



TEST REPORT

REPORT NUMBER: I23W00004-SAR-Rev2

ON

Type of Equipment:	Tracker
Type of Designation:	PT102A
Brand Name:	Prime
Manufacturer:	Micron Electronics LLC.
FCC ID:	ZKQ-PT102A

ACCORDING TO

IEEE C95.1-2019

IEC/IEEE 62209-1528-2020

Chongqing Academy of Information and Communication Technology

Month date, year

Mar. 22nd, 2023

Signature

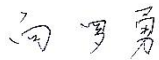

Xiang Luoyong

Director

Note:

The test results in this test report relate only to the devices specified in this report. This report shall not be reproduced except in full without the written approval of Chongqing Academy of Information and Communications Technology.

Chongqing Academy of Information and Communication Technology

Address: No. 8,Yuma Road, Chayuan New City, Nan'an District, Chongqing, P. R. China,401336
Tel: 0086-23-88069965

FAX:0086-23-88608777

Revision Version

Report Number	Revision	Date	Memo
I23W00004-SAR	00	2023-3-15	Initial creation of test report
I23W00004-SAR-Rev1	01	2023-3-21	First change of test report
I23W00004-SAR-Rev2	02	2023-3-22	Second change of test report

Note: This version has increased the tune up describe of all test frequency bands for 3M bandwidth full RB for QPSK and 16QAM, also increased the tune up describe of LTE B12 for 1.4M bandwidth 3RB.

TABLE OF CONTENT

1.TEST LABORATORY	5
1.1 TESTING LOCATION	5
1.2 TESTING ENVIRONMENT	5
1.3 PROJECT DATA	5
1.4 SIGNATURE	5
2. STATEMENT OF COMPLIANCE	6
3.CLIENT INFORMATION	7
3.1 APPLICANT INFORMATION	7
3.2 MANUFACTURER INFORMATION	7
4. EQUIPMENT UNDER TEST (EUT) AND ANCILLARY EQUIPMENT (AE)	8
4.1 ABOUT EUT	8
4.2 INTERNAL IDENTIFICATION OF EUT USED DURING THE TEST	9
4.3 INTERNAL IDENTIFICATION OF AE USED DURING THE TEST	9
5.REFERENCE DOCUMENTS	10
5.1 APPLICABLE LIMIT REGULATIONS	10
5.2 APPLICABLE MEASUREMENT STANDARDS	10
6.SPECIFIC ABSORPTION RATE (SAR)	11
6.1 INTRODUCTION	11
6.2 SAR DEFINITION	11
7.SAR MEASUREMENT SETUP	12
7.1 MEASUREMENT SET-UP	12
7.2 DASY5 E-FIELD PROBE SYSTEM	13
7.3 E-FIELD PROBE CALIBRATION	14
7.4 OTHER TEST EQUIPMENT	15
8.POSITION OF THE WIRELESS DEVICE IN RELATION TO THE PHANTOM	19
8.1 GENERAL CONSIDERATIONS	19
8.2 BODY-WORN DEVICE	20
8.3 DESKTOP DEVICE	21
8.4 DUT SETUP PHOTO	22
9.TISSUE SIMULATING LIQUIDS	23
9.1 EQUIVALENT TISSUES	23
9.2 DIELECTRIC PERFORMANCE	24
10.SYSTEM VALIDATION	25
10.1 SYSTEM VALIDATION	25
10.2 SYSTEM SETUP	25
11. MEASUREMENT PROCEDURES	27
11.1 TESTS TO BE PERFORMED	27
11.2 MEASUREMENT PROCEDURE	29
11.3 SAR MEASUREMENT FOR LTE	31
11.4 POWER DRIFT	32
12.AREA SCAN BASED 1-G SAR	33

12.1 REQUIREMENT OF KDB	33
12.2 FAST SAR ALGORITHMS	33
13.CONDUCTED OUTPUT POWER.....	34
13.1 LTE MEASUREMENT RESULT	34
14.SIMULTANEOUS TX SAR CONSIDERATIONS.....	44
15.SAR TEST RESULT	45
15.1 SAR RESULT	45
15.2. SAR MEASUREMENT VARIABILITY	47
16. MEASUREMENT UNCERTAINTY	48
17. MAIN TEST INSTRUMENTS	50
ANNEX A. GRAPH RESULTS	51
ANNEX B. SYSTEM VALIDATION RESULTS	54
ANNEX C. CALIBRATION REPORT	57
ANNEX D. EXTENDED CALIBRATION SAR DIPOLE	91
ANNEX E. ACCREDITATION CERTIFICATE	94

1. Test Laboratory

1.1 Testing Location

Company Name:	Chongqing Academy of Information and Communications Technology
Address:	No. 8, Yuma Road, Chayuan New City, Nan'an District, Chongqing, P. R. China
Postal Code:	401336
Telephone:	0086-23-88069965/021-68866880
Fax:	0086-23-88608777

1.2 Testing Environment

Normal Temperature:	18°C-25°C
Relative Humidity:	30%-70%
Ambient noise & Reflection:	< 0.012 W/kg

1.3 Project Data

Testing Start Date:	2023-3-3
Testing End Date:	2023-3-7

1.4 Signature

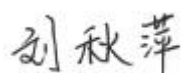

2023-3-22

Liu Qiuping
(Prepared this test report)

Date



2023-3-22

Yu Chun
(Reviewed this test report)

Date



2023-3-22

Xiang Luoyong
Director of the laboratory
(Approved this test report)

Date

Chongqing Academy of Information and Communication Technology

Address: No. 8, Yuma Road, Chayuan New City, Nan'an District, Chongqing, P. R. China, 401336
Tel: 0086-23-88069965 FAX: 0086-23-88608777

2. Statement of Compliance

The maximum results of Specific Absorption Rate (SAR) found during testing for **Micron Electronics LLC. Tracker** are as follow:

Table 2.1: Highest Reported SAR (1g, W/kg)

Technology Band	Head	Body (5mm)
LTE Band2	--	1.17
LTE Band4	--	1.16
LTE Band12	--	0.33

Remark: The SAR values found for the tracker are below the maximum recommended levels of 1.6 W/kg as averaged over any 1g tissue according to the IEEE C95.1-2019.

For body operation, this device has been tested and meets FCC RF exposure guidelines when used with any accessory that contains no metal and which provides a minimum separation distance of 5 mm between this device and the body of the user. Use of other accessories may not ensure compliance with FCC RF exposure guidelines.

The EUT battery must be fully charged and checked periodically during the test to ascertain uniform power output.

The measurement together with the test system set-up is described in Chapter 7 of this test report.

A detailed description of the equipment under test can be found in Chapter 4 of this test report.

The highest reported SAR value is obtained at the case of (Table 2.1), and the values are:

Body: 1.17 W/kg (1g)

3.Client Information

3.1 Applicant Information

Company Name:	Micron Electronics LLC.
Address /Post:	1001 Yamato Road, Suite 400, Boca Raton, FL 33431, USA
Telephone:	18885383489
Fax:	--
Email:	pcheng@micron-electronics.com
Contact Person:	Ping Cheng

3.2 Manufacturer Information

Company Name:	Micron Electronics LLC.
Address /Post:	1001 Yamato Road, Suite 400, Boca Raton, FL 33431, USA
Telephone:	18885383489
Fax:	--
Email:	pcheng@micron-electronics.com
Contact Person:	Ping Cheng

4. Equipment Under Test (EUT) and Ancillary Equipment (AE)

4.1 About EUT

Description:	Tracker
Model name:	PT102A
Operating mode(s):	LTE Band2/4/12
Tested Tx Frequency:	1850– 1910MHz (LTE Band 2)
	1710– 1755MHz (LTE Band 4)
	699– 716 MHz (LTE Band 12)
Test device Production information:	Production unit
Device type:	Portable device
Antenna type:	Metal(internal) antenna
Hotspot mode:	Not support

4.2 Internal Identification of EUT used during the test

EUT ID*	SN or IMEI	HW Version	SW Version	Date of receipt
EUT1	861475037109388	PT102_V2	PT102V03.01B07.I01	2023-2-17
EUT2	861475037112481	PT102_V2	PT102V03.01B07.I01	2023-2-17

*EUT ID: is used to identify the test sample in the lab internally.

4.3 Internal Identification of AE used during the test

AE ID*	Description	Model	SN	Manufacturer
NA	NA	NA	NA	NA

*AE ID: is used to identify the test sample in the lab internally.

5.Reference Documents

5.1 Applicable Limit Regulations

IEEE C95.1: 2019 IEEE Standard for Safety Levels with Respect to Human Exposure to Electric, Magnetic, and Electromagnetic Fields, 0 Hz to 300 GHz.

It specifies the maximum exposure limit of **1.6 W/kg** as averaged over any 1 gram of tissue for portable devices being used within 20 cm of the user in the uncontrolled environment.

5.2 Applicable Measurement Standards

IEC/IEEE 62209-1528-2020: Measurement procedure for the assessment of specific absorption rate of human exposure to radio frequency fields from hand-held and body-mounted wireless communication devices – Part 1528: Human models, instrumentation, and procedures (Frequency range of 4 MHz to 10 GHz)

KDB447498 D01: General RF Exposure Guidance v06: Mobile and Portable Devices RF Exposure Procedures and Equipment Authorization Policies.

KDB941225 D05 SAR for LTE Devices v02r05: SAR Evaluation Considerations for LTE Devices

KDB865664 D01SAR measurement 100 MHz to 6 GHz v01r04: SAR Measurement Requirements for 100 MHz to 6 GHz.

KDB865664 D02 RF Exposure Reporting v01r02: RF Exposure Compliance Reporting and Documentation Considerations.

6. Specific Absorption Rate (SAR)

6.1 Introduction

SAR is related to the rate at which energy is absorbed per unit mass in an object exposed to a radio field. The SAR distribution in a biological body is complicated and is usually carried out by experimental techniques or numerical modeling. The standard recommends limits for two tiers of groups, occupational/controlled and general population/uncontrolled, based on a person's awareness and ability to exercise control over his or her exposure. In general, occupational/controlled exposure limits are higher than the limits for general population/uncontrolled.

6.2 SAR Definition

The SAR definition is the time derivative (rate) of the incremental energy (dW) absorbed by (dissipated in) an incremental mass (dm) contained in a volume element (dv) of a given density (ρ). The equation description is as below:

$$SAR = \frac{d}{dt} \left(\frac{dW}{dm} \right) = \frac{d}{dt} \left(\frac{dW}{\rho dv} \right)$$

SAR is expressed in units of Watts per kilogram (W/kg)

SAR measurement can be either related to the temperature elevation in tissue by

$$SAR = c \left(\frac{\delta T}{\delta t} \right)$$

Where: C is the specific heat capacity, δT is the temperature rise and δt is the exposure duration, or related to the electrical field in the tissue by

$$SAR = \frac{\sigma |E|^2}{\rho}$$

Where: σ is the conductivity of the tissue, ρ is the mass density of tissue and E is the RMS electrical field strength.

However for evaluating SAR of low power transmitter, electrical field measurement is typically applied.

7.SAR MEASUREMENT SETUP

7.1 Measurement Set-up

The DASY5 system for performing compliance tests is illustrated above graphically. This system consists of the following items:

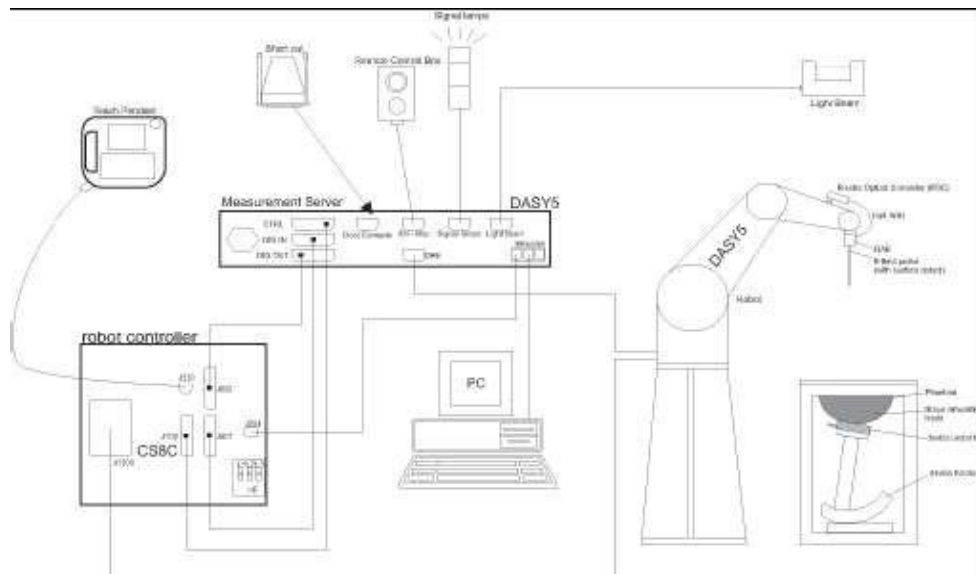

Picture 7.1-1 SAR Lab Test Measurement Set-up

- A standard high precision 6-axis robot (Stäubli TX=RX family) with controller, teach pendant and software. An arm extension for accommodating the data acquisition electronics (DAE).
- An isotropic field probe optimized and calibrated for the targeted measurement.
- A data acquisition electronics (DAE) which performs the signal amplification, signal multiplexing, AD-conversion, offset measurements, mechanical surface detection, collision detection, etc. The unit is battery powered with standard or rechargeable batteries. The signal is optically transmitted to the EOC.
- The Electro-optical converter (EOC) performs the conversion from optical to electrical signals for the digital communication to the DAE. To use optical surface detection, a special version of the EOC is required. The EOC signal is transmitted to the measurement server.
- The function of the measurement server is to perform the time critical tasks such as signal filtering, control of the robot operation and fast movement interrupts.
- The Light Beam used is for probe alignment. This improves the (absolute) accuracy of the probe positioning.
- A computer running WinXP and the DASY5 software.
- Remote control and teach pendant as well as additional circuitry for robot safety such as warning lamps, etc.
- The phantom, the device holder and other accessories according to the targeted measurement.

7.2 DASY5 E-field Probe System

The SAR measurements were conducted with the dosimetric probe designed in the classical triangular configuration and optimized for dosimetric evaluation. The probe is constructed using the thick film technique; with printed resistive lines on ceramic substrates. The probe is equipped with an optical multifiber line ending at the front of the probe tip. It is connected to the EOC box on the robot arm and provides an automatic detection of the phantom surface. Half of the fibers are connected to a pulsed infrared transmitter, the other half to a synchronized receiver. As the probe approaches the surface, the reflection from the surface produces a coupling from the transmitting to the receiving fibers. This reflection increases first during the approach, reaches maximum and then decreases. If the probe is flatly touching the surface, the coupling is zero. The distance of the coupling maximum to the surface is independent of the surface reflectivity and largely independent of the surface to probe angle. The DASY5 software reads the reflection during a software approach and looks for the maximum using 2nd order curve fitting. The approach is stopped at reaching the maximum.

Probe Specifications:

Model: EX3DV4
Frequency: 650MHz — 6GHz
Calibration: In head and body simulating tissue at
 Frequencies from 650 up to 4900MHz
Linearity: ± 0.2 dB

Dynamic Range: 10mW/kg-100W/kg

Probe Length: 330 mm

Probe Tip Length: 20mm

Body Diameter: 12 mm

Tip Diameter: 2.5mm

Tip-Center : 1 mm

Application: SAR Dosimetry Test Compliance tests of
 trackers Dosimetry in strong gradient
 fields



Picture 7-2 Near-field Probe



Picture 7-3 E-field Probe

7.3 E-field Probe Calibration

Each E-Probe/Probe Amplifier combination has unique calibration parameters. A TEM cell calibration procedure is conducted to determine the proper amplifier settings to enter in the probe parameters. The amplifier settings are determined for a given frequency by subjecting the probe to a known E-field density (1 mW/cm²) using an RF Signal generator, TEM cell, and RF Power Meter.

The free space E-field from amplified probe outputs is determined in a test chamber. This calibration can be performed in a TEM cell if the frequency is below 1 GHz and in a waveguide or other methodologies above 1 GHz for free space. For the free space calibration, the probe is placed in the volumetric center of the cavity and at the proper orientation with the field. The probe is then rotated 360 degrees until the three channels show the maximum reading. The power density readings equates to 1 mW/cm².

E-field temperature correlation calibration is performed in a flat phantom filled with the appropriate simulated brain tissue. The E-field in the medium correlates with the temperature rise in the dielectric medium. For temperature correlation calibration a RF transparent thermistor-based temperature probe is used in conjunction with the E-field probe.

$$SAR = C \frac{\Delta T}{\Delta t}$$

Where:

Δt = Exposure time (30 seconds),

C = Heat capacity of tissue (brain or muscle),

ΔT = Temperature increase due to RF exposure.

$$SAR = \frac{|E|^2 \cdot \sigma}{\rho}$$

Where:

σ = Simulated tissue conductivity,

ρ = Tissue density (kg/m³).

7.4 Other Test Equipment

7.4.1 Data Acquisition Electronics(DAE)

The data acquisition electronics consist of a highly sensitive electrometer-grade preamplifier with auto-zeroing, a channel and gain-switching multiplexer, a fast 16 bit AD-converter and a command decoder with a control logic unit. Transmission to the measurement server is accomplished through an optical downlink for data and status information, as well as an optical uplink for commands and the clock. The mechanical probe mounting device includes two different sensor systems for frontal and sideways probe contacts. They are used for mechanical surface detection and probe collision detection. The input impedance of the DAE is 200 MOhm; the inputs are symmetrical and floating. Common mode rejection is above 80 dB.



Picture7.4.1-1: DAE

7.4.2 Robot

The SPEAG DASY system uses the high precision robots (DASY5: TX90) type from Stäubli SA (France). For the 6-axis controller system, the robot controller version from Stäubli is used. The Stäubli robot series have many features that are important for our application:

- High precision (repeatability 0.02mm)
- High reliability (industrial design)
- Low maintenance costs (virtually maintenance free due to direct drive gears; no belt drives)
- Jerk-free straight movements (brushless synchron motors; no stepper motors)
- Low ELF interference (motor control fields shielded via the closed metallic construction shields)



Picture7.4.2-1: DASY 5

7.4.3 Measurement Server

The Measurement server is based on a PC/104 CPU board with CPU (DASY5: 400 MHz, Intel Celeron), chipdisk (DASY5: 128MB), RAM (DASY5: 128MB). The necessary circuits for communication with the DAE electronic box, as well as the 16 bit AD converter system for optical detection and digital I/O interface are contained on the DASY I/O board, which is directly connected to the PC/104 bus of the CPU board.

The measurement server performs all real-time data evaluation of field measurements and surface detection, controls robot movements and handles safety operation. The PC operating system cannot interfere with these time critical processes. All connections are supervised by a watchdog, and disconnection of any of the cables to the measurement server will automatically disarm the robot and disable all program-controlled robot movements. Furthermore, the measurement server is equipped with an expansion port which is reserved for future applications. Please note that this expansion port does not have a standardized pinout, and therefore only devices provided by SPEAG can be connected. Devices from any other supplier could seriously damage the measurement server.



Picture 7.4.3-1: Server for DASY 5

7.4.4 Device Holder for Phantom

The SAR in the phantom is approximately inversely proportional to the square of the distance between the source and the liquid surface. For a source at 5mm distance, a positioning uncertainty of ± 0.5 mm would produce a SAR uncertainty of $\pm 20\%$. Accurate device positioning is therefore crucial for accurate and repeatable measurements. The positions in which the devices must be measured are defined by the standards.

The DASY device holder is designed to cope with the different positions given in the standard. It has two scales for device rotation (with respect to the body axis) and device inclination (with respect to the line between the ear reference points). The rotation centers for both scales is the ear reference point (ERP).

Thus the device needs no repositioning when changing the angles. The DASY device holder is constructed of low-loss POM material having the following dielectric parameters:

relative permittivity=3 and loss tangent=0.02. The amount of dielectric material has been reduced in the closest vicinity of the device, since measurements have suggested that the influence of the clamp on the test results could thus be lowered.

<Laptop Extension Kit>

The extension is lightweight and made of POM, acrylic glass and foam. It fits easily on the upper part of the Mounting Device in place of the phone positioner. The extension is fully compatible with the Twin-SAM and ELI phantoms.



Picture7.4.4-1: Device Holder



Picture 7.4.4-2: Laptop Extension Kit

7.4.5 Phantom

The SAM Twin Phantom V4.0 is constructed of a fiberglass shell integrated in a table. The shape of the shell is based on data from an anatomical study designed to represent the 90th percentile of the population. The phantom enables the dissymmetric evaluation of SAR for both left and right handed handset usage, as well as body-worn usage using the flat phantom region. Reference markings on the Phantom allow the complete setup of all predefined phantom positions and measurement grids by manually teaching three points in the robot. The shell phantom has a 2mm shell thickness (except the ear region where shell thickness increases to 6 mm).

Shell Thickness: 2 ± 0.2 mm

Filling Volume: Approx. 25 liters

Dimensions: 810 x 1000 x 500 mm (H x L x W)

Available: Special



Picture 7.4.5-1: SAM Twin Phantom

8. Position of the wireless device in relation to the phantom

8.1 General considerations

This standard specifies two handset test positions against the head phantom – the “cheek” position and the “tilt” position.

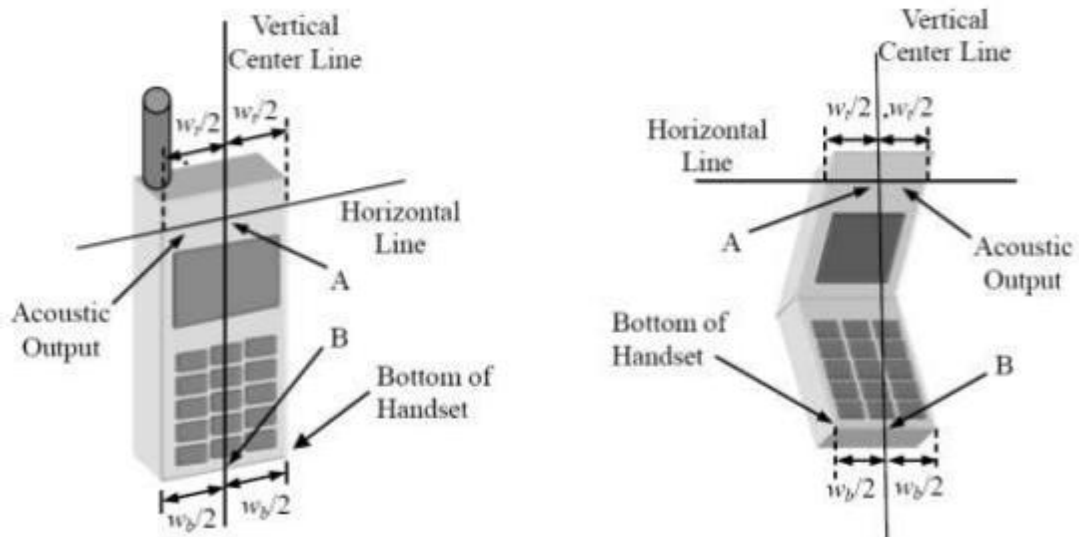

- w_t Width of the handset at the level of the acoustic
- w_b Width of the bottom of the handset
- A Midpoint of the width w_t of the handset at the level of the acoustic output
- B Midpoint of the width w_b of the bottom of the handset

Picture 12-a Typical “fixed” case handset Picture 12-b Typical “clam-shell” case handset

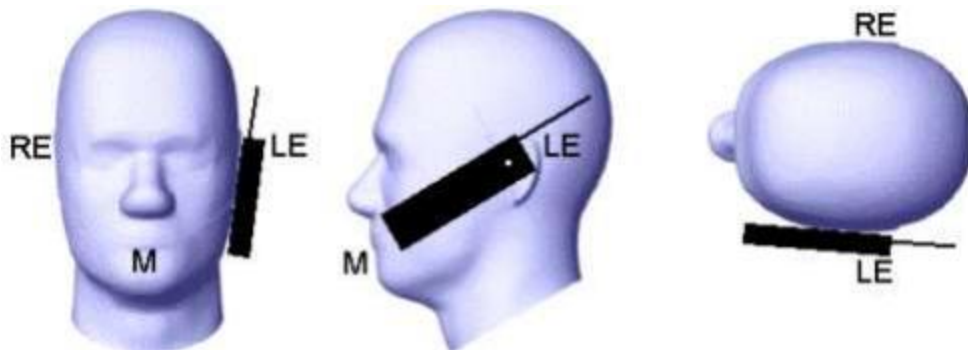

Picture 8.1-1 Cheek position of the wireless device on the left side of SAM

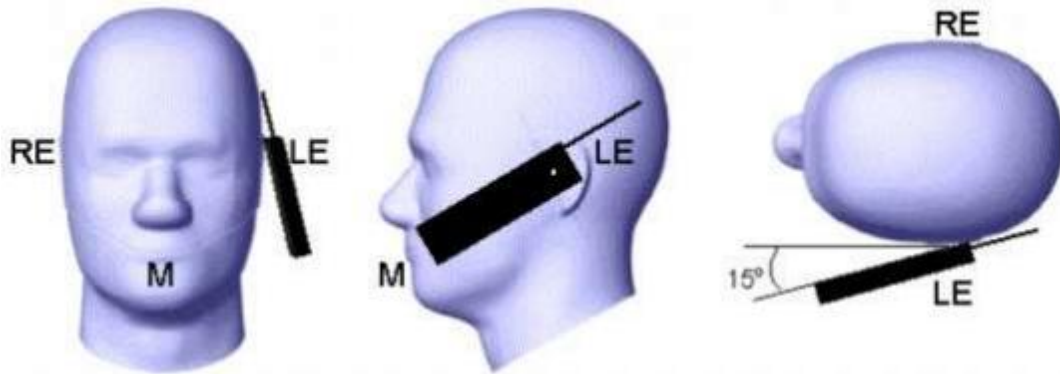

Picture 8.1-2 Tilt position of the wireless device on the left side of SAM

8.2 Body-worn device

A typical example of a body-worn device is a tracker, wireless enabled PDA or other battery operated wireless device with the ability to transmit while mounted on a person's body using a carry accessory approved by the wireless device manufacturer.

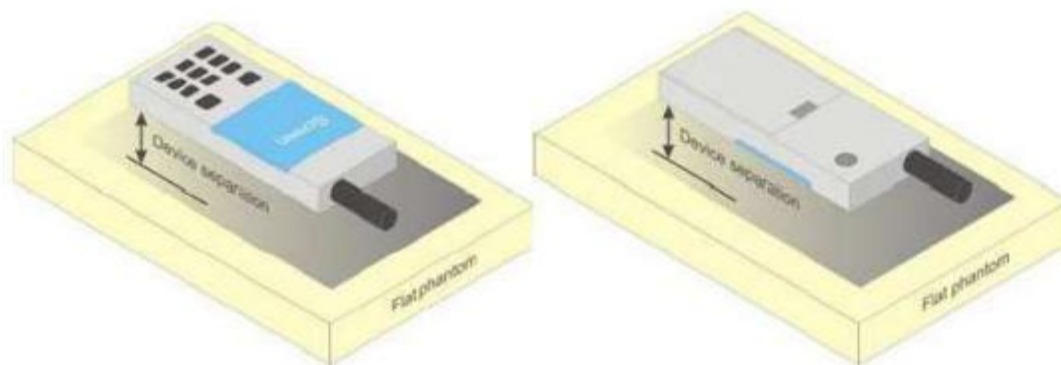

Picture 8.2-1 Test positions for body-worn devices

8.3 Desktop device

A typical example of a desktop device is a wireless enabled desktop computer placed on a table or desk when used. The DUT shall be positioned at the distance and in the orientation to the phantom that corresponds to the intended use as specified by the manufacturer in the user instructions. For devices that employ an external antenna with variable positions, tests shall be performed for all antenna positions specified. Picture 16 show positions for desktop device SAR tests. If the intended use is not specified, the device shall be tested directly against the flat phantom.

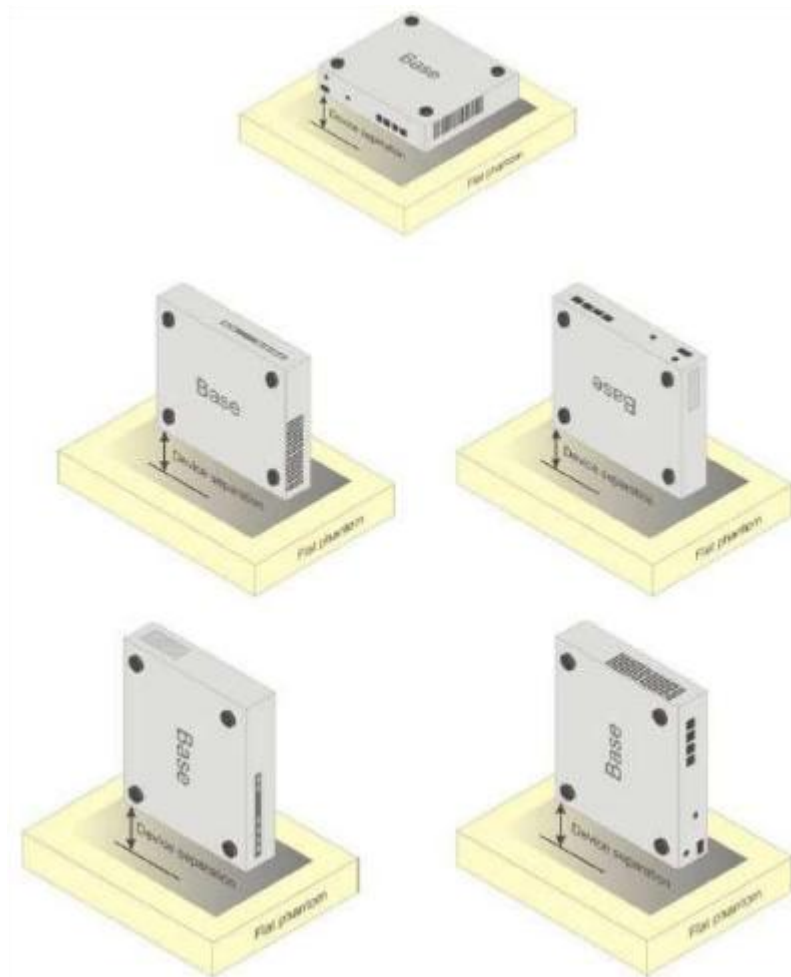

Picture8.3-1 Test positions for desktop devices

8.4 DUT Setup Photo

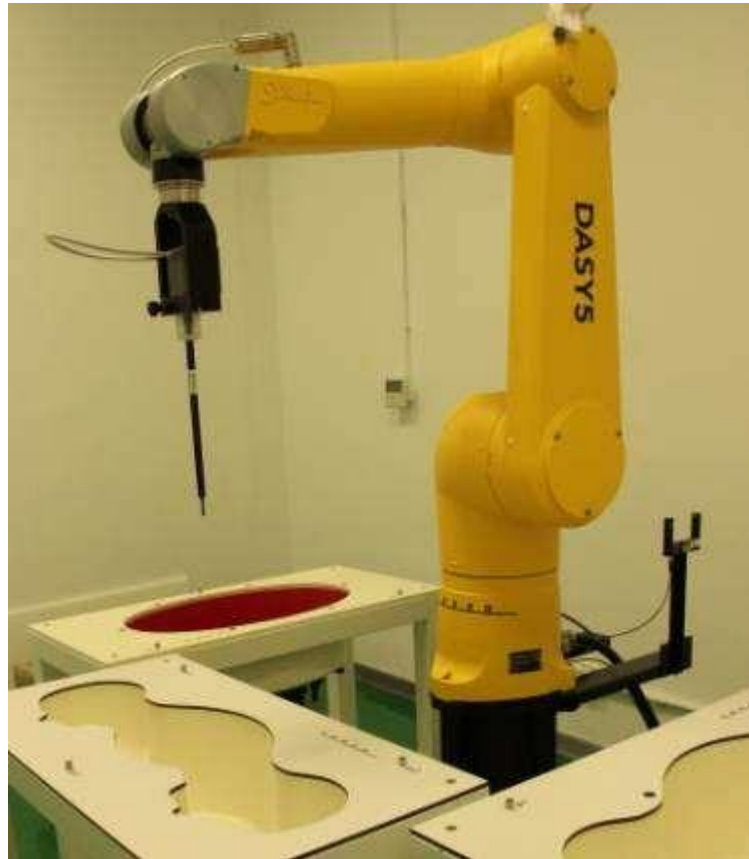

Picture 8.4-1: Specific Absorption Rate Test Layout

9. Tissue Simulating Liquids

9.1 Equivalent Tissues

The liquid used for the frequency range of 750-3000 MHz consisted of water, sugar, salt and Cellulose. The liquid has been previously proven to be suited for worst-case. The Table 9.1-1 and 9.1-2 shows the detail solution. The following tissue formulations are provided for reference only as some of the parameters have not been thoroughly verified. The composition of ingredients may be modified accordingly to achieve the desired target tissue parameters required for routine SAR evaluation.

Table 9.1-1 Composition of the Head Tissue Equivalent Matter

Ingredients (% by weight)		
Frequency (MHz)	750MHz	1750MHz&1900MHz
water	41.45	55.24
sugar	56.00	/
salt	1.45	0.306
preventol	0.1	/
cellulose	1.0	/
ClycolMonobutyl	/	44.45
Dielectric Parameters Target Value	f=750MHz $\epsilon=41.942$ $\sigma=0.893$	f=1750MHz $\epsilon=40.079$ $\sigma=1.371$ f=1900MHz $\epsilon=40.000$ $\sigma=1.400$

Table 9.1-2 Targets for tissue simulating liquid

Frequency (MHz)	Liquid Type	Conductivity (σ)	$\pm 5\%$ Range	Permittivity (ϵ)	$\pm 5\%$ Range
750	Head	0.893	0.849~0.938	41.942	39.845~44.039
1750	Head	1.371	1.302~1.440	40.079	38.075~42.083
1900	Head	1.400	1.330~1.470	40.000	38.000~42.000

9.2 Dielectric Performance

Table 9.2-1: Dielectric Performance of Head Tissue Simulating Liquid

Measurement Value						
Liquid Temperature: 22.1°C						
Type	Frequency (MHz)	Permittivity ϵ	Drift (%)	Conductivity σ	Drift (%)	Test Date
Head	750	40.717	-2.92	0.902	1.00	2023-3-7
Head	1750	41.103	2.55	1.361	-0.73	2023-3-6
Head	1900	40.335	0.84	1.433	2.36	2023-3-6

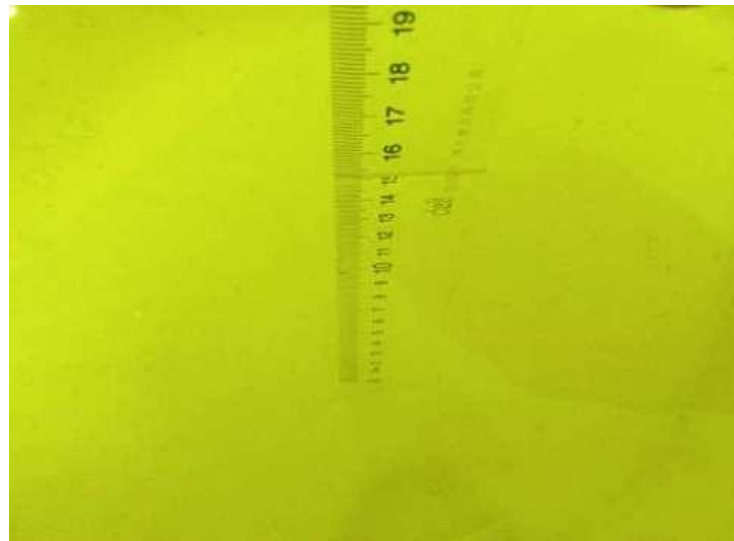

Picture 9.2-1: Liquid depth in the Flat Phantom (Head 750 MHz)



Picture 9.2-2: Liquid depth in the Flat Phantom (Head 1750&1900 MHz)

10. System Validation

10.1 System Validation

Each DASY system is equipped with one or more system validation kits. These units, together with the predefined measurement procedures within the DASY software, enable the user to conduct the system performance check and system validation. System validation kit includes a dipole, tripod holder to fix it underneath the flat phantom and a corresponding distance holder.

10.2 System Setup

In the simplified setup for system evaluation, the DUT is replaced by a calibrated dipole and the power source is replaced by a continuous wave that comes from a signal generator. The calibrated dipole must be placed beneath the flat phantom section of the SAM twin phantom with the correct distance holder. The distance holder should touch the phantom surface with a light pressure at the reference marking and be oriented parallel to the long side of the phantom. The equipment setup is shown below:

Picture 10.2-1 System Setup for System Evaluation

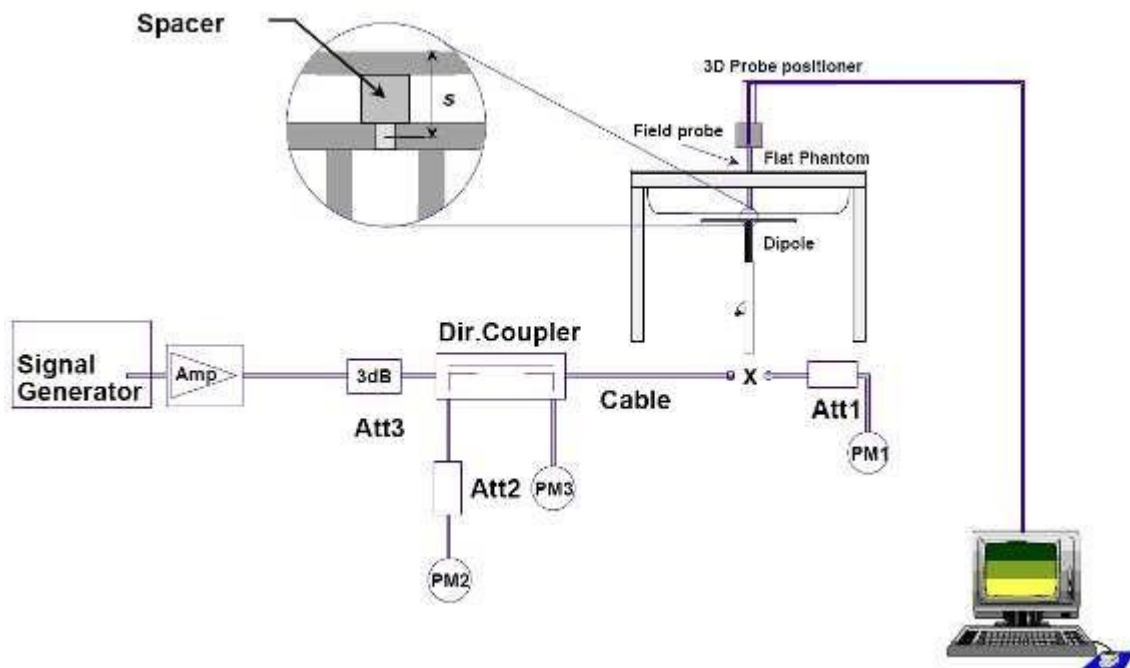

The output power on dipole port must be calibrated to 24 dBm (250mW) before dipole is connected. The results are normalized to 1 W input power.

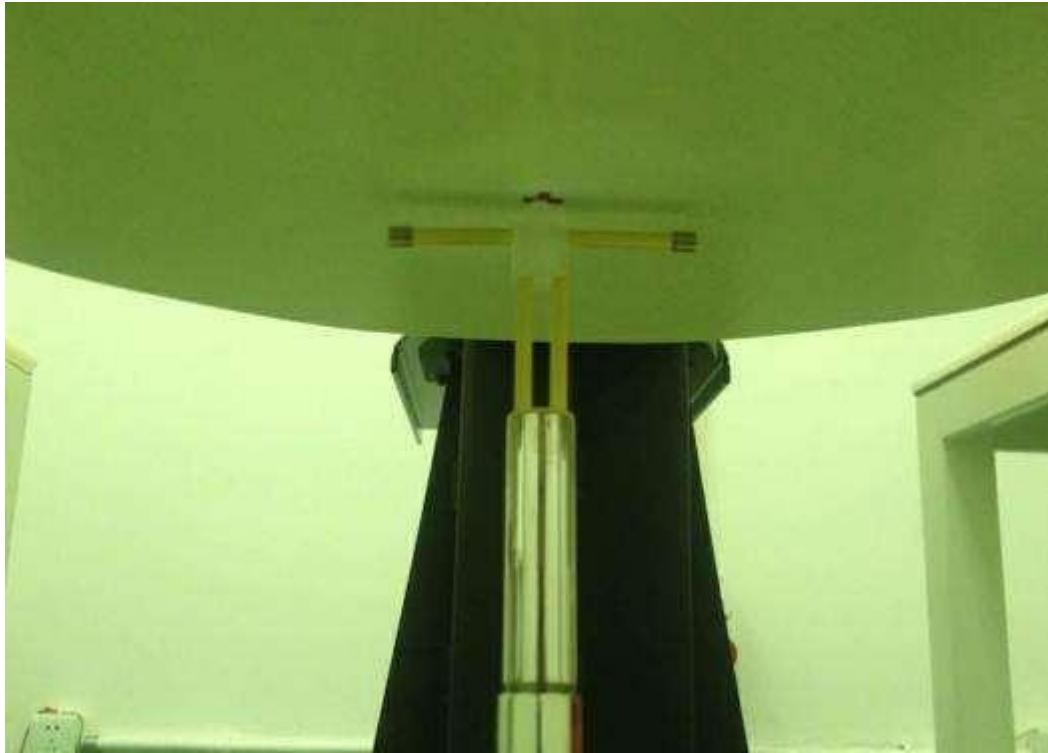

Picture 10.2-1: Photo of Dipole Setup

Table 10.2-1: System Validation of Head

Verification Results							
Input power level: 1W							
Frequency	Target value (W/kg)		Measured value (W/kg)		Deviation		Test date
	1 g Average	10 g Average	1 g Average	10 g Average	1 g Average(%)	10 g Average(%)	
750MHz	2.07	1.37	2.23	1.36	7.73	-0.73	2023-3-7
1750MHz	8.96	4.73	8.28	4.30	-7.59	-9.09	2023-3-6
1900MHz	9.78	5.04	9.61	4.84	-1.74	-3.97	2023-3-6

11. Measurement Procedures

11.1 Tests to be performed

In order to determine the highest value of the peak spatial-average SAR of a handset, all device positions, configurations and operational modes shall be tested for each frequency band according to steps 1 to 3 below. A flowchart of the test process is shown in Picture 19

Step 1: The tests described in 11.2 shall be performed at the channel that is closest to the centre of the transmit frequency band (f_c) for:

- a) all device positions (cheek and tilt, for both left and right sides of the SAM phantom, as described in Chapter 8),
- b) all configurations for each device position in a), e.g., antenna extended and retracted, and
- c) all operational modes, e.g., analogue and digital, for each device position in a) and configuration in b) in each frequency band.

If more than three frequencies need to be tested according to 11.1 (i.e., $N_c > 3$), then all frequencies, configurations and modes shall be tested for all of the above test conditions.

Step 2: For the condition providing highest peak spatial-average SAR determined in Step 1, perform all tests described in 11.2 at all other test frequencies, i.e., lowest and highest frequencies. In addition, for all other conditions (device position, configuration and operational mode) where the peak spatial-average SAR value determined in Step 1 is within 3 dB of the applicable SAR limit, it is recommended that all other test frequencies shall be tested as well.

Step 3: Examine all data to determine the highest value of the peak spatial-average SAR found in Steps 1 to 2.

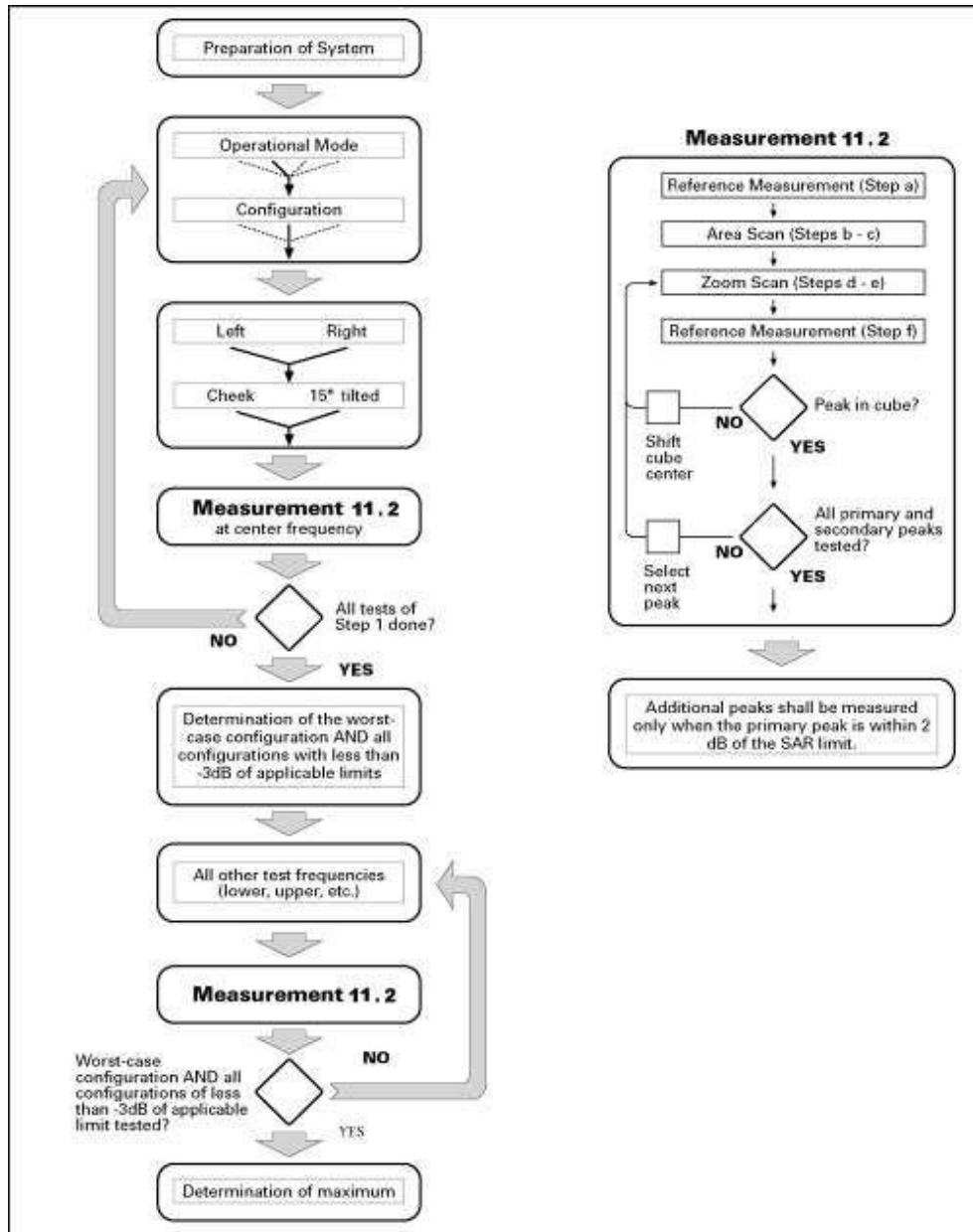

Picture 11.1-1: Block diagram of the tests to be performed

11.2 Measurement procedure

The following procedure shall be performed for each of the test conditions (see Picture 19) described in 11.1:

a) Measure the local SAR at a test point within 8 mm or less in the normal direction from the inner surface of the phantom.

b) Measure the two-dimensional SAR distribution within the phantom (area scan procedure). The boundary of the measurement area shall not be closer than 20 mm from the phantom side walls. The distance between the measurement points should enable the detection of the location of local maximum with an accuracy of better than half the linear dimension of the tissue cube after interpolation. A maximum grid spacing of 20 mm for frequencies below 3 GHz and $(60/f \text{ [GHz]})$ mm for frequencies of 3GHz and greater is recommended. The maximum distance between the geometrical centre of the probe detectors and the inner surface of the phantom shall be 5 mm for frequencies below 3 GHz and $\delta \ln(2)/2$ mm for frequencies of 3 GHz and greater, where δ is the plane wave skin depth and $\ln(x)$ is the natural logarithm. The maximum variation of the sensor-phantom surface shall be ± 1 mm for frequencies below 3 GHz and ± 0.5 mm for frequencies of 3 GHz and greater. At all measurement points the angle of the probe with respect to the line normal to the surface should be less than 5° . If this cannot be achieved for a measurement distance to the phantom inner surface shorter than the probe diameter, additional uncertainty evaluation is needed.

c) From the scanned SAR distribution, identify the position of the maximum SAR value, in addition identify the positions of any local maxima with SAR values within 2 dB of the maximum value that are not within the zoom-scan volume; additional peaks shall be measured only when the primary peak is within 2 dB of the SAR limit. This is consistent with the 2 dB threshold already stated;

d) Measure the three-dimensional SAR distribution at the local maxima locations identified in step

- e) The horizontal grid step shall be $(24 / f[\text{GHz}])$ mm or less but not more than 8 mm. The minimum zoom size of 30 mm by 30 mm and 30 mm for frequencies below 3 GHz. For higher frequencies, the minimum zoom size of 22 mm by 22 mm and 22 mm. The grid step in the vertical direction shall be $(8-f[\text{GHz}])$ mm or less but not more than 5 mm, if uniform spacing is used. If variable spacing is used in the vertical direction, the maximum spacing between the two closest measured points to the phantom shell shall be $(12 / f[\text{GHz}])$ mm or less but not more than 4 mm, and the spacing between further points shall increase by an incremental factor not exceeding 1.5. When variable spacing is used, extrapolation routines shall be tested with the same spacing as used in measurements. The maximum distance between the geometrical centre of the probe detectors and the inner surface of the phantom shall be 5 mm for frequencies below 3 GHz and $\delta \ln(2)/2$ mm for frequencies of 3 GHz and greater, where δ is the plane wave skin depth and $\ln(x)$ is the natural logarithm. Separate grids shall be centered on each of the local SAR maxima found in step c). Uncertainties due to field distortion between the media boundary and the dielectric enclosure of the probe should also be minimized, which is achieved if the distance between the phantom surface and physical tip of the probe is larger than probe tip diameter. Other methods may utilize correction procedures for these boundary effects that enable high precision measurements closer than half the probe diameter. For all measurement points, the angle of the probe with respect to the flat phantom surface shall be less than 5° . If this cannot be achieved an additional uncertainty evaluation is needed.
- f) Use post processing(e.g. interpolation and extrapolation) procedures to determine the local SAR values at the spatial resolution needed for mass averaging.

11.3 SAR Measurement for LTE

SAR tests for LTE are performed with a base station simulator, Rohde & Schwarz CMW500. Closed loop power control was used so the UE transmits with maximum output power during SAR testing.

All powers were measured with the CMW 500.

It is performed for conducted power and SAR based on the KDB941225 D05.

SAR is evaluated separately according to the following procedures for the different test positions in each exposure condition – head, body, body-worn accessories and other use conditions. The procedures in the following subsections are applied separately to test each LTE frequency band.

1) QPSK with 1 RB allocation

Start with the largest channel bandwidth and measure SAR for QPSK with 1 RB allocation, using the RB offset and required test channel combination with the highest maximum output power among RB offsets at the upper edge, middle and lower edge of each required test channel. When the reported SAR is ≤ 0.8 W/kg, testing of the remaining RB offset configurations and required test channels is not required for 1 RB allocation; otherwise, SAR is required for the remaining required test channels and only for the RB offset configuration with the highest output power for that channel. When the reported SAR of a required test channel is > 1.45 W/kg, SAR is required for all three RB offset configurations for that required test channel.

2) QPSK with 50% RB allocation

The procedures required for 1 RB allocation in 1) are applied to measure the SAR for QPSK with 50% RB allocation.

3) QPSK with 100% RB allocation

For QPSK with 100% RB allocation, SAR is not required when the highest maximum output power for 100% RB allocation is less than the highest maximum output power in 50% and 1 RB allocations and the highest reported SAR for 1 RB and 50% RB allocation in 1) and 2) are ≤ 0.8 W/kg. Otherwise, SAR is measured for the highest output power channel; and if the reported SAR is > 1.45 W/kg, the remaining required test channels must also be tested.

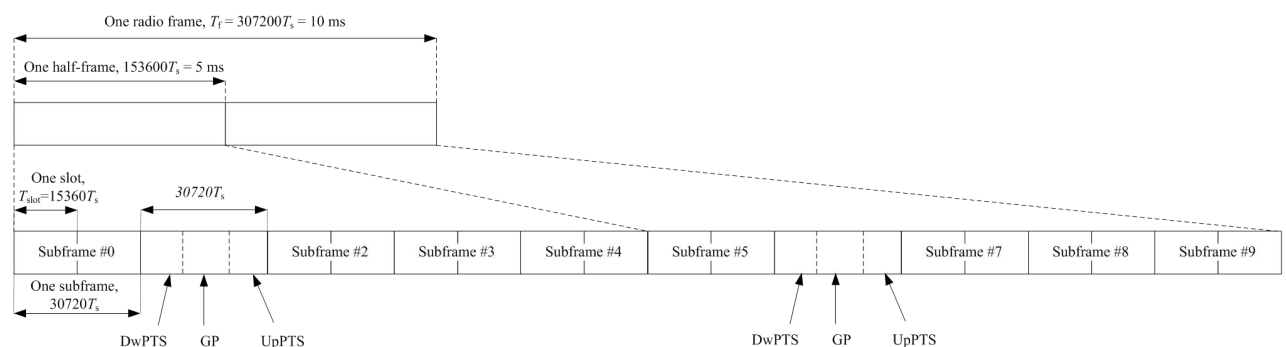

Figure 11.3-1: Frame structure type 2 (for 5 ms switch-point periodicity)

Table 11.3-1: Configuration of special subframe (lengths of DwPTS/GP/UpPTS)

Special subframe configuration	Normal cyclic prefix in downlink			Extended cyclic prefix in downlink		
	DwPTS	UpPTS		DwPTS	UpPTS	
		Normal cyclic prefix in uplink	Extended cyclic prefix in uplink		Normal cyclic prefix in uplink	Extended cyclic prefix in uplink
0	$6592 \cdot T_s$	$2192 \cdot T_s$	$2560 \cdot T_s$	$7680 \cdot T_s$	$2192 \cdot T_s$	$2560 \cdot T_s$
1	$19760 \cdot T_s$			$20480 \cdot T_s$		
2	$21952 \cdot T_s$			$23040 \cdot T_s$		
3	$24144 \cdot T_s$			$25600 \cdot T_s$		
4	$26336 \cdot T_s$	$4384 \cdot T_s$	$5120 \cdot T_s$	$7680 \cdot T_s$	$4384 \cdot T_s$	$5120 \cdot T_s$
5	$6592 \cdot T_s$			$20480 \cdot T_s$		
6	$19760 \cdot T_s$			$23040 \cdot T_s$		
7	$21952 \cdot T_s$			$12800 \cdot T_s$		
8	$24144 \cdot T_s$			-		
9	$13168 \cdot T_s$			-		

Table 11.3-2: Uplink-downlink configurations

Uplink-downlink configuration	Downlink-to-Uplink Switch-point periodicity	Subframe number									
		0	1	2	3	4	5	6	7	8	9
0	5 ms	D	S	U	U	U	D	S	U	U	U
1	5 ms	D	S	U	U	D	D	S	U	U	D
2	5 ms	D	S	U	D	D	D	S	U	D	D
3	10 ms	D	S	U	U	U	D	D	D	D	D
4	10 ms	D	S	U	U	D	D	D	D	D	D
5	10 ms	D	S	U	D	D	D	D	D	D	D
6	5 ms	D	S	U	U	U	D	S	U	U	D

Duty factor is calculated by:

$$\begin{aligned}
 \text{Duty factor} &= \text{uplink frame} \cdot 6 + \text{UpPTS} \cdot 2 / \text{one frame length} \\
 &= (30720 \cdot T_s \cdot 6 + 5120 \cdot T_s \cdot 2) / 307200 \cdot T_s \\
 &= 0.633
 \end{aligned}$$

11.4 Power Drift

To control the output power stability during the SAR test, DASY5 system calculates the power drift by measuring the E-field at the same location at the beginning and at the end of the measurement for each test position. These drift values can be found in Section 15 labeled as: (Power Drift [dB]). This ensures that the power drift during one measurement is within 5%.

12. Area Scan Based 1-g SAR

12.1 Requirement of KDB

According to the KDB447498D01v05, when the implementation is based the specific polynomial fit algorithm as presented at the 29th Bioelectromagnetics Society meeting (2007) and the estimated 1-g SAR is ≤ 1.2 W/kg, a zoom scan measurement is not required provided it is also not needed for any other purpose; for example, if the peak SAR location required for simultaneous transmission SAR test exclusion can be determined accurately by the SAR system or manually to discriminate between isotropic peak and scattered noisy SAR distributions from area scans.

There must not be any warning or alert messages due to various measurement concerns identified by the SAR system; for example, noise in measurements, peaks too close to scan boundary, peaks are too sharp, spatial resolution and uncertainty issues etc. The SAR system verification must also demonstrate that the area scan estimated 1-g SAR is within 3% of the zoom scan 1-g SAR (See Annex A). When all the SAR results for each exposure condition in a frequency band and wireless mode are based on estimated 1-g SAR, the 1-g SAR for the highest SAR configuration must be determined by a zoom scan.

12.2 Fast SAR Algorithms

The approach is based on the area scan measurement applying a frequency dependent attenuation parameter. This attenuation parameter was empirically determined by analyzing a large number of phones. The MOTOROLA FAST SAR was developed and validated by the MOTOROLA Research Group in Ft. Lauderdale.

In the initial study, an approximation algorithm based on Linear fit was developed. The accuracy of the algorithm has been demonstrated across a broad frequency range (136-2450 MHz) and for both 1-g and 10-g averaged SAR using a sample of 264 SAR measurements from 55 wireless handsets. For the sample size studied, the root-mean-squared errors of the algorithm are 1.2% and 5.8% for 1-g and 10-g averaged SAR, respectively. The paper describing the algorithm in detail is expected to be published in August 2004 within the Special Issue of Transactions on MTT.

In the second step, the same research group optimized the fitting algorithm to an Polynomial fit where the frequency validity was extended to cover the range 30-6000 MHz. Details of this study can be found in the BEMS 2007 Proceedings. Both algorithms are implemented in DASY software.

13. Conducted Output Power

13.1 LTE Measurement Result

Maximum Target Power for Production Unit

Frequency Band		Tune up (dBm)
Band 2	16QAM (1.4M/3M/5M, 1RB)	18.65±2
	16QAM (1.4M, 3RB)	18.65±2
	16QAM(3M, 50%RB and full RB)	18.65±2
	16QAM(5M/10M/15M/20M, 50%RB and full RB)	17.65±2
	16QAM(1.4M, full RB)	17.65±2
	QPSK (1.4M/3M/5M/10M/15M/20M) 1RB	19.15±2
	QPSK (1.4M,3RB)	19.15±2
	QPSK (3M, 50%RB and full RB)	19.15±2
	QPSK (5M/10M/15M/20M, 50%RB and full RB)	18.15±2
	QPSK (1.4M, full RB)	18.15±2
Band 4	16QAM (1.4M/3M/5M, 1RB)	18.86±2
	16QAM (1.4M, 3RB)	18.86±2
	16QAM(3M, 50%RB and full RB)	18.86±2
	16QAM(5M/10M/15M/20M, 50%RB and full RB)	17.86±2
	16QAM(1.4M, full RB)	17.86±2
	QPSK (1.4M/3M/5M/10M/15M/20M) 1RB	19.3±2
	QPSK (1.4M,3RB)	19.3±2
	QPSK (3M, 50%RB and full RB)	19.3±2
	QPSK (5M/10M/15M/20M, 50%RB and full RB)	18.3±2
	QPSK (1.4M, full RB)	18.3±2
Band 12	16QAM (1.4M/3M/5M, 1RB)	19.77±2
	16QAM (1.4M, 3RB)	19.77±2
	16QAM(3M, 50%RB and full RB)	19.77±2

	16QAM(5M/10M, 50%RB and full RB)	18.77 ± 2
	16QAM(1.4M, full RB)	18.77 ± 2
	QPSK (1.4M/3M/5M/10M, 1RB)	19.72 ± 2
	QPSK (1.4M, 3RB)	19.72 ± 2
	QPSK (3M, 50%RB and full RB)	19.72 ± 2
	QPSK (5M/10M, 50%RB and full RB)	18.72 ± 2
	QPSK (1.4M, full RB)	18.72 ± 2

LTE band2					
BANDWIDTH	Number of RBs	Channel	Frequency	QPSK(dBm)	16QAM(dBm)
1.4MHz	1RB-High (5)	18607	1850.7	21.00	19.84
		18900	1880	20.42	19.65
		19193	1909.3	20.62	19.46
	1RB-Middle (3)	18607	1850.7	20.98	20.24
		18900	1880	20.34	19.77
		19193	1909.3	20.66	19.67
	1RB-Low (0)	18607	1850.7	20.81	20.00
		18900	1880	20.27	19.55
		19193	1909.3	20.68	19.77
	3RB-High (3)	18607	1850.7	20.80	20.63
		18900	1880	20.17	20.18
		19193	1909.3	20.68	20.64
	3RB-Middle (1)	18607	1850.7	20.71	19.75
		18900	1880	20.40	19.35
		19193	1909.3	20.58	19.53
	3RB-Low (0)	18607	1850.7	20.86	20.49
		18900	1880	20.02	20.33
		19193	1909.3	20.66	20.60
	6RB (0)	18607	1850.7	19.78	18.76
		18900	1880	19.25	18.13
		19193	1909.3	19.58	18.53
3MHz	1RB-High (14)	18615	1851.5	20.35	19.05
		18900	1880	19.96	19.45
		19185	1908.5	20.46	19.51
	1RB-Middle (7)	18615	1851.5	20.36	19.23
		18900	1880	19.95	19.35
		19185	1908.5	20.34	19.48
	1RB-Low (0)	18615	1851.5	20.48	19.22
		18900	1880	20.25	19.35
		19185	1908.5	20.44	19.31
	8RB-High (7)	18615	1851.5	20.52	20.08
		18900	1880	19.91	19.88
		19185	1908.5	20.54	20.56
	8RB-Middle (4)	18615	1851.5	19.47	18.42
		18900	1880	18.99	18.06
		19185	1908.5	19.45	18.49
	8RB-Low (0)	18615	1851.5	20.50	20.16
		18900	1880	19.79	19.77
		19185	1908.5	20.55	20.57
	15RB (0)	18615	1851.5	19.31	18.32
		18900	1880	19.05	18.01
		19185	1908.5	19.49	18.66
5MHz	1RB-High (24)	18625	1852.5	20.21	19.03
		18900	1880	19.97	18.67
		19175	1907.5	20.24	19.37
	1RB-Middle (12)	18625	1852.5	20.44	19.57
		18900	1880	20.08	18.71
		19175	1907.5	20.62	19.61

	1RB-Low (0)	18625	1852.5	20.32	19.33	
		18900	1880	20.06	18.65	
		19175	1907.5	20.48	19.38	
	12RB-High (13)	18625	1852.5	19.44	18.44	
		18900	1880	19.02	18.16	
		19175	1907.5	19.51	18.27	
	12RB-Middle (6)	18625	1852.5	19.27	18.28	
		18900	1880	19.09	18.08	
		19175	1907.5	19.49	18.31	
	12RB-Low (0)	18625	1852.5	19.27	18.35	
		18900	1880	19.02	18.15	
		19175	1907.5	19.55	18.30	
25RB (0)	18625	1852.5	19.32	18.48		
	18900	1880	19.04	18.06		
	19175	1907.5	19.45	18.49		
10MHz	1RB-High (49)	18650	1855	20.39	--	
		18900	1880	20.00	--	
		19150	1905	20.47	--	
	1RB-Middle (24)	18650	1855	20.61	--	
		18900	1880	20.37	--	
		19150	1905	20.64	--	
	1RB-Low (0)	18650	1855	20.45	--	
		18900	1880	20.04	--	
		19150	1905	20.62	--	
	25RB-High (25)	18650	1855	19.44	--	
		18900	1880	19.10	--	
		19150	1905	19.47	--	
	25RB-Middle (12)	18650	1855	19.51	--	
		18900	1880	19.06	--	
		19150	1905	19.56	--	
	25RB-Low (0)	18650	1855	19.47	--	
		18900	1880	19.05	--	
		19150	1905	19.56	--	
	50RB (0)	18650	1855	19.42	--	
		18900	1880	19.05	--	
		19150	1905	19.62	--	
	15MHz	1RB-High (74)	18675	1857.5	20.37	--
			18900	1880	20.27	--
			19125	1902.5	20.59	--
1RB-Middle (37)		18675	1857.5	20.41	--	
		18900	1880	20.17	--	
		19125	1902.5	20.60	--	
1RB-Low (0)		18675	1857.5	20.30	--	
		18900	1880	20.30	--	
		19125	1902.5	20.70	--	
36RB-High (39)		18675	1857.5	19.32	--	
		18900	1880	19.21	--	
		19125	1902.5	19.61	--	
36RB-Middle (19)		18675	1857.5	19.32	--	
		18900	1880	19.24	--	
		19125	1902.5	19.66	--	
36RB-Low (0)		18675	1857.5	19.35	--	

20MHz	75RB (0)	18900	1880	19.27	--
		19125	1902.5	19.78	--
		18675	1857.5	19.18	--
		18900	1880	19.19	--
		19125	1902.5	19.48	--
	1RB-High (99)	18700	1860	20.28	--
		18900	1880	20.28	--
		19100	1900	20.43	--
	1RB-Middle (49)	18700	1860	20.73	--
		18900	1880	20.26	--
		19100	1900	21.14	--
	1RB-Low (0)	18700	1860	20.48	--
		18900	1880	20.21	--
		19100	1900	20.21	--
	50RB-High (50)	18700	1860	19.46	--
18900		1880	19.28	--	
19100		1900	19.66	--	
50RB-Middle (25)	18700	1860	19.59	--	
	18900	1880	19.25	--	
	19100	1900	19.83	--	
50RB-Low (0)	18700	1860	19.53	--	
	18900	1880	19.30	--	
	19100	1900	19.77	--	
100RB (0)	18700	1860	19.42	--	
	18900	1880	19.29	--	
	19100	1900	19.67	--	

LTE band4					
BANDWIDTH	Number of RBs	Channel	Frequency	QPSK(dBm)	16QAM(dBm)
1.4MHz	1RB-High (5)	19957	1710.7	21.09	19.72
		20175	1732.5	20.67	19.61
		20393	1754.3	20.85	19.87
	1RB-Middle (3)	19957	1710.7	21.22	20.19
		20175	1732.5	20.96	19.52
		20393	1754.3	20.88	20.01
	1RB-Low (0)	19957	1710.7	21.10	20.42
		20175	1732.5	20.68	19.77
		20393	1754.3	20.89	20.01
	3RB-High (3)	19957	1710.7	20.91	20.82
		20175	1732.5	20.87	20.82
		20393	1754.3	20.36	20.79
	3RB-Middle (1)	19957	1710.7	20.94	19.52
		20175	1732.5	20.73	19.94
		20393	1754.3	20.61	19.96
	3RB-Low (0)	19957	1710.7	21.00	20.77
		20175	1732.5	20.89	20.85
		20393	1754.3	20.40	20.82
	6RB (0)	19957	1710.7	19.89	18.70
		20175	1732.5	19.78	18.79
		20393	1754.3	19.68	18.86
3MHz	1RB-High (14)	19965	1711.5	20.95	19.80
		20175	1732.5	20.79	19.91
		20385	1753.5	20.58	19.74
	1RB-Middle (7)	19965	1711.5	20.90	19.68
		20175	1732.5	20.92	20.04
		20385	1753.5	20.76	19.46
	1RB-Low (0)	19965	1711.5	20.82	19.66
		20175	1732.5	20.81	19.92
		20385	1753.5	20.41	19.51
	8RB-High (7)	19965	1711.5	20.77	20.75
		20175	1732.5	20.66	20.51
		20385	1753.5	20.88	20.83
	8RB-Middle (4)	19965	1711.5	19.90	18.99
		20175	1732.5	19.66	18.69
		20385	1753.5	19.73	18.81
	8RB-Low (0)	19965	1711.5	20.90	20.79
		20175	1732.5	20.68	20.70
		20385	1753.5	20.90	20.84
	15RB (0)	19965	1711.5	19.80	18.85
		20175	1732.5	19.70	18.74
		20385	1753.5	19.69	18.67
5MHz	1RB-High (24)	19975	1712.5	21.03	19.91
		20175	1732.5	20.70	19.11
		20375	1752.5	20.82	20.07
	1RB-Middle (12)	19975	1712.5	21.04	20.09
		20175	1732.5	20.63	19.27
		20375	1752.5	20.87	19.99

Chongqing Academy of Information and Communication Technology

Address: No. 8,Yuma Road, Chayuan New City, Nan'an District, Chongqing, P. R. China,401336
 Tel: 0086-23-88069965 FAX:0086-23-88608777

	1RB-Low (0)	19975	1712.5	20.84	19.67	
		20175	1732.5	20.59	19.26	
		20375	1752.5	20.55	19.79	
	12RB-High (13)	19975	1712.5	19.98	18.90	
		20175	1732.5	19.69	18.68	
		20375	1752.5	19.76	18.75	
	12RB-Middle (6)	19975	1712.5	19.85	18.82	
		20175	1732.5	19.75	18.86	
		20375	1752.5	19.81	18.74	
	12RB-Low (0)	19975	1712.5	19.86	18.90	
		20175	1732.5	19.63	18.78	
		20375	1752.5	19.76	18.48	
25RB (0)	19975	1712.5	19.91	18.94		
	20175	1732.5	19.73	18.79		
	20375	1752.5	19.82	18.88		
10MHz	1RB-High (49)	20000	1715	20.80	--	
		20175	1732.5	20.84	--	
		20350	1750	20.73	--	
	1RB-Middle (24)	20000	1715	21.29	--	
		20175	1732.5	20.78	--	
		20350	1750	20.56	--	
	1RB-Low (0)	20000	1715	20.72	--	
		20175	1732.5	20.49	--	
		20350	1750	20.47	--	
	25RB-High (25)	20000	1715	19.83	--	
		20175	1732.5	19.73	--	
		20350	1750	19.70	--	
	25RB-Middle (12)	20000	1715	19.92	--	
		20175	1732.5	19.67	--	
		20350	1750	19.63	--	
	25RB-Low (0)	20000	1715	19.76	--	
		20175	1732.5	19.71	--	
		20350	1750	19.49	--	
	50RB (0)	20000	1715	19.83	--	
		20175	1732.5	19.78	--	
		20350	1750	19.70	--	
	15MHz	1RB-High (74)	20025	1717.5	20.69	--
			20175	1732.5	20.55	--
			20325	1747.5	20.91	--
1RB-Middle (37)		20025	1717.5	20.77	--	
		20175	1732.5	20.63	--	
		20325	1747.5	20.42	--	
1RB-Low (0)		20025	1717.5	20.88	--	
		20175	1732.5	20.96	--	
		20325	1747.5	20.67	--	
36RB-High (39)		20025	1717.5	19.81	--	
		20175	1732.5	19.68	--	
		20325	1747.5	19.52	--	
36RB-Middle (19)		20025	1717.5	19.91	--	
		20175	1732.5	19.75	--	
		20325	1747.5	19.50	--	
36RB-Low (0)		20025	1717.5	19.74	--	

Chongqing Academy of Information and Communication Technology

Address: No. 8,Yuma Road, Chayuan New City, Nan'an District, Chongqing, P. R. China,401336
 Tel: 0086-23-88069965 FAX:0086-23-88608777

		20175	1732.5	19.77	--
		20325	1747.5	19.62	--
	75RB (0)	20025	1717.5	19.86	--
		20175	1732.5	19.72	--
		20325	1747.5	19.57	--
20MHz	1RB-High (99)	20050	1720	21.09	--
		20175	1732.5	20.57	--
		20300	1745	20.91	--
	1RB-Mid (49)	20050	1720	21.22	--
		20175	1732.5	20.81	--
		20300	1745	20.63	--
	1RB-Low (0)	20050	1720	20.75	--
		20175	1732.5	20.85	--
		20300	1745	20.60	--
	50RB-High (50)	20050	1720	19.83	--
		20175	1732.5	19.87	--
		20300	1745	19.65	--
	50RB-Middle (25)	20050	1720	19.90	--
		20175	1732.5	19.78	--
		20300	1745	19.71	--
	50RB-Low (0)	20050	1720	19.89	--
		20175	1732.5	19.71	--
		20300	1745	19.67	--
	100RB (0)	20050	1720	19.90	--
		20175	1732.5	19.83	--
		20300	1745	19.62	--

LTE band12					
BANDWIDTH	Number of RBs	Channel	Frequency	QPSK(dBm)	16QAM(dBm)
1.4MHz	1RB-High (5)	23017	699.7	21.46	20.47
		23095	707.5	21.29	20.21
		23173	715.3	21.24	20.55
	1RB-Middle (3)	23017	699.7	21.27	20.33
		23095	707.5	21.15	20.88
		23173	715.3	21.28	20.71
	1RB-Low (0)	23017	699.7	21.06	20.46
		23095	707.5	21.18	20.38
		23173	715.3	21.11	20.64
	3RB-High (3)	23017	699.7	21.41	21.44
		23095	707.5	21.44	21.27
		23173	715.3	21.34	20.94
	3RB-Middle (1)	23017	699.7	21.11	20.27
		23095	707.5	21.04	20.1
		23173	715.3	21.41	20.06
	3RB-Low (0)	23017	699.7	21.43	21.45
		23095	707.5	21.42	20.81
		23173	715.3	21.44	21.15
6RB (0)	23017	699.7	20.20	19.45	
	23095	707.5	20.16	19.26	
	23173	715.3	20.39	19.19	
3MHz	1RB-High (14)	23025	700.5	20.93	20.31
		23095	707.5	20.99	19.90
		23165	714.5	21.31	20.58
	1RB-Middle (7)	23025	700.5	21.17	20.35
		23095	707.5	21.01	20.54
		23165	714.5	21.16	20.26
	1RB-Low (0)	23025	700.5	21.26	20.23
		23095	707.5	20.86	19.54
		23165	714.5	21.25	20.99
	8RB-High (7)	23025	700.5	20.94	21.20
		23095	707.5	21.49	21.51
		23165	714.5	21.71	21.76
	8RB-Middle (4)	23025	700.5	20.09	19.20
		23095	707.5	20.07	19.21
		23165	714.5	20.36	19.41
	8RB-Low (0)	23025	700.5	20.96	21.22
		23095	707.5	21.52	21.50
		23165	714.5	20.85	21.76
15RB (0)	23025	700.5	20.22	19.19	
	23095	707.5	20.20	19.17	
	23165	714.5	20.40	19.51	
5MHz	1RB-High (24)	23035	701.5	20.96	19.89
		23095	707.5	21.00	20.28
		23155	713.5	21.27	20.50
	1RB-Middle (12)	23035	701.5	21.20	20.24
		23095	707.5	21.24	19.96
		23155	713.5	21.27	20.63
1RB-Low (0)	23035	701.5	21.13	20.34	

Chongqing Academy of Information and Communication Technology

Address: No. 8,Yuma Road, Chayuan New City, Nan'an District, Chongqing, P. R. China,401336
 Tel: 0086-23-88069965 FAX:0086-23-88608777

	12RB-High (13)	23095	707.5	20.83	19.77
		23155	713.5	21.30	20.31
		23035	701.5	20.05	18.86
		23095	707.5	20.15	19.04
		23155	713.5	20.27	19.12
		23035	701.5	20.15	19.13
	12RB-Middle (6)	23095	707.5	20.04	19.04
		23155	713.5	20.33	19.08
		23035	701.5	20.24	19.14
	12RB-Low (0)	23095	707.5	20.08	18.80
		23155	713.5	20.22	19.00
		23035	701.5	20.02	19.08
	25RB (0)	23095	707.5	19.92	18.84
		23155	713.5	20.25	19.17
		23060	704	20.74	--
10MHz	1RB-High (49)	23095	707.5	21.32	--
		23130	711	20.95	--
		23060	704	20.75	--
	1RB-Middle (24)	23095	707.5	21.21	--
		23130	711	21.45	--
		23060	704	20.71	--
	1RB-Low (0)	23095	707.5	20.97	--
		23130	711	20.81	--
		23060	704	20.09	--
	25RB-High (25)	23095	707.5	20.12	--
		23130	711	20.22	--
		23060	704	20.04	--
	25RB-Middle (12)	23095	707.5	19.98	--
		23130	711	20.13	--
		23060	704	20.00	--
	25RB-Low (0)	23095	707.5	19.94	--
		23130	711	20.15	--
		23060	704	20.11	--
	50RB (0)	23095	707.5	20.05	--
		23130	711	20.21	--
		23060	704	20.11	--



14.Simultaneous TX SAR Considerations

Note:

For this device, it does not support simultaneous transmission mode.

15.SAR Test Result

15.1 SAR Result

Table 15.1-1: SAR Values(LTE Band2-Body)

Frequency		Mode (number of timeslots)	Test Position	Distance (mm)	Conducted Power (dBm)	Max. tune-up Power (dBm)	Measured SAR(1g) (W/kg)	Reported SAR(1g) (W/kg)	Power Drift (dB)
MHz	Ch.								
1900	19100	20M_QPSK_1@Mid	Front	5	21.14	21.15	1.050	1.05	0.00
1880	18900	20M_QPSK_1@Mid	Front	5	20.26	21.15	0.956	1.17	-0.10
1860	18700	20M_QPSK_1@Mid	Front	5	20.73	21.15	0.884	0.97	-0.07
1900	19100	20M_QPSK_1@Mid	Rear	5	21.14	21.15	0.669	0.67	0.00
1900	19100	20M_QPSK_1@Mid	Left	5	21.14	21.15	0.772	0.77	0.03
1900	19100	20M_QPSK_1@Mid	Right	5	21.14	21.15	0.096	0.10	0.18
1900	19100	20M_QPSK_1@Mid	Top	5	21.14	21.15	0.614	0.62	-0.04
1900	19100	20M_QPSK_1@Mid	Bottom	5	21.14	21.15	0.088	0.09	0.18
1900	19100	20M_QPSK_50@Mid	Front	5	19.83	20.15	0.622	0.67	-0.17
1900	19100	20M_QPSK_50@Mid	Rear	5	19.83	20.15	0.526	0.57	0.00
1900	19100	20M_QPSK_50@Mid	Left	5	19.83	20.15	0.584	0.63	0.01
1900	19100	20M_QPSK_50@Mid	Right	5	19.83	20.15	0.067	0.07	0.11
1900	19100	20M_QPSK_50@Mid	Top	5	19.83	20.15	0.674	0.73	-0.14
1900	19100	20M_QPSK_50@Mid	Bottom	5	19.83	20.15	0.061	0.07	0.08
1900	19100	20M_QPSK_100@0	Front	5	19.67	20.15	0.653	0.73	0.15

Note: This max SAR value zoom scan graph is Fig A.1

Table 15.1-2: SAR Values(LTE Ban4-Body)

Frequency		Mode (number of timeslots)	Test Position	Distance (mm)	Conducted Power (dBm)	Max. tune-up Power (dBm)	Measured SAR(1g) (W/kg)	Reported SAR(1g) (W/kg)	Power Drift (dB)
MHz	Ch.								
1720	20050	20M_QPSK_1@Mid	Front	5	21.22	21.30	0.942	0.96	-0.19
1732.5	20175	20M_QPSK_1@Mid	Front	5	20.81	21.30	0.898	1.01	-0.16
1745	20300	20M_QPSK_1@Mid	Front	5	20.63	21.30	0.991	1.16	-0.14
1720	20050	20M_QPSK_1@Mid	Rear	5	21.22	21.30	0.693	0.71	-0.05
1720	20050	20M_QPSK_1@Mid	Left	5	21.22	21.30	0.650	0.66	-0.18
1720	20050	20M_QPSK_1@Mid	Right	5	21.22	21.30	0.099	0.10	0.18
1720	20050	20M_QPSK_1@Mid	Top	5	21.22	21.30	0.657	0.67	-0.12
1720	20050	20M_QPSK_1@Mid	Bottom	5	21.22	21.30	0.014	0.01	0.18
1732.5	20175	20M_QPSK_50@High	Front	5	19.87	20.30	0.830	0.92	0.16
1720	20050	20M_QPSK_50@High	Front	5	19.83	20.30	0.939	1.05	-0.01
1745	20300	20M_QPSK_50@High	Front	5	19.65	20.30	0.739	0.86	0.17
1732.5	20175	20M_QPSK_50@High	Rear	5	19.87	20.30	0.576	0.64	-0.18
1732.5	20175	20M_QPSK_50@High	Left	5	19.87	20.30	0.526	0.58	-0.12
1732.5	20175	20M_QPSK_50@High	Right	5	19.87	20.30	0.167	0.18	0.10
1732.5	20175	20M_QPSK_50@High	Top	5	19.87	20.30	0.397	0.44	-0.07
1732.5	20175	20M_QPSK_50@High	Bottom	5	19.87	20.30	0.012	0.01	0.17
1720	20050	20M_QPSK_100@0	Front	5	19.90	20.30	0.838	0.92	0.16

Note: This max SAR value zoom scan graph is Fig A.2

Table 15.1-3: SAR Values(LTE Ban12-Body)

Frequency		Mode (number of timeslots)	Test Position	Distance (mm)	Conducted Power (dBm)	Max. tune-up Power (dBm)	Measured SAR(1g) (W/kg)	Reported SAR(1g) (W/kg)	Power Drift (dB)
MHz	Ch.								
711	23130	10M_QPSK_1@Mid	Front	5	21.45	21.72	0.266	0.28	-0.19
711	23130	10M_QPSK_1@Mid	Rear	5	21.45	21.72	0.225	0.24	0.05
711	23130	10M_QPSK_1@Mid	Left	5	21.45	21.72	0.310	0.33	0.00
711	23130	10M_QPSK_1@Mid	Right	5	21.45	21.72	0.268	0.29	0.04
711	23130	10M_QPSK_1@Mid	Top	5	21.45	21.72	0.124	0.13	-0.12
711	23130	10M_QPSK_1@Mid	Bottom	5	21.45	21.72	0.013	0.01	-0.04
707.5	23095	10M_QPSK_25@High	Front	5	20.12	20.72	0.212	0.24	-0.10
707.5	23095	10M_QPSK_25@High	Rear	5	20.12	20.72	0.175	0.20	0.11
707.5	23095	10M_QPSK_25@High	Left	5	20.12	20.72	0.240	0.28	0.01
707.5	23095	10M_QPSK_25@High	Right	5	20.12	20.72	0.237	0.27	-0.11
707.5	23095	10M_QPSK_25@High	Top	5	20.12	20.72	0.095	0.11	-0.05
707.5	23095	10M_QPSK_25@High	Bottom	5	20.12	20.72	0.008	0.01	-0.01

Note: This max SAR value zoom scan graph is Fig A.3

15.2. SAR Measurement Variability

SAR measurement variability must be assessed for each frequency band, which is determined by the SAR probe calibration point and tissue-equivalent medium used for the device measurements. When both head and body tissue-equivalent media are required for SAR measurements in a frequency band, the variability measurement procedures should be applied to the tissue medium with the highest measured SAR, using the highest measured SAR configuration for that tissue-equivalent medium.

The following procedures are applied to determine if repeated measurements are required.

- 1) Repeated measurement is not required when the original highest measured SAR is < 0.80 W/kg; steps 2) through 4) do not apply.
- 2) When the original highest measured SAR is ≥ 0.80 W/kg, repeat that measurement once.
- 3) Perform a second repeated measurement only if the ratio of largest to smallest SAR for the original and first repeated measurements is > 1.20 or when the original or repeated measurement is ≥ 1.45 W/kg (~ 10% from the 1-g SAR limit).
- 4) Perform a third repeated measurement only if the original, first or second repeated measurement is ≥ 1.5 W/kg and the ratio of largest to smallest SAR for the original, first and second repeated measurements is > 1.20 .

Table 15.2-1 SAR Measurement Variability for Body (1g)

Frequency		Mode/band	Test Position	Distance (mm)	Original Measured SAR (W/kg)	First Repeated measured SAR (W/kg)	The Ratio (%)
MHz	Ch.						
1900	19100	20M_QPSK_1@Mid	Front	5	1.050	0.975	1.08
1880	18900	20M_QPSK_1@Mid	Front	5	0.956	0.860	1.11
1860	18700	20M_QPSK_1@Mid	Front	5	0.884	0.894	1.01
1720	20050	20M_QPSK_1@Mid	Front	5	0.942	1.000	1.06
1732.5	20175	20M_QPSK_1@Mid	Front	5	0.898	0.853	1.05
1745	20300	20M_QPSK_1@Mid	Front	5	0.991	0.973	1.02
1720	20050	20M_QPSK_1@Mid	Rear	5	0.693	0.715	1.03
1732.5	20175	20M_QPSK_50@High	Front	5	0.830	0.780	1.06
1720	20050	20M_QPSK_50@High	Front	5	0.939	0.890	1.06
1720	20050	20M_QPSK_100@0	Front	5	0.838	0.850	1.01

16. Measurement Uncertainty

Measurement Uncertainty for Normal SAR Tests (below 3GHz)

Error Description	Uncert. Value	Prob. Dist.	Div.	(Ci)	(Ci)	Std. Unc. [%]	Std. Unc. [%]	(U _i) u _{eff}
				1g	10g	(1g)	(10g)	
Measurement System								
Probe Calibration	12.1	N	2	1	1	6.05	6.05	∞
Axial Isotropy	4.7	R	$\sqrt{3}$	0.7	0.7	1.90	1.90	∞
Hemispherical Isotropy	9.6	R	$\sqrt{3}$	0.7	0.7	3.88	3.88	∞
Boundary effects	1.0	R	$\sqrt{3}$	1	1	0.58	0.58	∞
Linearity	4.7	R	$\sqrt{3}$	1	1	2.71	2.71	∞
System Detection Limits	1.0	R	$\sqrt{3}$	1	1	0.58	0.58	∞
Readout Electronics	0.3	N	1	1	1	0.30	0.30	∞
Response Time	0.8	R	$\sqrt{3}$	1	1	0.50	0.50	∞
Integration Time	2.6	R	$\sqrt{3}$	1	1	1.50	1.50	∞
RF ambient conditions-noise	0	R	$\sqrt{3}$	1	1	0.00	0.00	∞
RF ambient conditions-reflection	0	R	$\sqrt{3}$	1	1	0.00	0.00	∞
Probe Positioned mech.restrictions	0.2	R	$\sqrt{3}$	1	1	0.12	0.12	∞
Probe Positioning with respect to phantom shell	2.9	R	$\sqrt{3}$	1	1	1.67	1.67	∞
Post-processing	4.0	R	$\sqrt{3}$	1	1	2.31	2.31	∞
Test Sample Related								
Device Holder	2.54	N	1	1	1	2.54	2.54	3
Test dample Positioning	0.5	N	1	1	1	0.50	0.50	63
Power Drift	5.0	R	$\sqrt{3}$	1	1	2.89	2.89	∞
Phantom and Setup								
Phantom Uncertainty	7.5	R	$\sqrt{3}$	1	1	4.33	4.33	∞
Liquid Conductivity (target)	5.0	R	$\sqrt{3}$	0.64	0.43	1.85	1.24	∞
Liquid Conductivity (meas..)	2.5	N	1	0.64	0.43	1.60	1.08	∞
Liquid Permittivity (target)	5.00	R	$\sqrt{3}$	0.6	0.49	1.73	1.41	∞
Liquid Permittivity (meas..)	0.4	N	1	0.6	0.49	0.24	0.20	∞
Combined Std. Uncertainty	$U'_c = \sqrt{\sum_{i=1}^{23} C_i^2 U_i^2}$	RSS				10.09	9.96	
Expanded STD Uncertainty	$U_c = 2U'_c$					20.18	19.93	

Measurement Uncertainty for Fast SAR Tests (below 3GHz)

Error Description	Uncert. Value	Prob. Dist.	Div.	(Ci)	(Ci)	Std. Unc. [%]	Std. Unc. [%]	(Ui) ueff
				1g	10g	(1g)	(10g)	
Measurement System								
Probe Calibration	12.1	N	2	1	1	6.05	6.05	∞
Axial Isotropy	4.7	R	$\sqrt{3}$	0.7	0.7	1.90	1.90	∞
Hemispherical Isotropy	9.6	R	$\sqrt{3}$	0.7	0.7	3.88	3.88	∞
Boundary effects	1.0	R	$\sqrt{3}$	1	1	0.58	0.58	∞
Linearity	4.7	R	$\sqrt{3}$	1	1	2.71	2.71	∞
System Detection Limits	1.0	R	$\sqrt{3}$	1	1	0.58	0.58	∞
Readout Electronics	0.3	N	1	1	1	0.30	0.30	∞
Response Time	0.8	R	$\sqrt{3}$	1	1	0.50	0.50	∞
Integration Time	2.6	R	$\sqrt{3}$	1	1	1.50	1.50	∞
RF ambient conditions-noise	0	R	$\sqrt{3}$	1	1	0.00	0.00	∞
RF ambient conditions-reception	0	R	$\sqrt{3}$	1	1	0.00	0.00	∞
Probe Positioned mech.restrictions	0.2	R	$\sqrt{3}$	1	1	0.12	0.12	∞
Probe Positioning with respect to phantom shell	2.9	R	$\sqrt{3}$	1	1	1.67	1.67	∞
Post-processing	4.0	R	$\sqrt{3}$	1	1	2.31	2.31	∞
Fast SAR-Z-Approximation	7.0	R	$\sqrt{3}$	1	1	4.0	4.0	∞
Test Sample Related								
Device Holder	2.54	N	1	1	1	2.54	2.54	3
Test dample Positioning	0.5	N	1	1	1	0.50	0.50	63
Power Drift	5.0	R	$\sqrt{3}$	1	1	2.89	2.89	∞
Phantom and Setup								
Phantom Uncertainty	7.5	R	$\sqrt{3}$	1	1	4.33	4.33	∞
Liquid Conductivity (target)	5.0	R	$\sqrt{3}$	0.64	0.43	1.85	1.24	∞
Liquid Conductivity (meas..)	2.5	N	1	0.64	0.43	1.60	1.08	∞
Liquid Permittivity (target)	5.00	R	$\sqrt{3}$	0.6	0.49	1.73	1.41	∞
Liquid Permittivity (meas..)	0.4	N	1	0.6	0.49	0.24	0.20	∞
Combined Std. Uncertainty	$U_c' = \sqrt{\sum_{i=1}^{23} Ci^2 Ui^2}$	RSS				10.85	10.73	
Expanded STD Uncertainty	$U_c = 2U_c'$					21.70	21.46	

17. MAIN TEST INSTRUMENTS

Table 17-1: List of Main Instruments

No.	Name	Type	Serial Number	Software version	Hardware version	Calibration Date	Valid Period
01	Probe	EX3DV4	3844	--	--	2022-06-08	2023-06-07
02	DAE	DAE4	797	--	--	2022-05-17	2023-05-16
03	Power Meter	N1914A	MY50001660	--	--	2022-05-30	2023-5-29
04	Radio Communication Analyzer	CMW500	109616	--	--	2022-05-30	2023-05-29
05	Signal Generator	N5181A	MY50143363	--	--	2022-05-30	2023-5-29
06	Power Sensor	E8481H	MY51020011	--	--	2022-05-30	2023-5-29
07	Power Amplifier	ZHL	QA1202003	--	--	2022-05-30	2023-05-29
08	Network Analyzer	E5071C	MY46212462	A.10.0x	8.0	2022-05-30	2023-5-29
09	D1750V2	Dipole	1063	--	--	2020-10-15	2023-5-13
10	D1900V2	Dipole	5d153	--	--	2020-10-14	2023-5-13
11	D750V2	Dipole	1037	--	--	2021-4-17	2023-5-13

END OF REPORT BODY

ANNEX A. GRAPH RESULTS

LTE Band2 Body Front (5mm)

Date/Time: 2023/3/6

Electronics: DAE4 Sn797

Medium: Head 1900MHz

Medium parameters used: $f = 1880$ MHz; $\sigma = 1.418$ S/m; $\epsilon_r = 40.446$; $\rho = 1000$ kg/m³

Ambient Temperature: 22.5°C Liquid Temperature: 22.1°C

Communication System: LTE Band 2 (0); Frequency: 1880 MHz; Duty Cycle: 1:1

Probe: EX3DV4 - SN3844ConvF(8.1, 8.1, 8.1)

Area Scan (6x7x1): Measurement grid: dx=15mm, dy=15mm

Maximum value of SAR (measured) = 1.04 W/kg

Zoom Scan (5x5x7)/Cube 0: Measurement grid: dx=8mm, dy=8mm, dz=5mm

Reference Value = 26.28 V/m; Power Drift = -0.10 dB

Peak SAR (extrapolated) = 1.60 W/kg

SAR(1 g) = 0.956 W/kg; SAR(10 g) = 0.549 W/kg

Maximum value of SAR (measured) = 1.04 W/kg

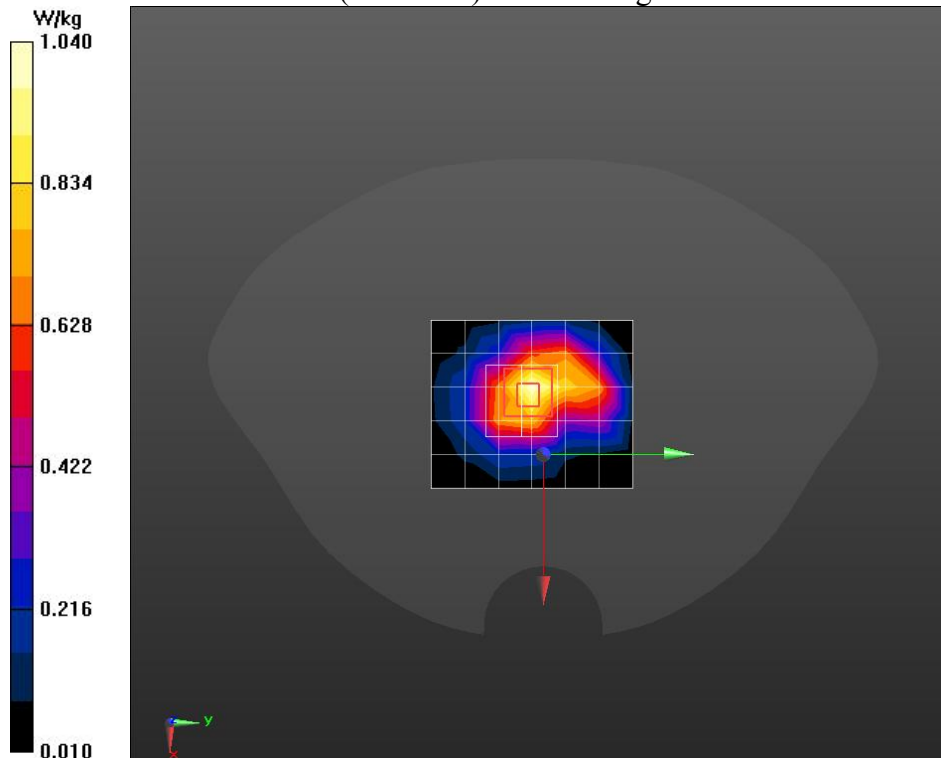

Fig A.1

LTE Band4 Body Front (5mm)

Date/Time: 2023/3/6

Electronics: DAE4 Sn797

Medium: Head 1750MHz

Medium parameters used: $f = 1745 \text{ MHz}$; $\sigma = 1.352 \text{ S/m}$; $\epsilon_r = 41.075$; $\rho = 1000 \text{ kg/m}^3$

Ambient Temperature: 22.5°C Liquid Temperature: 22.1°C

Communication System: LTE Band 4 (0); Frequency: 1745 MHz; Duty Cycle: 1:1

Probe: EX3DV4 - SN3844ConvF(8.5, 8.5, 8.5)

Area Scan (5x7x1): Measurement grid: $dx=15\text{mm}$, $dy=15\text{mm}$

Maximum value of SAR (measured) = 1.03 W/kg

Zoom Scan (5x5x7)/Cube 0: Measurement grid: $dx=8\text{mm}$, $dy=8\text{mm}$, $dz=5\text{mm}$

Reference Value = 29.51 V/m; Power Drift = -0.14 dB

Peak SAR (extrapolated) = 1.73 W/kg

SAR(1 g) = 0.991 W/kg; SAR(10 g) = 0.565 W/kg

Maximum value of SAR (measured) = 1.08 W/kg

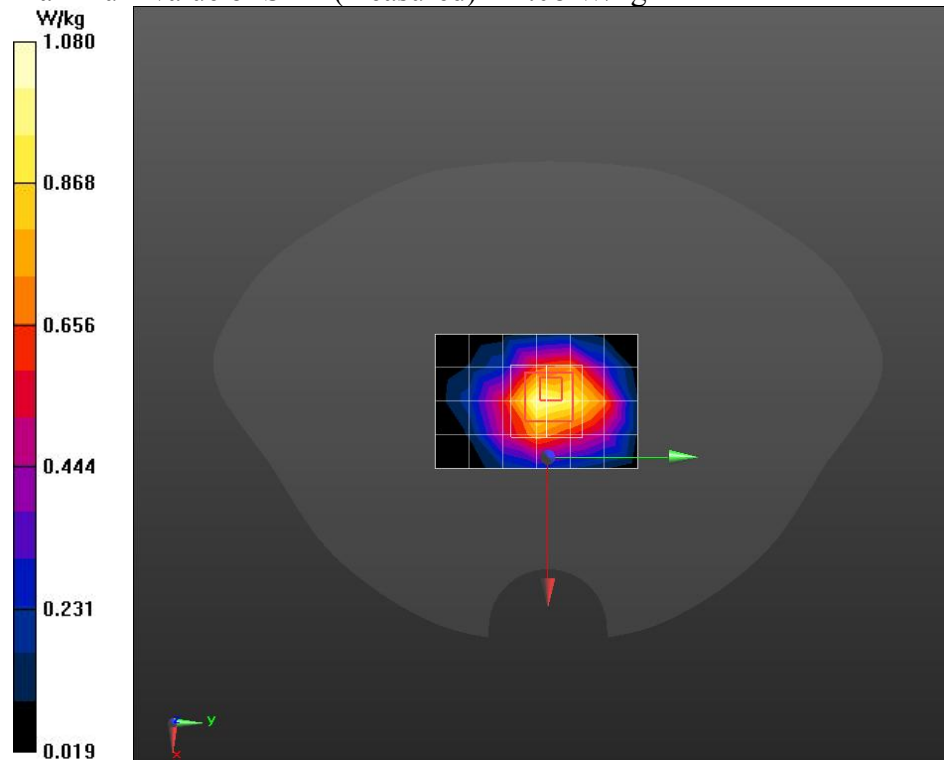

Fig A.2

LTE Band12 Body Left (5mm)

Date/Time: 2023/3/7

Electronics: DAE4 Sn797

Medium: Head 750MHz

Medium parameters used: $f = 711 \text{ MHz}$; $\sigma = 0.88 \text{ S/m}$; $\epsilon_r = 43.121$; $\rho = 1000 \text{ kg/m}^3$ Ambient Temperature: 22.5°C Liquid Temperature: 22.1°C

Communication System: LTE Band 12 (0); Frequency: 711 MHz; Duty Cycle: 1:1

Probe: EX3DV4 - SN3844ConvF(9.96, 9.96, 9.96)

Area Scan (4x7x1): Measurement grid: $dx=15\text{mm}$, $dy=15\text{mm}$

Maximum value of SAR (measured) = 0.282 W/kg

Zoom Scan (5x5x7)/Cube 0: Measurement grid: $dx=8\text{mm}$, $dy=8\text{mm}$, $dz=5\text{mm}$

Reference Value = 15.71 V/m; Power Drift = 0.00 dB

Peak SAR (extrapolated) = 0.592 W/kg

SAR(1 g) = 0.310 W/kg; SAR(10 g) = 0.173 W/kg

Maximum value of SAR (measured) = 0.329 W/kg

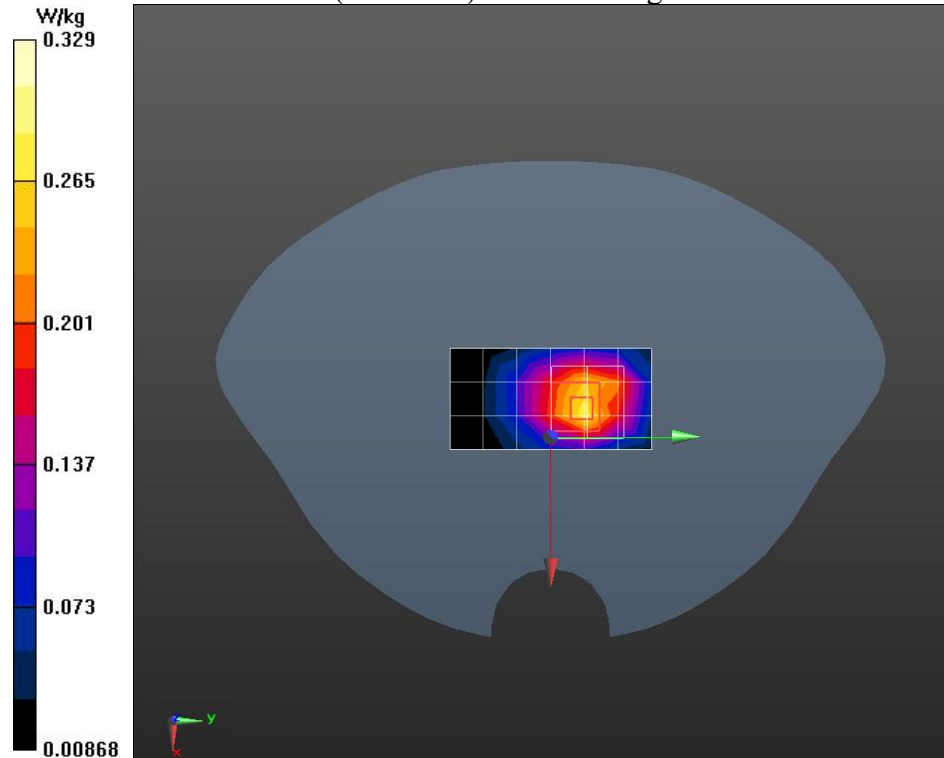

Fig A.3

ANNEX B. SYSTEM VALIDATION RESULTS

System Check Head 750 MHz

Date/Time: 2023/3/7

Medium: Head 750MHz

Medium parameters used: $f = 750$ MHz; $\sigma = 0.902$ S/m; $\epsilon_r = 40.717$; $\rho = 1000$ kg/m³

Ambient Temperature: 22.5°C Liquid Temperature: 22.1°C

Communication System: CW (0); Frequency: 750 MHz; Duty Cycle: 1:1

Probe: EX3DV4 - SN3844ConvF(9.96, 9.96, 9.96)

Area Scan (7x21x1): Measurement grid: dx=10mm, dy=10mm

Maximum value of SAR (measured) = 2.39 W/kg

Zoom Scan (7x7x7)/Cube 0: Measurement grid: dx=5mm, dy=5mm, dz=5mm

Reference Value = 51.91 V/m; Power Drift = 0.00 dB

Peak SAR (extrapolated) = 3.68 W/kg

SAR(1 g) = 2.230 W/kg; SAR(10 g) = 1.360 W/kg

Maximum value of SAR (measured) = 2.45 W/kg

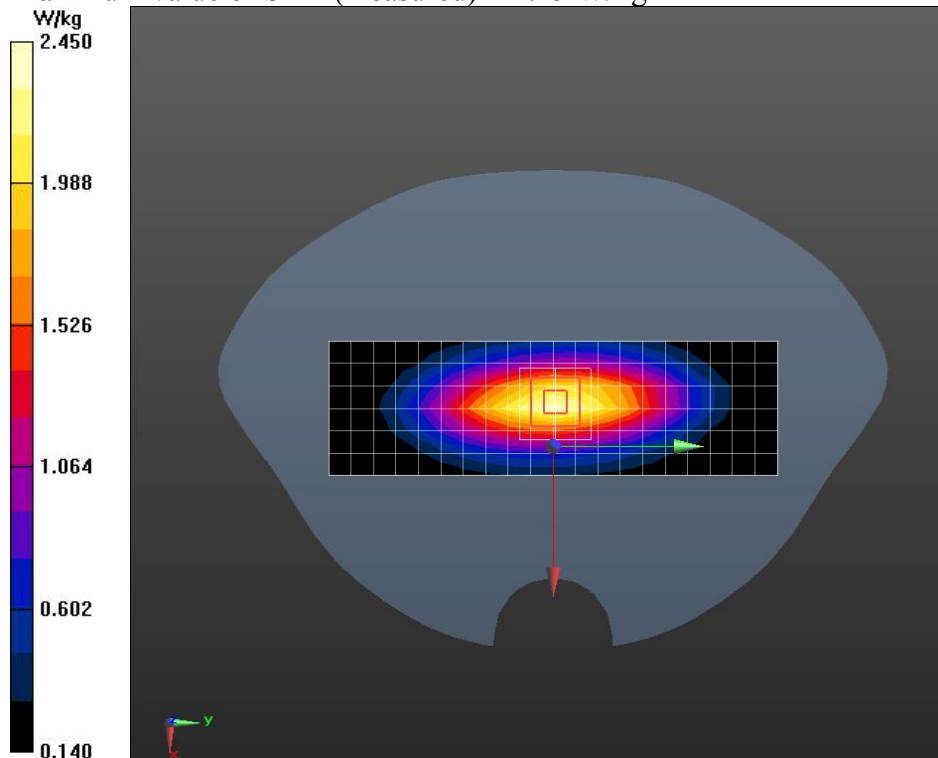

Chongqing Academy of Information and Communication Technology

Address: No. 8, Yuma Road, Chayuan New City, Nan'an District, Chongqing, P. R. China, 401336

Tel: 0086-23-88069965

FAX: 0086-23-88608777

System Check Head 1750MHz

Date/Time: 2023/3/6

Electronics: DAE4 Sn797

Medium: Head 1750MHz

Medium parameters used: $f = 1750 \text{ MHz}$; $\sigma = 1.361 \text{ S/m}$; $\epsilon_r = 41.103$; $\rho = 1000 \text{ kg/m}^3$

Ambient Temperature: 22.5°C Liquid Temperature: 22.1°C

Communication System: CW (0); Frequency: 1750 MHz; Duty Cycle: 1:1

Probe: EX3DV4 - SN3844ConvF(8.5, 8.5, 8.5)

Area Scan (6x11x1): Measurement grid: $dx=10\text{mm}$, $dy=10\text{mm}$

Maximum value of SAR (measured) = 8.53 W/kg

Zoom Scan (7x7x7)/Cube 0: Measurement grid: $dx=5\text{mm}$, $dy=5\text{mm}$, $dz=5\text{mm}$

Reference Value = 82.24 V/m; Power Drift = 0.04 dB

Peak SAR (extrapolated) = 15.7 W/kg

SAR(1 g) = 8.280 W/kg; SAR(10 g) = 4.300W/kg

Maximum value of SAR (measured) = 9.29 W/kg

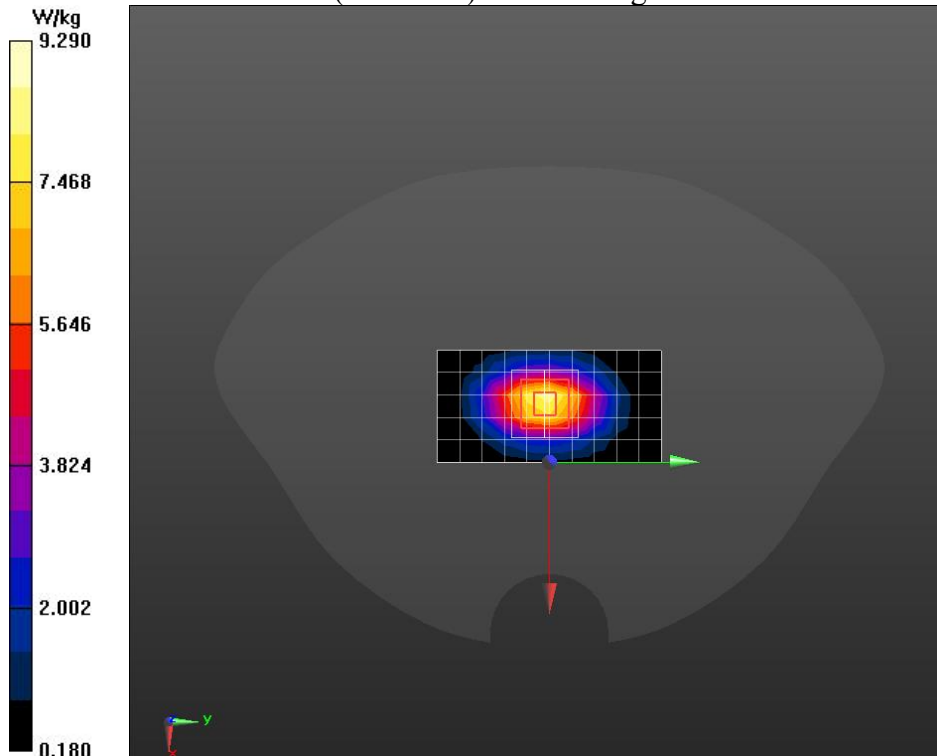

Chongqing Academy of Information and Communication Technology

Address: No. 8, Yuma Road, Chayuan New City, Nan'an District, Chongqing, P. R. China, 401336

Tel: 0086-23-88069965

FAX: 0086-23-88608777

System Check Head 1900MHz

Date/Time: 2023/3/6

Electronics: DAE4 Sn797

Medium: Head 1900MHz

Medium parameters used: $f = 1900 \text{ MHz}$; $\sigma = 1.433 \text{ S/m}$; $\epsilon_r = 40.335$; $\rho = 1000 \text{ kg/m}^3$

Ambient Temperature: 22.5°C Liquid Temperature: 22.1°C

Communication System: CW (0); Frequency: 1900 MHz; Duty Cycle: 1:1

Probe: EX3DV4 - SN3844ConvF(8.1, 8.1, 8.1)

Area Scan (7x13x1): Measurement grid: $dx=10\text{mm}$, $dy=10\text{mm}$

Maximum value of SAR (measured) = 10.1 W/kg

Zoom Scan (7x7x7)/Cube 0: Measurement grid: $dx=5\text{mm}$, $dy=5\text{mm}$, $dz=5\text{mm}$

Reference Value = 84.78 V/m ; Power Drift = 0.11 dB

Peak SAR (extrapolated) = 19.1 W/kg

SAR(1 g) = 9.610 W/kg ; SAR(10 g) = 4.840 W/kg

Maximum value of SAR (measured) = 10.8 W/kg

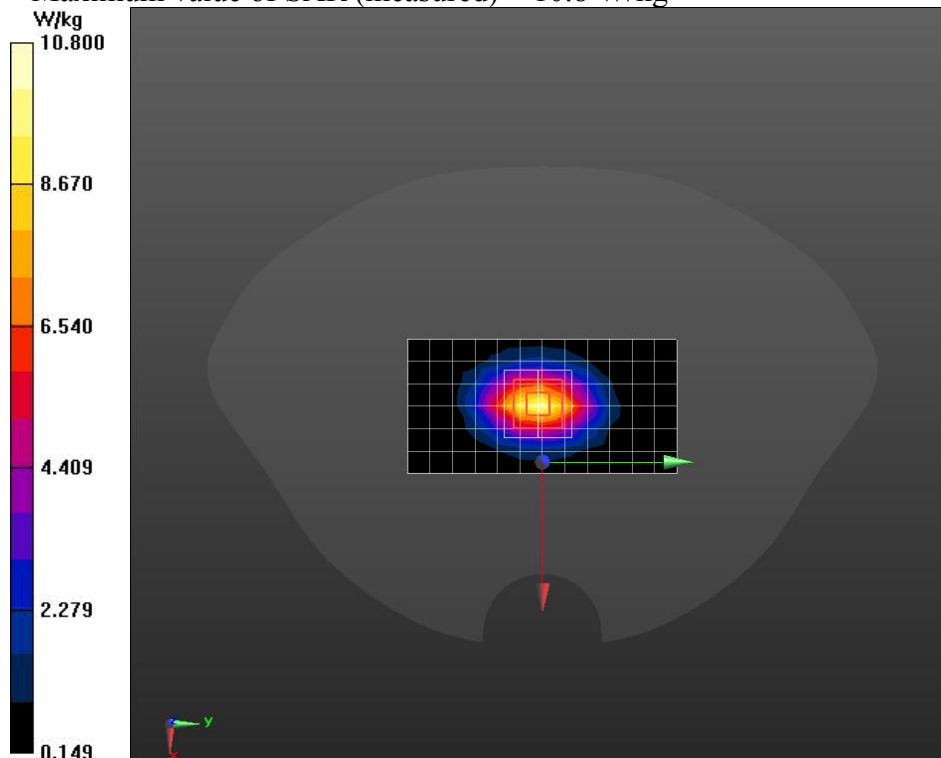

ANNEX C. CALIBRATION REPORT



In Collaboration with
TTL s p e a g
CALIBRATION LABORATORY

Add: No.52 HuaYuanBei Road, Haidian District, Beijing, 100191, China
Tel: +86-10-62304633-2512 Fax: +86-10-62304633-2504
E-mail: ctrl@chinattl.com Http://www.chinattl.cn



中国认可
国际互认
校准
CALIBRATION
CNAS L0570

Client : **CATR(Chongqing)** Certificate No: **Z22-60163**

CALIBRATION CERTIFICATE

Object : DAE4 - SN: 797

Calibration Procedure(s) : FF-Z11-002-01
Calibration Procedure for the Data Acquisition Electronics (DAEx)

Calibration date: May 17, 2022

This calibration Certificate documents the traceability to national standards, which realize the physical units of measurements(SI). The measurements and the uncertainties with confidence probability are given on the following pages and are part of the certificate.

All calibrations have been conducted in the closed laboratory facility: environment temperature(22±3)°C and humidity<70%.

Calibration Equipment used (M&TE critical for calibration)

Primary Standards	ID #	Cal Date(Calibrated by, Certificate No.)	Scheduled Calibration
Process Calibrator 753	1971018	15-Jun-21 (CTTL, No.J21X04465)	Jun-22

Calibrated by:	Name	Function
	Yu Zongying	SAR Test Engineer
Reviewed by:	Lin Hao	SAR Test Engineer
Approved by:	Qi Dianyuan	SAR Project Leader



Signature

Issued: May 23, 2022

This calibration certificate shall not be reproduced except in full without written approval of the laboratory.

Certificate No: Z22-60163

Page 1 of 3

Chongqing Academy of Information and Communication Technology

Address: No. 8, Yuma Road, Chayuan New City, Nan'an District, Chongqing, P. R. China, 401336
Tel: 0086-23-88069965

FAX: 0086-23-88608777



In Collaboration with
s p e a g
CALIBRATION LABORATORY



Add: No.52 HuaYuanBei Road, Haidian District, Beijing, 100191, China
Tel: +86-10-62304633-2512 Fax: +86-10-62304633-2504
E-mail: ctt@chinattl.com Http://www.chinattl.cn

Glossary:

DAE	data acquisition electronics
Connector angle	information used in DASYS system to align probe sensor X to the robot coordinate system.

Methods Applied and Interpretation of Parameters:

- *DC Voltage Measurement:* Calibration Factor assessed for use in DASYS system by comparison with a calibrated instrument traceable to national standards. The figure given corresponds to the full scale range of the voltmeter in the respective range.

- *Connector angle:* The angle of the connector is assessed measuring the angle mechanically by a tool inserted. Uncertainty is not required.

- The report provide only calibration results for DAE, it does not contain other performance test results.

Certificate No: Z22-60163Page 2 of 3



Add: No.52 HuaYuanBei Road, Haidian District, Beijing, 100191, China
 Tel: +86-10-62304633-2512 Fax: +86-10-62304633-2504
 E-mail: cttl@chinattl.com Http://www.chinattl.cn

DC Voltage Measurement

A/D - Converter Resolution nominal
 High Range: 1LSB = 6.1μV, full range = -100...+300 mV
 Low Range: 1LSB = 61nV, full range = -1.....+3mV
 DASY measurement parameters: Auto Zero Time: 3 sec; Measuring time: 3 sec

Calibration Factors	X	Y	Z
High Range	403.835 ± 0.15% (k=2)	404.092 ± 0.15% (k=2)	403.825 ± 0.15% (k=2)
Low Range	3.95845 ± 0.7% (k=2)	3.96789 ± 0.7% (k=2)	3.97952 ± 0.7% (k=2)

Connector Angle

Connector Angle to be used in DASY system	43° ± 1 °
---	-----------



TTL In Collaboration with **s p e a g**
CALIBRATION LABORATORY

Add: No.52 HuaYuanBei Road, Haidian District, Beijing, 100191, China
 Tel: +86-10-62304633-2117
 E-mail: cttl@chinattl.com http://www.caict.ac.cn

HAC-MRA **CNAS** 中国认可 国际互认 校准
 CALIBRATION CNAS L0570

Client **CATR(Chongqing)** Certificate No: **Z22-60227**

CALIBRATION CERTIFICATE

Object **EX3DV4 - SN : 3844**

Calibration Procedure(s) **FF-Z11-004-02**
Calibration Procedures for Dosimetric E-field Probes

Calibration date: **July 08, 2022**

This calibration Certificate documents the traceability to national standards, which realize the physical units of measurements(SI). The measurements and the uncertainties with confidence probability are given on the following pages and are part of the certificate.

All calibrations have been conducted in the closed laboratory facility: environment temperature(22±3)°C and humidity<70%.

Calibration Equipment used (M&TE critical for calibration)

Primary Standards	ID #	Cal Date(Calibrated by, Certificate No.)	Scheduled Calibration
Power Meter NRP2	101919	14-Jun-22(CTTL, No.J22X04181)	Jun-23
Power sensor NRP-Z91	101547	14-Jun-22(CTTL, No.J22X04181)	Jun-23
Power sensor NRP-Z91	101548	14-Jun-22(CTTL, No.J22X04181)	Jun-23
Reference 10dBAttenuator	18N50W-10dB	20-Jan-21(CTTL, No.J21X00486)	Jan-23
Reference 20dBAttenuator	18N50W-20dB	20-Jan-21(CTTL, No.J21X00485)	Jan-23
Reference Probe EX3DV4	SN 7464	26-Jan-22(SPEAG, No.EX3-7464_Jan22)	Jan-23
DAE4	SN 1555	20-Aug-21(SPEAG, No.DAE4-1555_Aug21/2)	Aug-22

Secondary Standards	ID #	Cal Date(Calibrated by, Certificate No.)	Scheduled Calibration
SignalGenerator MG3700A	6201052605	14-Jun-22(CTTL, No.J22X04182)	Jun-23
Network Analyzer E5071C	MY46110673	14-Jan-22(CTTL, No.J22X00406)	Jan-23

	Name	Function	Signature
Calibrated by:	Yu Zongying	SAR Test Engineer	
Reviewed by:	Lin Hao	SAR Test Engineer	
Approved by:	Qi Dianyuan	SAR Project Leader	

Issued: July 20, 2022

This calibration certificate shall not be reproduced except in full without written approval of the laboratory.

Certificate No: Z22-60227 Page 1 of 9

Chongqing Academy of Information and Communication Technology

Address: No. 8,Yuma Road, Chayuan New City, Nan'an District, Chongqing, P. R. China,401336
 Tel: 0086-23-88069965

FAX:0086-23-88608777

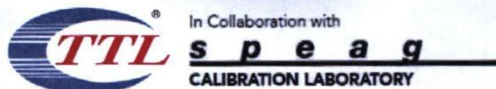

Add: No.52 HuaYuanBei Road, Haidian District, Beijing, 100191, China
Tel: +86-10-62304633-2117
E-mail: cttl@chinattl.com <http://www.caict.ac.cn>

Glossary:

TSL	tissue simulating liquid
NORM _{x,y,z}	sensitivity in free space
ConvF	sensitivity in TSL / NORM _{x,y,z}
DCP	diode compression point
CF	crest factor (1/duty_cycle) of the RF signal
A,B,C,D	modulation dependent linearization parameters
Polarization Φ	Φ rotation around probe axis
Polarization θ	θ rotation around an axis that is in the plane normal to probe axis (at measurement center), $\theta=0$ is normal to probe axis

Connector Angle information used in DASY system to align probe sensor X to the robot coordinate system

Calibration is Performed According to the Following Standards:

- IEEE Std 1528-2013, "IEEE Recommended Practice for Determining the Peak Spatial-Averaged Specific Absorption Rate (SAR) in the Human Head from Wireless Communications Devices: Measurement Techniques", June 2013
- IEC 62209-1, "Measurement procedure for the assessment of Specific Absorption Rate (SAR) from hand-held and body-mounted devices used next to the ear (frequency range of 300 MHz to 6 GHz)", July 2016
- IEC 62209-2, "Procedure to determine the Specific Absorption Rate (SAR) for wireless communication devices used in close proximity to the human body (frequency range of 30 MHz to 6 GHz)", March 2010
- KDB 865664, "SAR Measurement Requirements for 100 MHz to 6 GHz"

Methods Applied and Interpretation of Parameters:

- NORM_{x,y,z}:** Assessed for E-field polarization $\theta=0$ ($f \leq 900$ MHz in TEM-cell; $f > 1800$ MHz: waveguide). NORM_{x,y,z} are only intermediate values, i.e., the uncertainties of NORM_{x,y,z} does not effect the E^2 -field uncertainty inside TSL (see below ConvF).
- NORM(f)_{x,y,z} = NORM_{x,y,z} * frequency_response** (see Frequency Response Chart). This linearization is implemented in DASY4 software versions later than 4.2. The uncertainty of the frequency response is included in the stated uncertainty of ConvF.
- DCP_{x,y,z}:** DCP are numerical linearization parameters assessed based on the data of power sweep (no uncertainty required). DCP does not depend on frequency nor media.
- PAR:** PAR is the Peak to Average Ratio that is not calibrated but determined based on the signal characteristics.
- A_{x,y,z}; B_{x,y,z}; C_{x,y,z}; VR_{x,y,z}:** A,B,C are numerical linearization parameters assessed based on the data of power sweep for specific modulation signal. The parameters do not depend on frequency nor media. VR is the maximum calibration range expressed in RMS voltage across the diode.
- ConvF and Boundary Effect Parameters:** Assessed in flat phantom using E-field (or Temperature Transfer Standard for $f \leq 800$ MHz) and inside waveguide using analytical field distributions based on power measurements for $f > 800$ MHz. The same setups are used for assessment of the parameters applied for boundary compensation (alpha, depth) of which typical uncertainty valued are given. These parameters are used in DASY4 software to improve probe accuracy close to the boundary. The sensitivity in TSL corresponds to NORM_{x,y,z} * ConvF whereby the uncertainty corresponds to that given for ConvF. A frequency dependent ConvF is used in DASY version 4.4 and higher which allows extending the validity from ± 50 MHz to ± 100 MHz.
- Spherical isotropy (3D deviation from isotropy):** in a field of low gradients realized using a flat phantom exposed by a patch antenna.
- Sensor Offset:** The sensor offset corresponds to the offset of virtual measurement center from the probe tip (on probe axis). No tolerance required.
- Connector Angle:** The angle is assessed using the information gained by determining the NORM_x (no uncertainty required).

Certificate No: Z22-60227

Page 2 of 9

Chongqing Academy of Information and Communication Technology

Address: No. 8, Yuma Road, Chayuan New City, Nan'an District, Chongqing, P. R. China, 401336
Tel: 0086-23-88069965

FAX: 0086-23-88608777

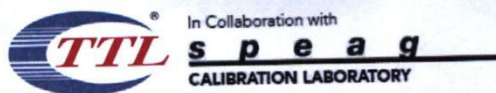

Add: No.52 HuaYuanBei Road, Haidian District, Beijing, 100191, China
 Tel: +86-10-62304633-2117
 E-mail: cttl@chinattl.com http://www.caict.ac.cn

DASY/EASY – Parameters of Probe: EX3DV4 – SN:3844

Basic Calibration Parameters

	Sensor X	Sensor Y	Sensor Z	Unc (k=2)
Norm($\mu\text{V}/(\text{V}/\text{m})^2$) ^A	0.49	0.41	0.19	$\pm 10.0\%$
DCP(mV) ^B	103.0	101.8	97.3	

Modulation Calibration Parameters

UID	Communication System Name		A dB	B dB $\cdot\mu\text{V}$	C	D dB	VR mV	Unc ^E (k=2)
0	CW	X	0.0	0.0	1.0	0.00	162.7	$\pm 2.5\%$
		Y	0.0	0.0	1.0		144.4	
		Z	0.0	0.0	1.0		85.6	

The reported uncertainty of measurement is stated as the standard uncertainty of Measurement multiplied by the coverage factor $k=2$, which for a normal distribution Corresponds to a coverage probability of approximately 95%.

^A The uncertainties of Norm X, Y, Z do not affect the E²-field uncertainty inside TSL (see Page 4).

^B Numerical linearization parameter: uncertainty not required.

^E Uncertainty is determined using the max. deviation from linear response applying rectangular distribution and is expressed for the square of the field value.

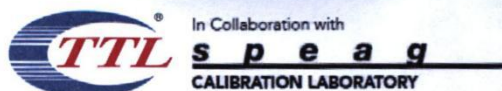

Add: No.52 HuaYuanBei Road, Haidian District, Beijing, 100191, China
 Tel: +86-10-62304633-2117
 E-mail: cttl@chinattl.com http://www.caict.ac.cn

DASY/EASY – Parameters of Probe: EX3DV4 – SN:3844

Calibration Parameter Determined in Head Tissue Simulating Media

f [MHz] ^C	Relative Permittivity ^F	Conductivity (S/m) ^F	ConvF X	ConvF Y	ConvF Z	Alpha ^G	Depth ^G (mm)	Unct. (k=2)
750	41.9	0.89	9.96	9.96	9.96	0.21	1.17	± 12.1%
900	41.5	0.97	9.55	9.55	9.55	0.29	1.00	± 12.1%
1750	40.1	1.37	8.50	8.50	8.50	0.24	1.03	± 12.1%
1900	40.0	1.40	8.10	8.10	8.10	0.24	1.01	± 12.1%
2100	39.8	1.49	8.18	8.18	8.18	0.23	1.18	± 12.1%
2300	39.5	1.67	7.95	7.95	7.95	0.65	0.67	± 12.1%
2450	39.2	1.80	7.69	7.69	7.69	0.65	0.68	± 12.1%
2600	39.0	1.96	7.49	7.49	7.49	0.65	0.67	± 12.1%
3300	38.2	2.71	7.24	7.24	7.24	0.46	0.96	± 13.3%
3500	37.9	2.91	7.00	7.00	7.00	0.48	0.97	± 13.3%
3700	37.7	3.12	6.78	6.78	6.78	0.43	1.03	± 13.3%
3900	37.5	3.32	6.74	6.74	6.74	0.40	1.25	± 13.3%
5250	35.9	4.71	5.48	5.48	5.48	0.55	1.17	± 13.3%
5600	35.5	5.07	4.96	4.96	4.96	0.60	1.16	± 13.3%
5750	35.4	5.22	5.01	5.01	5.01	0.55	1.22	± 13.3%

^C Frequency validity above 300 MHz of ±100MHz only applies for DASY v4.4 and higher (Page 2), else it is restricted to ±50MHz. The uncertainty is the RSS of ConvF uncertainty at calibration frequency and the uncertainty for the indicated frequency band. Frequency validity below 300 MHz is ± 10, 25, 40, 50 and 70 MHz for ConvF assessments at 30, 64, 128, 150 and 220 MHz respectively. Above 5 GHz frequency validity can be extended to ± 110 MHz.

^F At frequency below 3 GHz, the validity of tissue parameters (ϵ and σ) can be relaxed to ±10% if liquid compensation formula is applied to measured SAR values. At frequencies above 3 GHz, the validity of tissue parameters (ϵ and σ) is restricted to ±5%. The uncertainty is the RSS of the ConvF uncertainty for indicated target tissue parameters.

^G Alpha/Depth are determined during calibration. SPEAG warrants that the remaining deviation due to the boundary effect after compensation is always less than ± 1% for frequencies below 3 GHz and below ± 2% for the frequencies between 3-6 GHz at any distance larger than half the probe tip diameter from the boundary.

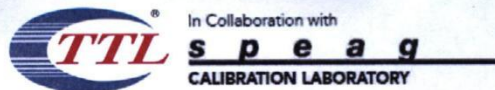

Add: No.52 HuaYuanBei Road, Haidian District, Beijing, 100191, China
Tel: +86-10-62304633-2117
E-mail: cttl@chinattl.com <http://www.caict.ac.cn>



Frequency Response of E-Field (TEM-Cell: ifi110 EXX, Waveguide: R22)

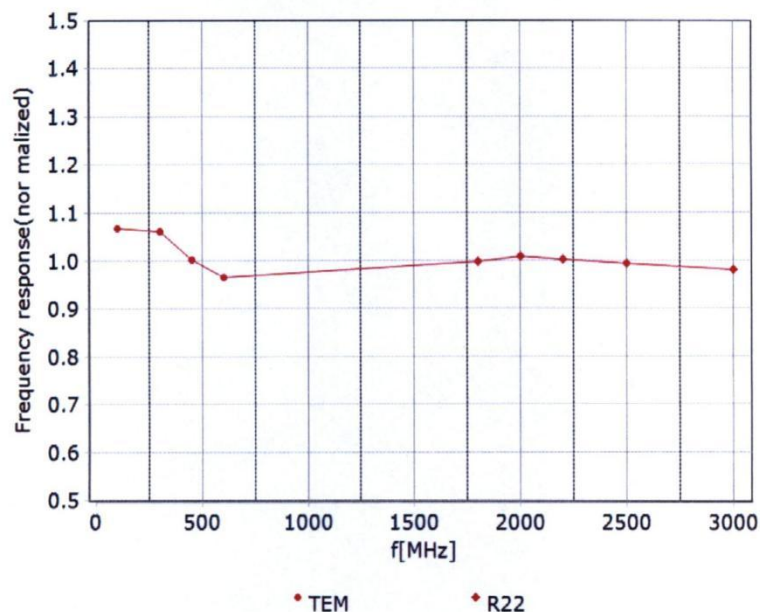

Uncertainty of Frequency Response of E-field: $\pm 7.4\%$ ($k=2$)

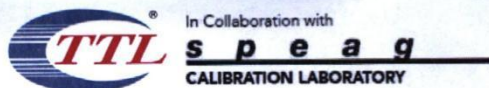

Add: No.52 HuaYuanBei Road, Haidian District, Beijing, 100191, China
 Tel: +86-10-62304633-2117
 E-mail: cttl@chinattl.com http://www.caict.ac.cn

Receiving Pattern (Φ), $\theta=0^\circ$

f=600 MHz, TEM

f=1800 MHz, R22

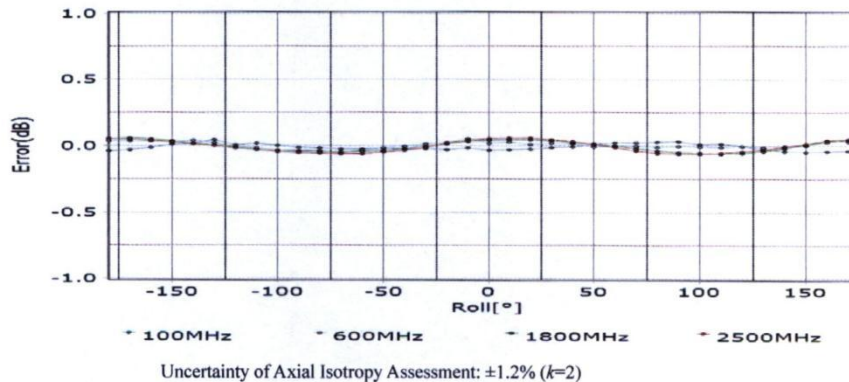
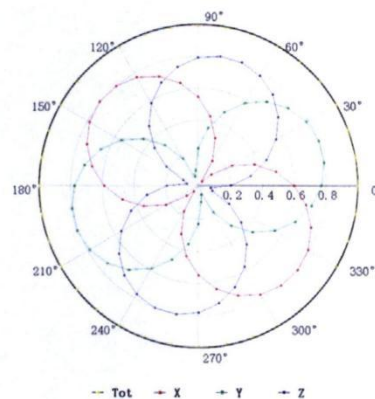
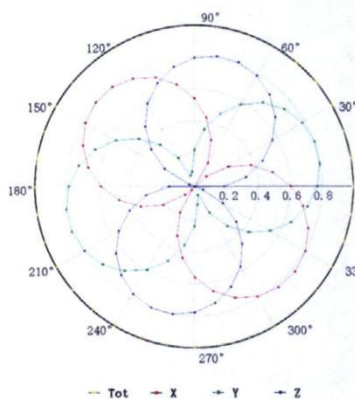

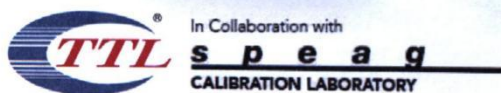

Add: No.52 HuaYuanBei Road, Haidian District, Beijing, 100191, China
Tel: +86-10-62304633-2117
E-mail: cttl@chinattl.com <http://www.caict.ac.cn>

Dynamic Range f(SAR_{head}) (TEM cell, f = 900 MHz)

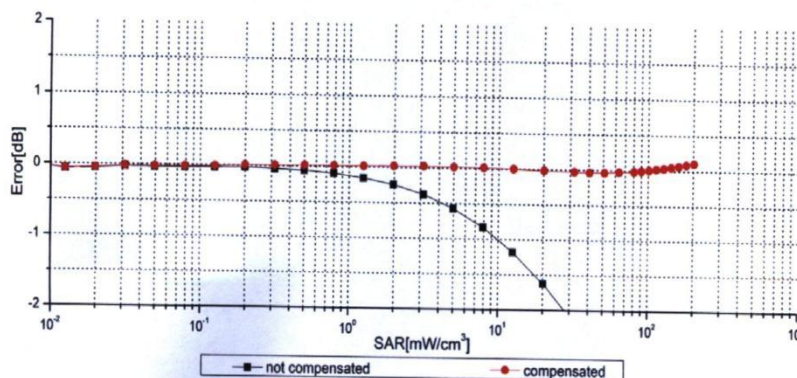
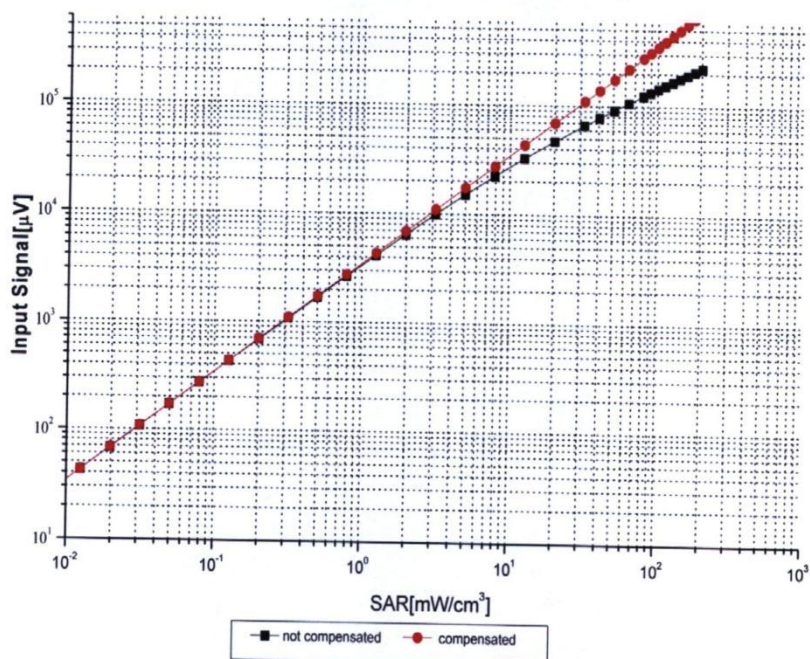

Uncertainty of Linearity Assessment: ±0.9% (k=2)

Conversion Factor Assessment

f=750 MHz,WGLS R9(H_convF)

f=1750 MHz,WGLS R22(H_convF)

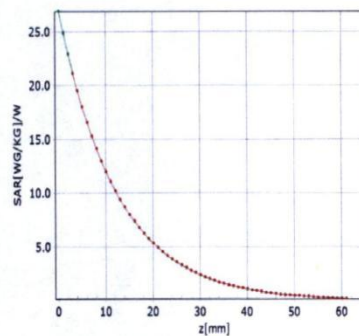
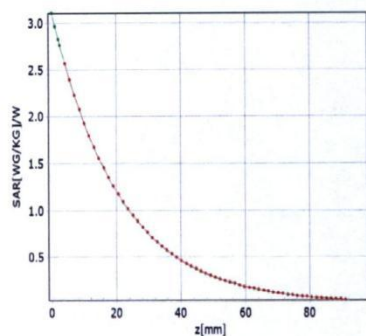

* analytical * measured

* analytical * measured

Deviation from Isotropy in Liquid

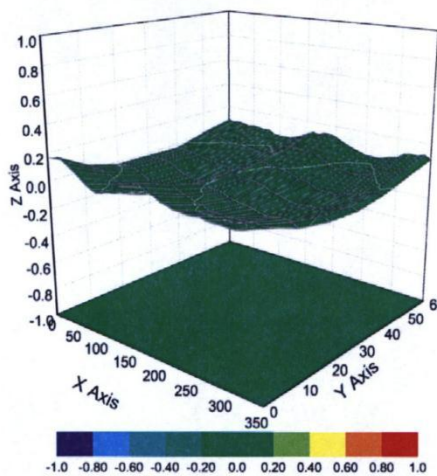

Uncertainty of Spherical Isotropy Assessment: $\pm 3.2\%$ ($k=2$)

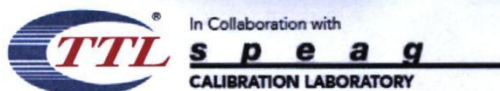

Add: No.52 HuaYuanBei Road, Haidian District, Beijing, 100191, China
Tel: +86-10-62304633-2117
E-mail: cttl@chinattl.com <http://www.caict.ac.cn>

DASY/EASY – Parameters of Probe: EX3DV4 – SN:3844

Other Probe Parameters

Sensor Arrangement	Triangular
Connector Angle (°)	25.7
Mechanical Surface Detection Mode	enabled
Optical Surface Detection Mode	disable
Probe Overall Length	337mm
Probe Body Diameter	10mm
Tip Length	9mm
Tip Diameter	2.5mm
Probe Tip to Sensor X Calibration Point	1mm
Probe Tip to Sensor Y Calibration Point	1mm
Probe Tip to Sensor Z Calibration Point	1mm
Recommended Measurement Distance from Surface	1.4mm



In Collaboration with
s p e a g
CALIBRATION LABORATORY



中国认可
国际互认
校准
CALIBRATION
CNAS L0570

Add: No.52 HuanYuanBei Road, Haidian District, Beijing, 100191, CI
Tel: +86-10-62304633-2079 Fax: +86-10-62304633-2504
E-mail: ctll@chinattl.com http://www.chinattl.cn

Client **CATR(Chongqing)**

Certificate No: **Z21-60146**

CALIBRATION CERTIFICATE			
Object	D750V3 - SN: 1037		
Calibration Procedure(s)	FF-Z11-003-01 Calibration Procedures for dipole validation kits		
Calibration date:	April 17, 2021		
<p>This calibration Certificate documents the traceability to national standards, which realize the physical units of measurements(SI). The measurements and the uncertainties with confidence probability are given on the following pages and are part of the certificate.</p> <p>All calibrations have been conducted in the closed laboratory facility: environment temperature(22±3)°C and humidity<70%.</p> <p>Calibration Equipment used (M&TE critical for calibration)</p>			
Primary Standards	ID #	Cal Date(Calibrated by, Certificate No.)	Scheduled Calibration
Power Meter NRP2	106276	12-May-20 (CTTL, No.J20X02965)	May-21
Power sensor NRP6A	101369	12-May-20 (CTTL, No.J20X02965)	May-21
Reference Probe EX3DV4	SN 7307	29-May-20(SPEAG,No.EX3-7307_May20)	May-21
DAE4	SN 777	08-Jan-21(CTTL-SPEAG,No.Z21-60003)	Jan-22
Secondary Standards	ID #	Cal Date(Calibrated by, Certificate No.)	Scheduled Calibration
Signal Generator E4438C	MY49071430	01-Feb-21 (CTTL, No.J21X00593)	Jan-22
NetworkAnalyzer E5071C	MY46103773	14-Jan-21 (CTTL, No.J21X00232)	Jan-22
Calibrated by:	Name Zhao Jing	Function SAR Test Engineer	Signature
Reviewed by:	Name Lin Hao	Function SAR Test Engineer	Signature
Approved by:	Name Qi Dianyuan	Function SAR Project Leader	Signature
Issued: April 21, 2021			
This calibration certificate shall not be reproduced except in full without written approval of the laboratory.			

Certificate No: Z21-60146

Page 1 of 6

Chongqing Academy of Information and Communication Technology

Address: No. 8,Yuma Road, Chayuan New City, Nan'an District, Chongqing, P. R. China,401336
Tel: 0086-23-88069965

FAX:0086-23-88608777



Add: No.52 HuanYuanBei Road, Haidian District, Beijing, 100191, China
Tel: +86-10-62304633-2079 Fax: +86-10-62304633-2504
E-mail: cttl@chinattl.com http://www.chinattl.cn

Glossary:

TSL	tissue simulating liquid
ConvF	sensitivity in TSL / NORM _{x,y,z}
N/A	not applicable or not measured

Calibration is Performed According to the Following Standards:

- IEEE Std 1528-2013, "IEEE Recommended Practice for Determining the Peak Spatial-Averaged Specific Absorption Rate (SAR) in the Human Head from Wireless Communications Devices: Measurement Techniques", June 2013
- IEC 62209-1, "Measurement procedure for assessment of specific absorption rate of human exposure to radio frequency fields from hand-held and body-mounted wireless communication devices- Part 1: Device used next to the ear (Frequency range of 300MHz to 6GHz)", July 2016
- IEC 62209-2, "Procedure to measure the Specific Absorption Rate (SAR) For wireless communication devices used in close proximity to the human body (frequency range of 30MHz to 6GHz)", March 2010
- KDB865664, SAR Measurement Requirements for 100 MHz to 6 GHz

Additional Documentation:

- DASY4/5 System Handbook

Methods Applied and Interpretation of Parameters:

- Measurement Conditions:** Further details are available from the Validation Report at the end of the certificate. All figures stated in the certificate are valid at the frequency indicated.
- Antenna Parameters with TSL:** The dipole is mounted with the spacer to position its feed point exactly below the center marking of the flat phantom section, with the arms oriented parallel to the body axis.
- Feed Point Impedance and Return Loss:** These parameters are measured with the dipole positioned under the liquid filled phantom. The impedance stated is transformed from the measurement at the SMA connector to the feed point. The Return Loss ensures low reflected power. No uncertainty required.
- Electrical Delay:** One-way delay between the SMA connector and the antenna feed point. No uncertainty required.
- SAR measured:** SAR measured at the stated antenna input power.
- SAR normalized:** SAR as measured, normalized to an input power of 1 W at the antenna connector.
- SAR for nominal TSL parameters:** The measured TSL parameters are used to calculate the nominal SAR result.

The reported uncertainty of measurement is stated as the standard uncertainty of Measurement multiplied by the coverage factor $k=2$, which for a normal distribution corresponds to a coverage probability of approximately 95%.



Add: No.52 HuanYuanBei Road, Haidian District, Beijing, 100191, China
 Tel: +86-10-62304633-2079 Fax: +86-10-62304633-2504
 E-mail: cttf@chinattl.com http://www.chinattl.cn

Measurement Conditions

DASY system configuration, as far as not given on page 1.

DASY Version	DASY52	V52.10.4
Extrapolation	Advanced Extrapolation	
Phantom	Triple Flat Phantom 5.1C	
Distance Dipole Center - TSL	15 mm	with Spacer
Zoom Scan Resolution	dx, dy, dz = 5 mm	
Frequency	750 MHz ± 1 MHz	

Head TSL parameters

The following parameters and calculations were applied.

	Temperature	Permittivity	Conductivity
Nominal Head TSL parameters	22.0 °C	42.0	0.90 mho/m
Measured Head TSL parameters	(22.0 ± 0.2) °C	42.0 ± 6 %	0.90 mho/m ± 6 %
Head TSL temperature change during test	<1.0 °C	----	----

SAR result with Head TSL

SAR averaged over 1 cm³ (1 g) of Head TSL	Condition	
SAR measured	250 mW input power	2.07 W/kg
SAR for nominal Head TSL parameters	normalized to 1W	8.24 W/kg ± 18.8 % (k=2)
SAR averaged over 10 cm³ (10 g) of Head TSL	Condition	
SAR measured	250 mW input power	1.37 W/kg
SAR for nominal Head TSL parameters	normalized to 1W	5.46 W/kg ± 18.7 % (k=2)



Add: No.52 HuanYuanBei Road, Haidian District, Beijing, 100191, China
Tel: +86-10-62304633-2079 Fax: +86-10-62304633-2504
E-mail: ettl@chinattl.com http://www.chinattl.cn

Appendix (Additional assessments outside the scope of CNAS L0570)

Antenna Parameters with Head TSL

Impedance, transformed to feed point	55.2Ω+ 1.58jΩ
Return Loss	- 25.8dB

General Antenna Parameters and Design

Electrical Delay (one direction)	0.941 ns
----------------------------------	----------

After long term use with 100W radiated power, only a slight warming of the dipole near the feedpoint can be measured.

The dipole is made of standard semirigid coaxial cable. The center conductor of the feeding line is directly connected to the second arm of the dipole. The antenna is therefore short-circuited for DC-signals. On some of the dipoles, small end caps are added to the dipole arms in order to improve matching when loaded according to the position as explained in the "Measurement Conditions" paragraph. The SAR data are not affected by this change. The overall dipole length is still according to the Standard.

No excessive force must be applied to the dipole arms, because they might bend or the soldered connections near the feedpoint may be damaged.

Additional EUT Data

Manufactured by	SPEAG
-----------------	-------



Add: No.52 HuanYuanBei Road, Haidian District, Beijing, 100191, China
 Tel: +86-10-62304633-2079 Fax: +86-10-62304633-2504
 E-mail: ctfl@chinattl.com http://www.chinattl.cn

DASY5 Validation Report for Head TSL

Date: 04.17.2021

Test Laboratory: CTTL, Beijing, China

DUT: Dipole 750 MHz; Type: D750V3; Serial: D750V3 - SN: 1037

Communication System: UID 0, CW; Frequency: 750 MHz; Duty Cycle: 1:1

Medium parameters used: $f = 750$ MHz; $\sigma = 0.896$ S/m; $\epsilon_r = 42.04$; $\rho = 1000$ kg/m³

Phantom section: Center Section

DASY5 Configuration:

- Probe: EX3DV4 - SN7307; ConvF(10.41, 10.41, 10.41) @ 750 MHz; Calibrated: 2020-05-29
- Sensor-Surface: 1.4mm (Mechanical Surface Detection)
- Electronics: DAE4 Sn777; Calibrated: 2021-01-08
- Phantom: MFP_V5.1C (20deg probe tilt); Type: QD 000 P51 Cx; Serial: 1062
- Measurement SW: DASY52, Version 52.10 (4); SEMCAD X Version 14.6.14 (7483)

Dipole Calibration/Zoom Scan (7x7x7) (7x7x7)/Cube 0: Measurement grid: dx=5mm, dy=5mm, dz=5mm

Reference Value = 54.83 V/m; Power Drift = -0.02 dB

Peak SAR (extrapolated) = 3.09 W/kg

SAR(1 g) = 2.07 W/kg; SAR(10 g) = 1.37 W/kg

Smallest distance from peaks to all points 3 dB below: Larger than measurement grid

Ratio of SAR at M2 to SAR at M1 = 67%

Maximum value of SAR (measured) = 2.74 W/kg

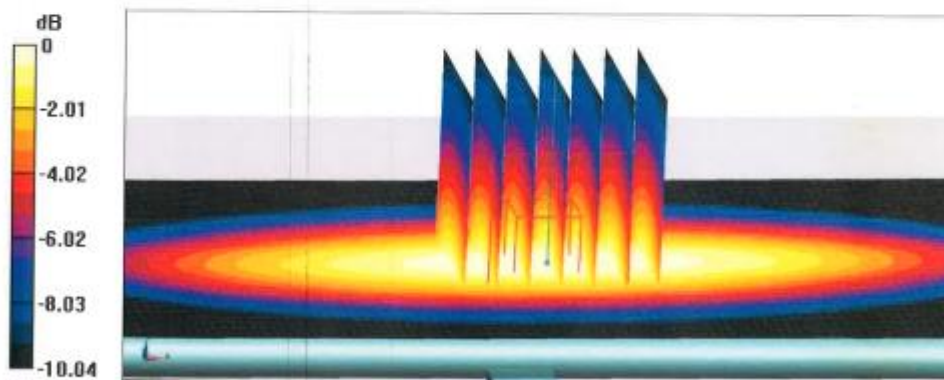

0 dB = 2.74 W/kg = 4.38 dBW/kg



Add: No.52 HuanYuanBei Road, Haidian District, Beijing, 100191, China
Tel: +86-10-62304633-2079 Fax: +86-10-62304633-2504
E-mail: cttl@chinattl.com http://www.chinattl.cn

Impedance Measurement Plot for Head TSL

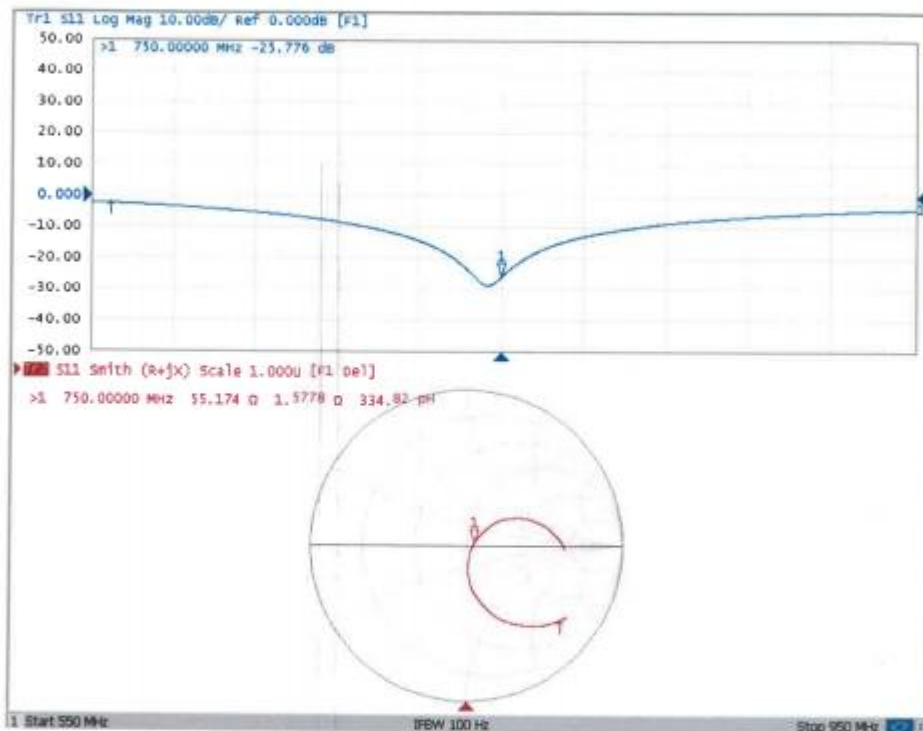



In Collaboration with
s p e a g
CALIBRATION LABORATORY



中国认可
国际互认
校准
CALIBRATION
CNAS L0570

Add: No.51 Xueyuan Road, Haidian District, Beijing, 100191, China
Tel: +86-10-62304633-2079 Fax: +86-10-62304633-2504
E-mail: cttl@chinattl.com http://www.chinattl.cn

Client **CATR(Chongqing)**

Certificate No: **Z20-60402**

CALIBRATION CERTIFICATE

Object: **D1750V2 - SN: 1063**

Calibration Procedure(s): **FF-Z11-003-01**
Calibration Procedures for dipole validation kits

Calibration date: **October 15, 2020**

This calibration Certificate documents the traceability to national standards, which realize the physical units of measurements(SI). The measurements and the uncertainties with confidence probability are given on the following pages and are part of the certificate.

All calibrations have been conducted in the closed laboratory facility: environment temperature(22±3)°C and humidity<70%.

Calibration Equipment used (M&TE critical for calibration)

Primary Standards	ID #	Cal Date(Calibrated by, Certificate No.)	Scheduled Calibration
Power Meter NRP2	106276	12-May-20 (CTTL, No.J20X02965)	May-21
Power sensor NRP6A	101369	12-May-20 (CTTL, No.J20X02965)	May-21
ReferenceProbe EX3DV4	SN 3617	30-Jan-20(SPEAG,No.EX3-3617_Jan20)	Jan-21
DAE4	SN 771	10-Feb-20(CTTL-SPEAG,No.Z20-60017)	Feb-21
Secondary Standards	ID #	Cal Date(Calibrated by, Certificate No.)	Scheduled Calibration
Signal Generator E4438C	MY49071430	25-Feb-20 (CTTL, No.J20X00516)	Feb-21
NetworkAnalyzer E5071C	MY46110673	10-Feb-20 (CTTL, No.J20X00515)	Feb-21

	Name	Function	Signature
Calibrated by:	Zhao Jing	SAR Test Engineer	
Reviewed by:	Lin Hao	SAR Test Engineer	
Approved by:	Qi Dianyuan	SAR Project Leader	

Issued: October 22, 2020

This calibration certificate shall not be reproduced except in full without written approval of the laboratory.



Add: No.51 Xueyuan Road, Haidian District, Beijing, 100191, China
Tel: +86-10-62304633-2079 Fax: +86-10-62304633-2504
E-mail: cttl@chinattl.com http://www.chinattl.cn

Glossary:

TSL	tissue simulating liquid
ConvF	sensitivity in TSL / NORM _{x,y,z}
N/A	not applicable or not measured

Calibration is Performed According to the Following Standards:

- IEEE Std 1528-2013, "IEEE Recommended Practice for Determining the Peak Spatial-Averaged Specific Absorption Rate (SAR) in the Human Head from Wireless Communications Devices: Measurement Techniques", June 2013
- IEC 62209-1, "Measurement procedure for assessment of specific absorption rate of human exposure to radio frequency fields from hand-held and body-mounted wireless communication devices- Part 1: Device used next to the ear (Frequency range of 300MHz to 6GHz)", July 2016
- IEC 62209-2, "Procedure to measure the Specific Absorption Rate (SAR) For wireless communication devices used in close proximity to the human body (frequency range of 30MHz to 6GHz)", March 2010
- KDB865664, SAR Measurement Requirements for 100 MHz to 6 GHz

Additional Documentation:

- DASY4/5 System Handbook

Methods Applied and Interpretation of Parameters:

- Measurement Conditions:* Further details are available from the Validation Report at the end of the certificate. All figures stated in the certificate are valid at the frequency indicated.
- Antenna Parameters with TSL:* The dipole is mounted with the spacer to position its feed point exactly below the center marking of the flat phantom section, with the arms oriented parallel to the body axis.
- Feed Point Impedance and Return Loss:* These parameters are measured with the dipole positioned under the liquid filled phantom. The impedance stated is transformed from the measurement at the SMA connector to the feed point. The Return Loss ensures low reflected power. No uncertainty required.
- Electrical Delay:* One-way delay between the SMA connector and the antenna feed point. No uncertainty required.
- SAR measured:* SAR measured at the stated antenna input power.
- SAR normalized:* SAR as measured, normalized to an input power of 1 W at the antenna connector.
- SAR for nominal TSL parameters:* The measured TSL parameters are used to calculate the nominal SAR result.

The reported uncertainty of measurement is stated as the standard uncertainty of Measurement multiplied by the coverage factor $k=2$, which for a normal distribution Corresponds to a coverage probability of approximately 95%.



In Collaboration with
s p e a g
CALIBRATION LABORATORY

Add: No.51 Xueyuan Road, Haidian District, Beijing, 100191, China
Tel: +86-10-62304633-2079 Fax: +86-10-62304633-2504
E-mail: cttl@chinattl.com http://www.chinattl.cn

Measurement Conditions

DASY system configuration, as far as not given on page 1.

DASY Version	DASY52	V52.10.4
Extrapolation	Advanced Extrapolation	
Phantom	Triple Flat Phantom 5.1C	
Distance Dipole Center - TSL	10 mm	with Spacer
Zoom Scan Resolution	dx, dy, dz = 5 mm	
Frequency	1750 MHz \pm 1 MHz	

Head TSL parameters

The following parameters and calculations were applied.

	Temperature	Permittivity	Conductivity
Nominal Head TSL parameters	22.0 °C	40.1	1.37 mho/m
Measured Head TSL parameters	(22.0 \pm 0.2) °C	39.6 \pm 6 %	1.37 mho/m \pm 6 %
Head TSL temperature change during test	<1.0 °C	----	----

SAR result with Head TSL

SAR averaged over 1 cm ³ (1 g) of Head TSL	Condition	
SAR measured	250 mW input power	8.96 W/kg
SAR for nominal Head TSL parameters	normalized to 1W	35.8 W/kg \pm 18.8 % (k=2)
SAR averaged over 10 cm ³ (10 g) of Head TSL	Condition	
SAR measured	250 mW input power	4.73 W/kg
SAR for nominal Head TSL parameters	normalized to 1W	18.9 W/kg \pm 18.7 % (k=2)

Body TSL parameters

The following parameters and calculations were applied.

	Temperature	Permittivity	Conductivity
Nominal Body TSL parameters	22.0 °C	53.4	1.49 mho/m
Measured Body TSL parameters	(22.0 \pm 0.2) °C	53.0 \pm 6 %	1.51 mho/m \pm 6 %
Body TSL temperature change during test	<1.0 °C	----	----

SAR result with Body TSL

SAR averaged over 1 cm ³ (1 g) of Body TSL	Condition	
SAR measured	250 mW input power	9.42 W/kg
SAR for nominal Body TSL parameters	normalized to 1W	37.3 W/kg \pm 18.8 % (k=2)
SAR averaged over 10 cm ³ (10 g) of Body TSL	Condition	
SAR measured	250 mW input power	5.05 W/kg
SAR for nominal Body TSL parameters	normalized to 1W	20.1 W/kg \pm 18.7 % (k=2)



Add: No.51 Xueyuan Road, Haidian District, Beijing, 100191, China
Tel: +86-10-62304633-2079 Fax: +86-10-62304633-2504
E-mail: cttl@chinattl.com http://www.chinattl.cn

Appendix (Additional assessments outside the scope of CNAS L0570)

Antenna Parameters with Head TSL

Impedance, transformed to feed point	49.4Ω- 0.99 jΩ
Return Loss	- 38.5 dB

Antenna Parameters with Body TSL

Impedance, transformed to feed point	46.0Ω- 0.80 jΩ
Return Loss	- 27.3 dB

General Antenna Parameters and Design

Electrical Delay (one direction)	1.087 ns
----------------------------------	----------

After long term use with 100W radiated power, only a slight warming of the dipole near the feedpoint can be measured.

The dipole is made of standard semirigid coaxial cable. The center conductor of the feeding line is directly connected to the second arm of the dipole. The antenna is therefore short-circuited for DC-signals. On some of the dipoles, small end caps are added to the dipole arms in order to improve matching when loaded according to the position as explained in the "Measurement Conditions" paragraph. The SAR data are not affected by this change. The overall dipole length is still according to the Standard. No excessive force must be applied to the dipole arms, because they might bend or the soldered connections near the feedpoint may be damaged.

Additional EUT Data

Manufactured by	SPEAG
-----------------	-------



Add: No.51 Xueyuan Road, Haidian District, Beijing, 100191, China
Tel: +86-10-62304633-2079 Fax: +86-10-62304633-2504
E-mail: cttl@chinattl.com http://www.chinattl.cn

DASY5 Validation Report for Head TSL

Date: 10.15.2020

Test Laboratory: CTTL, Beijing, China

DUT: Dipole 1750 MHz; Type: D1750V2; Serial: D1750V2 - SN: 1063

Communication System: UID 0, CW; Frequency: 1750 MHz; Duty Cycle: 1:1

Medium parameters used: $f = 1750$ MHz; $\sigma = 1.365$ S/m; $\epsilon_r = 39.61$; $\rho = 1000$ kg/m³

Phantom section: Right Section

DASY5 Configuration:

- Probe: EX3DV4 - SN3617; ConvF(8.41, 8.41, 8.41) @ 1750 MHz; Calibrated: 2020-01-30
- Sensor-Surface: 1.4mm (Mechanical Surface Detection)
- Electronics: DAE4 Sn771; Calibrated: 2020-02-10
- Phantom: MFP_V5.1C (20deg probe tilt); Type: QD 000 P51 Cx; Serial: 1062
- Measurement SW: DASY52, Version 52.10 (4); SEMCAD X Version 14.6.14 (7483)

System Performance Check/Zoom Scan (7x7x7) (7x7x7)/Cube 0: Measurement grid:

dx=5mm, dy=5mm, dz=5mm

Reference Value = 97.18 V/m; Power Drift = -0.03 dB

Peak SAR (extrapolated) = 16.8 W/kg

SAR(1 g) = 8.96 W/kg; SAR(10 g) = 4.73 W/kg

Smallest distance from peaks to all points 3 dB below = 10 mm

Ratio of SAR at M2 to SAR at M1 = 53.8%

Maximum value of SAR (measured) = 14.0 W/kg

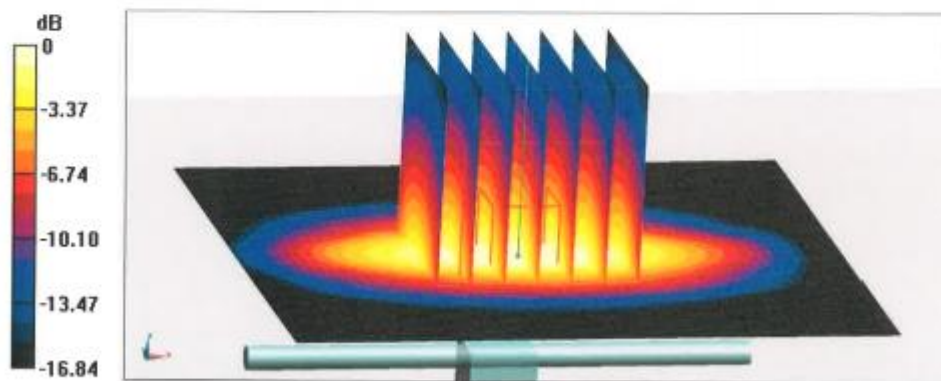
**0 dB = 14.0 W/kg = 11.46 dBW/kg**



Add: No.51 Xueyuan Road, Haidian District, Beijing, 100191, China
Tel: +86-10-62304633-2079 Fax: +86-10-62304633-2504
E-mail: cttl@chinattl.com http://www.chinattl.cn

Impedance Measurement Plot for Head TSL

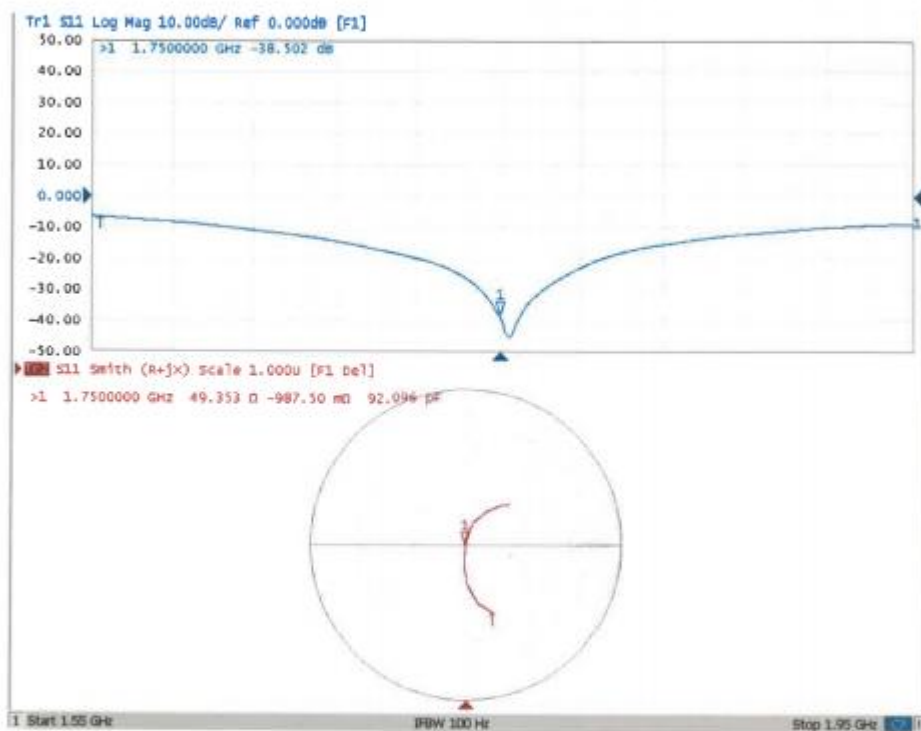



Add: No.51 Xueyuan Road, Haidian District, Beijing, 100191, China
Tel: +86-10-62304633-2079 Fax: +86-10-62304633-2504
E-mail: ctntl@chinattl.com http://www.chinattl.cn

DASY5 Validation Report for Body TSL

Date: 10.15.2020

Test Laboratory: CTTL, Beijing, China

DUT: Dipole 1750 MHz; Type: D1750V2; Serial: D1750V2 - SN: 1063

Communication System: UID 0, CW; Frequency: 1750 MHz; Duty Cycle: 1:1

Medium parameters used: $f = 1750$ MHz; $\sigma = 1.51$ S/m; $\epsilon_r = 53$; $\rho = 1000$ kg/m³

Phantom section: Right Section

DASY5 Configuration:

- Probe: EX3DV4 - SN3617; ConvF(8.09, 8.09, 8.09) @ 1750 MHz; Calibrated: 2020-01-30
- Sensor-Surface: 1.4mm (Mechanical Surface Detection)
- Electronics: DAE4 Sn771; Calibrated: 2020-02-10
- Phantom: MFP_V5.1C (20deg probe tilt); Type: QD 000 P51 Cx; Serial: 1062
- Measurement SW: DASY52, Version 52.10 (4); SEMCAD X Version 14.6.14 (7483)

System Performance Check/Zoom Scan (7x7x7) (7x7x7)/Cube 0: Measurement grid:

dx=5mm, dy=5mm, dz=5mm

Reference Value = 95.36 V/m; Power Drift = -0.01 dB

Peak SAR (extrapolated) = 16.5 W/kg

SAR(1 g) = 9.42 W/kg; SAR(10 g) = 5.05 W/kg

Smallest distance from peaks to all points 3 dB below = 9.2 mm

Ratio of SAR at M2 to SAR at M1 = 58.1%

Maximum value of SAR (measured) = 14.1 W/kg

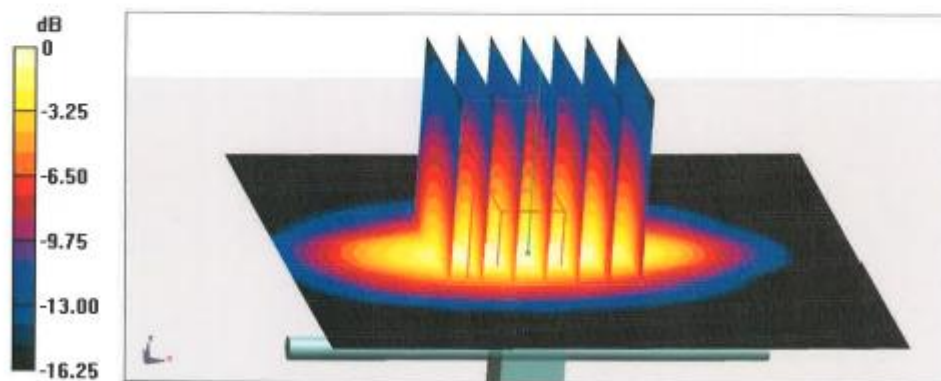
**0 dB = 14.1 W/kg = 11.49 dBW/kg**



Add: No.51 Xueyuan Road, Haidian District, Beijing, 100191, China
Tel: +86-10-62304633-2079 Fax: +86-10-62304633-2504
E-mail: cttl@chinattl.com http://www.chinattl.cn

Impedance Measurement Plot for Body TSL

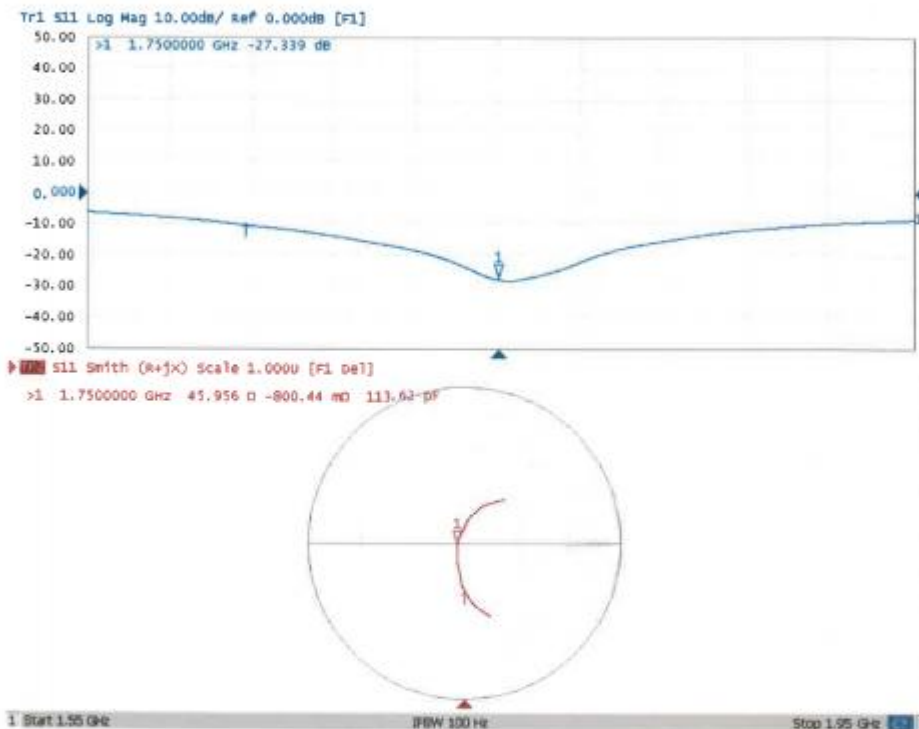



In Collaboration with
s p e a g
CALIBRATION LABORATORY



中国认可
国际互认
校准
CALIBRATION
CNAS L0570

Add: No.51 Xueyuan Road, Haidian District, Beijing, 100191, China
Tel: +86-10-62304633-2079 Fax: +86-10-62304633-2504
E-mail: ctll@chinattl.com http://www.chinattl.cn

Client **CATR(Chongqing)**

Certificate No: **Z20-60403**

CALIBRATION CERTIFICATE

Object **D1900V2 - SN: 5d153**
Calibration Procedure(s) **FF-Z11-003-01**
Calibration Procedures for dipole validation kits
Calibration date: **October 14, 2020**

This calibration Certificate documents the traceability to national standards, which realize the physical units of measurements(SI). The measurements and the uncertainties with confidence probability are given on the following pages and are part of the certificate.

All calibrations have been conducted in the closed laboratory facility: environment temperature(22±3)°C and humidity<70%.

Calibration Equipment used (M&TE critical for calibration)

Primary Standards	ID #	Cal Date(Calibrated by, Certificate No.)	Scheduled Calibration
Power Meter NRP2	106276	12-May-20 (CTTL, No.J20X02965)	May-21
Power sensor NRP6A	101369	12-May-20 (CTTL, No.J20X02965)	May-21
ReferenceProbe EX3DV4	SN 3617	30-Jan-20(SPEAG,No.EX3-3617_Jan20)	Jan-21
DAE4	SN 771	10-Feb-20(CTTL-SPEAG,No.Z20-60017)	Feb-21
Secondary Standards	ID #	Cal Date(Calibrated by, Certificate No.)	Scheduled Calibration
Signal Generator E4438C	MY49071430	25-Feb-20 (CTTL, No.J20X00516)	Feb-21
NetworkAnalyzer E5071C	MY46110673	10-Feb-20 (CTTL, No.J20X00515)	Feb-21

	Name	Function	Signature
Calibrated by:	Zhao Jing	SAR Test Engineer	
Reviewed by:	Lin Hao	SAR Test Engineer	
Approved by:	Qi Dianyuan	SAR Project Leader	

Issued: October 22, 2020

This calibration certificate shall not be reproduced except in full without written approval of the laboratory.



Add: No.51 Xueyuan Road, Haidian District, Beijing, 100191, China
Tel: +86-10-62304633-2079 Fax: +86-10-62304633-2504
E-mail: cttf@chinattl.com http://www.chinattl.cn

Glossary:

TSL	tissue simulating liquid
ConvF	sensitivity in TSL / NORM _{x,y,z}
N/A	not applicable or not measured

Calibration is Performed According to the Following Standards:

- IEEE Std 1528-2013, "IEEE Recommended Practice for Determining the Peak Spatial-Averaged Specific Absorption Rate (SAR) in the Human Head from Wireless Communications Devices: Measurement Techniques", June 2013
- IEC 62209-1, "Measurement procedure for assessment of specific absorption rate of human exposure to radio frequency fields from hand-held and body-mounted wireless communication devices- Part 1: Device used next to the ear (Frequency range of 300MHz to 6GHz)", July 2016
- IEC 62209-2, "Procedure to measure the Specific Absorption Rate (SAR) For wireless communication devices used in close proximity to the human body (frequency range of 30MHz to 6GHz)", March 2010
- KDB865664, SAR Measurement Requirements for 100 MHz to 6 GHz

Additional Documentation:

- DASY4/5 System Handbook

Methods Applied and Interpretation of Parameters:

- Measurement Conditions:** Further details are available from the Validation Report at the end of the certificate. All figures stated in the certificate are valid at the frequency indicated.
- Antenna Parameters with TSL:** The dipole is mounted with the spacer to position its feed point exactly below the center marking of the flat phantom section, with the arms oriented parallel to the body axis.
- Feed Point Impedance and Return Loss:** These parameters are measured with the dipole positioned under the liquid filled phantom. The impedance stated is transformed from the measurement at the SMA connector to the feed point. The Return Loss ensures low reflected power. No uncertainty required.
- Electrical Delay:** One-way delay between the SMA connector and the antenna feed point. No uncertainty required.
- SAR measured:** SAR measured at the stated antenna input power.
- SAR normalized:** SAR as measured, normalized to an input power of 1 W at the antenna connector.
- SAR for nominal TSL parameters:** The measured TSL parameters are used to calculate the nominal SAR result.

The reported uncertainty of measurement is stated as the standard uncertainty of Measurement multiplied by the coverage factor $k=2$, which for a normal distribution Corresponds to a coverage probability of approximately 95%.



Add: No.51 Xueyuan Road, Haidian District, Beijing, 100191, China
 Tel: +86-10-62304633-2079 Fax: +86-10-62304633-2504
 E-mail: cttl@chinattl.com http://www.chinattl.cn

Measurement Conditions

DASY system configuration, as far as not given on page 1.

DASY Version	DASY52	V52.10.4
Extrapolation	Advanced Extrapolation	
Phantom	Triple Flat Phantom 5.1C	
Distance Dipole Center - TSL	10 mm	with Spacer
Zoom Scan Resolution	dx, dy, dz = 5 mm	
Frequency	1900 MHz ± 1 MHz	

Head TSL parameters

The following parameters and calculations were applied.

	Temperature	Permittivity	Conductivity
Nominal Head TSL parameters	22.0 °C	40.0	1.40 mho/m
Measured Head TSL parameters	(22.0 ± 0.2) °C	39.0 ± 6 %	1.38 mho/m ± 6 %
Head TSL temperature change during test	<1.0 °C	----	----

SAR result with Head TSL

SAR averaged over 1 cm ³ (1 g) of Head TSL	Condition	
SAR measured	250 mW input power	9.78 W/kg
SAR for nominal Head TSL parameters	normalized to 1W	39.2 W/kg ± 18.8 % (k=2)
SAR averaged over 10 cm ³ (10 g) of Head TSL	Condition	
SAR measured	250 mW input power	5.04 W/kg
SAR for nominal Head TSL parameters	normalized to 1W	20.2 W/kg ± 18.7 % (k=2)

Body TSL parameters

The following parameters and calculations were applied.

	Temperature	Permittivity	Conductivity
Nominal Body TSL parameters	22.0 °C	53.3	1.52 mho/m
Measured Body TSL parameters	(22.0 ± 0.2) °C	53.1 ± 6 %	1.51 mho/m ± 6 %
Body TSL temperature change during test	<1.0 °C	----	----

SAR result with Body TSL

SAR averaged over 1 cm ³ (1 g) of Body TSL	Condition	
SAR measured	250 mW input power	9.89 W/kg
SAR for nominal Body TSL parameters	normalized to 1W	39.7 W/kg ± 18.8 % (k=2)
SAR averaged over 10 cm ³ (10 g) of Body TSL	Condition	
SAR measured	250 mW input power	5.15 W/kg
SAR for nominal Body TSL parameters	normalized to 1W	20.6 W/kg ± 18.7 % (k=2)



Add: No.51 Xueyuan Road, Haidian District, Beijing, 100191, China
Tel: +86-10-62304633-2079 Fax: +86-10-62304633-2504
E-mail: cttl@chinattl.com http://www.chinattl.cn

Appendix (Additional assessments outside the scope of CNAS L0570)

Antenna Parameters with Head TSL

Impedance, transformed to feed point	51.7Ω+ 5.15jΩ
Return Loss	- 25.5dB

Antenna Parameters with Body TSL

Impedance, transformed to feed point	48.8Ω+ 5.42jΩ
Return Loss	- 25.0dB

General Antenna Parameters and Design

Electrical Delay (one direction)	1.065 ns
----------------------------------	----------

After long term use with 100W radiated power, only a slight warming of the dipole near the feedpoint can be measured.

The dipole is made of standard semirigid coaxial cable. The center conductor of the feeding line is directly connected to the second arm of the dipole. The antenna is therefore short-circuited for DC-signals. On some of the dipoles, small end caps are added to the dipole arms in order to improve matching when loaded according to the position as explained in the "Measurement Conditions" paragraph. The SAR data are not affected by this change. The overall dipole length is still according to the Standard. No excessive force must be applied to the dipole arms, because they might bend or the soldered connections near the feedpoint may be damaged.

Additional EUT Data

Manufactured by	SPEAG
-----------------	-------



Add: No.51 Xueyuan Road, Haidian District, Beijing, 100191, China
 Tel: +86-10-62304633-2079 Fax: +86-10-62304633-2504
 E-mail: cttl@chinattl.com http://www.chinattl.cn

DASY5 Validation Report for Head TSL

Date: 10.14.2020

Test Laboratory: CTTL, Beijing, China

DUT: Dipole 1900 MHz; Type: D1900V2; Serial: D1900V2 - SN: 5d153

Communication System: UID 0, CW; Frequency: 1900 MHz; Duty Cycle: 1:1

Medium parameters used: $f = 1900$ MHz; $\sigma = 1.383$ S/m; $\epsilon_r = 38.95$; $\rho = 1000$ kg/m³

Phantom section: Center Section

DASY5 Configuration:

- Probe: EX3DV4 - SN3617; ConvF(8.14, 8.14, 8.14) @ 1900 MHz; Calibrated: 2020-01-30
- Sensor-Surface: 1.4mm (Mechanical Surface Detection)
- Electronics: DAE4 Sn771; Calibrated: 2020-02-10
- Phantom: MFP_V5.1C (20deg probe tilt); Type: QD 000 P51 Cx; Serial: 1062
- Measurement SW: DASY52, Version 52.10 (4); SEMCAD X Version 14.6.14 (7483)

System Performance Check/Zoom Scan (7x7x7) (7x7x7)/Cube 0: Measurement grid:

$dx=5$ mm, $dy=5$ mm, $dz=5$ mm

Reference Value = 102.3 V/m; Power Drift = -0.02 dB

Peak SAR (extrapolated) = 18.7 W/kg

SAR(1 g) = 9.78 W/kg; SAR(10 g) = 5.04 W/kg

Smallest distance from peaks to all points 3 dB below = 9.5 mm

Ratio of SAR at M2 to SAR at M1 = 52.7%

Maximum value of SAR (measured) = 15.5 W/kg

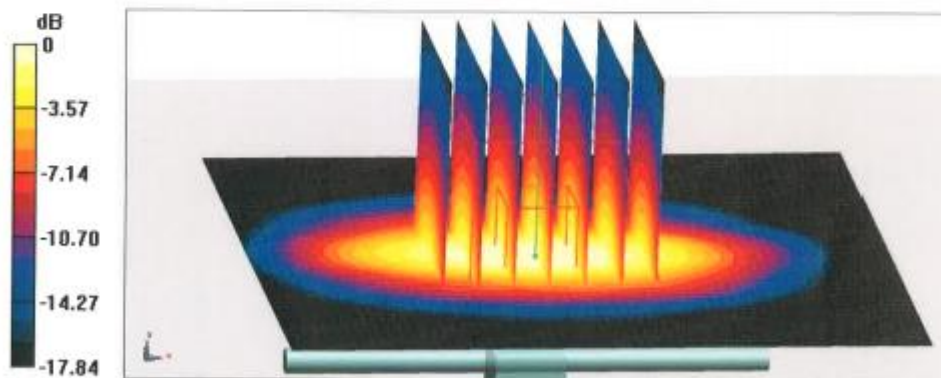

0 dB = 15.5 W/kg = 11.90 dBW/kg



Add: No.51 Xueyuan Road, Haidian District, Beijing, 100191, China
Tel: +86-10-62304633-2079 Fax: +86-10-62304633-2504
E-mail: cttl@chinattl.com http://www.chinattl.cn

Impedance Measurement Plot for Head TSL

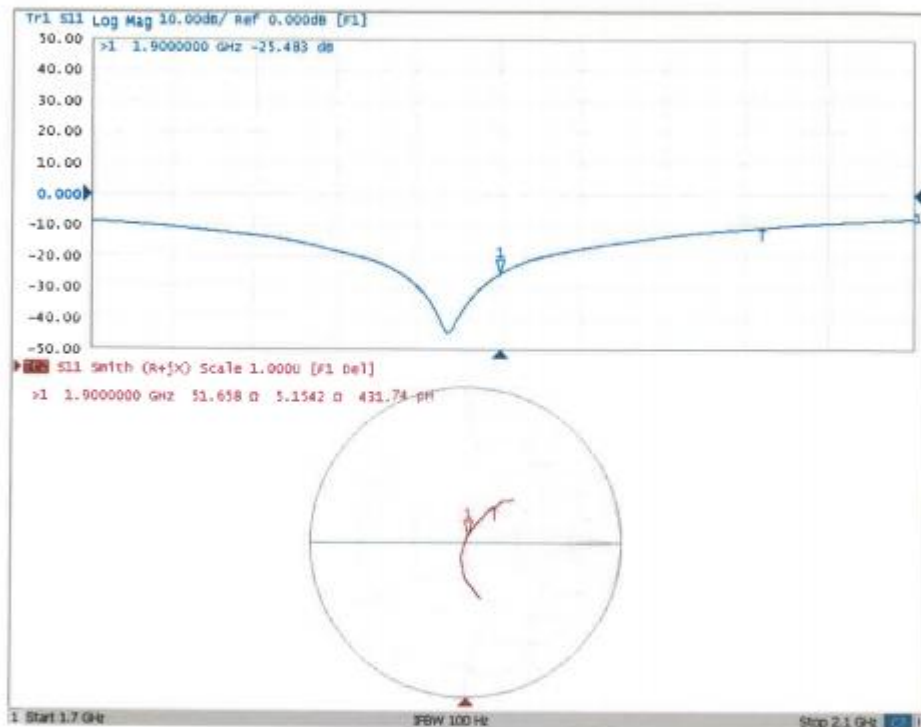



Add: No.51 Xueyuan Road, Haidian District, Beijing, 100191, China
Tel: +86-10-62304633-2079 Fax: +86-10-62304633-2504
E-mail: cttl@chinattl.com http://www.chinattl.cn

DASY5 Validation Report for Body TSL

Date: 10.14.2020

Test Laboratory: CTTL, Beijing, China

DUT: Dipole 1900 MHz; Type: D1900V2; Serial: D1900V2 - SN: 5d153

Communication System: UID 0, CW; Frequency: 1900 MHz; Duty Cycle: 1:1

Medium parameters used: $f = 1900$ MHz; $\sigma = 1.511$ S/m; $\epsilon_r = 53.06$; $\rho = 1000$ kg/m³

Phantom section: Center Section

DASY5 Configuration:

- Probe: EX3DV4 - SN3617; ConvF(7.94, 7.94, 7.94) @ 1900 MHz; Calibrated: 2020-01-30
- Sensor-Surface: 1.4mm (Mechanical Surface Detection)
- Electronics: DAE4 Sn771; Calibrated: 2020-02-10
- Phantom: MFP_V5.1C (20deg probe tilt); Type: QD 000 P51 Cx; Serial: 1062
- Measurement SW: DASY52, Version 52.10 (4); SEMCAD X Version 14.6.14 (7483)

System Performance Check/Zoom Scan (7x7x7) (7x7x7)/Cube 0: Measurement grid:

dx=5mm, dy=5mm, dz=5mm

Reference Value = 97.93 V/m; Power Drift = -0.02 dB

Peak SAR (extrapolated) = 18.2 W/kg

SAR(1 g) = 9.89 W/kg; SAR(10 g) = 5.15 W/kg

Smallest distance from peaks to all points 3 dB below = 9 mm

Ratio of SAR at M2 to SAR at M1 = 55.4%

Maximum value of SAR (measured) = 15.3 W/kg

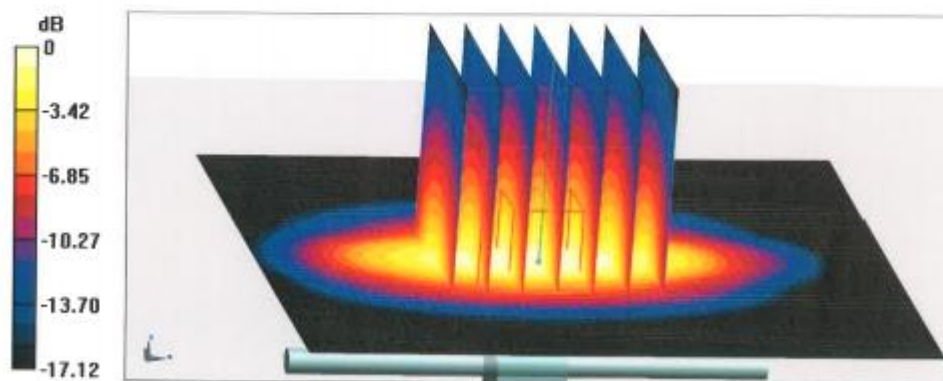

0 dB = 15.3 W/kg = 11.85 dBW/kg



Add: No.51 Xueyuan Road, Haidian District, Beijing, 100191, China
Tel: +86-10-62304633-2079 Fax: +86-10-62304633-2504
E-mail: cttl@chinattl.com http://www.chinattl.cn

Impedance Measurement Plot for Body TSL

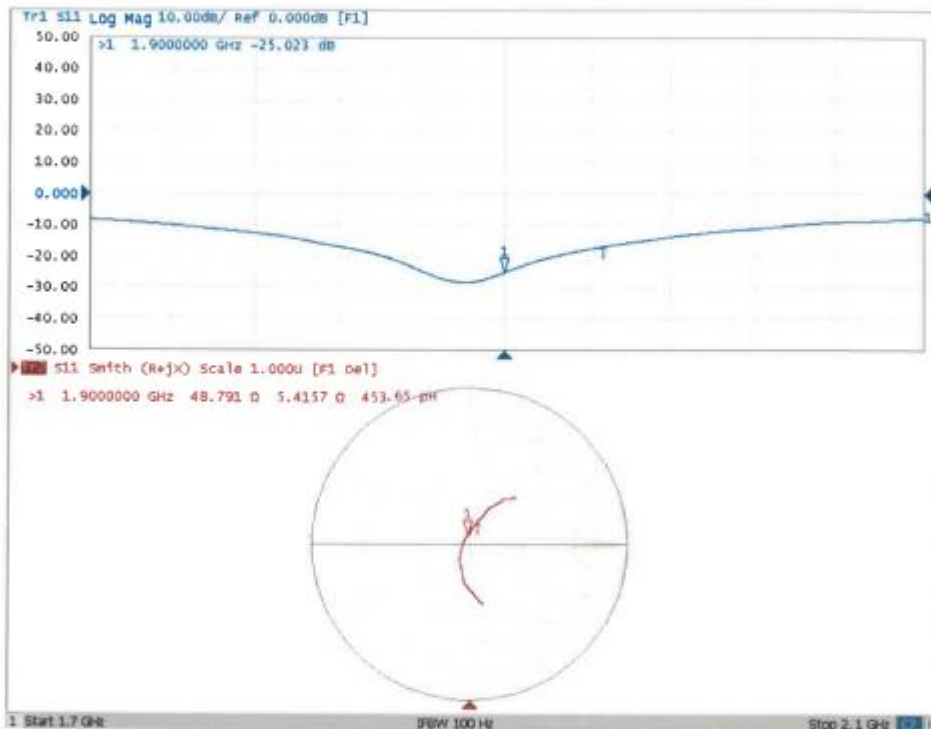

ANNEX D. Extended Calibration SAR Dipole

Referring to KDB865664 D01, if dipoles are verified in return loss ($< -20\text{dBm}$, within 20% of prior calibration), and in impedance (within 5 ohm of prior calibration), the annual calibration is not necessary and the calibration interval can be extended.

Justification of Extended Calibration SAR Dipole D750V3– serial no.1037

Head						
Date of Measurement	Return-Loss (dB)	Delta (%)	Real Impedance (ohm)	Delta (ohm)	Imaginary Impedance (johm)	Delta (johm)
2021-4-17	-25.78	\	55.2	\	1.6	\
2022-5-14	-24.46	5.12	56.1	0.9	-1.8	-3.4

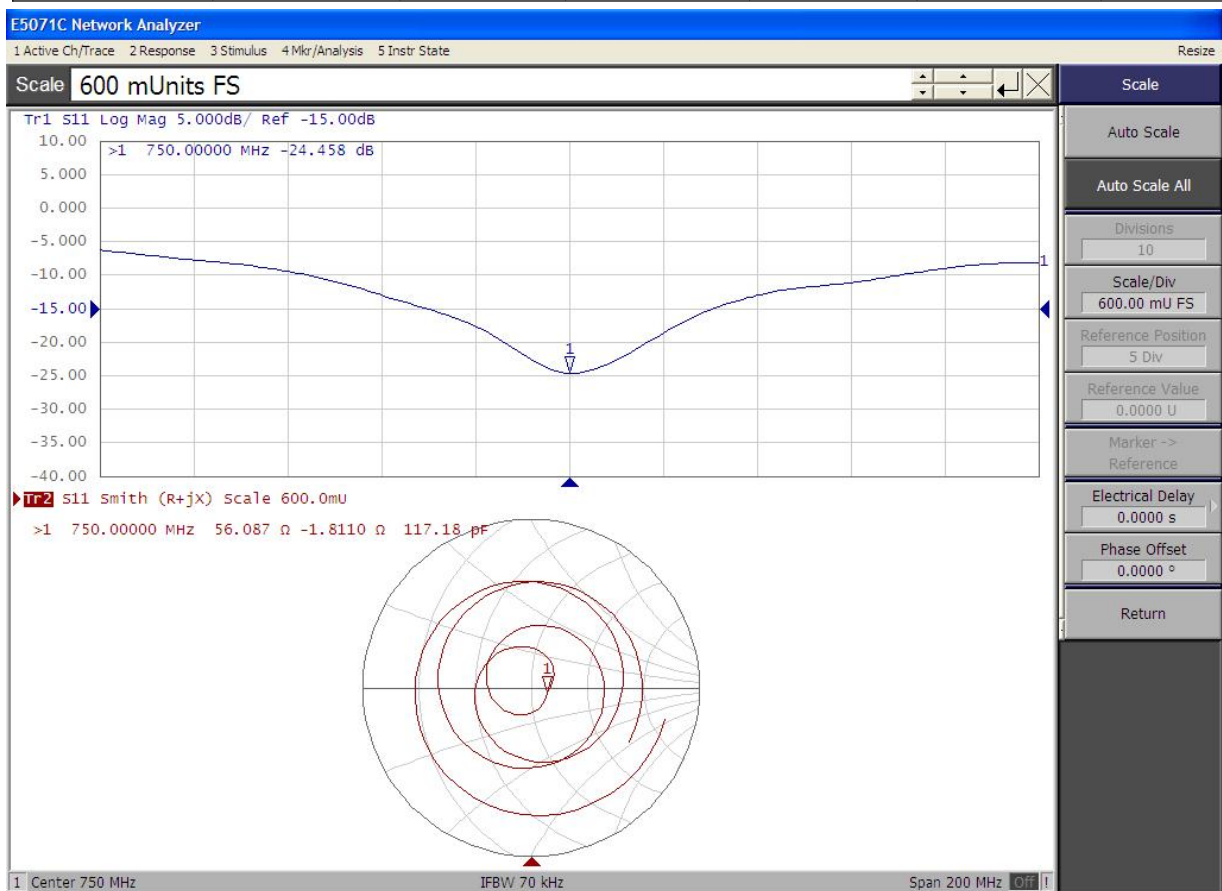

Justification of Extended Calibration SAR Dipole D1750V2– serial no.1063

Head						
Date of Measurement	Return-Loss (dB)	Delta (%)	Real Impedance (ohm)	Delta (ohm)	Imaginary Impedance (johm)	Delta (johm)
2020-10-15	-38.50	\	49.4	\	-1.0	\
2021-5-14	-36.31	5.69	49.4	0	-1.4	-0.4
2022-5-13	-39.14	7.79	51.00	1.6	0.50	1.9

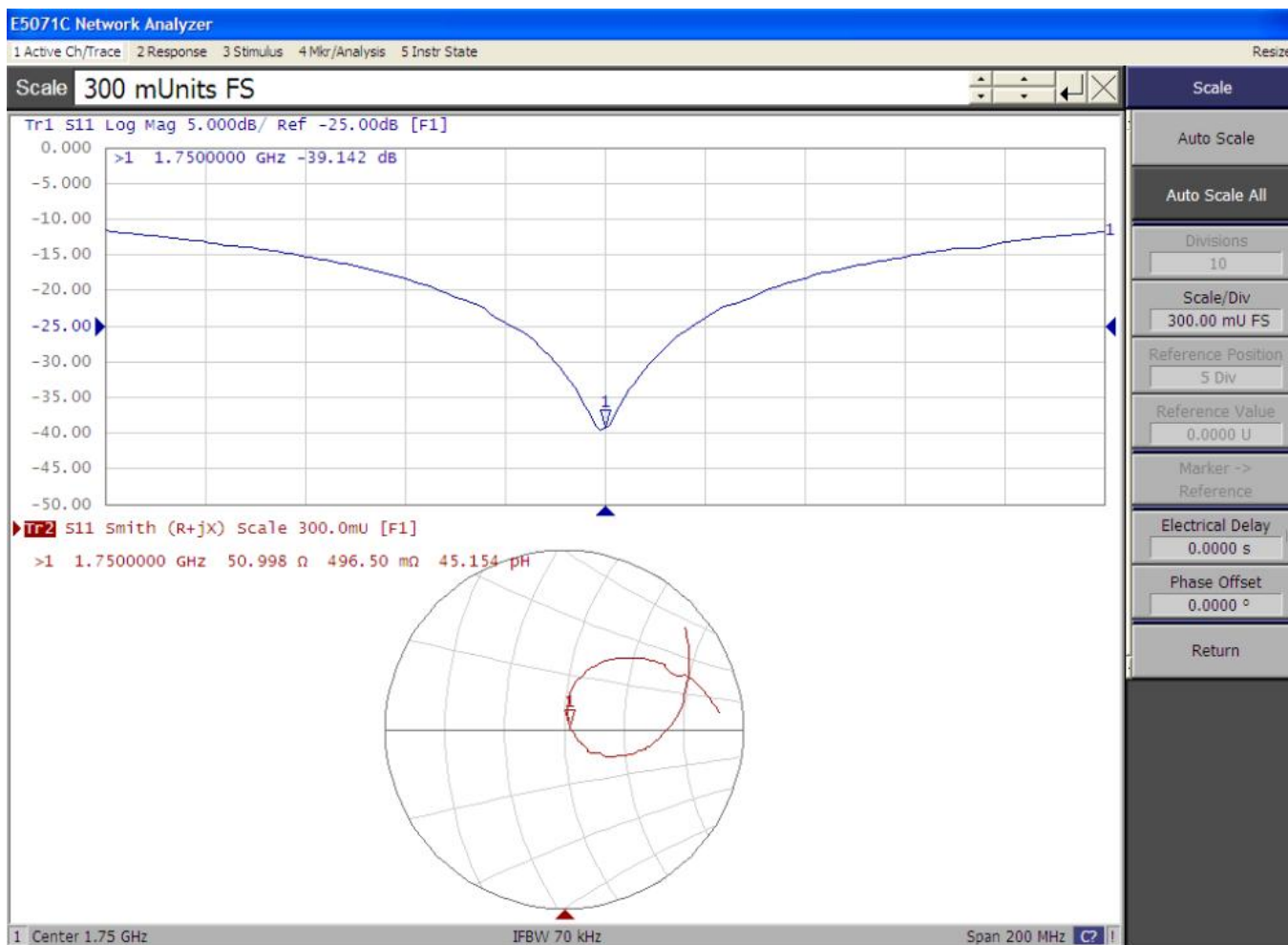

Justification of Extended Calibration SAR Dipole D1900V2– serial no.5d153

Head						
Date of Measurement	Return-Loss (dB)	Delta (%)	Real Impedance (ohm)	Delta (ohm)	Imaginary Impedance (johm)	Delta (johm)
2020-10-14	-25.48	\	51.7	\	5.2	\
2021-5-14	-26.59	4.36	54.8	3.1	1.1	-4.1
2022-5-13	-26.19	1.50	54.06	-0.74	-3.09	-4.19

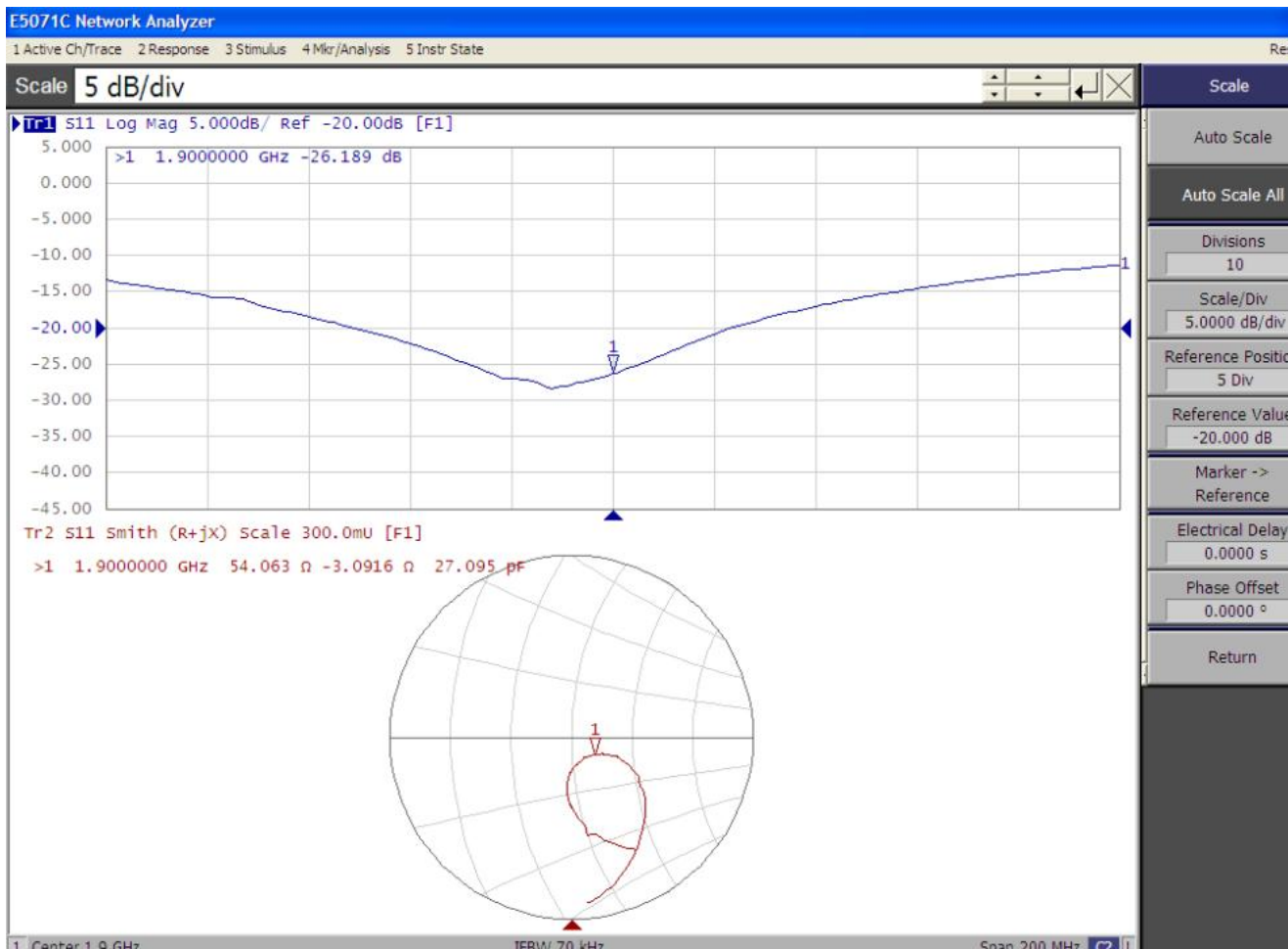

Chongqing Academy of Information and Communication Technology

Address: No. 8, Yuma Road, Chayuan New City, Nan'an District, Chongqing, P. R. China, 401336
 Tel: 0086-23-88069965

FAX: 0086-23-88608777

ANNEX E. Accreditation Certificate



Accredited Laboratory

A2LA has accredited

CHONGQING ACADEMY OF INFORMATION AND COMMUNICATIONS TECHNOLOGY

Chongqing, People's Republic of China

for technical competence in the field of

Electrical Testing

This laboratory is accredited in accordance with the recognized International Standard ISO/IEC 17025:2017 General requirements for the competence of testing and calibration laboratories. This laboratory also meets the requirements of any additional program requirements in the Electrical field.

This accreditation demonstrates technical competence for a defined scope and the operation of a laboratory quality management system

(refer to joint ISO-ILAC-IAF Communiqué dated April 2017).

Presented this 20th day of July 2022

Mr. Trace McInturff, Vice President, Accreditation Services

For the Accreditation Council

Certificate Number 4897-01

Valid to May 31, 2024

For the tests or types of tests to which this accreditation applies, please refer to the laboratory's Electrical Scope of Accreditation.

Chongqing Academy of Information and Communication Technology

Address: No. 8, Yuma Road, Chayuan New City, Nan'an District, Chongqing, P. R. China, 401336

Tel: 0086-23-88069965

FAX: 0086-23-88608777