

RF TEST REPORT



Report No.: 16050010-FCC-R

Supersede Report No.: N/A

Applicant	Micron Electronics LLC.	
Product Name	Tracker	
Model No.	Prime mPERs X	
Serial No.	N/A	
Test Standard	FCC Part 22(H):2015; FCC Part 24(E): 2015; ANSI/TIA C603D: 2010	
Test Date	February 26 to March 10 , 2016	
Issue Date	March 11, 2016	
Test Result	<input checked="" type="checkbox"/> Pass <input type="checkbox"/> Fail	
Equipment complied with the specification	<input checked="" type="checkbox"/>	
Equipment did not comply with the specification	<input type="checkbox"/>	
<i>Winnie Zhang</i>	<i>David Huang</i>	
Winnie Zhang Test Engineer	David Huang Checked By	
This test report may be reproduced in full only Test result presented in this test report is applicable to the tested sample only		

Issued by:

SIEMIC (SHENZHEN-CHINA) LABORATORIES

Zone A, Floor 1, Building 2 Wan Ye Long Technology Park

South Side of Zhoushi Road, Bao' an District, Shenzhen, Guangdong China 518108

Phone: +86 0755 2601 4629801 Email: China@siemic.com.cn

Laboratories Introduction

SIEMIC, headquartered in the heart of Silicon Valley, with superior facilities in US and Asia, is one of the leading independent testing and certification facilities providing customers with one-stop shop services for Compliance Testing and Global Certifications.



In addition to testing and certification, SIEMIC provides initial design reviews and compliance management throughout a project. Our extensive experience with China, Asia Pacific, North America, European, and International compliance requirements, assures the fastest, most cost effective way to attain regulatory compliance for the global markets.

Accreditations for Conformity Assessment

Country/Region	Scope
USA	EMC, RF/Wireless, SAR, Telecom
Canada	EMC, RF/Wireless, SAR, Telecom
Taiwan	EMC, RF, Telecom, SAR, Safety
Hong Kong	RF/Wireless, SAR, Telecom
Australia	EMC, RF, Telecom, SAR, Safety
Korea	EMI, EMS, RF, SAR, Telecom, Safety
Japan	EMI, RF/Wireless, SAR, Telecom
Singapore	EMC, RF, SAR, Telecom
Europe	EMC, RF, SAR, Telecom, Safety

Test Report	16050010-FCC-R
Page	3 of 41

This page has been left blank intentionally.

CONTENTS

1. REPORT REVISION HISTORY	5
2. CUSTOMER INFORMATION	5
3. TEST SITE INFORMATION	5
4. EQUIPMENT UNDER TEST (EUT) INFORMATION	6
5. TEST SUMMARY	8
6. MEASUREMENTS, EXAMINATION AND DERIVED RESULTS	9
6.1 MAXIMUM PERMISSIBLE EXPOSURE (MPE).....	9
6.2 RF OUTPUT POWER	10
6.3 PEAK-AVERAGE RATIO	13
6.4 OCCUPIED BANDWIDTH	15
6.6 SPURIOUS EMISSIONS AT ANTENNA TERMINALS	18
6.7 SPURIOUS RADIATED EMISSIONS	21
6.8 BAND EDGE.....	25
6.9 FREQUENCY STABILITY	28
ANNEX A. TEST INSTRUMENT.....	31
ANNEX B. EUT AND TEST SETUP PHOTOGRAPHS.....	32
ANNEX C. TEST SETUP AND SUPPORTING EQUIPMENT.....	37
ANNEX C.II. EUT OPERATING CONKITIONS	39
ANNEX D. USER MANUAL / BLOCK DIAGRAM / SCHEMATICS / PARTLIST	40
ANNEX E. DECLARATION OF SIMILARITY	41

1. Report Revision History

Report No.	Report Version	Description	Issue Date
16050010-FCC-R	NONE	Original	March 11, 2016

2. Customer information

Applicant Name	Micron Electronics LLC.
Applicant Add	1001 Yamato Road, Suite 400, Boca Raton, FL 33431, USA
Manufacturer	Micron Electronics LLC.
Manufacturer Add	1001 Yamato Road, Suite 400, Boca Raton, FL 33431, USA

3. Test site information

Lab performing tests	SIEMIC (Shenzhen-China) LABORATORIES
Lab Address	Zone A, Floor 1, Building 2 Wan Ye Long Technology Park South Side of Zhoushi Road, Bao' an District, Shenzhen, Guangdong China 518108
FCC Test Site No.	718246
IC Test Site No.	4842E-1
Test Software	Radiated Emission Program-To Shenzhen v2.0

4. Equipment under Test (EUT) Information

Description of EUT:	Tracker
Main Model:	Prime mPERs X
Serial Model:	N/A
Date EUT received:	February 25 , 2016
Test Date(s):	February 26 to March 10 , 2016
Equipment Category :	PCB
Antenna Gain:	Cellular CDMA:0dBi PCS CDMA:1.8dBi
Type of Modulation:	CDMA: QPSK
RF Operating Frequency (ies):	Cellular CDMA TX: 824.7 ~ 848.37 MHz; RX: 869.7 ~ 893.37 MHz PCS CDMA TX: 1851.25 ~ 1908.75 MHz; RX: 1931.25 ~ 1988.75 MHz
Maximum Conducted AV Power to Antenna:	Cellular CDMA: 24.09 dBm PCS CDMA: 23.05 dBm
ERP/EIRP:	Cellular CDMA: 21.74 dBm / ERP PCS CDMA: 24.50 dBm / EIRP
Port:	USB Port

Test Report	16050010-FCC-R
Page	7 of 41

Input Power: Adapter:
Model:K05100-3
Input: AC 100-240V; 50/60Hz;0.3A
Output: DC 5.0V,1000mA
Battery:
Model:PA23W
Capacity: 3.8V,400mAh,1.52Wh
Charge Voltage:4.35V

Trade Name : Prime

FCC ID: ZKQ-PMAX

5. Test Summary

The product was tested in accordance with the following specifications.

All testing has been performed according to below product classification:

FCC Rules	Description of Test	Result
§ 1.1307; § 2.1093	RF Exposure (SAR)	Compliance
§2.1046; § 22.913(a); § 24.232(c);	RF Output Power	Compliance
§ 24.232 (d) ;	Peak-Average Ratio	Compliance
§ 2.1049; § 22.905; § 22.917; § 24.238;	99% & -26 dB Occupied Bandwidth	Compliance
§ 2.1051; § 22.917(a); § 24.238(a);	Spurious Emissions at Antenna Terminal	Compliance
§ 2.1053; § 22.917(a); § 24.238(a);	Field Strength of Spurious Radiation	Compliance
§ 22.917(a); § 24.238(a);	Out of band emission, Band Edge	Compliance
§ 2.1055; § 22.355; § 24.235;	Frequency stability vs. temperature Frequency stability vs. voltage	Compliance
§ 1.1307; § 2.1093	RF Exposure (SAR)	Compliance

Note: Testing was performed by configuring EUT to maximum output power status, the declared output power class for different

Measurement Uncertainty

Emissions		
Test Item	Description	Uncertainty
Band Edge and Radiated Spurious Emissions	Confidence level of approximately 95% (in the case where distributions are normal), with a coverage factor of 2 (for EUTs < 0.5m X 0.5m X 0.5m)	+5.6dB/-4.5dB
-	-	-

6. MEASUREMENTS, EXAMINATION AND DERIVED RESULTS

6.1 Maximum Permissible Exposure (MPE)

Test Result: Pass

The EUT is a portable device, thus requires SAR evaluation;

Please refer to RF Exposure Evaluation Report: 16050010-FCC-H.

6.2 RF Output Power

Temperature	24°C
Relative Humidity	59%
Atmospheric Pressure	1007mbar
Test date :	March 07, 2016
Tested By :	Winnie Zhang

Requirement(s):

Spec	Item	Requirement	Applicable
§22.913 (a)	a)	ERP:38.45dBm	<input checked="" type="checkbox"/>
§24.232 (c)	b)	EIRP:33dBm	<input checked="" type="checkbox"/>

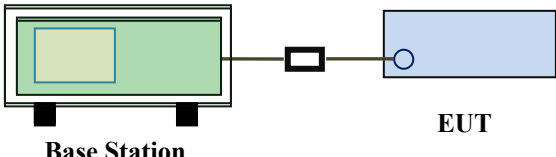
Test Setup	 <p style="text-align: center;">Base Station EUT</p>
------------	--

Test Procedure	<p>For Conducted Power:</p> <ul style="list-style-type: none"> - The transmitter output port was connected to base station. - Set EUT at maximum power through base station. - Select lowest, middle, and highest channels for each band and different test mode. <p>For ERP/EIRP:</p> <ul style="list-style-type: none"> - The transmitter was placed on a wooden turntable, and it was transmitting into a non-radiating load which was also placed on the turntable. - The measurement antenna was placed at a distance of 3 meters from the EUT. During the tests, the antenna height and polarization as well as EUT azimuth were varied in order to identify the maximum level of emissions from the EUT. The test was performed by placing the EUT on 3-orthogonal axis. - The frequency range up to tenth harmonic of the fundamental frequency was investigated. - Remove the EUT and replace it with substitution antenna. A signal generator was connected to the substitution antenna by a non-
----------------	--

	<p>radiating cable. The absolute levels of the spurious emissions were measured by the substitution.</p> <ul style="list-style-type: none"> - Spurious emissions in dB = 10 log (TX power in Watts/0.001) – the absolute level - Spurious attenuation limit in dB = 43 + 10 Log10 (power out in Watts).
Remark	
Result	<input checked="" type="checkbox"/> Pass <input type="checkbox"/> Fail

Test Data Yes N/A

Test Plot Yes (See below) N/A

Conducted Power

1x RTT Mode:

Burst Average Power (dBm);								
Band	Cellular				PCS			
Channel	1013	384	779	Tune up Power tolerant	25	600	1175	Tune up Power tolerant
Frequency (MHz)	824.7	836.5	848.37	/	1851.25	1880	1908.75	/
1x RTT	23.64	24.09	24.03	24±1	22.38	22.10	23.05	21.3±1

ERP & EIRP

ERP for Cellular Band (Part 22H)

Frequency (MHz)	Substituted level (dBm)	Antenna Polarization	Antenna Gain correction (dBi)	Cable Loss (dB)	Absolute Level (dBm)	Limit (dBm)
824.7	15.26	V	6.8	0.53	21.53	38.45
824.7	13.61	H	6.8	0.53	19.88	38.45
836.5	15.43	V	6.8	0.53	21.70	38.45
836.5	13.88	H	6.8	0.53	20.15	38.45
848.37	15.37	V	6.9	0.53	21.74	38.45
848.37	13.82	H	6.9	0.53	20.19	38.45

EIRP for PCS Band (Part 24E)

Frequency (MHz)	Substituted level (dBm)	Antenna Polarization	Antenna Gain correction (dBi)	Cable Loss (dB)	Absolute Level (dBm)	Limit (dBm)
1851.25	16.79	V	7.88	0.85	23.82	33
1851.25	14.91	H	7.88	0.85	21.94	33
1880	16.65	V	7.88	0.85	23.68	33
1880	14.83	H	7.88	0.85	21.86	33
1908.75	17.49	V	7.86	0.85	24.50	33
1908.75	15.74	H	7.86	0.85	22.75	33

6.3 Peak-Average Ratio

Temperature	24°C
Relative Humidity	59%
Atmospheric Pressure	1007mbar
Test date :	March 07, 2016
Tested By :	Winnie Zhang

Requirement(s):

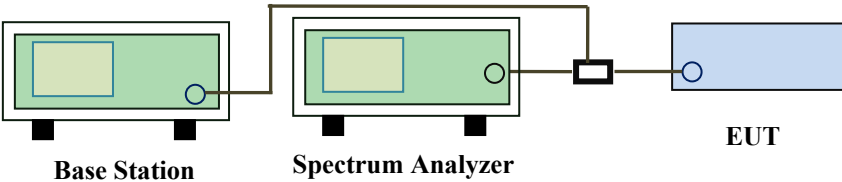
Spec	Item	Requirement	Applicable
§24.232(d)	a)	The peak-to-average ratio (PAR) of the transmission may not exceed 13 dB.	<input checked="" type="checkbox"/>
Test Setup	 <p style="text-align: center;">Base Station Spectrum Analyzer EUT</p>		
Test Procedure	<p>According with KDB 971168 v02r02</p> <ol style="list-style-type: none"> 1. The signal analyzer' s CCDF measurement profile is enabled 2. Frequency = carrier center frequency 3. Measurement BW > Emission bandwidth of signal 4. The signal analyzer was set to collect one million samples to generate the CCDF curve 5. The measurement interval was set depending on the type of signal analyzed. For continuous signals (>98% duty cycle), the measurement interval was set to 1ms. For burst transmissions, the spectrum analyzer is set to use an internal “ RF Burst” trigger that is synced with an incoming pulse and the measurement interval is set to less than the duration of the “ on time” of one burst to ensure that energy is only captured during a time in which the transmitter is operating at maximum power 		
Remark			
Result	<input checked="" type="checkbox"/> Pass <input type="checkbox"/> Fail		

Test Data Yes N/A
 Test Plot Yes (See below) N/A

1x RTT Mode:

PCS Band

Frequency (MHz)	Conducted power(dBm)		Peak-Average Ratio(PAR)
	Peak	Average	
1851.25	23.78	22.38	1.40
1880	23.65	22.10	1.55
1908.75	24.33	23.05	1.28

6.4 Occupied Bandwidth

Temperature	24°C
Relative Humidity	56%
Atmospheric Pressure	1004mbar
Test date :	March 04, 2016
Tested By :	Winnie Zhang

Requirement(s):

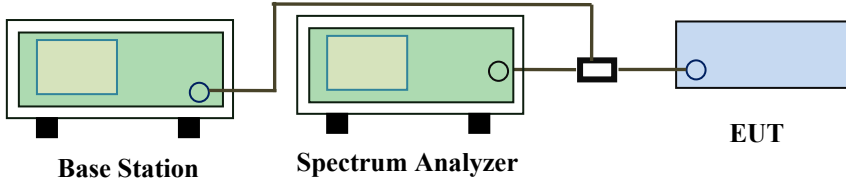
Spec	Item	Requirement	Applicable
§2.1049, §22.917, §22.905 §24.238	a)	99% Occupied Bandwidth(kHz)	<input checked="" type="checkbox"/>
	b)	26 dB Bandwidth(kHz)	<input checked="" type="checkbox"/>
Test Setup	 <p style="text-align: center;">Base Station Spectrum Analyzer EUT</p>		
Test Procedure	<ul style="list-style-type: none"> - The EUT was connected to Spectrum Analyzer and Base Station via power divider. - The 99% and 26 dB occupied bandwidth (BW) of the middle channel for the highest RF powers. 		
Remark			
Result	<input checked="" type="checkbox"/> Pass <input type="checkbox"/> Fail		

Test Data Yes N/A

Test Plot Yes (See below) N/A

1x RTT Mode:

Cellular Band (Part 22H) result

Channel	Frequency (MHz)	99% Occupied Bandwidth (MHz)	26 dB Bandwidth (MHz)
1013	824.7	1.2820	1.436
384	836.5	1.2861	1.440
779	848.37	1.2901	1.447

PCS Band (Part 24E) result

Channel	Frequency (MHz)	99% Occupied Bandwidth (MHz)	26 dB Bandwidth (MHz)
25	1851.25	1.2899	1.464
600	1880.0	1.2898	1.451
1175	1908.75	1.2896	1.449

Test Plots

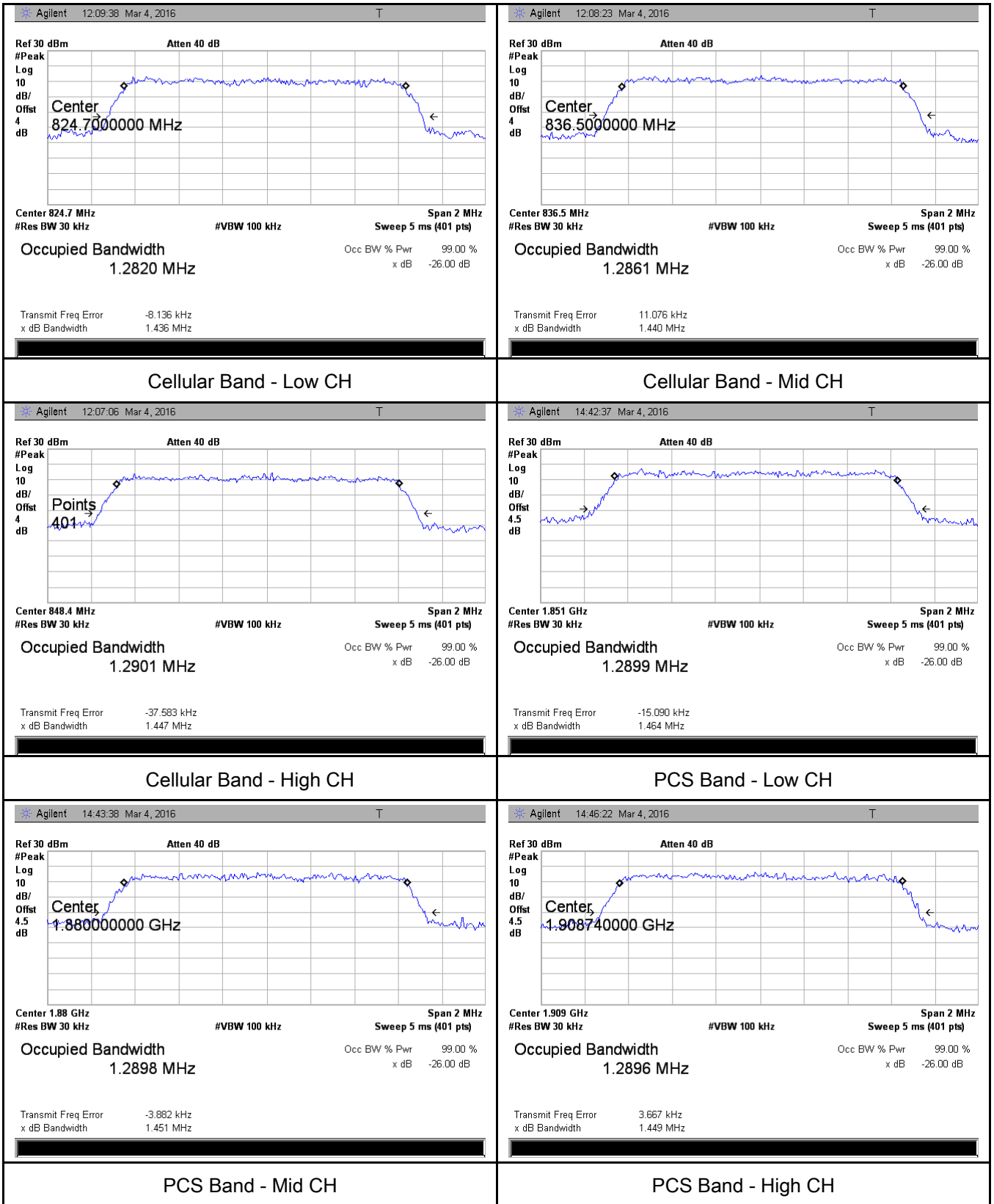

6.6 Spurious Emissions at Antenna Terminals

Temperature	24°C
Relative Humidity	56%
Atmospheric Pressure	1004mbar
Test date :	March 04, 2016
Tested By :	Winnie Zhang

Requirement(s):

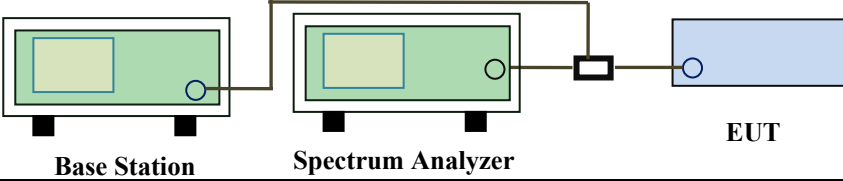
Spec	Item	Requirement	Applicable
§2.1051, §22.917(a)& §24.238(a)	a)	The power of any emission outside of the authorized operating frequency ranges must be lower than the transmitter power (P) by a factor of at least $43 + 10 \log (P)$ dB	<input checked="" type="checkbox"/>
Test Setup	 <p style="text-align: center;">Base Station Spectrum Analyzer EUT</p>		
Test Procedure	<ul style="list-style-type: none"> - The EUT was connected to Spectrum Analyzer and Base Station via power divider. - The Band Edges of low and high channels for the highest RF powers were measured. - Setting RBW as roughly BW/100. 		
Remark			
Result	<input checked="" type="checkbox"/> Pass <input type="checkbox"/> Fail		

Test Data Yes N/A
 Test Plot Yes (See below) N/A

Test Plots

Cellular Band (Part 22H) result

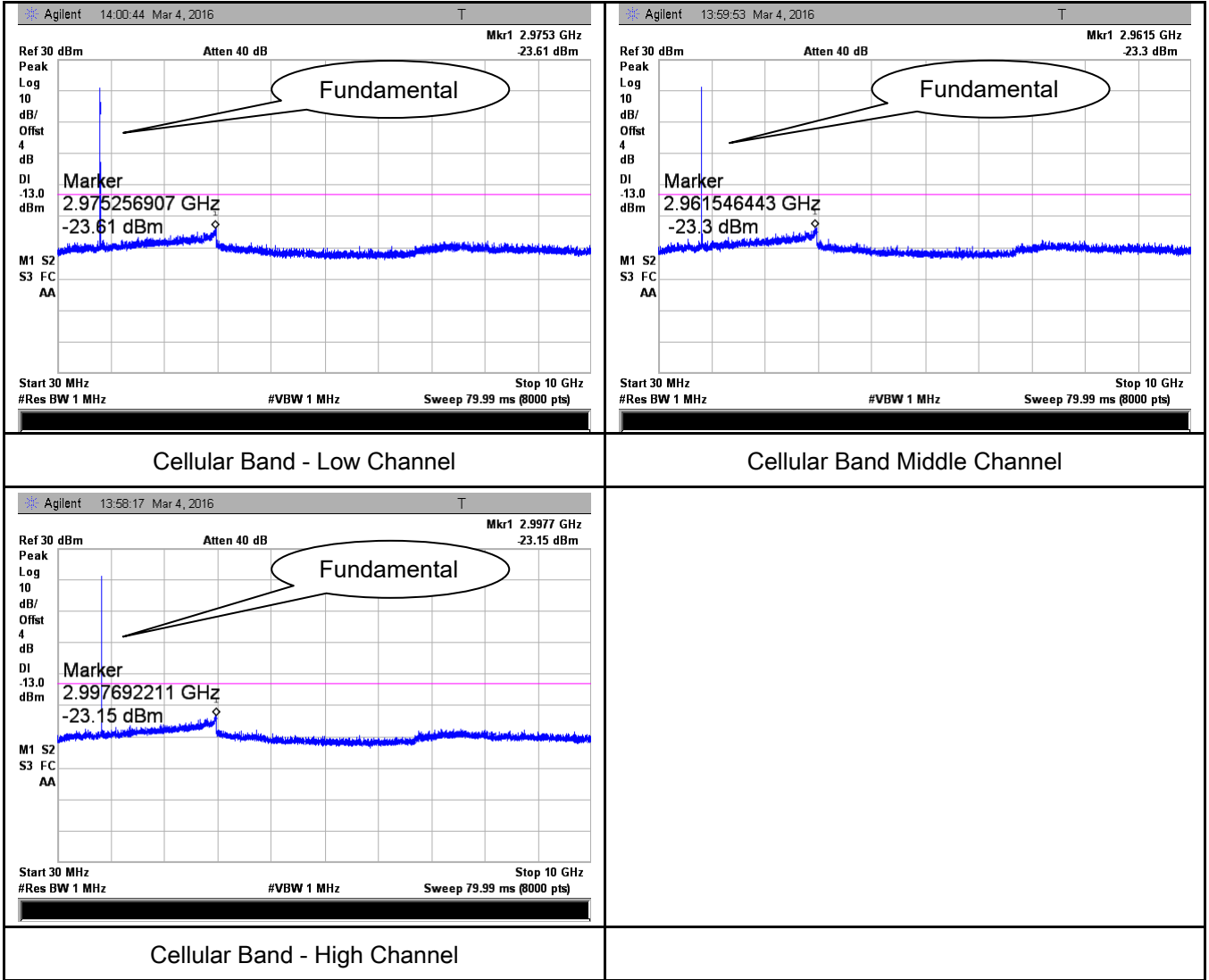

PCS Band (Part24E) result

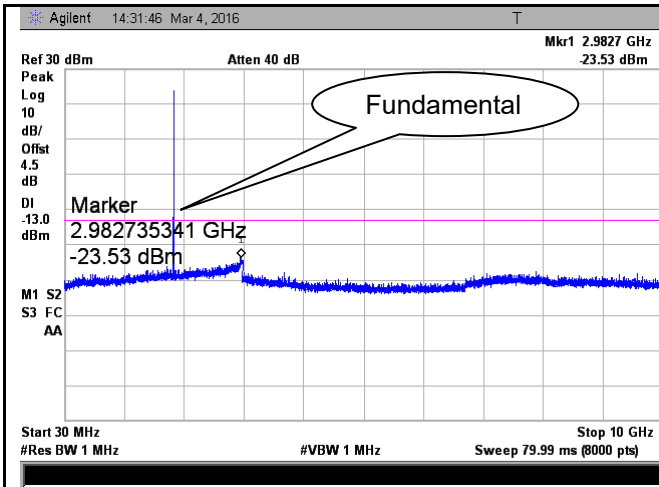

PCS Band - Low Channel-1

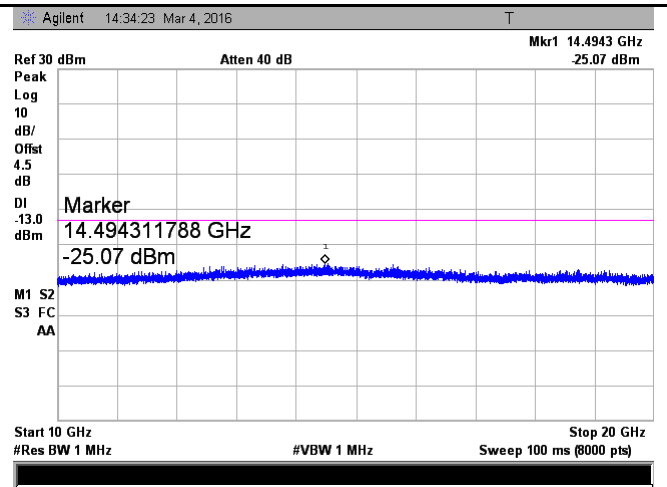

PCS Band - Low Channel-2

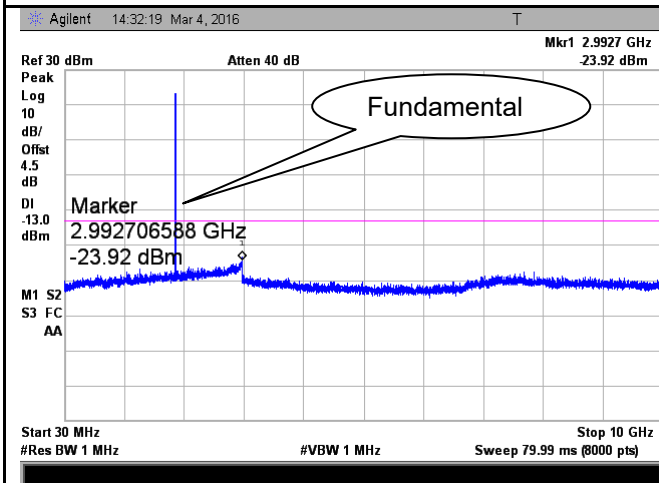

PCS Band - Middle Channel-1

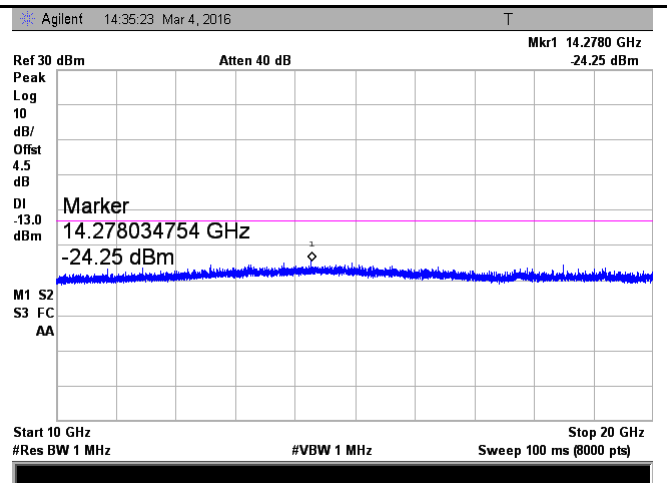

PCS Band - Middle Channel-2

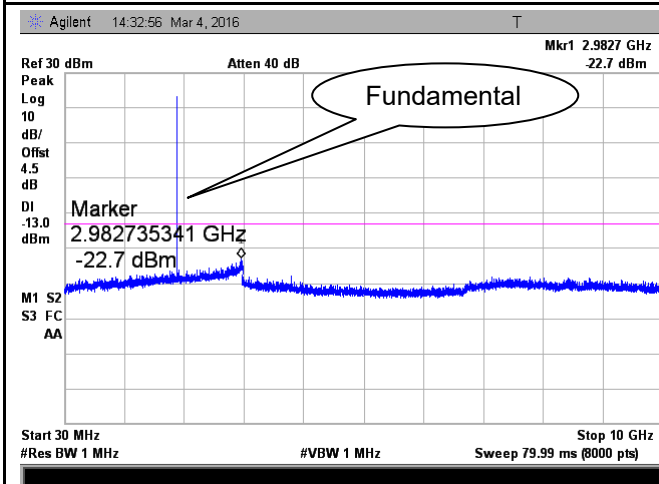

PCS Band - High Channel-1

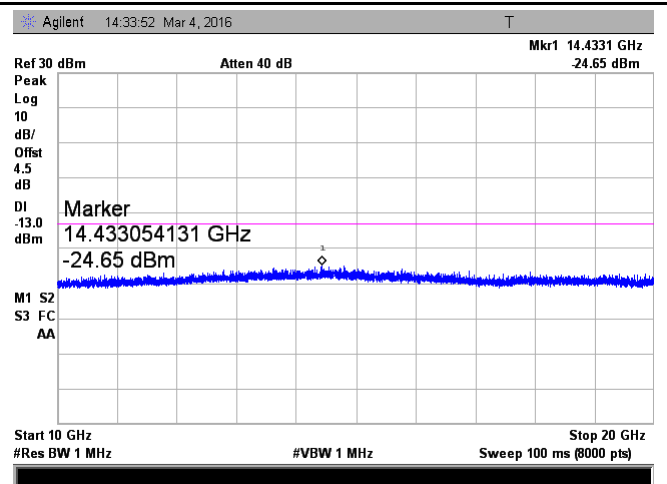

PCS Band - High Channel-2

6.7 Spurious Radiated Emissions

Temperature	24°C
Relative Humidity	59%
Atmospheric Pressure	1007mbar
Test date :	March 07, 2016
Tested By :	Winnie Zhang

Requirement(s):

Spec	Item	Requirement	Applicable
§2.1053, §22.917 & §24.238	a)	The power of any emission outside of the authorized operating frequency ranges must be attenuated below the transmitter power (P) by a factor of at least $43 + 10 \log (P)$ dB. The spectrum is scanned from 30 MHz up to a frequency including its 10th harmonic.	<input checked="" type="checkbox"/>

Test setup	<p>The diagram illustrates the test setup. A horizontal ground plane is shown. On the left, a turntable is positioned 1.5m above the ground plane, supporting EUT & Support Units. A distance of 3m is marked between the turntable and the antenna tower. The antenna tower is a vertical structure with a height of 1-4m, which is variable. A test receiver is connected to the antenna tower. The antenna tower is labeled 'Ant. Tower' and the height is labeled '1-4m Variable'.</p>
------------	--

Test Procedure	<ol style="list-style-type: none"> The transmitter was placed on a wooden turntable, and it was transmitting into a non-radiating load which was also placed on the turntable. The measurement antenna was placed at a distance of 3 meters from the EUT. During the tests, the antenna height and polarization as well as EUT azimuth were varied in order to identify the maximum level of emissions from the EUT. The test was performed by placing the EUT on 3-orthogonal axis. Remove the EUT and replace it with substitution antenna. A signal generator was connected to the substitution antenna by a non-radiating cable. The absolute levels of the spurious emissions were measured by the substitution. <p>Sample Calculation:</p> <p>EUT Field Strength = Raw Amplitude (dBμV/m) – Amplifier Gain (dB) + Antenna Factor (dB) + Cable Loss (dB) + Filter Attenuation (dB, if used)</p>
----------------	--

Test Report	16050010-FCC-R
Page	22 of 41

Remark	
Result	<input checked="" type="checkbox"/> Pass <input type="checkbox"/> Fail

Test Data Yes N/A
Test Plot Yes (See below) N/A

Cellular Band (Part 22H) result

Low channel

Frequency (MHz)	Substituted level (dBm)	Polarity (H/V)	Antenna Gain Correction (dB)	Cable Loss (dB)	Corrected Reading (dBm)	Limit (dBm)	Margin (dB)
1649.4	-41.87	V	7.95	0.78	-34.7	-13	-21.7
1649.4	-42.18	H	7.95	0.78	-35.01	-13	-22.01
276.5	-50.12	V	5.7	0.25	-44.67	-13	-31.67
623.7	-48.95	H	7	0.38	-42.33	-13	-29.33

Middle channel

Frequency (MHz)	Substituted level (dBm)	Polarity (H/V)	Antenna Gain Correction (dB)	Cable Loss (dB)	Corrected Reading (dBm)	Limit (dBm)	Margin (dB)
1673	-41.56	V	7.95	0.78	-34.39	-13	-21.39
1673	-42.63	H	7.95	0.78	-35.46	-13	-22.46
276.2	-50.24	V	5.7	0.25	-44.79	-13	-31.79
623.8	-48.87	H	7	0.38	-42.25	-13	-29.25

High channel

Frequency (MHz)	Substituted level (dBm)	Polarity (H/V)	Antenna Gain Correction (dB)	Cable Loss (dB)	Corrected Reading (dBm)	Limit (dBm)	Margin (dB)
1696.7	-41.66	V	7.95	0.78	-34.49	-13	-21.49
1696.7	-42.24	H	7.95	0.78	-35.07	-13	-22.07
276.6	-50.31	V	5.7	0.25	-44.86	-13	-31.86
623.2	-48.75	H	7	0.38	-42.13	-13	-29.13

Note:

- 1, The testing has been conformed to $10 \times 848.37 \text{MHz} = 8483.7 \text{MHz}$
- 2, All other emissions more than 30 dB below the limit

PCS Band (Part24E) result

Low channel

Frequency (MHz)	Substituted level (dBm)	Polarity (H/V)	Antenna Gain Correction (dB)	Cable Loss (dB)	Corrected Reading (dBm)	Limit (dBm)	Margin (dB)
3702.5	-48.86	V	10.25	2.73	-41.34	-13	-28.34
3702.5	-48.12	H	10.25	2.73	-40.6	-13	-27.6
276.4	-52.13	V	5.7	0.25	-46.68	-13	-33.68
623.1	-51.46	H	7	0.38	-44.84	-13	-31.84

Middle channel

Frequency (MHz)	Substituted level (dBm)	Polarity (H/V)	Antenna Gain Correction (dB)	Cable Loss (dB)	Corrected Reading (dBm)	Limit (dBm)	Margin (dB)
3760	-48.78	V	10.25	2.73	-41.26	-13	-28.26
3760	-48.36	H	10.25	2.73	-40.84	-13	-27.84
276.5	-52.28	V	5.7	0.25	-46.83	-13	-33.83
623.4	-51.51	H	7	0.38	-44.89	-13	-31.89

High channel

Frequency (MHz)	Substituted level (dBm)	Polarity (H/V)	Antenna Gain Correction (dB)	Cable Loss (dB)	Corrected Reading (dBm)	Limit (dBm)	Margin (dB)
3817.5	-48.69	V	10.36	2.73	-41.06	-13	-28.06
3817.5	-48.23	H	10.36	2.73	-40.6	-13	-27.6
276.3	-52.06	V	5.7	0.25	-46.61	-13	-33.61
623.6	-51.39	H	7	0.38	-44.77	-13	-31.77

Note:

- 1, The testing has been conformed to $10 \times 1908.75 \text{MHz} = 19087.5 \text{MHz}$
- 2, All other emissions more than 30 dB below the limit

6.8 Band Edge

Temperature	24°C
Relative Humidity	56%
Atmospheric Pressure	1004mbar
Test date :	March 04, 2016
Tested By :	Winnie Zhang

Requirement(s):

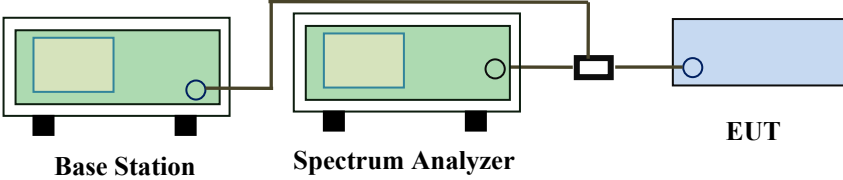
Spec	Item	Requirement	Applicable
§22.917(a) §24.238(a)	a)	The power of any emission outside of the authorized operating frequency ranges must be lower than the transmitter power (P) by a factor of at least $43 + 10 \log (P)$ dB.	<input checked="" type="checkbox"/>
Test setup	 <p>The diagram shows a Base Station (green box) connected to a Spectrum Analyzer (green box) and an EUT (blue box) via a power divider. The Base Station and Spectrum Analyzer are connected to the power divider, which then splits the signal to the Spectrum Analyzer and the EUT.</p>		
Procedure	<ul style="list-style-type: none"> - The EUT was connected to Spectrum Analyzer and Base Station via power divider. - The Band Edges of low and high channels for the highest RF powers were measured. Setting RBW as roughly BW/100. 		
Remark			
Result	<input checked="" type="checkbox"/> Pass <input type="checkbox"/> Fail		

Test Data Yes N/A

Test Plot Yes (See below) N/A

Cellular Band (Part 22H) result

Frequency (MHz)	Emission (dBm)	Limit (dBm)
823.9275	-22.35	-13
849.2100	-22.64	-13

PCS Band (Part 24E) result

Frequency (MHz)	Emission (dBm)	Limit (dBm)
1850.3175	-18.82	-13
1909.5650	-20.18	-13

Test Plots

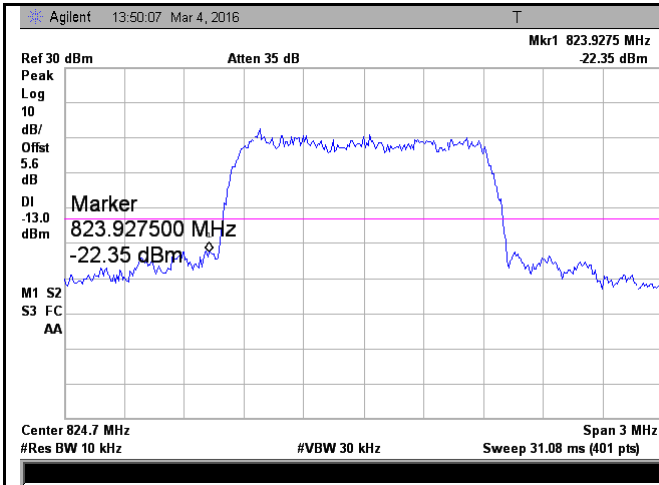

Cellular Band - Low Channel

Note: Offset=Cable loss (4.0) + 10log
(1.436)=4.0+1.6=5.6 dB

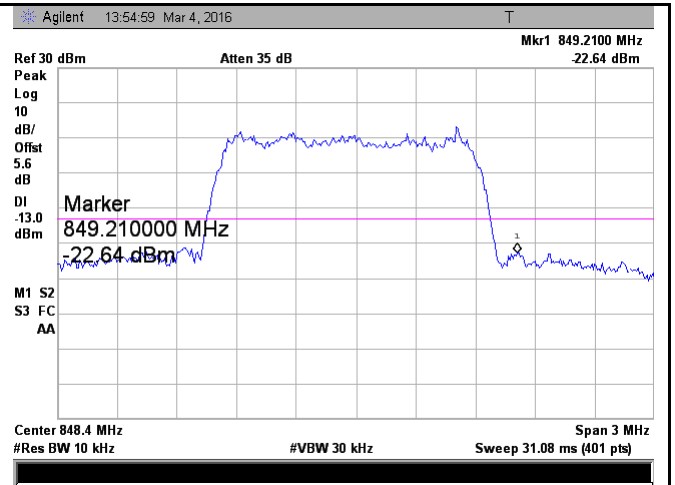

Cellular Band - High Channel

Note: Offset=Cable loss (4.0) + 10log
(1.447)=4.0+1.6=5.6 dB

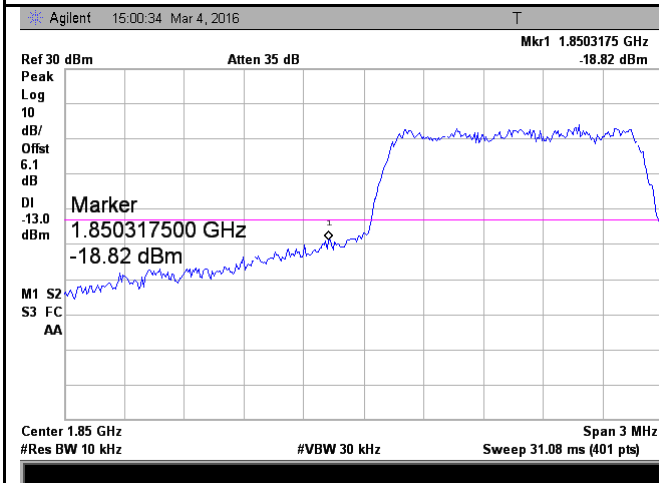

PCS Band - Low Channel

Note: Offset=Cable loss (4.5) + 10log
(1.464)=4.5+1.6=6.1 dB

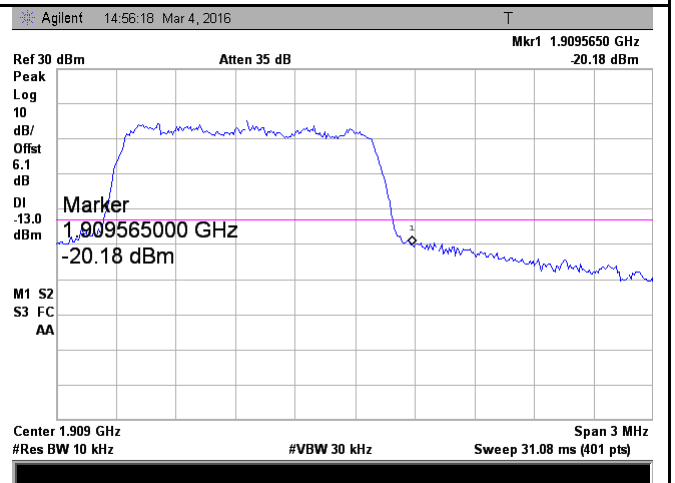

PCS Band - High Channel

Note: Offset=Cable loss (4.5) + 10log
(1.449)=4.5+1.6=6.1 dB

6.9 Frequency Stability

Temperature	23°C
Relative Humidity	55%
Atmospheric Pressure	1003mbar
Test date :	March 03, 2016
Tested By :	Winnie Zhang

Requirement(s):

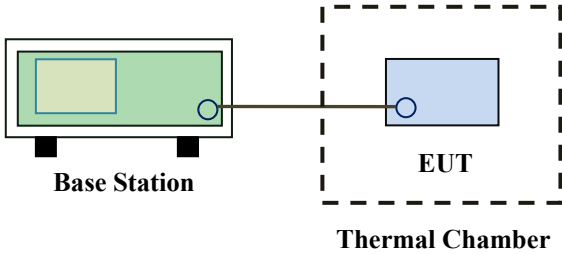
Spec	Item	Requirement	Applicable																																
§2.1055, §22.355 & §24.235	a)	According to §22.355, the carrier frequency of each transmitter in the Public Mobile Services must be maintained within the tolerances given in Table below: Frequency Tolerance for Transmitters in the Public Mobile Services	<input checked="" type="checkbox"/>																																
		<table border="1"> <thead> <tr> <th>Frequency Range (MHz)</th> <th>Base, fixed (ppm)</th> <th>Mobile ≤ 3 watts (ppm)</th> <th>Mobile ≤ 3 watts (ppm)</th> </tr> </thead> <tbody> <tr> <td>25 to 50</td> <td>20.0</td> <td>20.0</td> <td>50.0</td> </tr> <tr> <td>50 to 450</td> <td>5.0</td> <td>5.0</td> <td>50.0</td> </tr> <tr> <td>450 to 51</td> <td>2.5</td> <td>5.</td> <td>5.0</td> </tr> <tr> <td>821 to 896</td> <td>1.5</td> <td>2.5</td> <td>2.5</td> </tr> <tr> <td>928 to 929.</td> <td>5 0</td> <td>N/A</td> <td>N/A</td> </tr> <tr> <td>929 to 960.</td> <td>1.5</td> <td>N/A</td> <td>N/A</td> </tr> <tr> <td>2110 to 2220</td> <td>10.0</td> <td>N/A</td> <td>N/A</td> </tr> </tbody> </table>		Frequency Range (MHz)	Base, fixed (ppm)	Mobile ≤ 3 watts (ppm)	Mobile ≤ 3 watts (ppm)	25 to 50	20.0	20.0	50.0	50 to 450	5.0	5.0	50.0	450 to 51	2.5	5.	5.0	821 to 896	1.5	2.5	2.5	928 to 929.	5 0	N/A	N/A	929 to 960.	1.5	N/A	N/A	2110 to 2220	10.0	N/A	N/A
		Frequency Range (MHz)		Base, fixed (ppm)	Mobile ≤ 3 watts (ppm)	Mobile ≤ 3 watts (ppm)																													
		25 to 50		20.0	20.0	50.0																													
		50 to 450		5.0	5.0	50.0																													
		450 to 51		2.5	5.	5.0																													
		821 to 896		1.5	2.5	2.5																													
		928 to 929.		5 0	N/A	N/A																													
929 to 960.	1.5	N/A	N/A																																
2110 to 2220	10.0	N/A	N/A																																
According to §24.235, the frequency stability shall be sufficient to ensure that the fundamental emissions stay within the authorized frequency block.																																			
Test setup	 <p>The diagram illustrates the test setup. On the left, a green rectangular box labeled 'Base Station' is shown. A line connects it to a blue rectangular box labeled 'EUT' (Equipment Under Test) which is enclosed within a dashed-line box labeled 'Thermal Chamber'.</p>																																		

Test Report	16050010-FCC-R
Page	29 of 41

Procedure	A communication link was established between EUT and base station. The frequency error was monitored and measured by base station under variation of ambient temperature and variation of primary supply voltage. Limit: The frequency stability of the transmitter shall be maintained within $\pm 0.00025\%$ ($\pm 2.5\text{ppm}$) of the center frequency.
Remark	
Result	<input checked="" type="checkbox"/> Pass <input type="checkbox"/> Fail

Test Data Yes N/A

Test Plot Yes (See below) N/A

Cellular Band (Part 22H) result

Middle Channel, $f_0 = 836.52$ MHz				
Temperature (°C)	Power Supplied (V _{DC})	Frequency Error (Hz)	Frequency Error (ppm)	Limit (ppm)
-10	3.7	19	0.0227	2.5
0		16	0.0191	2.5
10		15	0.0179	2.5
20		15	0.0179	2.5
30		14	0.0167	2.5
40		17	0.0203	2.5
50		13	0.0155	2.5
55		17	0.0203	2.5
25		4.2	16	0.0191
	3.5	20	0.0239	2.5

PCS Band (Part 24E) result

Middle Channel, $f_0 = 1880$ MHz				
Temperature (°C)	Power Supplied (V _{DC})	Frequency Error (Hz)	Frequency Error (ppm)	Limit (ppm)
-10	3.7	21	0.0112	2.5
0		17	0.0090	2.5
10		14	0.0074	2.5
20		14	0.0074	2.5
30		15	0.0080	2.5
40		21	0.0112	2.5
50		23	0.0122	2.5
55		21	0.0112	2.5
25		4.2	20	0.0106
	3.5	210	0.1117	2.5

Annex A. TEST INSTRUMENT

Instrument	Model	Serial #	Cal Date	Cal Due	In use
RF Conducted Test					
Agilent ESA-E SERIES SPECTRUM ANALYZER	E4407B	09/16/2015	09/16/2015	09/15/2016	<input checked="" type="checkbox"/>
Power Splitter	1#	09/01/2015	09/01/2015	08/31/2016	<input checked="" type="checkbox"/>
Universal Radio Communication Tester	CMU200	09/25/2015	09/25/2015	09/24/2016	<input checked="" type="checkbox"/>
Power Amplifier	SMC150D	R1553-0313	03/10/2015	03/10/2016	<input checked="" type="checkbox"/>
Power Amplifier	S41-25D	R1553-0314	05/28/2015	05/28/2016	<input checked="" type="checkbox"/>
Temperature/Humidity Chamber	UHL-270	10/09/2015	10/09/2015	10/08/2016	<input checked="" type="checkbox"/>
DC Power Supply	E3640A	09/17/2015	09/17/2015	09/16/2016	<input checked="" type="checkbox"/>
Radiated Emissions					
EMI test receiver	ESL6	100262	09/17/2015	09/16/2016	<input checked="" type="checkbox"/>
OPT 010 AMPLIFIER (0.1-1300MHz)	8447E	2727A02430	09/01/2015	08/31/2016	<input checked="" type="checkbox"/>
Microwave Preamplifier (0.5 ~ 18GHz)	PAM-118	443008	03/25/2015	03/24/2016	<input checked="" type="checkbox"/>
Bilog Antenna (30MHz~6GHz)	JB6	A110712	09/21/2015	09/20/2016	<input checked="" type="checkbox"/>
Bilog Antenna (30MHz~2GHz)	JB1	A112017	09/21/2015	09/20/2016	<input checked="" type="checkbox"/>
Double Ridge Horn Antenna (1 ~18GHz)	AH-118	71259	09/24/2015	09/23/2016	<input checked="" type="checkbox"/>
Double Ridge Horn Antenna (1 ~18GHz)	AH-118	71283	09/24/2015	09/23/2016	<input checked="" type="checkbox"/>
SYNTHESIZED SIGNAL GENERATOR	8665B	3744A01293	09/17/2015	09/16/2016	<input checked="" type="checkbox"/>
Tunable Notch Filter	3NF-800/1000-S	AA4	09/01/2015	08/31/2016	<input checked="" type="checkbox"/>
Tunable Notch Filter	3NF-1000/2000-S	AM 4	09/01/2015	08/31/2016	<input checked="" type="checkbox"/>

Annex B. EUT And Test Setup Photographs

Annex B.i. Photograph: EUT External Photo



Whole Package - Top View



Adapter - Front View



EUT - Front View



EUT - Rear View



EUT - Top View



EUT - Bottom View



EUT - Left View



EUT - Right View

Annex B.ii. Photograph: EUT Internal Photo



Cover Off - Top View 1

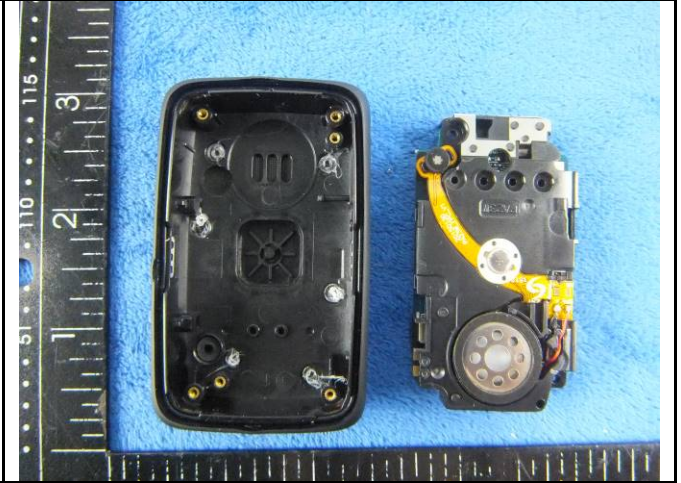

Cover Off - Top View 2

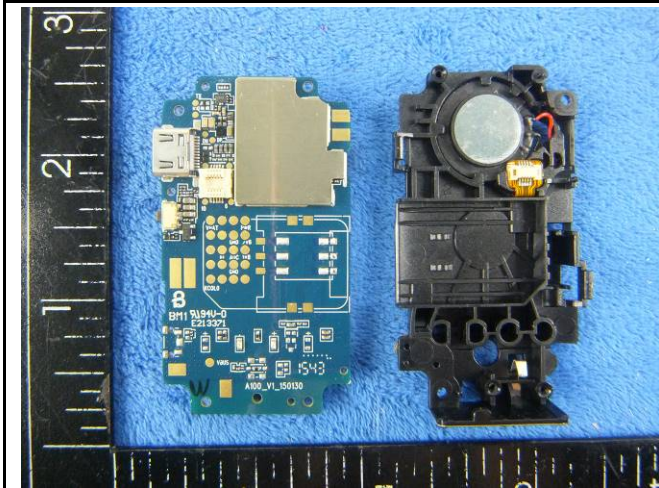

Cover Off - Top View 3



Battery - Front View



Battery - Rear View

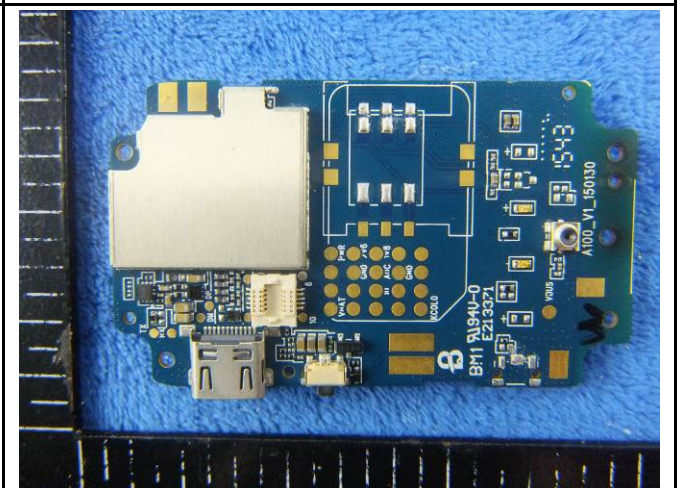

Mainboard with Shielding - Front View



Mainboard with Shielding - Rear View

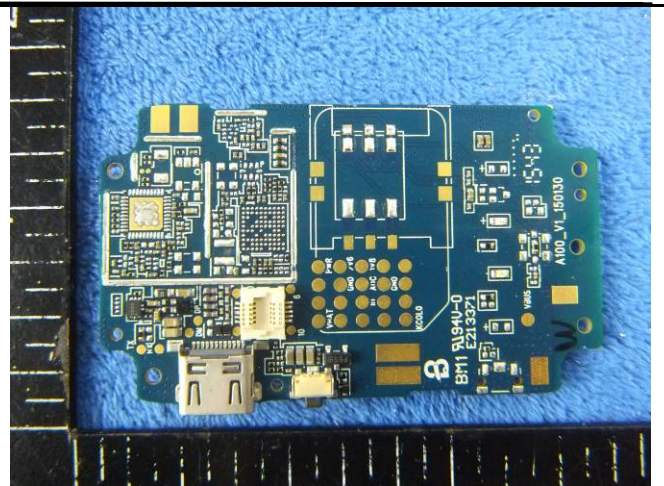

Mainboard without shielding - Front View

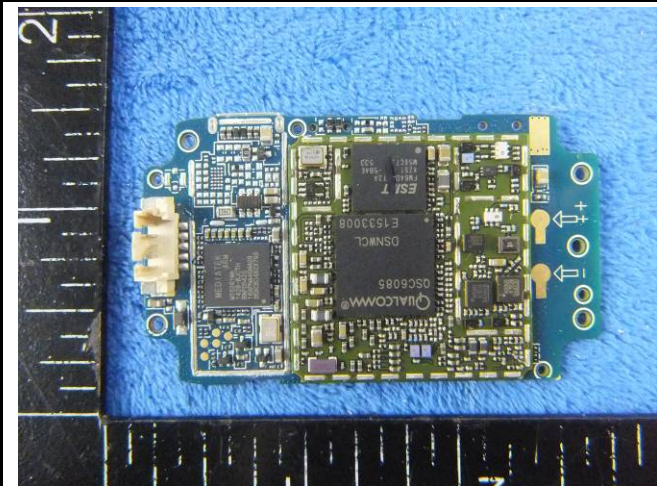

Mainboard without Shielding - Rear View

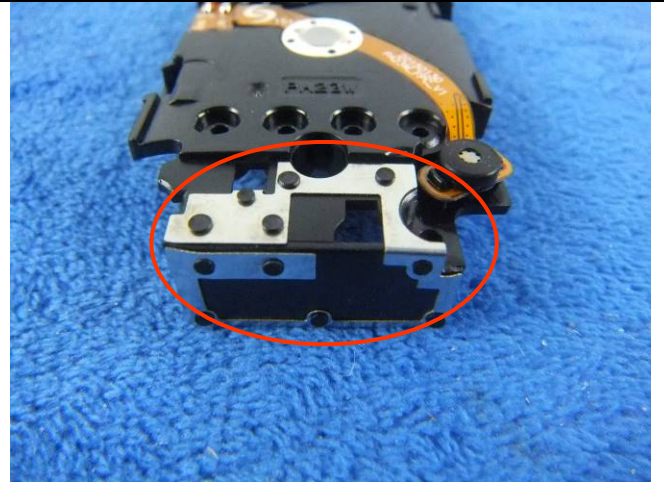

CDMA - Antenna View

Annex B.iii. Photograph: Test Setup Photo

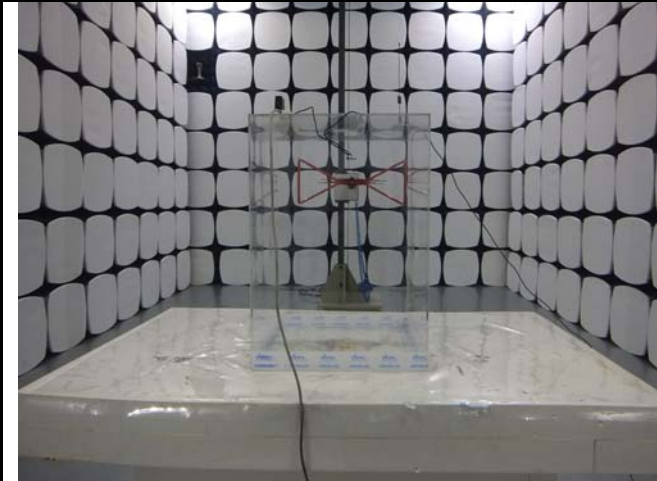

Radiated Spurious Emissions Test Setup Below 1GHz



Radiated Spurious Emissions Test Setup Above
1GHz

Annex C. TEST SETUP AND SUPPORTING EQUIPMENT

Annex C.ii. TEST SET UP BLOCK

Block Configuration Diagram for Radiated Emissions

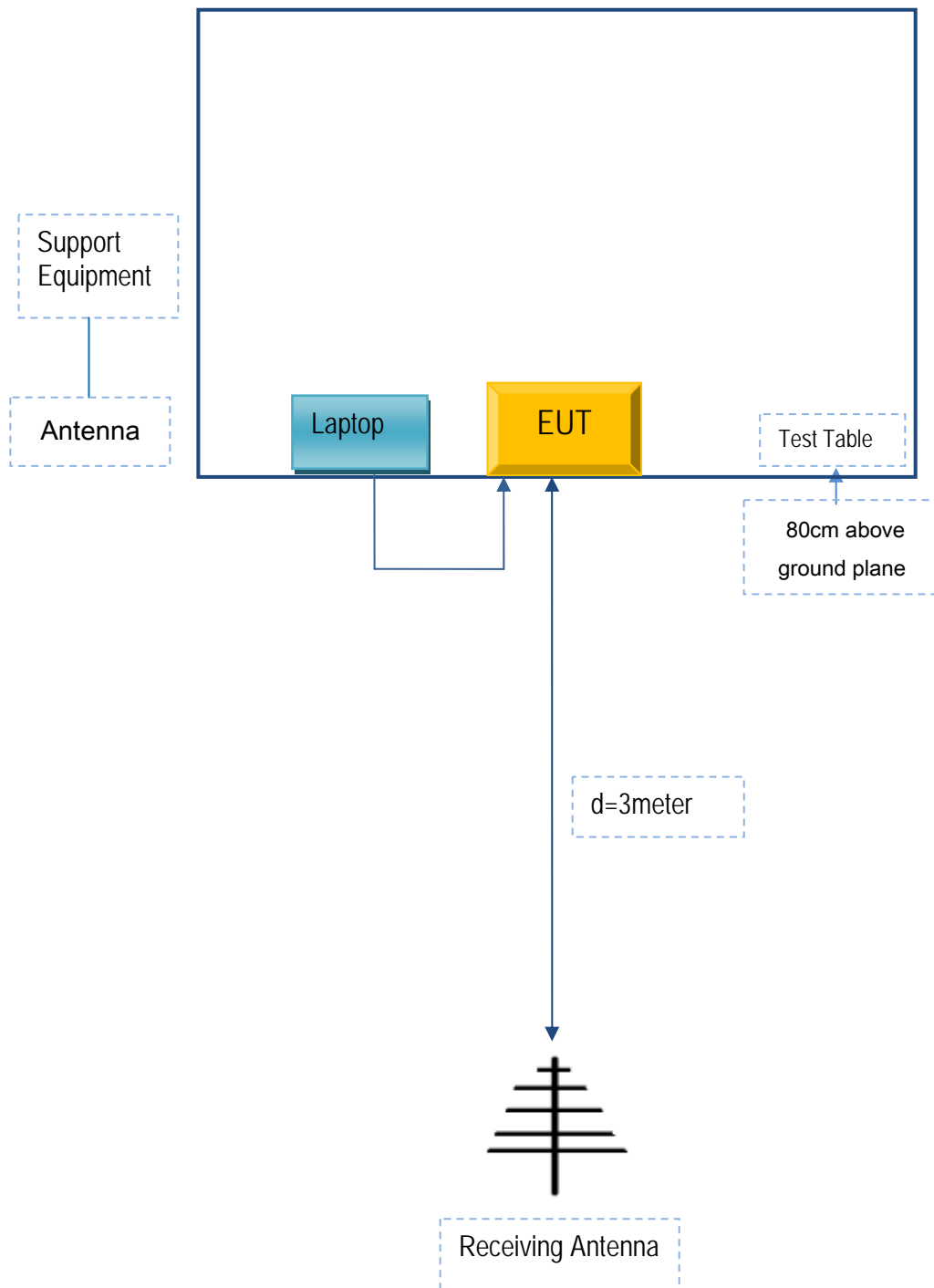

Annex C. ii. SUPPORTING EQUIPMENT DESCRIPTION

The following is a description of supporting equipment and details of cables used with the EUT.

Manufacturer	Equipment Description	Model	Serial No
Micron Electronics LLC.	Adapter	K05100-3	JX05100

Supporting Cable:

Cable type	Shield Type	Ferrite Core	Length	Serial No
USB Cable	Un-shielding	No	0.8m	JX04022

Annex C.ii. EUT OPERATING CONKITIONS

The following is the description of how the EUT is exercised during testing.

Test	Description Of Operation
Emissions Testing	The EUT was communicating with base station and set to work at maximum output power.
Others Testing	The EUT was communicating with base station and set to work at maximum output power.

Test Report	16050010-FCC-R
Page	40 of 41

Annex D. User Manual / Block Diagram / Schematics / Partlist

Please see attachment

Test Report	16050010-FCC-R
Page	41 of 41

Annex E. DECLARATION OF SIMILARITY

N/A