

# FCC Part22H&24E Test Report

Product Name : eCare  
Model No. : VL2000  
FCC ID : ZKQ-0916201100001

Applicant : Micron Electronics LLC  
Address : 601 North Congress Ave, Suite 439

Date of Receipt : 19/09/2011  
Test Date : 19/09/2011~23/09/2011  
Issued Date : 26/09/2011  
Report No. : 119S032R-HP-US-P07V01  
Report Version : V 1.0

The test results relate only to the samples tested.

The test results shown in the test report are traceable to the national/international standard through the calibration of the equipment and evaluated measurement uncertainty herein.

This report must not be used to claim product endorsement by TAF, NVLAP, NIST or any agency of the Government.

The test report shall not be reproduced except in full without the written approval of QuieTek Corporation.

## Test Report Certification

Issued Date : 26/09/2011

Report No. : 119S032R-HP-US-P07V01



Product Name : eCare  
Applicant : Micron Electronics LLC  
Address : 601 North Congress Ave, Suite 439  
Manufacturer : Shanghai SIMCom Ltd.  
Address : SIM Technology Building, No.633, Jinzhong Road,  
Changning District, shanghai, P.R.china  
Model No. : VL2000  
FCC ID : ZKQ-0916201100001  
EUT Voltage : DC 3.6~4.2V  
Brand Name : PRIME PT  
Applicable Standard : FCC CFR Title 47 Part 2, TIA/EIA 603-C  
FCC Part22 Subpart H, FCC Part24 Subpart E  
Test Result : Complied  
Performed Location : Suzhou EMC Laboratory  
No.99 Hongye Rd., Suzhou Industrial Park Loufeng Hi-Tech  
Development Zone., Suzhou, China  
TEL: +86-512-6251-5088 / FAX: +86-512-6251-5098  
FCC Registration Number: 800392

Documented By : Alice Ni  
(Engineering ADM: Alice Ni)  
Reviewed By : Robin Wu  
(Senior Engineer: Robin Wu)  
Approved By : Marlin Chen  
(Engineering Supervisor: Marlin Chen)

## Laboratory Information

We, **Quietek Corporation**, are an independent EMC and safety consultancy that was established the whole facility in our laboratories. The test facility has been accredited/accepted(audited or listed) by the following related bodies in compliance with ISO 17025, EN 45001 and specified testing scope:

<b>Taiwan R.O.C.</b>	<b>: BSMI, NCC, TAF</b>
<b>Germany</b>	<b>: TUV Rheinland</b>
<b>Norway</b>	<b>: Nemko, DNV</b>
<b>USA</b>	<b>: FCC, NVLAP</b>
<b>Japan</b>	<b>: VCCI</b>

The related certificate for our laboratories about the test site and management system can be downloaded from Quietek Corporation's Web Site : <http://www.quietek.com/tw/ctg/cts/accreditations.htm>  
 The address and introduction of Quietek Corporation's laboratories can be founded in our Web site : <http://www.quietek.com/>  
 If you have any comments, Please don't hesitate to contact us. Our contact information is as below:

### HsinChu Testing Laboratory :

No.75-2, 3<sup>rd</sup> Lin, Wangye Keng, Yonghxing Tsuen, Qionglin Shiang, Hsinchu County 307, Taiwan, R.O.C.  
 TEL:+886-3-592-8858 / FAX:+886-3-592-8859 E-Mail : [service@quietek.com](mailto:service@quietek.com)



### LinKou Testing Laboratory :

No. 5-22, Ruei-Shu Valley, Ruei-Ping Tsuen, Lin-Kou Shiang, Taipei, Taiwan, R.O.C.  
 TEL : 886-2-8601-3788 / FAX : 886-2-8601-3789 E-Mail : [service@quietek.com](mailto:service@quietek.com)



### Suzhou (China) Testing Laboratory :

No. 99 Hongye Rd., Suzhou Industrial Park Loufeng Hi-Tech Development Zone., Suzhou,China.  
 TEL : +86-512-6251-5088 / FAX : +86-512-6251-5098 E-Mail : [service@quietek.com](mailto:service@quietek.com)



**TABLE OF CONTENTS**

Description	Page
1. General Information .....	6
1.1. EUT Description .....	6
1.2. Mode of Operation .....	7
1.3. Tested System Details .....	8
1.4. Configuration of Tested System .....	9
1.5. EUT Exercise Software .....	10
2. Technical Test .....	11
2.1. Summary of Test Result .....	11
2.2. Test Environment .....	12
3. Peak Output Power .....	13
3.1. Test Equipment .....	13
3.2. Test Setup .....	14
3.3. Limit .....	14
3.4. Test Procedure .....	14
3.5. Uncertainty .....	16
3.6. Test Result .....	17
3.7. Test Photograph .....	21
4. Modulation Characteristic .....	24
4.1. Test Equipment .....	24
4.2. Test Setup .....	24
4.3. Limit .....	25
4.4. Test Procedure .....	25
4.5. Uncertainty .....	25
4.6. Test Result .....	26
5. Occupied Bandwidth .....	27
5.1. Test Equipment .....	27
5.2. Test Setup .....	27
5.3. Limit .....	28
5.4. Test Procedure .....	28
5.5. Uncertainty .....	28
5.6. Test Result .....	29
6. Spurious Emission At Antenna Terminals (+/- 1MHz) .....	33
6.1. Test Equipment .....	33
6.2. Test Setup .....	33
6.3. Limit .....	34
6.4. Test Procedure .....	34

---

6.5. Uncertainty .....	34
6.6. Test Result.....	35
7. Spurious Emission .....	37
7.1. Test Equipment.....	37
7.2. Test Setup.....	38
7.3. Limit.....	38
7.4. Test Procedure .....	38
7.5. Uncertainty .....	40
7.6. Test Result.....	41
7.7. Test Photograph .....	51
8. Frequency Stability Under Temperature & Voltage Variations.....	54
8.1. Test Equipment.....	54
8.2. Test Setup.....	54
8.3. Limit.....	55
8.4. Test Procedure .....	55
8.5. Uncertainty .....	55
8.6. Test Result.....	56
9. Attachment .....	58
➤ EUT Photograph.....	58

## 1. General Information

### 1.1. EUT Description

Product Name	eCare
Brand Name	PRIME PT
Model No.	VL2000
Working Voltage	DC 3.6~4.2V
GPS Function	Yes
Support Band	GSM850/PCS1900
Tx Frequency Range	GSM 850: 824MHz to 849MHz PCS 1900: 1850MHz to 1910MHz
Rx Frequency Range	GSM 850: 869MHz to 894MHz PCS 1900: 1930MHz to 1990MHz
GPRS Class	10
Type of modulation	GMSK
Peak Antenna Gain	1.2dBi
AC Adapter	Brand Name: eCare M/N: SW013UF-0500200US Input: 100-240V~50/60Hz 0.4A Output: DC 5V, 2A

**1.2. Mode of Operation**

Quietek has verified the construction and function in typical operation. All the test modes were carried out with the EUT in normal operation, which was shown in this test report and defined as:

Test Mode
Mode 1: GSM 850 Link
Mode 2: PCS 1900 Link

Note:

1. Regards to the frequency band operation: the lowest, middle and highest frequency of channel were selected to perform the test, then shown on this report.
2. Radiated power output working at GSM link was higher than that working at GPRS link, so all of test items were done working at GSM mode. Refer to peak power output for more details.
3. For the ERP/EIRP and radiated emission test, every axis (X, Y, Z) was verified, and show the worst (Z axis) result on this report.
4. This device is a composite device in accordance with Part 15 Subpart B regulations. The report number is 117S015R-HP-US-P01V02.

**1.3. Tested System Details**

The types for all equipments, plus descriptions of all cables used in the tested system (including inserted cards) are:

Product	Manufacturer	Model No.	Serial No.	Power Cord
1 Radio Communication Tester	R&S	CMU 200	112012	N/A
2 ESG Vector Signal Generator	Agilent	E4438C	MY49070163	N/A



1.4. Configuration of Tested System

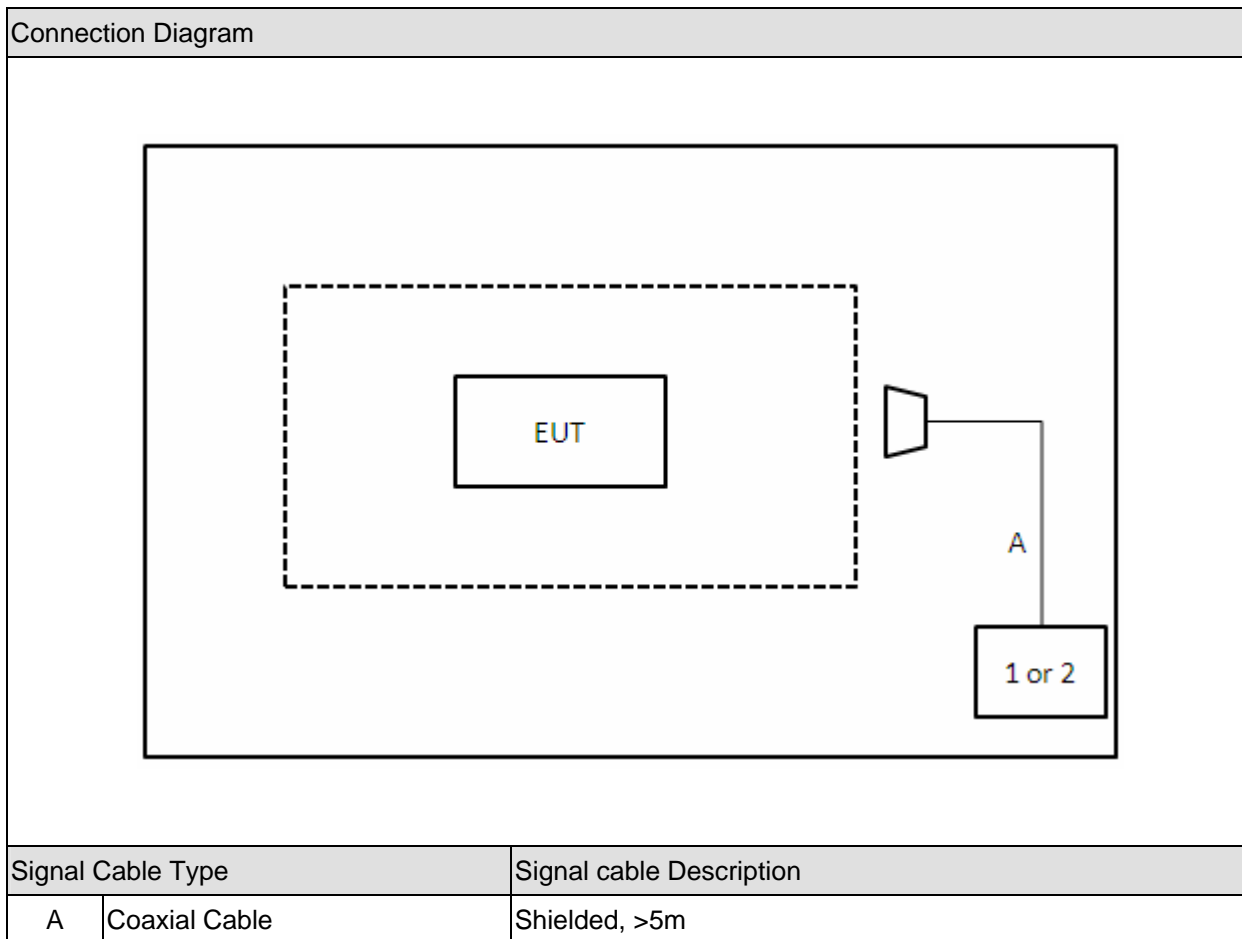

**1.5. EUT Exercise Software**

1	Setup the EUT and simulators as shown on above.
2	Turn on the power of all equipment.
3	EUT Communicate with CMU200, then select channel to test.

**2. Technical Test**

**2.1. Summary of Test Result**

- No deviations from the test standards
- Deviations from the test standards as below description:

For GSM 850 (FCC Part 22H & Part 2)

Emission			
Performed Item	Normative References	Test Performed	Deviation
Peak Output Power	FCC Part 22.913(a)(2) and Part 2.1046	Yes	No
Modulation Characteristic	FCC Part 2.1047(d)	Yes	No
Occupied Bandwidth	FCC Part 2.1049	Yes	No
Spurious Emission At Antenna Terminals (+/- 1MHz)	FCC Part 22.917(a) and Part 2.1049	Yes	No
Spurious Emission	FCC Part 22.917(b) and Part 2.1051, 2.1053	Yes	No
Frequency Stability Under Temperature & Voltage Variations	FCC Part 22.355 and 2.1055	Yes	No

For PCS 1900 (FCC Part 24E & Part 2)

Emission			
Performed Item	Normative References	Test Performed	Deviation
Peak Output Power	FCC Part 24.232(b) and Part 2.1046	Yes	No
Modulation Characteristic	FCC Part 2.1047(d)	Yes	No
Occupied Bandwidth	FCC Part 24.238(b) and Part 2.1049	Yes	No
Spurious Emission At Antenna Terminals (+/- 1MHz)	FCC Part 24.238(a) and Part 2.1049	Yes	No
Spurious Emission	FCC Part 24.238(b) and Part 2.1051, 2.1053	Yes	No
Frequency Stability Under Temperature & Voltage Variations	FCC Part 24.235 and 2.1055	Yes	No

**2.2. Test Environment**

Items	Required (IEC 68-1)	Actual
Temperature (°C)	15-35	23
Humidity (%RH)	25-75	52
Barometric pressure (mbar)	860-1060	950-1000

### 3. Peak Output Power

#### 3.1. Test Equipment

Peak Output Power / AC-5

Instrument	Manufacturer	Type No.	Serial No	Cali. Due Date
PSA Series Spectrum Analyzer	Agilent	E4440A	MY49420184	2012.04.10
Radio Communication Tester	R&S	CMU 200	117088	2012.04.29
Dual Directional Coupler	Agilent	778D	20160	2012.04.20
10dB Coaxial Coupler	Agilent	87300C	MY44300299	2012.04.20
PSG Analog Signal Generator	Agilent	E8257D	MY44321116	2012.04.23
Preamplifier	QuieTek	AP-025C	CHM-0503006	2012.05.05
Preamplifier	Miteq	NSP1800-25	1364185	2012.05.05
Bilog Antenna	Teseq GmbH	CBL6112D	27612	2011.10.18
Half Wave Tuned Dipole Antenna	COM-POWER	AD-100	40137	2011.11.24
Broad-Band Horn Antenna	Schwarzbeck	BBHA9120D	737	2011.11.24
Broad-Band Horn Antenna	Schwarzbeck	BBHA9120D	499	2012.06.11
Temperature/Humidity Meter	Zhicheng	ZC1-2	AC5-TH	2012.01.14

### 3.2. Test Setup

Conducted Power Measurement:

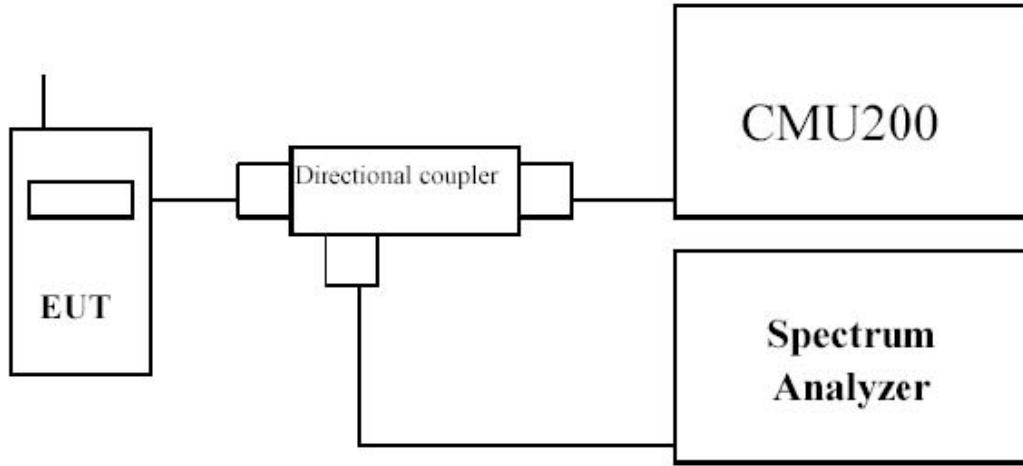

Radiated Power Measurement:

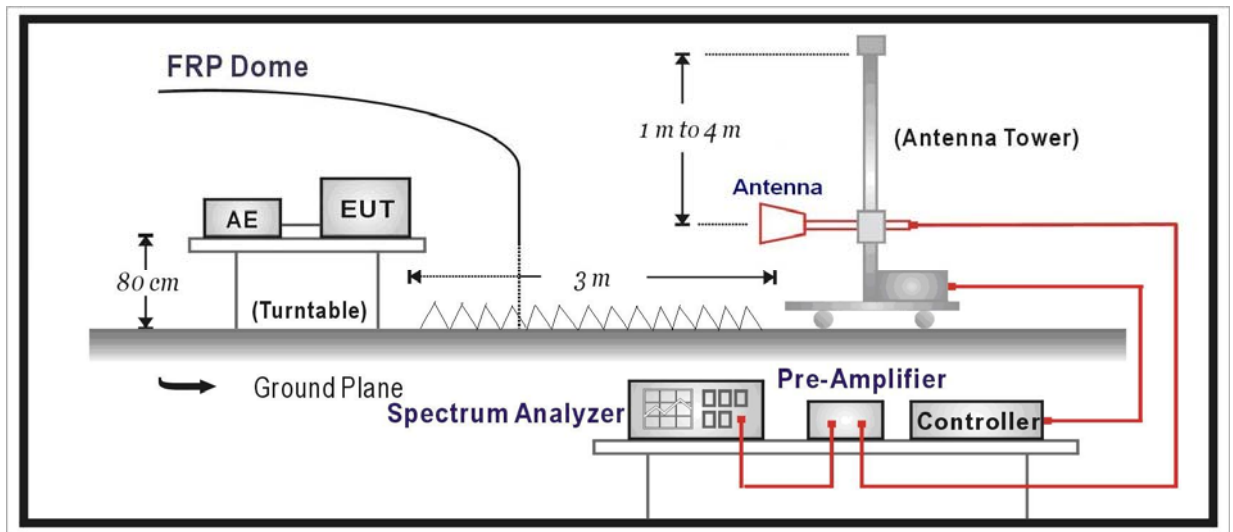

### 3.3. Limit

**For FCC Part 22.913(a)(2):**

The ERP of mobile transmitters and auxiliary test transmitters must not exceed 7 Watts.

**For FCC Part 24.232(b):**

The EIRP of mobile transmitters and auxiliary test transmitters must not exceed 2 Watts.

### 3.4. Test Procedure

## **Conducted Power Measurement:**

- a) Place the EUT on a bench and set it in transmitting mode.
- b) Connect a low loss RF cable from the antenna port to a spectrum analyzer and CMU200 by a Directional Couple.
- c) EUT Communicate with CMU200, then selects a channel for testing.
- d) Add a correction factor to the display of spectrum, and then test.

## **Radiated Power Measurement:**

- e) The EUT shall be placed at the specified height on a support, and in the position closest to normal use as declared by provider.
- f) The test antenna shall be oriented initially for vertical polarization and shall be chosen to correspond to the frequency of the transmitter
- g) The output of the test antenna shall be connected to the measuring receiver.
- h) The transmitter shall be switched on and the measuring receiver shall be tuned to the frequency of the transmitter under test.
- i) The test antenna shall be raised and lowered through the specified range of height until a maximum signal level is detected by the measuring receiver.
- j) The transmitter shall then be rotated through 360° in the horizontal plane, until the maximum signal level is detected by the measuring receiver.
- k) The test antenna shall be raised and lowered again through the specified range of height until a maximum signal level is detected by the measuring receiver.
- l) The maximum signal level detected by the measuring receiver shall be noted.
- m) The transmitter shall be replaced by a substitution antenna.
- n) The substitution antenna shall be orientated for vertical polarization and the length of the substitution antenna shall be adjusted to correspond to the frequency of the transmitter.
- o) The substitution antenna shall be connected to a calibrated signal generator.
- p) If necessary, the input attenuator setting of the measuring receiver shall be adjusted in order to increase the sensitivity of the measuring receiver.
- q) The test antenna shall be raised and lowered through the specified range of height to ensure that the maximum signal is received.
- r) The input signal to the substitution antenna shall be adjusted to the level that produces a level detected by the measuring receiver, that is equal to the level noted while the transmitter radiated power was measured, corrected for the change of input attenuator setting of the measuring receiver.
- s) The measurement shall be repeated with the test antenna and the substitution antenna orientated for horizontal polarization.
- t) The measure of the effective radiated power is the larger of the two levels recorded at the input to the substitution antenna, corrected for gain of the substitution antenna if

necessary.

- u) Test site anechoic chamber refer to ANSI C63.4: 2009.

### **3.5. Uncertainty**

The measurement uncertainty is defined as for Conducted Power Measurement  $\pm 1.2$  dB,  
for Radiated Power Measurement  $\pm 3.2$  dB



3.6. Test Result

Table 1

No. of timeslots	1	2	3	4
Duty Cycle	1 : 8	1 : 4	1 : 2.66	1 : 2
Timebased avg. power compared to slotted avg. power	-9 dB	-6 dB	-4.25 dB	-3 dB

This device just supports GPRS Class 10 with maximum 2 slots uplink.

The following table shows the conducted power measured and time based average power calculated:

Table 2

GSM850

Channel No.	Frequency (MHz)	Modulation	Avg. Burst Power (dBm)	Duty Cycle Factor (dB)	Frame Power (dBm)	ERP (dBm)	Limit (dBm)
128	824.2	GMSK	31.82	-9	22.82	27.93	38.50
189	836.4	GMSK	31.80	-9	22.80	28.09	38.50
251	848.8	GMSK	31.63	-9	22.63	28.31	38.50

PCS1900

Channel No.	Frequency (MHz)	Modulation	Avg. Burst Power (dBm)	Duty Cycle Factor (dB)	Frame Power (dBm)	EIRP (dBm)	Limit (dBm)
512	1850.2	GMSK	29.23	-9	20.23	26.51	33.00
661	1880.0	GMSK	28.97	-9	19.97	25.15	33.00
810	1909.8	GMSK	28.67	-9	19.67	24.11	33.00

GPRS850

Channel No.	Frequency (MHz)	Modulation	Avg. Burst Power (dBm)	Duty Cycle Factor (dB)	Frame Power (dBm)	ERP (dBm)	Limit (dBm)
128	824.2	GMSK	31.75	-9	22.75	27.85	38.50
189	836.4	GMSK	31.70	-9	22.70	27.91	38.50
251	848.8	GMSK	31.57	-9	22.57	28.30	38.50

GPRS1900

Channel No.	Frequency (MHz)	Modulation	Avg. Burst Power (dBm)	Duty Cycle Factor (dB)	Frame Power (dBm)	EIRP (dBm)	Limit (dBm)
512	1850.2	GMSK	29.22	-9	20.22	26.48	33.00
661	1880.0	GMSK	28.97	-9	19.97	24.80	33.00
810	1909.8	GMSK	28.66	-9	19.66	23.79	33.00

Radiated Measurement

GSM850

Frequency (MHz)	SA Reading (dBm)	Ant. Pol. (H/V)	SG Reading (dBm)	Cable Loss (dB)	Gain (dBd)	ERP (dBm)	Limit (dBm)	Margin (dB)
Low Channel 128 (824.20MHz)								
824.2	-7.55	H	26.21	1.76	-0.02	24.43	38.50	-14.07
824.2	-4.79	V	29.71	1.76	-0.02	27.93	38.50	-10.57
Middle Channel 189 (836.40MHz)								
836.4	-8.22	H	25.67	1.75	0.10	24.02	38.50	-14.48
836.4	-5.02	V	29.74	1.75	0.10	28.09	38.50	-10.41
High Channel 251 (848.80MHz)								
848.8	-7.26	H	26.76	1.78	0.13	25.11	38.50	-13.39
848.8	-4.65	V	29.96	1.78	0.13	28.31	38.50	-10.19

PCS1900

Frequency (MHz)	SA Reading (dBm)	Ant. Pol. (H/V)	SG Reading (dBm)	Cable Loss (dB)	Gain (dBi)	EIRP (dBm)	Limit (dBm)	Margin (dB)
Low Channel 512 (1850.20MHz)								
1850.2	16.93	H	15.00	2.68	10.40	22.72	33.00	-10.28
1850.2	20.91	V	18.79	2.68	10.40	26.51	33.00	-6.49
Middle Channel 661 (1880.00MHz)								
1880.0	13.86	H	11.91	2.68	10.43	19.66	33.00	-13.34
1880.0	19.69	V	17.40	2.68	10.43	25.15	33.00	-7.85
High Channel 810 (1909.80MHz)								
1909.8	14.11	H	12.34	2.70	10.44	20.08	33.00	-12.92
1909.8	20.58	V	16.37	2.70	10.44	24.11	33.00	-8.89

GPRS850

Frequency (MHz)	SA Reading (dBm)	Ant. Pol. (H/V)	SG Reading (dBm)	Cable Loss (dB)	Gain (dBd)	ERP (dBm)	Limit (dBm)	Margin (dB)
Low Channel 128 (824.20MHz)								
824.2	-7.84	H	25.91	1.76	-0.02	24.13	38.50	-14.37
824.2	-4.86	V	29.63	1.76	-0.02	27.85	38.50	-10.65
Middle Channel 189 (836.40MHz)								
836.4	-8.22	H	25.67	1.75	0.10	24.02	38.50	-14.48
836.4	-5.20	V	29.56	1.75	0.10	27.91	38.50	-10.59
High Channel 251 (848.80MHz)								
848.8	-7.08	H	27.53	1.78	0.13	25.88	38.50	-12.62
848.8	-4.67	V	29.95	1.78	0.13	28.30	38.50	-10.20

GPRS1900

Frequency (MHz)	SA Reading (dBm)	Ant .Pol. (H/V)	SG Reading (dBm)	Cable Loss (dB)	Gain (dBi)	EIRP (dBm)	Limit (dBm)	Margin (dB)
Low Channel 512 (1850.20MHz)								
1850.2	14.93	H	13.00	2.68	10.40	20.72	33.00	-12.28
1850.2	20.88	V	18.76	2.68	10.40	26.48	33.00	-6.52
Middle Channel 661 (1880.00MHz)								
1880.0	13.47	H	11.52	2.68	10.43	19.27	33.00	-13.73
1880.0	19.33	V	17.05	2.68	10.43	24.80	33.00	-8.20
High Channel 810 (1909.80MHz)								
1909.8	13.82	H	11.85	2.70	10.44	19.59	33.00	-13.41
1909.8	20.27	V	16.05	2.70	10.44	23.79	33.00	-9.21

**3.7. Test Photograph**

Description: ERP Test Setup

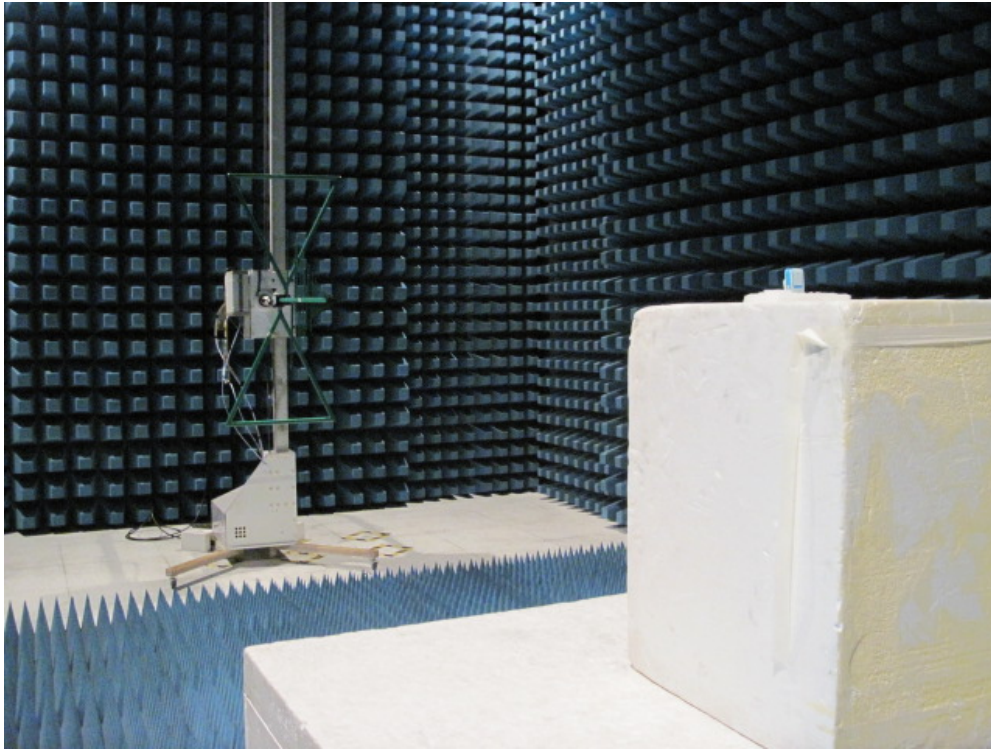

Description: Substitution Antenna for ERP Test

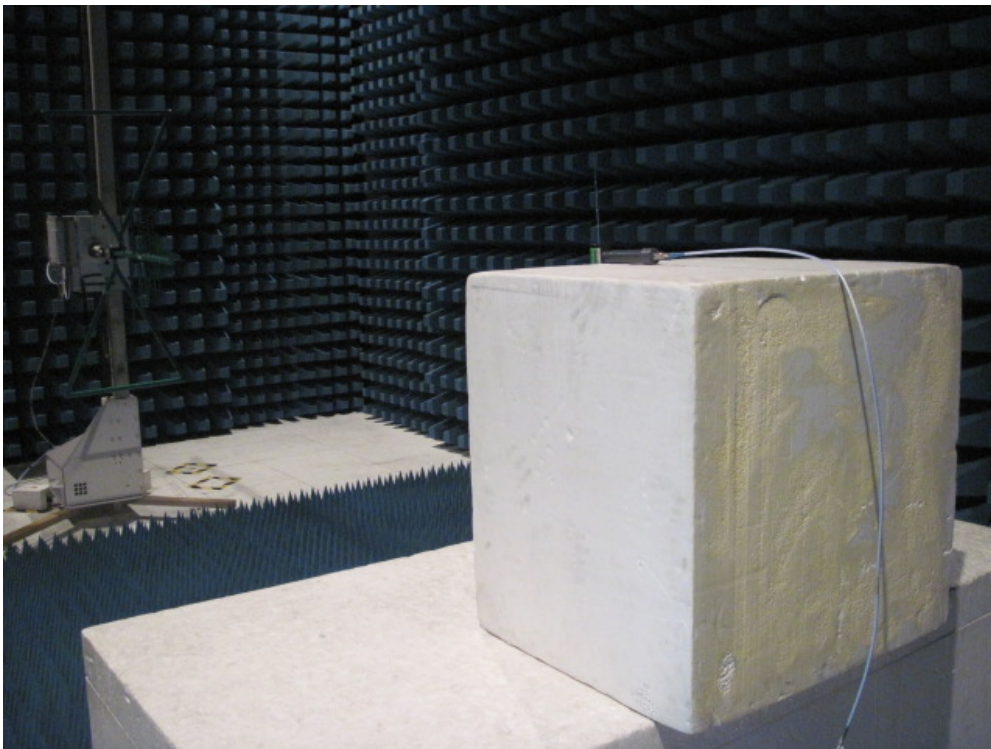

Description: EIRP Test Setup



Description: Substitution Antenna for EIRP Test



Description: Conducted Output Power Measurement Setup



## 4. Modulation Characteristic

### 4.1. Test Equipment

Modulation Characteristic / AC-6

Instrument	Manufacturer	Type No.	Serial No	Cal. Date
PSA Series Spectrum Analyzer	Agilent	E4440A	MY49420184	2012.04.10
Radio Communication Tester	R&S	CMU 200	117088	2012.04.29
Dual Directional Coupler	Agilent	778D	20160	2012.04.20
10dB Coaxial Coupler	Agilent	87300C	MY44300299	2012.04.20
Temperature/Humidity Meter	Zhicheng	ZC1-2	AC6-TH	2012.01.14

### 4.2. Test Setup

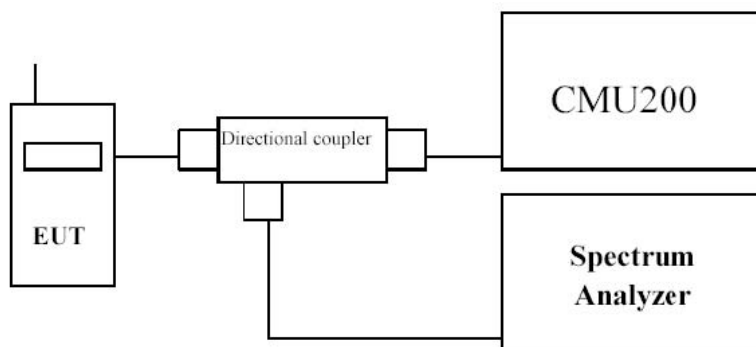



#### 4.3. Limit

N/A

#### 4.4. Test Procedure

GMSK is a form of binary signaling schemes which represent digital states as a shift between discrete sinusoidal frequencies called Frequency Shift Keying (FSK). Minimum Shift Keying (MSK) is continuous phase FSK with the smallest possible modulation index  $h$ . Modulation index is defined as:  $h = 2 \cdot F \cdot T_b$

where  $F$  = Peak frequency deviation in Hz and  $T_b$  = Bit period in seconds

Two discrete frequencies, representing two distinct digital states, with equal phases at switch time  $t = 0$  requires a minimum value of  $h = 0.5$ . The Gaussian part of GMSK describes the fact that the digital pulses are filtered in the time domain. This results in bits which are sinusoidal rather than square. The effective spectrum is then compressed with the average carrier frequency in the center of the passband. This is a great advantage because of the significantly reduced bandwidth. GMSK is utilized because of these bandwidth conservation properties.

The bandwidth for GSM is a 60 MHz up-link at 1850-1910 MHz and down-link at 1930-1990 MHz. The 65 MHz is divided into 299 channels, each of which is 200 kHz wide. Slight spectral spillage is allowed into neighboring channels (which is minimized by GMSK). This separated transmit/receive frequencies scheme under GSM enables easier duplex filtering.

Within the bandwidth, individual channels are subdivided into multiframes (made of 26 frames), frames (made of 8 time slots), and time slots (made of 8 fields). The time slots are 0.57 ms long allowing 156.25 bits of information including overhead.

The modulation used in GPRS is the same used in GSM. A GSM channel contains eight timeslots, each timeslot is dedicated to one circuit switched call. For GPRS the timeslots are assigned on an as needed basis, and more than one timeslot can be assigned for a particular transmission depending on the network and the device.

#### 4.5. Uncertainty

The measurement uncertainty is defined as 0.1%

4.6. Test Result

The modulation of GSM/GPRS were verified and confirmed compliance with requirement.

GSM 850

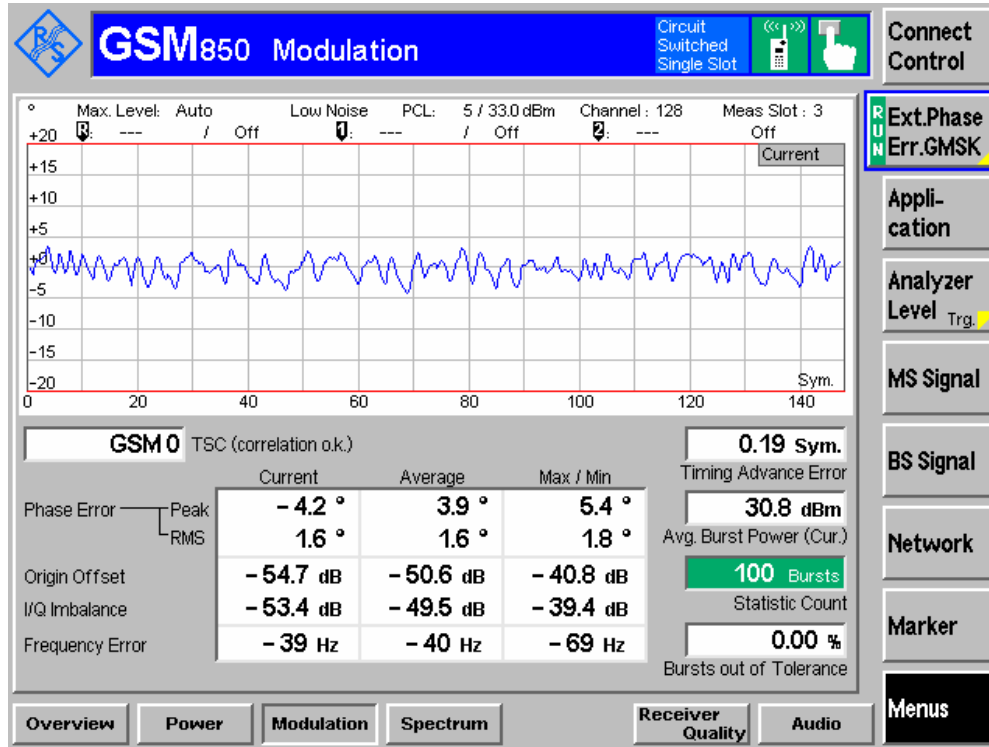

PCS 1900

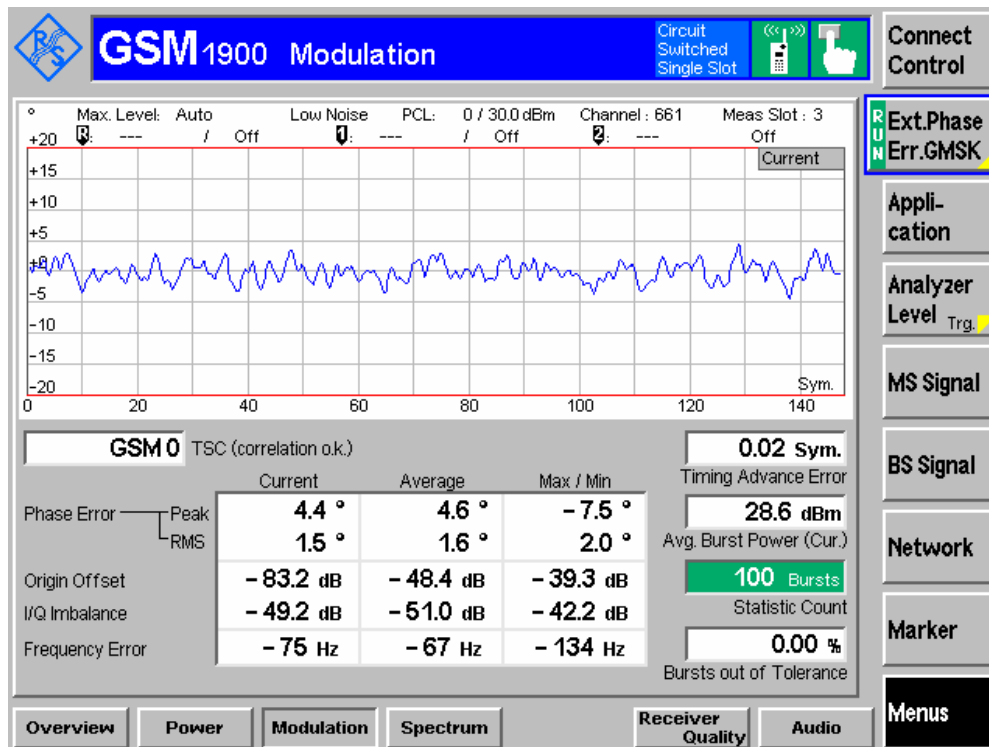

## 5. Occupied Bandwidth

### 5.1. Test Equipment

Occupied Bandwidth / AC-6

Instrument	Manufacturer	Type No.	Serial No	Cali. Due Date
PSA Series Spectrum Analyzer	Agilent	E4440A	MY49420184	2012.04.10
Radio Communication Tester	R&S	CMU 200	117088	2012.04.29
Dual Directional Coupler	Agilent	778D	20160	2012.04.20
10dB Coaxial Coupler	Agilent	87300C	MY44300299	2012.04.20
Temperature/Humidity Meter	Zhicheng	ZC1-2	AC6-TH	2012.01.14

### 5.2. Test Setup

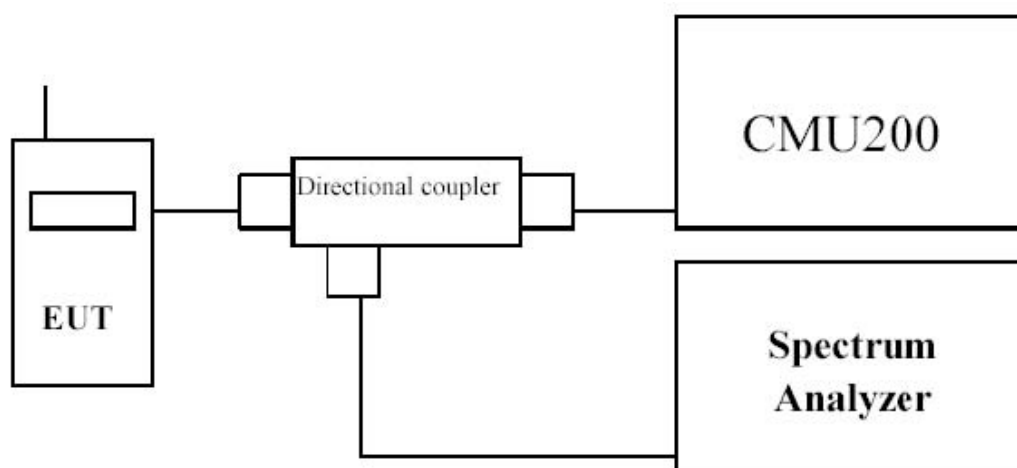

**5.3. Limit**

N/A

**5.4. Test Procedure**

Using Occupied Bandwidth measurement function of spectrum analyzer, and setting as follows:

For GSM 850/1900 test --- RBW = 3 kHz and VBW = 10 kHz

**5.5. Uncertainty**

The measurement uncertainty is defined as  $\pm 10$  Hz

## 5.6. Test Result

Product	eCare		
Test Item	Occupied Bandwidth		
Test Mode	Mode 1: GSM 850 Link		
Date of Test	2011/09/22	Test Site	AC-6

Channel No.	Frequency (MHz)	-26dB Occupied Bandwidth (kHz)	99% Occupied Bandwidth (kHz)
128	824.20	317.23	252.02
189	836.40	316.21	247.82
251	848.80	316.09	247.54

Figure Channel 128 (824.20MHz)

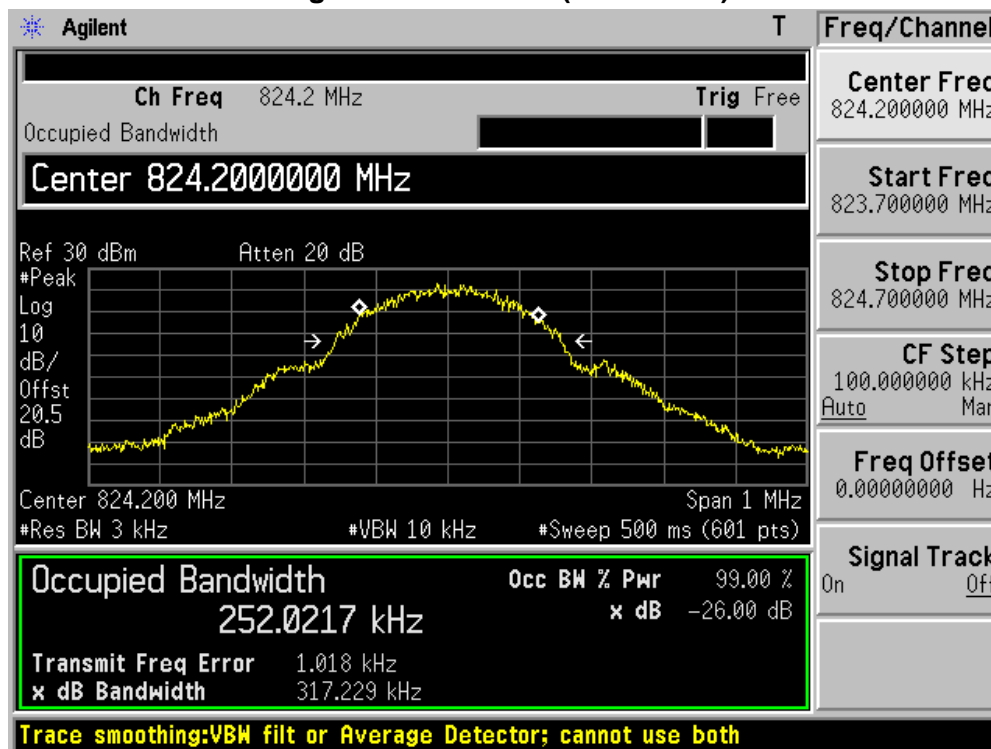

Figure Channel 189 (836.40MHz)

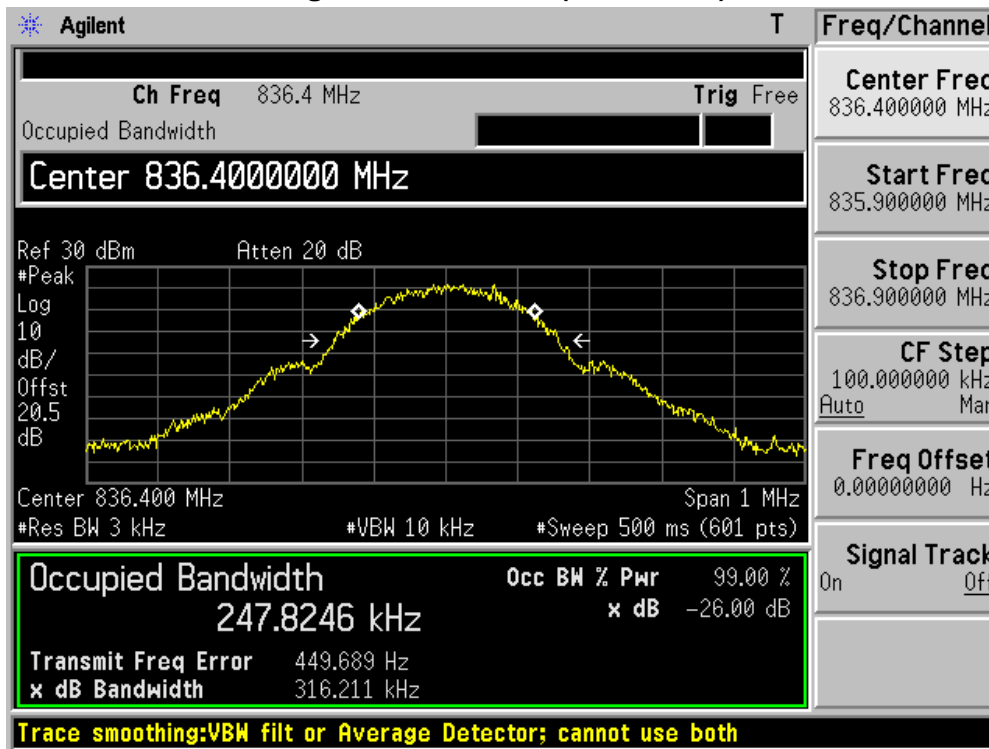
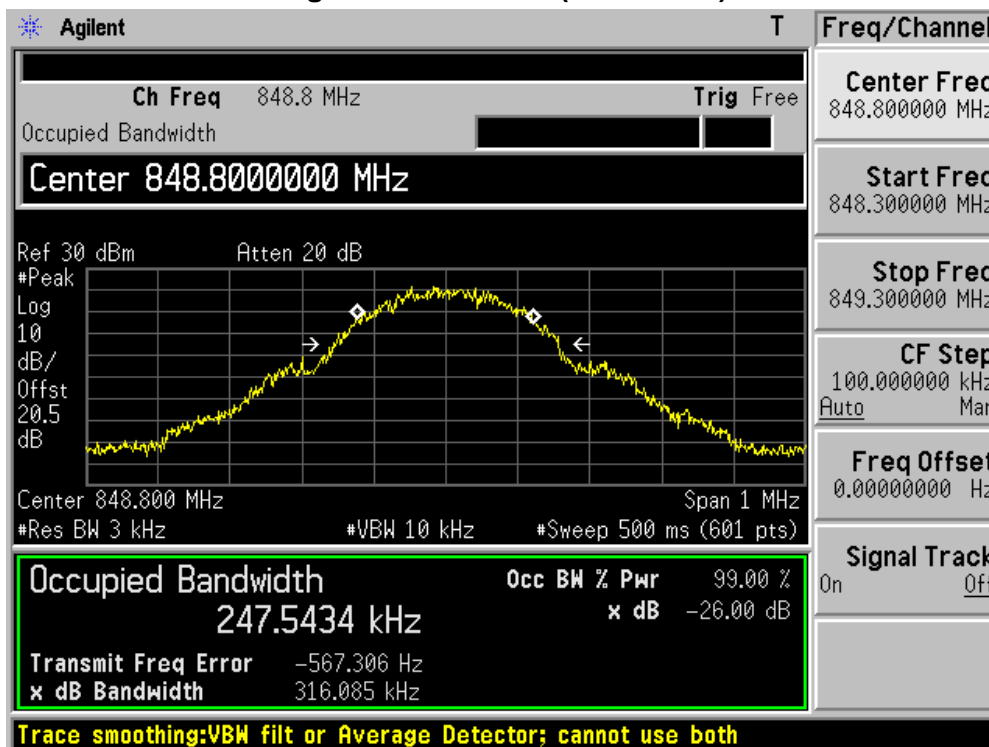

Figure Channel 251 (848.80MHz)



Product	eCare		
Test Item	Occupied Bandwidth		
Test Mode	Mode 2: PCS 1900 Link		
Date of Test	2011/09/22	Test Site	AC-6

Channel No.	Frequency (MHz)	-26dB Occupied Bandwidth (kHz)	99% Occupied Bandwidth (kHz)
512	1850.20	306.31	247.36
661	1880.00	319.93	250.25
810	1909.80	311.11	245.41

**Figure Channel 512 (1850.20MHz)**

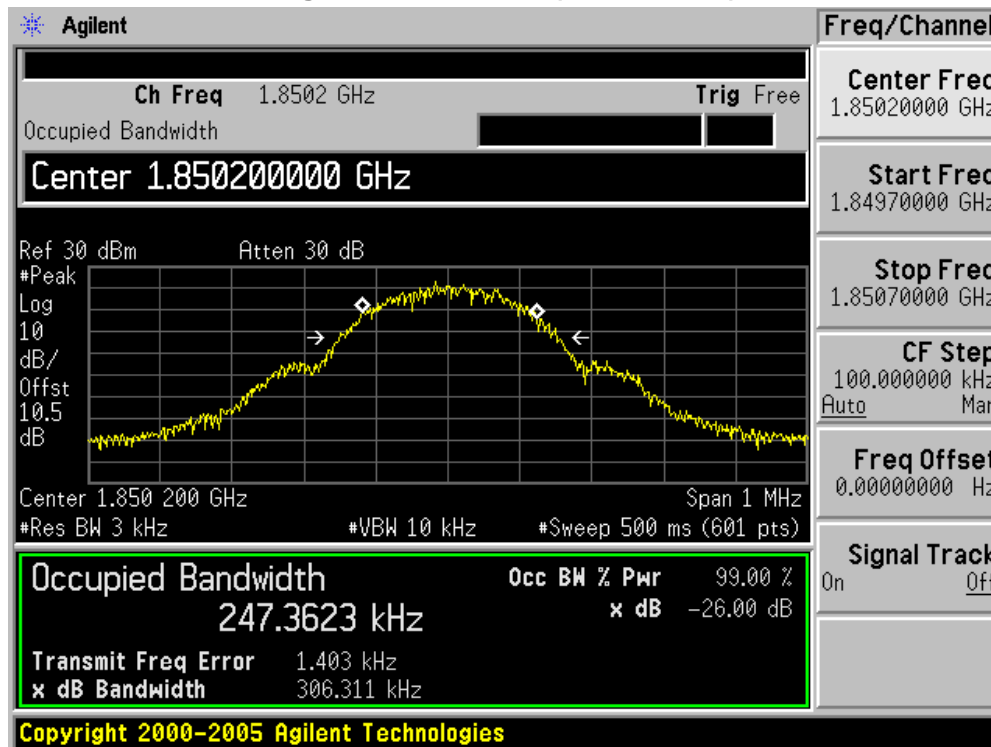

Figure Channel 661 (1880.00MHz)

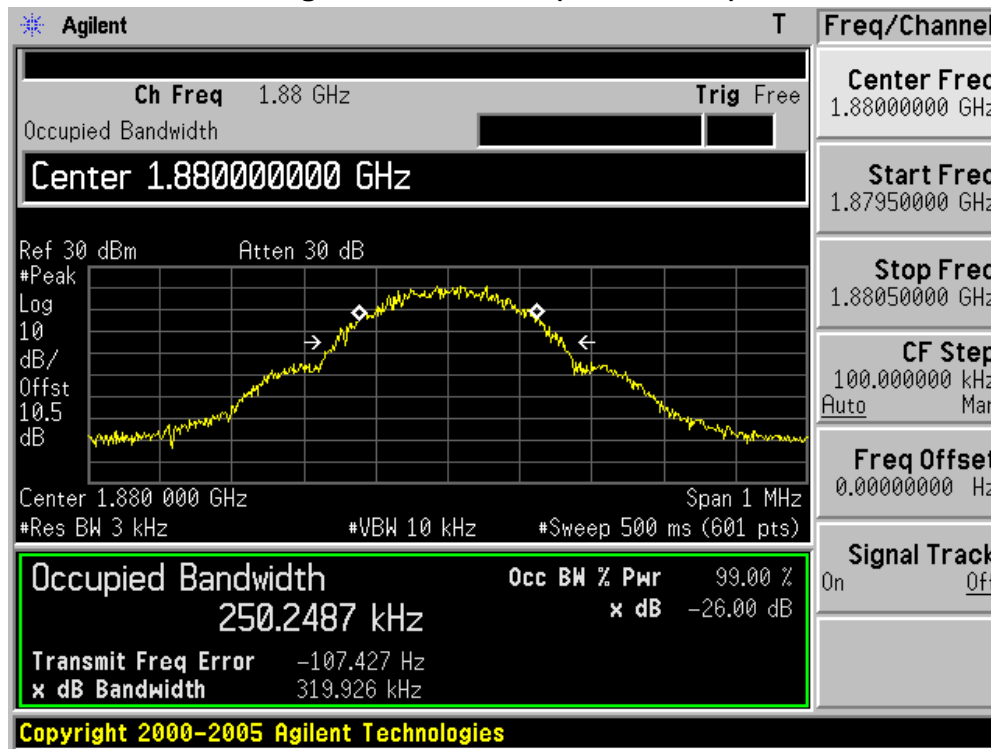

Figure Channel 810 (1909.80MHz)





**6. Spurious Emission At Antenna Terminals (+/- 1MHz)**

**6.1. Test Equipment**

Spurious Emission At Antenna Terminals (+/- 1MHz) / AC-6

Instrument	Manufacturer	Type No.	Serial No	Cali. Due Date
PSA Series Spectrum Analyzer	Agilent	E4440A	MY49420184	2012.04.10
Radio Communication Tester	R&S	CMU 200	117088	2012.04.29
Dual Directional Coupler	Agilent	778D	20160	2012.04.20
10dB Coaxial Coupler	Agilent	87300C	MY44300299	2012.04.20
Temperature/Humidity Meter	Zhicheng	ZC1-2	AC6-TH	2012.01.14

**6.2. Test Setup**

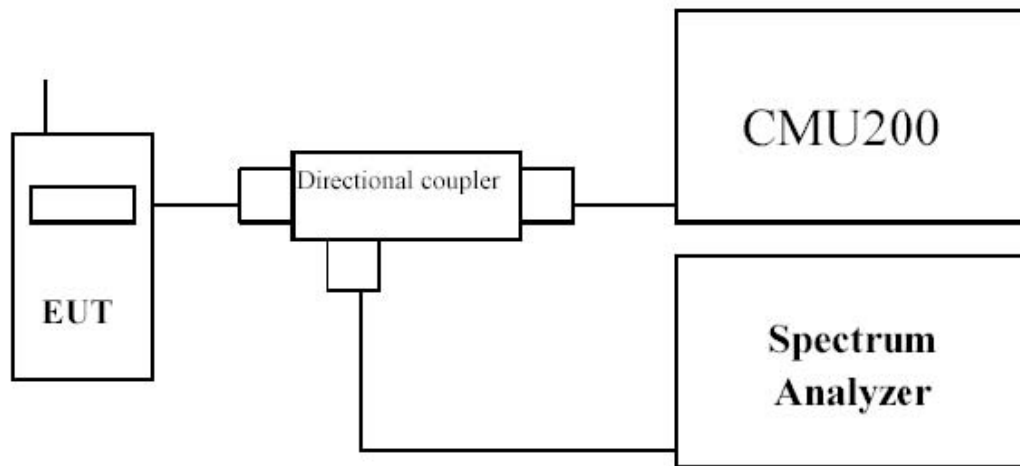

### **6.3. Limit**

The power of any emission outside of the authorized operating frequency ranges must be attenuated below the transmitting power (P) by a factor of at least  $43 + 10\log(P)$  dB.

### **6.4. Test Procedure**

In the 1MHz bands immediately outside and adjacent to the frequency block a resolution bandwidth of at least one percent of the emission bandwidth of the fundamental emission of the transmitter may be employed to measure the out of band Emissions.

### **6.5. Uncertainty**

The measurement uncertainty is defined as  $\pm 1.2$  dB.

## 6.6. Test Result

Product	eCare		
Test Item	Spurious Emission At Antenna Terminals (+/- 1MHz)		
Test Mode	Mode 1: GSM 850 Link		
Date of Test	2011/09/22	Test Site	AC-6

Figure Channel 128 (824.20MHz)

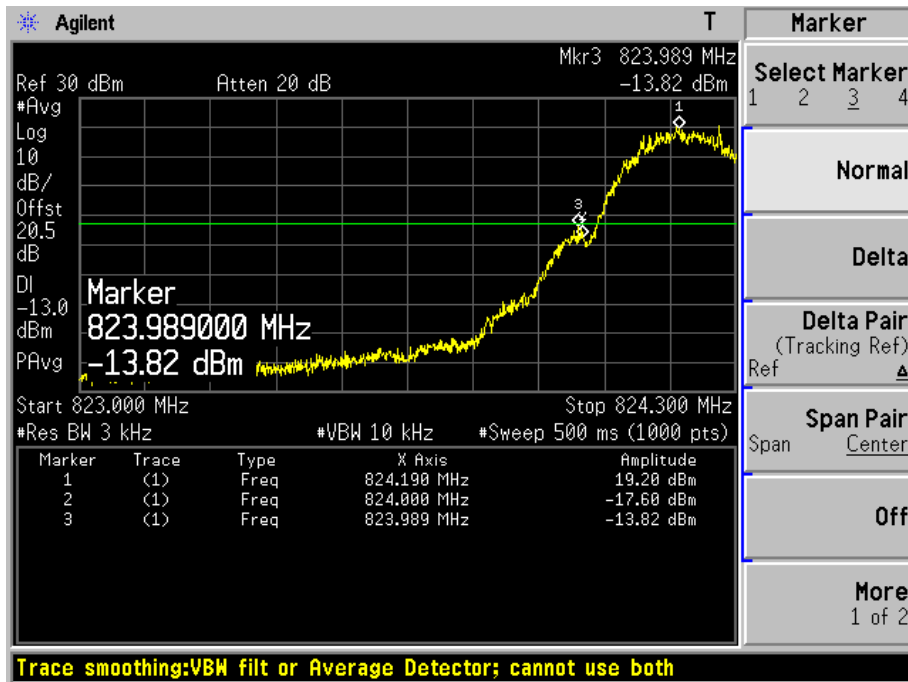
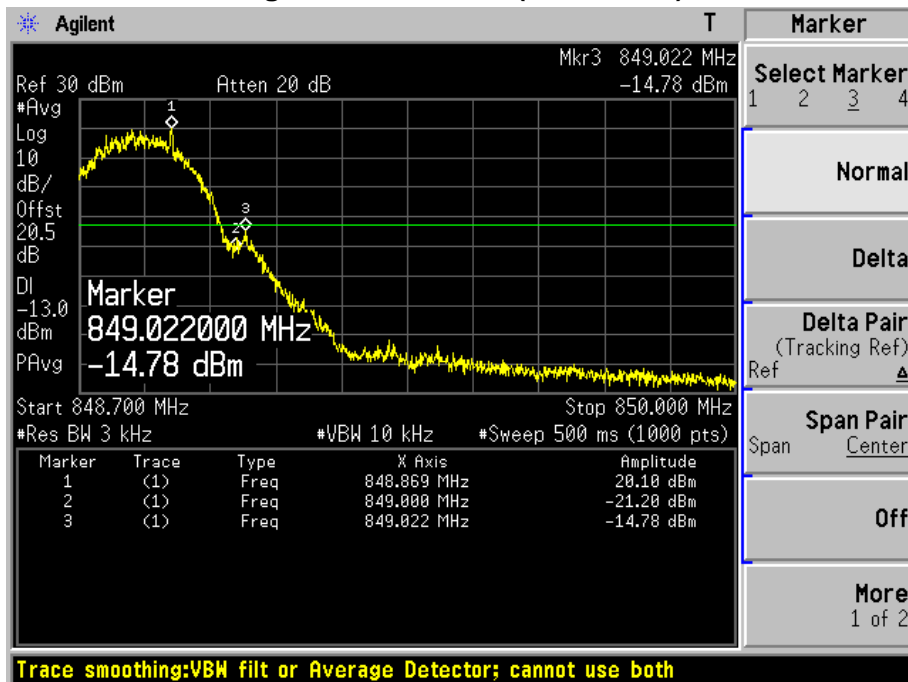
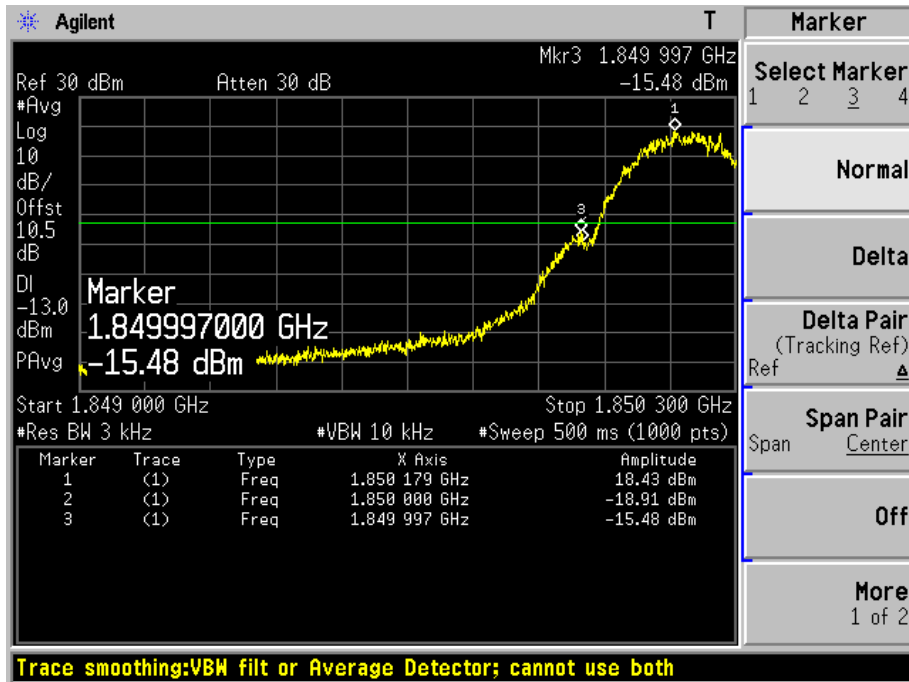

Figure Channel 251 (848.80MHz)



Product	eCare		
Test Item	Spurious Emission At Antenna Terminals (+/- 1MHz)		
Test Mode	Mode 2: PCS 1900 Link		
Date of Test	2011/09/22	Test Site	AC-6

**Figure Channel 512 (1850.20MHz)**



**Figure Channel 810 (1909.80MHz)**

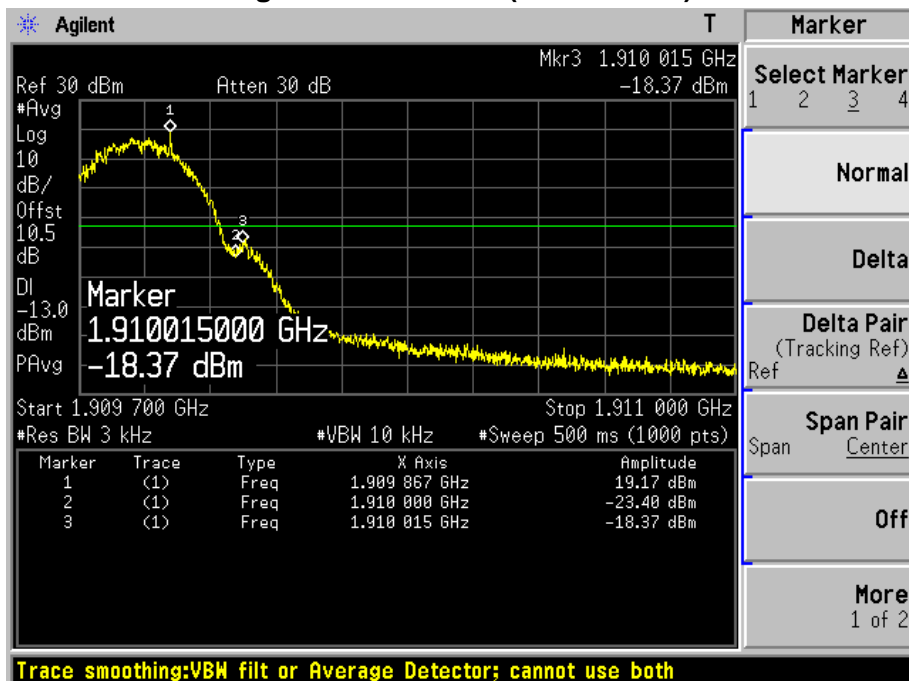

**7. Spurious Emission**

**7.1. Test Equipment**

Spurious Emission / AC-5

Instrument	Manufacturer	Type No.	Serial No	Cali. Due Date
PSA Series Spectrum Analyzer	Agilent	E4440A	MY49420184	2012.04.10
Radio Communication Tester	R&S	CMU 200	117088	2012.04.29
Dual Directional Coupler	Agilent	778D	20160	2012.04.20
10dB Coaxial Coupler	Agilent	87300C	MY44300299	2012.04.20
PSG Analog Signal Generator	Agilent	E8257D	MY44321116	2012.04.23
Preamplifier	QuieTek	AP-025C	CHM-0503006	2012.05.05
Preamplifier	Miteq	NSP1800-25	1364185	2012.05.05
Bilog Antenna	Teseq GmbH	CBL6112D	27612	2011.10.18
Half Wave Tuned Dipole Antenna	COM-POWER	AD-100	40137	2011.11.24
Broad-Band Horn Antenna	Schwarzbeck	BBHA9120D	737	2011.11.24
Broad-Band Horn Antenna	Schwarzbeck	BBHA9120D	499	2012.06.11
Temperature/Humidity Meter	Zhicheng	ZC1-2	AC5-TH	2012.01.14

### 7.2. Test Setup

Radiated Spurious Measurement: below 1GHz

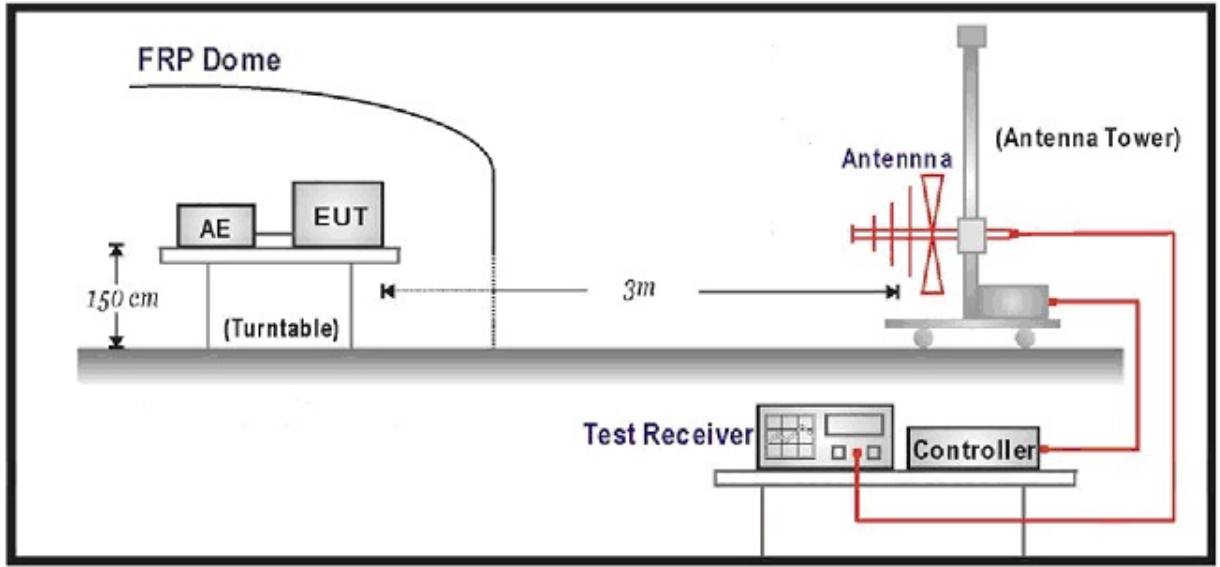

Radiated Spurious Measurement: above 1GHz

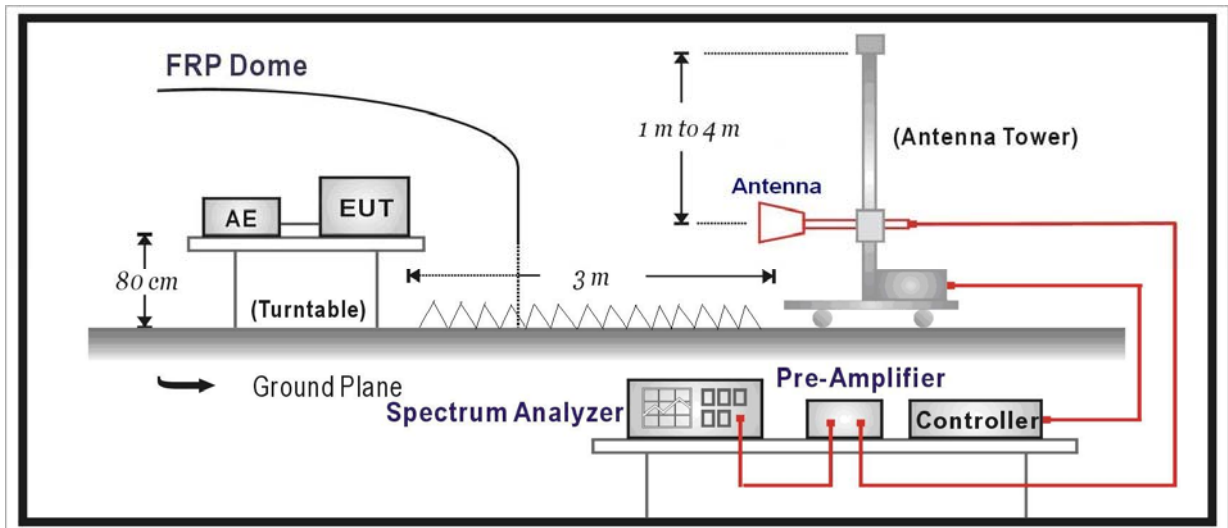

### 7.3. Limit

The power of any emission outside of the authorized operating frequency ranges must be attenuated below the transmitting power (P) by a factor of at least  $43 + 10\log(P)$  dB.

### 7.4. Test Procedure

### **Conducted Spurious Measurement:**

- a) Place the EUT on a bench and set it in transmitting mode.
- b) Connect a low loss RF cable from the antenna port to a spectrum analyzer and CMU200 by a Directional Couple.
- c) EUT Communicate with CMU200, then select a channel for testing.
- d) Add a correction factor to the display of spectrum, and then test.
- e) The resolution bandwidth of the spectrum analyzer was set at 1 MHz, sufficient scans were taken to show the out of band Emission if any up to 10<sup>th</sup> harmonic.

### **Radiated Spurious Measurement:**

- a) The EUT shall be placed at the specified height on a support, and in the position closest to normal use as declared by provider.
- b) The test antenna shall be oriented initially for vertical polarization and shall be chosen to correspond to the frequency of the transmitter
- c) The output of the test antenna shall be connected to the measuring receiver.
- d) The transmitter shall be switched on and the measuring receiver shall be tuned to the frequency of the transmitter under test.
- e) The test antenna shall be raised and lowered through the specified range of height until a maximum signal level is detected by the measuring receiver.
- f) The transmitter shall then be rotated through 360° in the horizontal plane, until the maximum signal level is detected by the measuring receiver.
- g) The test antenna shall be raised and lowered again through the specified range of height until a maximum signal level is detected by the measuring receiver.
- v) The maximum signal level detected by the measuring receiver shall be noted.
- h) The transmitter shall be replaced by a substitution antenna.
- i) The substitution antenna shall be orientated for vertical polarization and the length of the substitution antenna shall be adjusted to correspond to the frequency of the transmitter.
- j) The substitution antenna shall be connected to a calibrated signal generator.
- k) If necessary, the input attenuator setting of the measuring receiver shall be adjusted in order to increase the sensitivity of the measuring receiver.
- l) The test antenna shall be raised and lowered through the specified range of height to ensure that the maximum signal is received.
- m) The input signal to the substitution antenna shall be adjusted to the level that produces a level detected by the measuring receiver, that is equal to the level noted while the transmitter radiated power was measured, corrected for the change of input attenuator setting of the measuring receiver.
- n) The measurement shall be repeated with the test antenna and the substitution antenna

orientated for horizontal polarization.

- o) The measure of the effective radiated power is the larger of the two levels recorded at the input to the substitution antenna, corrected for gain of the substitution antenna if necessary.
- p) The frequency range was checked up to 10<sup>th</sup> harmonic.
- q) Test site anechoic chamber refer to ANSI C63.4: 2009

## **7.5. Uncertainty**

The measurement uncertainty is defined as 3.2 dB for Radiated Power Measurement.



**7.6. Test Result**

Product	eCare		
Test Item	Spurious Emission		
Test Mode	Mode 1: GSM 850 Link		
Date of Test	2011/09/22	Test Site	AC-5

**Below 1GHz**

Frequency (MHz)	SA Reading (dBm)	Ant.Pol. (H/V)	SG Reading (dBm)	Cable Loss (dB)	Gain (dBd)	ERP (dBm)	Limit (dBm)	Margin (dB)
Low Channel 128 (824.20MHz)								
256.50	-95.56	V	-68.59	1.45	0.04	-70.00	-13.00	-57.00
437.40	-96.99	V	-67.00	1.90	0.44	-68.46	-13.00	-55.46
256.50	-95.42	H	-67.48	1.45	0.04	-68.89	-13.00	-55.89
437.40	-95.97	H	-65.16	1.90	0.44	-66.62	-13.00	-53.62
Middle Channel 189 (836.40MHz)								
256.50	-95.23	V	-68.27	1.45	0.04	-69.68	-13.00	-56.68
437.40	-95.81	V	-65.83	1.90	0.44	-67.29	-13.00	-54.29
256.50	-95.24	H	-67.30	1.45	0.04	-68.71	-13.00	-55.71
437.40	-94.38	H	-63.57	1.90	0.44	-65.03	-13.00	-52.03
High Channel 251 (848.80MHz)								
256.50	-95.09	V	-68.12	1.45	0.04	-69.53	-13.00	-56.53
437.40	-96.26	V	-66.28	1.90	0.44	-67.74	-13.00	-54.74
256.50	-95.53	H	-67.59	1.45	0.04	-69.00	-13.00	-56.00
437.40	-96.60	H	-65.79	1.90	0.44	-67.25	-13.00	-54.25

**Above 1GHz**

Frequency (MHz)	SA Reading (dBm)	Ant.Pol. (H/V)	SG Reading (dBm)	Cable Loss (dB)	Gain (dBi)	EIRP (dBm)	Limit (dBm)	Margin (dB)
Low Channel 128 (824.20MHz)								
1646.00	-45.62	V	-50.34	2.50	9.75	-43.09	-13.00	-30.09
2470.50	-57.88	V	-59.07	3.12	10.48	-51.71	-13.00	-38.71
1646.00	-53.87	H	-59.41	2.50	9.75	-52.16	-13.00	-39.16
2470.50	-42.32	H	-41.21	3.12	10.48	-33.85	-13.00	-20.85
Middle Channel 189 (836.40MHz)								
1671.50	-49.89	V	-50.27	2.52	9.95	-42.84	-13.00	-29.84
2513.00	-45.46	V	-58.13	3.18	10.62	-50.69	-13.00	-37.69

1671.50	-53.06	H	-57.63	2.52	9.95	-50.20	-13.00	-37.20
2513.00	-58.85	H	-59.93	3.18	10.62	-52.49	-13.00	-39.49
High Channel 251 (848.80MHz)								
1697.00	-42.22	V	-47.11	2.54	10.06	-39.59	-13.00	-26.59
2547.00	-55.89	V	-56.47	3.14	10.68	-48.93	-13.00	-35.93
1697.00	-52.27	H	-56.42	2.54	10.06	-48.90	-13.00	-35.90
2547.00	-57.97	H	-58.29	3.14	10.68	-50.75	-13.00	-37.75

Product	eCare		
Test Item	Spurious Emission		
Test Mode	Mode 2: PCS 1900 Link		
Date of Test	2011/09/22	Test Site	AC-5

**Below 1GHz**

Frequency (MHz)	SA Reading (dBm)	Ant.Pol. (H/V)	SG Reading (dBm)	Cable Loss (dB)	Gain (dBd)	ERP (dBm)	Limit (dBm)	Margin (dB)
<b>Low Channel 512 (1850.20MHz)</b>								
256.50	-93.85	V	-67.01	1.45	0.04	-68.42	-13.00	-55.42
437.40	-95.58	V	-65.76	1.90	0.44	-67.22	-13.00	-54.22
256.50	-94.27	H	-66.45	1.45	0.04	-67.86	-13.00	-54.86
437.40	-96.20	H	-66.13	1.90	0.44	-67.59	-13.00	-54.59
<b>Middle Channel 661 (1880.00MHz)</b>								
256.50	-94.57	V	-67.73	1.45	0.04	-69.14	-13.00	-56.14
437.40	-96.54	V	-66.72	1.90	0.44	-68.18	-13.00	-55.18
256.50	-94.55	H	-66.74	1.45	0.04	-68.15	-13.00	-55.15
437.40	-96.19	H	-65.54	1.90	0.44	-67.00	-13.00	-54.00
<b>High Channel 810 (1909.80MHz)</b>								
256.50	-95.30	V	-68.46	1.45	0.04	-69.87	-13.00	-56.87
437.40	-96.16	V	-66.34	1.90	0.44	-67.80	-13.00	-54.80
256.50	-67.75	H	-92.75	1.45	0.04	-94.16	-13.00	-81.16
437.40	-66.49	H	-94.22	1.90	0.44	-95.68	-13.00	-82.68

**Above 1GHz**

Frequency (MHz)	SA Reading (dBm)	Ant.Pol. (H/V)	SG Reading (dBm)	Cable Loss (dB)	Gain (dBi)	EIRP (dBm)	Limit (dBm)	Margin (dB)
<b>Low Channel 512 (1850.20MHz)</b>								
3703.00	-38.27	V	-36.96	3.84	12.69	-28.11	-13.00	-15.11
5547.50	-55.41	V	-49.06	4.82	13.15	-40.73	-13.00	-27.73
3703.00	-56.66	H	-55.44	3.84	12.69	-46.59	-13.00	-33.59
5547.50	-64.29	H	-58.14	4.82	13.15	-49.81	-13.00	-36.81
<b>Middle Channel 661 (1880.00MHz)</b>								
3762.50	-39.98	V	-38.91	3.73	12.72	-29.92	-13.00	-16.92
5641.00	-54.16	V	-48.38	4.93	13.14	-40.17	-13.00	-27.17

3762.50	-41.44	H	-40.29	3.73	12.72	-31.30	-13.00	-18.30
5641.00	-55.49	H	-49.63	4.93	13.14	-41.42	-13.00	-28.42
High Channel 810 (1909.80MHz)								
3822.00	-37.35	V	-35.78	4.02	12.73	-27.07	-13.00	-14.07
5726.00	-54.90	V	-48.44	4.87	13.11	-40.20	-13.00	-27.20
3822.00	-42.50	H	-40.78	4.02	12.73	-32.07	-13.00	-19.07
5726.00	-58.14	H	-52.05	4.87	13.11	-43.81	-13.00	-30.81

Product	eCare		
Test Item	Conducted Spurious Emission		
Test Mode	Mode 1: GSM 850 Link		
Date of Test	2011/09/22	Test Site	AC-5

Channel 128

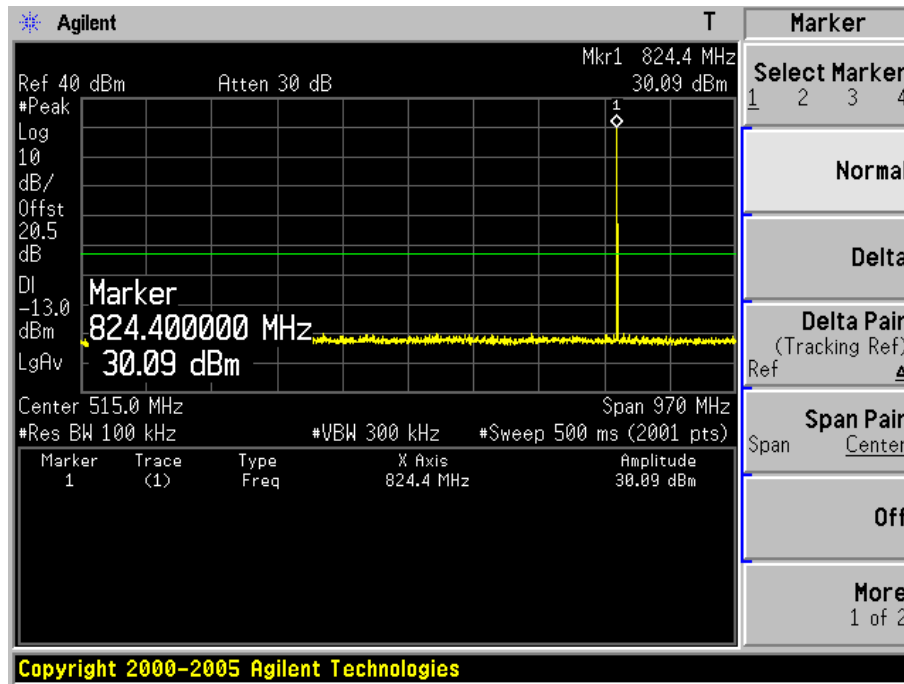

Channel 128

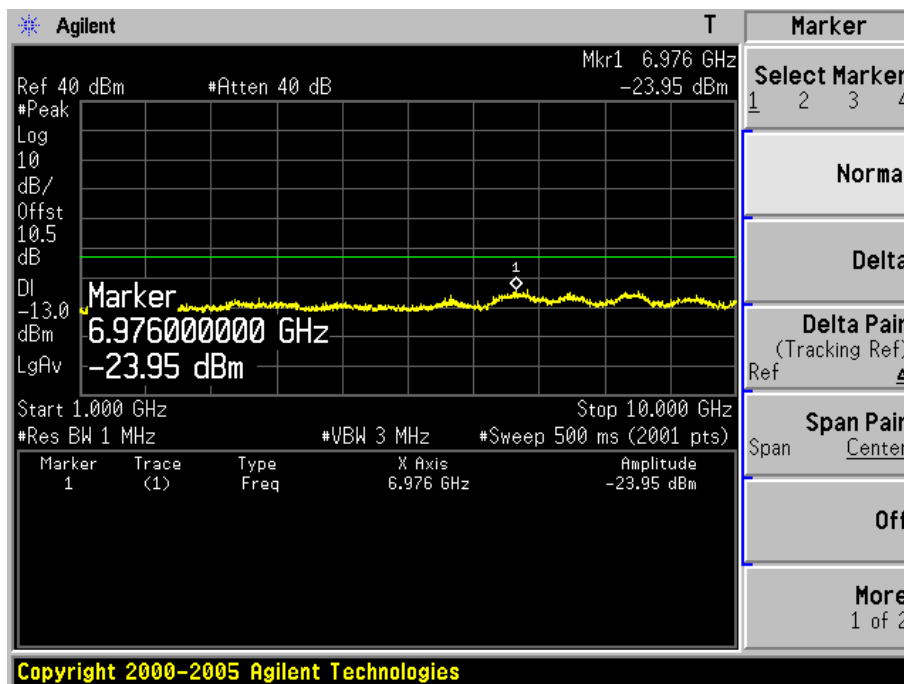

Channel 189

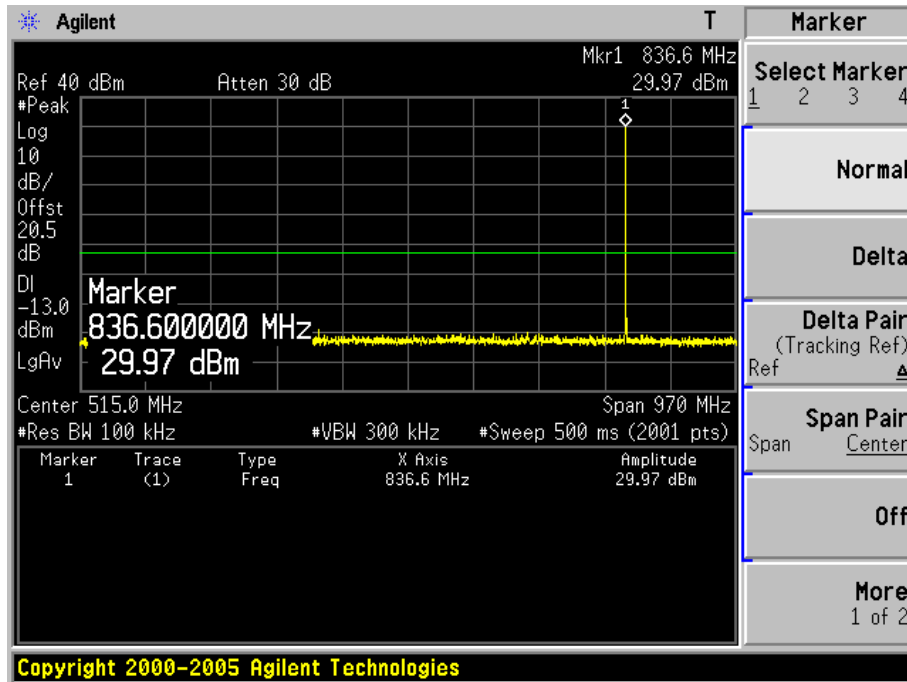

Channel 189

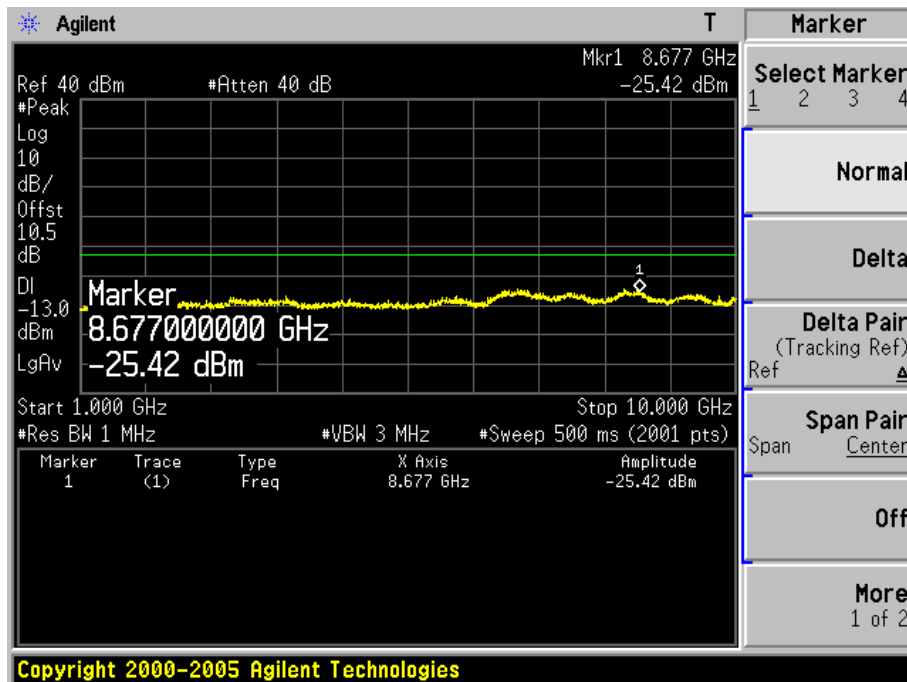

Channel 251

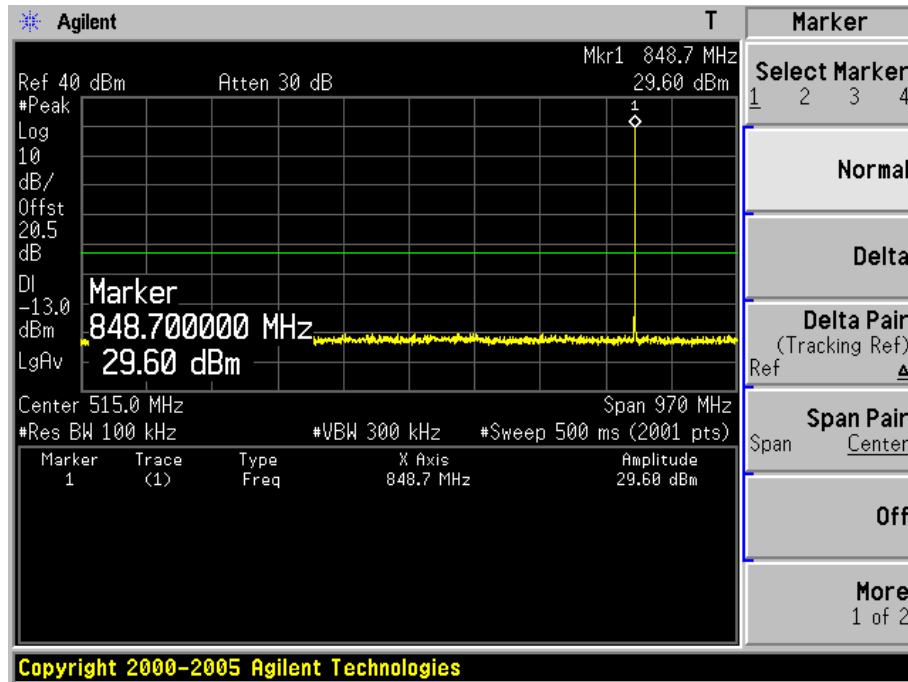

Channel 251

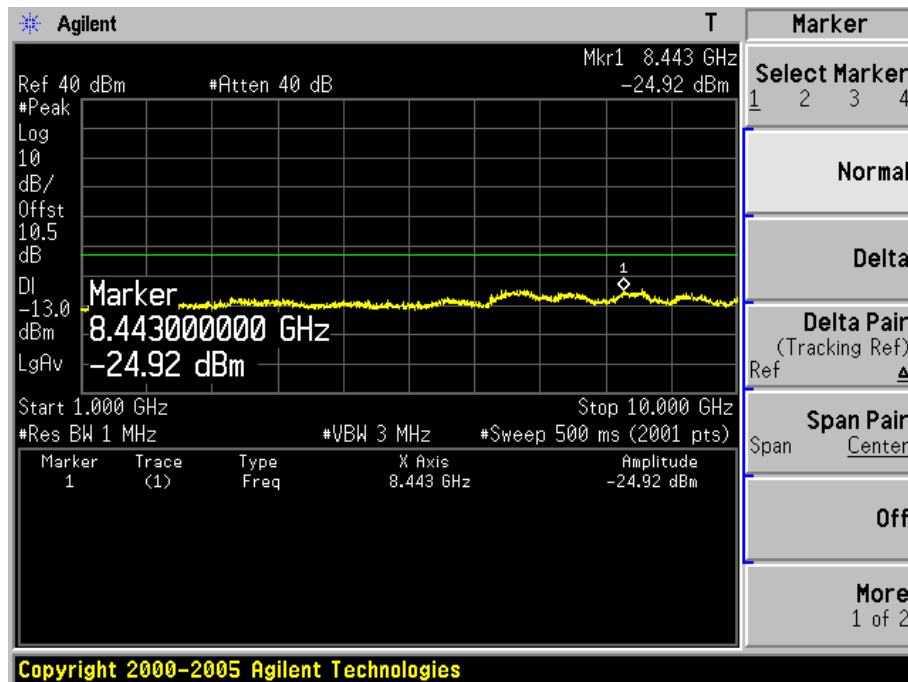

Product	eCare		
Test Item	Conducted Spurious Emission		
Test Mode	Mode 2: PCS 1900 Link		
Date of Test	2011/09/22	Test Site	AC-5

Channel 512

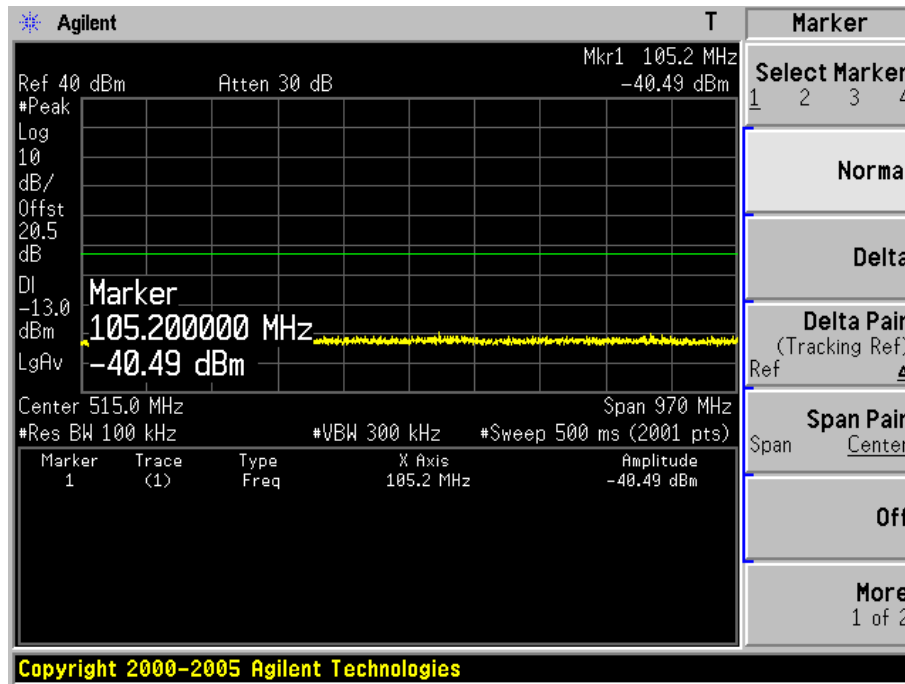

Channel 512

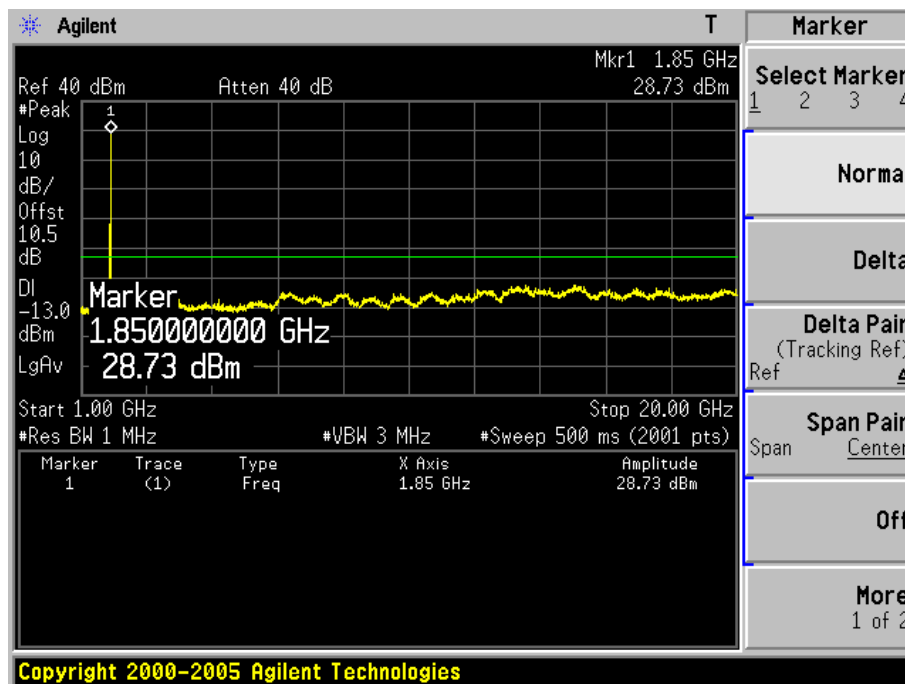



Channel 661

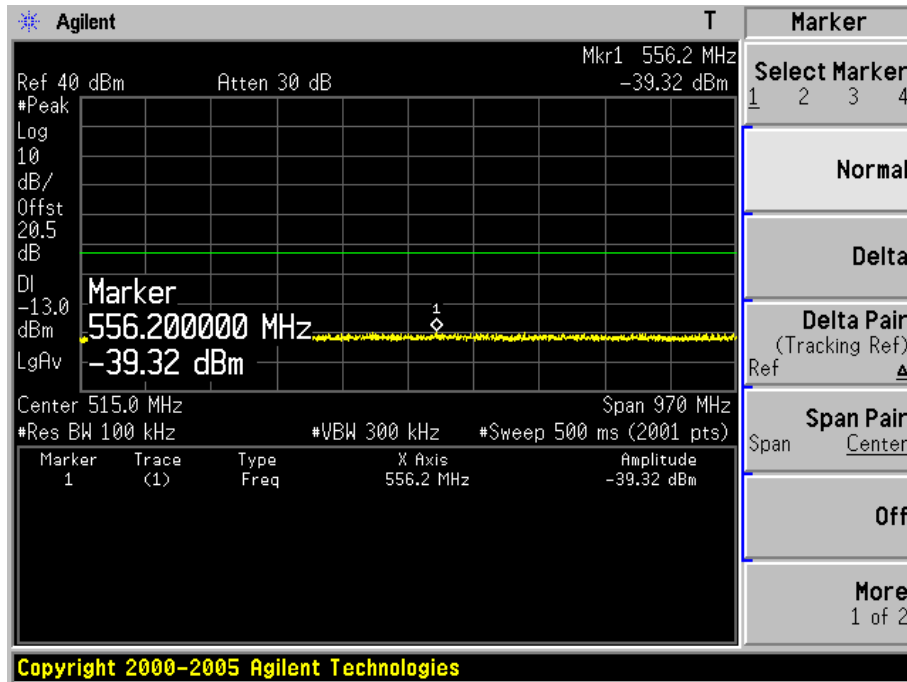

Channel 661

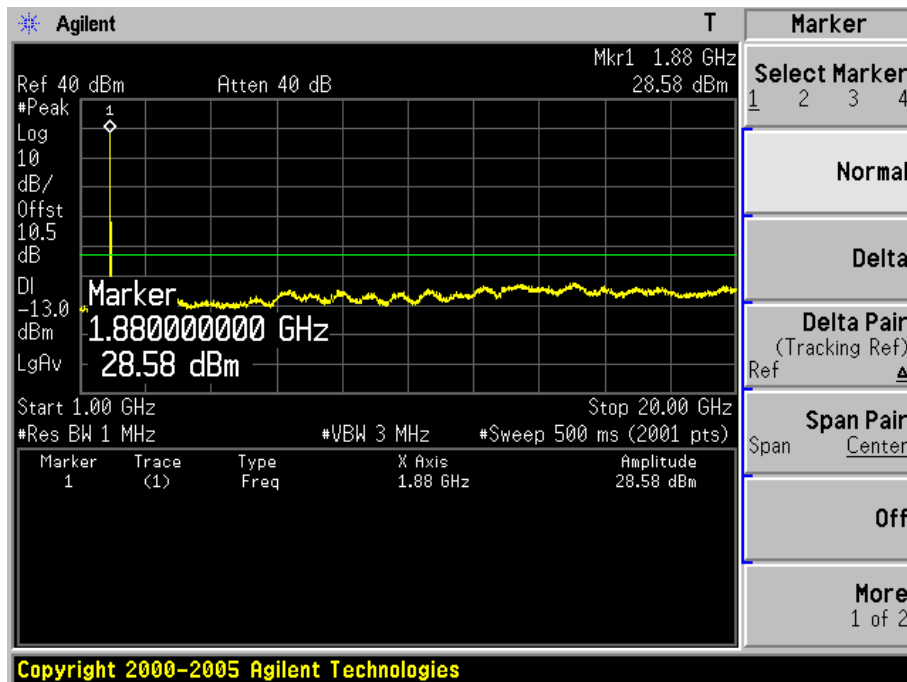

Channel 810

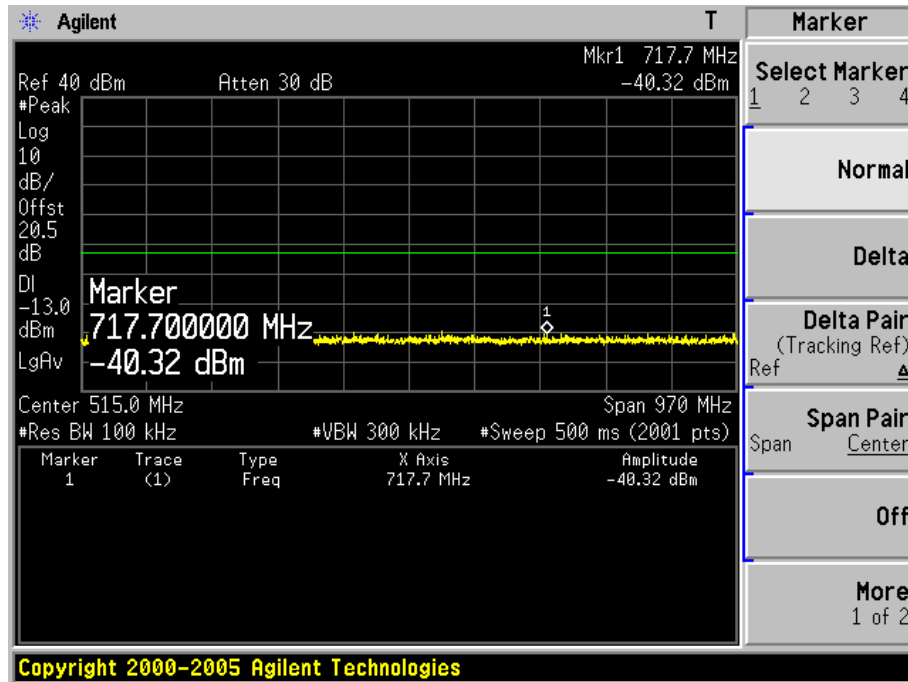

Channel 810

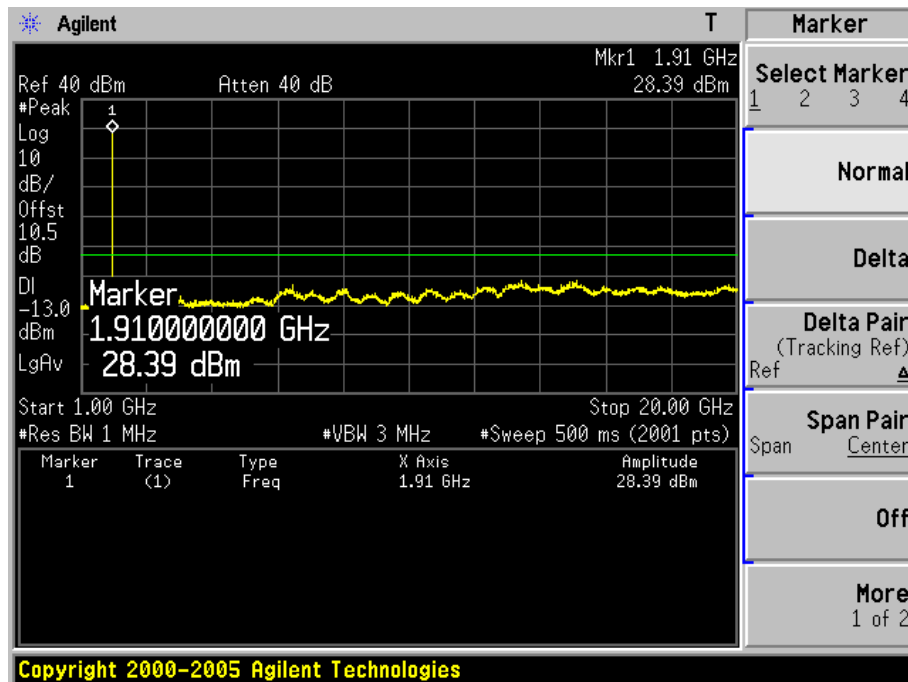

7.7. Test Photograph

Description: Conducted Spurious Emission Measurement Setup



Description: ERP Test Setup

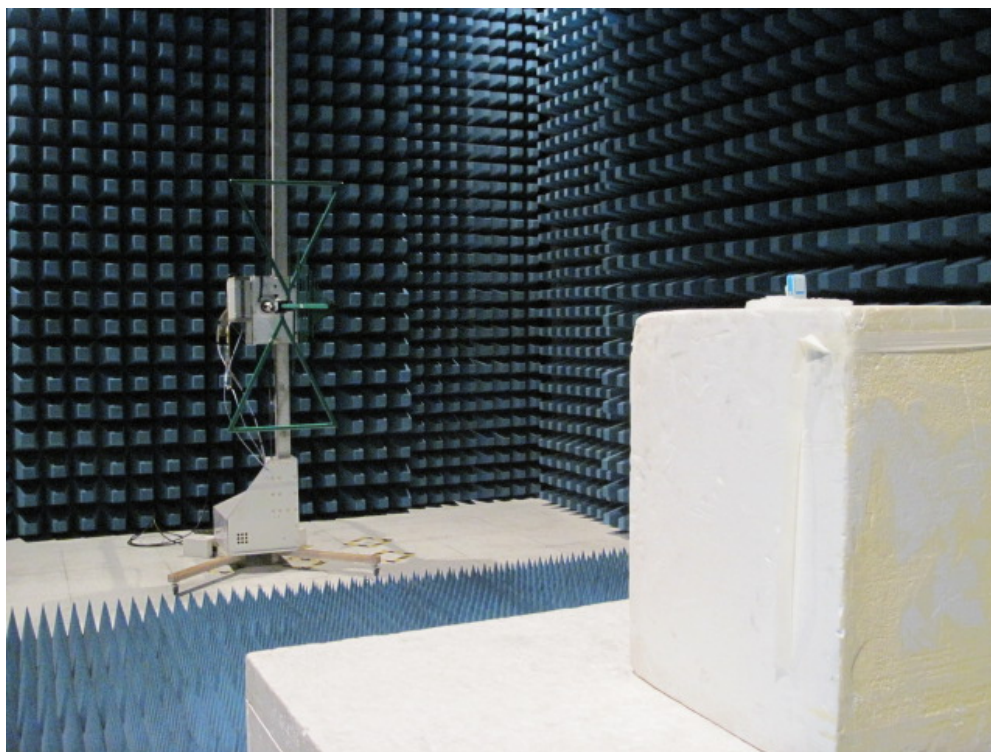

Description: Substitution Antenna for ERP Test

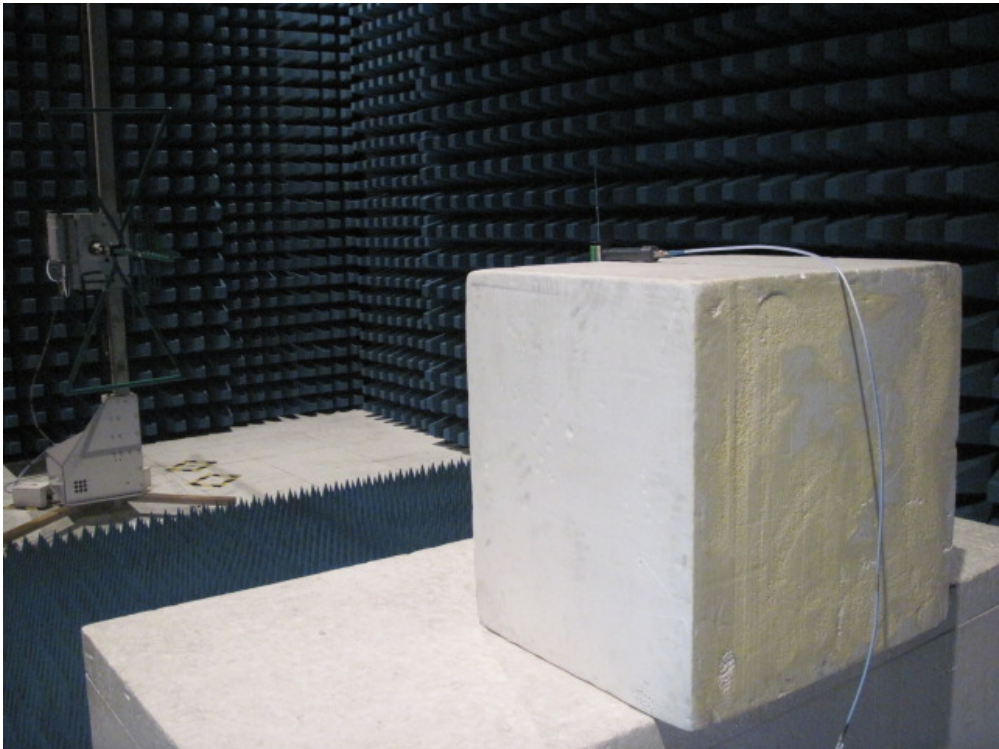

Description: EIRP Test Setup

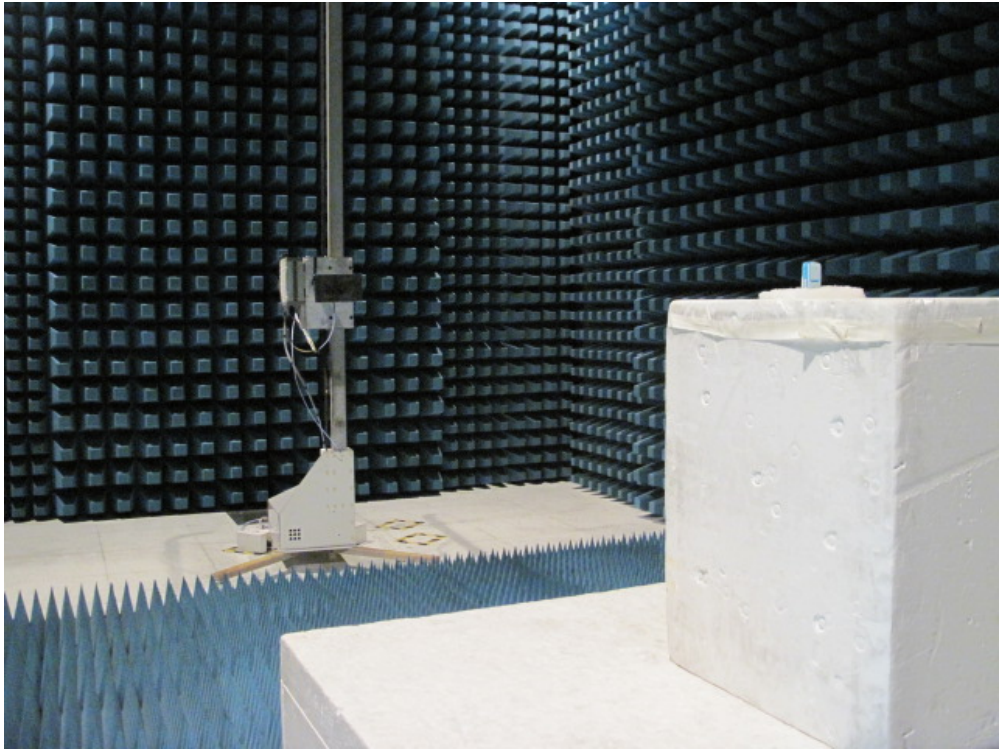

Description: Substitution Antenna for EIRP Test



## 8. Frequency Stability Under Temperature & Voltage Variations

### 8.1. Test Equipment

Frequency Stability Under Temperature & Voltage Variations / AC-6

Instrument	Manufacturer	Type No.	Serial No	Cali. Due Date
PSA Series Spectrum Analyzer	Agilent	E4440A	MY49420184	2012.04.10
Radio Communication Tester	R&S	CMU 200	117088	2012.04.29
Dual Directional Coupler	Agilent	778D	20160	2012.04.20
10dB Coaxial Coupler	Agilent	87300C	MY44300299	2012.04.20
DC Power Supply	IDRC	CD-035-020PR	977272	2011.10.21
Temperature & Humidity Chamber	Gaoyu	TH-1P-B	WIT-05121302	2012.01.19
Temperature/Humidity Meter	Zhicheng	ZC1-2	AC6-TH	2012.01.14

### 8.2. Test Setup

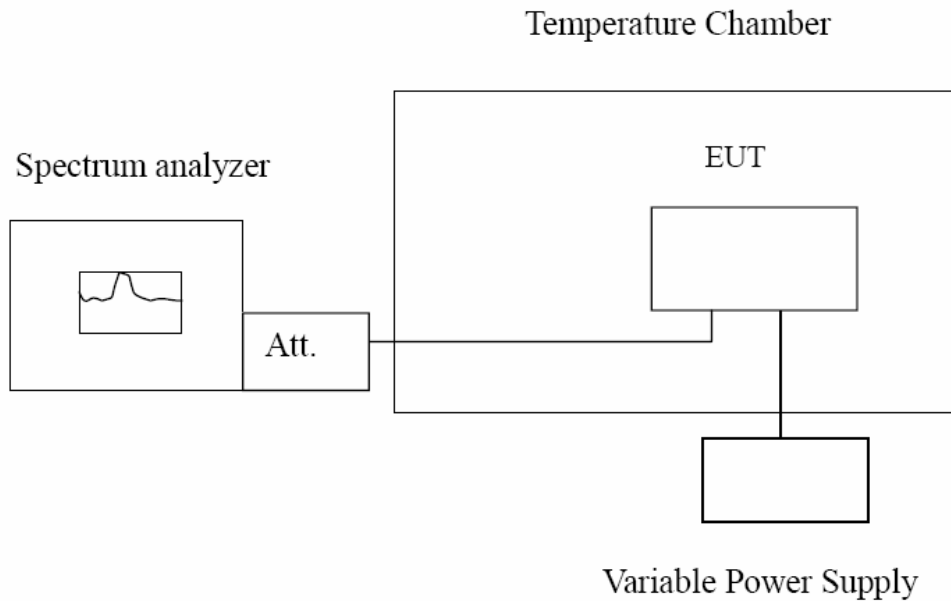

**8.3. Limit**

The frequency stability shall be sufficient to ensure that the fundamental emission stays within the authorized frequency block.

Limit	$< \pm 2.5 \text{ ppm}$
-------	-------------------------

**8.4. Test Procedure**

**Frequency Stability Under Temperature Variations:**

The equipment under test was connected to an external AC or DC power supply and input rated voltage. RF output was connected to a frequency counter or spectrum analyzer via feed through attenuators. The EUT was placed inside the temperature chamber. Set the spectrum analyzer RBW low enough to obtain the desired frequency resolution and measure EUT 20°C operating frequency as reference frequency. Turn EUT off and set the chamber temperature to -25°C (EUT Spec). After the temperature stabilized for approximately 30 minutes recorded the frequency. Repeat step measure with 10°C increased per stage until the highest temperature of +50°C reached.

**Frequency Stability Under Voltage Variations:**

Set chamber temperature to 20°C. Use a variable AC power supply / DC power source to power the EUT and set the voltage to rated voltage. Set the spectrum analyzer RBW low enough to obtain the desired frequency resolution and recorded the frequency.

Reduce the input voltage to specify extreme voltage variation ( $\pm 15\%$ ) and endpoint, record the maximum frequency change.

**8.5. Uncertainty**

The measurement uncertainty is defined as  $\pm 10 \text{ Hz}$ .

**8.6. Test Result**

Product	eCare		
Test Item	Frequency Stability Under Temperature & Voltage Variations		
Test Mode	Mode 1: GSM 850 Link		
Date of Test	2011/09/22	Test Site	AC6

Frequency Stability under Temperature

Temperature Interval (°C)	Test Frequency (MHz)	Deviation		Limit (ppm)
		(Hz)	(ppm)	
-25	836.40	-95	-0.11	< ± 2.5
-10	836.40	-84	-0.10	< ± 2.5
0	836.40	-75	-0.09	< ± 2.5
10	836.40	-59	-0.07	< ± 2.5
20	836.40	-57	-0.07	< ± 2.5
30	836.40	-64	-0.08	< ± 2.5
40	836.40	-83	-0.10	< ± 2.5
50	836.40	-92	-0.11	< ± 2.5

Frequency Stability under Voltage

DC Voltage (V)	Test Frequency (MHz)	Deviation		Limit (ppm)
		(Hz)	(ppm)	
4.200	836.40	-60	-0.07	< ± 2.5
3.800	836.40	-58	-0.07	< ± 2.5
3.600	836.40	-71	-0.08	< ± 2.5



Product	eCare		
Test Item	Frequency Stability Under Temperature & Voltage Variations		
Test Mode	Mode 2: PCS 1900 Link		
Date of Test	2011/09/22	Test Site	AC6

Frequency Stability under Temperature

Temperature Interval (°C)	Test Frequency (MHz)	Deviation		Limit (ppm)
		(Hz)	(ppm)	
-25	1880.00	-134	-0.07	< ± 2.5
-10	1880.00	-110	-0.06	< ± 2.5
0	1880.00	-120	-0.06	< ± 2.5
10	1880.00	-78	-0.04	< ± 2.5
20	1880.00	-75	-0.04	< ± 2.5
30	1880.00	-86	-0.05	< ± 2.5
40	1880.00	-94	-0.05	< ± 2.5
50	1880.00	-102	-0.05	< ± 2.5

Frequency Stability under Voltage

DC Voltage (V)	Test Frequency (MHz)	Deviation		Limit (ppm)
		(Hz)	(ppm)	
4.200	1880.00	-79	-0.04	< ± 2.5
3.800	1880.00	-80	-0.04	< ± 2.5
3.600	1880.00	-92	-0.05	< ± 2.5

9. Attachment

➤ EUT Photograph

(1) EUT Photo



(2) EUT Photo



(3) EUT Photo



(4) EUT Photo



(5) EUT Photo



(6) EUT Photo



(7) EUT Photo

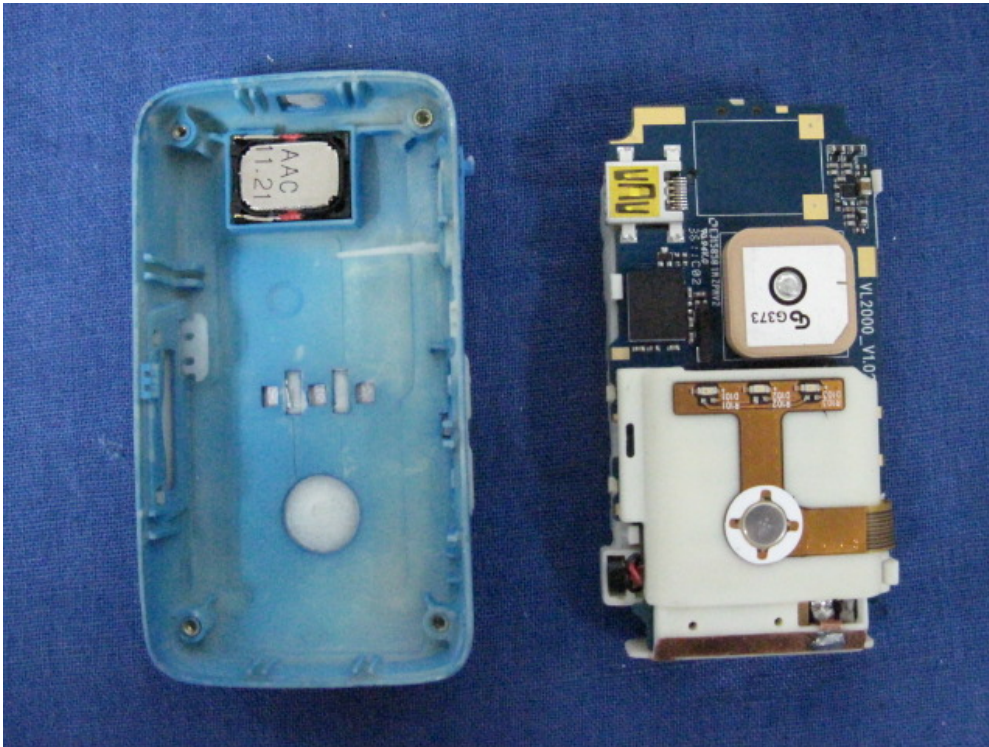

(8) EUT Photo



(9) EUT Photo

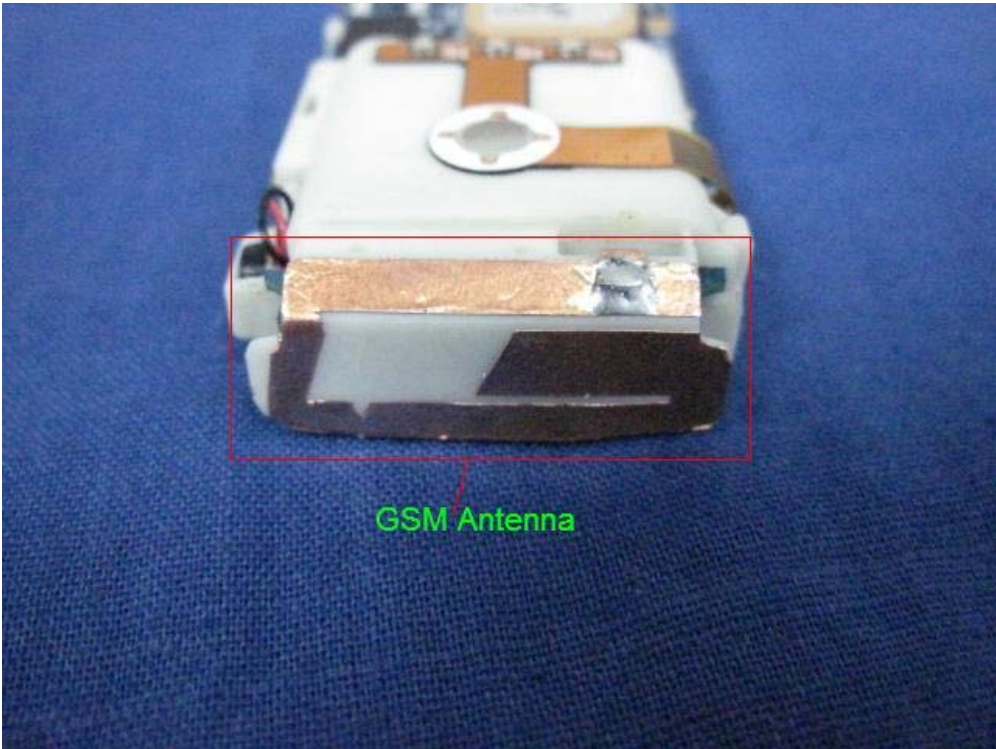

(10) EUT Photo



(11) EUT Photo

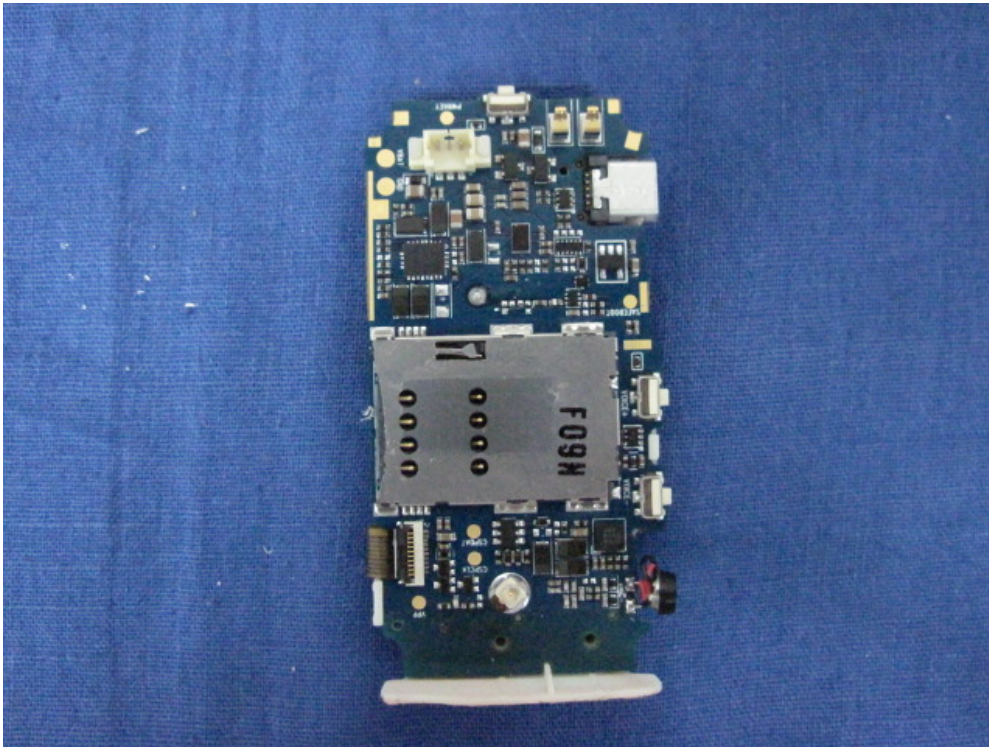

(12) EUT Photo



(13) EUT Photo



(14) EUT Photo

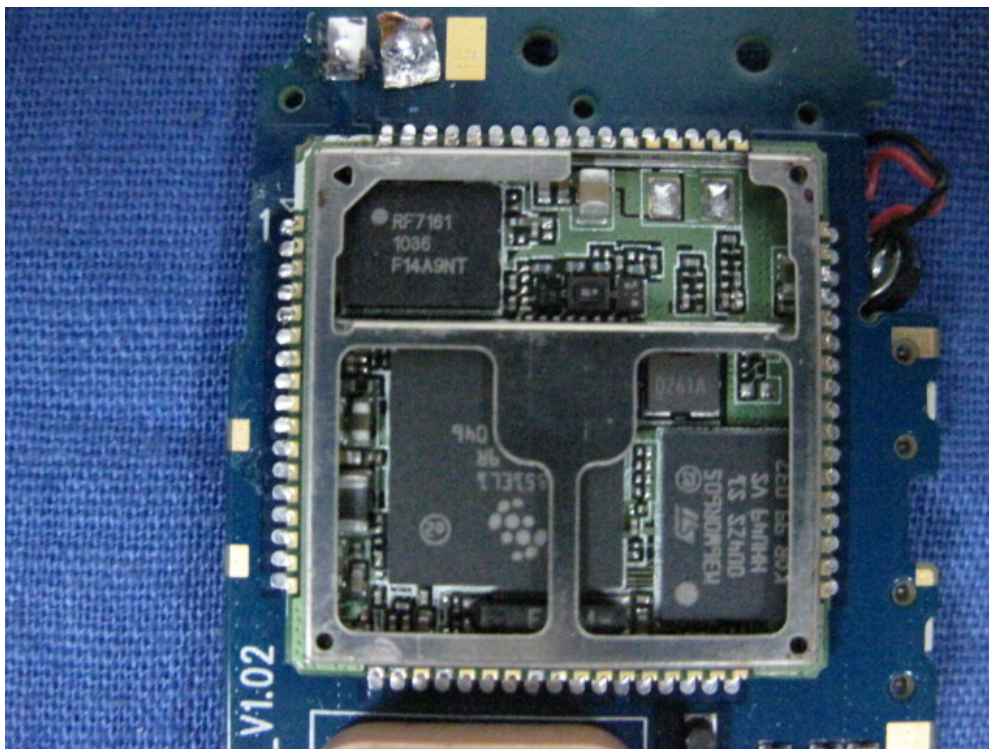



(15) EUT Photo

