

FCC Part22H&24E Test Report

Product Name : GPS Tracker
Model No. : PRIME AT (VL1000)
FCC ID : ZKQ-0609201100001

Applicant : Micron Electronics LLC
Address : 601 N. Congress Ave, Suite 439

Date of Receipt : 16/06/2011
Test Date : 16/06/2011~21/06/2011
Issued Date : 22/06/2011
Report No. : 116S045R-HP-US-P07V01
Report Version : V 1.0

The test results relate only to the samples tested.

The test results shown in the test report are traceable to the national/international standard through the calibration of the equipment and evaluated measurement uncertainty herein.

This report must not be used to claim product endorsement by TAF, NVLAP, NIST or any agency of the Government.

The test report shall not be reproduced except in full without the written approval of QuieTek Corporation.

Test Report Certification

Issued Date : 22/06/2011

Report No. : 116S045R-HP-US-P07V01



Product Name : GPS Tracker
Applicant : Micron Electronics LLC
Address : 601 N. Congress Ave, Suite 439
Manufacturer : Shanghai Simcom Ltd.
Address : Building A, SIM Technology Building, No.633, Jinzhong Road, Changning District, Shanghai P.R. China 200335
Model No. : PRIME AT (VL1000)
FCC ID : ZKQ-0609201100001
EUT Voltage : MIN: 3.6V, NOR: 3.7V, MAX: 4.2V
Brand Name : PRIME
Applicable Standard : FCC CFR Title 47 Part 2, TIA/EIA 603-C
FCC Part22 Subpart H, FCC Part24 Subpart E
Test Result : Complied
Performed Location : Suzhou EMC Laboratory
No.99 Hongye Rd., Suzhou Industrial Park Loufeng Hi-Tech Development Zone., Suzhou, China
TEL: +86-512-6251-5088 / FAX: +86-512-6251-5098
FCC Registration Number: 800392

Documented By : Alice Ni
(Engineering ADM: Alice Ni)

Reviewed By : Robin Wu
(Senior Engineer: Robin Wu)

Approved By : Marlin Chen
(Engineering Supervisor: Marlin Chen)

Laboratory Information

We, **Quietek Corporation**, are an independent EMC and safety consultancy that was established the whole facility in our laboratories. The test facility has been accredited/accepted(audited or listed) by the following related bodies in compliance with ISO 17025, EN 45001 and specified testing scope:

Taiwan R.O.C.	: BSMI, NCC, TAF
Germany	: TUV Rheinland
Norway	: Nemko, DNV
USA	: FCC, NVLAP
Japan	: VCCI

The related certificate for our laboratories about the test site and management system can be downloaded from Quietek Corporation's Web Site : <http://www.quietek.com/tw/ctg/cts/accreditations.htm>
 The address and introduction of Quietek Corporation's laboratories can be founded in our Web site : <http://www.quietek.com/>
 If you have any comments, Please don't hesitate to contact us. Our contact information is as below:

HsinChu Testing Laboratory :

No.75-2, 3rd Lin, Wangye Keng, Yonghxing Tsuen, Qionglin Shiang, Hsinchu County 307, Taiwan, R.O.C.
 TEL:+886-3-592-8858 / FAX:+886-3-592-8859 E-Mail : service@quietek.com



LinKou Testing Laboratory :

No. 5-22, Ruei-Shu Valley, Ruei-Ping Tsuen, Lin-Kou Shiang, Taipei, Taiwan, R.O.C.
 TEL : 886-2-8601-3788 / FAX : 886-2-8601-3789 E-Mail : service@quietek.com



Suzhou (China) Testing Laboratory :

No. 99 Hongye Rd., Suzhou Industrial Park Loufeng Hi-Tech Development Zone., Suzhou,China.
 TEL : +86-512-6251-5088 / FAX : +86-512-6251-5098 E-Mail : service@quietek.com



TABLE OF CONTENTS

Description	Page
1. General Information.....	6
1.1. EUT Description	6
1.2. Mode of Operation.....	7
1.3. Tested System Details	8
1.4. Configuration of Tested System.....	9
1.5. EUT Exercise Software.....	10
2. Technical Test.....	11
2.1. Summary of Test Result.....	11
2.2. Test Environment.....	12
3. Peak Output Power	13
3.1. Test Equipment.....	13
3.2. Test Setup.....	14
3.3. Limit.....	14
3.4. Test Procedure	14
3.5. Uncertainty	16
3.6. Test Result.....	17
3.7. Test Photograph	19
4. Occupied Bandwidth.....	21
4.1. Test Equipment.....	21
4.2. Test Setup.....	21
4.3. Limit.....	22
4.4. Test Procedure	22
4.5. Uncertainty	22
4.6. Test Result.....	23
5. Spurious Emission At Antenna Terminals (+/- 1MHz).....	27
5.1. Test Equipment.....	27
5.2. Test Setup.....	27
5.3. Limit.....	28
5.4. Test Procedure	28
5.5. Uncertainty	28
5.6. Test Result.....	29
6. Spurious Emission	31
6.1. Test Equipment.....	31
6.2. Test Setup.....	32
6.3. Limit.....	32
6.4. Test Procedure	32

6.5. Uncertainty 34

6.6. Test Result..... 35

6.7. Test Photograph 37

7. Frequency Stability Under Temperature & Voltage Variations..... 39

7.1. Test Equipment..... 39

7.2. Test Setup..... 39

7.3. Limit..... 40

7.4. Test Procedure 40

7.5. Uncertainty 40

7.6. Test Result..... 41

8. Attachment 43

 EUT Photograph..... 43

1. General Information

1.1. EUT Description

Product Name	GPS Tracker
Brand Name	PRIME
Model No.	PRIME AT (VL1000)
Working Voltage	MIN: 3.6V, NOR: 3.7V, MAX: 4.2V
GPS Function	Yes
Support Band	GSM850/PCS1900
Tx Frequency Range	GSM 850: 824MHz to 849MHz PCS 1900: 1850MHz to 1910MHz
Rx Frequency Range	GSM 850: 869MHz to 894MHz PCS 1900: 1930MHz to 1990MHz
GPRS Class	10
Type of modulation	GMSK
Peak Antenna Gain	0dBi
AC Adapter	Manufacturer: SHENZHEN SUPERWORLD ELECTRONIC TECHNOLOGICAL CO., LTD M/N: SW013UF-0500200US Input: 100-240V~50/60Hz 0.4A Output: DC 5V, 2A

1.2. Mode of Operation

Quietek has verified the construction and function in typical operation. All the test modes were carried out with the EUT in normal operation, which was shown in this test report and defined as:

Test Mode
Mode 1: GPRS 850 Link
Mode 2: GPRS 1900 Link

Note:

1. Regards to the frequency band operation: the lowest, middle and highest frequency of channel were selected to perform the test, then shown on this report.
2. For the ERP/EIRP and radiated emission test, every axis (X, Y, Z) was verified, and show the worst (Z axis) result on this report.
3. This device is a composite device in accordance with Part 15 Subpart B regulations. The report number is 116S045R-HP-US-P01V02.

1.3. Tested System Details

The types for all equipments, plus descriptions of all cables used in the tested system (including inserted cards) are:

Product		Manufacturer	Model No.	Serial No.	Power Cord
1	CMU200	R&S	CMU200	N/A	N/A

1.4. Configuration of Tested System

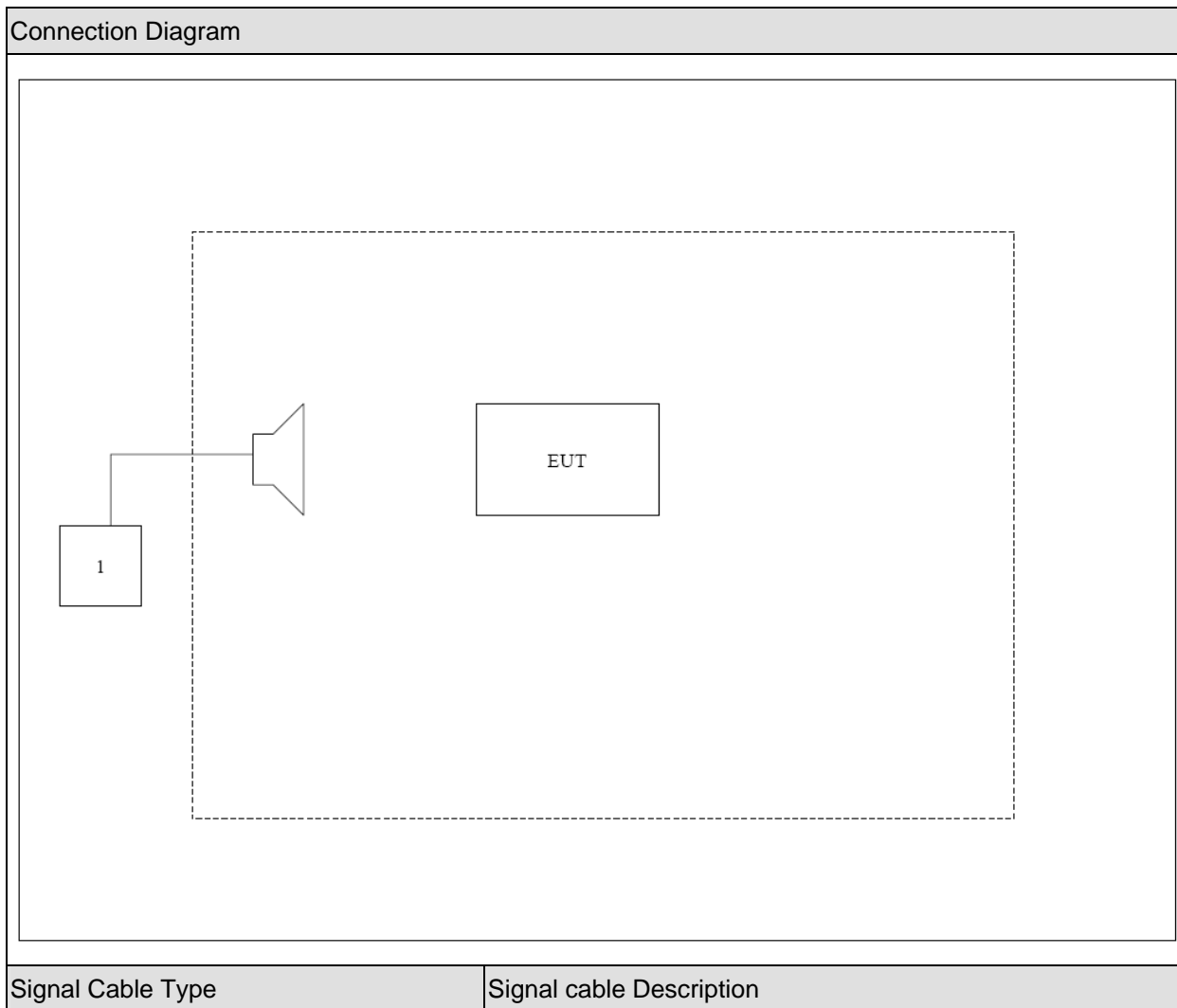

1.5. EUT Exercise Software

1	Setup the EUT and simulators as shown on above.
2	Turn on the power of all equipment.
3	EUT Communicate with CMU200, then select channel to test.

2. Technical Test

2.1. Summary of Test Result

- No deviations from the test standards
- Deviations from the test standards as below description:

For GSM 850 (FCC Part 22H & Part 2)

Emission			
Performed Item	Normative References	Test Performed	Deviation
Peak Output Power	FCC Part 22.913(a)(2) and Part 2.1046	Yes	No
Modulation Characteristic	FCC Part 2.1047(d)	Yes	No
Occupied Bandwidth	FCC Part 2.1049	Yes	No
Spurious Emission At Antenna Terminals (+/- 1MHz)	FCC Part 22.917(a) and Part 2.1049	Yes	No
Spurious Emission	FCC Part 22.917(b) and Part 2.1051, 2.1053	Yes	No
Frequency Stability Under Temperature & Voltage Variations	FCC Part 22.355 and 2.1055	Yes	No

For PCS 1900 (FCC Part 24E & Part 2)

Emission			
Performed Item	Normative References	Test Performed	Deviation
Peak Output Power	FCC Part 24.232(b) and Part 2.1046	Yes	No
Modulation Characteristic	FCC Part 2.1047(d)	Yes	No
Occupied Bandwidth	FCC Part 24.238(b) and Part 2.1049	Yes	No
Spurious Emission At Antenna Terminals (+/- 1MHz)	FCC Part 24.238(a) and Part 2.1049	Yes	No
Spurious Emission	FCC Part 24.238(b) and Part 2.1051, 2.1053	Yes	No
Frequency Stability Under Temperature & Voltage Variations	FCC Part 24.235 and 2.1055	Yes	No

2.2. Test Environment

Items	Required (IEC 68-1)	Actual
Temperature (°C)	15-35	23
Humidity (%RH)	25-75	52
Barometric pressure (mbar)	860-1060	950-1000

3. Peak Output Power

3.1. Test Equipment

Peak Output Power / AC-5

Instrument	Manufacturer	Type No.	Serial No	Cali. Due Date
PSA Series Spectrum Analyzer	Agilent	E4440A	MY49420184	2012.04.10
Radio Communication Tester	R&S	CMU 200	117088	2011.07.12
Dual Directional Coupler	Agilent	778D	20160	2012.04.20
10dB Coaxial Coupler	Agilent	87300C	MY44300299	2012.04.20
PSG Analog Signal Generator	Agilent	E8257D	MY44321116	2012.04.23
Preamplifier	QuieTek	AP-025C	CHM-0503006	2012.05.05
Preamplifier	Miteq	NSP1800-25	1364185	2012.05.05
Bilog Antenna	Teseq GmbH	CBL6112D	27612	2011.10.18
Half Wave Tuned Dipole Antenna	COM-POWER	AD-100	40137	2011.11.24
Broad-Band Horn Antenna	Schwarzbeck	BBHA9120D	737	2011.11.24
Broad-Band Horn Antenna	Schwarzbeck	BBHA9120D	499	2012.06.11
Temperature/Humidity Meter	Zhicheng	ZC1-2	AC5-TH	2012.01.14

3.2. Test Setup

Conducted Power Measurement:

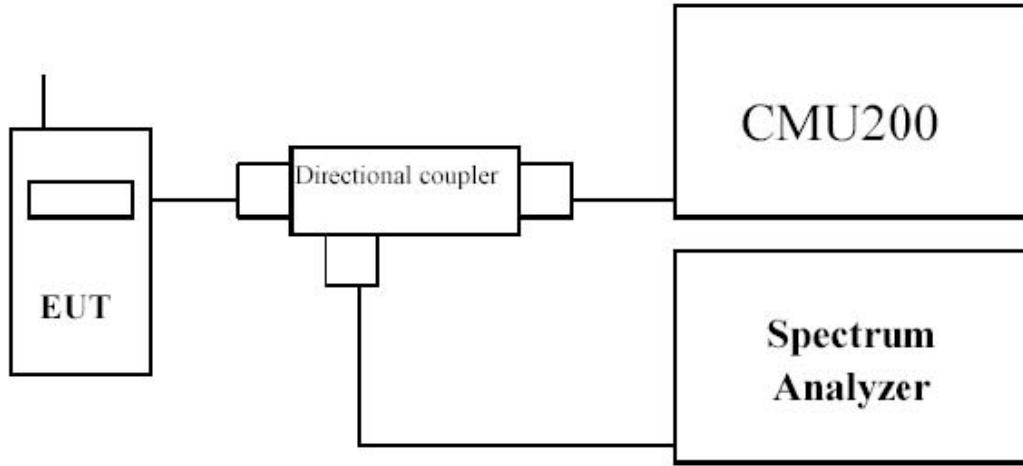

Radiated Power Measurement:

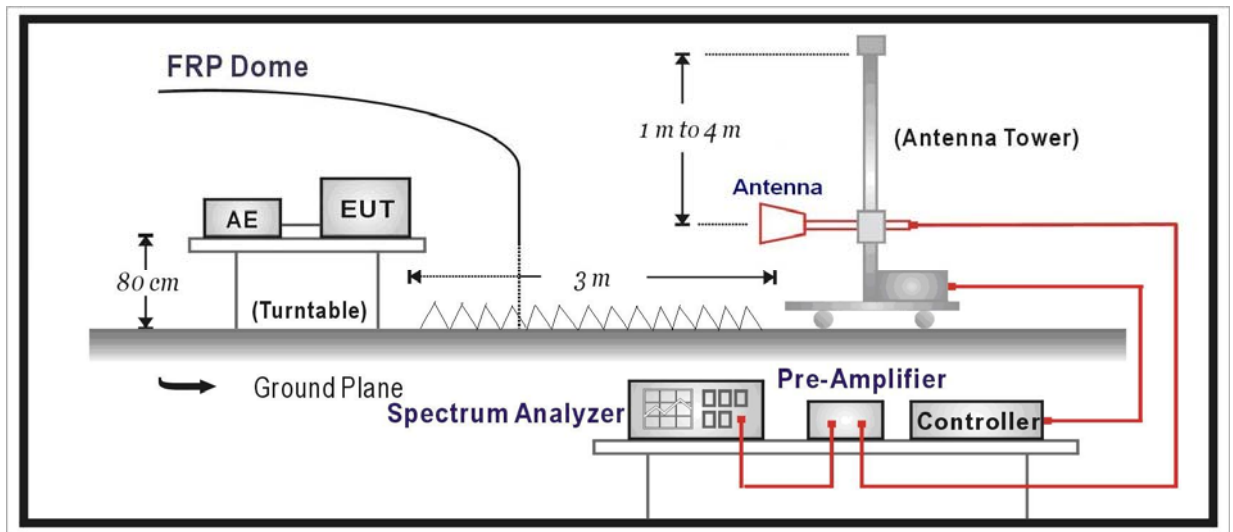

3.3. Limit

For FCC Part 22.913(a)(2):

The ERP of mobile transmitters and auxiliary test transmitters must not exceed 7 Watts.

For FCC Part 24.232(b):

The EIRP of mobile transmitters and auxiliary test transmitters must not exceed 2 Watts.

3.4. Test Procedure

Conducted Power Measurement:

- a) Place the EUT on a bench and set it in transmitting mode.
- b) Connect a low loss RF cable from the antenna port to a spectrum analyzer and CMU200 by a Directional Couple.
- c) EUT Communicate with CMU200, then selects a channel for testing.
- d) Add a correction factor to the display of spectrum, and then test.

Radiated Power Measurement:

- e) The EUT shall be placed at the specified height on a support, and in the position closest to normal use as declared by provider.
- f) The test antenna shall be oriented initially for vertical polarization and shall be chosen to correspond to the frequency of the transmitter
- g) The output of the test antenna shall be connected to the measuring receiver.
- h) The transmitter shall be switched on and the measuring receiver shall be tuned to the frequency of the transmitter under test.
- i) The test antenna shall be raised and lowered through the specified range of height until a maximum signal level is detected by the measuring receiver.
- j) The transmitter shall then be rotated through 360° in the horizontal plane, until the maximum signal level is detected by the measuring receiver.
- k) The test antenna shall be raised and lowered again through the specified range of height until a maximum signal level is detected by the measuring receiver.
- l) The maximum signal level detected by the measuring receiver shall be noted.
- m) The transmitter shall be replaced by a substitution antenna.
- n) The substitution antenna shall be orientated for vertical polarization and the length of the substitution antenna shall be adjusted to correspond to the frequency of the transmitter.
- o) The substitution antenna shall be connected to a calibrated signal generator.
- p) If necessary, the input attenuator setting of the measuring receiver shall be adjusted in order to increase the sensitivity of the measuring receiver.
- q) The test antenna shall be raised and lowered through the specified range of height to ensure that the maximum signal is received.
- r) The input signal to the substitution antenna shall be adjusted to the level that produces a level detected by the measuring receiver, that is equal to the level noted while the transmitter radiated power was measured, corrected for the change of input attenuator setting of the measuring receiver.
- s) The measurement shall be repeated with the test antenna and the substitution antenna orientated for horizontal polarization.
- t) The measure of the effective radiated power is the larger of the two levels recorded at the input to the substitution antenna, corrected for gain of the substitution antenna if

necessary.

- u) Test site anechoic chamber refer to ANSI C63.4: 2009.

3.5. Uncertainty

The measurement uncertainty is defined as for Conducted Power Measurement ± 1.2 dB,
for Radiated Power Measurement ± 3.2 dB

3.6. Test Result

Table 1

No. of timeslots	1	2	3	4
Duty Cycle	1 : 8	1 : 4	1 : 2.66	1 : 2
Timebased avg. power compared to slotted avg. power	-9 dB	-6 dB	-4.25 dB	-3 dB

This device just supports GPRS Class 10 with maximum 2 slots uplink.

The following table shows the conducted power measured and time based average power calculated:

Table 2

GPRS850

Channel No.	Frequency (MHz)	Modulation	Avg. Burst Power (dBm)	Duty Cycle Factor (dB)	Frame Power (dBm)	ERP (dBm)	Limit (dBm)
128	824.2	GMSK	31.46	-9	22.46	29.04	38.50
189	836.4	GMSK	31.54	-9	22.54	28.47	38.50
251	848.8	GMSK	31.56	-9	22.56	29.15	38.50

GPRS1900

Channel No.	Frequency (MHz)	Modulation	Avg. Burst Power (dBm)	Duty Cycle Factor (dB)	Frame Power (dBm)	EIRP (dBm)	Limit (dBm)
512	1850.2	GMSK	29.33	-9	20.33	27.87	33.00
661	1880.0	GMSK	29.29	-9	20.29	28.14	33.00
810	1909.8	GMSK	29.10	-9	20.10	28.72	33.00

Radiated Measurement

GPRS850

Frequency (MHz)	SA Reading (dBm)	Ant. Pol. (H/V)	SG Reading (dBm)	Cable Loss (dB)	Gain (dBd)	ERP (dBm)	Limit (dBm)	Margin (dB)
Low Channel 128 (824.20MHz)								
824.2	-9.24	H	24.45	1.76	-0.02	22.67	38.50	-15.83
824.2	-3.62	V	30.82	1.76	-0.02	29.04	38.50	-9.46
Middle Channel 189 (836.40MHz)								
836.4	-10.48	H	23.31	1.75	0.10	21.66	38.50	-16.84
836.4	-4.55	V	30.12	1.75	0.10	28.47	38.50	-10.03
High Channel 251 (848.80MHz)								
848.8	-9.91	H	24.09	1.78	0.13	22.44	38.50	-16.06
848.8	-3.79	V	30.80	1.78	0.13	29.15	38.50	-9.35

GPRS1900

Frequency (MHz)	SA Reading (dBm)	Ant. Pol. (H/V)	SG Reading (dBm)	Cable Loss (dB)	Gain (dBi)	EIRP (dBm)	Limit (dBm)	Margin (dB)
Low Channel 512 (1850.20MHz)								
1850.2	18.88	H	13.57	2.68	10.40	21.29	33.00	-11.71
1850.2	25.91	V	20.15	2.68	10.40	27.87	33.00	-5.13
Middle Channel 661 (1880.00MHz)								
1880.0	20.02	H	14.50	2.68	10.43	22.25	33.00	-10.75
1880.0	26.25	V	20.39	2.68	10.43	28.14	33.00	-4.86
High Channel 810 (1909.80MHz)								
1909.8	20.13	H	14.61	2.70	10.44	22.35	33.00	-10.65
1909.8	26.69	V	20.98	2.70	10.44	28.72	33.00	-4.28

3.7. Test Photograph

Description: ERP Test Setup

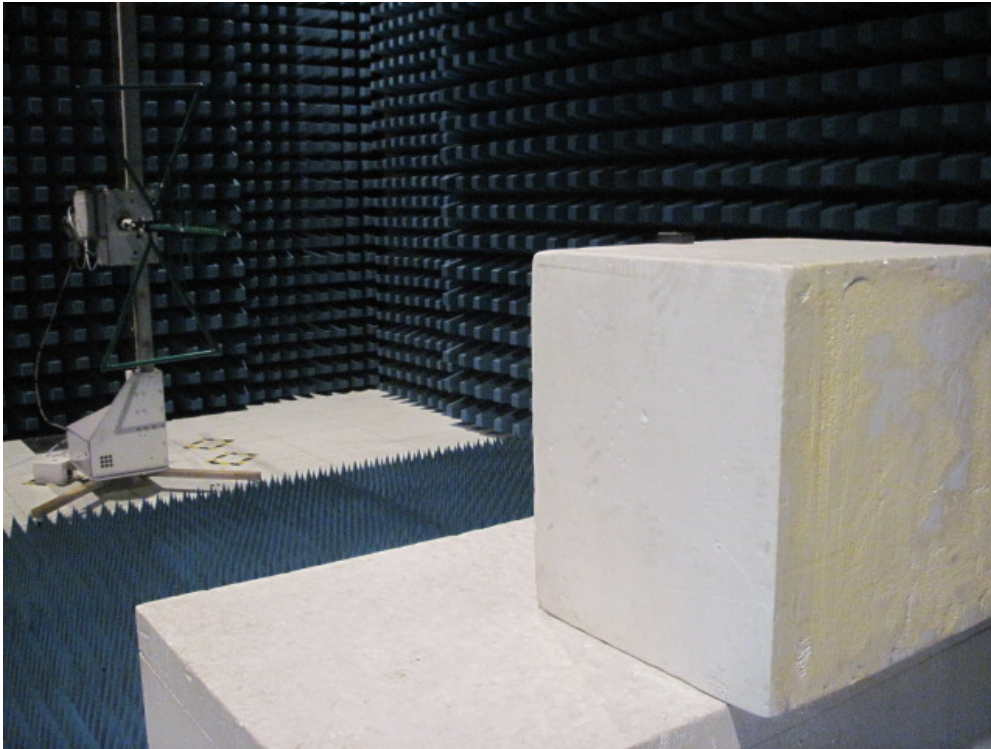

Description: Substitution Antenna for ERP Test

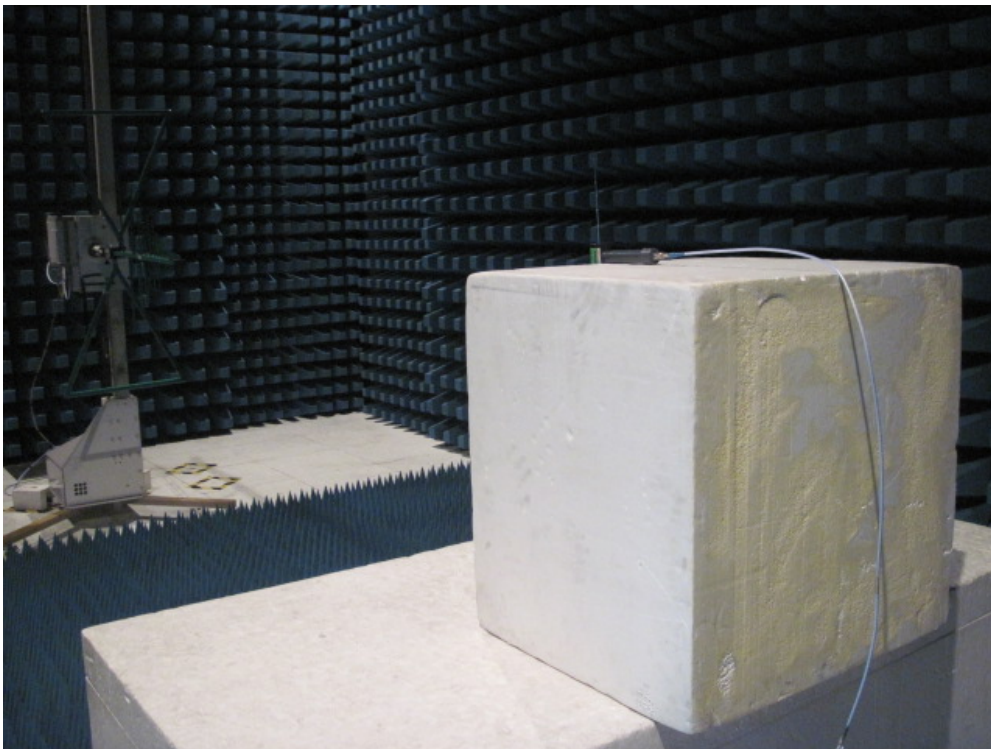

Description: EIRP Test Setup

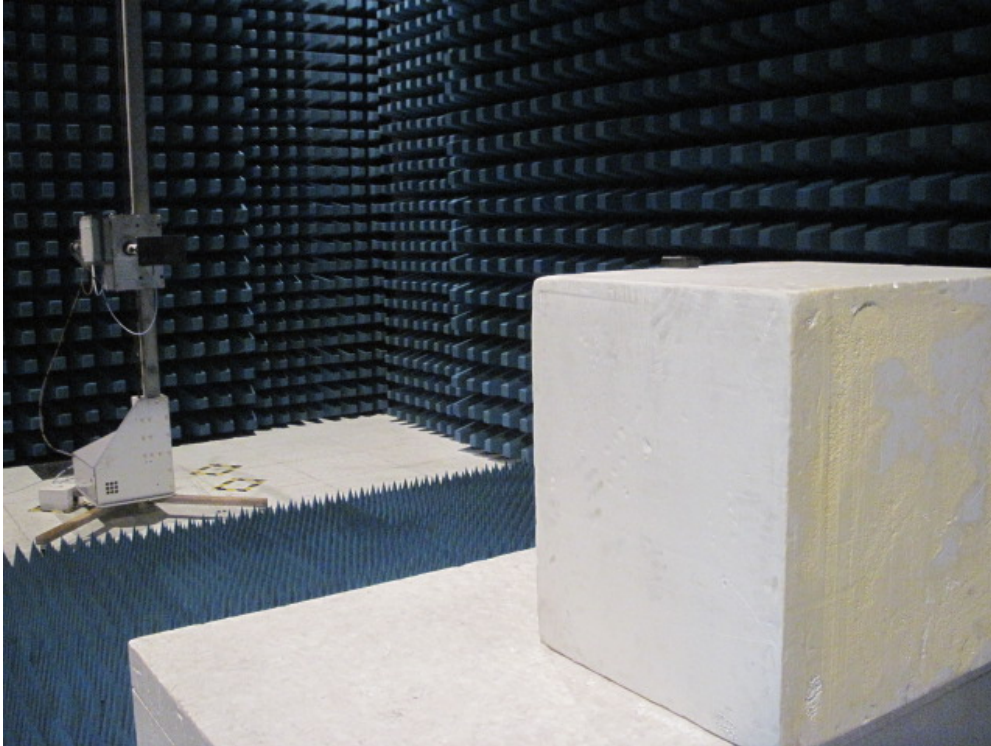

Description: Substitution Antenna for EIRP Test



4. Occupied Bandwidth

4.1. Test Equipment

Occupied Bandwidth / AC-6

Instrument	Manufacturer	Type No.	Serial No	Cali. Due Date
PSA Series Spectrum Analyzer	Agilent	E4440A	MY49420184	2012.04.10
Radio Communication Tester	R&S	CMU 200	117088	2011.07.12
Dual Directional Coupler	Agilent	778D	20160	2012.04.20
10dB Coaxial Coupler	Agilent	87300C	MY44300299	2012.04.20
Temperature/Humidity Meter	Zhicheng	ZC1-2	AC6-TH	2012.01.14

4.2. Test Setup

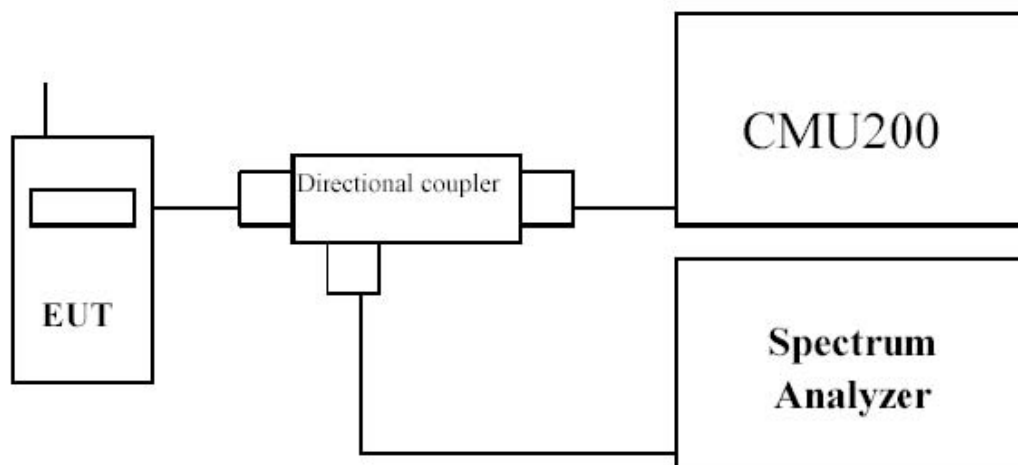

4.3. Limit

N/A

4.4. Test Procedure

Using Occupied Bandwidth measurement function of spectrum analyzer, and setting as follows:

For GSM 850/1900 test --- RBW = 3 kHz and VBW = 10 kHz

4.5. Uncertainty

The measurement uncertainty is defined as ± 10 Hz

4.6. Test Result

Product	GPS Tracker		
Test Item	Occupied Bandwidth		
Test Mode	Mode 1: GPRS850 Link		
Date of Test	2011/06/20	Test Site	AC-6

Channel No.	Frequency (MHz)	-26dB Occupied Bandwidth (kHz)	99% Occupied Bandwidth (kHz)
128	824.20	318.27	249.59
189	836.40	312.02	249.43
251	848.80	317.69	248.66

Figure Channel 128 (824.20MHz)

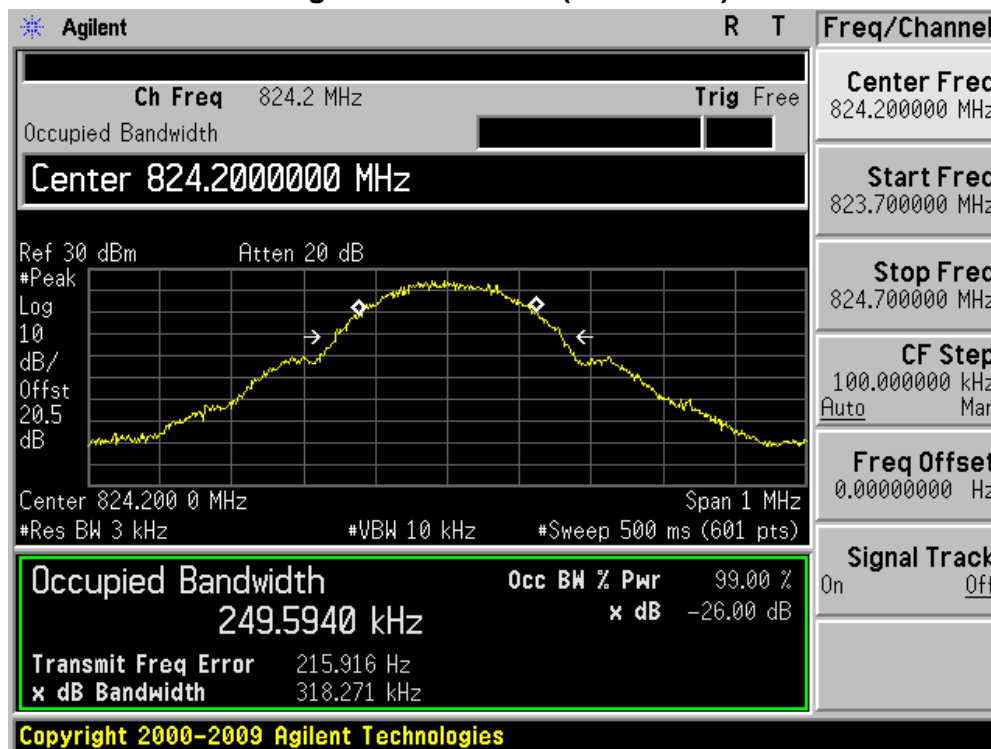

Figure Channel 189 (836.40MHz)

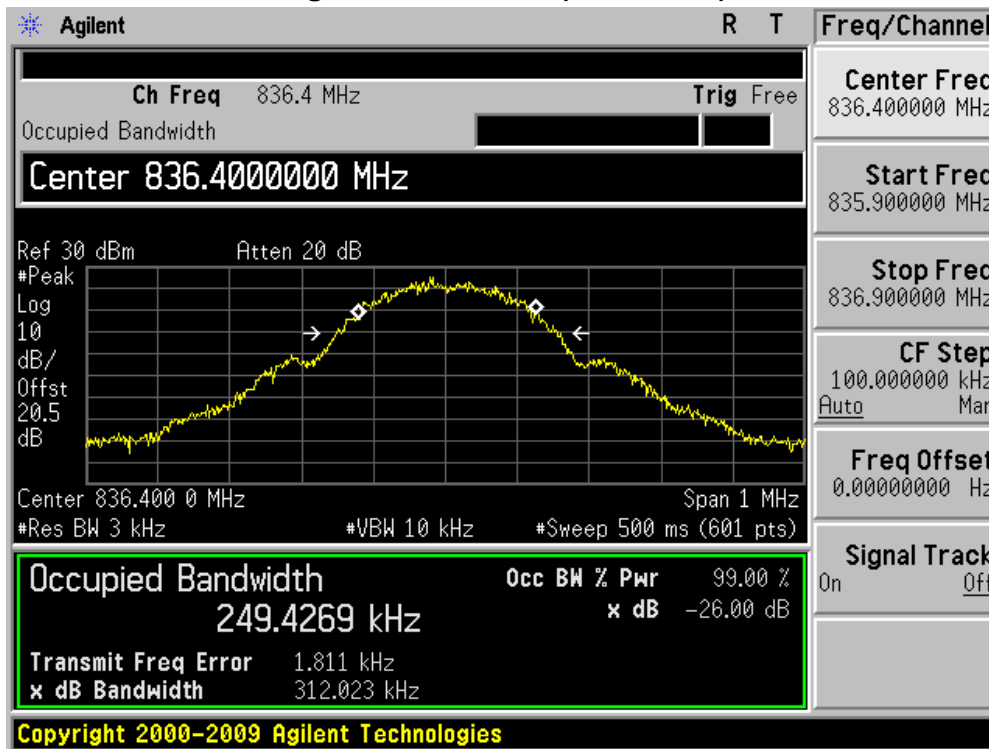

Figure Channel 251 (848.80MHz)



Product	GPS Tracker		
Test Item	Occupied Bandwidth		
Test Mode	Mode 2: GPRS1900 Link		
Date of Test	2011/06/20	Test Site	AC-6

Channel No.	Frequency (MHz)	-26dB Occupied Bandwidth (kHz)	99% Occupied Bandwidth (kHz)
512	1850.20	315.44	246.56
661	1880.00	317.54	246.92
810	1909.80	318.27	248.00

Figure Channel 512 (1850.20MHz)

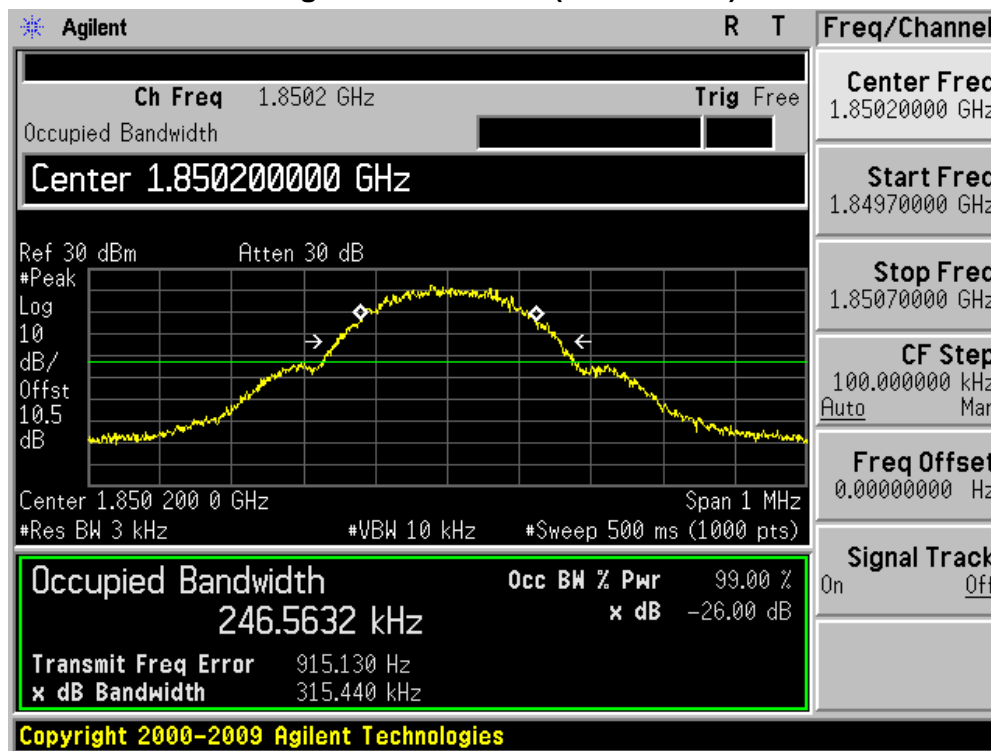

Figure Channel 661 (1880.00MHz)

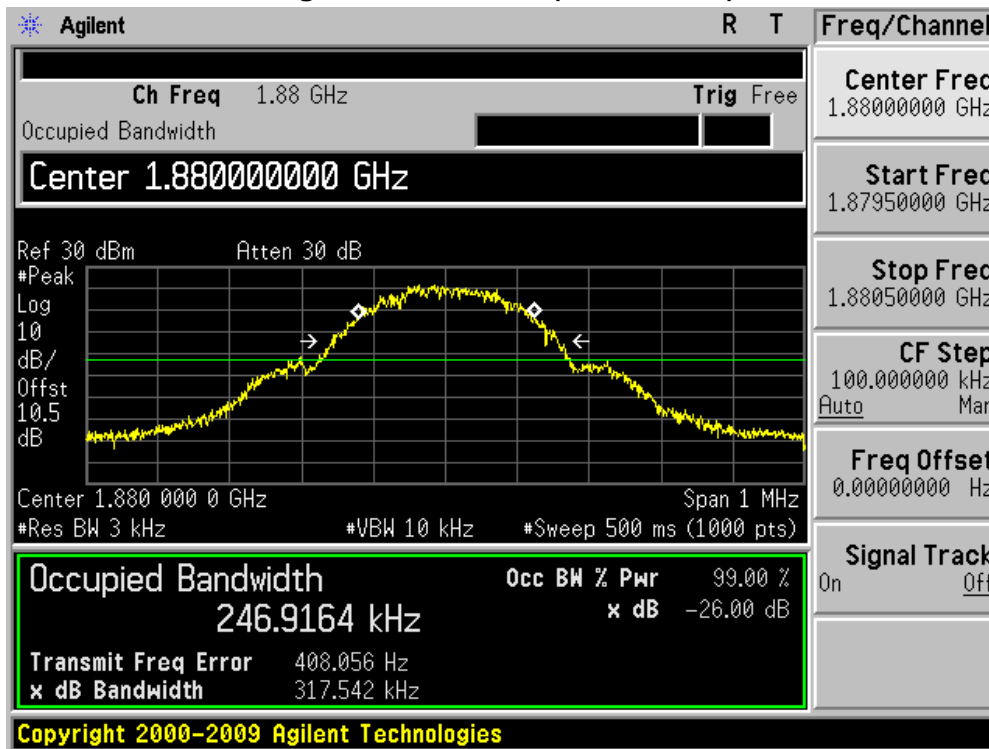
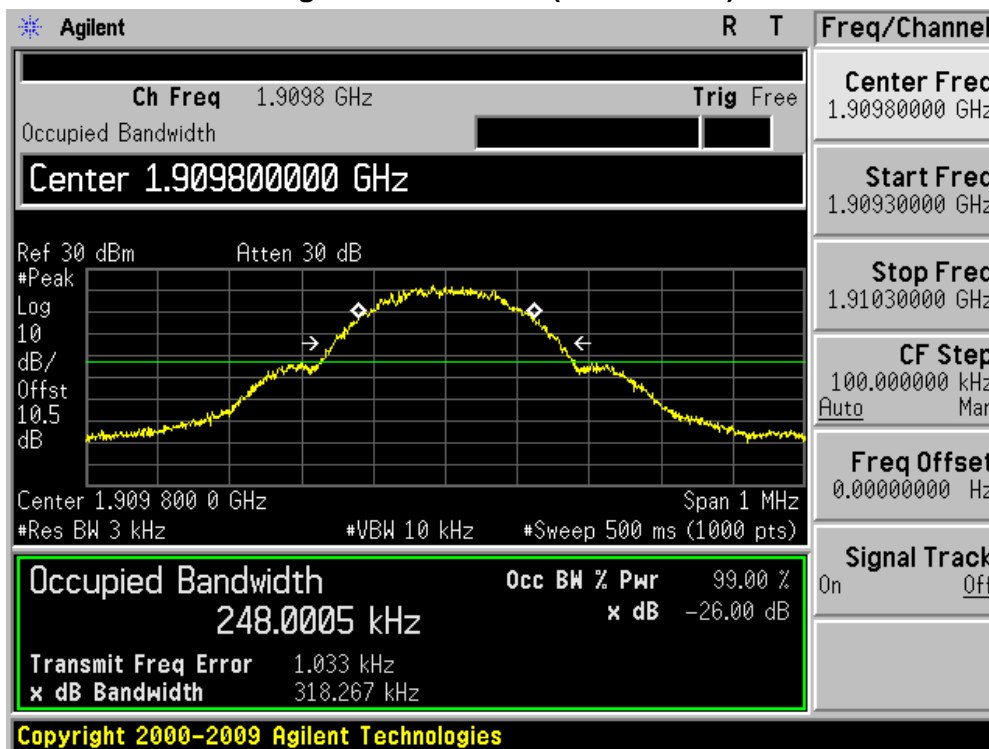

Figure Channel 810 (1909.80MHz)



5. Spurious Emission At Antenna Terminals (+/- 1MHz)

5.1. Test Equipment

Spurious Emission At Antenna Terminals (+/- 1MHz) / AC-6

Instrument	Manufacturer	Type No.	Serial No	Cali. Due Date
PSA Series Spectrum Analyzer	Agilent	E4440A	MY49420184	2012.04.10
Radio Communication Tester	R&S	CMU 200	117088	2011.07.12
Dual Directional Coupler	Agilent	778D	20160	2012.04.20
10dB Coaxial Coupler	Agilent	87300C	MY44300299	2012.04.20
Temperature/Humidity Meter	Zhicheng	ZC1-2	AC6-TH	2012.01.14

5.2. Test Setup

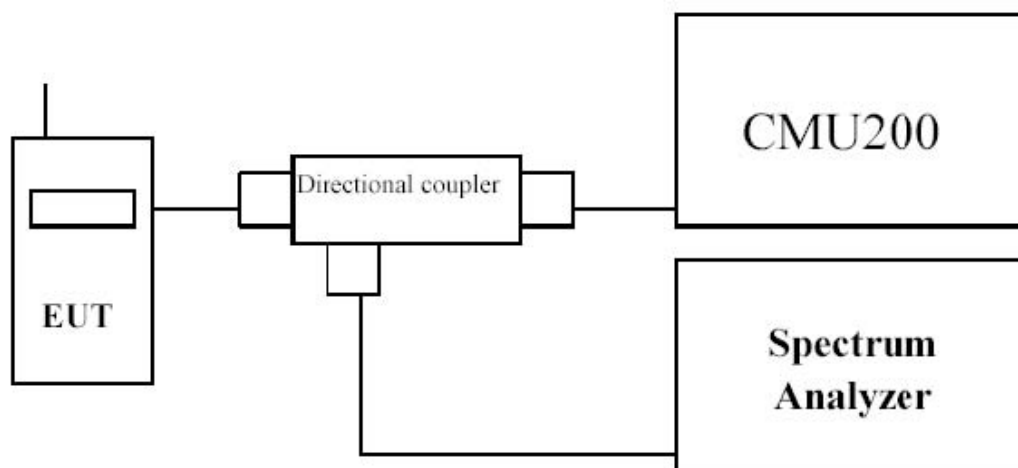

5.3. Limit

The power of any emission outside of the authorized operating frequency ranges must be attenuated below the transmitting power (P) by a factor of at least $43 + 10\log(P)$ dB.

5.4. Test Procedure

In the 1MHz bands immediately outside and adjacent to the frequency block a resolution bandwidth of at least one percent of the emission bandwidth of the fundamental emission of the transmitter may be employed to measure the out of band Emissions.

5.5. Uncertainty

The measurement uncertainty is defined as ± 1.2 dB.

5.6. Test Result

Product	GPS Tracker		
Test Item	Spurious Emission At Antenna Terminals (+/- 1MHz)		
Test Mode	Mode 1: GPRS 850 Link		
Date of Test	2011/06/20	Test Site	AC-6

Figure Channel 128 (824.20MHz)

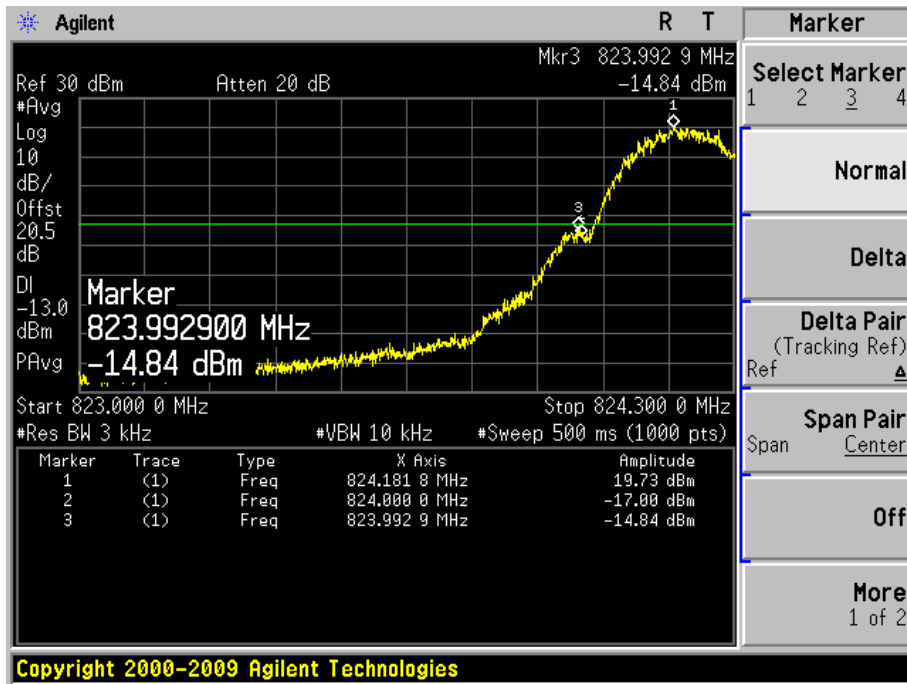
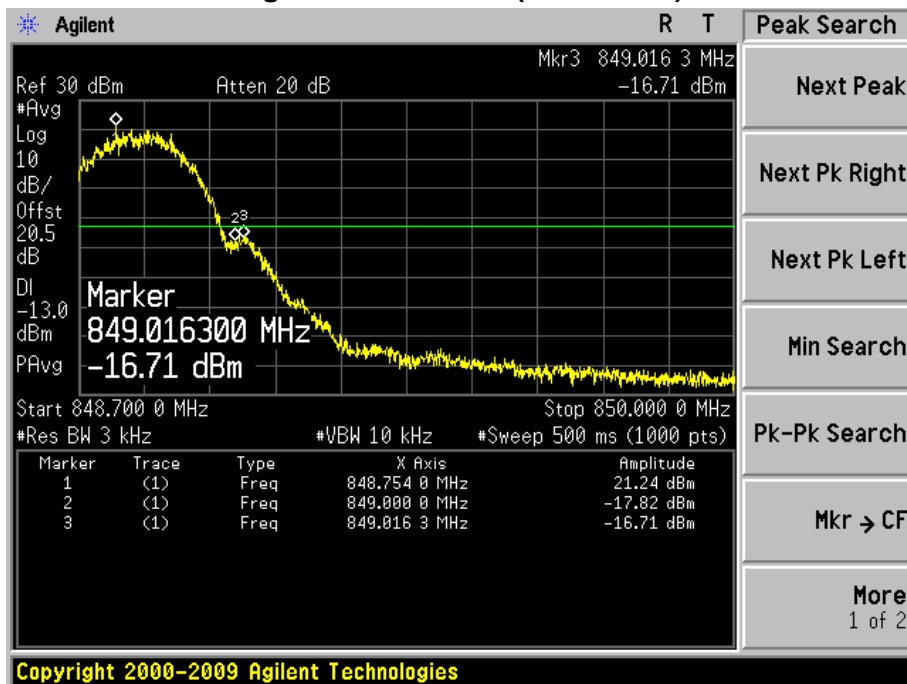

Figure Channel 251 (848.80MHz)



Product	GPS Tracker		
Test Item	Spurious Emission At Antenna Terminals (+/- 1MHz)		
Test Mode	Mode 2: GPRS1900 Link		
Date of Test	2011/06/20	Test Site	AC-6

Figure Channel 512 (1850.20MHz)

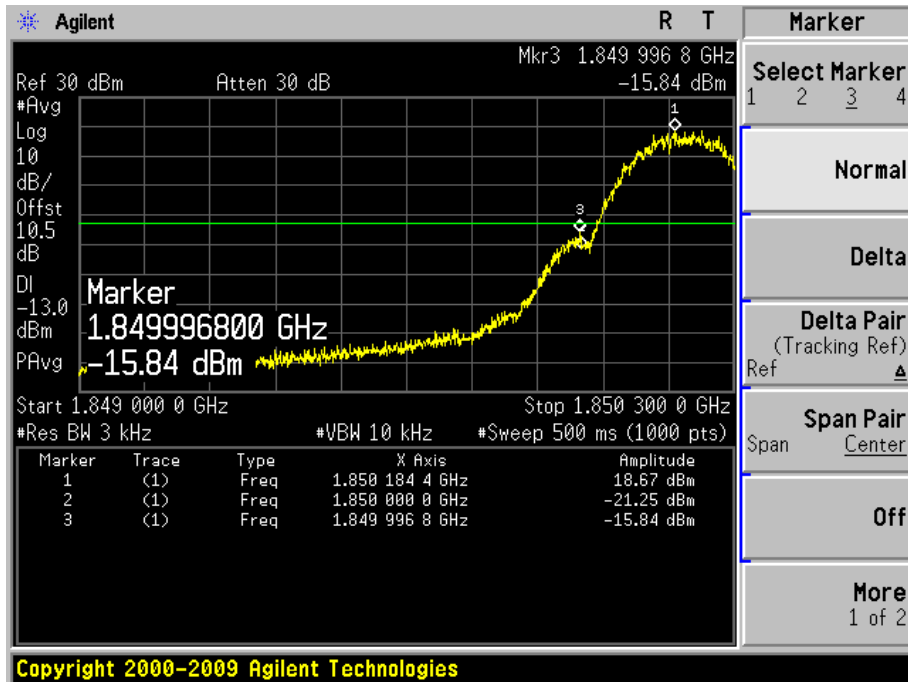
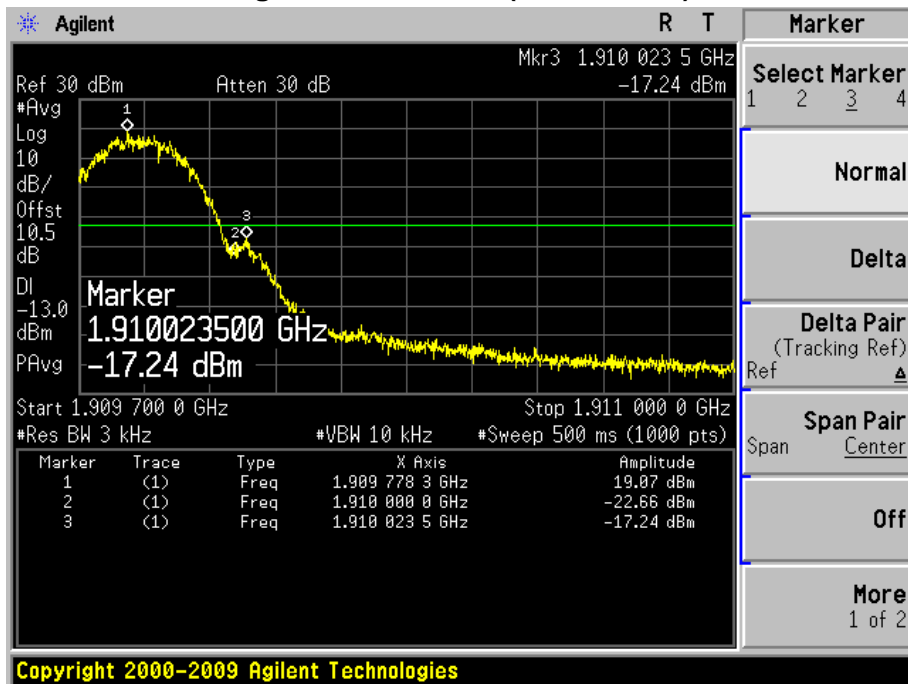

Figure Channel 810 (1909.80MHz)



6. Spurious Emission

6.1. Test Equipment

Spurious Emission / AC-5

Instrument	Manufacturer	Type No.	Serial No	Cali. Due Date
PSA Series Spectrum Analyzer	Agilent	E4440A	MY49420184	2012.04.10
Radio Communication Tester	R&S	CMU 200	117088	2011.07.12
Dual Directional Coupler	Agilent	778D	20160	2012.04.20
10dB Coaxial Coupler	Agilent	87300C	MY44300299	2012.04.20
PSG Analog Signal Generator	Agilent	E8257D	MY44321116	2012.04.23
Preamplifier	QuieTek	AP-025C	CHM-0503006	2012.05.05
Preamplifier	Miteq	NSP1800-25	1364185	2012.05.05
Bilog Antenna	Teseq GmbH	CBL6112D	27612	2011.10.18
Half Wave Tuned Dipole Antenna	COM-POWER	AD-100	40137	2011.11.24
Broad-Band Horn Antenna	Schwarzbeck	BBHA9120D	737	2011.11.24
Broad-Band Horn Antenna	Schwarzbeck	BBHA9120D	499	2012.06.11
Temperature/Humidity Meter	Zhicheng	ZC1-2	AC5-TH	2012.01.14

6.2. Test Setup

Radiated Spurious Measurement: below 1GHz

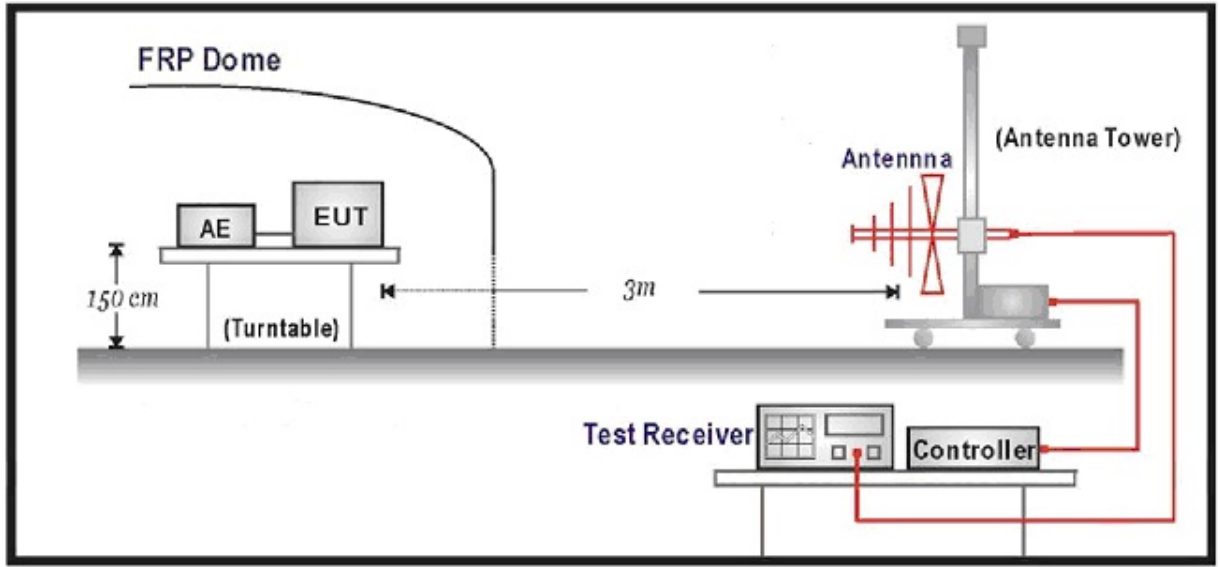

Radiated Spurious Measurement: above 1GHz

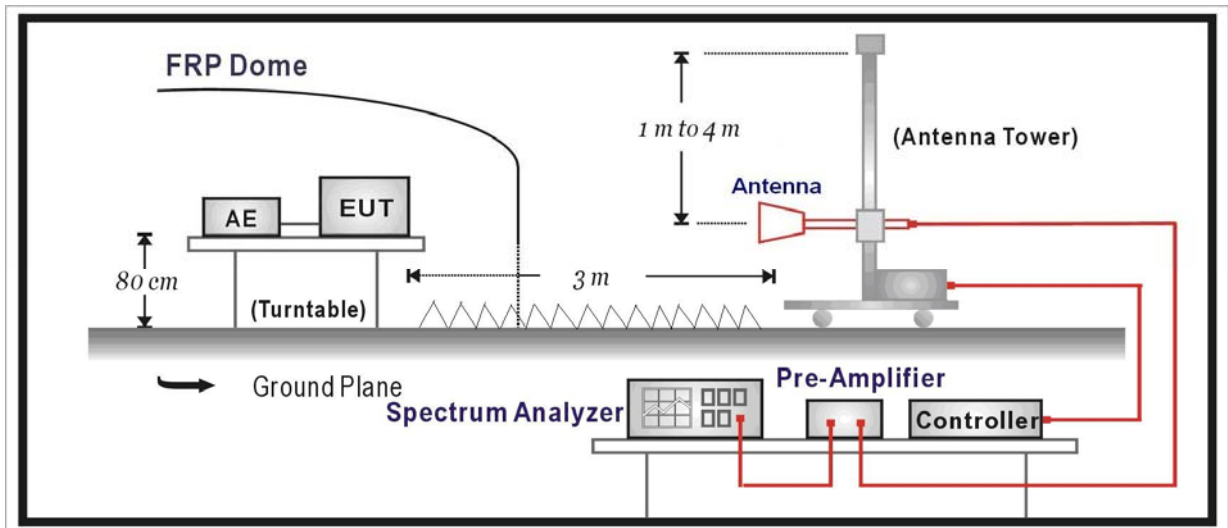

6.3. Limit

The power of any emission outside of the authorized operating frequency ranges must be attenuated below the transmitting power (P) by a factor of at least $43 + 10\log(P)$ dB.

6.4. Test Procedure

Conducted Spurious Measurement:

- a) Place the EUT on a bench and set it in transmitting mode.
- b) Connect a low loss RF cable from the antenna port to a spectrum analyzer and CMU200 by a Directional Couple.
- c) EUT Communicate with CMU200, then select a channel for testing.
- d) Add a correction factor to the display of spectrum, and then test.
- e) The resolution bandwidth of the spectrum analyzer was set at 1 MHz, sufficient scans were taken to show the out of band Emission if any up to 10th harmonic.

Radiated Spurious Measurement:

- a) The EUT shall be placed at the specified height on a support, and in the position closest to normal use as declared by provider.
- b) The test antenna shall be oriented initially for vertical polarization and shall be chosen to correspond to the frequency of the transmitter
- c) The output of the test antenna shall be connected to the measuring receiver.
- d) The transmitter shall be switched on and the measuring receiver shall be tuned to the frequency of the transmitter under test.
- e) The test antenna shall be raised and lowered through the specified range of height until a maximum signal level is detected by the measuring receiver.
- f) The transmitter shall then be rotated through 360° in the horizontal plane, until the maximum signal level is detected by the measuring receiver.
- g) The test antenna shall be raised and lowered again through the specified range of height until a maximum signal level is detected by the measuring receiver.
- v) The maximum signal level detected by the measuring receiver shall be noted.
- h) The transmitter shall be replaced by a substitution antenna.
- i) The substitution antenna shall be orientated for vertical polarization and the length of the substitution antenna shall be adjusted to correspond to the frequency of the transmitter.
- j) The substitution antenna shall be connected to a calibrated signal generator.
- k) If necessary, the input attenuator setting of the measuring receiver shall be adjusted in order to increase the sensitivity of the measuring receiver.
- l) The test antenna shall be raised and lowered through the specified range of height to ensure that the maximum signal is received.
- m) The input signal to the substitution antenna shall be adjusted to the level that produces a level detected by the measuring receiver, that is equal to the level noted while the transmitter radiated power was measured, corrected for the change of input attenuator setting of the measuring receiver.
- n) The measurement shall be repeated with the test antenna and the substitution antenna

orientated for horizontal polarization.

- o) The measure of the effective radiated power is the larger of the two levels recorded at the input to the substitution antenna, corrected for gain of the substitution antenna if necessary.
- p) The frequency range was checked up to 10th harmonic.
- q) Test site anechoic chamber refer to ANSI C63.4: 2009

6.5. Uncertainty

The measurement uncertainty is defined as 3.2 dB for Radiated Power Measurement.

6.6. Test Result

Product	GPS Tracker		
Test Item	Spurious Emission		
Test Mode	Mode 1: GPRS850 Traffic		
Date of Test	2011/06/20	Test Site	AC-5

Frequency (MHz)	SA Reading (dBm)	Ant.Pol. (H/V)	SG Reading (dBm)	Cable Loss (dB)	Gain (dBi)	EIRP (dBm)	Limit (dBm)	Margin (dB)
Low Channel 128 (824.20MHz)								
1646.00	-41.35	V	-46.07	2.50	9.75	-38.82	-13.00	-25.82
2470.50	-51.08	V	-52.26	3.12	10.48	-44.90	-13.00	-31.90
1646.00	-41.74	H	-46.55	2.50	9.75	-39.30	-13.00	-26.30
2470.50	-45.58	H	-44.32	3.12	10.48	-36.96	-13.00	-23.96
Middle Channel 189 (836.40MHz)								
1671.50	-40.34	V	-45.16	2.52	9.95	-37.73	-13.00	-24.73
2513.00	-49.44	V	-50.91	3.18	10.62	-43.47	-13.00	-30.47
1671.50	-44.04	H	-48.61	2.52	9.95	-41.18	-13.00	-28.18
2513.00	-49.38	H	-48.49	3.18	10.62	-41.05	-13.00	-28.05
High Channel 251 (848.80MHz)								
1697.00	-43.34	V	-48.22	2.54	10.06	-40.70	-13.00	-27.70
2547.00	-48.94	V	-49.52	3.14	10.68	-41.98	-13.00	-28.98
1697.00	-46.76	H	-50.91	2.54	10.06	-43.39	-13.00	-30.39
2547.00	-56.07	H	-56.40	3.14	10.68	-48.86	-13.00	-35.86

Product	GPS Tracker		
Test Item	Spurious Emission		
Test Mode	Mode 2: GPRS1900 Traffic		
Date of Test	2011/06/20	Test Site	AC-5

Frequency (MHz)	SA Reading (dBm)	Ant.Pol. (H/V)	SG Reading (dBm)	Cable Loss (dB)	Gain (dBi)	EIRP (dBm)	Limit (dBm)	Margin (dB)
Low Channel 512 (1850.20MHz)								
3703.00	-54.46	V	-53.15	3.84	12.69	-44.30	-13.00	-31.30
5547.50	-57.24	V	-50.88	4.82	13.15	-42.55	-13.00	-29.55
3703.00	-56.44	H	-55.22	3.84	12.69	-46.37	-13.00	-33.37
5547.50	-56.56	H	-50.83	4.82	13.15	-42.50	-13.00	-29.50
Middle Channel 661 (1880.00MHz)								
3762.50	-55.41	V	-54.25	3.73	12.72	-45.26	-13.00	-32.26
5641.00	-55.89	V	-49.42	4.93	13.14	-41.21	-13.00	-28.21
3762.50	-57.52	H	-56.43	3.73	12.72	-47.44	-13.00	-34.44
5641.00	-55.49	H	-49.63	4.93	13.14	-41.42	-13.00	-28.42
High Channel 810 (1909.80MHz)								
3822.00	-50.19	V	-48.62	4.02	12.73	-39.91	-13.00	-26.91
5726.00	-57.11	V	-50.64	4.87	13.11	-42.40	-13.00	-29.40
3822.00	-55.93	H	-54.21	4.02	12.73	-45.50	-13.00	-32.50
5726.00	-56.75	H	-50.66	4.87	13.11	-42.42	-13.00	-29.42

6.7. Test Photograph

Description: ERP Test Setup

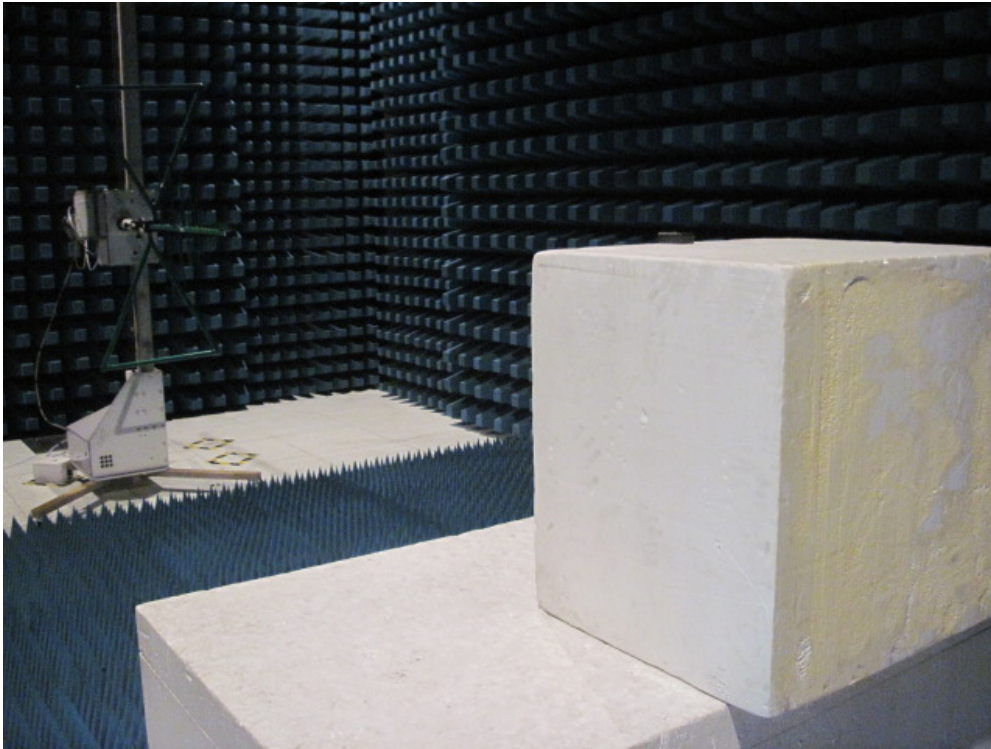

Description: Substitution Antenna for ERP Test

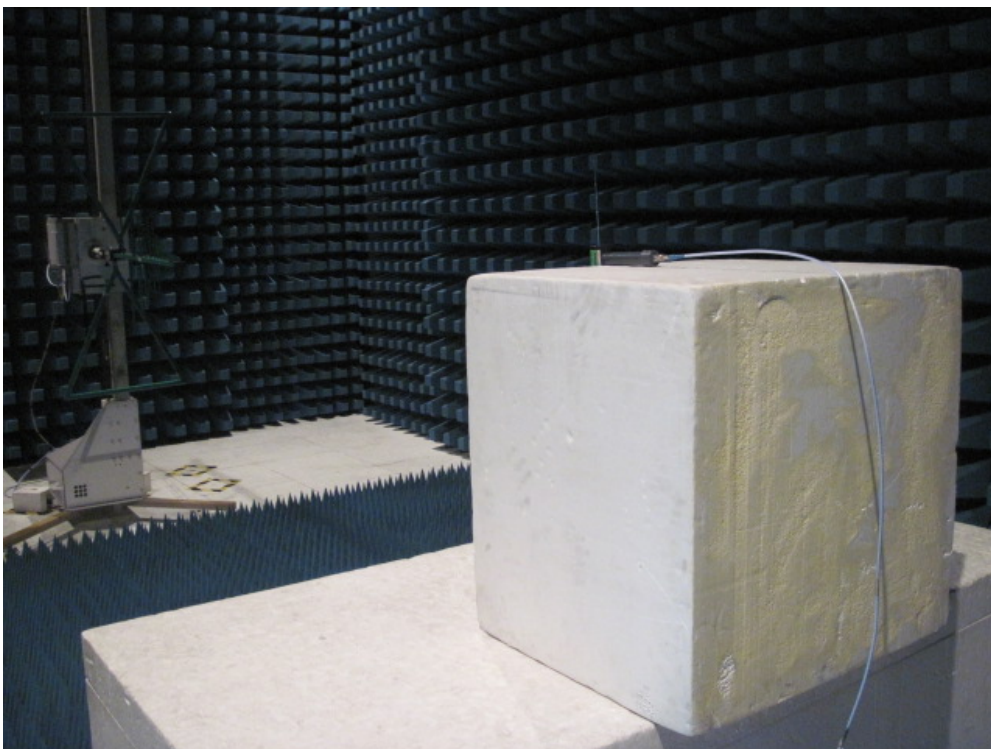

Description: EIRP Test Setup

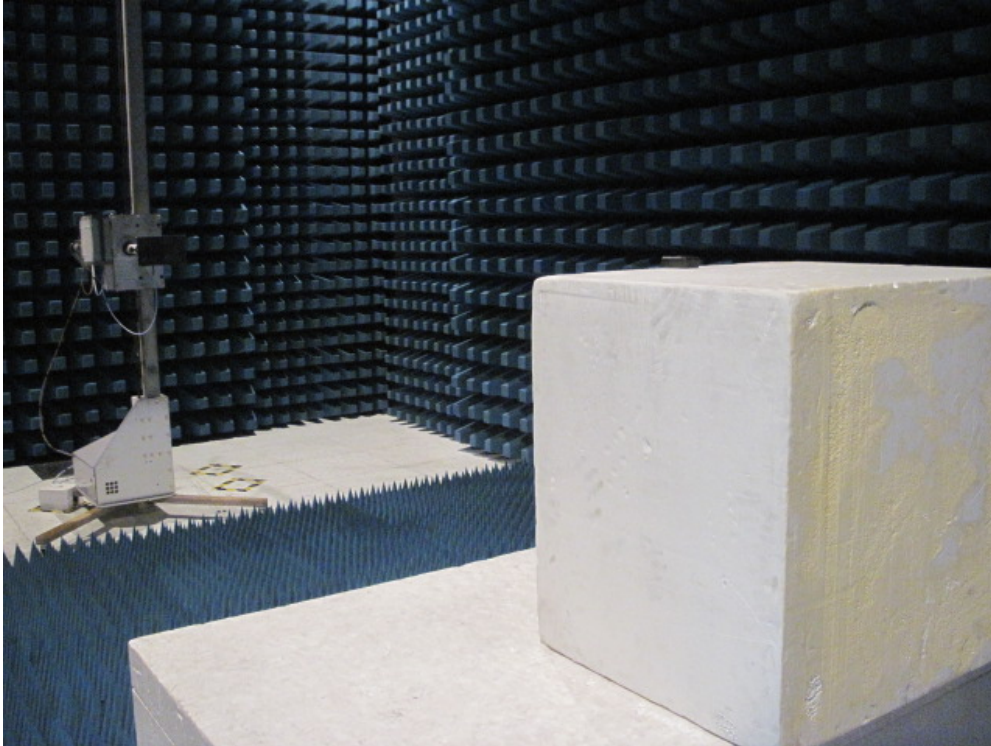

Description: Substitution Antenna for EIRP Test



7. Frequency Stability Under Temperature & Voltage Variations

7.1. Test Equipment

Frequency Stability Under Temperature & Voltage Variations / AC-6

Instrument	Manufacturer	Type No.	Serial No	Cali. Due Date
PSA Series Spectrum Analyzer	Agilent	E4440A	MY49420184	2012.04.10
Radio Communication Tester	R&S	CMU 200	117088	2011.07.12
Dual Directional Coupler	Agilent	778D	20160	2012.04.20
10dB Coaxial Coupler	Agilent	87300C	MY44300299	2012.04.20
DC Power Supply	IDRC	CD-035-020PR	977272	2011.10.21
Temperature & Humidity Chamber	Gaoyu	TH-1P-B	WIT-05121302	2012.01.19
Temperature/Humidity Meter	Zhicheng	ZC1-2	AC6-TH	2012.01.14

7.2. Test Setup

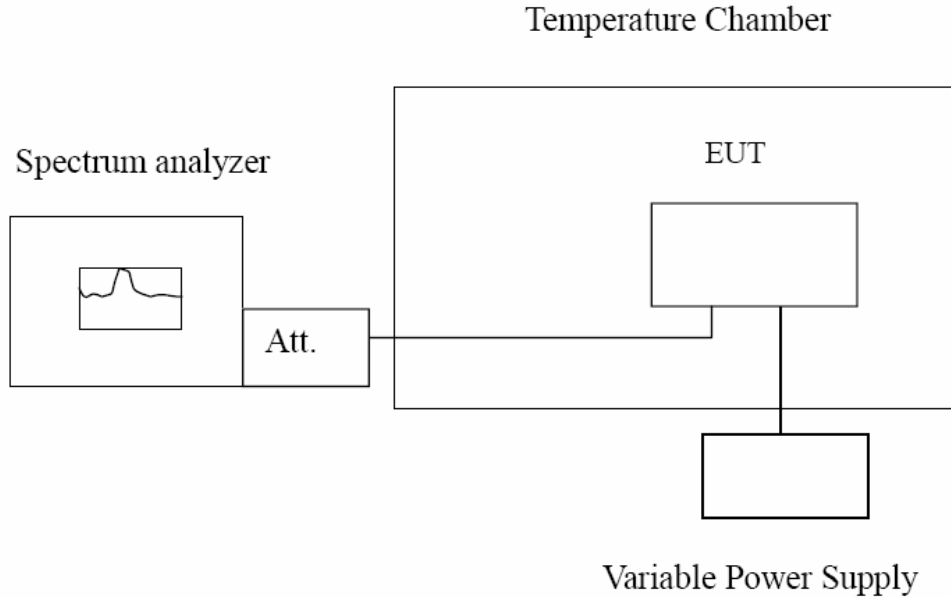

7.3. Limit

The frequency stability shall be sufficient to ensure that the fundamental emission stays within the authorized frequency block.

Limit	$< \pm 2.5 \text{ ppm}$
-------	-------------------------

7.4. Test Procedure

Frequency Stability Under Temperature Variations:

The equipment under test was connected to an external AC or DC power supply and input rated voltage. RF output was connected to a frequency counter or spectrum analyzer via feed through attenuators. The EUT was placed inside the temperature chamber. Set the spectrum analyzer RBW low enough to obtain the desired frequency resolution and measure EUT 20°C operating frequency as reference frequency. Turn EUT off and set the chamber temperature to -30°C. After the temperature stabilized for approximately 30 minutes recorded the frequency. Repeat step measure with 10°C increased per stage until the highest temperature of +50°C reached.

Frequency Stability Under Voltage Variations:

Set chamber temperature to 20°C. Use a variable AC power supply / DC power source to power the EUT and set the voltage to rated voltage. Set the spectrum analyzer RBW low enough to obtain the desired frequency resolution and recorded the frequency.

Reduce the input voltage to specify extreme voltage variation ($\pm 15\%$) and endpoint, record the maximum frequency change.

7.5. Uncertainty

The measurement uncertainty is defined as $\pm 10 \text{ Hz}$.

7.6. Test Result

Product	GPS Tracker		
Test Item	Frequency Stability Under Temperature & Voltage Variations		
Test Mode	Mode 1: GPRS 850 Link		
Date of Test	2011/06/20	Test Site	AC6

Frequency Stability under Temperature

Temperature Interval (°C)	Test Frequency (MHz)	Deviation (Hz)	Limit (kHz)
-10	836.40	-8612	± 2091
0	836.40	-8306	± 2091
10	836.40	-8975	± 2091
20	836.40	-8347	± 2091
30	836.40	-8100	± 2091
40	836.40	-7912	± 2091
50	836.40	-8803	± 2091

Frequency Stability under Voltage

DC Voltage (V)	Test Frequency (MHz)	Deviation (Hz)	Limit (KHz)
3.600	836.40	-10916	± 2091
3.700	836.40	-10734	± 2091
4.200	836.40	-11096	± 2091

Product	GPS Tracker		
Test Item	Frequency Stability Under Temperature & Voltage Variations		
Test Mode	Mode 2: GPRS1900 Link		
Date of Test	2011/06/20	Test Site	AC6

Frequency Stability under Temperature

Temperature Interval (°C)	Test Frequency (MHz)	Deviation (Hz)	Limit (kHz)
-10	1880.00	-8980	± 4700
0	1880.00	-8960	± 4700
10	1880.00	-8131	± 4700
20	1880.00	-8302	± 4700
30	1880.00	-8411	± 4700
40	1880.00	-6850	± 4700
50	1880.00	-8324	± 4700

Frequency Stability under Voltage

DC Voltage (V)	Test Frequency (MHz)	Deviation (Hz)	Limit (KHz)
3.600	1880.00	-10967	± 4700
3.700	1880.00	-10914	± 4700
4.200	1880.00	-11877	± 4700

8. Attachment

➤ EUT Photograph

(1) EUT Photo



(2) EUT Photo



(3) EUT Photo



(4) EUT Photo



(5) EUT Photo



(6) EUT Photo



(7) EUT Photo



(8) EUT Photo

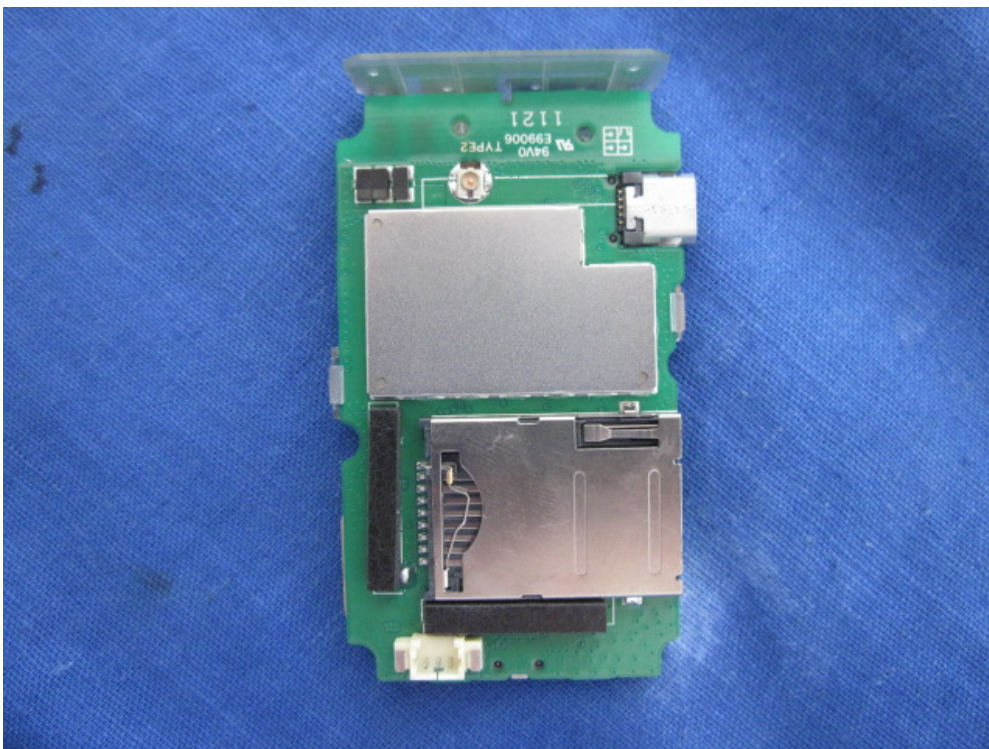

(9) EUT Photo



(10) EUT Photo



(11) EUT Photo



(12) EUT Photo



(13) EUT Photo

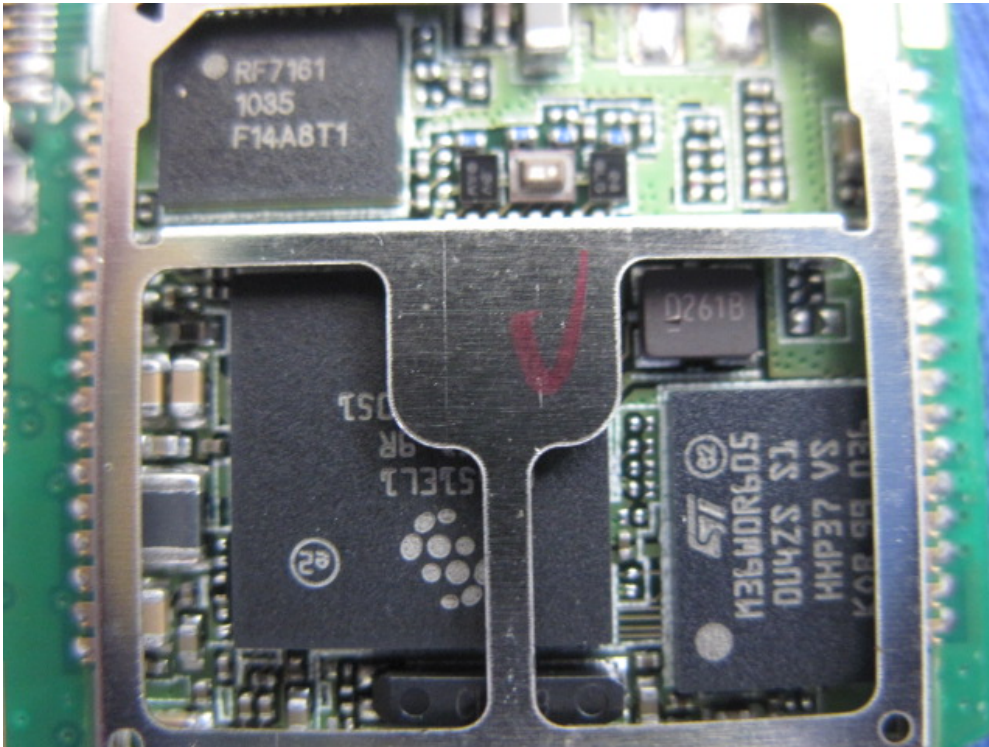

(14) EUT Photo

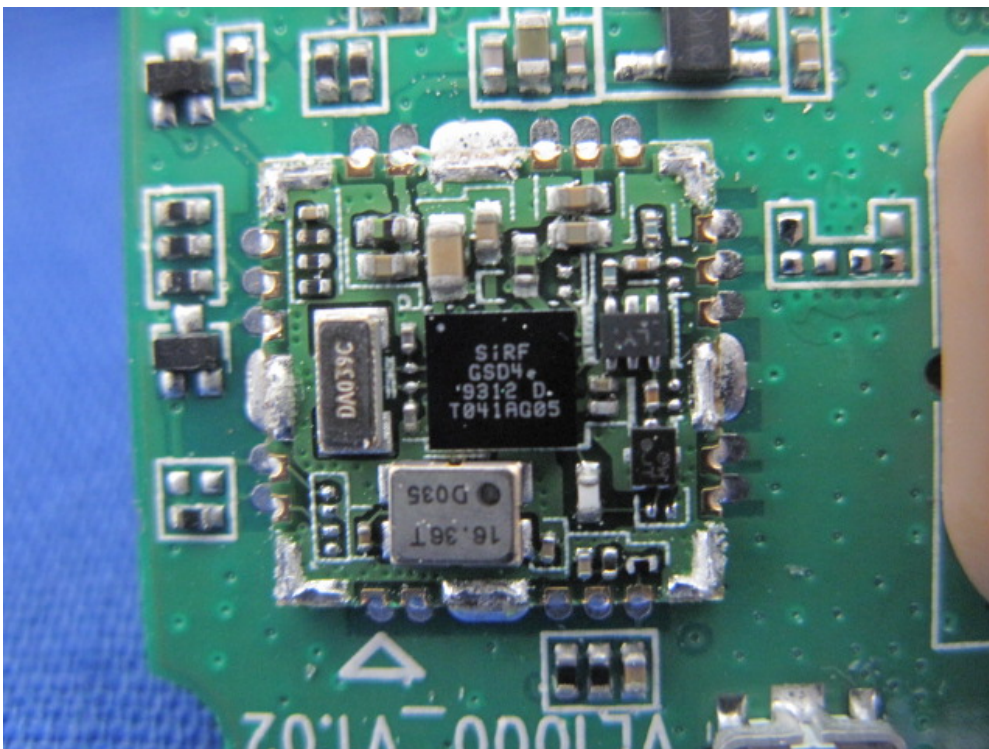

(15) EUT Photo

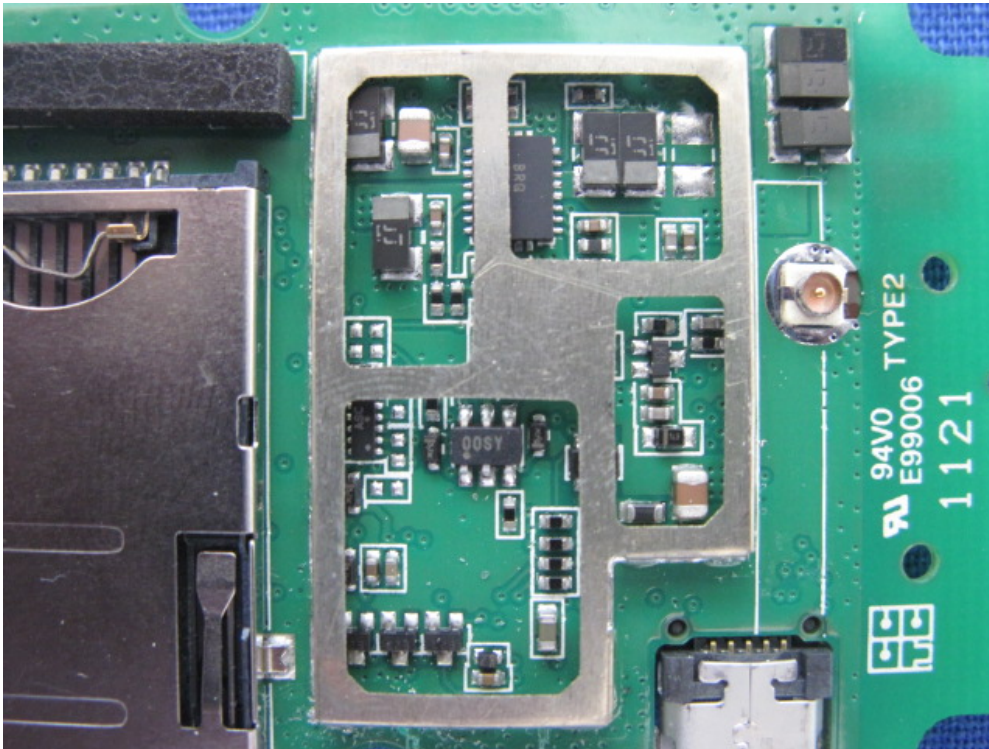

(16) EUT Photo



(17) EUT Photo



(18) EUT Photo



(19) EUT Photo



(20) EUT Photo

