

FCC Radio Test Report

FCC ID: ZK8-HB001C

The report concerns: Original Grant

Report Reference No.....: 20EFAS04126 2951

Date Sample(s) Received.....: 2020-04-15

Date of Tested.....: 2020-04-15 to 2020-05-06

Date of issue.....: 2020-05-06

Testing Laboratory: DongGuan ShuoXin Electronic Technology Co., Ltd.
Zone A, 1F, No. 6, XinGang Road YuanGang Street,
Address: XinAn District, ChangAn Town, DongGuan City,
GuangDong, China

Applicant's name: ZMODO Technology Shenzhen Corp. Ltd.
Address: 25/F, Office Tower A, Financial Technology Building,
11 Keyuan Road, Nanshan District, Shenzhen,
Guangdong, China

Manufacturer.....: ZMODO Technology Shenzhen Corp. Ltd.

Equipment.....: Hubbell SpectraSAFE

Trade Mark: N/A

Model: 93124134

Ratings: I/P: DC 5V

Responsible Engineer :

Smile Wang

Authorized Signatory:

King Wang

Table of Contents	Page
1 . TEST REPORT DECLARE	4
2 . SUMMARY OF TEST RESULTS	5
2.1 MEASUREMENT UNCERTAINTY	6
3 . GENERAL INFORMATION	7
3.1 GENERAL DESCRIPTION OF EUT	7
3.2 DESCRIPTION OF TEST MODES	8
3.3 PARAMETERS OF TEST SOFTWARE	9
3.4 BLOCK DIAGRAM SHOWING THE CONFIGURATION OF SYSTEM TESTED	10
3.5 SUPPORT UNITS	10
3.6 TEST ENVIRONMENT CONDITIONS	10
3.7 DUTY CYCLE	11
4 . AC POWER LINE CONDUCTED EMISSIONS TEST	12
4.1 LIMIT	12
4.2 TEST PROCEDURE	12
4.3 MEASUREMENT INSTRUMENTS LIST	12
4.4 TESTSETUP	13
4.5 EUT OPERATION CONDITIONS	13
4.6 TEST RESULTS	14
5 . RADIATED EMISSIONSTEST	16
5.1 LIMIT	16
5.2 TEST PROCEDURE	17
5.3 MEASUREMENT INSTRUMENTS LIST	18
5.4 TESTSETUP	18
5.5 EUT OPERATIONCONDITIONS	19
5.6 TEST RESULTS - 9KHZ TO 30MHZ	20
5.7 TEST RESULTS - 30MHZTO 1000MHZ	21
5.8 TEST RESULTS- ABOVE 1000MHZ(BAND EDGE)	23
5.9 TEST RESULTS- ABOVE 1000MHZ(HARMONIC)	39
6 . BANDWIDTH TEST	63
6.1 LIMIT	63
6.2 TEST PROCEDURE AND SETTING	63
6.3 MEASUREMENT INSTRUMENTS LIST	63
6.4 TEST SETUP	63

Table of Contents	Page
6.5 EUT OPERATION CONDITIONS	63
6.6 TESTRESULTS	64
7 . MAXIMUM OUTPUT POWER TEST	68
7.1 LIMIT	68
7.2 TEST PROCEDURE AND SETTING	68
7.3 MEASUREMENT INSTRUMENTS LIST	68
7.4 TEST SETUP	68
7.5 EUT OPERATION CONDITIONS	68
7.6 TESTRESULTS	69
8 . CONDUCTED SPURIOUS EMISSIONS	70
8.1 LIMIT	70
8.2 TEST PROCEDURE AND SETTING	70
8.3 MEASUREMENT INSTRUMENTS LIST	70
8.4 TEST SETUP	70
8.5 EUT OPERATION CONDITIONS	70
8.6 TESTRESULTS	71
9 . POWER SPECTRAL DENSITY TEST	73
9.1 LIMIT	73
9.2 TEST PROCEDURE AND SETTING	73
9.3 MEASUREMENT INSTRUMENTS LIST	73
9.4 TEST SETUP	73
9.5 EUT OPERATION CONDITIONS	73
9.6 TESTRESULTS	74

1. TEST REPORT DECLARE

Applicant	ZMODO Technology Shenzhen Corp. Ltd.
Address	25/F, Office Tower A, Financial Technology Building, 11 Keyuan Road, Nanshan District, Shenzhen, Guangdong, China
Manufacturer	ZMODO Technology Shenzhen Corp. Ltd.
Address	25/F, Office Tower A, Financial Technology Building, 11 Keyuan Road, Nanshan District, Shenzhen, Guangdong, China
Factory	ZMODO Technology Shenzhen Corp. Ltd.
Address	25/F, Office Tower A, Financial Technology Building, 11 Keyuan Road, Nanshan District, Shenzhen, Guangdong, China
Equipment	Hubbell SpectraSAFE
Model No.	93124134
Trade Mark	N/A
Standard	FCC Part15, Subpart C (15.247) ANSI C63.10-2013

We Declare:

The equipment described above is tested by DongGuan ShuoXin Electronic Technology Co., Ltd. and in the configuration tested the equipment complied with the standards specified above. The test results are contained in this test report and DongGuan ShuoXin Electronic Technology Co., Ltd. is assumed of full responsibility for the accuracy and completeness of these tests.

2. SUMMARY OF TEST RESULTS

The EUT have been tested according to the applicable standards as referenced below:

Standard(s) Section		Test Item	Judgment	Remark
FCC	ISED			
15.207	--	AC Power Line Conducted Emissions	PASS	-----
15.247(d) 15.205(a) 15.209(a)	--	Radiated Emissions	PASS	-----
15.247(a)(2)	--	Bandwidth	PASS	-----
15.247(b)(3)	--	Maximum Output Power	PASS	-----
15.247(d)	--	Conducted Spurious Emission	PASS	-----
15.247(e)	--	Power Spectral Density	PASS	-----
15.203	--	Antenna Requirement	PASS	Note(2)

Note:

- (1) "N/A" denotes test is not applicable in this test report.
- (2) The device what use a permanently attached antenna were considered sufficient tocomply with the provisions of 15.203.

2.1 MEASUREMENT UNCERTAINTY

Test Item	Uncertainty
Uncertainty for Conduction emission test (9kHz-150kHz)	3.7 dB
Uncertainty for Conduction emission test (150kHz-30MHz)	3.3 dB
Uncertainty for Radiation Emission test (30MHz-200MHz)	4.60 dB (Polarize: V)
	4.60 dB (Polarize: H)
Uncertainty for Radiation Emission test (200MHz-1GHz)	6.10 dB (Polarize: V)
	5.08 dB (Polarize: H)
Uncertainty for Radiation Emission test (1GHz-6GHz)	5.01 dB (Polarize: V)
	5.01 dB (Polarize: H)
Uncertainty for Radiation Emission test (6GHz-18GHz)	5.26 dB (Polarize: V)
	5.26 dB (Polarize: H)
Uncertainty for Radiation Emission test (18GHz-40GHz)	5.06 dB (Polarize: V)
	5.06 dB (Polarize: H)
Uncertainty for radio frequency	$\pm 0.048\text{kHz}$
Uncertainty for conducted RF Power	$\pm 0.32\text{dB}$

Note:

This uncertainty represents an expanded uncertainty expressed at approximately the 95% confidence level using a coverage factor of $k=2$.

3. GENERAL INFORMATION

3.1 GENERAL DESCRIPTION OF EUT

Equipment	Hubbell SpectraSAFE	
Brand Name	N/A	
Test Model	93124134	
Series Model	N/A	
Model Difference(s)	N/A	
Hardware Version	V1.0	
Software Version	V1.0	
PowerSource	Supplied from USB.	
Power Rating	DC 5V	
Operation Frequency	2412 MHz~ 2462 MHz ;2422 MHz~ 2452 MHz	
Modulation Technology	IEEE 802.11b:DSSS IEEE 802.11g:OFDM IEEE 802.11n:OFDM	
Bit Rate of Transmitter	IEEE 802.11b: 11/5.5/2/1 Mbps IEEE 802.11g: 54/48/36/24/18/12/9/6 Mbps IEEE 802.11n: up to 300 Mbps	
Operating Mode	IEEE 802.11b:1TX IEEE 802.11g:1TX IEEE 802.11n (HT20):1TX IEEE 802.11n (HT40):1TX	
Antenna Information	Antenna Type:Integral ant	Maximum Peak Gain: 3dBi
Max. Output Power	IEEE 802.11b: 17.83dBm(0.0607W) IEEE 802.11g: 19.03dBm(0.0800W) IEEE 802.11n (HT20):18.98dBm(0.0791W) IEEE 802.11n (HT40):18.57dBm(0.0719W)	

Note:

1. For a more detailed features description, please refer to the manufacturer's specifications or the user's manual.

2. Channel List:

CH01 - CH11 for IEEE 802.11b, IEEE 802.11g, IEEE 802.11n (HT20) CH03-CH09 for IEEE 802.11n (HT40)							
Channel	Frequency (MHz)	Channel	Frequency (MHz)	Channel	Frequency (MHz)	Channel	Frequency (MHz)
01	2412	04	2427	07	2442	10	2457
02	2417	05	2432	08	2447	11	2462
03	2422	06	2437	09	2452		

3.2 DESCRIPTION OF TEST MODES

The test system was pre-tested based on the consideration of all possible combinations of EUT operation mode.

Pretest Mode	Description
Mode 1	TX B Mode Channel 01/06/11
Mode 2	TX G Mode Channel 01/06/11
Mode 3	TX N-20 MHz Mode Channel 01/06/11
Mode 4	TX N-40 MHz Mode Channel03/06/09
Mode 5	TX G Mode Channel 11

Following mode(s) as (were) found to be the worst case(s) and selected for the final test.

AC power line conducted emissions test	
Final Test Mode	Description
Mode 5	TX G Mode Channel 11

Radiated emissions test - Below 1GHz	
Final Test Mode	Description
Mode 5	TX G Mode Channel 11

Radiated emissions test- Above 1GHz	
Final Test Mode	Description
Mode 1	TX B Mode Channel 01/06/11
Mode 2	TX G Mode Channel 01/06/11
Mode 3	TX N-20 MHz Mode Channel 01/06/11
Mode 4	TX N-40 MHz Mode Channel03/06/09

Conducted test	
Final Test Mode	Description
Mode 1	TX B Mode Channel 01/06/11
Mode 2	TX G Mode Channel 01/06/11
Mode 3	TX N-20 MHz Mode Channel 01/06/11
Mode 4	TX N-40 MHz Mode Channel03/06/09

NOTE:

(1) The measurements are performed at the high, middle, low available channels.

(2) 802.11b mode: DBPSK (1Mbps)

802.11g mode: OFDM (6Mbps)

802.11n HT20 mode : BPSK (13Mbps)

802.11n HT40mode : BPSK (27Mbps)

For radiated emission tests, the highest output powers were set for final test.

(3) For radiated emission below 1GHz and AC power line conducted emissions test, the IEEE 802.11n20 channel 11 is found to be the worst case and recorded.

3.3 PARAMETERS OF TEST SOFTWARE

Test Software	Realtek 11n 8188F USB WLAN MP Diagnostic Program		
Frequency (MHz)	2412	2437	2462
IEEE 802.11b	43	46	46
IEEE 802.11g	49	49	48
IEEE 802.11n (HT20)	52	52	52
Test Frequency (MHz)	2422	2437	2452
IEEE 802.11n (HT40)	54	53	54

3.4 BLOCK DIAGRAM SHOWING THE CONFIGURATION OF SYSTEM TESTED

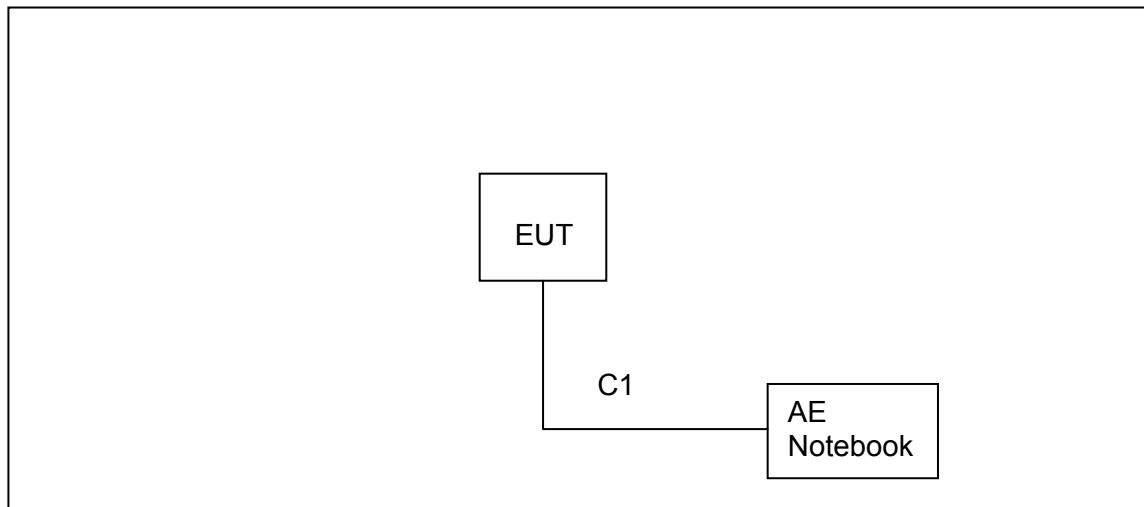

3.5 SUPPORT UNITS

Item	Equipment	Brand	Model No.	Series No.
AE	Notebook	ACER	MS2367	32807810766

Item	Cable Type	Shielded Type	Ferrite Core	Length
C1	DC Cable	NO	NO	0.8m

3.6 TEST ENVIRONMENT CONDITIONS

Test Item	Temperature	Humidity	Test Voltage
AC Power Line Conducted Emissions	25°C	53%	DC 5V
Radiated Emissions-9K-30MHz	25°C	60%	DC 5V
Radiated Emissions-30 MHz to 1GHz	24°C	68%	DC 5V
Radiated Emissions-Above 1000 MHz	24°C	68%	DC 5V
Bandwidth	24.8°C	40.9%	DC 5V
Maximum Output Power	24.8°C	40.9%	DC 5V
Conducted Spurious Emission	24.8°C	40.9%	DC 5V
Power Spectral Density	24.8°C	40.9%	DC 5V

3.7 DUTY CYCLE

All tests are set to 100%duty cycle

If duty cycle is $\geq 98\%$, duty factor is not required.

If duty cycle is $< 98\%$, duty factor shall be considered, the Duty Factor = $10 \log(1/\text{Duty cycle})$, the output power = measured power + duty factor, the result of duty factor as below table:

IEEE 802.11b	IEEE 802.11g	IEEE 802.11n (HT20)	IEEE 802.11n (HT40)
0.00	0.00	0.00	0.00

4. AC POWER LINE CONDUCTED EMISSIONS TEST

4.1 LIMIT

Frequency of Emission (MHz)	Limit (dB μ V)	
	Quasi-peak	Average
0.15 -0.50	66 to 56*	56 to 46*
0.50 -5.0	56	46
5.0 -30.0	60	50

NOTE:

- (1) The tighter limit applies at the band edges.
- (2) The limit of " * " marked band means the limitation decreases linearly with the logarithm of the frequency in the range.

The following table is the setting of the receiver

Receiver Parameters	Setting
Attenuation	10 dB
Start Frequency	0.15 MHz
Stop Frequency	30 MHz
IF Bandwidth	9 kHz

4.2 TEST PROCEDURE

- a. The EUT was placed 0.8 meters from the horizontal ground plane with EUT being connected to the power mains through a line impedance stabilization network (LISN). All other support equipment powered from additional LISN(s). The LISN provide 50 Ohm/ 50uH of coupling impedance for the measuring instrument.
- b. Interconnecting cables that hang closer than 40 cm to the ground plane shall be folded back and forth in the center forming a bundle 30 to 40 cm long.
- c. I/O cables that are not connected to a peripheral shall be bundled in the center. The end of the cable may be terminated, if required, using the correct terminating impedance. The overall length shall not exceed 1 m.
- d. LISN at least 80 cm from nearest part of EUT chassis.

4.3 MEASUREMENT INSTRUMENTS LIST

Item	Kind of Equipment	Manufacturer	Type No.	Serial No.	Calibrated until
1	Pulse Limiter	MTS-systemtechnik	MTS-IMP-136	261115-010-0024	12/11/2020
2	EMI Test Receiver	R&S	ESCI	101308	12/11/2020
3	LISN	AFJ	LS16	16011103219	06/09/2020
4	LISN	Schwarzbeck	NSLK 8127	8127-432	12/11/2020
5	Measurement Software	Farad	EZ-EMC (Ver.ATT-03A)	N/A	N/A

4.4 TESTSETUP

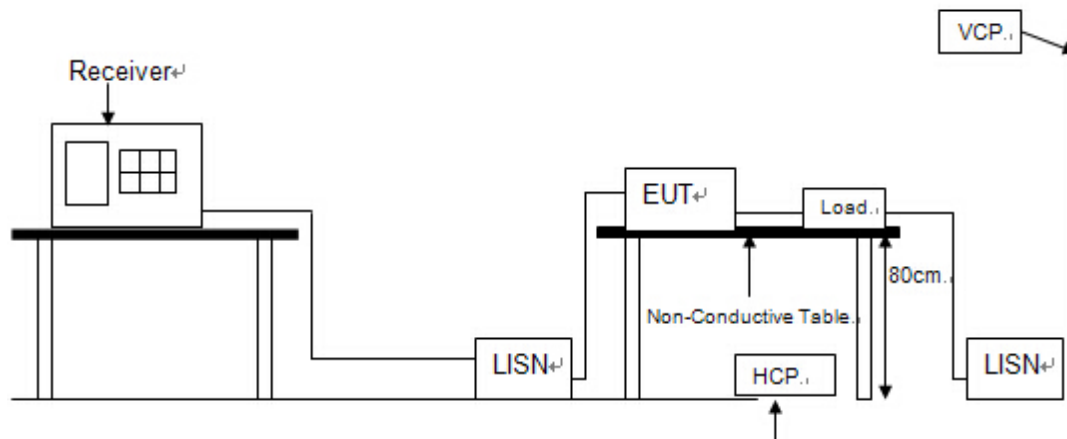

4.5 EUT OPERATION CONDITIONS

The EUT was configured for testing in a typical fashion (as a customer would normally use it). The EUT has been programmed to continuously transmit during test. This operating condition was tested and used to collect the included data.

4.6 TEST RESULTS

Test Mode: TX G Mode Channel 11

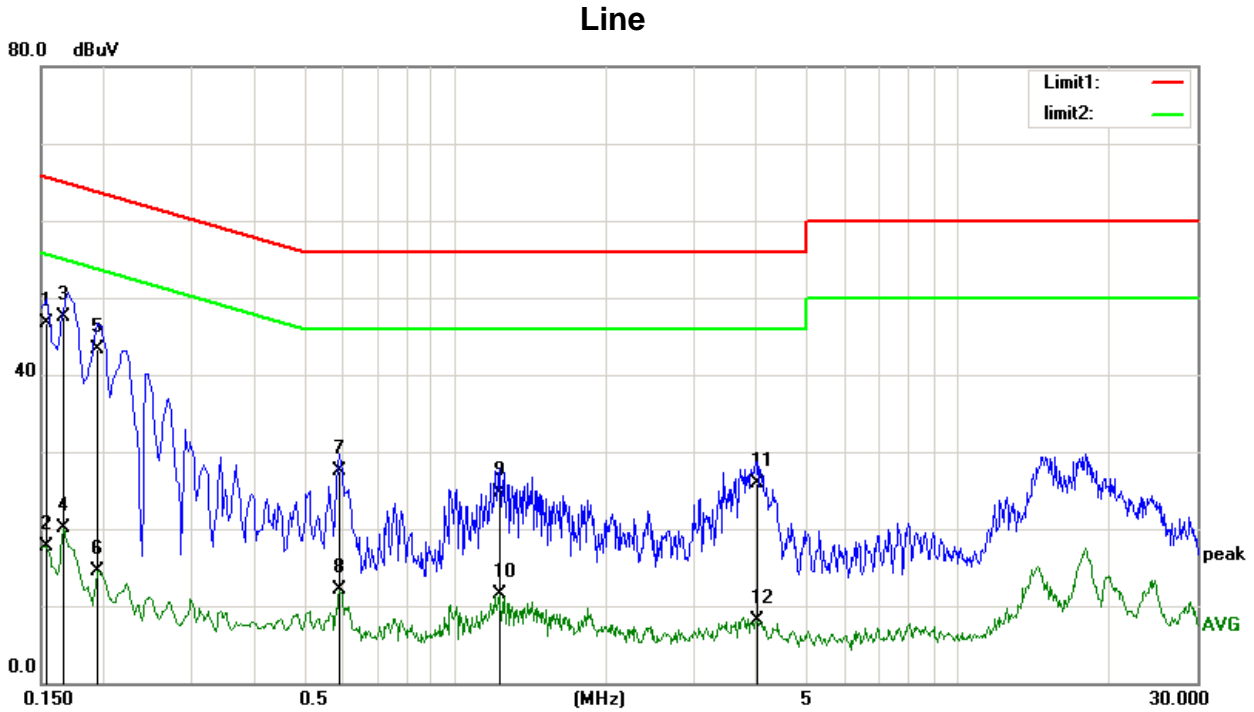

No.	Frequency (MHz)	Reading (dBuV)	Correct Factor(dB)	Result (dBuV)	Limit (dBuV)	Margin (dB)	Remark
1	0.1539	35.34	11.44	46.78	65.78	-19.00	QP
2	0.1539	6.35	11.44	17.79	55.78	-37.99	AVG
3	0.1660	36.18	11.36	47.54	65.15	-17.61	QP
4	0.1660	8.70	11.36	20.06	55.15	-35.09	AVG
5	0.1940	32.06	11.17	43.23	63.86	-20.63	QP
6	0.1940	3.35	11.17	14.52	53.86	-39.34	AVG
7	0.5899	17.41	10.15	27.56	56.00	-28.44	QP
8	0.5899	2.00	10.15	12.15	46.00	-33.85	AVG
9	1.2260	14.65	10.10	24.75	56.00	-31.25	QP
10	1.2260	1.37	10.10	11.47	46.00	-34.53	AVG
11	4.0060	15.79	10.14	25.93	56.00	-30.07	QP
12	4.0060	-2.13	10.14	8.01	46.00	-37.99	AVG

Remarks:

- (1) Measurement Value = Reading Level + Correct Factor.
- (2) Margin Level = Measurement Value - Limit Value.

Test Mode: TX G Mode Channel 11

Neutral

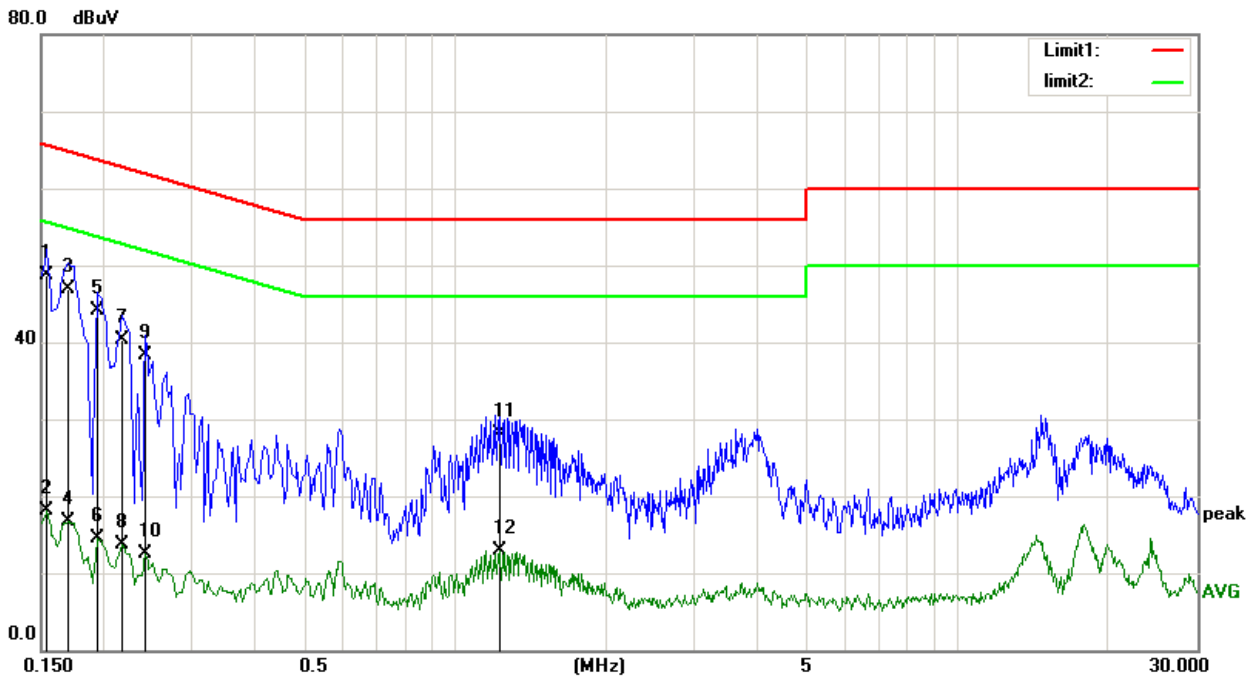

No.	Frequency (MHz)	Reading (dBuV)	Correct Factor(dB)	Result (dBuV)	Limit (dBuV)	Margin (dB)	Remark
1	0.1539	37.18	11.44	48.62	65.78	-17.16	QP
2	0.1539	6.65	11.44	18.09	55.78	-37.69	AVG
3	0.1700	35.54	11.33	46.87	64.96	-18.09	QP
4	0.1700	5.28	11.33	16.61	54.96	-38.35	AVG
5	0.1940	32.98	11.17	44.15	63.86	-19.71	QP
6	0.1940	3.25	11.17	14.42	53.86	-39.44	AVG
7	0.2180	29.35	11.00	40.35	62.89	-22.54	QP
8	0.2180	2.72	11.00	13.72	52.89	-39.17	AVG
9	0.2420	27.44	10.84	38.28	62.02	-23.74	QP
10	0.2420	1.58	10.84	12.42	52.02	-39.60	AVG
11	1.2260	18.01	10.10	28.11	56.00	-27.89	QP
12	1.2260	2.77	10.10	12.87	46.00	-33.13	AVG

Remarks:

- (1) Measurement Value = Reading Level + Correct Factor.
- (2) Margin Level = Measurement Value - Limit Value.

5. RADIATED EMISSIONSTEST

5.1 LIMIT

In case the emission fall within the restricted band specified on 15.205(a), then the 15.209(a) and limit in the table below has to be followed.

LIMITS OF RADIATED EMISSION MEASUREMENT (9 kHz-1000MHz)

Frequency (MHz)	Field Strength (microvolts/meter)	Measurement Distance (meters)
0.009-0.490	2400/F(kHz)	300
0.490-1.705	24000/F(kHz)	30
1.705-30.0	30	30
30-88	100	3
88-216	150	3
216-960	200	3
Above 960	500	3

LIMITS OF RADIATED EMISSION MEASUREMENT (9 kHz-30 MHz)

Frequency (MHz)	Magnetic field strength (H-Field) (μ A/m)	Measurement Distance (meters)
0.009-0.490	6.37/F(kHz)	300
0.490-1.705	6.37/F(kHz)	30
1.705-30.0	0.08	30

LIMITS OF RADIATED EMISSION MEASUREMENT (30 MHz-1000MHz)

Frequency (MHz)	Field Strength (μ V/m at 3m)
30-88	100
88-216	150
216-960	200
Above 960	500

LIMITS OF RADIATED EMISSION MEASUREMENT (Above 1000MHz)

Frequency (MHz)	(dBuV/m at 3 m)	
	Peak	Average
Above 1000	74	54

NOTE:

- (1) The limit for radiated test was performed according to FCC PART 15C and RSS-247.
- (2) The tighter limit applies at the band edges.
- (3) Emission level (dBuV/m)=20log Emission level (uV/m).

5.2 TEST PROCEDURE

- a. The measuring distance of 3 m shall be used for measurements. The EUT was placed on the top of a rotating table 0.8 meter above the ground at a 3 meter semi-anechoic chamber. The table was rotated 360 degrees to determine the position of the highest radiation.(below 1GHz)
- b. The measuring distance of 3 m shall be used for measurements. The EUT was placed on the top of a rotating table 1.5 meter above the ground at a 3 meter semi-anechoic chamber. The table was rotated 360 degrees to determine the position of the highest radiation.(above 1GHz)
- c. The height of the equipment or of the substitution antenna shall be 0.8m or 1.5m; the height of the test antenna shall vary between 1 m to 4 m. Both horizontal and vertical polarizations of the antenna are set to make the measurement.
- d. For each suspected emission, the EUT was arranged to its worst case and then the antenna was tuned to heights find the maximum reading (used Bore sight function).
- e. The receiver system was set to peak and average detect function and specified bandwidth with maximum hold mode when the test frequency is above 1GHz.
- f. The initial step in collecting radiated emission data is a receiver peak detector mode pre-scanning the measurement frequency range. Significant peaks are then marked and then Quasi Peak detector mode re-measured.
- g. All readings are Peak unless otherwise stated QP in column of Note. Peak denotes that the Peak reading compliance with the QP Limits and then QP Mode measurement didn't perform. (below 1GHz)
- h. All readings are Peak Mode value unless otherwise stated AVG in column of Note. If the Peak Mode Measured value compliance with the Peak Limits and lower than AVG Limits, the EUT shall be deemed to meet both Peak & AVG Limits and then only Peak Mode was measured, but AVG Mode didn't perform. (above 1GHz)
- i. The test result is calculated as the following:
 - (1) Result = Reading + Correct Factor
 - (2) Correct Factor = Antenna Factor + Cable Loss – Amplifier Gain + Attenuator
 - (3) Margin = Result - Limit

Spectrum Parameter	Setting
Attenuation	Auto
Start Frequency	1000 MHz
Stop Frequency	10th carrier harmonic
RBW / VBW (Emission in restricted band)	1MHz / 3MHz for Peak, 1MHz / 1/T for Average

Receiver Parameter	Setting
Attenuation	Auto
Start ~ Stop Frequency	9 kHz~90 kHz for PK/AVG detector
Start ~ Stop Frequency	90 kHz~110 kHz for QP detector
Start ~ Stop Frequency	110 kHz~490 kHz for PK/AVG detector
Start ~ Stop Frequency	490 kHz~30 MHz for QP detector
Start ~ Stop Frequency	30MHz~1000MHz for QP detector

5.3 MEASUREMENT INSTRUMENTS LIST

Item	Equipment	Manufacturer	Model No.	Serial No.	Calibrated until
1	EMI Test Receiver	R&S	ESCI	101307	12/12/2020
2	Spectrum Analyzer	Agilent	E4407B	US40240708	11/17/2020
3	Loop antenna	SCHWARZBECK K	FMZB1519	1519-062	12/14/2020
4	Broadband antenna	SCHWARZBECK	VULB9168	VULB9168-192	03/22/2021
5	HORN ANTENNA	SCHWARZBECK	BBHA9120D	9120D 1065	04/21/2021
6	Preamplifier Amplifier	HP	8447F	3113A05680	12/11/2020
7	PRE-AMPLIFIER	CY	EMC011830	980136	12/11/2020
8	RF Cable	R&S	Test Cable 4	4	12/11/2020
9	RF Cable	R&S	Test Cable 5	5	12/11/2020
10	RF Cable	R&S	Test Cable 9	9	04/22/2020
11	RF Cable	R&S	Test Cable 10	10	12/11/2020
12	Measurement Software	Farad	EZ-EMC (Ver.ATT-03A)	N/A	N/A

5.4 TESTSETUP

9 kHz-30 MHz

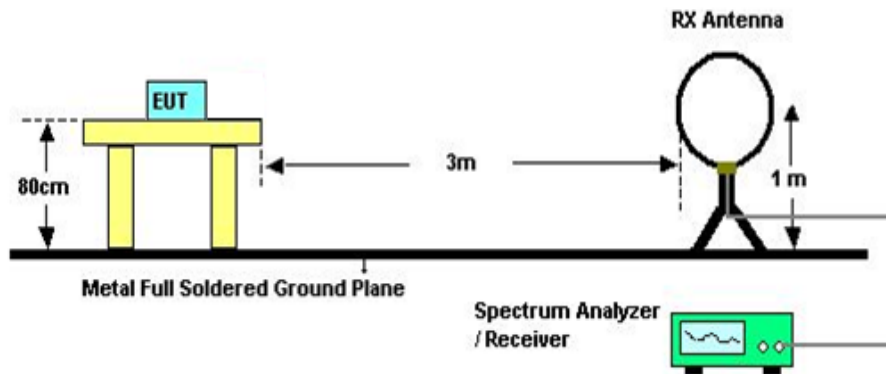

30 MHz to 1 GHz

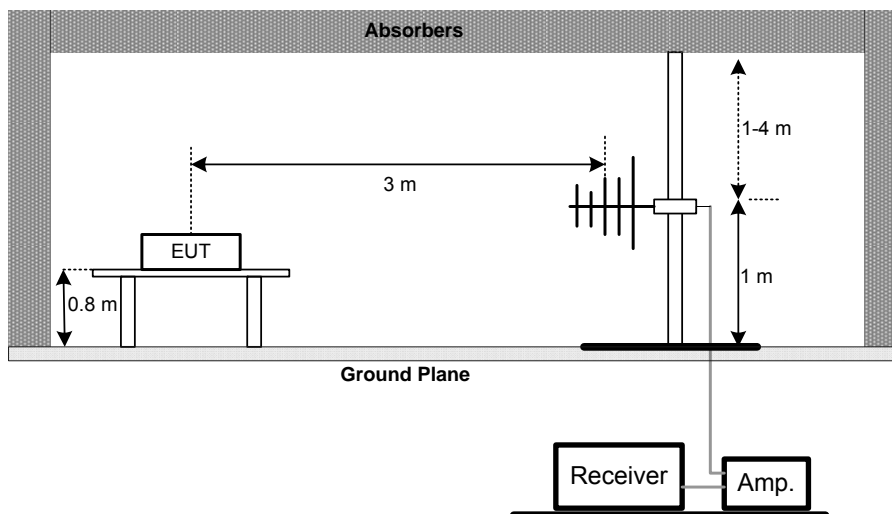

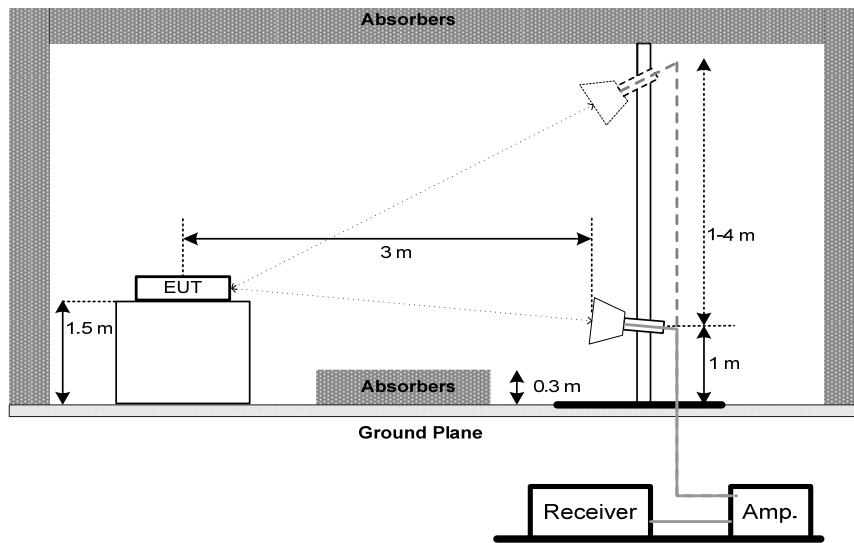
Above 1 GHz**5.5 EUT OPERATION CONDITIONS**

The EUT was programmed to be in continuously transmitting mode.

5.6 TEST RESULTS - 9kHz TO 30MHz

Test Mode:	TX G Mode Channel 11
------------	----------------------

Freq.	Reading	Limit	Margin	State
(MHz)	(dBuV/m)	(dBuV/m)	(dB)	P/F
--	--	--	--	P
--	--	--	--	P

Note:

The amplitude of spurious emissions which are attenuated by more than 20dB below the permissible value has no need to be reported.

Distance extrapolation factor = $20 \log (\text{specific distance}/\text{test distance})(\text{dB})$;

Limit line = specific limits(dBuv) + distance extrapolation factor

5.7 TEST RESULTS - 30MHz TO 1000MHz

Test Mode : TX G Mode Channel 11

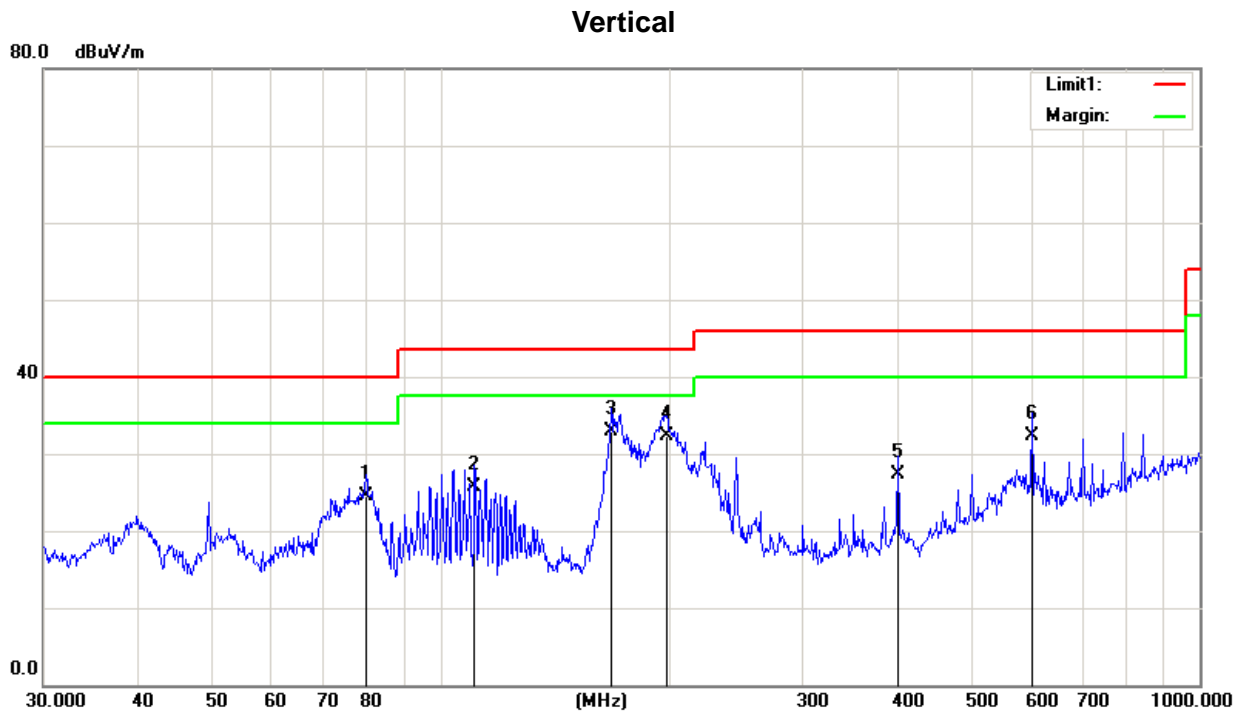

No.	Frequency (MHz)	Reading (dBuV/m)	Correct Factor(dB/m)	Result (dBuV/m)	Limit (dBuV/m)	Margin (dB)	Remark
1	79.8002	40.01	-15.51	24.50	40.00	-15.50	QP
2	110.9570	39.84	-14.04	25.80	43.50	-17.70	QP
3	167.8242	43.35	-10.48	32.87	43.50	-10.63	QP
4	198.5879	43.52	-11.22	32.30	43.50	-11.20	QP
5	400.4318	33.97	-6.72	27.25	46.00	-18.75	QP
6	601.4265	35.71	-3.35	32.36	46.00	-13.64	QP

Test Mode : TX G Mode Channel 11

Horizontal

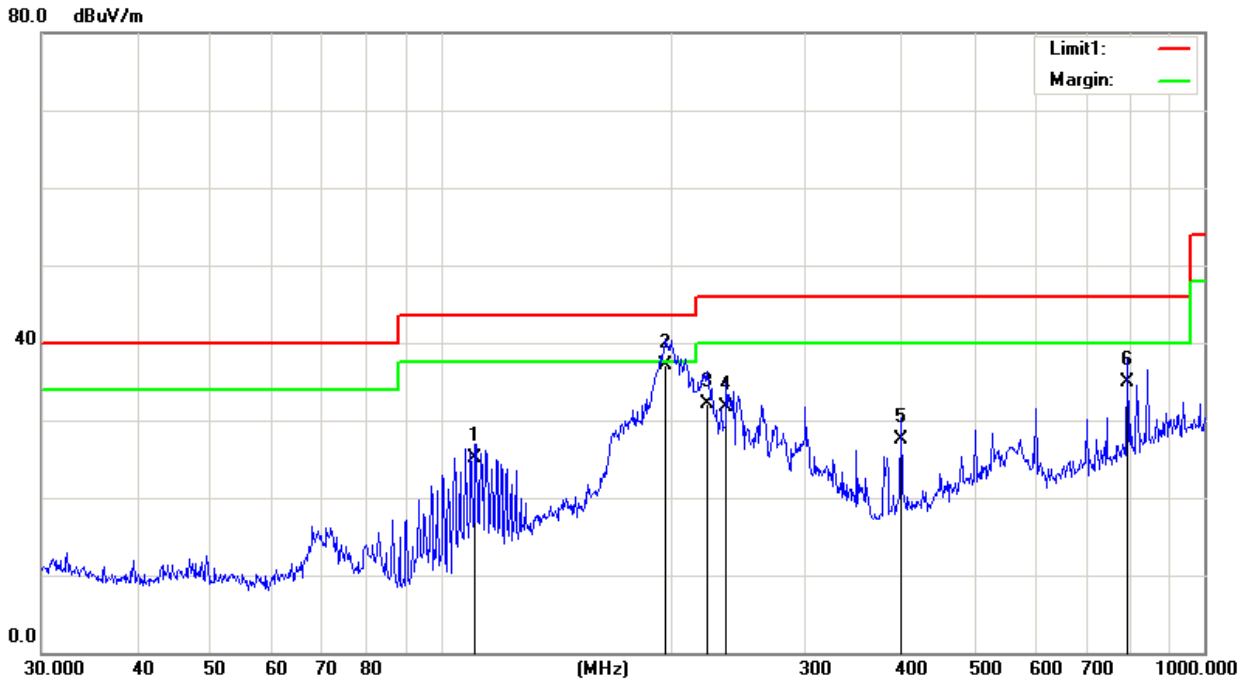

No.	Frequency (MHz)	Reading (dBuV/m)	Correct Factor(dB/m)	Result (dBuV/m)	Limit (dBuV/m)	Margin (dB)	Remark
1	110.9570	39.24	-14.23	25.01	43.50	-18.49	QP
2	197.2000	46.58	-9.41	37.17	43.50	-6.33	QP
3	223.7333	40.31	-8.23	32.08	46.00	-13.92	QP
4	236.6447	38.74	-7.08	31.66	46.00	-14.34	QP
5	400.4318	34.25	-6.81	27.44	46.00	-18.56	QP
6	793.3958	34.19	0.65	34.84	46.00	-11.16	QP

5.8 TEST RESULTS- ABOVE 1000MHz(BAND EDGE)

Orthogonal Axis	X
Test Mode:	TX B Mode2412 MHz

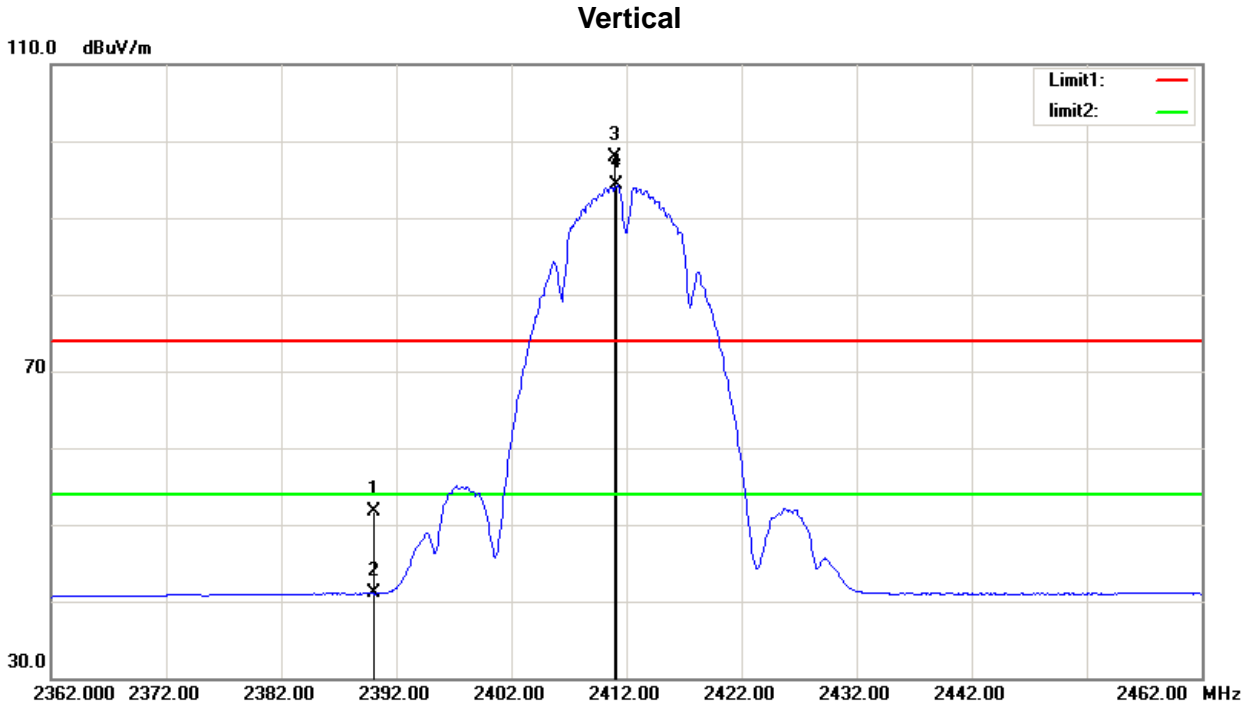

No.	Frequency (MHz)	Reading (dBuV/m)	Correct Factor(dB/m)	Result (dBuV/m)	Limit (dBuV/m)	Margin (dB)	Remark
1	2390.000	20.04	31.62	51.66	74.00	-22.34	peak
2	2390.000	9.39	31.62	41.01	54.00	-12.99	AVG
3	2411.000	66.15	31.68	97.83	/	/	peak
4	2411.200	62.60	31.68	94.28	/	/	AVG

Orthogonal Axis	X
Test Mode:	TX B Mode2412 MHz

Horizontal

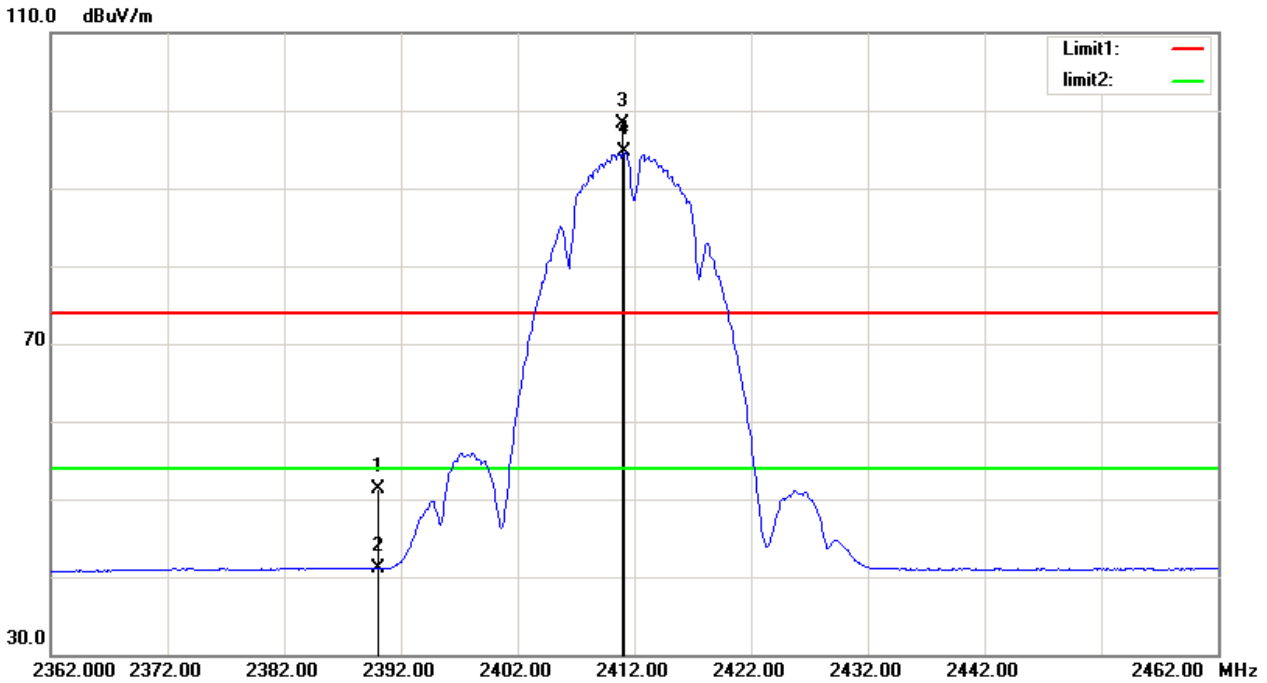

No.	Frequency (MHz)	Reading (dBuV/m)	Correct Factor(dB/m)	Result (dBuV/m)	Limit (dBuV/m)	Margin (dB)	Remark
1	2390.000	19.77	31.62	51.39	74.00	-22.61	peak
2	2390.000	9.47	31.62	41.09	54.00	-12.91	AVG
3	2411.000	66.60	31.68	98.28	/	/	peak
4	2411.200	63.02	31.68	94.70	/	/	AVG

Orthogonal Axis	X
Test Mode:	TX B Mode2462 MHz

Vertical

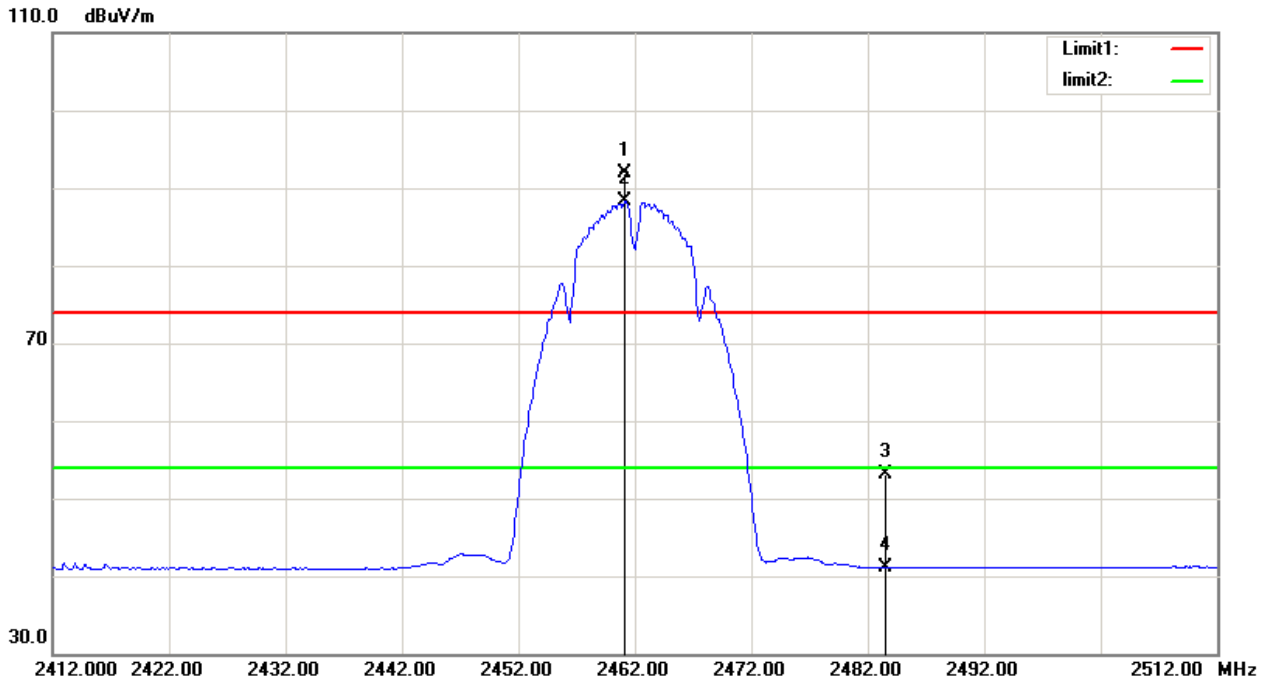

No.	Frequency (MHz)	Reading (dBuV/m)	Correct Factor(dB/m)	Result (dBuV/m)	Limit (dBuV/m)	Margin (dB)	Remark
1	2461.100	60.10	31.83	91.93	/	/	peak
2	2461.200	56.51	31.83	88.34	/	/	AVG
3	2483.500	21.28	31.89	53.17	74.00	-20.83	peak
4	2483.500	9.22	31.89	41.11	54.00	-12.89	AVG

Orthogonal Axis	X
Test Mode:	TX B Mode2462 MHz

Horizontal

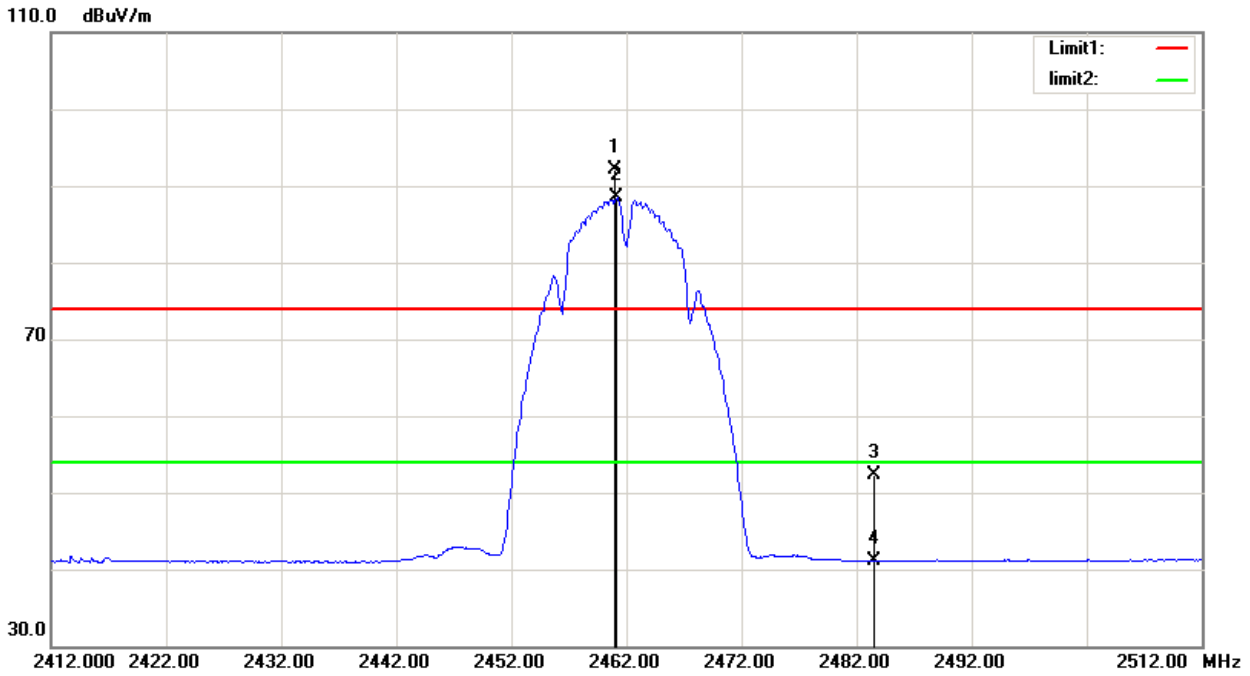

No.	Frequency (MHz)	Reading (dBuV/m)	Correct Factor(dB/m)	Result (dBuV/m)	Limit (dBuV/m)	Margin (dB)	Remark
1	2461.000	60.24	31.83	92.07	/	/	peak
2	2461.200	56.61	31.83	88.44	/	/	AVG
3	2483.500	20.32	31.89	52.21	74.00	-21.79	peak
4	2483.500	9.20	31.89	41.09	54.00	-12.91	AVG

Orthogonal Axis	X
Test Mode:	TX G Mode2412 MHz

Vertical

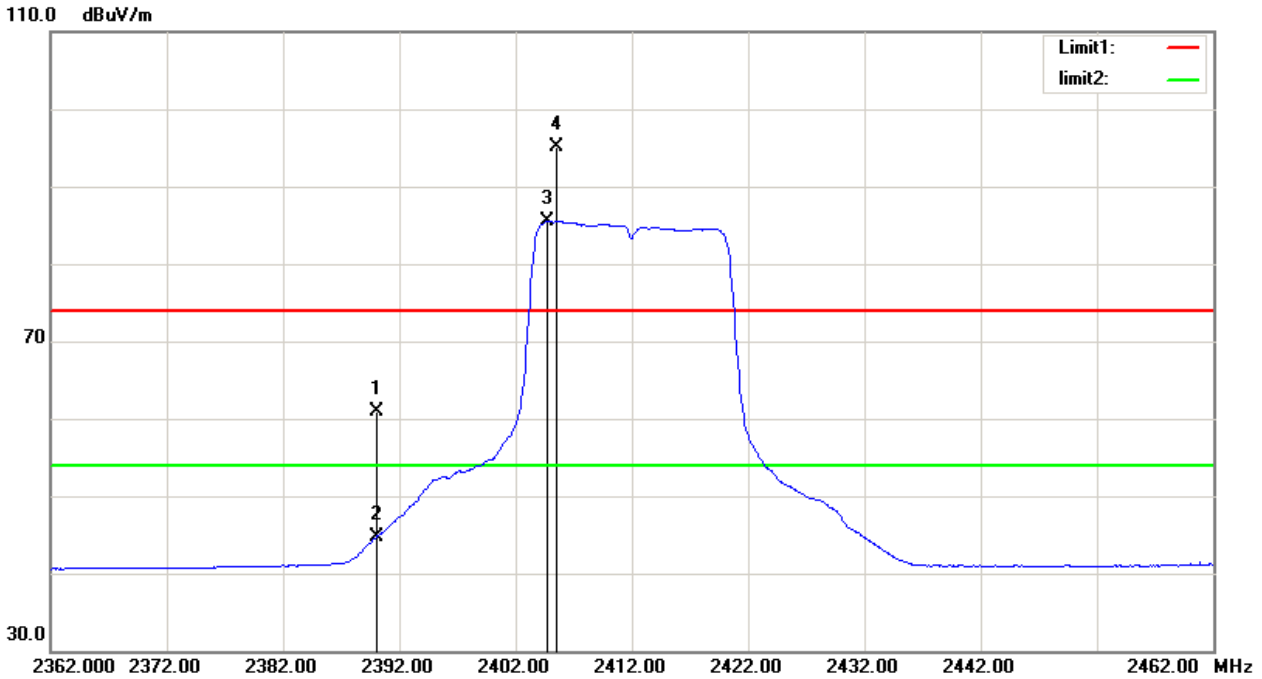

No.	Frequency (MHz)	Reading (dBuV/m)	Correct Factor(dB/m)	Result (dBuV/m)	Limit (dBuV/m)	Margin (dB)	Remark
1	2390.000	29.23	31.62	60.85	74.00	-13.15	peak
2	2390.000	13.06	31.62	44.68	54.00	-9.32	AVG
3	2404.700	53.81	31.65	85.46	/	/	AVG
4	2405.600	63.38	31.66	95.04	/	/	peak

Orthogonal Axis	X
Test Mode:	TX G Mode2412 MHz

Horizontal

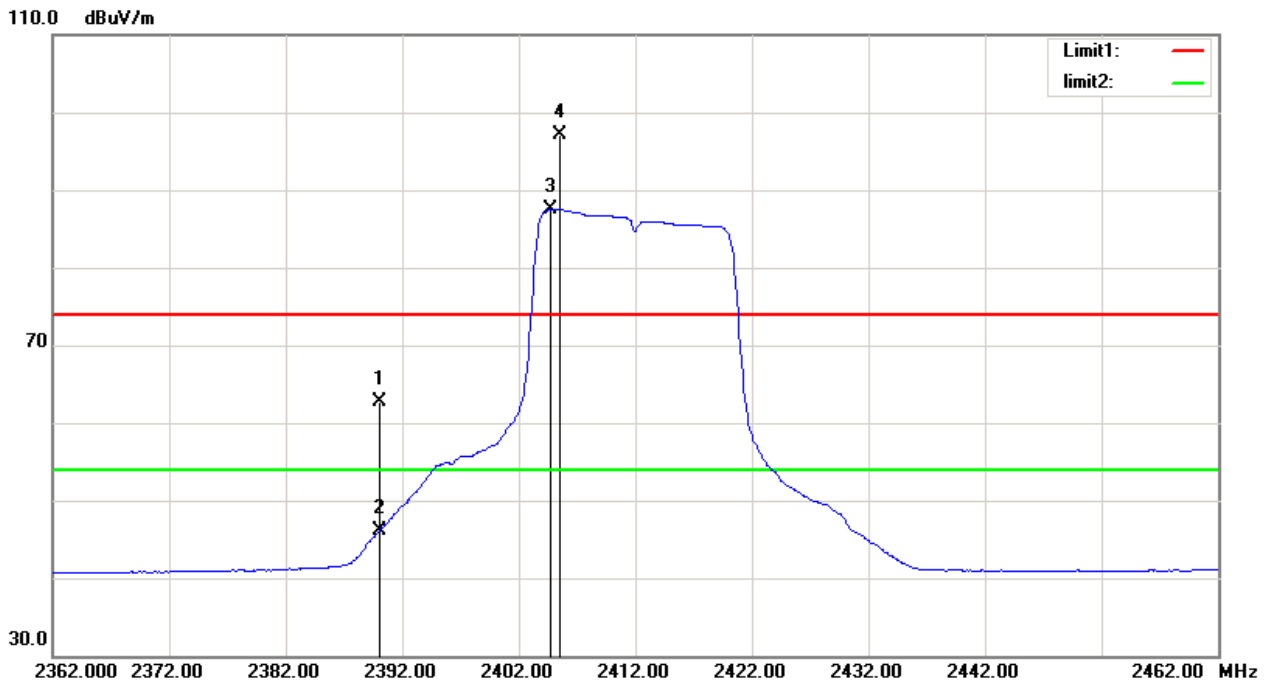

No.	Frequency (MHz)	Reading (dBuV/m)	Correct Factor(dB/m)	Result (dBuV/m)	Limit (dBuV/m)	Margin (dB)	Remark
1	2390.000	31.04	31.62	62.66	74.00	-11.34	peak
2	2390.000	14.48	31.62	46.10	54.00	-7.90	AVG
3	2404.700	55.87	31.65	87.52	/	/	AVG
4	2405.600	65.38	31.66	97.04	/	/	peak

Orthogonal Axis	X
Test Mode:	TX G Mode2462 MHz

Vertical

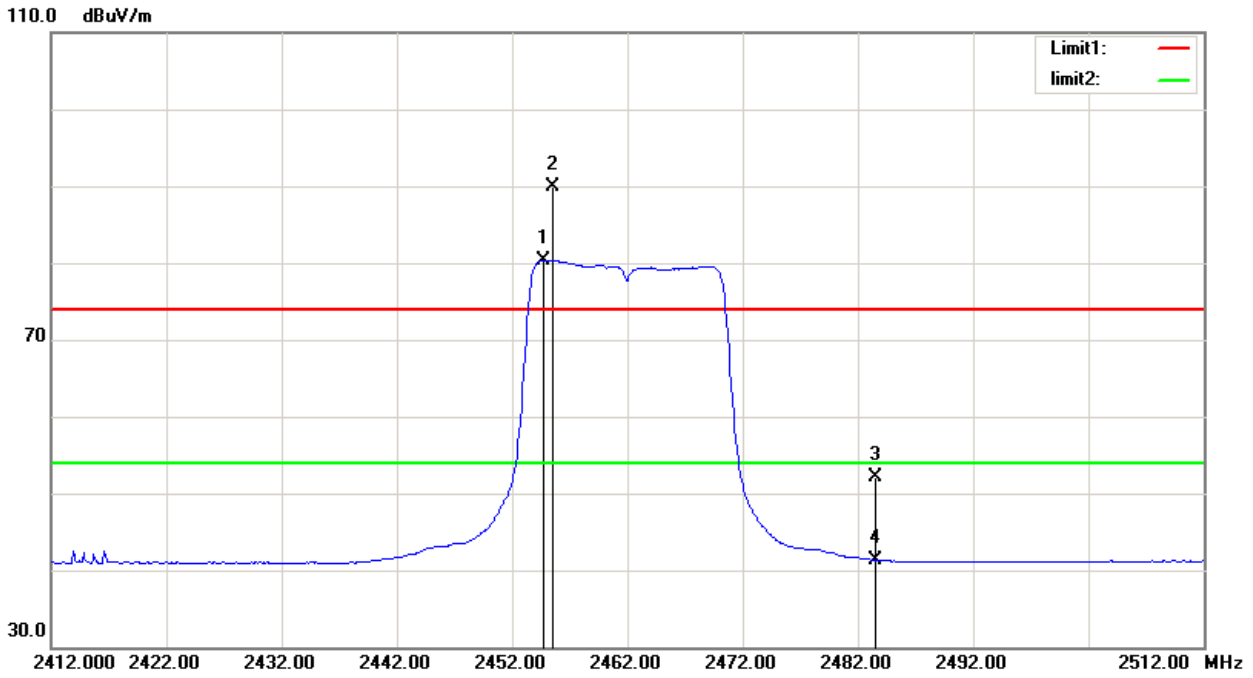

No.	Frequency (MHz)	Reading (dBuV/m)	Correct Factor(dB/m)	Result (dBuV/m)	Limit (dBuV/m)	Margin (dB)	Remark
1	2454.700	48.58	31.81	80.39	/	/	AVG
2	2455.600	58.04	31.81	89.85	/	/	peak
3	2483.500	20.19	31.89	52.08	74.00	-21.92	peak
4	2483.500	9.45	31.89	41.34	54.00	-12.66	AVG

Orthogonal Axis	X
Test Mode:	TX G Mode2462 MHz

Horizontal

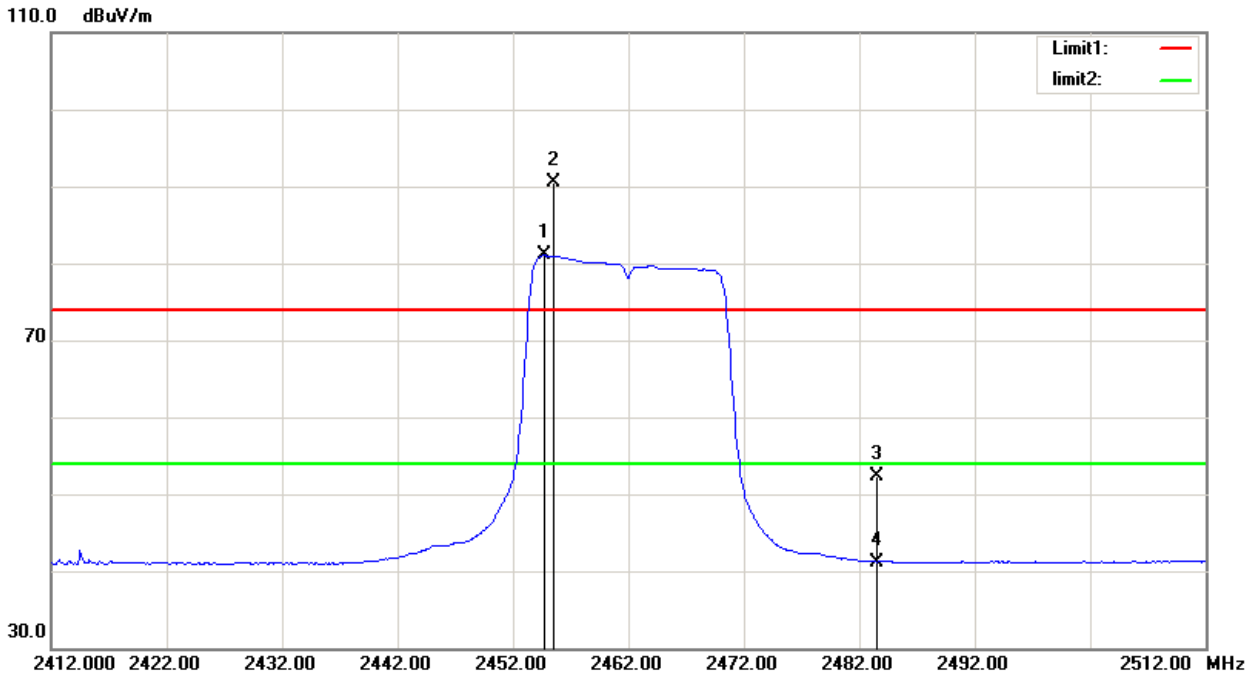

No.	Frequency (MHz)	Reading (dBuV/m)	Correct Factor (dB/m)	Result (dBuV/m)	Limit (dBuV/m)	Margin (dB)	Remark
1	2454.700	49.23	31.81	81.04	/	/	AVG
2	2455.600	58.76	31.81	90.57	/	/	peak
3	2483.500	20.50	31.89	52.39	74.00	-21.61	peak
4	2483.500	9.30	31.89	41.19	54.00	-12.81	AVG

Orthogonal Axis	X
Test Mode:	TX N-20M Mode2412 MHz

Vertical

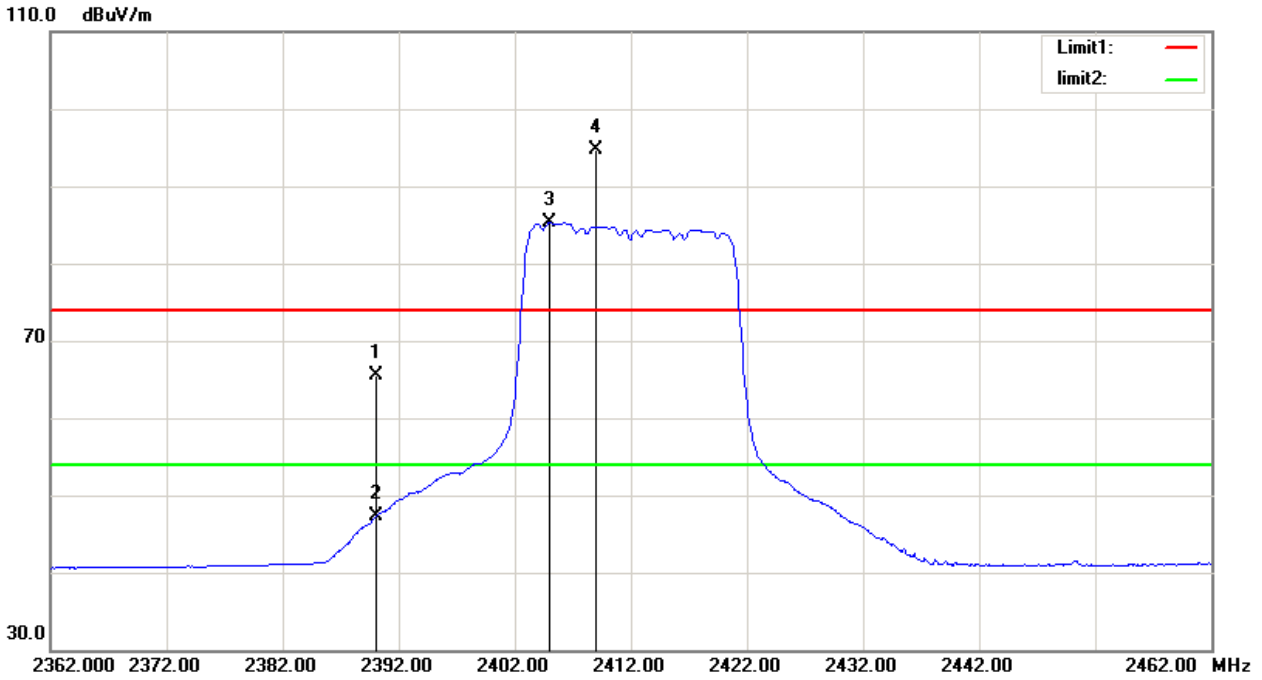

No.	Frequency (MHz)	Reading (dBuV/m)	Correct Factor(dB/m)	Result (dBuV/m)	Limit (dBuV/m)	Margin (dB)	Remark
1	2390.000	33.98	31.62	65.60	74.00	-8.40	peak
2	2390.000	15.63	31.62	47.25	54.00	-6.75	AVG
3	2405.000	53.56	31.66	85.22	/	/	AVG
4	2409.000	62.99	31.67	94.66	/	/	peak

Orthogonal Axis	X
Test Mode:	TX N-20M Mode2412 MHz

Horizontal

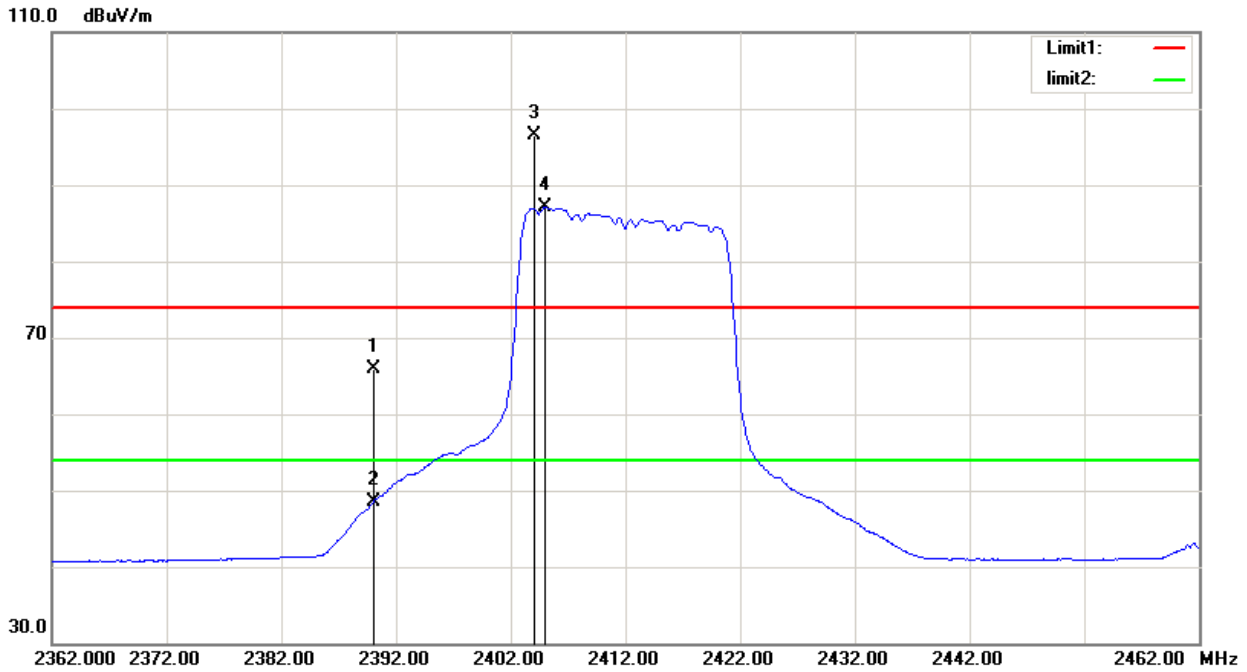

No.	Frequency (MHz)	Reading (dBuV/m)	Correct Factor(dB/m)	Result (dBuV/m)	Limit (dBuV/m)	Margin (dB)	Remark
1	2390.000	34.31	31.62	65.93	74.00	-8.07	peak
2	2390.000	16.91	31.62	48.53	54.00	-5.47	AVG
3	2404.100	64.90	31.65	96.55	/	/	peak
4	2405.000	55.36	31.66	87.02	/	/	AVG

Orthogonal Axis	X
Test Mode:	TX N-20M Mode2462 MHz

Vertical

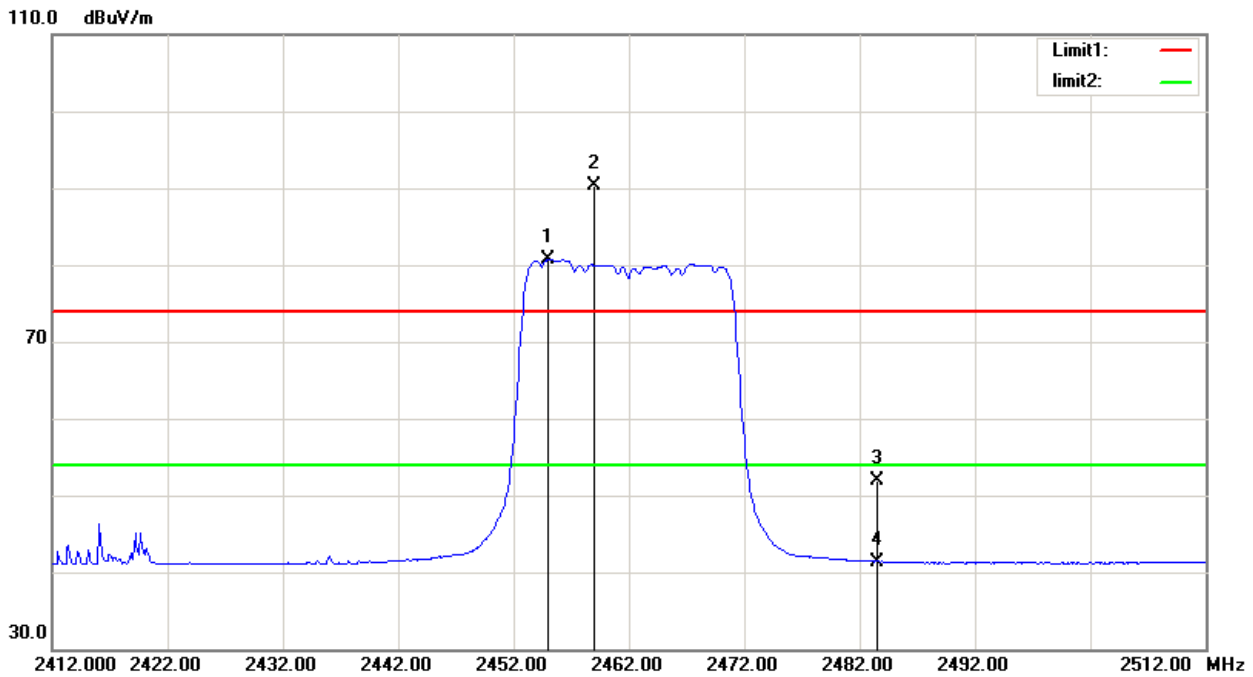

No.	Frequency (MHz)	Reading (dBuV/m)	Correct Factor(dB/m)	Result (dBuV/m)	Limit (dBuV/m)	Margin (dB)	Remark
1	2455.000	48.90	31.81	80.71	/	/	AVG
2	2459.000	58.39	31.82	90.21	/	/	peak
3	2483.500	19.97	31.89	51.86	74.00	-22.14	peak
4	2483.500	9.51	31.89	41.40	54.00	-12.60	AVG

Orthogonal Axis	X
Test Mode:	TX N-20M Mode2462 MHz

Horizontal

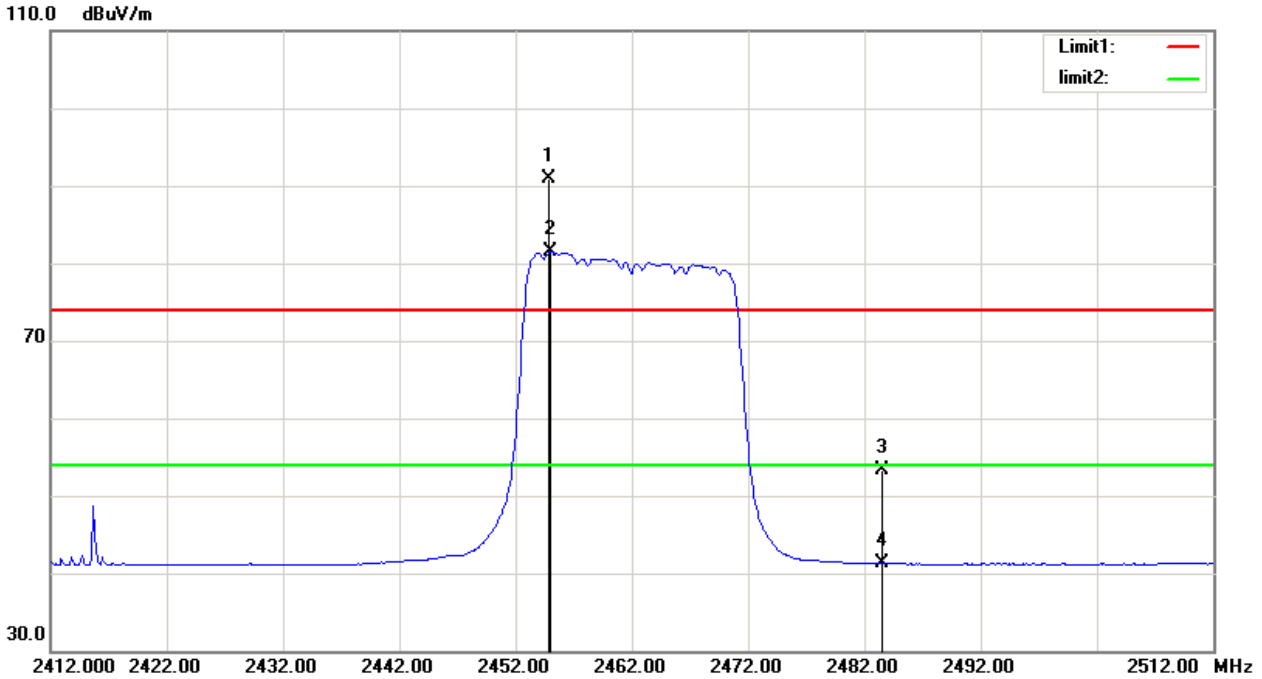

No.	Frequency (MHz)	Reading (dBuV/m)	Correct Factor(dB/m)	Result (dBuV/m)	Limit (dBuV/m)	Margin (dB)	Remark
1	2454.800	59.06	31.81	90.87	/	/	peak
2	2455.000	49.65	31.81	81.46	/	/	AVG
3	2483.500	21.43	31.89	53.32	74.00	-20.68	peak
4	2483.500	9.38	31.89	41.27	54.00	-12.73	AVG

Orthogonal Axis	X
Test Mode:	TX N-40M Mode 2422MHz

Vertical

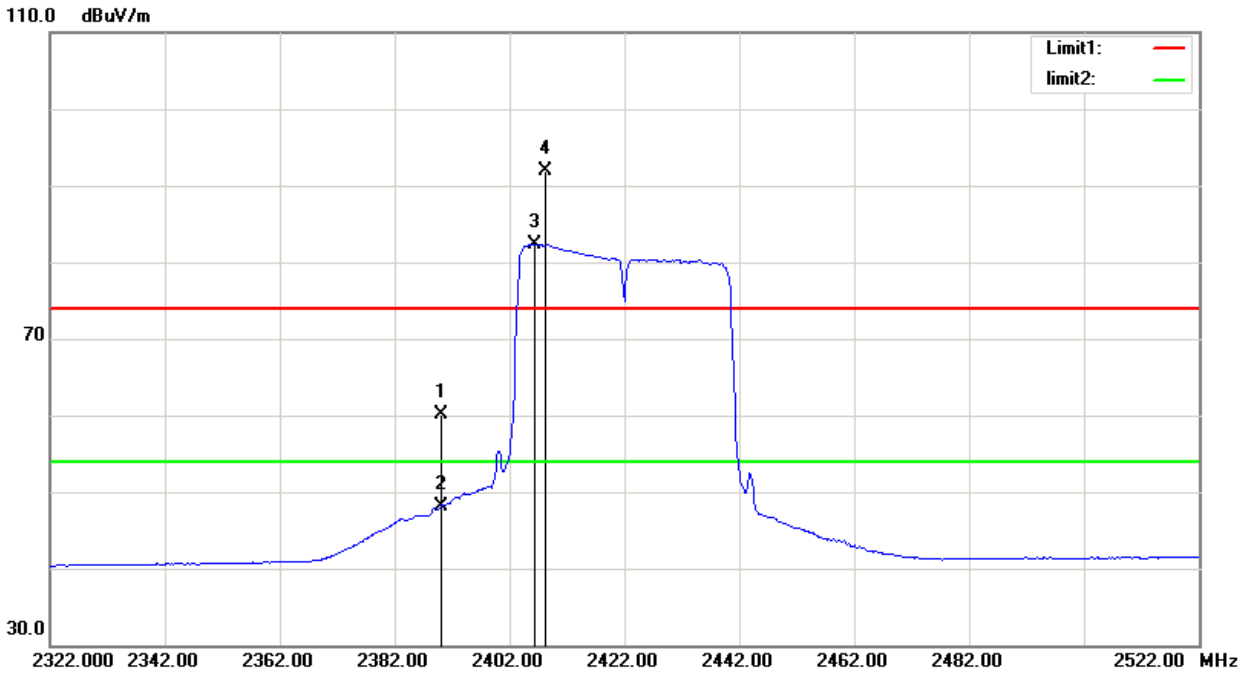

No.	Frequency (MHz)	Reading (dBuV/m)	Correct Factor(dB/m)	Result (dBuV/m)	Limit (dBuV/m)	Margin (dB)	Remark
1	2390.000	28.58	31.62	60.20	74.00	-13.80	peak
2	2390.000	16.44	31.62	48.06	54.00	-5.94	AVG
3	2406.400	50.70	31.67	82.37	/	/	AVG
4	2408.200	60.16	31.67	91.83	/	/	peak

Orthogonal Axis	X
Test Mode:	TX N-40M Mode 2422MHz

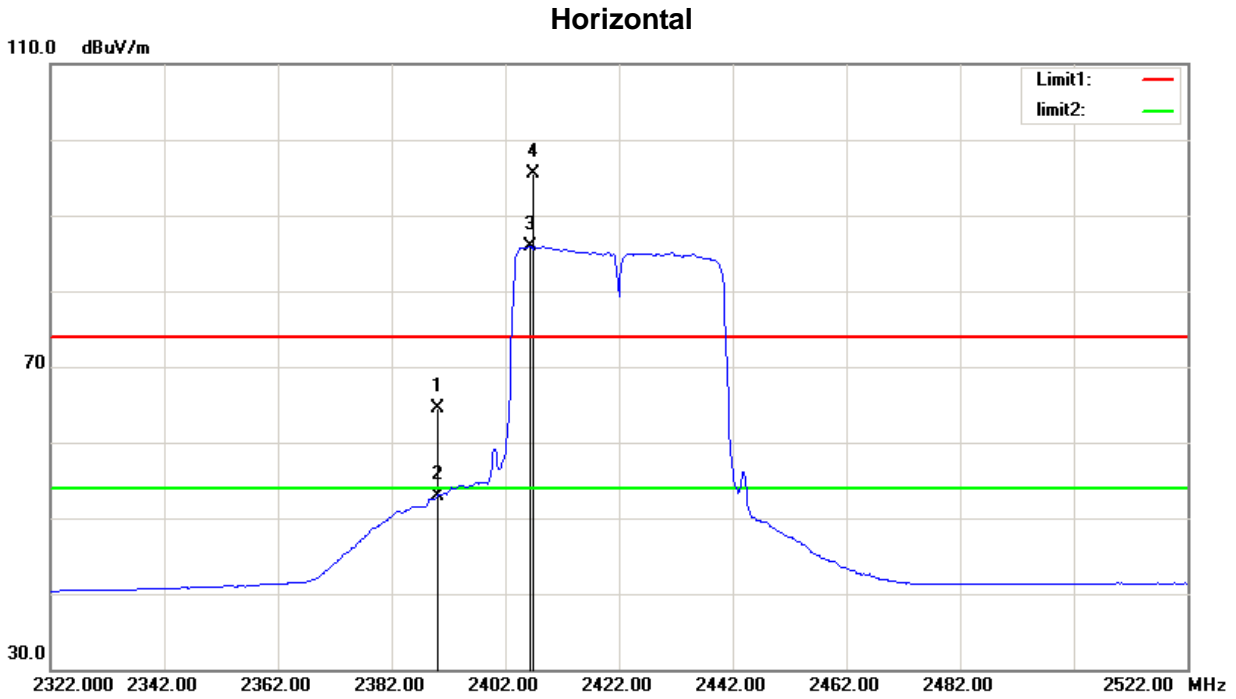

No.	Frequency (MHz)	Reading (dBuV/m)	Correct Factor(dB/m)	Result (dBuV/m)	Limit (dBuV/m)	Margin (dB)	Remark
1	2390.000	32.92	31.62	64.54	74.00	-9.46	peak
2	2390.000	21.24	31.62	52.86	54.00	-1.14	AVG
3	2406.400	54.25	31.67	85.92	/	/	AVG
4	2407.000	63.75	31.67	95.42	/	/	peak

Orthogonal Axis	X
Test Mode:	TX N-40M Mode2452 MHz

Vertical

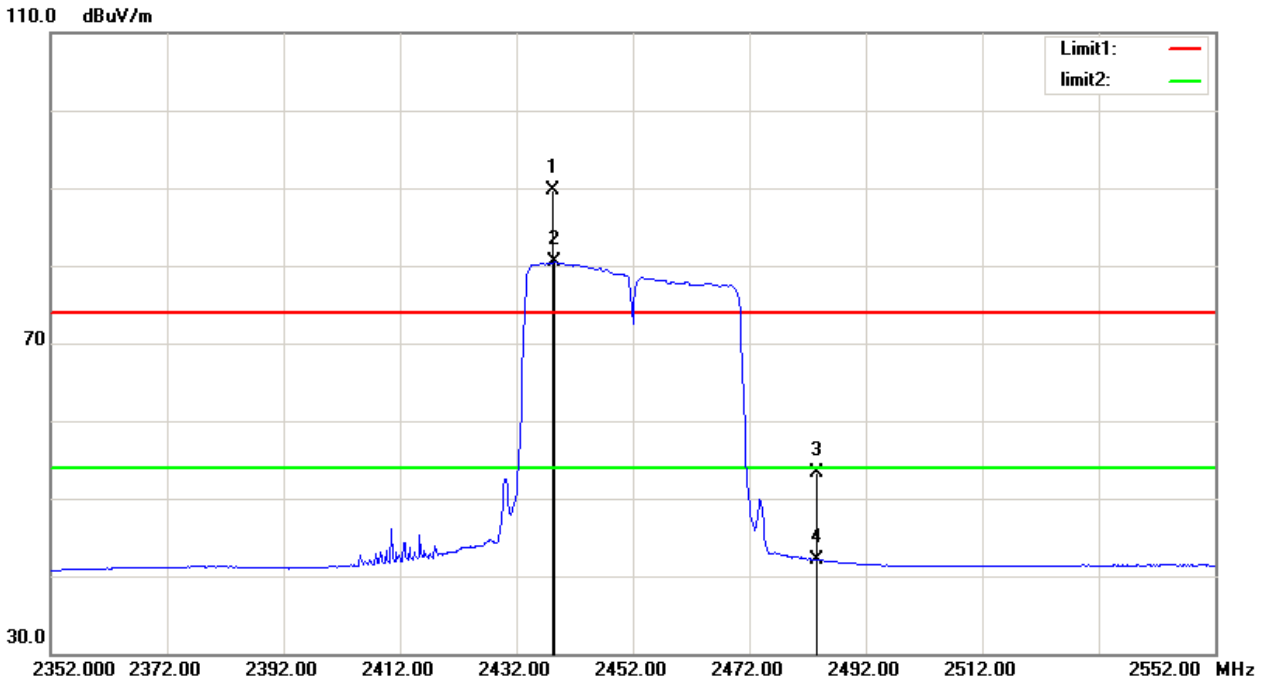

No.	Frequency (MHz)	Reading (dBuV/m)	Correct Factor(dB/m)	Result (dBuV/m)	Limit (dBuV/m)	Margin (dB)	Remark
1	2438.200	58.03	31.76	89.79	/	/	peak
2	2438.400	48.67	31.76	80.43	/	/	AVG
3	2483.500	21.36	31.89	53.25	74.00	-20.75	peak
4	2483.500	10.24	31.89	42.13	54.00	-11.87	AVG

Orthogonal Axis	X
Test Mode:	TX N-40M Mode2452 MHz

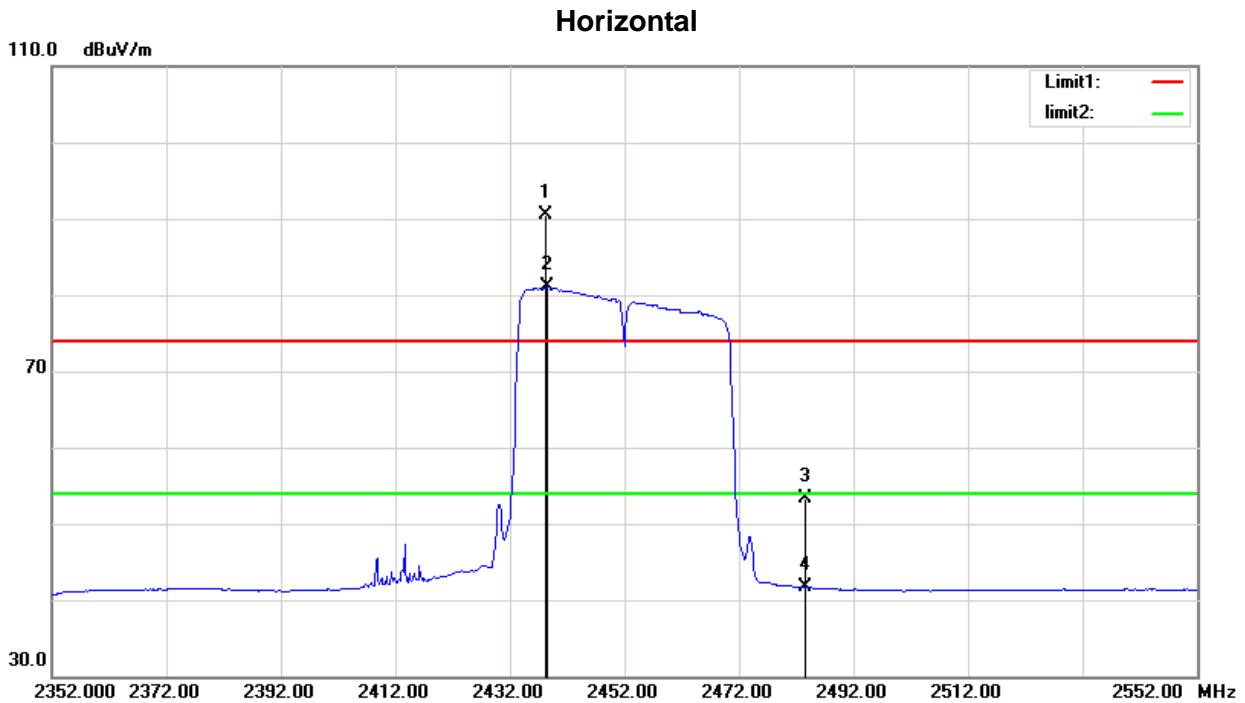

No.	Frequency (MHz)	Reading (dBuV/m)	Correct Factor(dB/m)	Result (dBuV/m)	Limit (dBuV/m)	Margin (dB)	Remark
1	2438.200	58.71	31.76	90.47	/	/	peak
2	2438.400	49.30	31.76	81.06	/	/	AVG
3	2483.500	21.42	31.89	53.31	74.00	-20.69	peak
4	2483.500	9.77	31.89	41.66	54.00	-12.34	AVG

5.9 TEST RESULTS- ABOVE 1000MHz(HARMONIC)

Orthogonal Axis	X
Test Mode:	TX B Mode2412 MHz

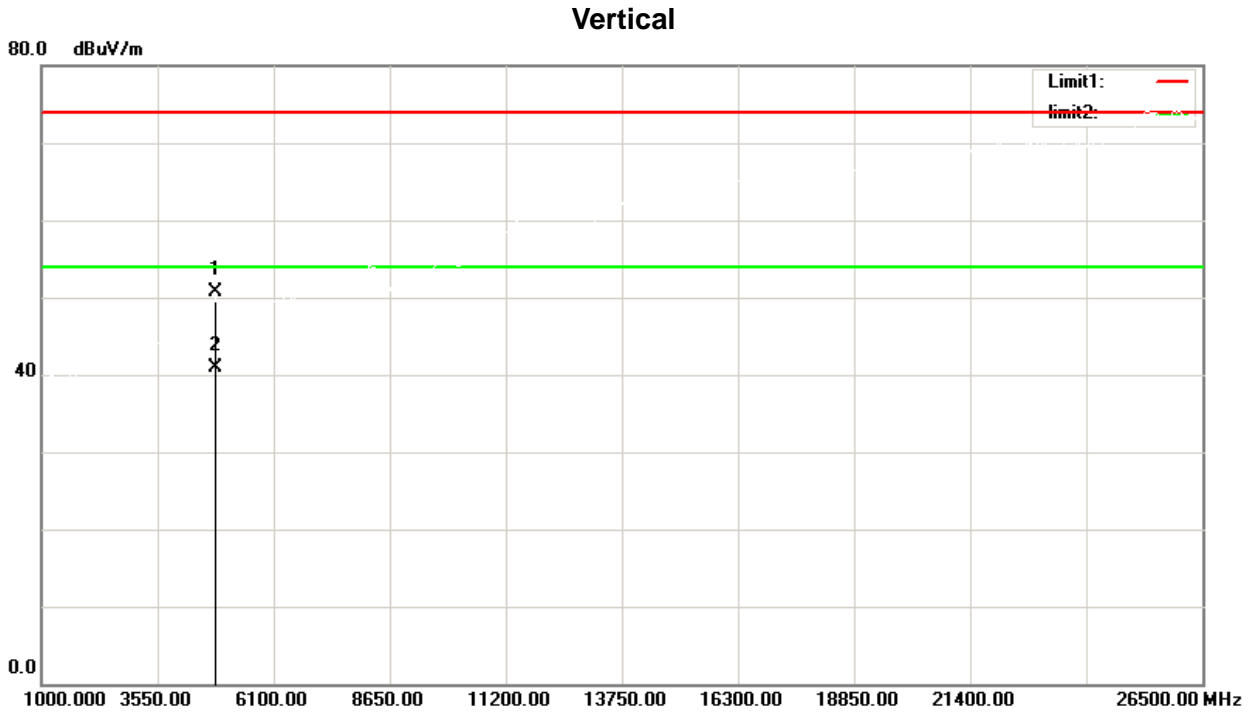

No.	Frequency (MHz)	Reading (dBuV/m)	Correct Factor(dB/m)	Result (dBuV/m)	Limit (dBuV/m)	Margin (dB)	Remark
1	4824.000	53.94	-3.24	50.70	74.00	-23.30	peak
2	4824.000	44.19	-3.24	40.95	54.00	-13.05	AVG

Orthogonal Axis	X
Test Mode:	TX B Mode2412 MHz

Horizontal

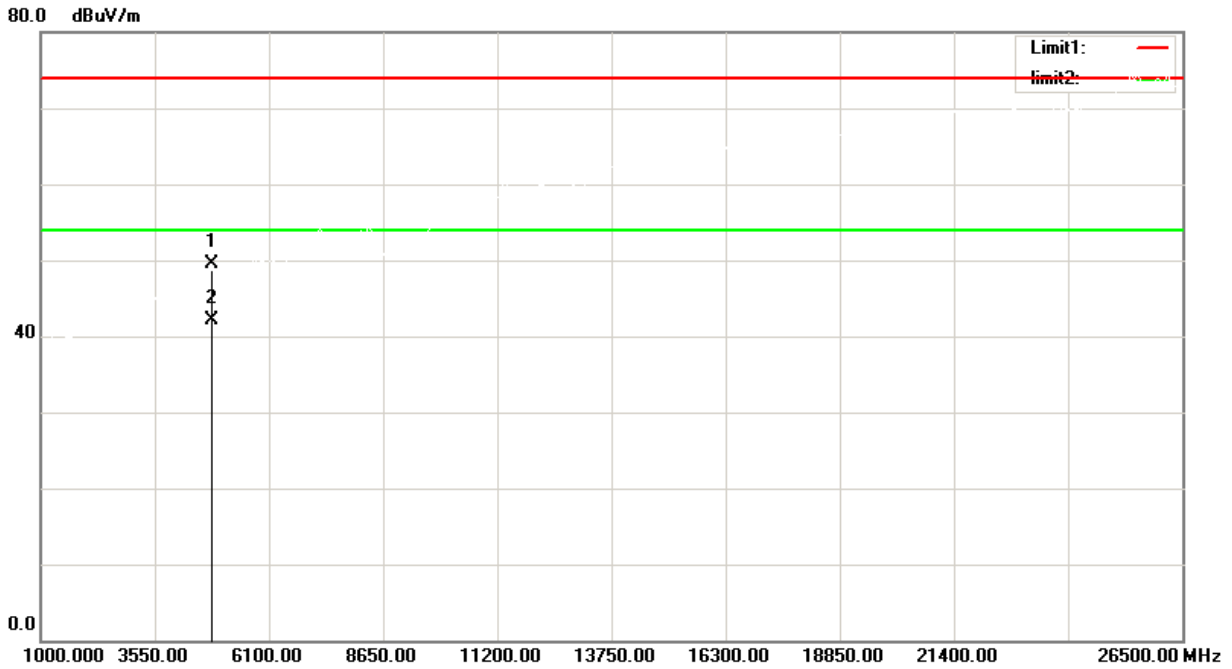

No.	Frequency (MHz)	Reading (dBuV/m)	Correct Factor(dB/m)	Result (dBuV/m)	Limit (dBuV/m)	Margin (dB)	Remark
1	4824.000	52.75	-3.24	49.51	74.00	-24.49	peak
2	4824.000	45.38	-3.24	42.14	54.00	-11.86	AVG

Orthogonal Axis	X
Test Mode:	TX B Mode2437 MHz

Vertical

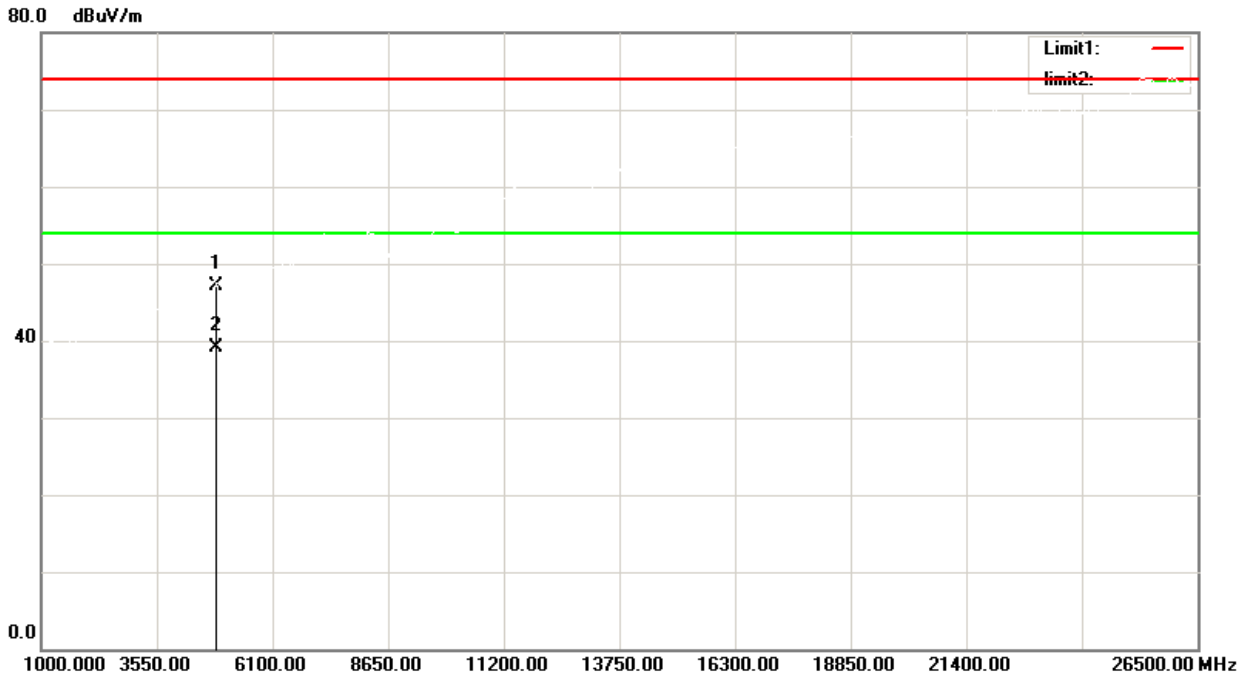

No.	Frequency (MHz)	Reading (dBuV/m)	Correct Factor(dB/m)	Result (dBuV/m)	Limit (dBuV/m)	Margin (dB)	Remark
1	4874.000	50.22	-3.06	47.16	74.00	-26.84	peak
2	4874.000	42.17	-3.06	39.11	54.00	-14.89	AVG

Orthogonal Axis	X
Test Mode:	TX B Mode2437 MHz

Horizontal

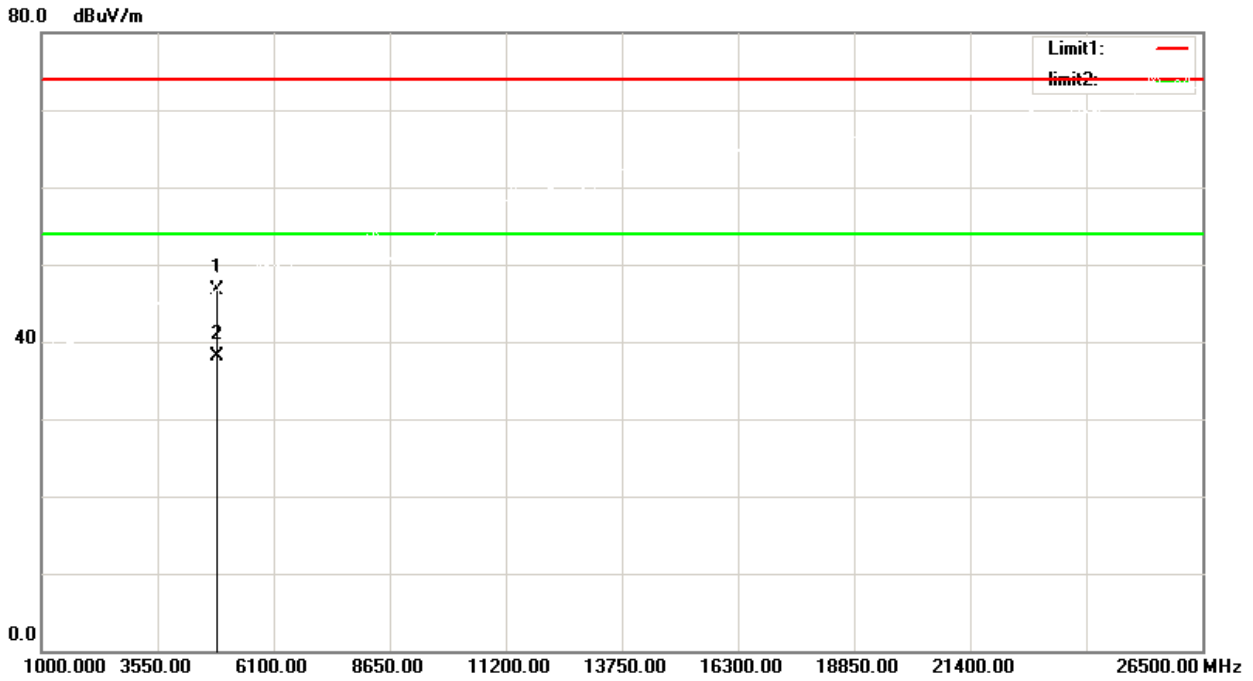

No.	Frequency (MHz)	Reading (dBuV/m)	Correct Factor(dB/m)	Result (dBuV/m)	Limit (dBuV/m)	Margin (dB)	Remark
1	4874.000	49.82	-3.06	46.76	74.00	-27.24	peak
2	4874.000	41.26	-3.06	38.20	54.00	-15.80	AVG

Orthogonal Axis	X
Test Mode:	TX B Mode2462 MHz

Vertical

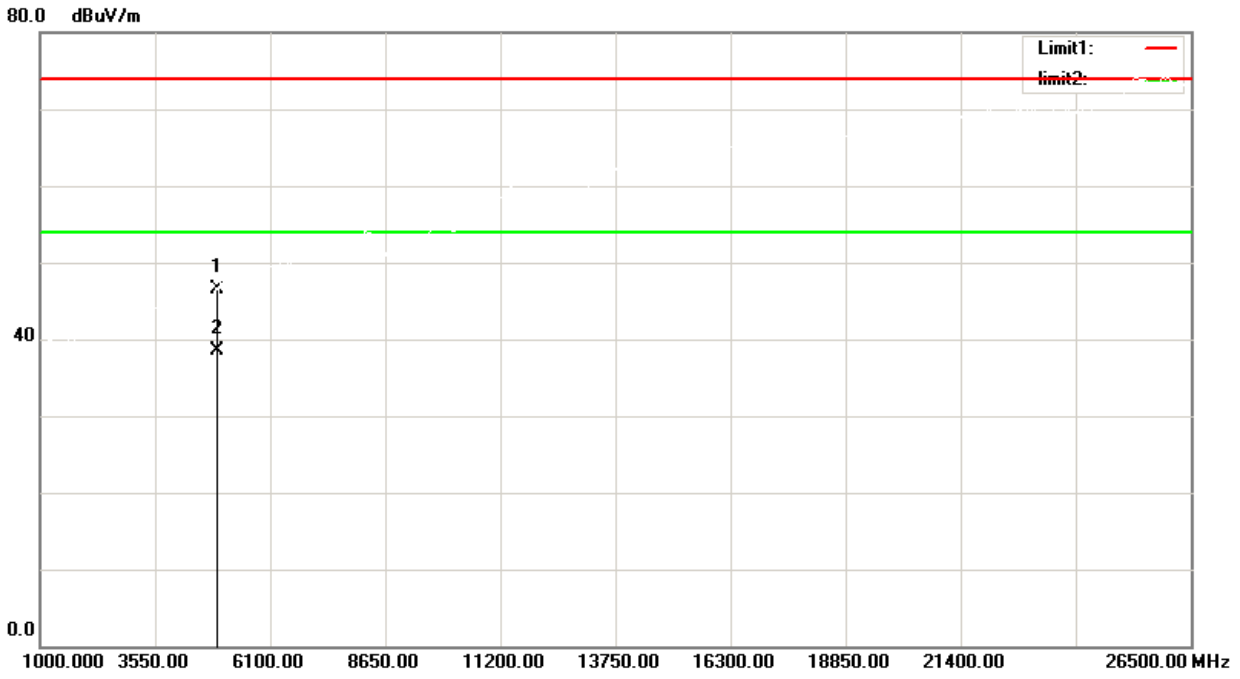

No.	Frequency (MHz)	Reading (dBuV/m)	Correct Factor(dB/m)	Result (dBuV/m)	Limit (dBuV/m)	Margin (dB)	Remark
1	4924.000	49.44	-2.87	46.57	74.00	-27.43	peak
2	4924.000	41.39	-2.87	38.52	54.00	-15.48	AVG

Orthogonal Axis	X
Test Mode:	TX B Mode2462 MHz

Horizontal

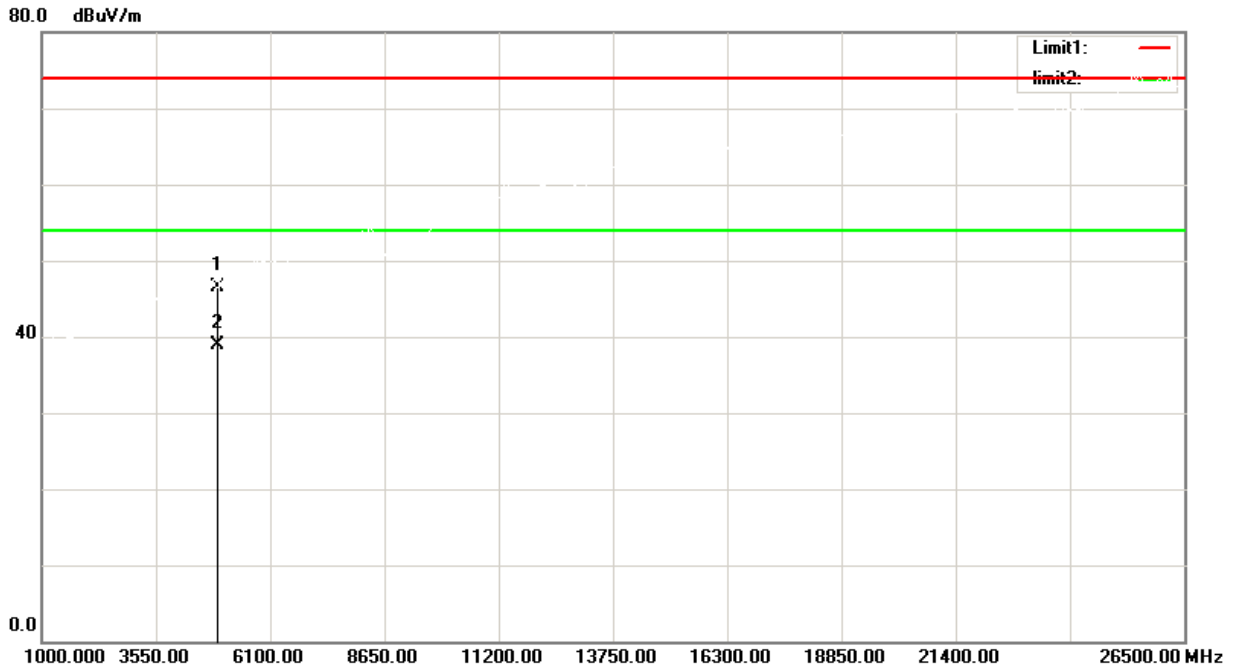

No.	Frequency (MHz)	Reading (dBuV/m)	Correct Factor(dB/m)	Result (dBuV/m)	Limit (dBuV/m)	Margin (dB)	Remark
1	4924.000	49.42	-2.87	46.55	74.00	-27.45	peak
2	4924.000	41.87	-2.87	39.00	54.00	-15.00	AVG

Orthogonal Axis	X
Test Mode:	TX G Mode2412 MHz

Vertical

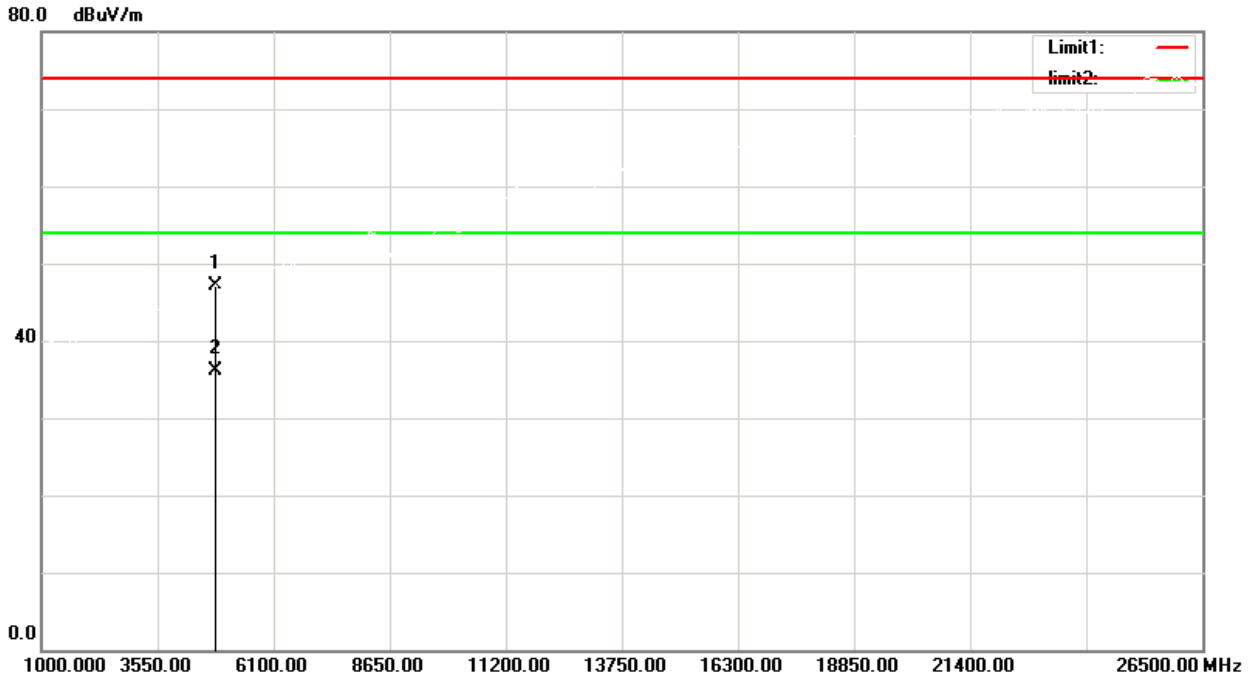

No.	Frequency (MHz)	Reading (dBuV/m)	Correct Factor(dB/m)	Result (dBuV/m)	Limit (dBuV/m)	Margin (dB)	Remark
1	4824.000	50.44	-3.24	47.20	74.00	-26.80	peak
2	4824.000	39.34	-3.24	36.10	54.00	-17.90	AVG

Orthogonal Axis	X
Test Mode:	TX G Mode2412 MHz

Horizontal

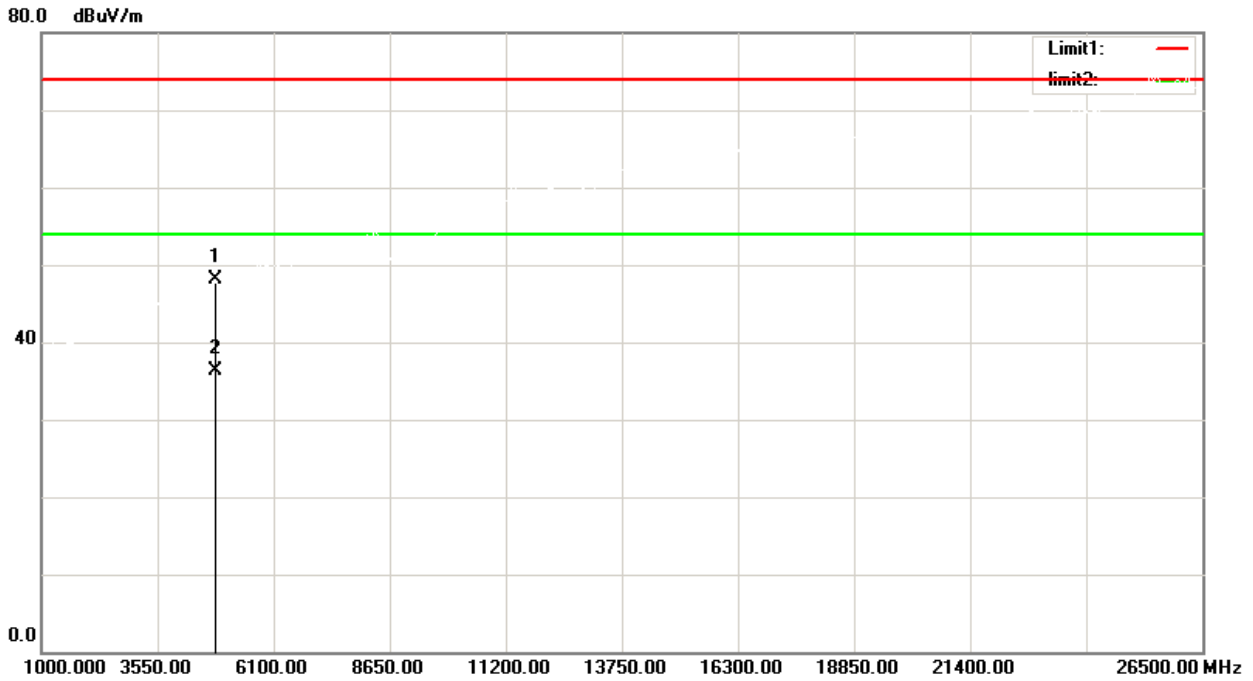

No.	Frequency (MHz)	Reading (dBuV/m)	Correct Factor(dB/m)	Result (dBuV/m)	Limit (dBuV/m)	Margin (dB)	Remark
1	4824.000	51.25	-3.24	48.01	74.00	-25.99	peak
2	4824.000	39.64	-3.24	36.40	54.00	-17.60	AVG

Orthogonal Axis	X
Test Mode:	TX G Mode2437 MHz

Vertical

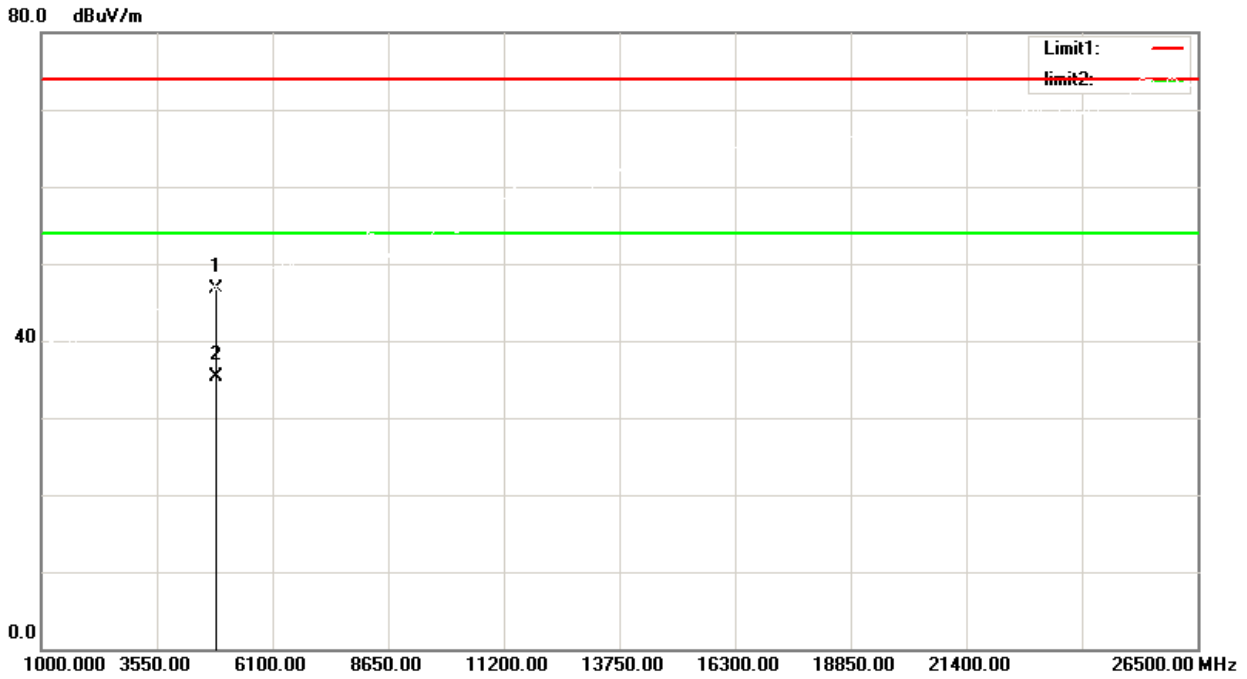

No.	Frequency (MHz)	Reading (dBuV/m)	Correct Factor(dB/m)	Result (dBuV/m)	Limit (dBuV/m)	Margin (dB)	Remark
1	4874.000	49.72	-3.06	46.66	74.00	-27.34	peak
2	4874.000	38.37	-3.06	35.31	54.00	-18.69	AVG

Orthogonal Axis	X
Test Mode:	TX G Mode2437 MHz

Horizontal

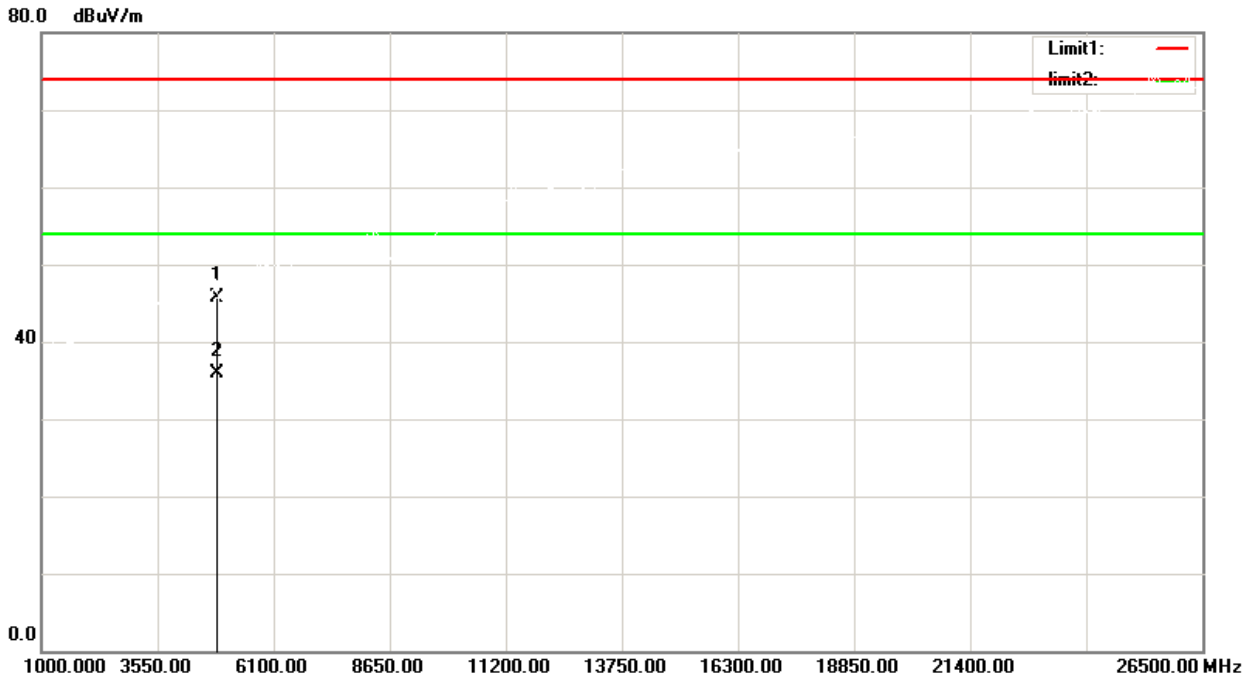

No.	Frequency (MHz)	Reading (dBuV/m)	Correct Factor(dB/m)	Result (dBuV/m)	Limit (dBuV/m)	Margin (dB)	Remark
1	4874.000	48.82	-3.06	45.76	74.00	-28.24	peak
2	4874.000	38.94	-3.06	35.88	54.00	-18.12	AVG

Orthogonal Axis	X
Test Mode:	TX G Mode2462 MHz

Vertical

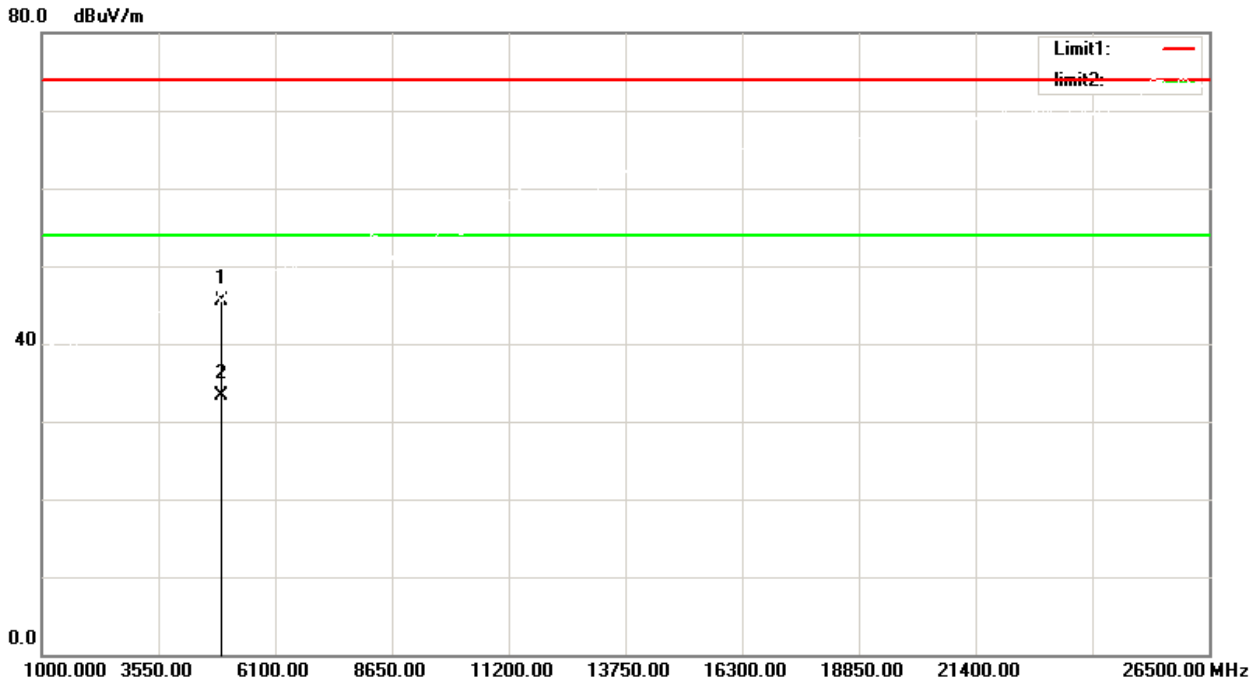

No.	Frequency (MHz)	Reading (dBuV/m)	Correct Factor(dB/m)	Result (dBuV/m)	Limit (dBuV/m)	Margin (dB)	Remark
1	4924.000	48.44	-2.87	45.57	74.00	-28.43	peak
2	4924.000	36.18	-2.87	33.31	54.00	-20.69	AVG

Orthogonal Axis	X
Test Mode:	TX G Mode2462 MHz

Horizontal

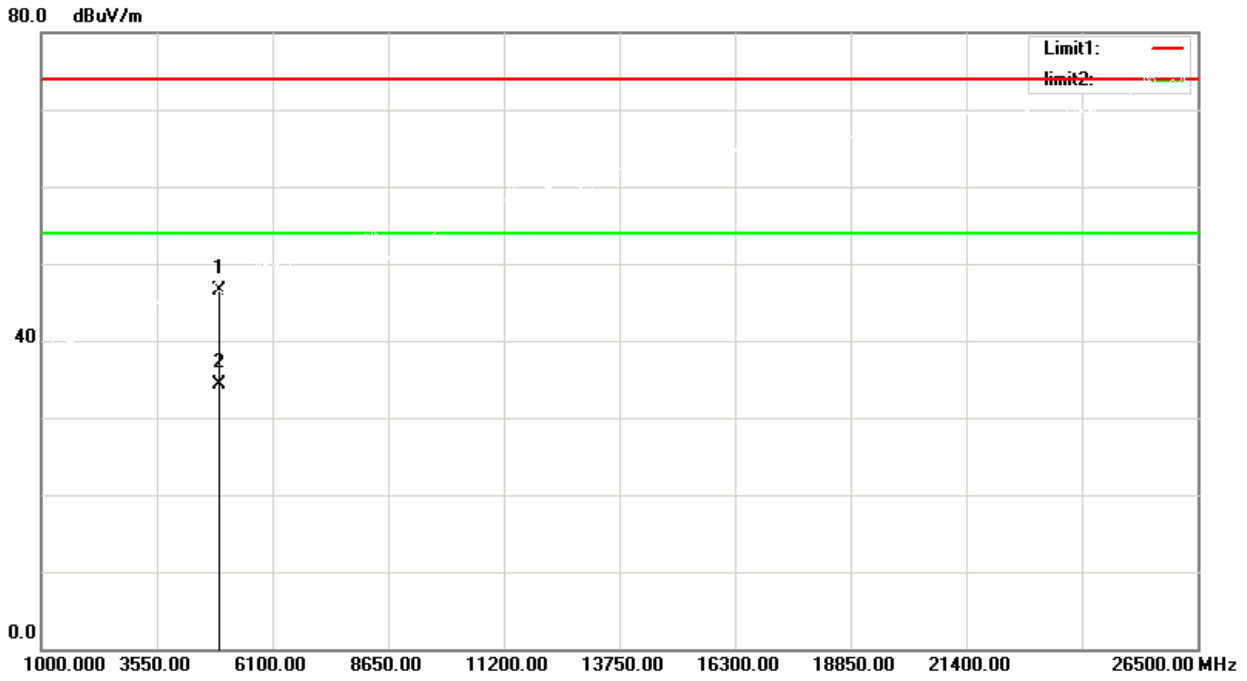

No.	Frequency (MHz)	Reading (dBuV/m)	Correct Factor(dB/m)	Result (dBuV/m)	Limit (dBuV/m)	Margin (dB)	Remark
1	4924.000	49.42	-2.87	46.55	74.00	-27.45	peak
2	4924.000	37.09	-2.87	34.22	54.00	-19.78	AVG

Orthogonal Axis	X
Test Mode:	TX N-20M Mode2412 MHz

Vertical

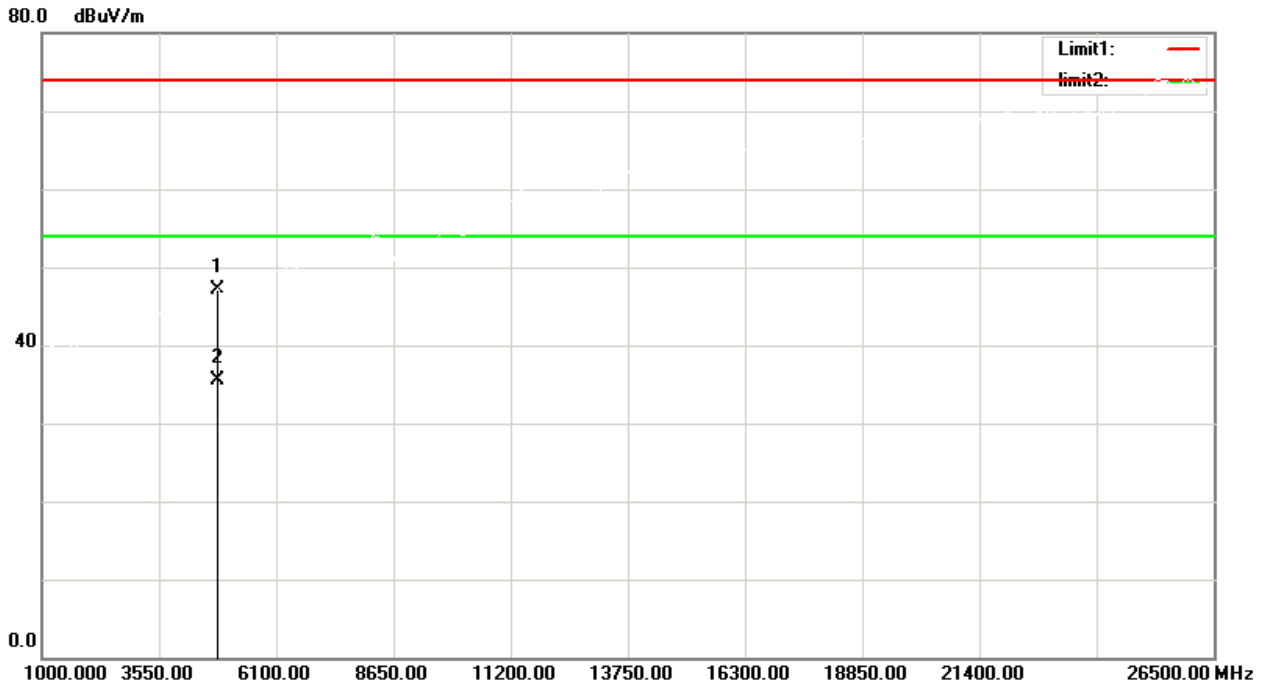

No.	Frequency (MHz)	Reading (dBuV/m)	Correct Factor(dB/m)	Result (dBuV/m)	Limit (dBuV/m)	Margin (dB)	Remark
1	4824.000	50.44	-3.24	47.20	74.00	-26.80	peak
2	4824.000	38.76	-3.24	35.52	54.00	-18.48	AVG

Orthogonal Axis	X
Test Mode:	TX N-20M Mode2412 MHz

Horizontal

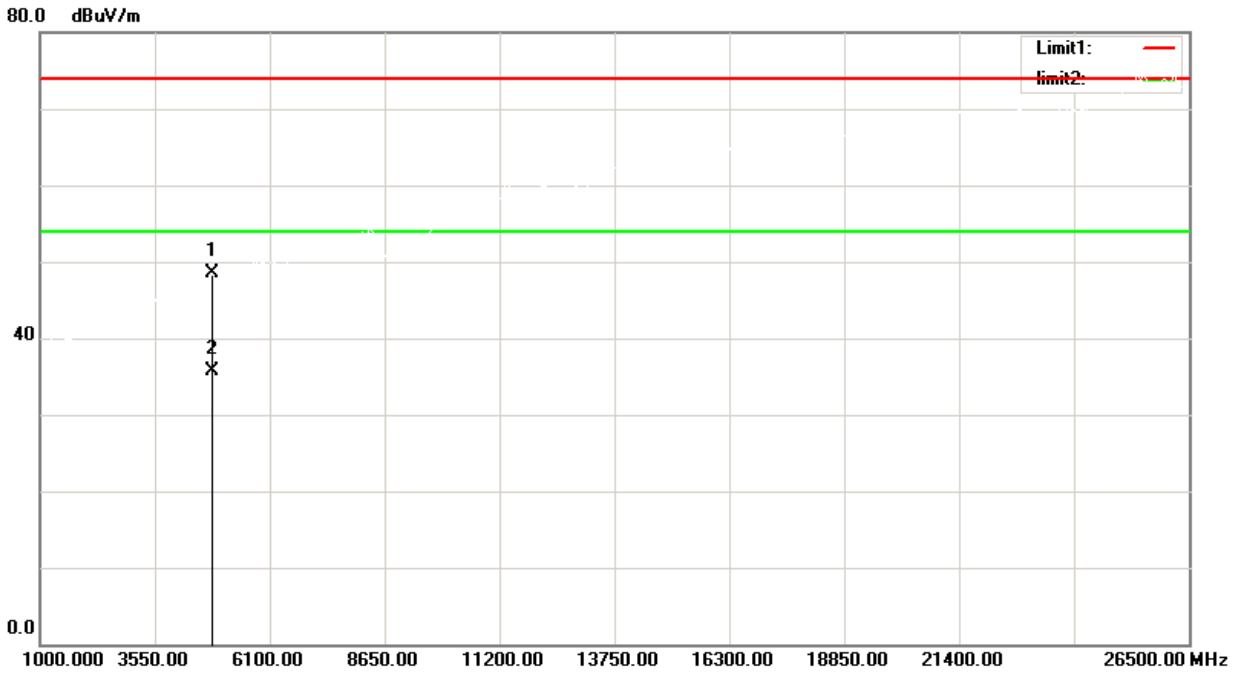

No.	Frequency (MHz)	Reading (dBuV/m)	Correct Factor(dB/m)	Result (dBuV/m)	Limit (dBuV/m)	Margin (dB)	Remark
1	4824.000	51.75	-3.24	48.51	74.00	-25.49	peak
2	4824.000	38.97	-3.24	35.73	54.00	-18.27	AVG

Orthogonal Axis	X
Test Mode:	TX N-20M Mode2437 MHz

Vertical

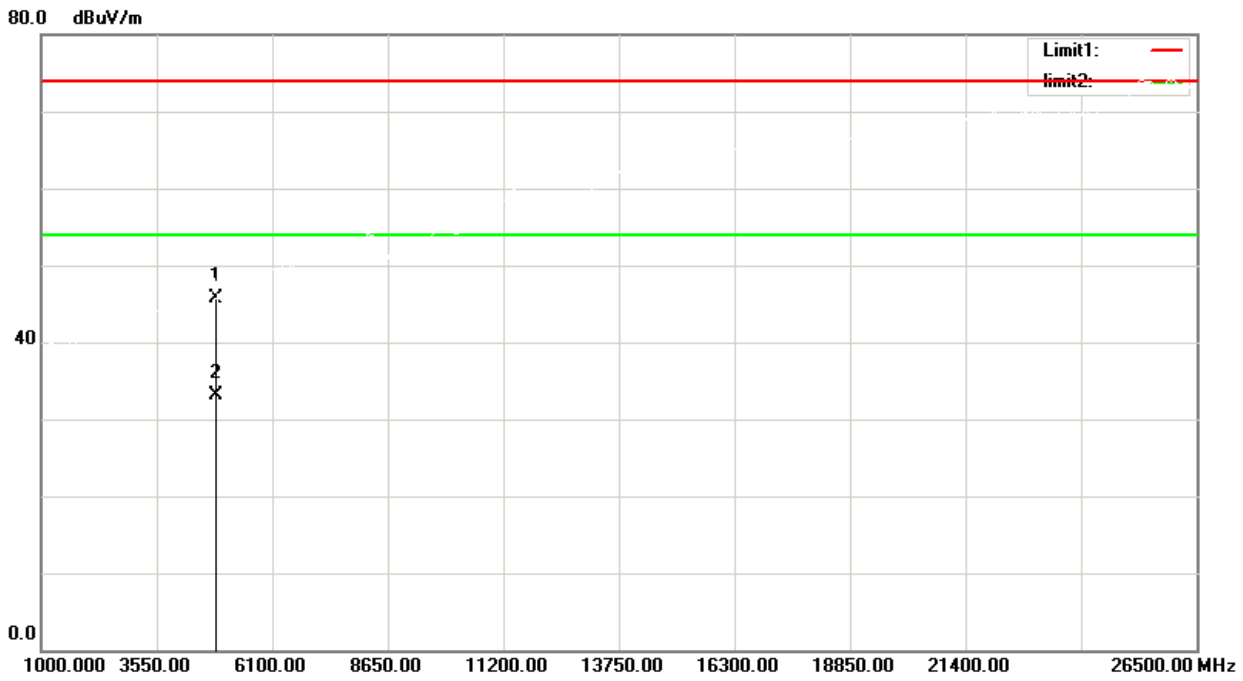

No.	Frequency (MHz)	Reading (dBuV/m)	Correct Factor(dB/m)	Result (dBuV/m)	Limit (dBuV/m)	Margin (dB)	Remark
1	4874.000	48.72	-3.06	45.66	74.00	-28.34	peak
2	4874.000	36.12	-3.06	33.06	54.00	-20.94	AVG

Orthogonal Axis	X
Test Mode:	TX N-20M Mode2437 MHz

Horizontal

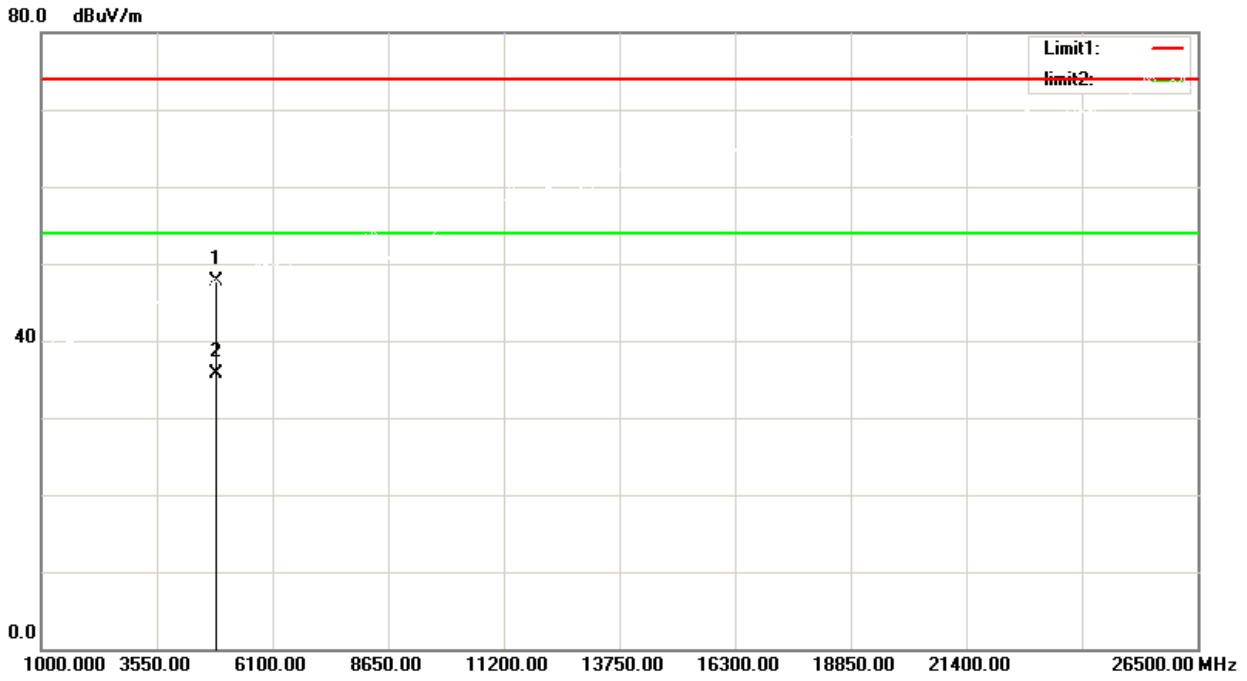

No.	Frequency (MHz)	Reading (dBuV/m)	Correct Factor(dB/m)	Result (dBuV/m)	Limit (dBuV/m)	Margin (dB)	Remark
1	4874.000	50.82	-3.06	47.76	74.00	-26.24	peak
2	4874.000	38.75	-3.06	35.69	54.00	-18.31	AVG

Orthogonal Axis	X
Test Mode:	TX N-20M Mode2462 MHz

Vertical

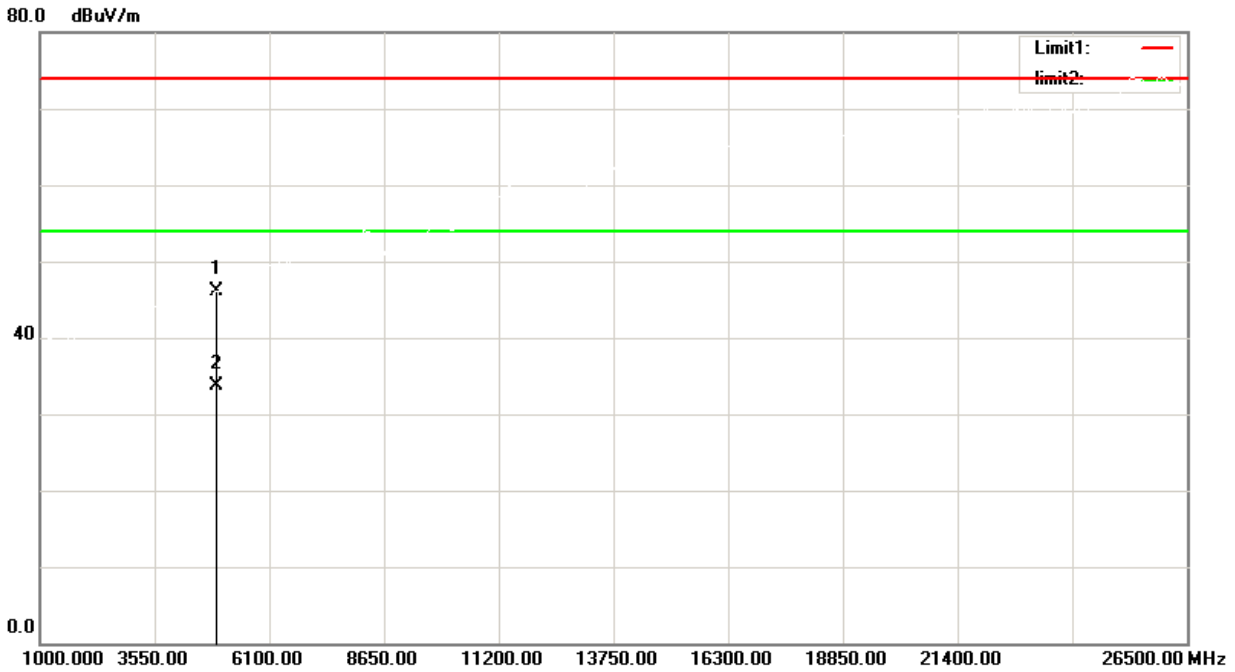

No.	Frequency (MHz)	Reading (dBuV/m)	Correct Factor(dB/m)	Result (dBuV/m)	Limit (dBuV/m)	Margin (dB)	Remark
1	4924.000	48.94	-2.87	46.07	74.00	-27.93	peak
2	4924.000	36.48	-2.87	33.61	54.00	-20.39	AVG

Orthogonal Axis	X
Test Mode:	TX N-20M Mode2462 MHz

Horizontal

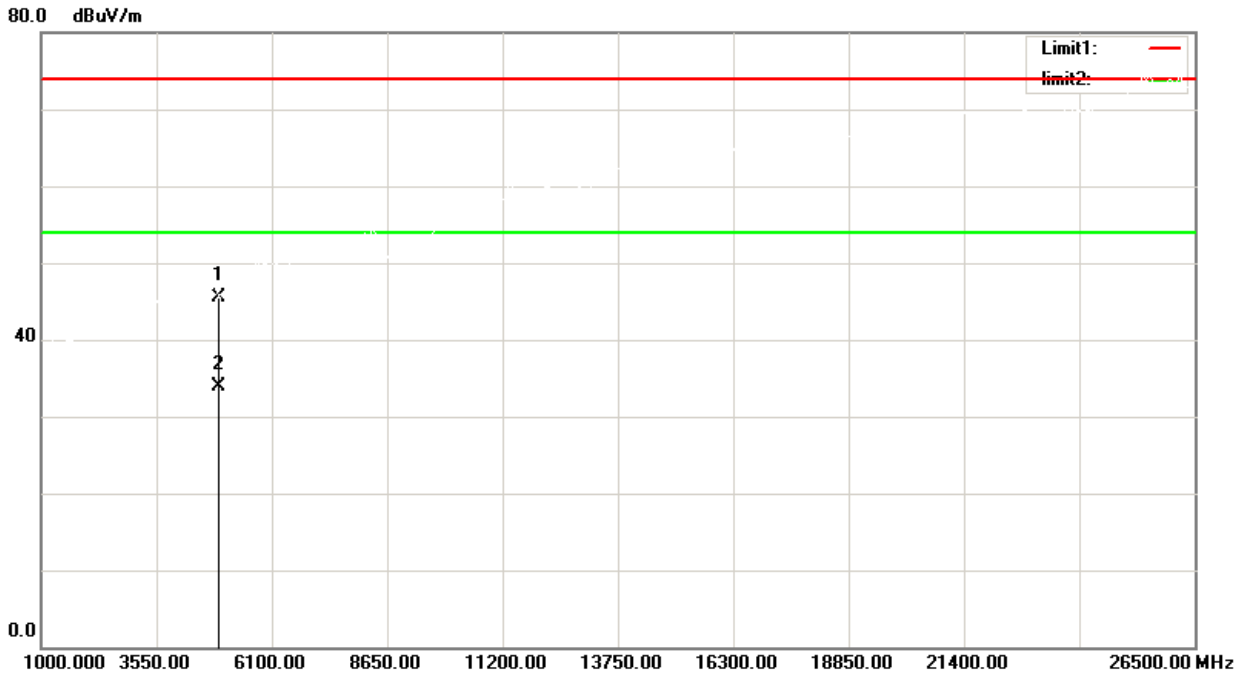

No.	Frequency (MHz)	Reading (dBuV/m)	Correct Factor(dB/m)	Result (dBuV/m)	Limit (dBuV/m)	Margin (dB)	Remark
1	4924.000	48.42	-2.87	45.55	74.00	-28.45	peak
2	4924.000	36.82	-2.87	33.95	54.00	-20.05	AVG

Orthogonal Axis	X
Test Mode:	TX N-40M Mode 2422MHz

Vertical

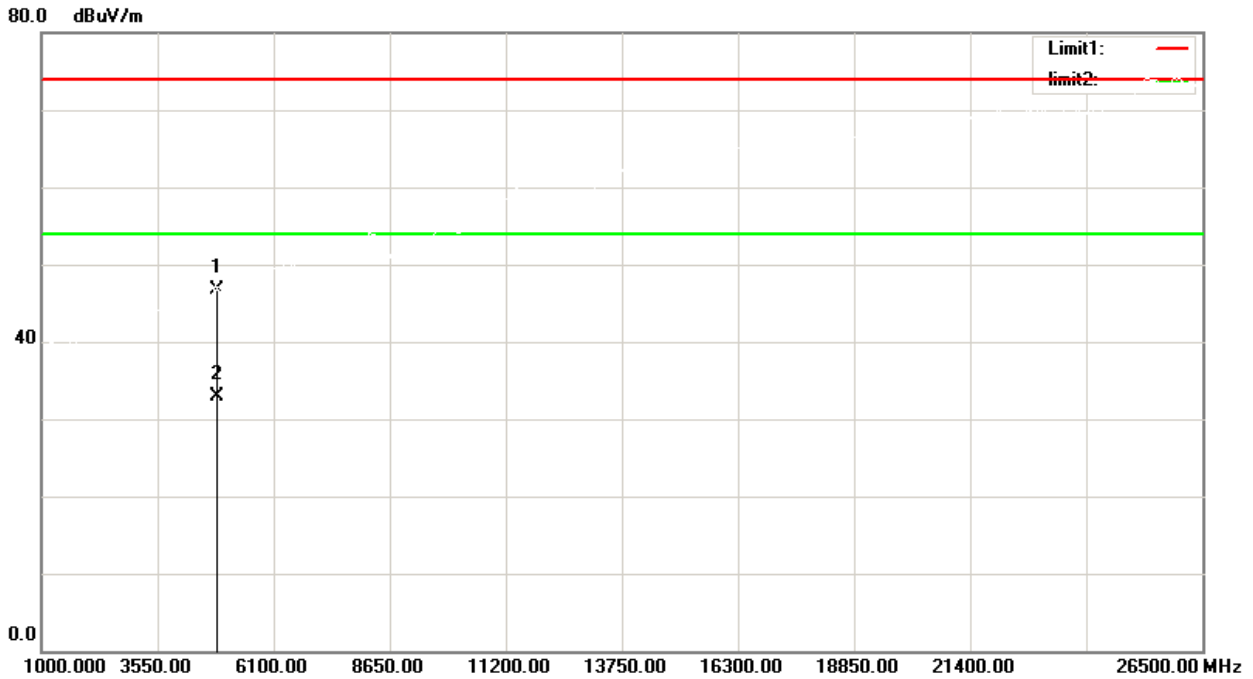

No.	Frequency (MHz)	Reading (dBuV/m)	Correct Factor(dB/m)	Result (dBuV/m)	Limit (dBuV/m)	Margin (dB)	Remark
1	4844.000	49.84	-3.18	46.66	74.00	-27.34	peak
2	4844.000	36.08	-3.18	32.90	54.00	-21.10	AVG

Orthogonal Axis	X
Test Mode:	TX N-40M Mode 2422MHz

Horizontal

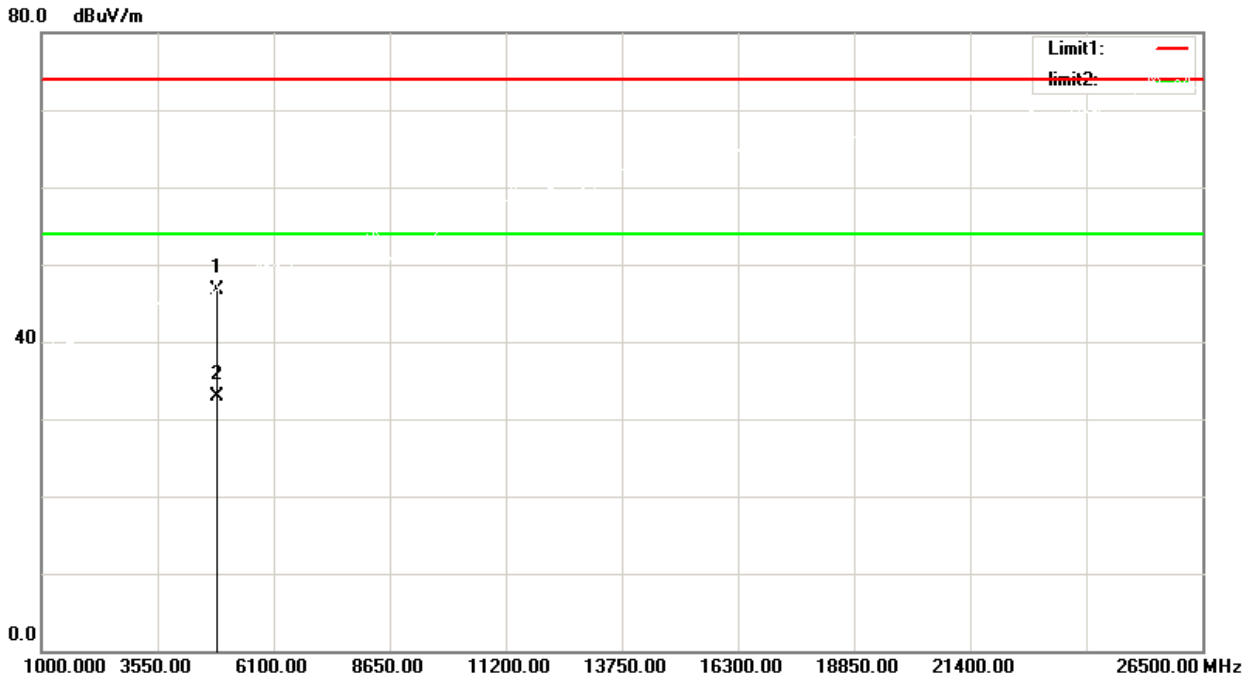

No.	Frequency (MHz)	Reading (dBuV/m)	Correct Factor(dB/m)	Result (dBuV/m)	Limit (dBuV/m)	Margin (dB)	Remark
1	4844.000	49.94	-3.18	46.76	74.00	-27.24	peak
2	4844.000	36.09	-3.18	32.91	54.00	-21.09	AVG

Orthogonal Axis	X
Test Mode:	TX N-40M Mode2437 MHz

Vertical

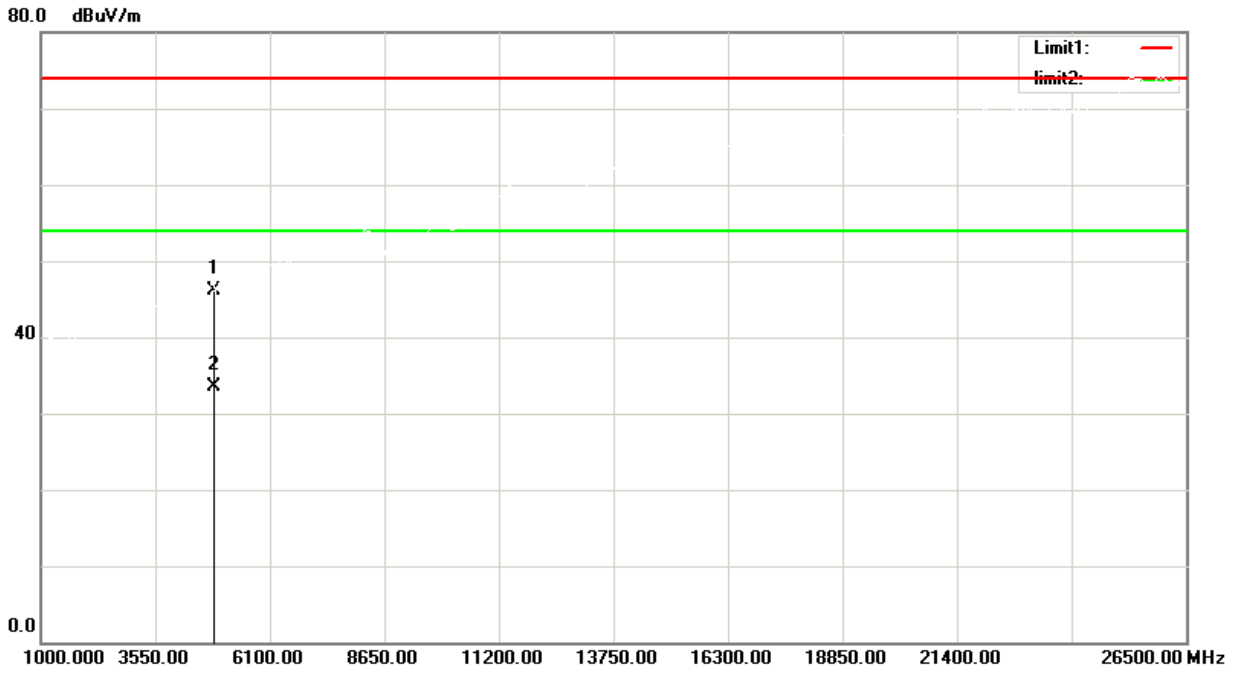

No.	Frequency (MHz)	Reading (dBuV/m)	Correct Factor(dB/m)	Result (dBuV/m)	Limit (dBuV/m)	Margin (dB)	Remark
1	4874.000	49.22	-3.06	46.16	74.00	-27.84	peak
2	4874.000	36.54	-3.06	33.48	54.00	-20.52	AVG

Orthogonal Axis	X
Test Mode:	TX N-40M Mode2437 MHz

Horizontal

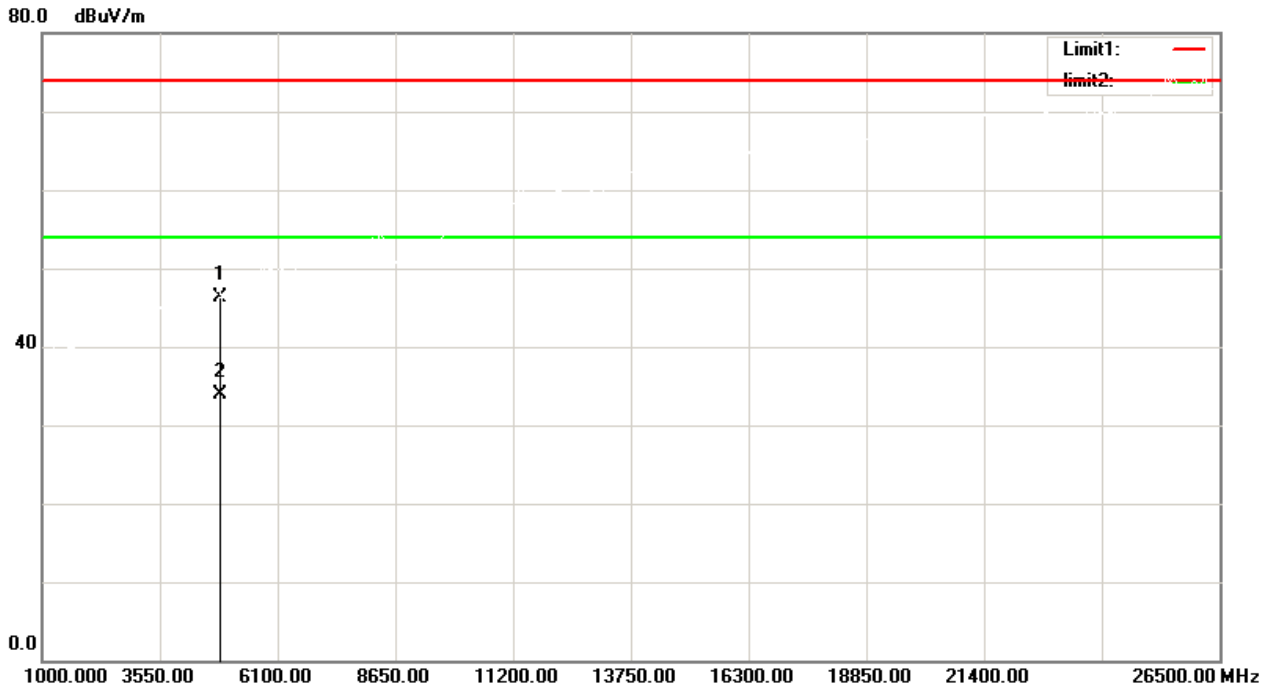

No.	Frequency (MHz)	Reading (dBuV/m)	Correct Factor(dB/m)	Result (dBuV/m)	Limit (dBuV/m)	Margin (dB)	Remark
1	4874.000	49.32	-3.06	46.26	74.00	-27.74	peak
2	4874.000	36.95	-3.06	33.89	54.00	-20.11	AVG

Orthogonal Axis	X
Test Mode:	TX N-40M Mode2452 MHz

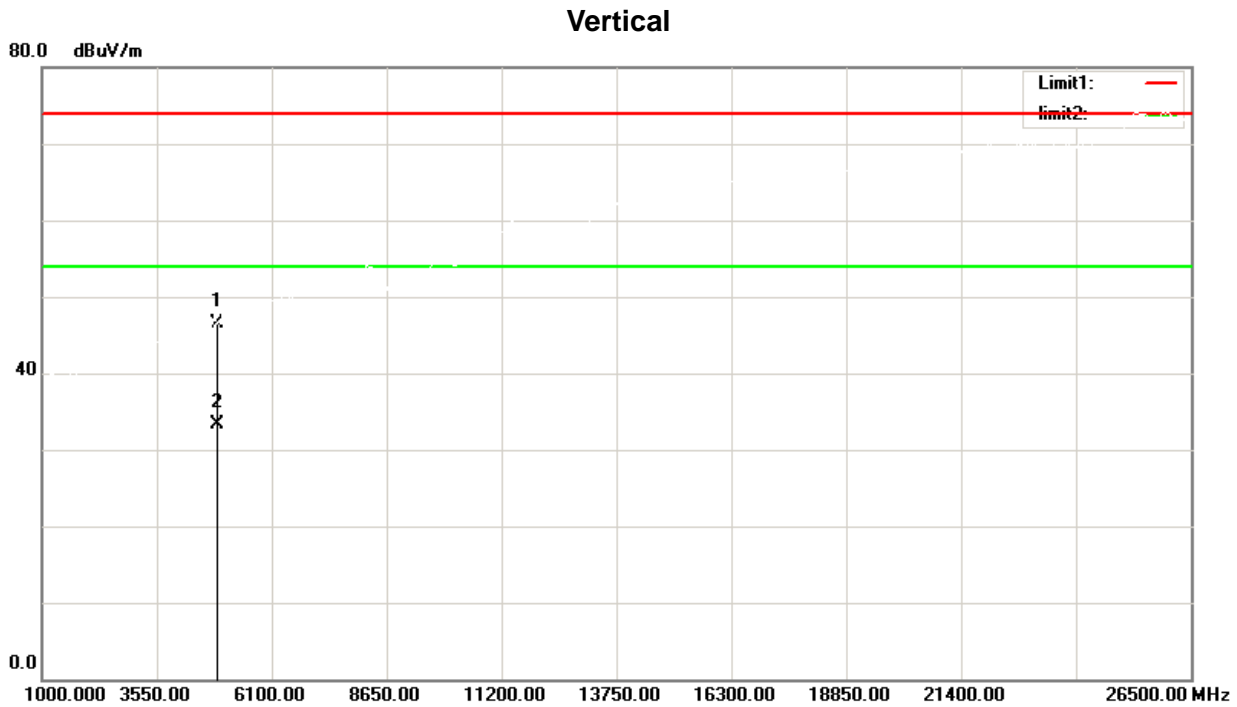

No.	Frequency (MHz)	Reading (dBuV/m)	Correct Factor(dB/m)	Result (dBuV/m)	Limit (dBuV/m)	Margin (dB)	Remark
1	4904.000	49.52	-2.95	46.57	74.00	-27.43	peak
2	4904.000	36.23	-2.95	33.28	54.00	-20.72	AVG

Orthogonal Axis	X
Test Mode:	TX N-40M Mode2452 MHz

Horizontal

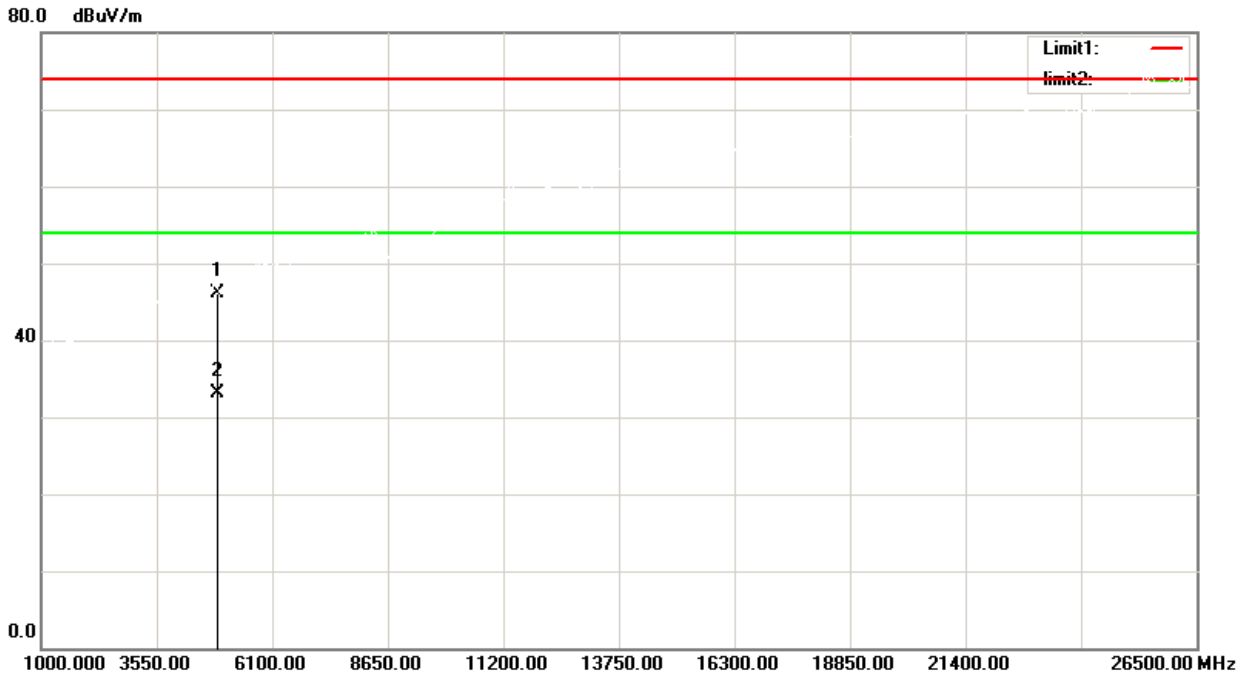

No.	Frequency (MHz)	Reading (dBuV/m)	Correct Factor(dB/m)	Result (dBuV/m)	Limit (dBuV/m)	Margin (dB)	Remark
1	4904.000	49.00	-2.95	46.05	74.00	-27.95	peak
2	4904.000	36.04	-2.95	33.09	54.00	-20.91	AVG

6. BANDWIDTH TEST

6.1 LIMIT

FCC Part15, Subpart C (15.247)&RSS-Gen and RSS-247		
Section	Test Item	Limit
15.247(a)(2) RSS-247 5.2 (a)	6dB Bandwidth	Minimum 500 kHz
	99% Emission Bandwidth	-

6.2 TEST PROCEDURE AND SETTING

- a. The EUT was directly connected to the spectrum analyzer and antenna output port as show in the block diagram below.
- b. For 6dB Bandwidth Spectrum setting:RBW= 100KHz, VBW=300KHz, Sweep time = 2.5ms.
For 99% OBW Spectrum Setting: RBW= 300KHz, VBW=1MHz,Sweep time = 2.5ms.
- c. The bandwidth was performed in accordance with method 11.8.1 of ANSI C63.10-2013.

6.3 MEASUREMENT INSTRUMENTS LIST

Item	Kind of Equipment	Manufacturer	Type No.	Serial No.	Calibrated until
1	Spectrum analyzer	KEYSIGHT	N9010A	MY55150427	2020/05/27
2	Attenuator	Mini-Circuits	BW-S10W2	101109	N/A
3	RF Cable	Mi-cable	C10-01-01-1	100309	N/A

6.4 TEST SETUP

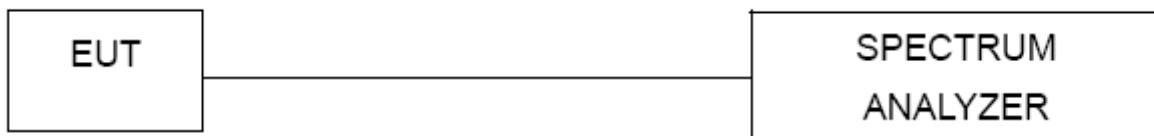

6.5 EUT OPERATION CONDITIONS

The EUT tested system was configured as the statements of 4.5 unless otherwise a special operating condition is specified in the follows during the testing.

6.6 TESTRESULTS

TX B Mode					
Channel	Frequency (MHz)	6dB Bandwidth (MHz)	99% Emission Bandwidth(MHz)	6dB Bandwidth Min. Limit(kHz)	Result
01	2412	9.074	13.454	500	PASS
06	2437	9.074	13.382	500	PASS
11	2462	9.069	13.462	500	PASS

6dB

CH01

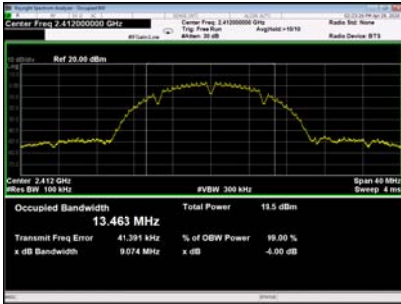

CH06

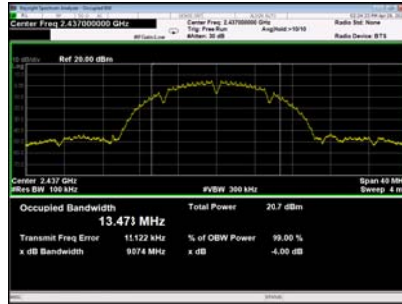

CH11



99%

CH01

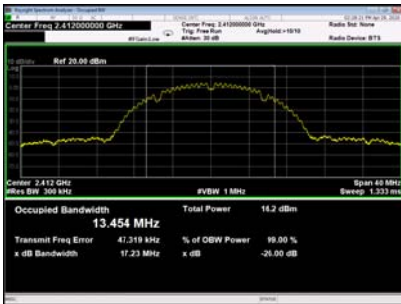

CH06

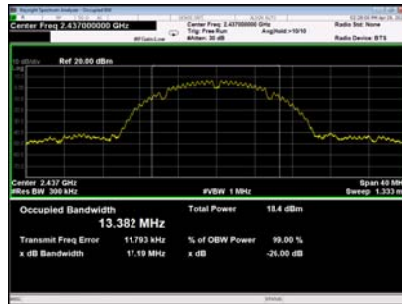

CH11

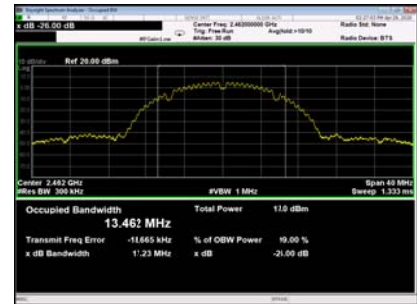

TX G Mode					
Channel	Frequency (MHz)	6dB Bandwidth (MHz)	99% Emission Bandwidth(MHz)	6dB Bandwidth Min. Limit(kHz)	Result
01	2412	16.58	16.862	500	PASS
06	2437	16.57	16.878	500	PASS
11	2462	16.58	16.851	500	PASS

6dB

CH01

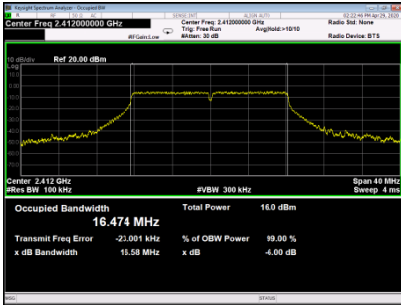

CH06

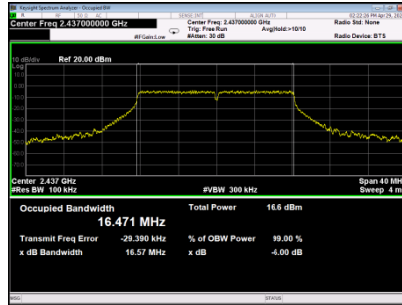

CH11

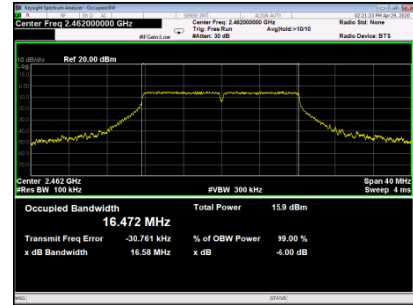

99%

CH01

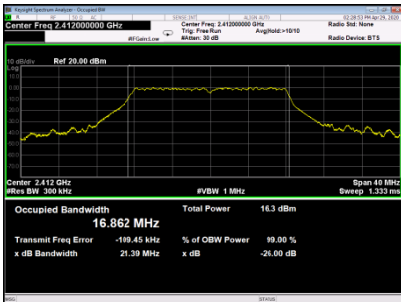

CH06

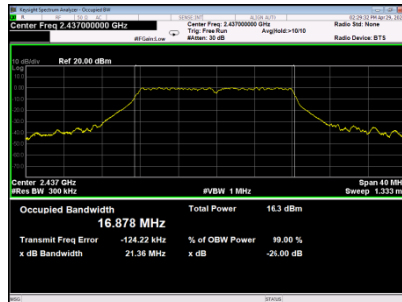

CH11

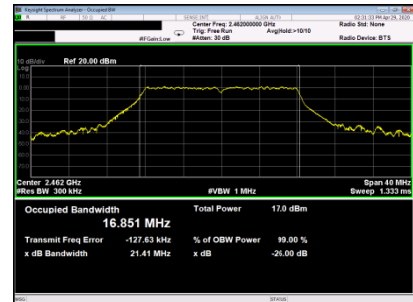

TX N (HT20) Mode					
Channel	Frequency (MHz)	6dB Bandwidth (MHz)	99% Emission Bandwidth(MHz)	6dB Bandwidth Min. Limit(kHz)	Result
01	2412	17.77	17.882	500	PASS
06	2437	17.76	17.896	500	PASS
11	2462	17.79	17.863	500	PASS

6dB

CH01

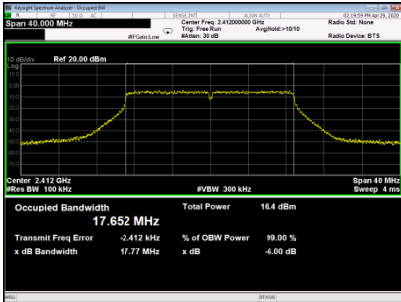

CH06

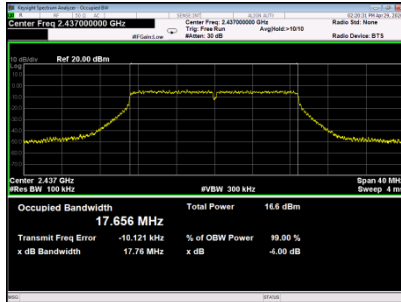

CH11

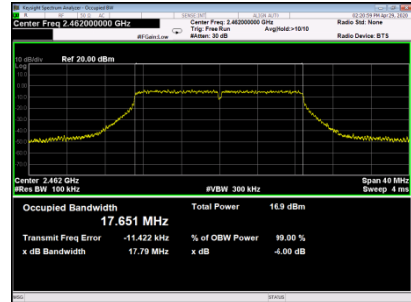

99%

CH01

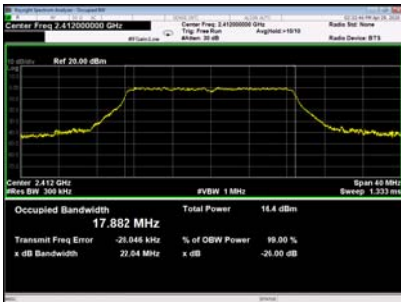

CH06

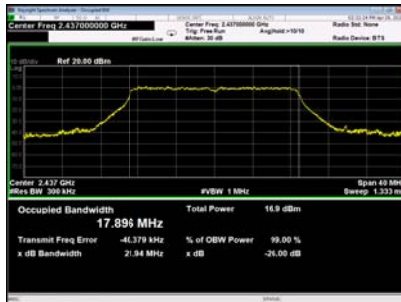

CH11

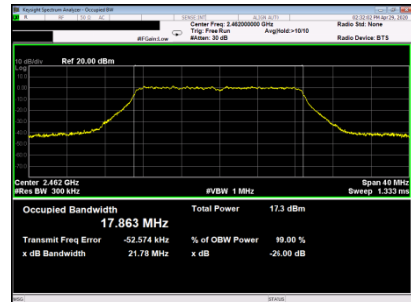

TX N (HT40) Mode					
Channel	Frequency (MHz)	6dB Bandwidth (MHz)	99% Emission Bandwidth(MHz)	6dB Bandwidth Min. Limit(kHz)	Result
03	2422	36.50	36.152	500	PASS
06	2437	36.52	36.154	500	PASS
09	2452	36.53	36.153	500	PASS

6dB

CH03

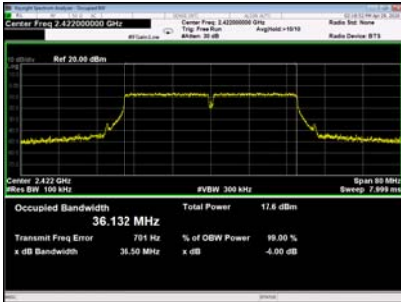

CH06

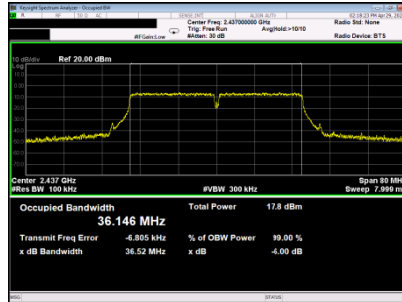

CH09

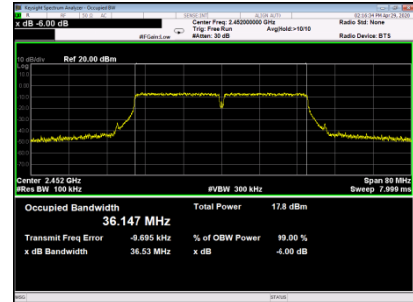

99%

CH03

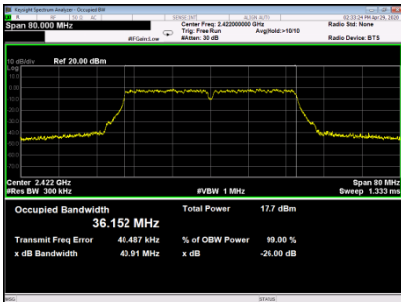

CH06

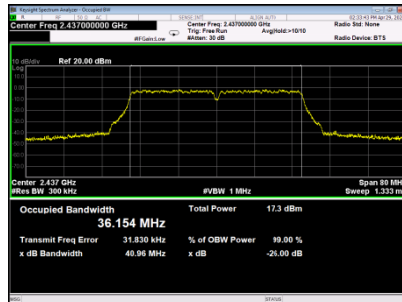

CH9

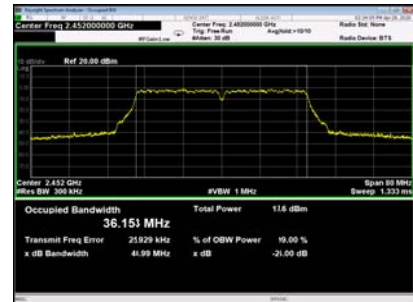

7. MAXIMUM OUTPUT POWER TEST

7.1 LIMIT

FCC Part15, Subpart C (15.247)&RSS-247		
Section	Test Item	Limit
15.247(b)(3) RSS-2475.4 (d)	Maximum Output Power	1 Watt or 30dBm

7.2 TEST PROCEDURE AND SETTING

- The EUT was directly connected to the power meter and antenna output port as show in the block diagram below.
- The maximum conducted output power was performed in accordance with method 11.9.1.3 of ANSI C63.10-2013.and FCC KDB 662911 D01 v02r01 Multiple Transmitter Output.

7.3 MEASUREMENT INSTRUMENTS LIST

Item	Equipment	Manufacturer	Model No.	Serial No.	Calibrated until
1	Power Sensor	KEYSIGHT	U2021XA	MY55240009	05/27/2020
2	Attenuator	Mini-Circuits	BW-S10W2	101109	N/A
3	RF Cable	Micable	C10-01-01-1	100309	N/A
4	Test Software	KEYSIGHT	Power Panel	V3.11	N/A

7.4 TEST SETUP

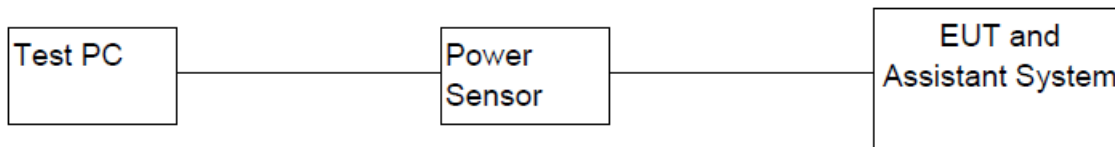

7.5 EUT OPERATION CONDITIONS

The EUT tested system was configured as the statements of 4.5 unless otherwise a special operating condition is specified in the follows during the testing.

7.6 TESTRESULTS

TX B Mode				
Channel	Frequency (MHz)	Output Power (dBm)	Output Power (W)	Result
01	2412	17.83	0.0607	PASS
06	2437	17.68	0.0586	PASS
11	2462	17.47	0.0559	PASS
Limit	30dBm / 1W			

TX G Mode				
Channel	Frequency (MHz)	Output Power (dBm)	Output Power (W)	Result
01	2412	18.81	0.0760	PASS
06	2437	18.95	0.0785	PASS
11	2462	19.03	0.0800	PASS
Limit	30dBm / 1W			

TX N (HT20)				
Channel	Frequency (MHz)	Output Power (dBm)	Output Power (W)	Result
01	2412	18.78	0.0755	PASS
06	2437	18.98	0.0791	PASS
11	2462	18.89	0.0775	PASS
Limit	30dBm / 1W			

TX N (HT40)				
Channel	Frequency (MHz)	Output Power (dBm)	Output Power (W)	Result
03	2422	18.57	0.0719	PASS
06	2437	18.31	0.0678	PASS
09	2452	18.30	0.0676	PASS
Limit	30dBm / 1W			

8. CONDUCTED SPURIOUS EMISSIONS

8.1 LIMIT

For FCC

In any 100 kHz bandwidth outside the frequency band in which the spread spectrum or digitally modulated intentional radiator is operating, the radio frequency power that is produced by the intentional radiator shall be at least 20 dB below that in the 100 kHz bandwidth within the band that contains the highest level of the desired power, based on either an RF conducted or a radiated measurement, provided the transmitter demonstrates compliance with the peak Output Power limits. If the transmitter complies with the Output Power limits based on the use of RMS averaging over a time interval, as permitted under paragraph (b)(3) of this section, the attenuation required under this paragraph shall be 30 dB instead of 20 dB. Attenuation below the general limits specified in Section 15.209(a) is not required.

For ISSED

In any 100 kHz bandwidth outside the frequency band in which the spread spectrum or digitally modulated device is operating, the RF power that is produced shall be at least 20 dB below that in the 100 kHz bandwidth within the band that contains the highest level of the desired power, based on either an RF conducted or a radiated measurement, provided that the transmitter demonstrates compliance with the peak Output Power limits. If the transmitter complies with the Output Power limits based on the use of root-mean-square averaging over a time interval, as permitted under section 5.4(d), the attenuation required shall be 30 dB instead of 20 dB. Attenuation below the general field strength limits specified in RSS-Gen is not required.

8.2 TEST PROCEDURE AND SETTING

- a. The EUT was directly connected to the spectrum analyzer and antenna output port as show in the block diagram below.
- b. Spectrum Setting: RBW= 100 kHz, VBW=300 kHz, Sweep time = Auto.

8.3 MEASUREMENT INSTRUMENTS LIST

Item	Kind of Equipment	Manufacturer	Type No.	Serial No.	Calibrated until
1	Spectrum analyzer	KEYSIGHT	N9010A	MY55150427	2020/05/27
2	Attenuator	Mini-Circuits	BW-S10W2	101109	N/A
3	RF Cable	Mi-cable	C10-01-01-1	100309	N/A

8.4 TEST SETUP



8.5 EUT OPERATION CONDITIONS

The EUT tested system was configured as the statements of 4.5 unless otherwise a special operating condition is specified in the follows during the testing.

8.6 TESTRESULTS

TX B Mode

Bandedge-CH01

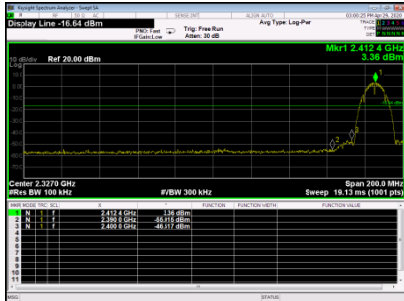

Bandedge-CH11

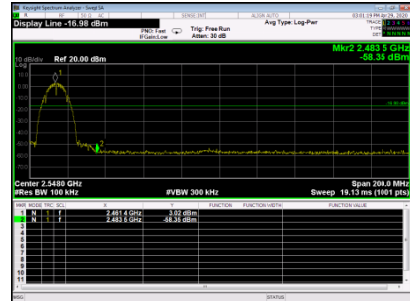

10th Harmonic of the fundamental frequency

CH01

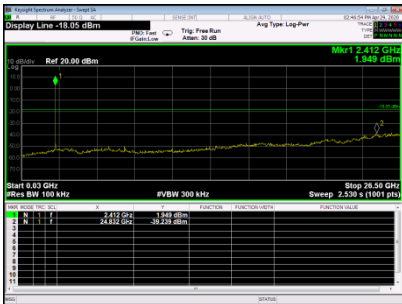

CH06

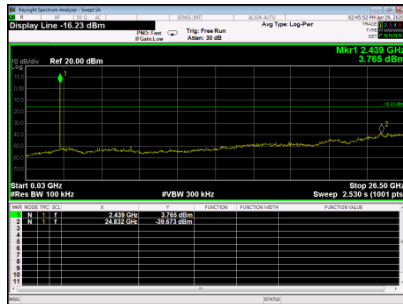

CH11

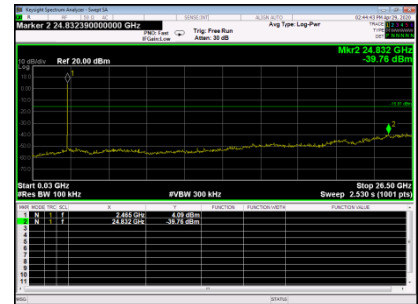

TX G Mode

Bandedge-CH01

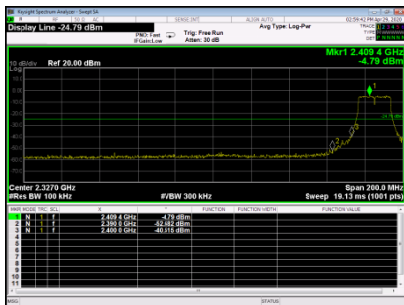

Bandedge-CH11

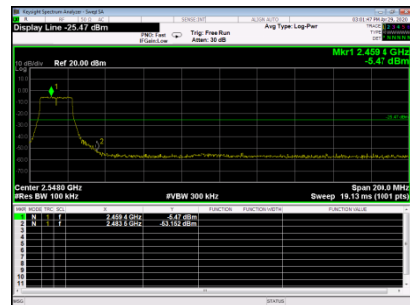

10th Harmonic of the fundamental frequency

CH01

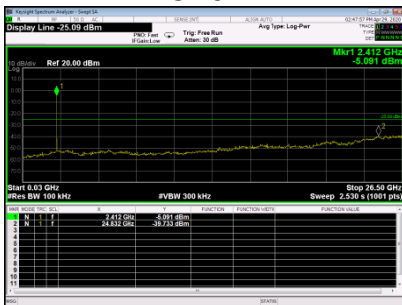

CH06



CH11

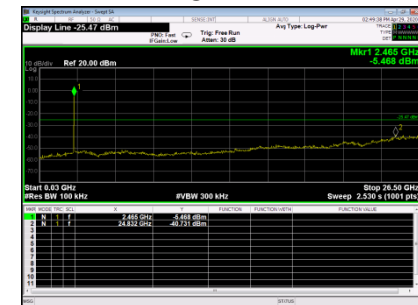

TX N (HT20) Mode

Bandedge-CH01

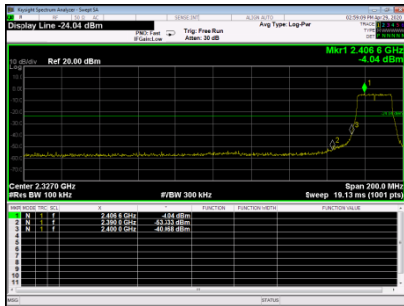

Bandedge-CH11

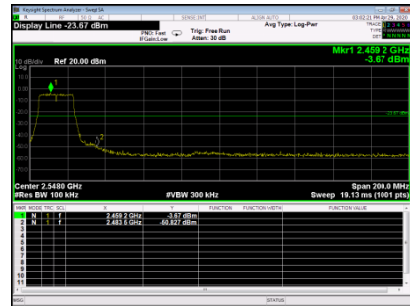

10th Harmonic of the fundamental frequency

CH01



CH06

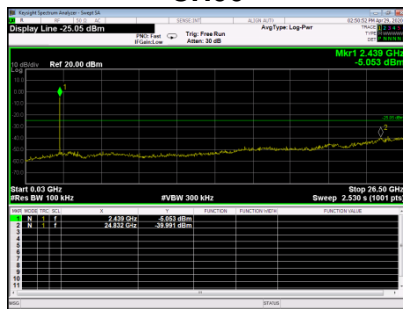

CH11

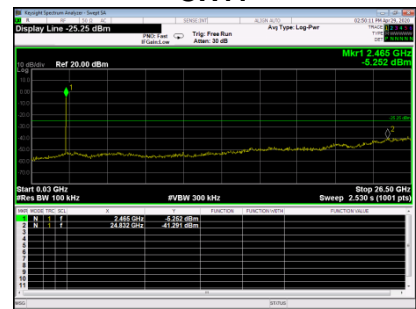

TX N (HT40) Mode

Bandedge-CH03



Bandedge-CH09



10th Harmonic of the fundamental frequency

CH03

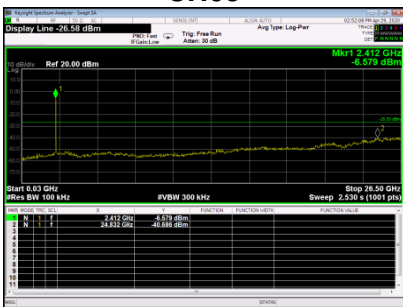

CH06

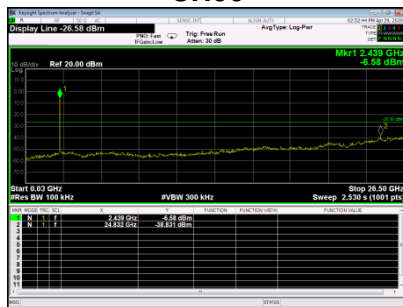

CH09

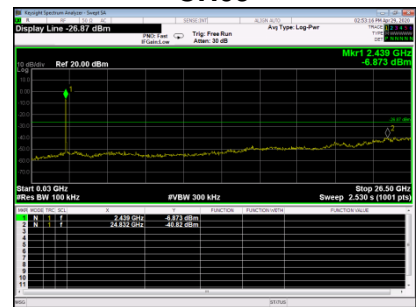

9. POWER SPECTRAL DENSITY TEST

9.1 LIMIT

FCC Part15, Subpart C (15.247)&RSS-247		
Section	Test Item	Limit
15.247(e)	Power Spectral Density	8 dBm (in any 3 kHz)

9.2 TEST PROCEDURE AND SETTING

- The EUT was directly connected to the spectrum analyzer and antenna output port as show in the block diagram below.
- Spectrum Setting: RBW=3 kHz, VBW=10 kHz, Sweep time = Auto.
- The Power Spectral Density was performed in accordance with method11.10.2 of ANSI C63.10-2013.

9.3 MEASUREMENT INSTRUMENTS LIST

Item	Kind of Equipment	Manufacturer	Type No.	Serial No.	Calibrated until
1	Spectrum analyzer	KEYSIGHT	N9010A	MY55150427	2020/05/27
2	Attenuator	Mini-Circuits	BW-S10W2	101109	N/A
3	RF Cable	Mi-cable	C10-01-01-1	100309	N/A

9.4 TEST SETUP



9.5 EUT OPERATION CONDITIONS

The EUT tested system was configured as the statements of 4.5 unless otherwise a special operating condition is specified in the follows during the testing.

9.6 TESTRESULTS

TX B Mode				
Channel	Frequency (MHz)	Power Spectral Density (dBm/3 kHz)	Limit: <dBm/3KHz	Result
01	2412	-16.563	8	PASS
06	2437	-15.362	8	PASS
11	2462	-15.555	8	PASS

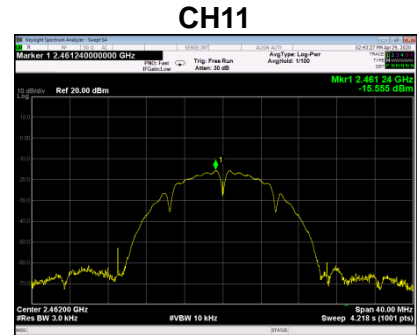
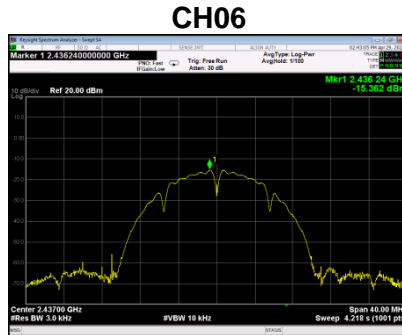
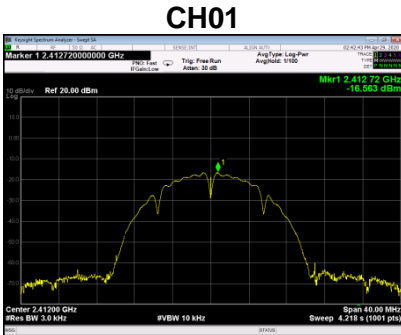

TX G Mode				
Channel	Frequency (MHz)	Power Spectral Density (dBm/3 kHz)	Limit: <dBm/3KHz	Result
01	2412	-18.688	8	PASS
06	2437	-18.912	8	PASS
11	2462	-18.056	8	PASS

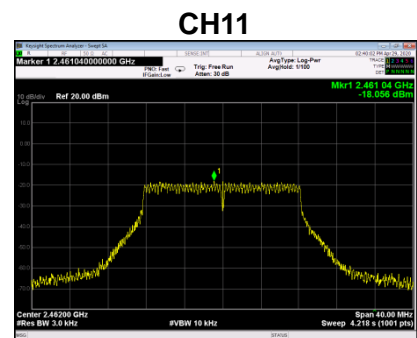
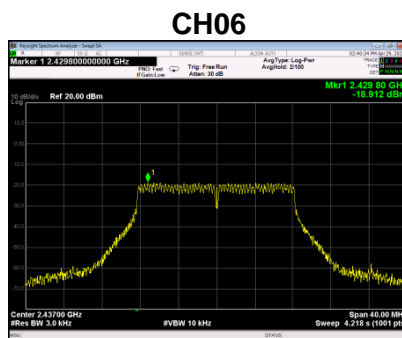
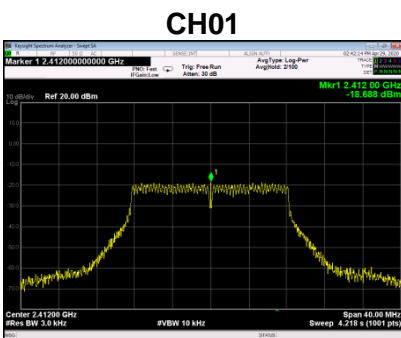

TX N (HT20) Mode				
Channel	Frequency (MHz)	Power Spectral Density (dBm/3 kHz)	Limit: <dBm/3KHz	Result
01	2412	-15.575	8	PASS
06	2437	-17.065	8	PASS
11	2462	-16.635	8	PASS

CH01

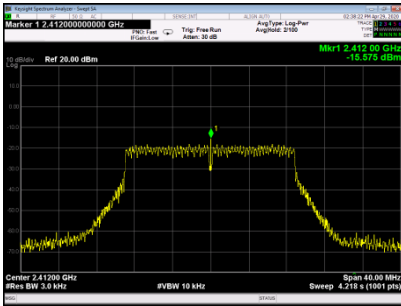

CH06

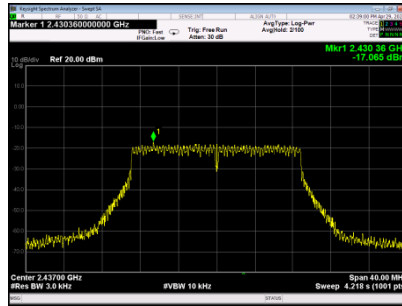

CH11

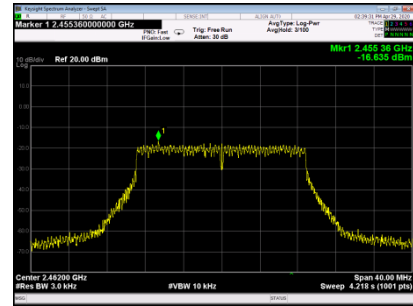

TX N (HT40) Mode				
Channel	Frequency (MHz)	Power Spectral Density (dBm/3 kHz)	Limit: <dBm/3KHz	Result
03	2412	-16.746	8	PASS
06	2437	-17.805	8	PASS
09	2452	-18.982	8	PASS

CH03

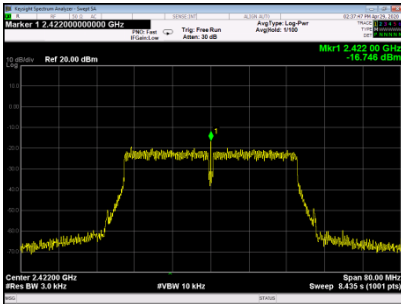

CH06

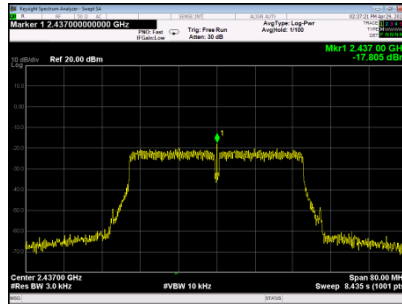

CH09

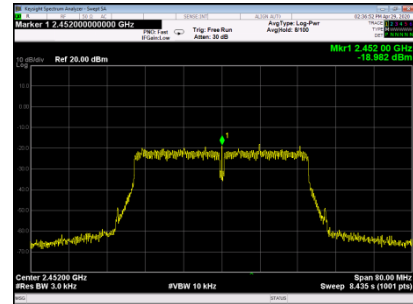

END OF TEST REPORT