



Bluetooth soundbar

SR219

For the most up-to-date version of this User's Guide, go to www.iLiveElectronics.com

Safety Instructions & Warnings



WARNING: To reduce the risk of electric shock, do not remove cover (or back). No user-serviceable parts inside. Refer servicing to qualified service personnel.



The exclamation point within an equilateral triangle is intended to alert the user to the presence of important operating and maintenance (servicing) instructions in the literature accompanying the appliance.



The lightning flash with arrowhead symbol, within an equilateral triangle, is intended to alert the user to the presence of un-insulated "dangerous voltage" within the product's enclosure that may be of sufficient magnitude to constitute a risk of electric shock to persons.



This symbol indicates that this product incorporates double insulation between hazardous mains voltage and user accessible parts.



WARNING : This product can expose you to chemicals including lead, which is known to the State of California to cause cancer and birth defects or other reproductive harm. For more information go to www.P65Warnings.ca.gov. **This product meets and complies with all Federal regulations.**

Important Safety Instructions

- Read these Instructions.
- Keep these Instructions.
- Heed all Warnings.
- Follow all instructions.
- Do not use this apparatus near water.
- Clean only with a dry cloth.
- Do not block any ventilation openings. Install in accordance with the manufacturer's instructions.
- Do not install near any heat sources such as radiators, heat registers, stoves, or other apparatus (including amplifiers) that produce heat.
- Do not defeat the safety purpose of the polarized or grounding - type plug. A polarized plug has two blades with one wider than the other. A grounding type plug has two blades and a third grounding prong. The wide blade or the third prong are provided for your safety. When the provided plug does not fit into your outlet, consult an electrician for replacement of the obsolete outlet.
- Protect the power cord from being walked on or pinched particularly at plugs, convenience receptacles, and the point where they exit from the apparatus.
- Only use attachments/accessories specified by the manufacturer.
- Unplug this apparatus during lightning storms or when unused for long periods of time.
- Refer all servicing to qualified service personnel. Servicing is required when the apparatus has been damaged in any way, such as power-supply cord or plug is damaged, liquid has been spilled or objects have fallen into the apparatus, the apparatus has been exposed to rain or moisture, does not operate normally, or has been dropped.
- Use only with a cart, stand, tripod, bracket, or table specified by the manufacturer, or sold with the apparatus. When a cart is used, use caution when moving the cart/apparatus combination to avoid injury from tip-over.



WARNING: Never place a television set in an unstable location. A television set may fall, causing serious personal injury or death. Many injuries, particularly to children can be avoided by taking simple precautions such as:

- Using cabinets or stands recommended by the manufacturer of the televisions set.
- Only using furniture that can safely support the television set.
- Ensuring the televisions set is not overhanging the edge of the supporting furniture.
- Not placing the televisions set on cloth or other materials that may be located between the televisions set and supporting furniture.
- Educating children about the dangers of climbing on furniture to reach the televisions set or its controls.

If your television set is being retained and relocated, the same considerations as above should be applied.

NOTE: When choosing where to place this TV that there is a chance of staining and marks on the surface. As with any rubber compound made with oils, the feet could cause marks or staining where the feet rest.

FCC Warnings

Warning: Changes or modifications to this unit not expressly approved by the party responsible for compliance could void the user's authority to operate the equipment.

NOTE: This equipment has been tested and found to comply with the limits for a Class B digital device, pursuant to Part 15 of the FCC Rules. These limits are designed to provide reasonable protection against harmful interference in a residential installation. This equipment generates, uses, and can radiate radio frequency energy and, if not installed and used in accordance with the instructions, may cause harmful interference to radio communications. However, there is no guarantee that interference will not occur in a particular installation. If this equipment does cause harmful interference to radio or television reception, which can be determined by turning the equipment off and on, the user is encouraged to try to correct the interference by one or more of the following measures:

- Reorient or relocate the receiving antenna.
- Increase the separation between the equipment and receiver.
- Connect the equipment into an outlet on a circuit different from that to which the receiver is connected.
- Consult the dealer or an experienced radio/TV technician for help.

FCC Radiation Exposure Statement:

This equipment complies with FCC radiation exposure limits set forth for an uncontrolled environment. This equipment should be installed and operated with minimum distance 20cm between the radiator & your body.

This device complies with Part 15 of the FCC Rules. Operation is subject to the following two conditions:

- (1) **This device may not cause harmful interference, and**
- (2) **this device must accept any interference received, including interference that may cause undesired operation.**

Battery Warnings

- **WARNING:** Do not ingest battery, Chemical Burn Hazard.
- If the remote control supplied with this product contains a coin/button cell battery and the coin/button cell battery is swallowed, it can cause severe internal burns in just 2 hours and can lead to death.
- Keep new and used batteries away from children. If the battery compartment does not close securely, stop using the product and keep it away from children.
- If you think batteries might have been swallowed or placed inside any part of the body, seek immediate medical attention.
- **CAUTION:** Danger of explosion if battery is incorrectly replaced. Replace only with the same or equivalent type.
- **WARNING:** There is a danger of explosion if you attempt to charge standard Alkaline batteries in the unit. Only use rechargeable NiMH batteries.
- Battery shall not be exposed to excessive heat such as sunshine, fire, or the like.
- Do not mix old and new batteries.
- Completely replace all old batteries with new ones.
- Do not mix alkaline, standard (carbon-zinc), or rechargeable (ni-cad, ni-mh, etc) batteries.
- Batteries should be recycled or disposed of as per state and local guidelines.

Additional Warnings and Precautions

- **CAUTION: TO PREVENT ELECTRIC SHOCK, MATCH WIDE BLADE OF PLUG TO WIDE SLOT, FULLY INSERT.**
- Mains plug is used as disconnect device and it should remain readily operable during intended use. In order to disconnect the apparatus from the mains completely, the mains plug should be disconnected from the mains socket outlet completely.
- **CAUTION:** Use of controls or adjustments or performance of procedures other than those specified may result in hazardous radiation exposure.
- **WARNING:** Changes or modifications to this unit not expressly approved by the party responsible for compliance could void the user's authority to operate the equipment.
- **WARNING:** Use of this unit near fluorescent lighting may cause interference regarding use of the remote. If the unit is displaying erratic behavior move away from any fluorescent lighting, as it may be the cause.
- **WARNING:** Shock hazard - Do Not Open.
- Caution and marking information is located at the rear or bottom of the apparatus.
- **WARNING:** To reduce the risk of fire or electric shock, do not expose this apparatus to rain, moisture, dripping, or splashing.
- Objects filled with liquids, such as vases, shall not be placed on the apparatus.

Table of Contents

Setup	5
Features & Specifications	
Power	
Remote Battery	
Includes	
Orientation	6
Front View	
Speaker Controls (Right Side)	
Speaker Inputs (Rear View)	
Remote	
Wall Mounting	8
Bluetooth Wireless	9
Initial Bluetooth Connection and Playing Audio	
Previously Connected Devices	
What Is the Learn Feature?	
Why Use the Learn Feature?	
Using the Learn Feature	
Audio Inputs	10
Stereo RCA Inputs (Aux In)	
Subwoofer Output	
Optical Input	
Line In	
Stereo RCA Inputs (Aux In) - Detail	
Optical Input - Detail	
Line In	
Line In - Detail	
Company Information	12
Contact Information	
International Support	
Warranty	

Setup

Features & Specifications

- 32" length
- Supports Bluetooth
- Wireless range: 60 ft.
- 2 channel stereo sound
- Digital volume control
- Full-function remote
- Learning remote control capability
- Optical digital audio input
- Subwoofer output
- Aux In (3.5mm audio input)
- RCA stereo audio inputs

Includes

- Remote control with CR2025 battery pre-installed
- Optical audio cable
- AC/DC power adapter
- Wall-mount hardware and instructions

Power

Plug the power cord into the DC Input on the back of the speaker and a standard wall outlet.

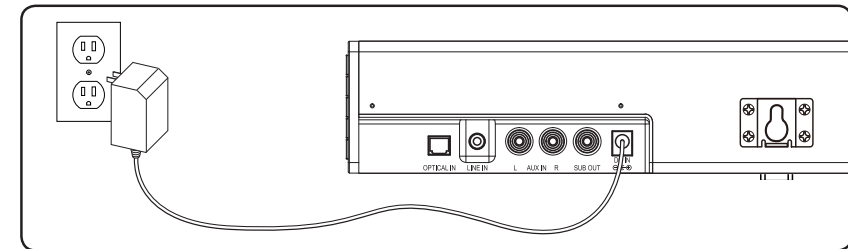

Remote Battery

Requires 1 CR2025 battery (pre-installed).

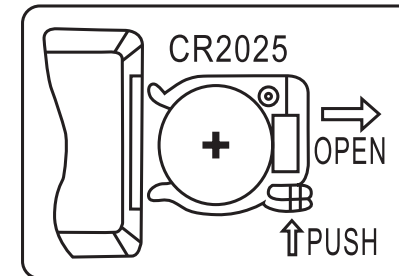

Orientation

Front View

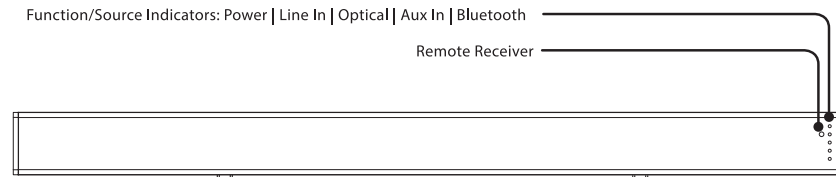

SOURCE MODE / STATUS	INDICATOR LIGHT
Power OFF	Red Light ON
Power ON	Red Light OFF
Line In (3.5mm audio input)	Green Light ON
Optical Input	Orange Light ON
Aux (RCA Stereo input)	White Light ON
Bluetooth Pairing	Quick Flashing Blue Light
Bluetooth Connected	Blue Light ON

Speaker Controls (Right Side)

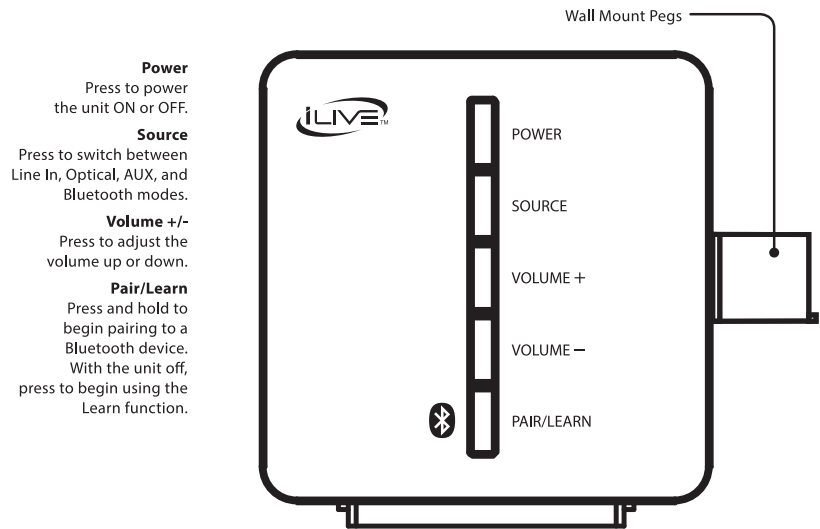

Speaker Inputs (Rear View)

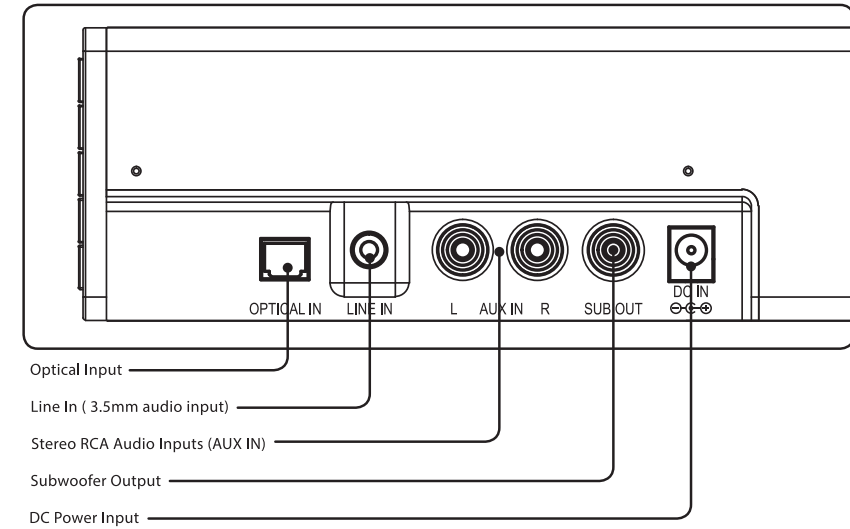

Remote

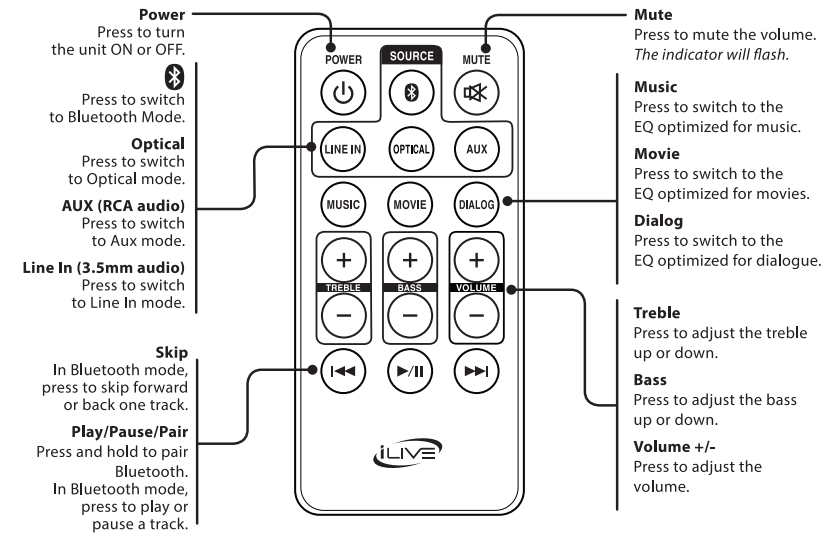

Wall Mounting

Wall Mount Bracket Installation

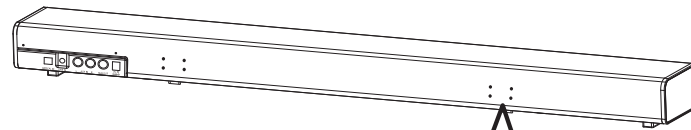

Step 1

Find the mounting bracket holes on the rear of the sound bar (4 per side).

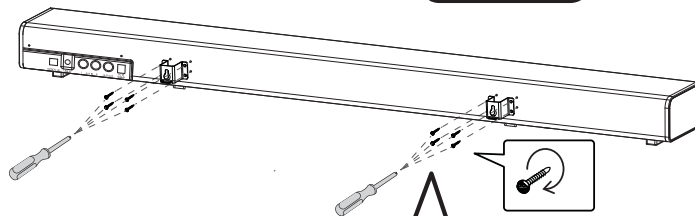

Step 2

Using a screwdriver, attach the mounting brackets to the sound bar.

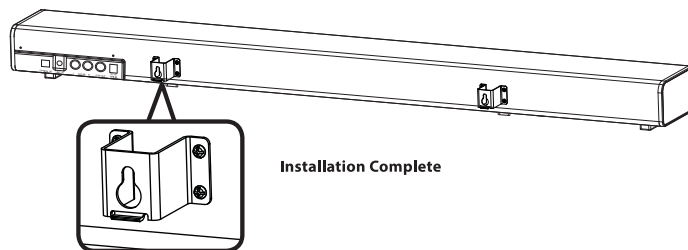
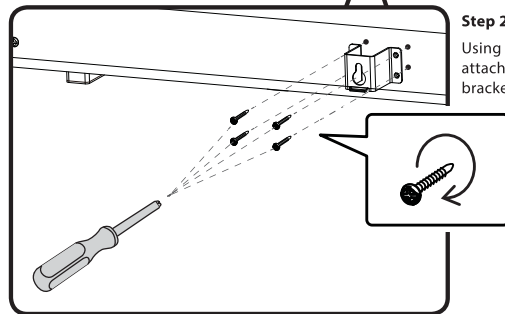

Installation Complete

Bluetooth Wireless

Initial Bluetooth Connection and Playing Audio

1. Power on the sound bar by pressing the **Power** button. A voice will say, "Bluetooth," and the LED indicator will slowly flash blue. When pairing, remain within 3 feet of the Bluetooth device.
2. Using the controls on your Bluetooth device, select **ITB196** in the Bluetooth Settings to pair. If need be, refer to the user's manual for your specific device for more information.
3. When successfully paired, a voice will announce, "Bluetooth is connected," and the LED indicator will turn solid blue. Audio from the connected Bluetooth device will now be heard through the speaker.
4. Use the controls on the connected Bluetooth device to select and play audio. Use the speaker controls or the connected Bluetooth device to play, pause, and adjust the volume level.
5. After initial pairing, press the **Power** button until the voice prompt says, "Power on." The speaker will power ON and automatically connect to the last Bluetooth device used. **Note:** If your device should become unpaired or you find it is unable to connect, press & hold the **Play** button to enter to Pairing Mode. A voice will announce, "Bluetooth is connecting," and you can connect to the speaker manually.

Note: This sound bar has last function memory. After powering OFF, it will resume the last play mode when powering ON again. Remember to press the **Bluetooth** button to switch it to Bluetooth Mode before connecting.

Previously Connected Devices

- The sound bar can remember multiple Bluetooth devices and will always try to re-connect to the last device used.
- To reconnect to a different device, turn off Bluetooth on unwanted devices, then access the Bluetooth settings menu on the device you wish to use and select **ITB196**.

Learn Feature

What Is the Learn Feature?

The Learn feature captures remote commands from your television remote, and teaches your sound bar to operate when these commands are pressed. Power, volume and mute are a few examples of commands that the sound bar can learn.

Why Use the Learn Feature?

Teaching the sound bar remote commands will reduce the number of remotes needed, save time searching for remote codes, and improve the ease of operation.

Note: Not all functions of the sound bar will be available through your own remote control. Use the included remote for these functions. While ITB196 is able to learn most IR protocols, not all can be programmed.

Using the Learn Feature

1. With the power Off, press the **Learn** button on the unit. An indicator light will begin flashing red.
2. Press the button you desire to be learned on the included remote. For example: **Volume +**
3. The **red light** will continue to flash, and another indicator will display a **blue light**.
4. Press the corresponding button on your remote.
5. The **red light** will continue to flash, and another indicator will display a **green light**.
6. Press the **Learn** button on the unit.
7. The programmed button on your remote will now be able to control your sound bar. **Note:** It is necessary to program each button on your remote separately.
8. If the sound bar has failed to learn a command, the indicator will display an orange light. Please try another remote control.

Audio Inputs

Stereo RCA Inputs (Aux In)

1. Connect the RCA cables (not included) to the RCA Stereo Inputs located on the back of the unit, and to the audio outputs on a television or other audio source.
2. Press the **Power** button to power on the unit.
3. Press the **Source** button to select **Aux In**, indicated by a white light.
4. Audio played through the television will now be heard through the speakers.

Subwoofer Output

The sound bar can be connected to a detached subwoofer by using another RCA cable (not included).

1. With the main stereo RCA cables connected, use another RCA cable (not included) to connect an external subwoofer to the **Subwoofer Output**.
2. When audio is played through any source, the speaker will automatically use the connected subwoofer.

Optical Input

Requires an audio source with an Optical Audio Output and a Digital Optical Audio Cable (included).

1. Using a Digital Optical Audio Cable, connect the **Optical Input** on the sound bar to the Optical Output on your audio source (TV, amplifier, etc.).
2. Power ON the sound bar and press **Optical** on the remote or **Source** on the sound bar to select **Optical Mode**. A voice will announce the source mode and the indicator will turn orange.
3. On the connected audio source (TV, amplifier, etc.), be sure the audio settings are set to PCM or Optical Audio.
4. Audio played through the connected audio source (TV, amplifier, etc.) should now be heard through the speaker.

Important tips for optical audio:

- Use the correct optical audio cable and make sure that it is firmly seated in both source and sound bar sockets.
- Optical audio output is activated from the audio source (a red light should be visible from the optical socket). It may be labeled SPDIF in the settings menu of the source.
- The optical output source should be set to output PCM and not Dolby Digital.

Line In

Requires 3.5 mm audio input cable (not included).

1. Plug one end of a 3.5 mm audio input cable into the **Line In** on the unit and plug the other end of the cable into the audio output/headphone output on an MP3 Player or other audio source.
2. Press the **Power** button to power the unit on.
3. Press the **Source** button to select **Line In**, indicated by a green light.
4. Audio played through the connected device will now be heard through the speakers. Use the controls on the connected device to play, pause, or skip selected tracks.

Stereo RCA Inputs (Aux In) - Detail

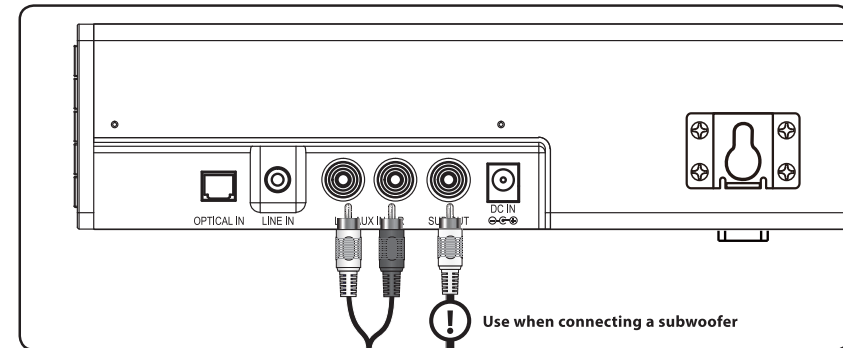

Optical Input - Detail

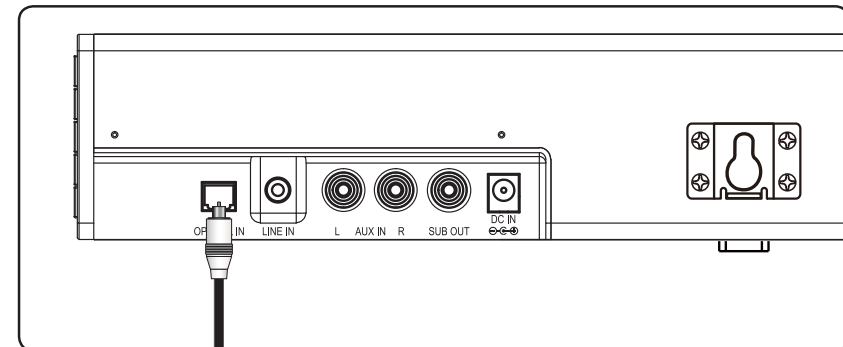

Line In

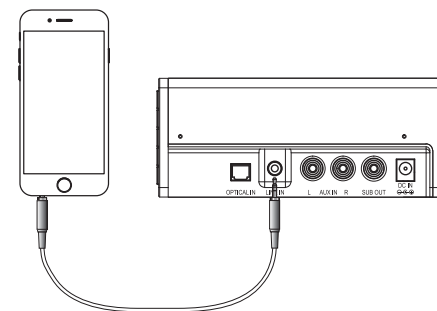

Line In - Detail

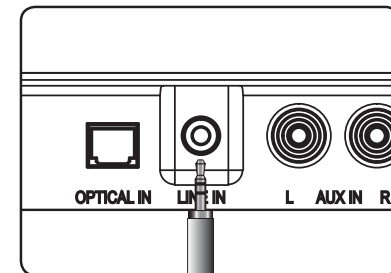

Company Information

Contact Information

Website: www.iLiveElectronics.com

Email Support: prodinfo@dpiinc.com

Email Parts: partsinfo@dpiinc.com

Phone Support: 1-888-999-4215

Warranty

For Warranty Information and the most up-to-date version of this User's Guide, go to:
www.iLiveElectronics.com

International Support

To download this User's Guide in English, Spanish, and French, or to get answers to frequently asked questions, visit the support section at: www.iLiveElectronics.com

Para descargar este Manual del Usuario en inglés, español y francés, o para obtener respuestas a preguntas frecuentes, visite la sección de apoyo en: www.iLiveElectronics.com

Pour télécharger ce guide de l'utilisateur en anglais, espagnol ou français, ou pour obtenir des réponses à des questions fréquemment posées, consultez la rubrique d'assistance sur: www.iLiveElectronics.com



***Protect for Today
Sustain for Tomorrow***

Copyright © 2019 Digital Products International (DPI, Inc.) All other trademarks appearing herein are the property of their respective owners. Specifications are subject to change without notice.