

BT Test Report

Application Purpose : Original grant
Applicant Name: : Shenzhen SKY DRAGON Audio-video Technology Co.,LTD
FCC ID : ZJPHTB017B
Equipment Type : Bluetooth Speaker
Model Name : SR110 , HTB017B , SR212
Report Number : FCC17010003A
Standard(S) : FCC Part 15 Subpart C
Date Of Receipt : January 03, 2017
Date Of Issue : January 13, 2017

Test By :



(Daisy Qin)

Reviewed By :



(Sol Qin)

Authorized by :



(Michal Ling)

Prepared by :

QTC Certification & Testing Co., Ltd.

2nd Floor,B1 Buiding,Fengyeyuan Industrial Plant,,Liuxian
2st.Road,Xin'an Street,Bao'an District,,Shenzhen,
518000China. **Registration Number: 588523**

| REPORT REVISE RECORD | | | | |
|----------------------|-------------|------------------|---------------|-----------------|
| Report Version | Revise Time | Issued Date | Valid Version | Notes |
| V1.0 | / | January 12, 2017 | Valid | Original Report |
| | | | | |

| | |
|---|-----------|
| GENERAL DESCRIPTION OF EUT | 5 |
| 2.1 MEASUREMENT UNCERTAINTY 7 | |
| 2.2 DESCRIPTION OF TEST MODES 8 | |
| 2.3 TABLE OF PARAMETERS OF TEXT SOFTWARE SETTING 9 | |
| 2.4 CONFIGURATION OF SYSTEM UNDER TEST 9 | |
| 2.5 DESCRIPTION OF SUPPORT UNITS (CONDUCTED MODE) 10 | |
| 3. SUMMARY OF TEST RESULTS..... | 11 |
| 4. MEASUREMENT INSTRUMENTS | 12 |
| STANDARD APPLICABLE 13 | |
| ANTENNA CONNECTOR CONSTRUCTION 13 | |
| §15.207 - CONDUCTED EMISSIONS | 14 |
| APPLICABLE STANDARD 14 | |
| TEST PROCEDURE 14 | |
| TEST CONDITIONS 14 | |
| PLOT(S) OF TEST DATA 14 | |
| §15.209, §15.205, §15.247(D) - SPURIOUS EMISSIONS..... | 17 |
| TEST EQUIPMENT 17 | |
| TEST PROCEDURE 17 | |
| ENVIRONMENTAL CONDITIONS 17 | |
| RADIATED EMISSION LIMIT 20 | |
| §15.247(A) (2) – 6DB BANDWIDTH TESTING..... | 26 |
| TEST EQUIPMENT 26 | |
| TEST PROCEDURE 26 | |
| ENVIRONMENTAL CONDITIONS 26 | |
| APPLICABLE STANDARD 26 | |
| TEST RESULT: PASS. 27 | |
| §15.247(B) (3) - MAXIMUM PEAK OUTPUT POWER | 29 |
| TEST EQUIPMENT 29 | |
| TEST PROCEDURE 29 | |
| ENVIRONMENTAL CONDITIONS 29 | |
| APPLICABLE STANDARD 29 | |
| TEST RESULT 30 | |

§15.247(D) – 100 KHZ BANDWIDTH OF FREQUENCY BAND EDGE..... 32

TEST EQUIPMENT 32

TEST PROCEDURE 32

ENVIRONMENTAL CONDITIONS 32

APPLICABLE STANDARD 32

TEST RESULT 32

§15.247(E) -MAXIMUM CONDUCTED POWER SPECTRAL DENSITY 37

TEST EQUIPMENT 37

TEST PROCEDURE 37

ENVIRONMENTAL CONDITIONS 37

APPLICABLE STANDARD 37

TEST RESULT 38

PHOTOGRAPHS OF THE TEST CONFIGURATION 40

PHOTOGRAPHS OF EUT..... 42

1. GENERAL INFORMATION

GENERAL DESCRIPTION OF EUT

| | |
|-----------------------------|---|
| Test Model | SR110 |
| Reference type | HTB017B · SR212 |
| Applicant | Shenzhen SKY DRAGON Audio-video Technology Co.,LTD |
| Address | B16,Laneway 3,Liuxian 2RD,District71,Baoan,shenzhen |
| Manufacturer | Shenzhen SKY DRAGON Audio-video Technology Co.,LTD |
| Address | B16,Laneway 3,Liuxian 2RD,District71,Baoan,shenzhen |
| Equipment Type | Bluetooth Speaker |
| Brand Name | CKY |
| Hardware version: | SR110_V1.0 |
| Software version: | BK3254_SR110_(HTB017)_32I_MIC36_HUANG_20170109_JT2_(01DE) |
| Extreme Temp. Tolerance | -10°C to 55°C |
| Adapter Information: | N/A |
| Operating Frequency | 2402-2480MHz |
| Channels | 40 |
| Channel Spacing | 2MHz |
| Modulation Type | GFSK |
| Version | 4.0 |
| Antenna Type: | Integral Antenna |
| Antenna gain: | 0dBi |
| Data of receipt | January03, 2017 |
| Date of test | January 03, 2017 to January 12, 2017 |
| Deviation | None |
| Condition of Test Sample | Normal |

We hereby certify that:

All measurement facilities used to collect the measurement data are located at QTC Certification & Testing Co., Ltd.

Registration Number: 588523

The data evaluation, test procedures, and equipment configurations shown in this report were made in accordance with the procedures given in ANSI C 63.4:2014. The sample tested as described in this report is in compliance with the FCC Rules Part15 Subpart C.

ALL the testing were referenced KDB NO.558074

The test results of this report relate only to the tested sample identified in this report.

Model Difference

| Production Name | Trade Name | Model No. |
|-------------------|------------|-------------------------|
| Bluetooth Speaker | SKON | SR110 , HTB017B , SR212 |

Note:1.The difference between the product model is only appearance, brand and model number ,other design is same.

2. In addition, the appearance difference is only the size, but PCBA is the same.

2. TEST DESCRIPTION

2.1 MEASUREMENT UNCERTAINTY

The reported uncertainty of measurement $y \pm U$, where expanded uncertainty U is based on a standard uncertainty multiplied by a coverage factor of $k=2$, providing a level of confidence of approximately **95 %**.

| No. | Item | Uncertainty |
|-----|-------------------------------|-------------------------|
| 1 | Conducted Emission Test | $\pm 3.2\text{dB}$ |
| 2 | RF power, conducted | $\pm 0.16\text{dB}$ |
| 3 | Spurious emissions, conducted | $\pm 0.21\text{dB}$ |
| 4 | All emissions, radiated(<1G) | $\pm 4.7\text{dB}$ |
| 5 | All emissions, radiated(>1G) | $\pm 4.7\text{dB}$ |
| 6 | Temperature | $\pm 0.5^\circ\text{C}$ |
| 7 | Humidity | $\pm 2\%$ |

2.2 DESCRIPTION OF TEST MODES

To investigate the maximum EMI emission characteristics generated from EUT, the test system was pre-scanning tested based on the consideration of following EUT operation mode or test configuration mode which possibly have effect on EMI emission level. Each of these EUT operation mode(s) or test configuration mode(s) mentioned above was evaluated respectively.

| Pretest Mode | Description |
|--------------|-------------|
| Mode 1 | CH00 |
| Mode 2 | CH19 |
| Mode 3 | CH39 |
| Mode 4 | Normal |

| For Conducted Emission | |
|------------------------|-------------|
| Final Test Mode | Description |
| Mode 4 | Normal |

| For Radiated Emission | |
|-----------------------|-------------|
| Final Test Mode | Description |
| Mode 1 | CH00 |
| Mode 2 | CH19 |
| Mode 3 | CH39 |

Note:

- (1) The measurements are performed at the highest, middle, lowest available channels.**
- (2) Record the worst case of each test item in this report.**

2.3 Table of Parameters of Text Software Setting

During testing channel & power controlling software provided by the customer was used to control the operating channel as well as the output power level. The RF output power selection is for the setting of RF output power expected by the customer and is going to be fixed on the firmware of the final end product power parameters.

| | | | |
|-----------------------|-----|--|--|
| Test software Version | N/A | | |
|-----------------------|-----|--|--|

| | | | |
|-------------------|----------|----------|----------|
| Frequency | 2402 MHz | 2440 MHz | 2480 MHz |
| Parameters(1Mbps) | DEF | DEF | DEF |

2.4 CONFIGURATION OF SYSTEM UNDER TEST

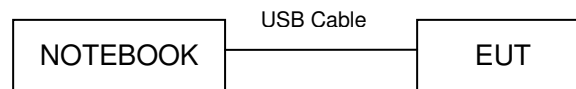

(EUT: Bluetooth Speaker)

2.5 DESCRIPTION OF SUPPORT UNITS (CONDUCTED MODE)

The EUT has been tested as an independent unit together with other necessary accessories or support units. The following support units or accessories were used to form a representative test configuration during the tests.

| Item | Equipment | Mfr/Brand | Model/Type No. | Series No. | Note |
|------|---------------------|-----------------|---------------------|------------|------|
| 1 | USB Cable | / | N/A | / | / |
| 2 | The notebook | ThinkPad | ThinkPadE450 | | |

Note:

- (1) The support equipment was authorized by Declaration of Confirmation.
- (2) For detachable type I/O cable should be specified the length in cm in 『Length』 column.
- (3) “YES” is means “shielded” “with core”; “NO” is means “unshielded” “without core”.

3. SUMMARY OF TEST RESULTS

Test procedures according to the technical standards:

| FCC Part15 (15.247) , Subpart C | | | |
|--|---|-----------------|---------------|
| Standard Section | Test Item | Judgment | Remark |
| 15.203 | Antenna Requirement | PASS | |
| 15.207 | Conducted Emission | PASS | |
| 15.209, 15.205, 15.247(d) | Spurious Emission | PASS | |
| 15.247(a) (2) | 6dB Bandwidth Testing | PASS | |
| 15.247(b) (3) | Maximum Peak Output Power | PASS | |
| 15.247(d) | 100 KHz Bandwidth of Frequency Band Edge | PASS | |
| 15.247(e) | Maximum Conducted Power Spectral Density | PASS | |

NOTE:

(1) "N/A" denotes test is not applicable in this test report.

4. MEASUREMENT INSTRUMENTS

| NAME OF EQUIPMENT | MANUFACTURER | MODEL | SERIAL NUMBER | Calibration Date | Calibration Due. |
|--------------------------------------|------------------------|--------------|---------------|------------------|------------------|
| EMI Test Receiver | R&S | ESCI | 100005 | 08/19/2016 | 08/18/2017 |
| LISN | AFJ | LS16 | 16010222119 | 08/19/2016 | 08/18/2017 |
| LISN(EUT) | Mestec | AN3016 | 04/10040 | 08/19/2016 | 08/18/2017 |
| Universal Radio Communication Tester | R&S | CMU 200 | 1100.0008.02 | 08/19/2016 | 08/18/2017 |
| Coaxial cable | Megalon | LMR400 | N/A | 08/12/2016 | 08/11/2017 |
| GPIB cable | Megalon | GPIB | N/A | 08/12/2016 | 08/11/2017 |
| Spectrum Analyzer | R&S | FSU | 100114 | 08/19/2016 | 08/18/2017 |
| Pre Amplifier | H.P. | HP8447E | 2945A02715 | 10/13/2016 | 10/12/2017 |
| Pre-Amplifier | CDSI | PAP-1G18-38 | -- | 10/13/2016 | 10/12/2017 |
| Bi-log Antenna | SUNOL Sciences | JB3 | A021907 | 10/15/2016 | 10/14/2017 |
| 9*6*6 Anechoic | -- | -- | -- | 10/22/2016 | 10/21/2017 |
| 8*4*3 Shield | -- | -- | -- | 10/22/2016 | 10/21/2017 |
| Horn Antenna | COMPLIANCE ENGINEERING | CE18000 | -- | 10/15/2016 | 10/14/2017 |
| Horn Antenna | SCHWARZBECK | BBHA9120D | 9120D-631 | 10/15/2016 | 10/14/2017 |
| Cable | TIME MICROWAVE | LMR-400 | N-TYPE04 | 04/25/2016 | 04/24/2017 |
| System-Controller | CCS | N/A | N/A | N.C.R | N.C.R |
| Turn Table | CCS | N/A | N/A | N.C.R | N.C.R |
| Antenna Tower | CCS | N/A | N/A | N.C.R | N.C.R |
| RF cable | Murata | MXHQ87WA3000 | - | 08/21/2016 | 08/20/2017 |
| Loop Antenna | EMCO | 6502 | 00042960 | 08/22/2016 | 08/21/2017 |
| Horn Antenna | SCHWARZBECK | BBHA 9170 | 1123 | 08/19/2016 | 08/18/2017 |
| Power meter | Anritsu | ML2487A | 6K00003613 | 08/23/2016 | 08/22/2017 |
| Power sensor | Anritsu | MX248XD | -- | 08/19/2016 | 08/18/2017 |

§15.203 - ANTENNA REQUIREMENT

Standard Applicable

According to § 15.203, an intentional radiator shall be designed to ensure that no antenna other than that furnished by the responsible party shall be used with the device. The use of a permanently attached antenna or of an antenna that uses a unique coupling to the intentional radiator shall be considered sufficient to comply with the provisions of this section. The manufacturer may design the unit so that a broken antenna can be replaced by the user, but the user of a standard antenna jack or electrical connector is prohibited. The structure and application of the EUT were analyzed to determine compliance with section §15.203 of the rules. §15.203 state that the subject device must meet the following criteria:

- a. Antenna must be permanently attached to the unit.
- b. Antenna must use a unique type of connector to attach to the EUT.

Unit must be professionally installed, and installer shall be responsible for verifying that the correct antenna is employed with the unit.

And according to FCC 47 CFR section 15.247 (b), if the transmitting antennas of directional gain greater than 6dBi are used, the power shall be reduced by the amount in dB that the directional gain of the antenna exceeds 6 dBi.

Antenna Connector Construction

The EUT's antenna integrated on PCB, The antenna's gain is 0dBi and meets the requirement.

§15.207 - CONDUCTED EMISSIONS

Applicable Standard

The specification used was with the FCC Part 15.207 limits.

Test Procedure

During the conducted emission test, the EUT was connected to the outlet of the LISN.

Maximizing procedure was performed on the six (6) highest emissions of the EUT.

All data was recorded in the Quasi-peak and average detection mode.

Test Result

PASS

Test Conditions

| | |
|--------------------|-----------|
| Temperature: | 26 °C |
| Relative Humidity: | 60% |
| ATM Pressure: | 100.0kPa |
| Voltage | 120V/60Hz |

Plot(s) of Test Data

Plot(s) of Test Data is presented hereinafter as reference.

Phase: L

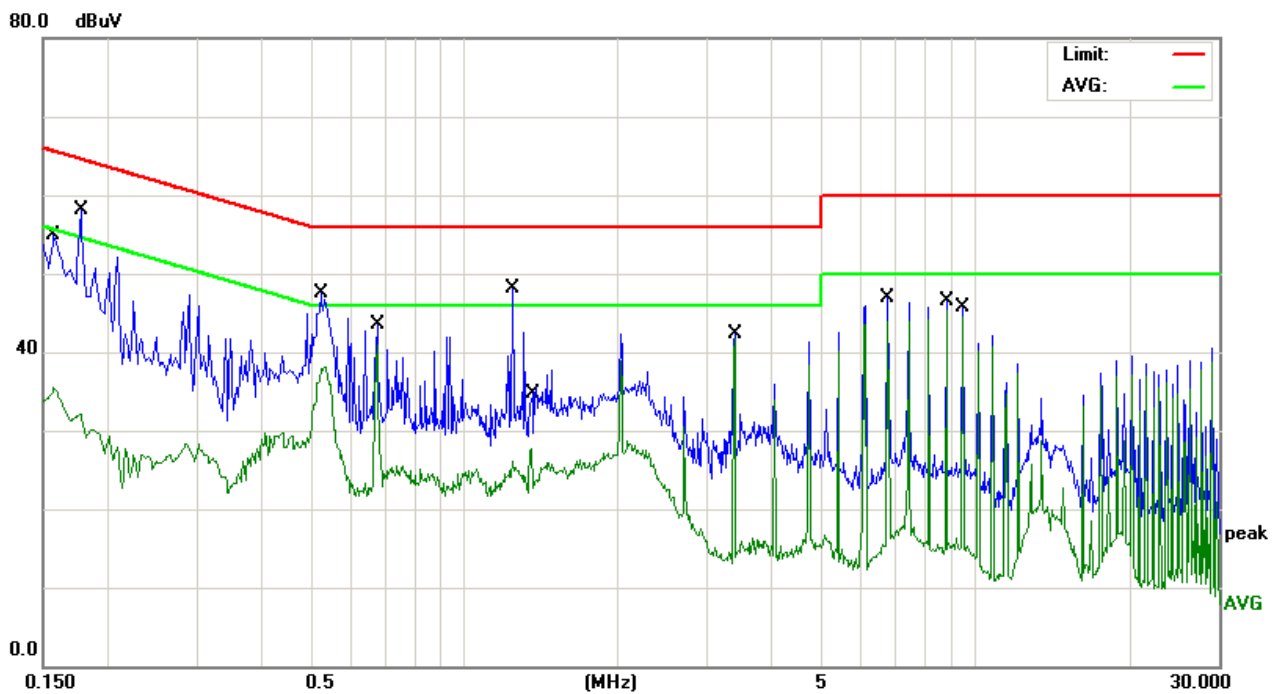

| No. | Mk. | Freq. MHz | Reading Level dBuV | Correct Factor dB | Measure- ment dBuV | Limit dBuV | Over dB | Detector |
|-----|-----|--------------|--------------------------|-------------------------|--------------------------|---------------|------------|----------|
| 1 | | 0.1580 | 23.64 | 11.79 | 35.43 | 55.56 | -20.13 | AVG |
| 2 | | 0.1780 | 46.59 | 11.52 | 58.11 | 64.57 | -6.46 | QP |
| 3 | | 0.5260 | 36.72 | 10.80 | 47.52 | 56.00 | -8.48 | QP |
| 4 | | 0.6780 | 30.14 | 10.77 | 40.91 | 46.00 | -5.09 | AVG |
| 5 | | 1.2460 | 37.55 | 10.62 | 48.17 | 56.00 | -7.83 | QP |
| 6 | | 1.3540 | 17.08 | 10.62 | 27.70 | 46.00 | -18.30 | AVG |
| 7 | | 3.3820 | 31.79 | 10.56 | 42.35 | 56.00 | -13.65 | QP |
| 8 | * | 3.3820 | 31.19 | 10.56 | 41.75 | 46.00 | -4.25 | AVG |
| 9 | | 6.7620 | 36.25 | 10.57 | 46.82 | 60.00 | -13.18 | QP |
| 10 | | 6.7620 | 33.30 | 10.57 | 43.87 | 50.00 | -6.13 | AVG |
| 11 | | 8.7940 | 34.67 | 10.58 | 45.25 | 50.00 | -4.75 | AVG |
| 12 | | 9.4700 | 35.17 | 10.58 | 45.75 | 60.00 | -14.25 | QP |

Remark: All of the Tx modes have been investigated, and only worst mode is presented in this report.

Phase: N

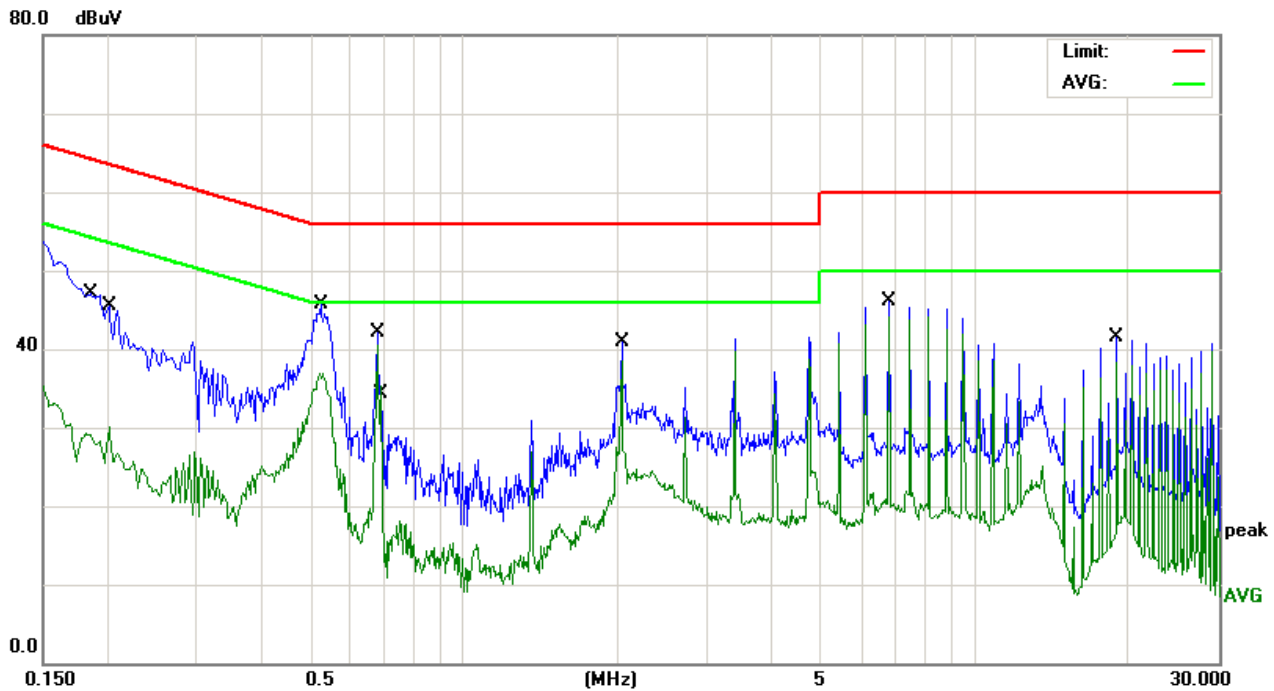

| No. | Mk. | Freq. MHz | Reading Level dBuV | Correct Factor dB | Measure- ment dBuV | Limit dBuV | Over dB | Detector |
|-----|-----|--------------|--------------------------|-------------------------|--------------------------|---------------|------------|----------|
| 1 | | 0.1864 | 35.49 | 11.40 | 46.89 | 64.19 | -17.30 | QP |
| 2 | | 0.2020 | 18.98 | 11.20 | 30.18 | 53.52 | -23.34 | AVG |
| 3 | | 0.5260 | 34.88 | 10.80 | 45.68 | 56.00 | -10.32 | QP |
| 4 | | 0.5299 | 26.09 | 10.80 | 36.89 | 46.00 | -9.11 | AVG |
| 5 | | 0.6780 | 31.23 | 10.77 | 42.00 | 56.00 | -14.00 | QP |
| 6 | | 0.6940 | 8.92 | 10.77 | 19.69 | 46.00 | -26.31 | AVG |
| 7 | | 2.0340 | 30.27 | 10.59 | 40.86 | 56.00 | -15.14 | QP |
| 8 | | 2.0340 | 27.99 | 10.59 | 38.58 | 46.00 | -7.42 | AVG |
| 9 | | 6.7820 | 35.59 | 10.57 | 46.16 | 60.00 | -13.84 | QP |
| 10 | * | 6.7820 | 33.47 | 10.57 | 44.04 | 50.00 | -5.96 | AVG |
| 11 | | 18.9940 | 30.92 | 10.63 | 41.55 | 60.00 | -18.45 | QP |
| 12 | | 18.9940 | 27.58 | 10.63 | 38.21 | 50.00 | -11.79 | AVG |

Remark: All of the Tx modes have been investigated, and only worst mode is presented in this report.

§15.209, §15.205, §15.247(d) - SPURIOUS EMISSIONS

Test Equipment

Please refer to section 4 this report.

Test Procedure

The out of band emission tests were performed in the 3-meter chamber test site, using the setup accordance with the ANSI C63.4-2014. The specification used was the FCC Part Subpart C limits.

- a. The measuring distance of at 3 m shall be used for measurements at frequency up to 1GHz. For frequencies above 1GHz, any suitable measuring distance may be used.
- b. The EUT was placed on the top of a rotating table 0.8 meters above the ground at a 3 meter open area test site. The table was rotated 360 degrees to determine the position of the highest radiation.
- c. The height of the equipment or of the substitution antenna shall be 0.8 m; the height of the test antenna shall vary between 1 m to 4 m. Both horizontal and vertical polarizations of the antenna are set to make the measurement.
- d. The initial step in collecting conducted emission data is a spectrum analyzer peak detector mode pre-scanning the measurement frequency range. Significant peaks are then marked and then Quasi Peak detector mode re-measured.
- e. If the Peak Mode measured value compliance with and lower than Quasi Peak Mode Limit, the EUT shall be deemed to meet QP Limits and then no additional QP Mode measurement performed.
- f. For the actual test configuration, please refer to the related Item –EUT Test Photos.

Note:

Both horizontal and vertical antenna polarities were tested

And performed pretest to three orthogonal axis. The worst case emissions were reported

Environmental Conditions

| | |
|--------------------|----------|
| Temperature: | 26 °C |
| Relative Humidity: | 55% |
| ATM Pressure: | 100.0kPa |

Radiated Test Setup

The system was investigated from 9 KHz to 25 GHz.

During the radiated emission test, the EMI test receiver & Spectrum Analyzer Setup were set with the following configurations:

| Frequency Range | RBW | Video B/W | Detector |
|-------------------|---------|-----------|----------|
| 9kHz-30MHz | 9kHz | 30 kHz | QP |
| 30 MHz – 1000 MHz | 100 kHz | 300 kHz | QP |
| 1000 MHz – 25 GHz | 1 MHz | 3 MHz | PK |
| 1000 MHz – 25 GHz | 1 MHz | 1 Hz | AVG |

(A) Radiated Emission Test-Up Frequency Below 30MHz

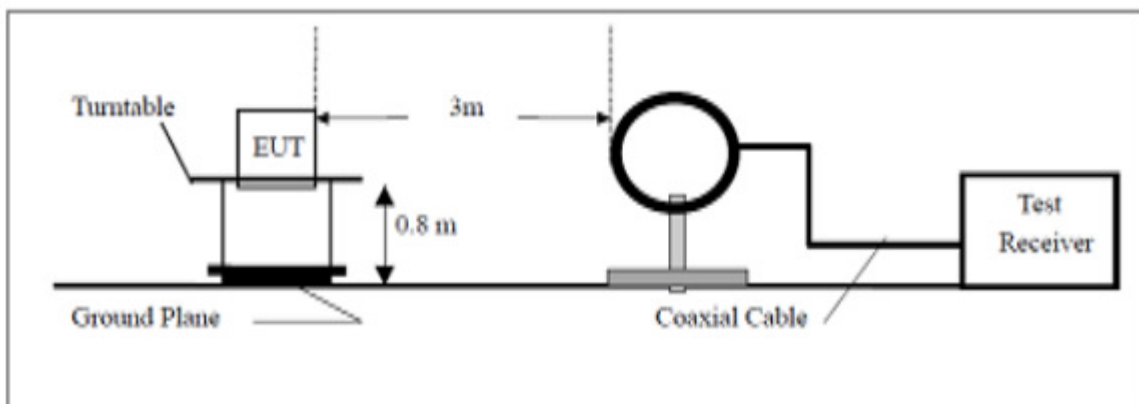

(B) Radiated Emission Test-Up Frequency 30MHz~1GHz

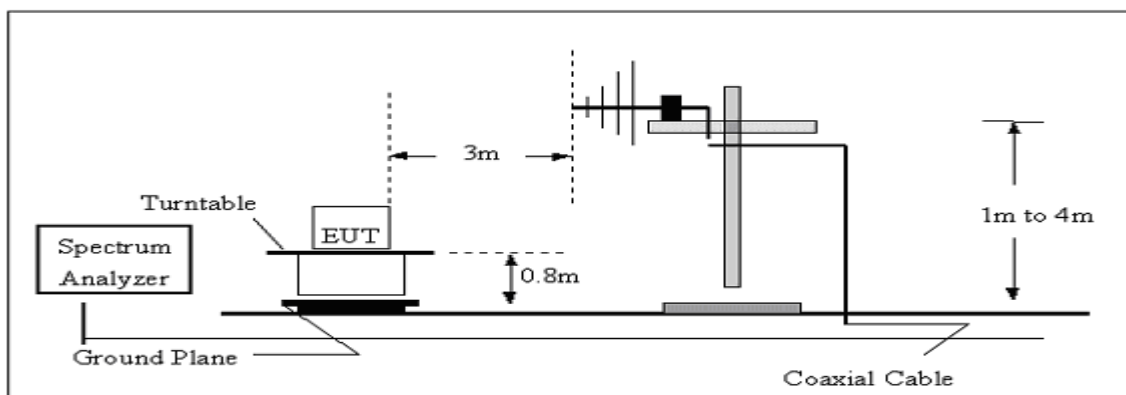

(C) Radiated Emission Test-Up Frequency Above 1GHz

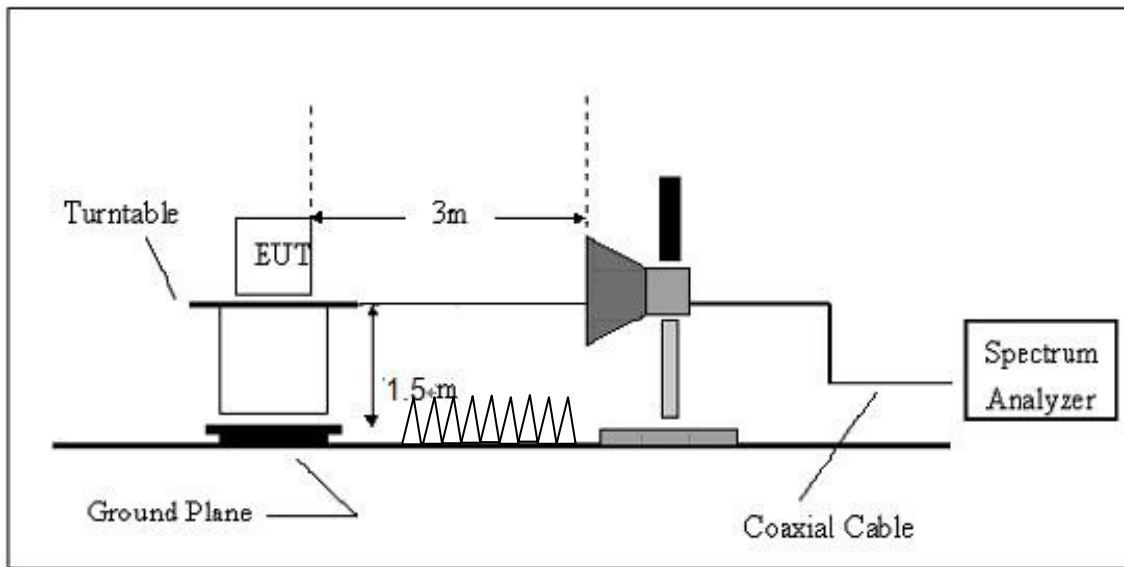

For the accrual test configuration, please refer to the related items-photos of Testing.

Radiated Emission Limit

Applicable Standard

FCC §15.247 (d); §15.209; §15.205;

Radiated Emission Test Result

Test Mode: Transmitting

| Frequency (MHz) | Field strength (microvolts/meter) | Measurement distance (meters) |
|-----------------|-----------------------------------|-------------------------------|
| 0.009–0.490 | 2400/F(kHz) | 300 |
| 0.490–1.705 | 24000/F(kHz) | 30 |
| 1.705–30.0 | 30 | 30 |
| 30–88 | 100** | 3 |
| 88–216 | 150** | 3 |
| 216–960 | 200** | 3 |
| Above 960 | 500 | 3 |

Note:

Both horizontal and vertical antenna polarities were tested and performed pretest to three orthogonal axis. The worst case emissions were reported

Test result:

From 9KHz to 30MHz

NOTE: 9KHz-30MHz the measurements were greater than 20dB below the limit.

Frequency from 30MHz to 1GHz

Horizontal:

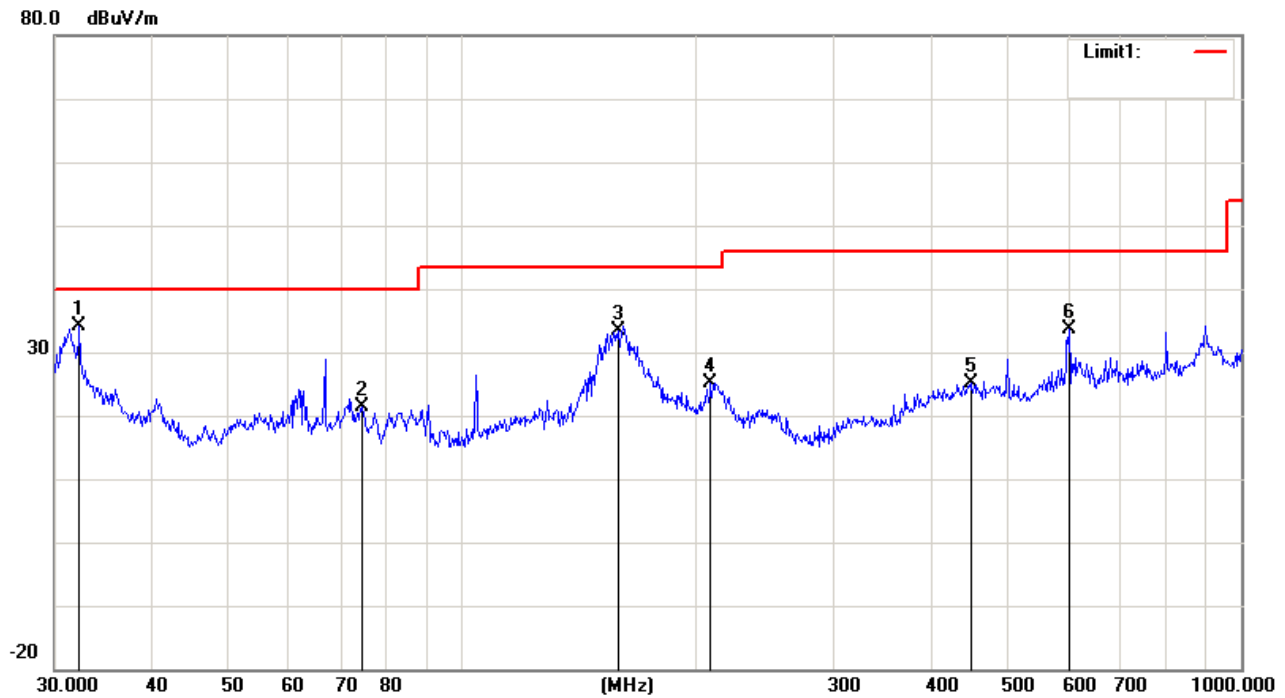

| No. | Mk. | Freq. MHz | Reading Level dBuV | Correct Factor dB | Measure- ment dBuV/m | Limit dBuV/m | Over dB | Detector |
|-----|-----|--------------|--------------------------|-------------------------|----------------------------|-----------------|------------|----------|
| 1 | * | 32.2925 | 32.07 | 1.95 | 34.02 | 40.00 | -5.98 | QP |
| 2 | | 74.3955 | 29.01 | -7.57 | 21.44 | 40.00 | -18.56 | QP |
| 3 | | 158.6677 | 37.59 | -4.30 | 33.29 | 43.50 | -10.21 | QP |
| 4 | | 208.5803 | 30.19 | -5.13 | 25.06 | 43.50 | -18.44 | QP |
| 5 | | 449.5558 | 27.10 | -2.07 | 25.03 | 46.00 | -20.97 | QP |
| 6 | | 601.4265 | 32.64 | 1.04 | 33.68 | 46.00 | -12.32 | QP |

Remark: All of the TX modes have been investigated, and only worst mode is presented in this report.

Vertical:

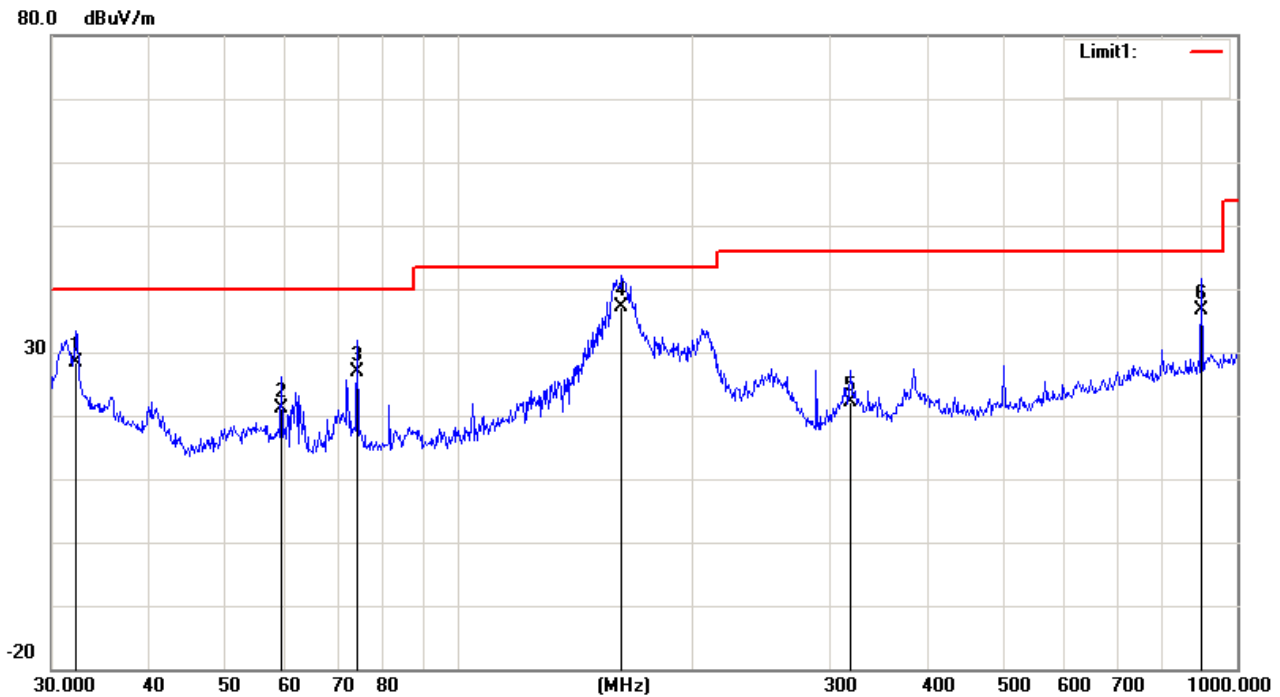

| No. | Mk. | Freq. MHz | Reading Level dBuV | Correct Factor dB | Measure- ment dBuV/m | Limit dBuV/m | Over dB | Detector |
|-----|-----|--------------|--------------------------|-------------------------|----------------------------|-----------------|------------|----------|
| 1 | | 32.2924 | 26.36 | 1.95 | 28.31 | 40.00 | -11.69 | QP |
| 2 | | 59.2325 | 30.49 | -9.41 | 21.08 | 40.00 | -18.92 | QP |
| 3 | | 74.1350 | 34.41 | -7.58 | 26.83 | 40.00 | -13.17 | QP |
| 4 | * | 162.0414 | 41.46 | -4.42 | 37.04 | 43.50 | -6.46 | QP |
| 5 | | 318.8170 | 26.70 | -4.48 | 22.22 | 46.00 | -23.78 | QP |
| 6 | | 900.1473 | 30.87 | 5.73 | 36.60 | 46.00 | -9.40 | QP |

Remark: All of the TX modes have been investigated, and only worst mode is presented in this report.

From 1GHz to 25GHz:

| | | | |
|--------------------|------------|---------------|------------------|
| Operation Mode: | Channel 0 | Test Date : | January 05, 2017 |
| Frequency Range: | Above 1GHz | Temperature : | 28°C |
| Test Result: | PASS | Humidity : | 65 % |
| Measured Distance: | 3m | Test By: | |

| Freq. (MHz) | Ant.Pol. | Emission Level(dBuV) | | Limit 3m(dBuV/m) | | Over(dB) | |
|----------------|----------|----------------------|-------|------------------|----|----------|--------|
| | H/V | PK | AV | PK | AV | PK | AV |
| 4804 | V | 60.22 | 39.63 | 74 | 54 | -13.78 | -14.37 |
| 7206 | V | 58.10 | 40.57 | 74 | 54 | -15.90 | -13.43 |
| 4804 | H | 58.10 | 39.87 | 74 | 54 | -15.90 | -14.13 |
| 7206 | H | 59.75 | 40.75 | 74 | 54 | -14.25 | -13.25 |

All emissions not reported were more than 20dB below the specified limit or in the noise floor.

- Note:**
- (1) All Readings are Peak Value and AV.
 - (2) Emission Level= Reading Level+ Probe Factor +Cable Loss.
 - (3) Data of measurement within this frequency range shown "--" in the table above means the reading of emissions are attenuated more than 20dB below the permissible limits or the field strength is too small to be measured.

Operation Mode: Channel 19 Test Date : January 05, 2017
 Frequency Range: Above 1GHz Temperature : 28°C
 Test Result: PASS Humidity : 65 %
 Measured Distance: 3m Test By:

| Freq. (MHz) | Ant.Pol. | Emission Level(dBuV) | | Limit 3m(dBuV/m) | | Over(dB) | |
|----------------|----------|----------------------|-------|------------------|----|----------|--------|
| | H/V | PK | AV | PK | AV | PK | AV |
| 4864.61 | V | 59.75 | 39.72 | 74 | 54 | -14.25 | -14.28 |
| 7126.53 | V | 58.91 | 40.90 | 74 | 54 | -15.09 | -13.10 |
| 4684.87 | H | 59.55 | 40.12 | 74 | 54 | -14.45 | -13.88 |
| 7226.50 | H | 59.31 | 40.31 | 74 | 54 | -14.69 | -13.69 |

All emissions not reported were more than 20dB below the specified limit or in the noise floor.

- Note:**
- (1) All Readings are Peak Value and AV.
 - (2) Emission Level= Reading Level+Probe Factor +Cable Loss.
 - (3) Data of measurement within this frequency range shown "--" in the table above means the reading of emissions are attenuated more than 20dB below the permissible limits or the field strength is too small to be measured.

Operation Mode: Channel 39 Test Date : January 05, 2017
 Frequency Range: Above 1GHz Temperature : 28°C
 Test Result: PASS Humidity : 65 %
 Measured Distance: 3m Test By:

| Freq. (MHz) | Ant.Pol. H/V | Emission Level(dBuV) | | Limit 3m(dBuV/m) | | Over(dB) | |
|----------------|-----------------|----------------------|-------|------------------|----|----------|--------|
| | | PK | AV | PK | AV | PK | AV |
| 4950.17 | V | 60.33 | 41.11 | 74 | 54 | -13.67 | -12.89 |
| 7420.21 | V | 59.76 | 40.87 | 74 | 54 | -14.24 | -13.13 |
| 8220.67 | V | 58.27 | 40.01 | 74 | 54 | -15.73 | -13.99 |
| 4960.59 | H | 59.30 | 40.30 | 74 | 54 | -14.70 | -13.70 |
| 7240.63 | H | 60.33 | 41.11 | 74 | 54 | -13.67 | -12.89 |

All emissions not reported were more than 20dB below the specified limit or in the noise floor.

- Note:**
- (1) All Readings are Peak Value and AV.
 - (2) Emission Level= Reading Level+Probe Factor +Cable Loss.
 - (3) Data of measurement within this frequency range shown "--" in the table above means the reading of emissions are attenuated more than 20dB below the permissible limits or the field strength is too small to be measured.

§15.247(a) (2) – 6dB BANDWIDTH TESTING

Test Equipment

Please refer to Section 4 this report.

Test Procedure

1. Set EUT in the transmitting mode.
2. Remove the antenna from the EUT and then connect a low loss RF cable from the antenna port to the spectrum analyzer.
3. Set the spectrum analyzer as RBW=100KHz,VBW ~~RBW~~, Span=3MHz,Sweep=auto.
4. Mark the peak frequency and -6dB(upper and lower)frequency.
5. Repeat until all the rest channels are investigated.

Note : The EUT was tested according to KDB 558074 for compliance to FCC 47CFR 15.247 requirements.

Environmental Conditions

| | |
|--------------------|----------|
| Temperature: | 26 °C |
| Relative Humidity: | 55% |
| ATM Pressure: | 100.0kPa |

Applicable Standard

Systems using digital modulation techniques may operate in the 902–928 MHz, 2400–2483.5 MHz, and 5725–5850 MHz bands. The minimum 6 dB bandwidth shall be at least 500 kHz.

Test Result: Pass.

Please refer to the following tables

| Channel Frequency (MHz) | Data Rate (Mbps) | 6dB Bandwidth (kHz) | Limit (kHz) | Ref. Plot |
|-------------------------|------------------|---------------------|-------------|-----------|
| 2402 | 1 | 697.11 | >500 | PLOT 1 |
| 2440 | 1 | 711.54 | >500 | PLOT 2 |
| 2480 | 1 | 701.923 | >500 | PLOT 3 |

Low Channel

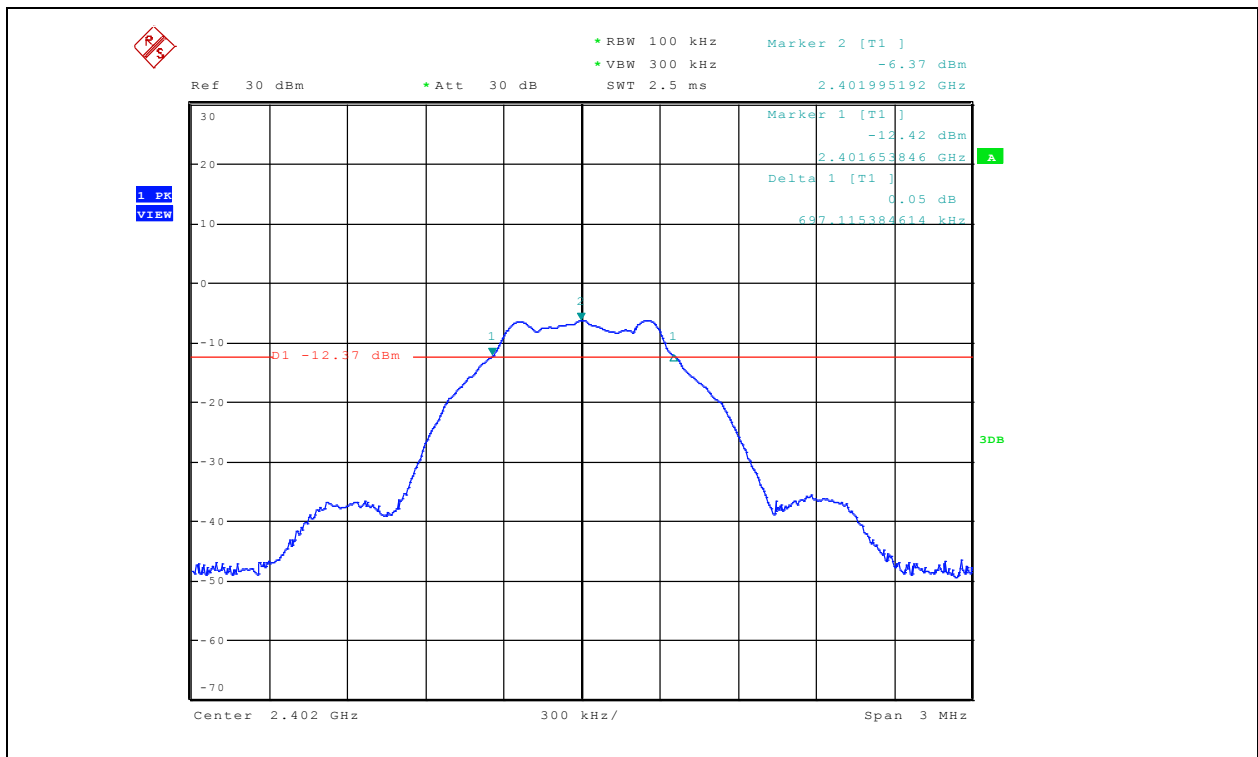

Middle channel

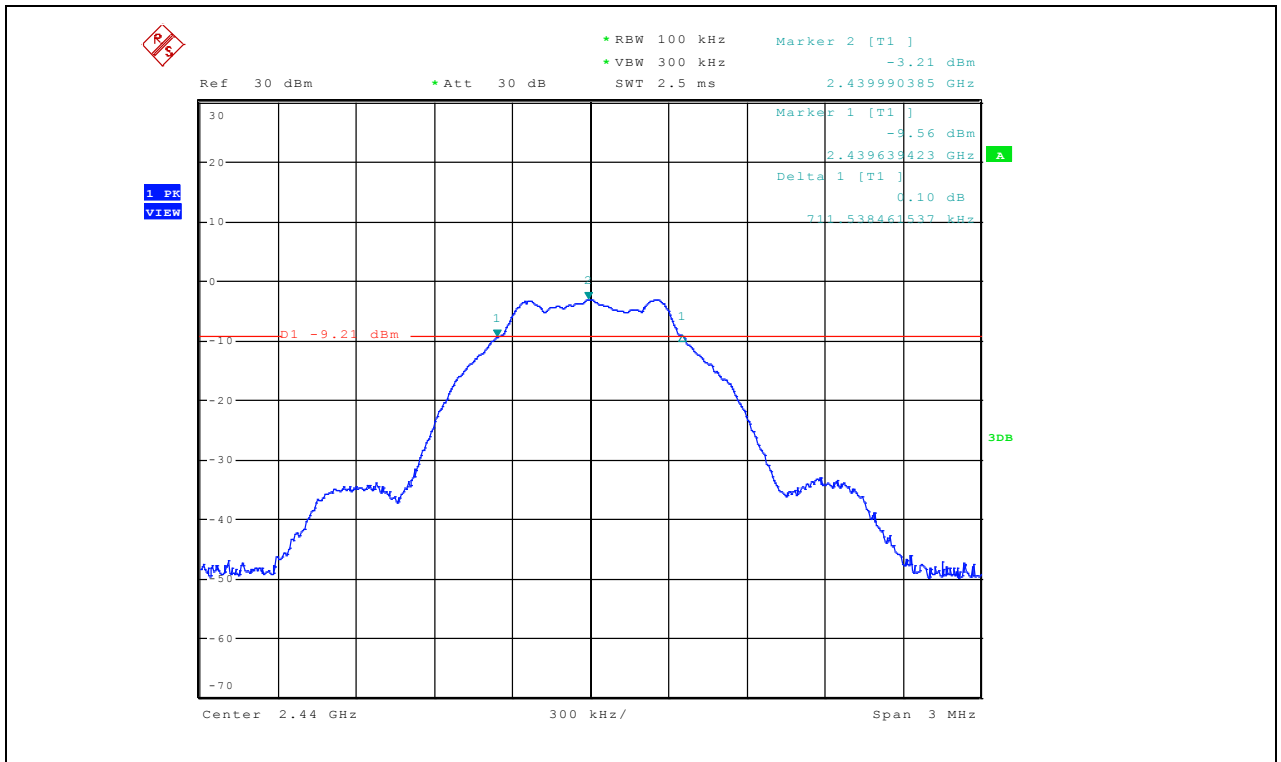

High Channel

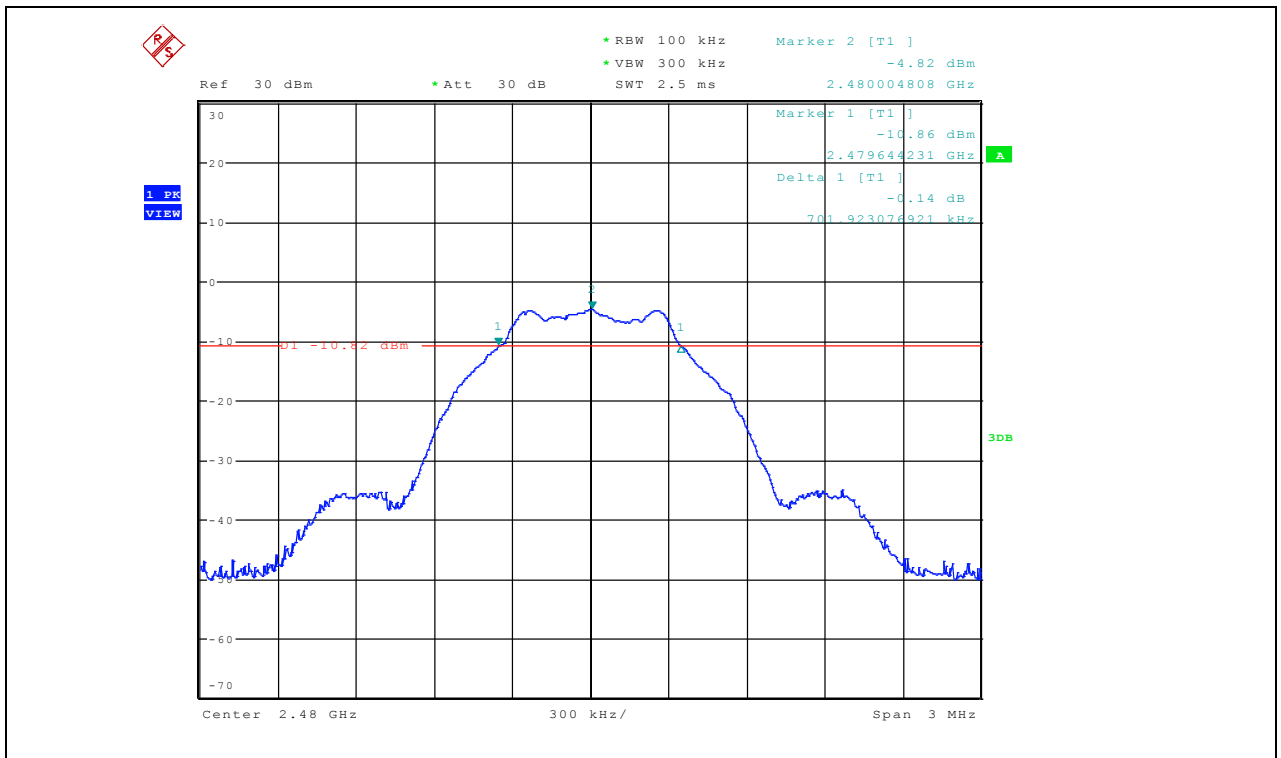

§15.247(b) (3) - MAXIMUM PEAK OUTPUT POWER

Test Equipment

Please refer to Section 4 this report.

Test Procedure

1. The EUT was directly connected to the spectrum analyzer and antenna output port as show in the block diagram below,
2. Set the EUT Work on the top, the middle and the bottom operation frequency individually.
3. Set the RBW =1MHz, VBW \geq 3RBW, span \geq 1.5*6dbbandwidth.
Sweep time = auto couple, Detector = peak, Trace mode = max hold.
4. Record the maximum power from the spectrum analyzer.
5. The maximum peak power shall be less 1 Watt (30dBm).

Note : The EUT was tested according to KDB 558074 for compliance to FCC 47CFR 15.247 requirements.

Environmental Conditions

| | |
|--------------------|----------|
| Temperature: | 26 °C |
| Relative Humidity: | 55% |
| ATM Pressure: | 100.0kPa |

Applicable Standard

According to §15.247(b) (3), for systems using digital modulation in the 902–928 MHz, 2400–2483.5 MHz, and 5725–5850 MHz bands: 1 Watt. As an alternative to a peak power measurement, compliance with the one Watt limit can be based on a measurement of the maximum conducted output power. Maximum Conducted Output Power is defined as the total transmit power delivered to all antennas and antenna elements averaged across all symbols in the signaling alphabet when the transmitter is operating at its maximum power control level. Power must be summed across all antennas and antenna elements. The average must not include any time intervals during which the transmitter is off or is transmitting at a reduced power level. If multiple modes of operation are possible (e.g., alternative modulation methods), the maximum conducted output power is the highest total transmit power occurring in any mode.

Test Result

| Channel | Frequency (MHz) | Data Rate (Mbps) | Conducted Power (dBm) | Limit (dBm) |
|---------|-----------------|------------------|-----------------------|-------------|
| Low | 2402 | 1 | -5.36 | 30 |
| Middle | 2440 | 1 | -2.17 | 30 |
| High | 2480 | 1 | -3.95 | 30 |

Low channel

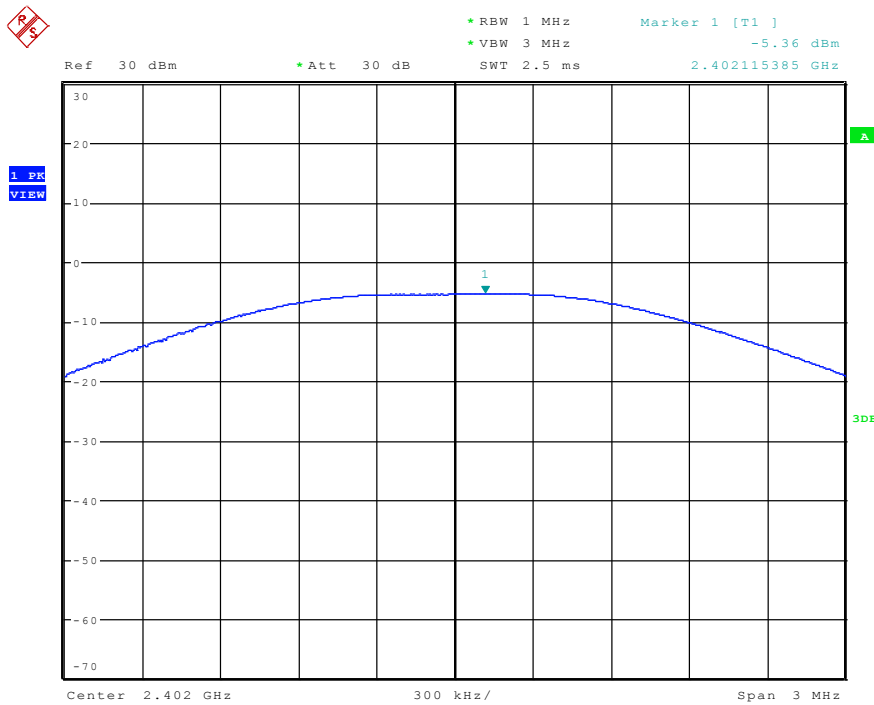

Middle channel

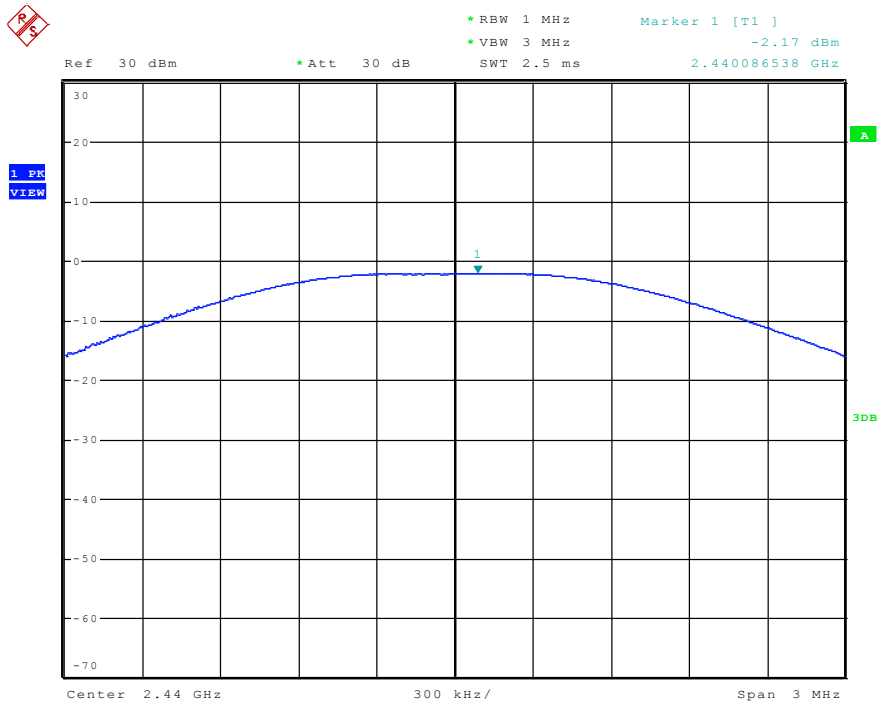

High channel

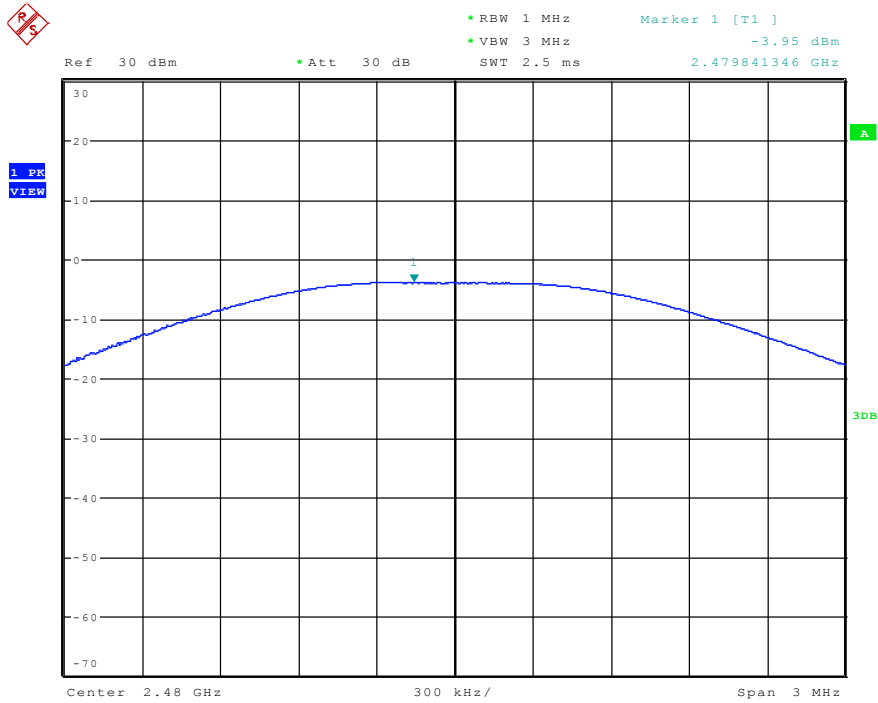

§15.247(d) – 100 kHz BANDWIDTH OF FREQUENCY BAND EDGE

Test Equipment

Please refer to Section 4 this report.

Test Procedure

The out of band emission tests were performed in the 3-meter chamber test site, using the setup accordance with the ANSI C63.4-2014. The specification used was the FCC Part Subpart C limits.

Environmental Conditions

| | |
|--------------------|----------|
| Temperature: | 26 °C |
| Relative Humidity: | 55% |
| ATM Pressure: | 100.0kPa |

Applicable Standard

In any 100 kHz bandwidth outside the frequency band in which the spread spectrum or digitally modulated intentional radiator is operating, the radio frequency power that is produced by the intentional radiator shall be at least 20 dB below that in the 100 kHz bandwidth within the band that contains the highest level of the desired power, based on either an RF conducted or a radiated measurement, provided the transmitter demonstrates compliance with the peak conducted power limits. If the transmitter complies with the conducted power limits based on the use of RMS averaging over a time interval, as permitted under paragraph (b)(3) of this section, the attenuation required under this paragraph shall be 30 dB instead of 20 dB. Attenuation below the general limits specified in §15.209(a) is not required. In addition, radiated emissions which fall in the restricted bands, as defined in §15.205(a), must also comply with the radiated emission limits specified in §15.209(a) (see §15.205(c)).

Test Result

PASS

Radiated measurement:

| Indicated | | result (PK/AV) | Table Angle Degree | Antenna | | Correction Factor | | | FCC Part 15.247 | | |
|------------------------|---------------------------------------|-------------------|--------------------------|---------------|----------------|--------------------------|-----------------------|--------------------------|---------------------------------|-------------------------|----------------|
| Frequency (MHz) | Receiver Reading (dB μ V/m) | | | Height (m) | Polar (H/V) | Ant. Factor (dB/m) | Cable Loss (dB) | Pre-Amp. Gain (dB) | Cord. Amp. (dB μ V/m) | Limit (dB μ V/m) | Margin (dB) |
| Low Channel (2402MHz) | | | | | | | | | | | |
| 2390 | 40.12 | AV | 225 | 1.5 | V | 30.3 | 4.1 | 33.1 | 41.42 | 54 | 12.58 |
| 2390 | 41.84 | AV | 90 | 2 | H | 30.3 | 4.1 | 33.1 | 40.54 | 54 | 10.86 |
| 2390 | 61.17 | PK | 180 | 1.5 | V | 30.3 | 4.1 | 33.1 | 41.42 | 74 | 11.53 |
| 2390 | 61.87 | PK | 270 | 2 | H | 30.3 | 4.1 | 33.1 | 63.17 | 74 | 10.83 |
| High Channel (2480MHz) | | | | | | | | | | | |
| 2483.5 | 41.03 | AV | 360 | 1 | V | 31 | 4.4 | 32.7 | 43.73 | 54 | 10.27 |
| 2483.5 | 41.23 | AV | 90 | 2 | H | 31 | 4.4 | 32.7 | 43.93 | 54 | 10.07 |
| 2483.5 | 60.47 | PK | 180 | 1 | V | 31 | 4.4 | 32.7 | 63.17 | 74 | 10.83 |
| 2483.5 | 60.73 | PK | 225 | 2 | H | 31 | 4.4 | 32.7 | 63.43 | 74 | 10.57 |

Conducted Emission Measurement:

Low channel

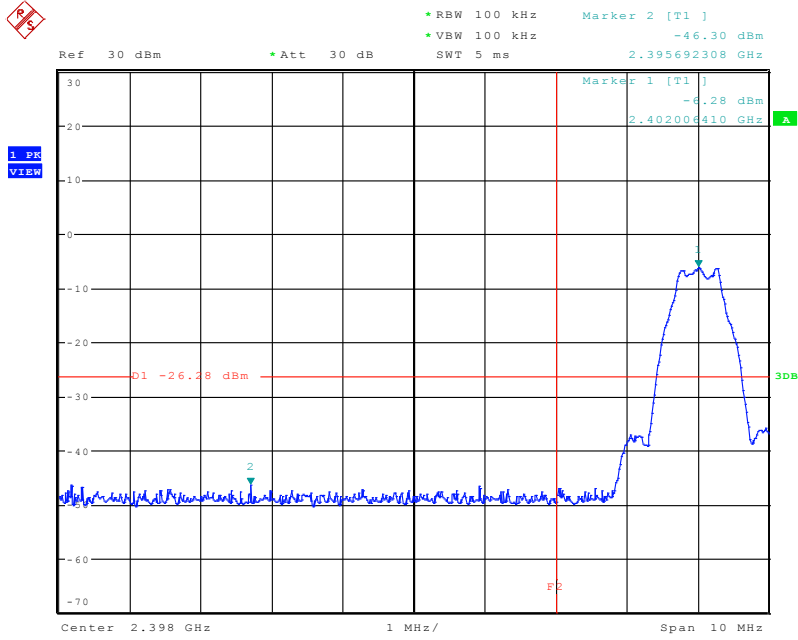

Date: 10.JAN.2017 18:43:07

High channel

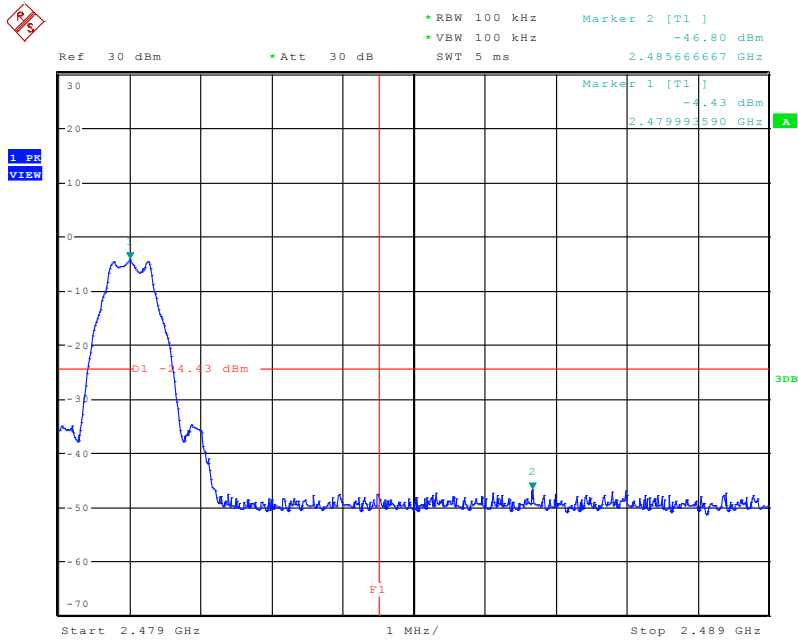

Date: 10.JAN.2017 18:45:00

Conducted spurious emissions

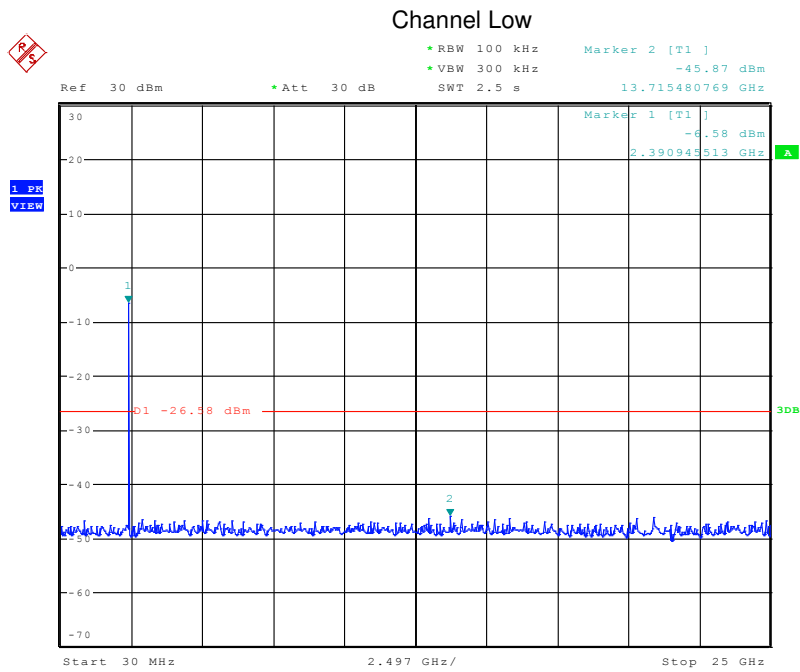

Date: 10.JAN.2017 18:46:09

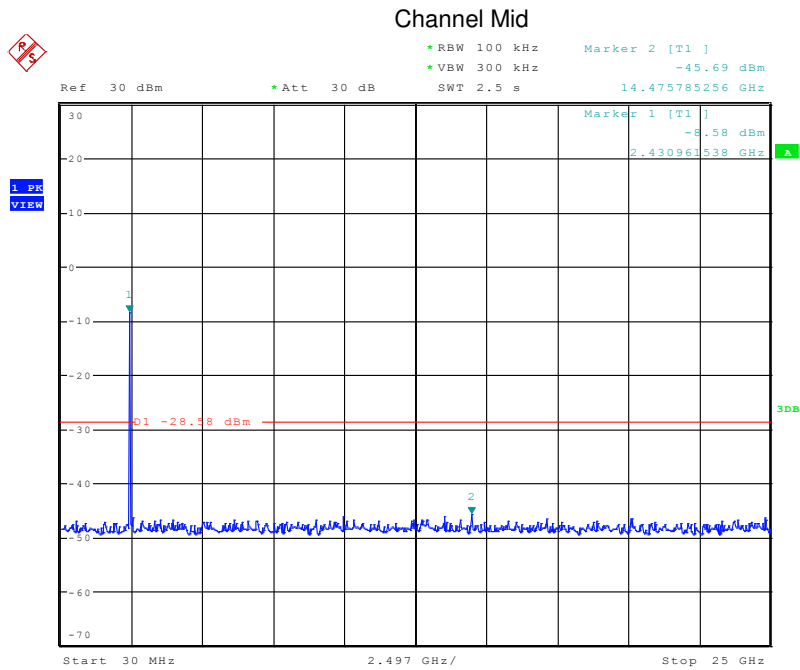

Date: 10.JAN.2017 18:47:10

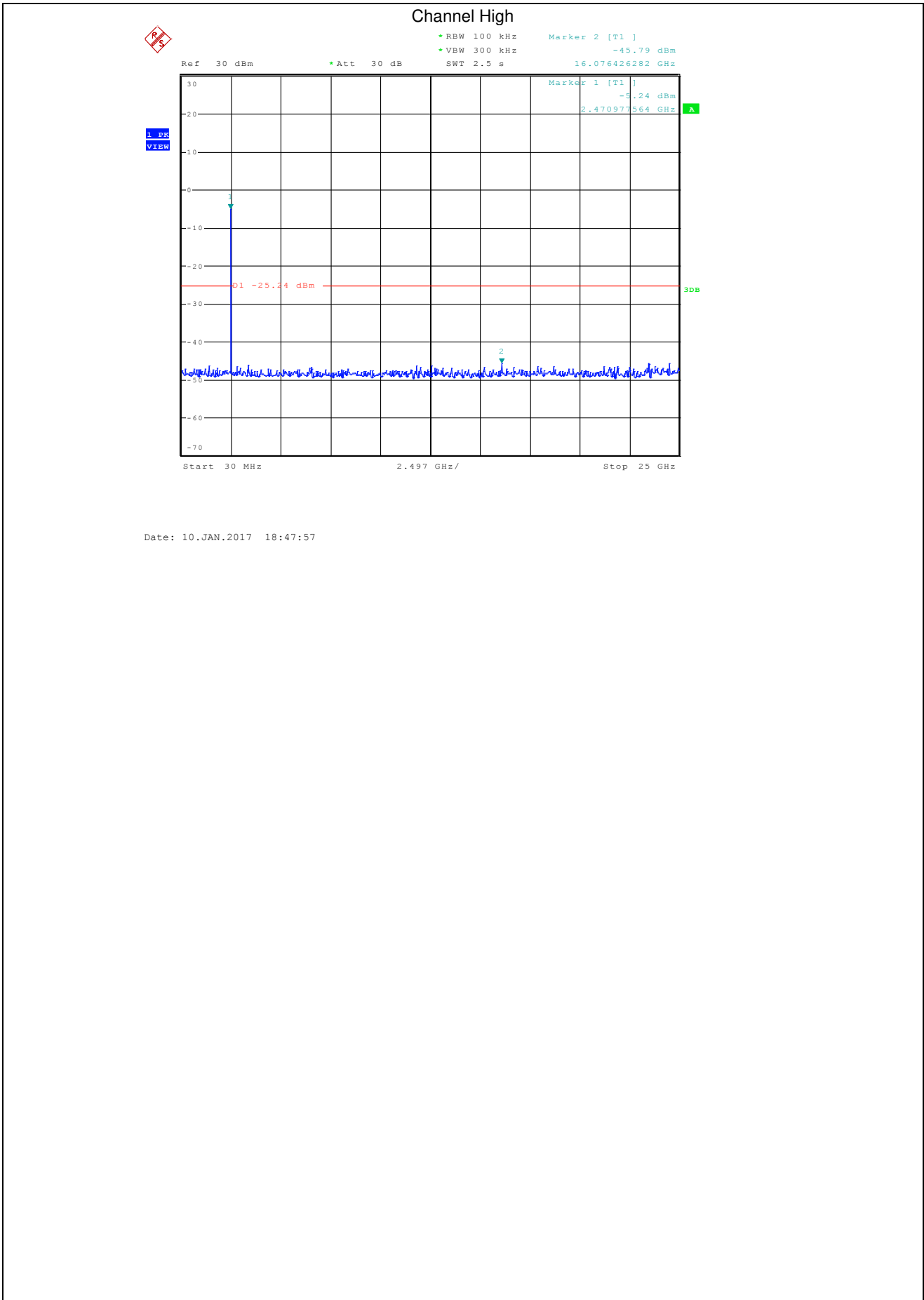

§15.247(e) -MAXIMUM CONDUCTED POWER SPECTRAL DENSITY

Test Equipment

Please refer to Section 4 this report.

Test Procedure

- 1, This procedure shall be used if maximum peak conducted output power was used to demonstrate compliance, and is optional if the maximum conducted (average) output power was used to demonstrate compliance.
- 2, Set analyzer center frequency to DTS channel center frequency.
- 3, Set the RBW to:3 kHz \cong RBW \cong 100 kHz, Set the VBW \cong 3 RBW, Detector = peak. Sweep time = auto couple
- 4, Trace mode = max hold, Allow trace to fully stabilize.

Note : The EUT was tested according to KDB 558074 for compliance to FCC 47CFR 15.247 requirements.

Environmental Conditions

| | |
|--------------------|----------|
| Temperature: | 25 °C |
| Relative Humidity: | 55% |
| ATM Pressure: | 100.0kPa |

Applicable Standard

For digitally modulated systems, the power spectral density conducted from the intentional radiator to the antenna shall not be greater than 8 dBm in any 3 kHz band during any time interval of continuous transmission. This power spectral density shall be determined in accordance with the provisions of paragraph (b) of this section. The same method of determining the conducted output power shall be used to determine the power spectral density.

Test Result

PASS

| Channel Frequency (MHz) | Data Rate (Mbps) | PSD (dBm/3kHz) | Limit (dBm/3kHz) | RESULT |
|-------------------------|------------------|----------------|------------------|-----------|
| 2402 | 1 | -22.35 | 8 | Compliant |
| 2440 | 1 | -21.27 | 8 | Compliant |
| 2480 | 1 | -19.65 | 8 | Compliant |

Low Channel

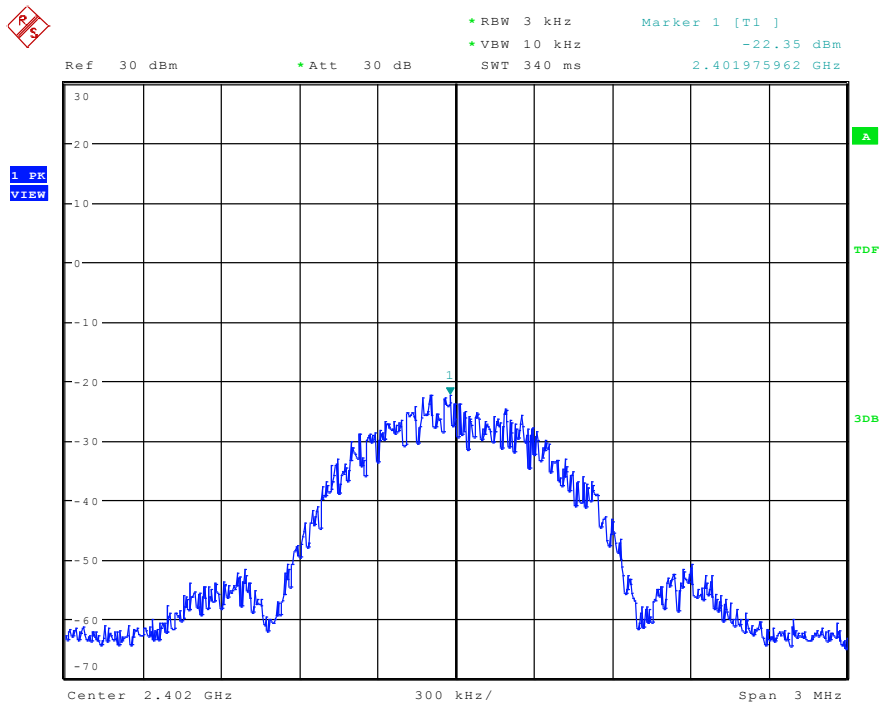

Middle Channel

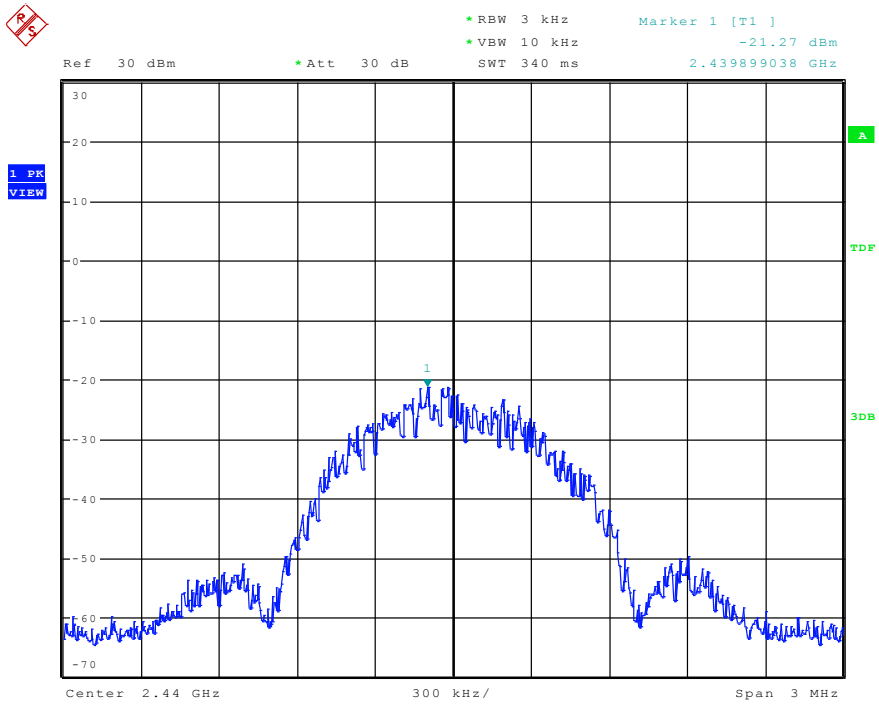

High Channel

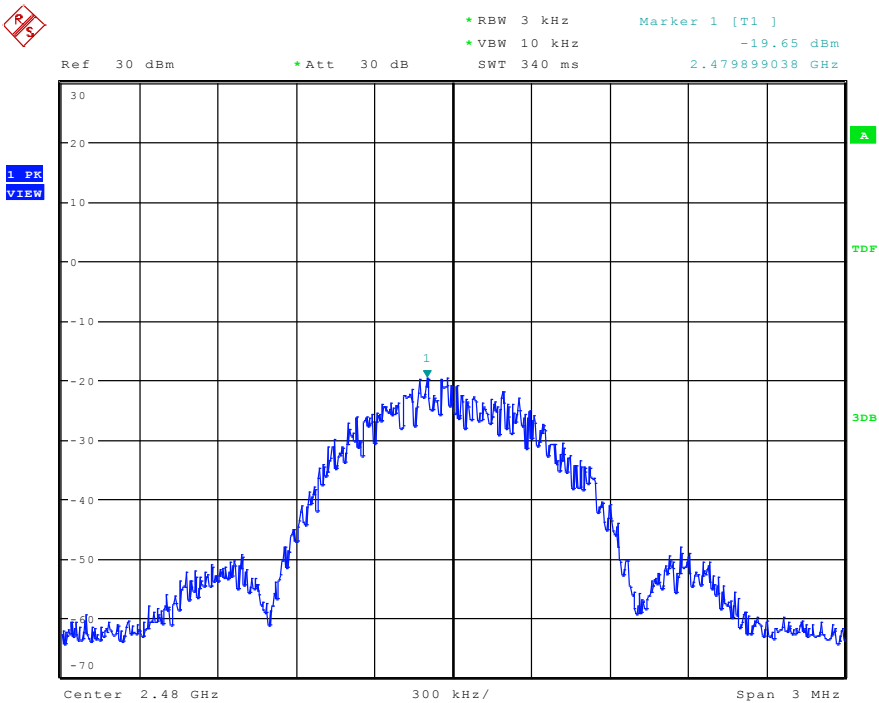

PHOTOGRAPHS OF THE TEST CONFIGURATION

CONDUCTED EMISSION TEST



RADIATED EMISSION TEST

(Frequency from 30MHz to 1GHz)

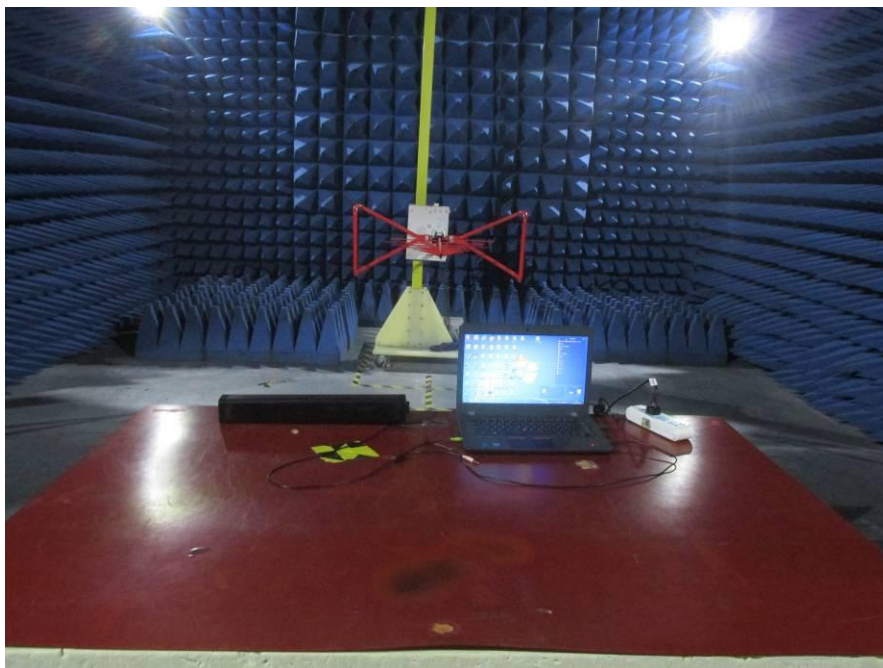

RADIATED EMISSION TEST
(Frequency above 1GHz)



PHOTOGRAPHS OF EUT (SR110)

Appearance photograph of EUT



Appearance photograph of EUT



Appearance photograph of EUT



Appearance photograph of EUT



Appearance photograph of EUT

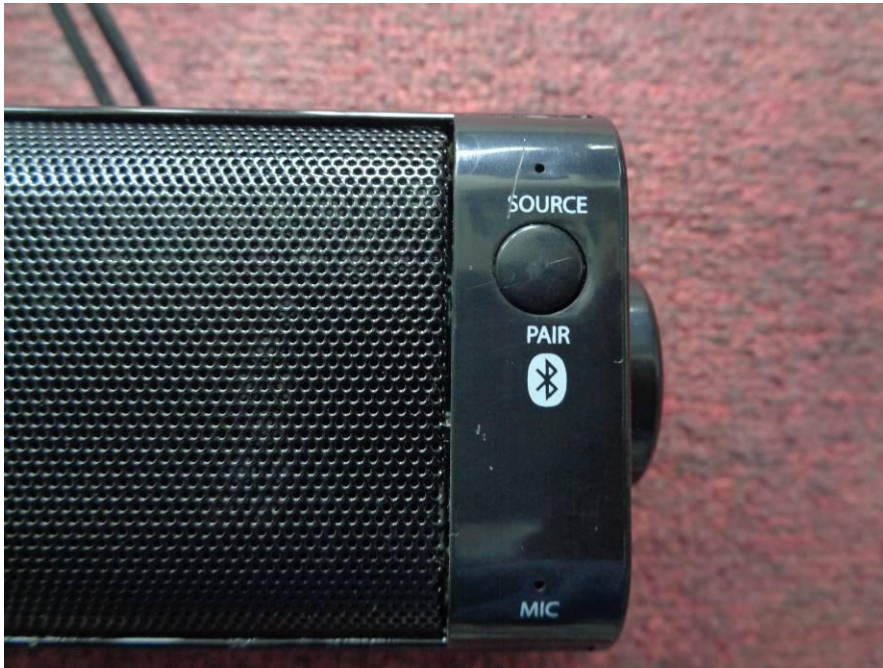

Internal photograph of EUT



Internal photograph of EUT

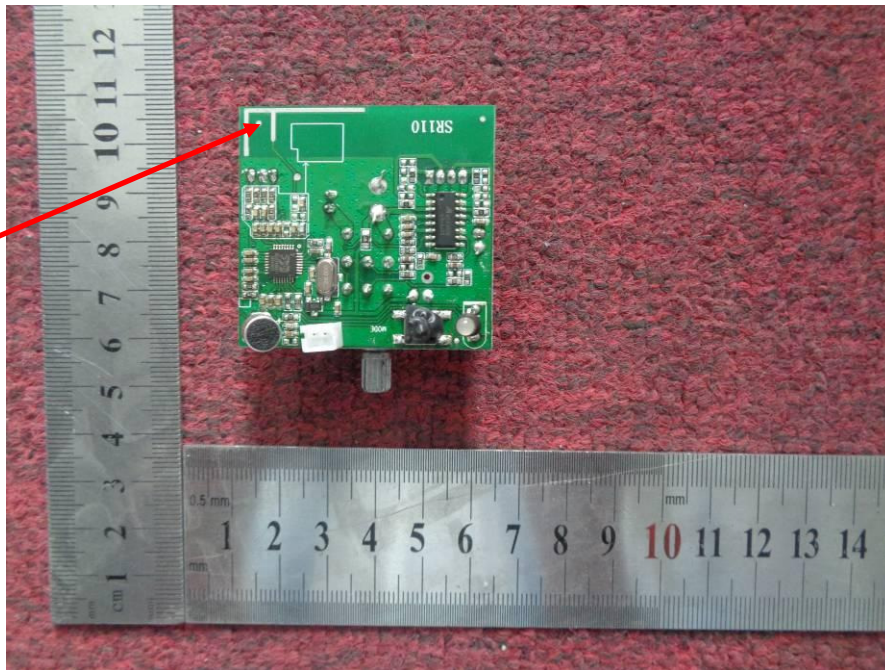

BT Antenna

Internal photograph of EUT

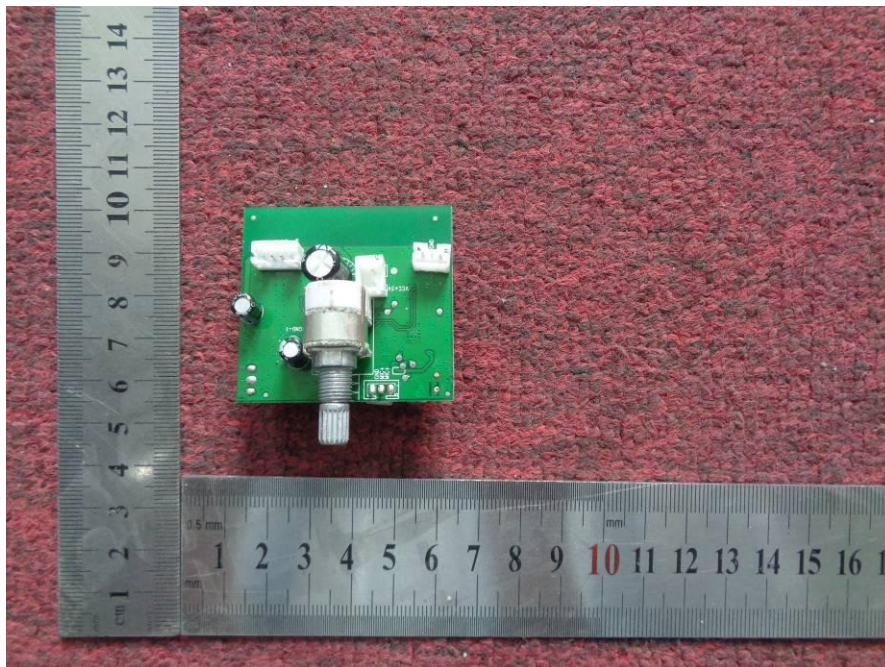

PHOTOGRAPHS OF EUT(SR212)

Appearance photograph of EUT



Appearance photograph of EUT

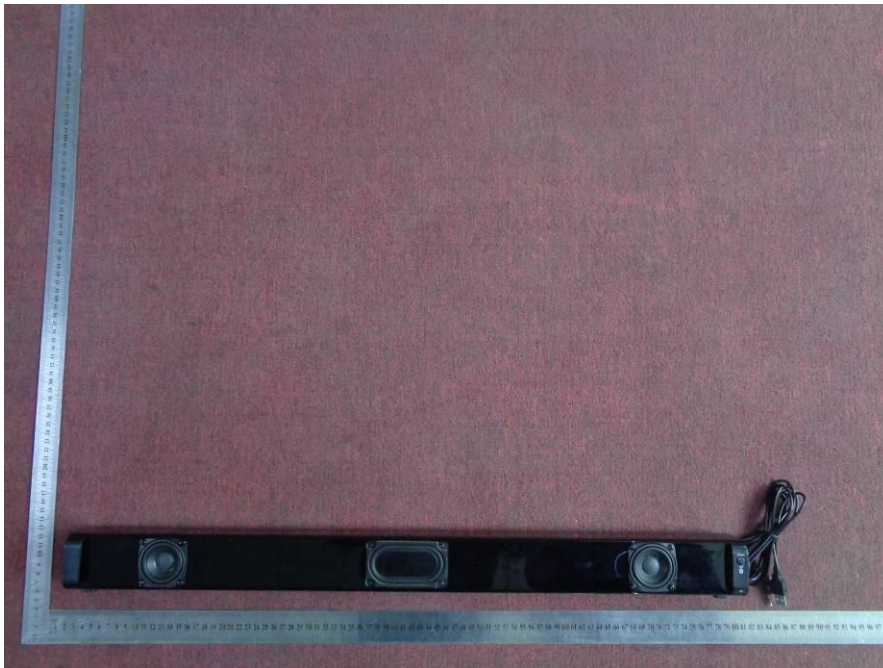

Appearance photograph of EUT



Appearance photograph of EUT



Appearance photograph of EUT



Appearance photograph of EUT

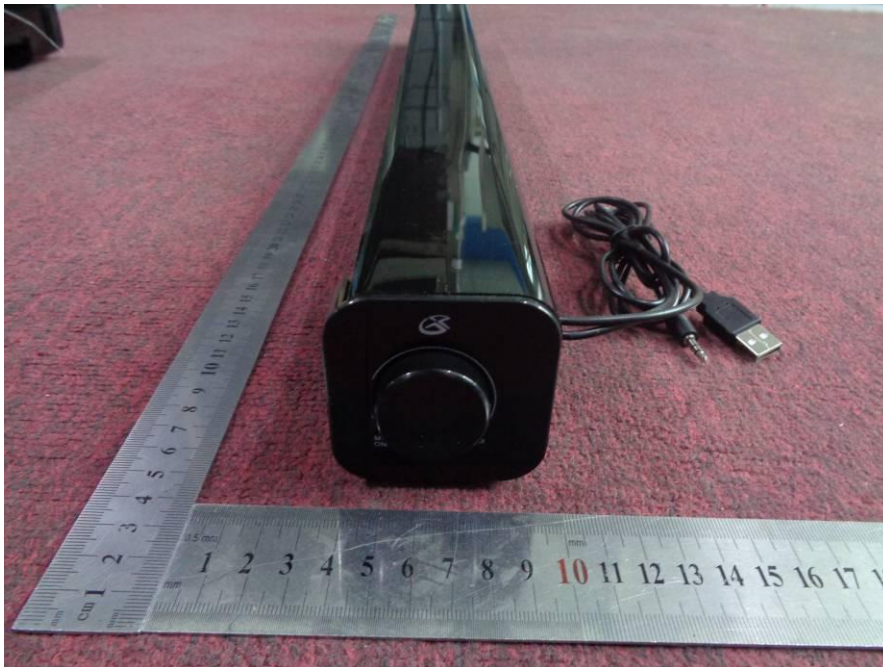

Appearance photograph of EUT

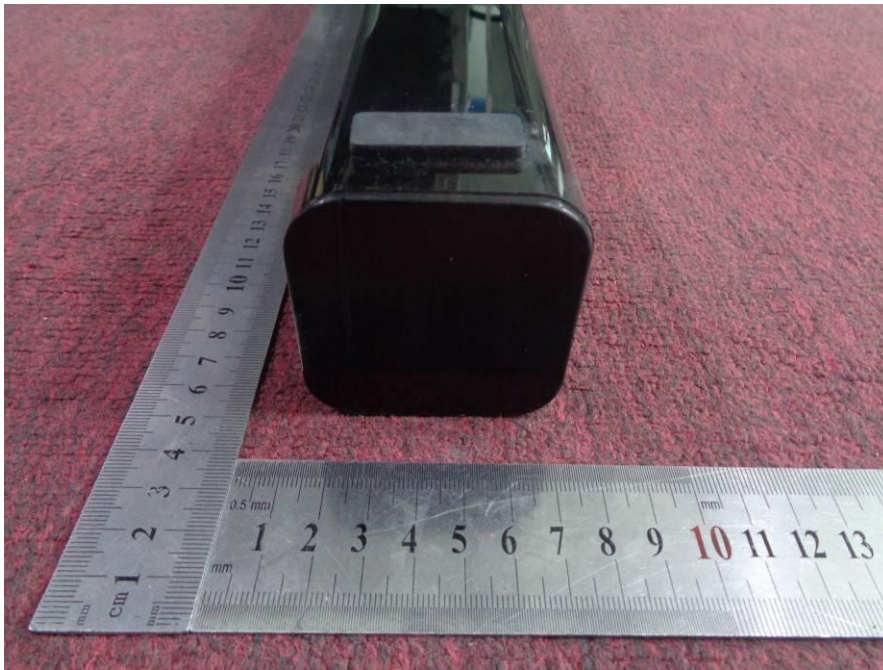

Internal photograph of EUT

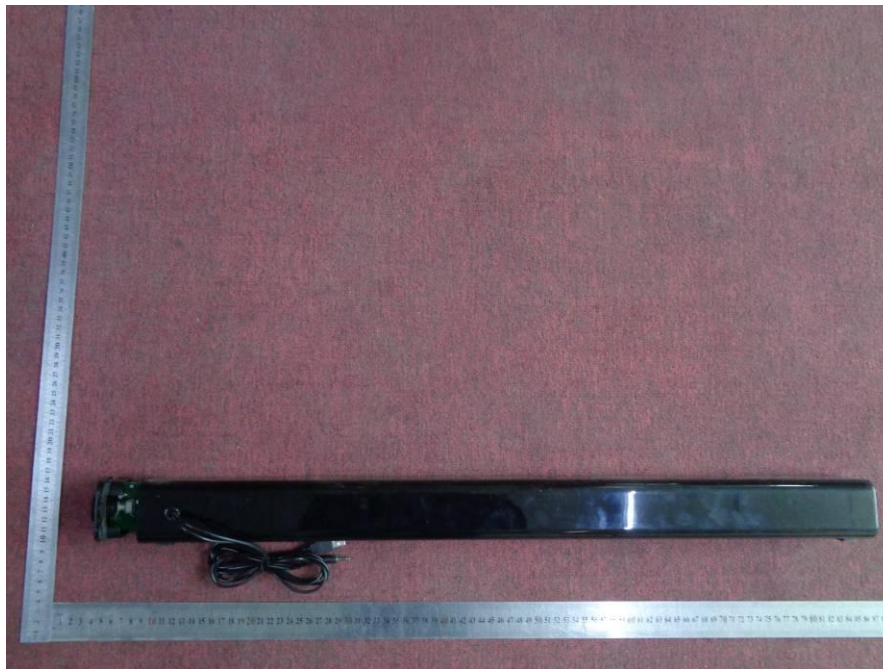

Internal photograph of EUT

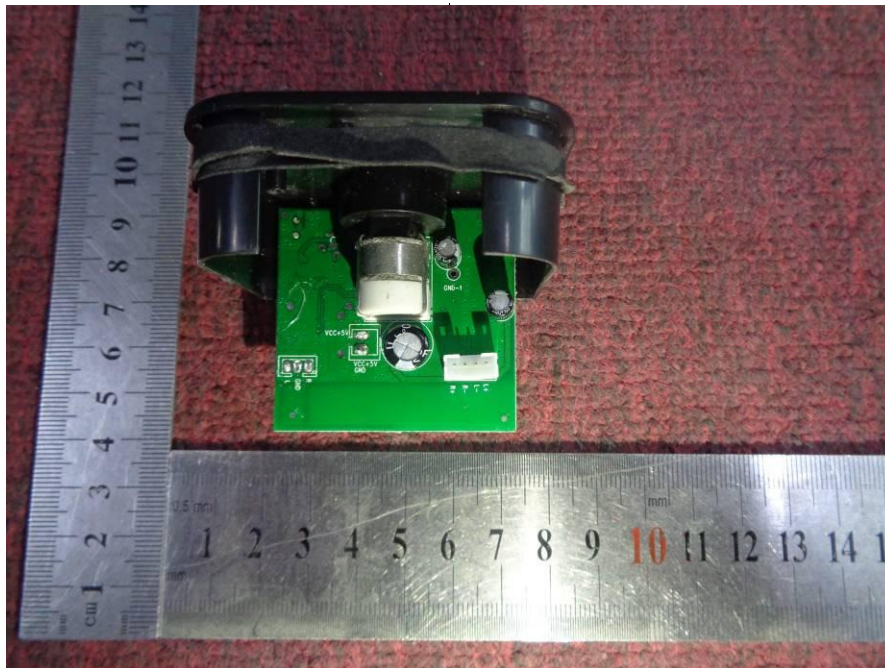

Internal photograph of EUT

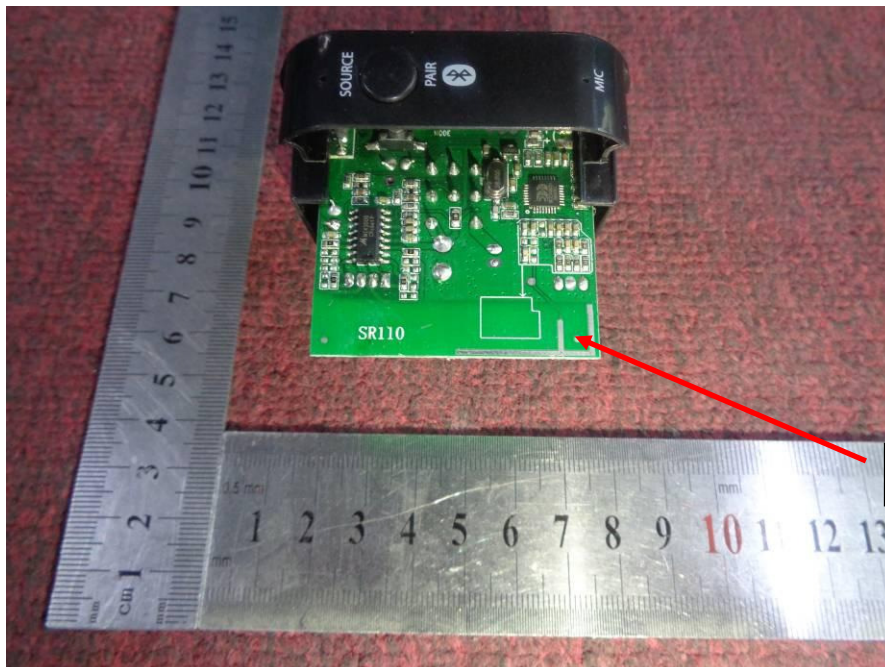

BT Antenna

Internal photograph of EUT



Internal photograph of EUT



---END OF REPORT---