



A D T

SAR TEST REPORT

REPORT NO.: SA110505C11

MODEL NO.: N905

FCC ID: ZJLKOBON905

IC ID: 8912A-KOBON905

RECEIVED: May 05, 2011

TESTED: May 19, 2011

ISSUED: May 23, 2011

APPLICANT: Kobo Inc.

ADDRESS: 135 Liberty St. Suite 101, Toronto, Ontario,
Canada, M6K1A7

ISSUED BY: Bureau Veritas Consumer Products Services
(H.K.) Ltd., Taoyuan Branch

LAB ADDRESS: No. 47, 14th Ling, Chia Pau Tsuen, Lin Kou
Hsiang, Taipei Hsien 244, Taiwan, R.O.C.

TEST LOCATION: No. 19, Hwa Ya 2nd Rd, Wen Hwa Tsuen, Kwei
Shan Hsiang, Taoyuan Hsien 333, Taiwan, R.O.C.

This test report consists of 27 pages in total except Appendix. It may be duplicated completely for legal use with the approval of the applicant. It should not be reproduced except in full, without the written approval of our laboratory. The client should not use it to claim product certification, approval, or endorsement by TAF or any government agency. The test results in the report only apply to the tested sample.





TABLE OF CONTENTS

RELEASE CONTROL RECORD.....	3
1. CERTIFICATION	4
2. GENERAL INFORMATION	5
2.1 GENERAL DESCRIPTION OF EUT.....	5
2.2 GENERAL DESCRIPTION OF APPLIED STANDARDS.....	6
2.3 GENERAL INFORMATION OF THE SAR SYSTEM	7
2.4 TEST EQUIPMENT	10
2.5 GENERAL DESCRIPTION OF THE SPATIAL PEAK SAR EVALUATION	11
2.6 DESCRIPTION OF SUPPORT UNITS.....	14
3. DESCRIPTION OF ANTENNA LOCATION	15
4. RECIPES FOR TISSUE SIMULATING LIQUIDS	16
5. SYSTEM VALIDATION.....	19
5.1 TEST PROCEDURE	19
5.2 VALIDATION RESULTS	20
5.3 SYSTEM VALIDATION UNCERTAINTIES	21
6. TEST RESULTS	22
6.1 TEST PROCEDURES.....	22
6.2 CONDUCTED POWER.....	24
6.3 DESCRIPTION OF TEST CONDITION.....	24
6.4 MEASURED SAR RESULT.....	25
6.5 POWER DRIFT TABLE	26
6.6 SAR LIMITS	26
7. INFORMATION ON THE TESTING LABORATORIES.....	27
APPENDIX A: TEST CONFIGURATIONS AND TEST DATA	
APPENDIX B: ADT SAR MEASUREMENT SYSTEM	
APPENDIX C: PHOTOGRAPHS OF SYSTEM VALIDATION	
APPENDIX D: SYSTEM CERTIFICATE & CALIBRATION	



A D T

RELEASE CONTROL RECORD

ISSUE NO.	REASON FOR CHANGE	DATE ISSUED
Original release	NA	May 23, 2011



A D T

1. CERTIFICATION

PRODUCT: eReader

MODEL: N905

BRAND: kobo

APPLICANT: Kobo Inc.

TESTED: May 19, 2011

TEST SAMPLE: ENGINEERING SAMPLE

STANDARDS: FCC Part 2 (Section 2.1093)

FCC OET Bulletin 65, Supplement C (01-01)

RSS-102 Issue 4 (2010-03)

The above equipment (model: N905) has been tested by **Bureau Veritas Consumer Products Services (H.K.) Ltd., Taoyuan Branch**, and found compliance with the requirement of the above standards. The test record, data evaluation & Equipment Under Test (EUT) configurations represented herein are true and accurate accounts of the measurements of the sample's EMC characteristics under the conditions specified in this report.

PREPARED BY :  , DATE : May 23, 2011
Polly Chien / Specialist

APPROVED BY :  , DATE : May 23, 2011
Gary Chang / Assistant Manager



A D T

2. GENERAL INFORMATION

2.1 GENERAL DESCRIPTION OF EUT

EUT	eReader
MODEL NO.	N905
FCC ID	ZJLKOBON905
IC ID	8912A-KOBON905
POWER SUPPLY	5Vdc (host equipment) 3.7Vdc (battery)
MODULATION TYPE	CCK, DQPSK, DBPSK for DSSS 64QAM, 16QAM, QPSK, BPSK for OFDM
MODULATION TECHNOLOGY	DSSS, OFDM
TRANSFER RATE	802.11b:11.0/ 5.5/ 2.0/ 1.0Mbps 802.11g: 54.0/ 48.0/ 36.0/ 24.0/ 18.0/ 12.0/ 9.0/ 6.0Mbps 802.11n (20MHz): up to 150.0Mbps
OPERATING FREQUENCY	2412 ~ 2462MHz
NUMBER OF CHANNEL	11 for 802.11b, 802.11g, 802.11n (20MHz)
MAXIMUM SAR (1g)	0.456W/kg
ANTENNA TYPE	Printed antenna on with 3dBi gain
ANTENNA CONNECTOR	NA
DATA CABLE	0.8m shielded USB cable without core
I/O PORTS	Refer to users' manual
ACCESSORY DEVICES	Battery

NOTE:

1. The EUT provides one completed transmitter and one receiver.

MODULATION MODE	TX FUNCTION
802.11b	1TX
802.11g	1TX
802.11n (20MHz)	1TX

2. The above EUT information is declared by manufacturer and for more detailed features description, please refer to the manufacturer's specifications or user's manual.



A D T

2.2 GENERAL DESCRIPTION OF APPLIED STANDARDS

According to the specifications of the manufacturer, this product must comply with the requirements of the following standards:

FCC Part 2 (2.1093)

FCC OET Bulletin 65, Supplement C (01- 01)

RSS-102 Issue 4 (2010-03)

IEEE 1528-2003

All test items have been performed and recorded as per the above standards.



2.3 GENERAL INFORMATION OF THE SAR SYSTEM

DASY52 (Version 52.6) consists of high precision robot, probe alignment sensor, phantom, robot controller, controlled measurement server and near-field probe. The robot includes six axes that can move to the precision position of the DASY52 software defined. The DASY52 software can define the area that is detected by the probe. The robot is connected to controlled box. Controlled measurement server is connected to the controlled robot box. The DAE includes amplifier, signal multiplexing, AD converter, offset measurement and surface detection. It is connected to the Electro-optical coupler (ECO). The ECO performs the conversion from the optical into digital electric signal of the DAE and transfers data to the PC.

EX3DV4 ISOTROPIC E-FIELD PROBE

CONSTRUCTION	Symmetrical design with triangular core Built-in shielding against static charges PEEK enclosure material (resistant to organic solvents, e.g., DGBE)
FREQUENCY	10 MHz to > 6 GHz Linearity: ± 0.2 dB (30 MHz to 6 GHz)
DIRECTIVITY	± 0.3 dB in HSL (rotation around probe axis) ± 0.5 dB in tissue material (rotation normal to probe axis)
DYNAMIC RANGE	10 μ W/g to > 100 mW/g Linearity: ± 0.2 dB (noise: typically < 1 μ W/g)
DIMENSIONS	Overall length: 330 mm (Tip: 20 mm) Tip diameter: 2.5 mm (Body: 12 mm) Typical distance from probe tip to dipole centers: 1 mm
APPLICATION	High precision dosimetric measurements in any exposure scenario (e.g., very strong gradient fields). Only probe which enables compliance testing for frequencies up to 6 GHz with precision of better 30%.

NOTE

1. The Probe parameters have been calibrated by the SPEAG. Please reference "APPENDIX D" for the Calibration Certification Report.
2. For frequencies above 800MHz, calibration in a rectangular wave-guide is used, because wave-guide size is manageable.
3. For frequencies below 800MHz, temperature transfer calibration is used because the wave-guide size becomes relatively large.



TWIN SAM V4.0

CONSTRUCTION The shell corresponds to the specifications of the Specific Anthropomorphic Mannequin (SAM) phantom defined in IEEE 1528-2003, EN 62209-1 and IEC 62209. It enables the dosimetric evaluation of left and right hand phone usage as well as body mounted usage at the flat phantom region. A cover prevents evaporation of the liquid. Reference markings on the phantom allow the complete setup of all predefined phantom positions and measurement grids by manually teaching three points with the robot.

SHELL THICKNESS 2 ± 0.2mm

FILLING VOLUME Approx. 25liters

DIMENSIONS Height: 810mm; Length: 1000mm; Width: 500mm

SYSTEM VALIDATION KITS:

CONSTRUCTION Symmetrical dipole with 1/4 balun enables measurement of feedpoint impedance with NWA matched for use near flat phantoms filled with brain simulating solutions. Includes distance holder and tripod adaptor

CALIBRATION Calibrated SAR value for specified position and input power at the flat phantom in brain simulating solutions

FREQUENCY 2450MHz

RETURN LOSS > 20dB at specified validation position

POWER CAPABILITY > 100W (f < 1GHz); > 40W (f > 1GHz)

OPTIONS Dipoles for other frequencies or solutions and other calibration conditions upon request



DEVICE HOLDER FOR SAM TWIN PHANTOM

CONSTRUCTION

The device holder for the mobile phone device is designed to cope with different positions given in the standard. It has two scales for the device rotation (with respect to the body axis) and the device inclination (with respect to the line between the ear reference points). The rotation centers for both scales is the ear reference point (ERP). Thus the device needs no repositioning when changing the angles. The holder has been made out of low-loss POM material having the following dielectric parameters: relative permittivity $\varepsilon = 3$ and loss tangent $\delta = 0.02$. The amount of dielectric material has been reduced in the closest vicinity of the device, since measurements have suggested that the influence of the clamp on the test results could thus be lowered. The device holder for the portable device makes up of the polyethylene foam. The dielectric parameters of material close to the dielectric parameters of the air.

DATA ACQUISITION ELECTRONICS

CONSTRUCTION

The data acquisition electronics (DAE3) consists of a highly sensitive electrometer grade preamplifier with auto-zeroing, a channel and gain-switching multiplex, a fast 16 bit AD converter and a command decoder and control logic unit. Transmission to the measurement server is accomplished through an optical downlink for data and status information as well as an optical uplink for commands and the clock. The mechanical probe is mounting device includes two different sensor systems for frontal and sideways probe contacts. They are used for mechanical surface detection and probe collision detection. The input impedance of the DAE3 box is 200M Ω ; the inputs are symmetrical and floating. Common mode rejection is above 80 dB.



A D T

2.4 TEST EQUIPMENT

FOR SAR MEASUREMENT

ITEM	NAME	BRAND	TYPE	SERIES NO.	DATE OF CALIBRATION	DUE DATE OF CALIBRATION
1	ELI 4.0 Phantom	S & P	QDOVA001 BA	1043	NA	NA
2	Signal Generator	Anritsu	68247B	984703	May 31, 2010	May 30, 2011
3	E-Field Probe	S & P	EX3DV4	3650	Jan. 24, 2011	Jan. 23, 2012
4	DAE	S & P	DAE 3	510	Oct. 04, 2010	Oct. 03, 2011
5	Robot Positioner	Staubli Unimation	NA	NA	NA	NA
6	Validation Dipole	S & P	D2450V2	716	Jan. 26, 2011	Jan. 25, 2012

NOTE: Before starting the measurement, all test equipment shall be warmed up for 30min.

FOR TISSUE PROPERTY

ITEM	NAME	BRAND	TYPE	SERIES NO.	DATE OF CALIBRATION	DUE DATE OF CALIBRATION
1	Network Analyzer	Agilent	E8358A	US41480538	Dec. 30, 2010	Dec. 29, 2011
2	Dielectric Probe	Agilent	85070D	US01440176	NA	NA

NOTE:

1. Before starting, all test equipment shall be warmed up for 30min.
2. The tolerance ($k=1$) specified by Agilent for general dielectric measurements, deriving from inaccuracies in the calibration data, analyzer drift, and random errors, are usually $\pm 2.5\%$ and $\pm 5\%$ for measured permittivity and conductivity, respectively. However, the tolerances for the conductivity is smaller for material with large loss tangents, i.e., less than $\pm 2.5\%$ ($k=1$). It can be substantially smaller if more accurate methods are applied.

2.5 GENERAL DESCRIPTION OF THE SPATIAL PEAK SAR EVALUATION

The DASY52 post-processing software (SEMCAD) automatically executes the following procedures to calculate the field units from the micro-volt readings at the probe connector. The parameters used in the evaluation are stored in the configuration modules of the software:

Probe parameters:	- Sensitivity	Norm _i , a _{i0} , a _{i1} , a _{i2}
	- Conversion factor	ConvF _i
	- Diode compression point	dcp _i
Device parameters:	- Frequency	F
	- Crest factor	Cf
Media parameters:	- Conductivity	σ
	- Density	ρ

The first step of the evaluation is a linearization of the filtered input signal to account for the compression characteristics of the detector diode. The compensation depends on the input signal, the diode type and the DC-transmission factor from the diode to the evaluation electronics. If the exciting field is pulsed, the crest factor of the signal must be known to correctly compensate for peak power. The formula for each channel can be given as:

$$V_i = U_i + U_i^2 \cdot \frac{cf}{dcp_i}$$

V _i	=compensated signal of channel i	(i = x, y, z)
U _i	=input signal of channel i	(i = x, y, z)
Cf	=crest factor of exciting field	(DASY parameter)
dcp _i	=diode compression point	(DASY parameter)

From the compensated input signals the primary field data for each channel can be evaluated:

$$\text{E-field probes: } E_i = \sqrt{\frac{V_i}{\text{Norm}_i \cdot \text{ConvF}}}$$

$$\text{H-field probes: } H_i = \sqrt{V_i} \cdot \frac{a_{i0} + a_{i1}f + a_{i2}f^2}{f}$$

- V_i = compensated signal of channel I (i = x, y, z)
- Norm_i = sensor sensitivity of channel i $\mu\text{V}/(\text{V/m})^2$ for E-field Probes (i = x, y, z)
- ConvF = sensitivity enhancement in solution
- a_{ij} = sensor sensitivity factors for H-field probes
- F = carrier frequency [GHz]
- E_i = electric field strength of channel i in V/m
- H_i = magnetic field strength of channel i in A/m

The RSS value of the field components gives the total field strength (Hermitian magnitude):

$$E_{tot} = \sqrt{E_x^2 + E_y^2 + E_z^2}$$

The primary field data are used to calculate the derived field units.

$$SAR = E_{tot}^2 \cdot \frac{\sigma}{\rho \cdot 1'000}$$

- SAR = local specific absorption rate in mW/g
- E_{tot} = total field strength in V/m
- σ = conductivity in [mho/m] or [Siemens/m]
- ρ = equivalent tissue density in g/cm³



A D T

Note that the density is set to 1, to account for actual head tissue density rather than the density of the tissue simulating liquid. The entire evaluation of the spatial peak values is performed within the Post-processing engine (SEMCAD). The system always gives the maximum values for the 1g and 10g cubes. The algorithm to find the cube with highest averaged SAR is divided into the following stages:

1. The extraction of the measured data (grid and values) from the Zoom Scan
2. The calculation of the SAR value at every measurement point based on all stored data (A/D values and measurement parameters)
3. The generation of a high-resolution mesh within the measured volume
4. The interpolation of all measured values from the measurement grid to the high-resolution grid
5. The extrapolation of the entire 3-D field distribution to the phantom surface over the distance from sensor to surface
6. The calculation of the averaged SAR within masses of 1g and 10g.

The probe is calibrated at the center of the dipole sensors that is located 1 to 2.7mm away from the probe tip. During measurements, the probe stops shortly above the phantom surface, depending on the probe and the surface detecting system. Both distances are included as parameters in the probe configuration file. The software always knows exactly how far away the measured point is from the surface. As the probe cannot directly measure at the surface, the values between the deepest measured point and the surface must be extrapolated. The angle between the probe axis and the surface normal line is less than 30 degree.



The maximum search is automatically performed after each area scan measurement. It is based on splines in two or three dimensions. The procedure can find the maximum for most SAR distributions even with relatively large grid spacing. After the area scanning measurement, the probe is automatically moved to a position at the interpolated maximum. The following scan can directly use this position for reference, e.g., for a finer resolution grid or the cube evaluations. The 1g and 10g peak evaluations are only available for the predefined cube 7 x 7 x 7 scans. The routines are verified and optimized for the grid dimensions used in these cube measurements. The measured volume of 30 x 30 x 30mm contains about 30g of tissue. The first procedure is an extrapolation (incl. boundary correction) to get the points between the lowest measured plane and the surface. The next step uses 3D interpolation to get all points within the measured volume in a 1mm grid (42875 points). In the last step, a 1g cube is placed numerically into the volume and its averaged SAR is calculated. This cube is then moved around until the highest averaged SAR is found. If the highest SAR is found at the edge of the measured volume, the system will issue a warning: higher SAR values might be found outside of the measured volume. In that case the cube measurement can be repeated, using the new interpolated maximum as the center.

2.6 DESCRIPTION OF SUPPORT UNITS

The EUT has been tested as an independent unit.



3. DESCRIPTION OF ANTENNA LOCATION



WiFi Antenna

4. RECIPES FOR TISSUE SIMULATING LIQUIDS

For the measurement of the field distribution inside the SAM phantom, the phantom must be filled with 25 liters of tissue simulation liquid.

The following ingredients are used :

- **WATER-** Deionized water (pure H₂O), resistivity ≥ 16 M - as basis for the liquid
- **DGMBE-** Diethylenglycol-monobuthyl ether (DGMBE), Fluka Chemie GmbH, CAS # 112-34-5 - to reduce relative permittivity

THE RECIPES FOR 2450MHz SIMULATING LIQUID TABLE

INGREDIENT	BODY SIMULATING LIQUID 2450MHz (MSL-2450)
Water	69.83%
DGMBE	30.17%
Dielectric Parameters at 22 °C	$f = 2450\text{MHz}$ $\epsilon = 52.7 \pm 5\%$ $\sigma = 1.95 \pm 5\% \text{ S/m}$

Testing the liquids using the Agilent Network Analyzer E8358A and Agilent Dielectric Probe Kit 85070D. The testing procedure is following as

1. Turn Network Analyzer on and allow at least 30min. warm up.
2. Mount dielectric probe kit so that interconnecting cable to Network Analyzer will not be moved during measurements or calibration.
3. Pour de-ionized water and measure water temperature ($\pm 1^\circ$).
4. Set water temperature in Agilent-Software (Calibration Setup).
5. Perform calibration.
6. Validate calibration with dielectric material of known properties (e.g. polished ceramic slab with $>8\text{mm}$ thickness $\epsilon' = 10.0$, $\epsilon'' = 0.0$). If measured parameters do not fit within tolerance, repeat calibration (± 0.2 for ϵ' : ± 0.1 for ϵ'').
7. Conductivity can be calculated from ϵ'' by $\sigma = \omega \epsilon_0 \epsilon'' = \epsilon'' f [\text{GHz}] / 18$.
8. Measure liquid shortly after calibration. Repeat calibration every hour.
9. Stir the liquid to be measured. Take a sample ($\sim 50\text{ml}$) with a syringe from the center of the liquid container.
10. Pour the liquid into a small glass flask. Hold the syringe at the bottom of the flask to avoid air bubbles.
11. Put the dielectric probe in the glass flask. Check that there are no air bubbles in front of the opening in the dielectric probe kit.
12. Perform measurements.
13. Adjust medium parameters in DASY52 for the frequencies necessary for the measurements ('Setup Config', select medium and press 'Option'-button.)
14. Select the current medium for the frequency of the validation.



A D T

FOR SIMULATING LIQUID

LIQUID TYPE		MSL-2450			
SIMULATING LIQUID TEMP.		21.6			
TEST DATE		May 19, 2011			
TESTED BY		Morrison Huang			
FREQ. (MHz)	LIQUID PARAMETER	STANDARD VALUE	MEASUREMENT VALUE	ERROR PERCENTAGE (%)	LIMIT(%)
2412.0	Permittivity (ϵ)	52.75	54.06	2.48	±5
2437.0		52.72	53.94	2.31	
2450.0		52.70	53.86	2.20	
2412.0	Conductivity (σ) S/m	1.91	1.93	1.05	
2437.0		1.94	1.96	1.03	
2450.0		1.95	1.98	1.54	



5. SYSTEM VALIDATION

The system validation was performed in the flat phantom with equipment listed in the following table. Since the SAR value is calculated from the measured electric field, dielectric constant and conductivity of the body tissue and the SAR is proportional to the square of the electric field. So, the SAR value will be also proportional to the RF power input to the system validation dipole under the same test environment. In our system validation test, 250mW RF input power was used.

5.1 TEST PROCEDURE

Before the system performance check, we need only to tell the system which components (probe, medium, and device) are used for the system performance check; the system will take care of all parameters. The dipole must be placed beneath the flat section of the SAM Twin Phantom with the correct distance holder in place. The distance holder should touch the phantom surface with a light pressure at the reference marking (little cross) and be oriented parallel to the long side of the phantom. Accurate positioning is not necessary, since the system will search for the peak SAR location, except that the dipole arms should be parallel to the surface. The device holder for mobile phones can be left in place but should be rotated away from the dipole.

1. The "Power Reference Measurement" and "Power Drift Measurement" jobs are located at the beginning and end of the batch process. They measure the field drift at one single point in the liquid over the complete procedure. The indicated drift is mainly the variation of the amplifier output power. If it is too high (above ± 0.1 dB), the system performance check should be repeated; some amplifiers have very high drift during warm-up. A stable amplifier gives drift results in the DASY system below ± 0.02 dB.
2. The "Surface Check" job tests the optical surface detection system of the DASY system by repeatedly detecting the surface with the optical and mechanical surface detector and comparing the results. The output gives the detecting heights of both systems, the difference between the two systems and the standard deviation of the detection repeatability. Air bubbles or refraction in the liquid due to separation of the sugar-water mixture gives poor repeatability (above ± 0.1 mm). In that case it is better to abort the system performance check and stir the liquid.



- 3. The "Area Scan" job measures the SAR above the dipole on a plane parallel to the surface. It is used to locate the approximate location of the peak SAR. The proposed scan uses large grid spacing for faster measurement; due to the symmetric field, the peak detection is reliable. If a finer graphic is desired, the grid spacing can be reduced. Grid spacing and orientation have no influence on the SAR result.
- 4. The "Zoom Scan" job measures the field in a volume around the peak SAR value assessed in the previous "Area Scan" job (for more information see the application note on SAR evaluation).

About the validation dipole positioning uncertainty, the constant and low loss dielectric spacer is used to establish the correct distance between the top surface of the dipole and the bottom surface of the phantom, the error component introduced by the uncertainty of the distance between the liquid (i.e., phantom shell) and the validation dipole in the DASY52 system is less than ±0.1mm.

$$SAR_{tolerance} [\%] = 100 \times \left(\frac{(a + d)^2}{a^2} - 1 \right)$$

As the closest distance is 10mm, the resulting tolerance SAR_{tolerance}[%] is <2%.

5.2 VALIDATION RESULTS

SYSTEM VALIDATION TEST OF SIMULATING LIQUID					
FREQUENCY (MHz)	REQUIRED SAR (mW/g)	MEASURED SAR (mW/g)	DEVIATION (%)	SEPARATION DISTANCE	TESTED DATE
MSL2450	13.40 (1g)	13.90	3.73	10mm	May 19, 2011

NOTE: Please see Appendix for the photo of system validation test.

5.3 SYSTEM VALIDATION UNCERTAINTIES

In the table below, the system validation uncertainty with respect to the analytically assessed SAR value of a dipole source as given in the IEEE 1528 standard is given. This uncertainty is smaller than the expected uncertainty for mobile phone measurements due to the simplified setup and the symmetric field distribution.

Error Description	Tolerance (±%)	Probability Distribution	Divisor	(C _i)		Standard Uncertainty (±%)		(v _i)
				(1g)	(10g)	(1g)	(10g)	
Measurement System								
Probe Calibration	5.50	Normal	1	1	1	5.50	5.50	∞
Axial Isotropy	0.25	Rectangular	√3	0.7	0.7	0.10	0.10	∞
Hemispherical Isotropy	1.30	Rectangular	√3	0.7	0.7	0.53	0.53	∞
Boundary effects	1.00	Rectangular	√3	1	1	0.58	0.58	∞
Linearity	0.30	Rectangular	√3	1	1	0.17	0.17	∞
System Detection Limits	1.00	Rectangular	√3	1	1	0.58	0.58	∞
Readout Electronics	0.30	Normal	1	1	1	0.30	0.30	∞
Response Time	0.80	Rectangular	√3	1	1	0.46	0.46	∞
Integration Time	2.60	Rectangular	√3	1	1	1.50	1.50	∞
RF Ambient Noise	3.00	Rectangular	√3	1	1	1.73	1.73	9
RF Ambient Reflections	3.00	Rectangular	√3	1	1	1.73	1.73	9
Probe Positioner	0.40	Rectangular	√3	1	1	0.23	0.23	∞
Probe Positioning	2.90	Rectangular	√3	1	1	1.67	1.67	∞
Max. SAR Eval.	1.00	Rectangular	√3	1	1	0.58	0.58	∞
Test sample related								
Sample positioning	1.90	Normal	1	1	1	1.90	1.90	4
Device holder uncertainty	2.80	Normal	1	1	1	2.80	2.80	4
Output power variation-SAR drift measurement	4.50	Rectangular	√3	1	1	2.60	2.60	1
Dipole Related								
Dipole Axis to Liquid Distance	1.60	Rectangular	√3	1	1	0.92	0.92	4
Input Power Drift	0.46	Rectangular	√3	1	1	0.27	0.27	1
Phantom and Tissue parameters								
Phantom Uncertainty	4.00	Rectangular	√3	1	1	2.31	2.31	∞
Liquid Conductivity (target)	5.00	Rectangular	√3	0.64	0.43	1.85	1.24	∞
Liquid Conductivity (measurement)	1.54	Normal	1	0.64	0.43	0.99	0.66	9
Liquid Permittivity (target)	5.00	Rectangular	√3	0.6	0.49	1.73	1.41	∞
Liquid Permittivity (measurement)	2.48	Normal	1	0.6	0.49	1.49	1.22	9
Combined Standard Uncertainty						8.78	8.54	
Coverage Factor for 95%						Kp=2		
Expanded Uncertainty (K=2)						17.55	17.08	

NOTE: About the system validation uncertainty assessment, please reference the section 7.

6. TEST RESULTS

6.1 TEST PROCEDURES

Use the software to control the EUT channel and transmission power. Then record the conducted power before the testing. Place the EUT to the specific test location. After the testing, must writing down the conducted power of the EUT into the report. The SAR value was calculated via the 3D spline interpolation algorithm that has been implemented in the software of DASY52 SAR measurement system manufactured and calibrated by SPEAG. According to the IEEE 1528 standards, the recommended procedure for assessing the peak spatial-average SAR value consists of the following steps:

- Power reference measurement
- Verification of the power reference measurement
- Area scan
- Zoom scan
- Power reference measurement

The area scan was performed for the highest spatial SAR location. The zoom scan with 30mm x 30mm x 30mm volume was performed for SAR value averaged over 1g and 10g spatial volumes.

In the zoom scan, the distance between the measurement point at the probe sensor location (geometric center behind the probe tip) and the phantom surface is 2mm and maintained at a constant distance of $\pm 0.5\text{mm}$ during a zoom scan to determine peak SAR locations. The distance is 2mm between the first measurement point and the bottom surface of the phantom.

The measurement time is 0.5s at each point of the zoom scan. The probe boundary effect compensation shall be applied during the SAR test. Because of the tip of the probe to the Phantom surface separated distances are longer than half a tip probe diameter.

In the area scan, the separation distance is 2mm between the each measurement point and the phantom surface. The scan size shall be included the transmission portion of the EUT. The measurement time is the same as the zoom scan. At last the reference power drift shall be less than $\pm 5\%$.



A D T

6.2 CONDUCTED POWER

TEST MODE				802.11b	
CHAN.	FREQ. (MHz)	MODULATION TYPE	DATA RATE (Mbps)	AVG	PEAK
1	2412 (Low)	DBPSK	1	12.6	15.1
6	2437 (Mid.)	DBPSK	1	10.3	12.8
11	2462 (High)	DBPSK	1	10.1	12.6

TEST MODE				802.11g	
CHAN.	FREQ. (MHz)	MODULATION TYPE	DATA RATE (Mbps)	AVG	PEAK
1	2412 (Low)	BPSK	6	16.4	23.4
6	2437 (Mid.)	BPSK	6	17.0	24.7
11	2462 (High)	BPSK	6	16.5	23.7

TEST MODE				802.11n (20MHz)	
CHAN.	FREQ. (MHz)	MODULATION TYPE	DATA RATE (Mbps)	AVG	PEAK
1	2412 (Low)	BPSK	6.5	16.5	23.9
6	2437 (Mid.)	BPSK	6.5	17.1	24.3
11	2462 (High)	BPSK	6.5	16.6	23.8

6.3 DESCRIPTION OF TEST CONDITION

TEST DATE	TEMPERATURE(°C)		HUMIDITY(%RH)	TESTED BY
	AIRBENT	LIQUID		
May 19, 2011	22.8	21.6	57	Morrison Huang

6.4 MEASURED SAR RESULT

SAR (1g) (W/kg)			
Duty Cycle: 100%			
Distance between EUT and phantom is 5mm			
11b			
Chan.	Freq. (MHz)	Bottom	Top
1	2412 (Low)	0.128	0.118
11g			
6	2437 (Mid.)	0.391	0.342
802.11n (20MHz)			
6	2437 (Mid.)	0.456	0.364

NOTE:

1. In this testing, the limit for General Population Spatial Peak averaged over 1g, 1.6 W/kg, is applied.
2. Please see the Appendix A for the data.
3. The variation of the EUT conducted power measured before and after SAR testing should not over 5%.
4. Per KDB 447498, when 1-g SAR for the highest output channel is less than 0.8 W/kg, testing for the other channels is not required.



6.5 POWER DRIFT TABLE

Test Mode	Test Position	Communication Mode	Test Channel	Test Frequency	Power (dBm)		Power Drift (%)
					Begin	After	
1	Tip 5mm	802.11b	1	2412	12.60	12.50	-2.28
2		802.11g	6	2437	17.00	16.90	-2.28
3		802.11n (20MHz)	6	2437	17.10	16.90	-4.50
4	Bottom 5mm	802.11b	1	2412	12.60	12.50	-2.28
5		802.11g	6	2437	17.00	16.80	-4.50
6		802.11n (20MHz)	6	2437	17.10	17.00	-2.28

6.6 SAR LIMITS

HUMAN EXPOSURE	SAR (W/kg)	
	(GENERAL POPULATION / UNCONTROLLED EXPOSURE ENVIRONMENT)	(OCCUPATIONAL / CONTROLLED EXPOSURE ENVIRONMENT)
Spatial Average (whole body)	0.08	0.4
Spatial Peak (averaged over 1 g)	1.6	8.0
Spatial Peak (hands / wrists / feet / ankles averaged over 10 g)	4.0	20.0

NOTE: This limits accord to 47 CFR 2.1093 – Safety Limit.



7. INFORMATION ON THE TESTING LABORATORIES

We, Bureau Veritas Consumer Products Services (H.K.) Ltd., Taoyuan Branch, were founded in 1988 to provide our best service in EMC, Radio, Telecom and Safety consultation. Our laboratories are accredited and approved according to ISO/IEC 17025.

Copies of accreditation certificates of our laboratories obtained from approval agencies can be downloaded from our web site: www.adt.com.tw/index.5.phtml. If you have any comments, please feel free to contact us at the following:

Linko EMC/RF Lab:

Tel: 886-2-26052180

Fax: 886-2-26051924

Hsin Chu EMC/RF Lab:

Tel: 886-3-5935343

Fax: 886-3-5935342

Hwa Ya EMC/RF/Safety/Telecom Lab:

Tel: 886-3-3183232

Fax: 886-3-3185050

Web Site: www.adt.com.tw

The address and road map of all our labs can be found in our web site also.

---END---



香港商立德國際商品試驗有限公司桃園分公司

Bureau Veritas Consumer Products Services (H.K.) Ltd., Taoyuan Branch

A D T

APPENDIX A: TEST DATA

Product Name: eReader ; Model Number: N905

Liquid Level Photo

Tissue 2450MHz D=150mm

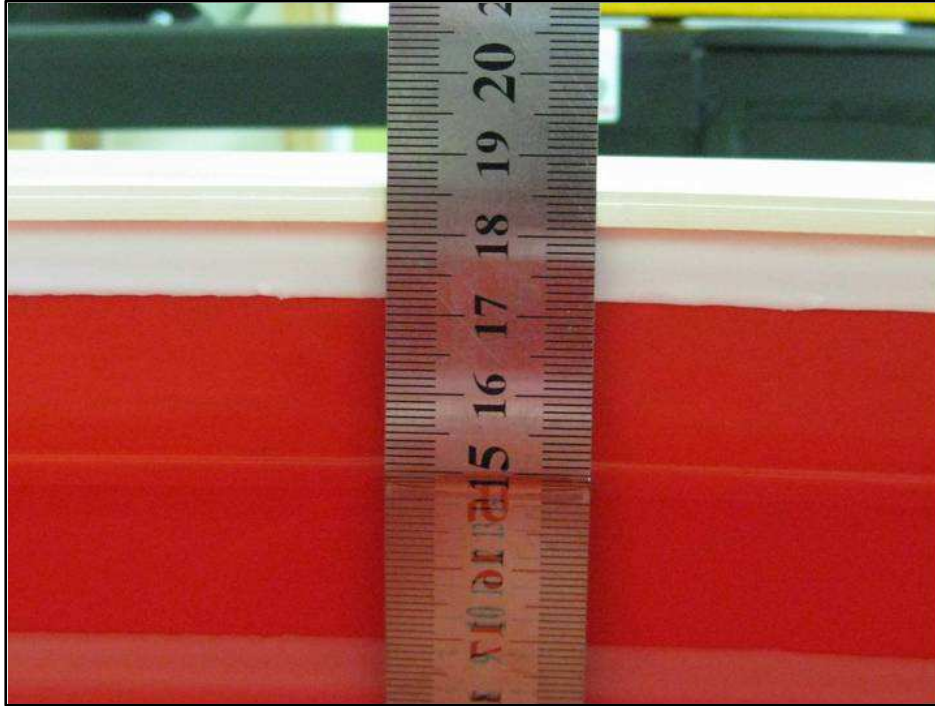

M01-Tip-11b-Ch1

Communication System: 802.11b ; Frequency: 2412 MHz ; Duty Cycle: 1:1 ; Modulation type: DBPSK
 Medium: MSL2450 Medium parameters used: $f = 2412$ MHz; $\sigma = 1.93$ mho/m; $\epsilon_r = 54.06$; $\rho = 1000$ kg/m³

Phantom section: Flat Section ; Separation distance : 5 mm (The tip side of the EUT to the Phantom)

DASY5 Configuration:

- Probe: EX3DV4 - SN3650; ConvF(7.05, 7.05, 7.05); Calibrated: 2011/1/24
- Sensor-Surface: 2mm (Mechanical Surface Detection)
- Electronics: DAE3 Sn510; Calibrated: 2010/10/4
- Phantom: ELI 4.0; Type: QDOVA001BA;Serial: 1043
- Measurement SW: DASY52, Version 52.6 (1); SEMCAD X Version 14.4.2 (2595)

Flat-Section MSL/Flat Section 5mm Low/Area Scan (5x11x1): Measurement grid:

$dx=15$ mm, $dy=15$ mm

Maximum value of SAR (measured) = 0.150 mW/g

Flat-Section MSL/Flat Section 5mm Low/Zoom Scan (5x5x7)/Cube 0: Measurement grid:

$dx=8$ mm, $dy=8$ mm, $dz=5$ mm

Reference Value = 6.097 V/m; Power Drift = 0.18 dB

Peak SAR (extrapolated) = 0.244 W/kg

SAR(1 g) = 0.118 mW/g; SAR(10 g) = 0.058 mW/g

Maximum value of SAR (measured) = 0.175 mW/g

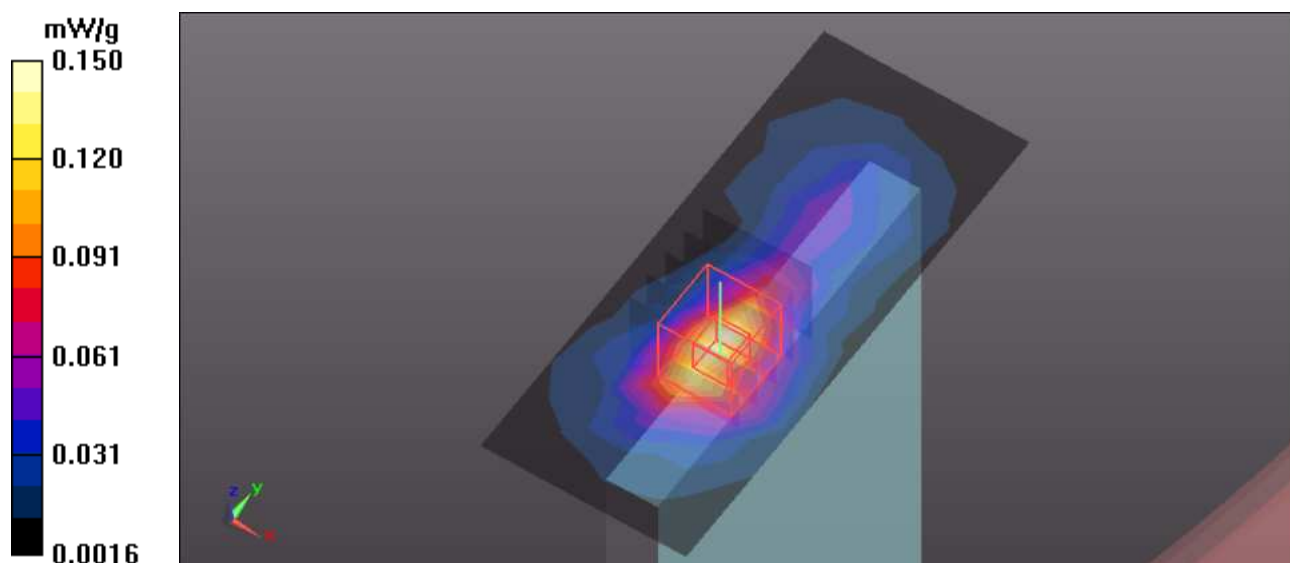

M02-Tip-11g-Ch6

Communication System: 802.11g ; Frequency: 2437 MHz ; Duty Cycle: 1:1 ; Modulation type: BPSK
Medium: MSL2450 Medium parameters used: $f = 2437$ MHz; $\sigma = 1.96$ mho/m; $\epsilon_r = 53.94$; $\rho = 1000$ kg/m³

Phantom section: Flat Section ; Separation distance : 5 mm (The tip side of the EUT to the Phantom)

DASY5 Configuration:

- Probe: EX3DV4 - SN3650; ConvF(7.05, 7.05, 7.05); Calibrated: 2011/1/24
- Sensor-Surface: 2mm (Mechanical Surface Detection)
- Electronics: DAE3 Sn510; Calibrated: 2010/10/4
- Phantom: ELI 4.0; Type: QDOVA001BA;Serial: 1043
- Measurement SW: DASY52, Version 52.6 (1); SEMCAD X Version 14.4.2 (2595)

Flat-Section MSL/Flat Section 5mm Mid/Area Scan (5x11x1): Measurement grid:

$dx=15$ mm, $dy=15$ mm

Maximum value of SAR (measured) = 0.349 mW/g

Flat-Section MSL/Flat Section 5mm Mid/Zoom Scan (5x5x7)/Cube 0: Measurement grid:

$dx=8$ mm, $dy=8$ mm, $dz=5$ mm

Reference Value = 12.194 V/m; Power Drift = -0.06 dB

Peak SAR (extrapolated) = 0.689 W/kg

SAR(1 g) = 0.342 mW/g; SAR(10 g) = 0.165 mW/g

Maximum value of SAR (measured) = 0.522 mW/g

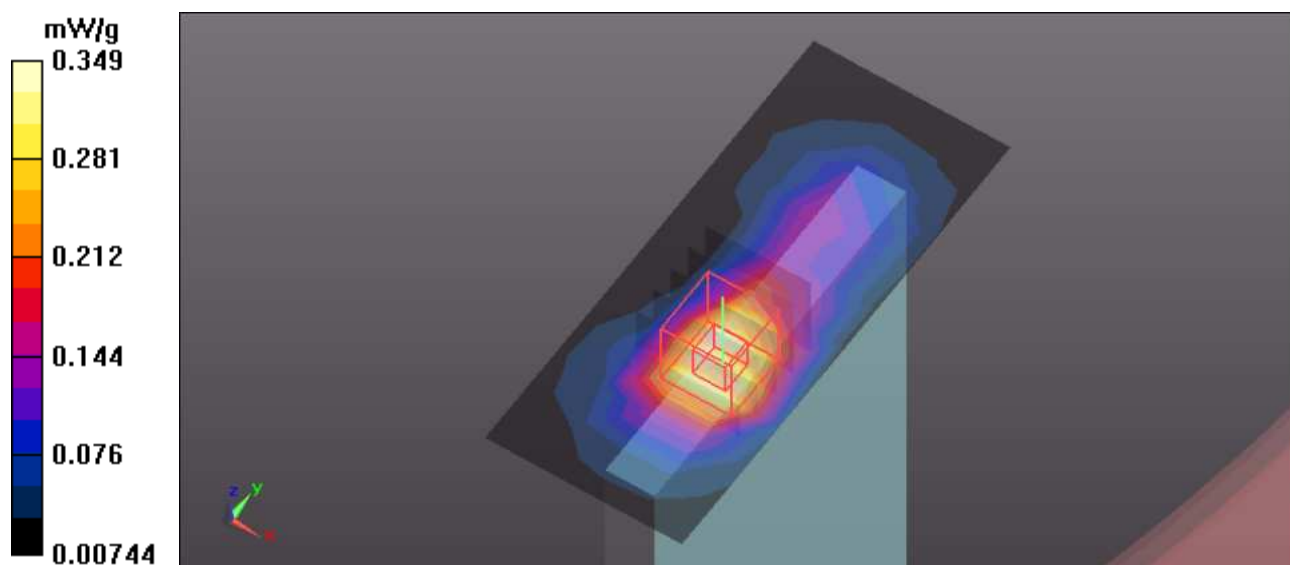

M03-Tip-11n 20MHz-Ch6

Communication System: 11n 20M; Frequency: 2437 MHz; Duty Cycle: 1:1; Modulation type: BPSK
 Medium: MSL2450 Medium parameters used: $f = 2437$ MHz; $\sigma = 1.96$ mho/m; $\epsilon_r = 53.94$; $\rho = 1000$ kg/m³

Phantom section: Flat Section; Separation distance: 5 mm (The tip side of the EUT to the Phantom)

DASY5 Configuration:

- Probe: EX3DV4 - SN3650; ConvF(7.05, 7.05, 7.05); Calibrated: 2011/1/24
- Sensor-Surface: 2mm (Mechanical Surface Detection)
- Electronics: DAE3 Sn510; Calibrated: 2010/10/4
- Phantom: ELI 4.0; Type: QDOVA001BA; Serial: 1043
- Measurement SW: DASY52, Version 52.6 (1); SEMCAD X Version 14.4.2 (2595)

Flat-Section MSL/Flat Section 5mm Mid/Area Scan (5x11x1): Measurement grid:

$dx=15$ mm, $dy=15$ mm

Maximum value of SAR (measured) = 0.387 mW/g

Flat-Section MSL/Flat Section 5mm Mid/Zoom Scan (5x5x7)/Cube 0: Measurement grid:

$dx=8$ mm, $dy=8$ mm, $dz=5$ mm

Reference Value = 12.085 V/m; Power Drift = 0.09 dB

Peak SAR (extrapolated) = 0.725 W/kg

SAR(1 g) = 0.364 mW/g; SAR(10 g) = 0.172 mW/g

Maximum value of SAR (measured) = 0.558 mW/g

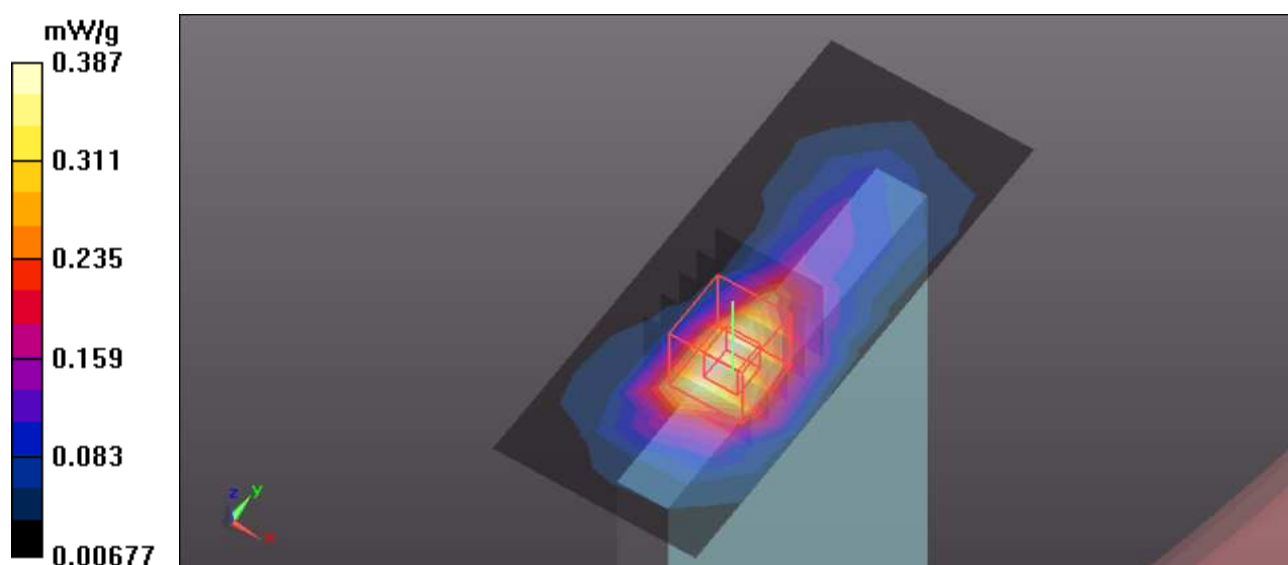

M04-Bottom-11b-Ch1

Communication System: 802.11b ; Frequency: 2412 MHz ; Duty Cycle: 1:1 ; Modulation type: DBPSK
Medium: MSL2450 Medium parameters used: $f = 2412$ MHz; $\sigma = 1.93$ mho/m; $\epsilon_r = 54.06$; $\rho = 1000$ kg/m³

Phantom section: Flat Section ; Separation distance : 5 mm (The bottom side of the EUT to the Phantom)

DASY5 Configuration:

- Probe: EX3DV4 - SN3650; ConvF(7.05, 7.05, 7.05); Calibrated: 2011/1/24
- Sensor-Surface: 2mm (Mechanical Surface Detection)
- Electronics: DAE3 Sn510; Calibrated: 2010/10/4
- Phantom: ELI 4.0; Type: QDOVA001BA;Serial: 1043
- Measurement SW: DASY52, Version 52.6 (1); SEMCAD X Version 14.4.2 (2595)

Flat-Section MSL/Flat Section 5mm Low/Area Scan (11x14x1): Measurement grid:
dx=15mm, dy=15mm

Maximum value of SAR (measured) = 0.140 mW/g

Flat-Section MSL/Flat Section 5mm Low/Zoom Scan (5x5x7)/Cube 0: Measurement grid:
dx=8mm, dy=8mm, dz=5mm

Reference Value = 4.733 V/m; Power Drift = -0.13 dB

Peak SAR (extrapolated) = 0.277 W/kg

SAR(1 g) = 0.128 mW/g; SAR(10 g) = 0.069 mW/g

Maximum value of SAR (measured) = 0.189 mW/g

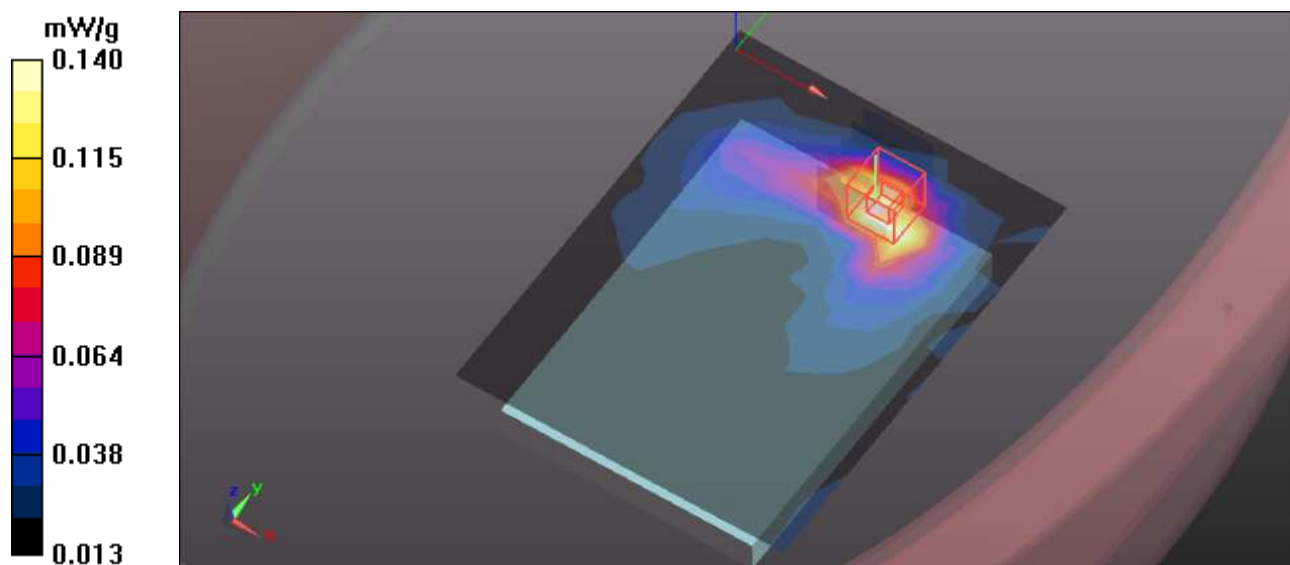

M05-Bottom-11g-Ch6

Communication System: 802.11g ; Frequency: 2437 MHz ; Duty Cycle: 1:1 ; Modulation type: BPSK
Medium: MSL2450 Medium parameters used: $f = 2437$ MHz; $\sigma = 1.96$ mho/m; $\epsilon_r = 53.94$; $\rho = 1000$ kg/m³

Phantom section: Flat Section ; Separation distance : 5 mm (The bottom side of the EUT to the Phantom)

DASY5 Configuration:

- Probe: EX3DV4 - SN3650; ConvF(7.05, 7.05, 7.05); Calibrated: 2011/1/24
- Sensor-Surface: 2mm (Mechanical Surface Detection)
- Electronics: DAE3 Sn510; Calibrated: 2010/10/4
- Phantom: ELI 4.0; Type: QDOVA001BA;Serial: 1043
- Measurement SW: DASY52, Version 52.6 (1); SEMCAD X Version 14.4.2 (2595)

Flat-Section MSL/Flat Section 5mm Mid/Area Scan (11x14x1): Measurement grid:

$dx=15$ mm, $dy=15$ mm

Maximum value of SAR (measured) = 0.403 mW/g

Flat-Section MSL/Flat Section 5mm Mid/Zoom Scan (5x5x7)/Cube 0: Measurement grid:

$dx=8$ mm, $dy=8$ mm, $dz=5$ mm

Reference Value = 2.954 V/m; Power Drift = 0.15 dB

Peak SAR (extrapolated) = 0.849 W/kg

SAR(1 g) = 0.391 mW/g; SAR(10 g) = 0.188 mW/g

Maximum value of SAR (measured) = 0.574 mW/g

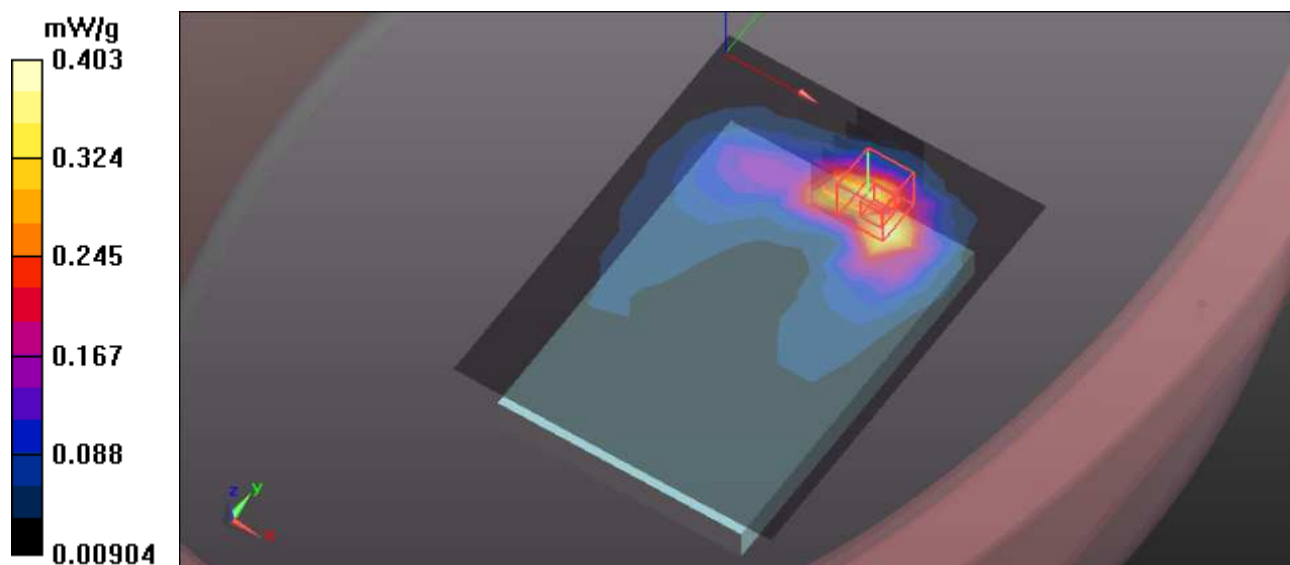

M06-Bottom-11n 20MHz-Ch6

Communication System: 11n 20M; Frequency: 2437 MHz; Duty Cycle: 1:1; Modulation type: BPSK
Medium: MSL2450 Medium parameters used: $f = 2437$ MHz; $\sigma = 1.96$ mho/m; $\epsilon_r = 53.94$; $\rho = 1000$ kg/m³

Phantom section: Flat Section; Separation distance: 5 mm (The bottom side of the EUT to the Phantom)

DASY5 Configuration:

- Probe: EX3DV4 - SN3650; ConvF(7.05, 7.05, 7.05); Calibrated: 2011/1/24
- Sensor-Surface: 2mm (Mechanical Surface Detection)
- Electronics: DAE3 Sn510; Calibrated: 2010/10/4
- Phantom: ELI 4.0; Type: QDOVA001BA; Serial: 1043
- Measurement SW: DASY52, Version 52.6 (1); SEMCAD X Version 14.4.2 (2595)

Flat-Section MSL/Flat Section 5mm Mid/Area Scan (11x14x1): Measurement grid:
dx=15mm, dy=15mm

Maximum value of SAR (measured) = 0.476 mW/g

Flat-Section MSL/Flat Section 5mm Mid/Zoom Scan (5x5x7)/Cube 0: Measurement grid:
dx=8mm, dy=8mm, dz=5mm

Reference Value = 4.513 V/m; Power Drift = -0.13 dB

Peak SAR (extrapolated) = 0.910 W/kg

SAR(1 g) = 0.377 mW/g; SAR(10 g) = 0.172 mW/g

Maximum value of SAR (measured) = 0.600 mW/g

Flat-Section MSL/Flat Section 5mm Mid/Zoom Scan (5x5x7)/Cube 1: Measurement grid:
dx=8mm, dy=8mm, dz=5mm

Reference Value = 4.513 V/m; Power Drift = -0.13 dB

Peak SAR (extrapolated) = 1.078 W/kg

SAR(1 g) = 0.456 mW/g; SAR(10 g) = 0.204 mW/g

Maximum value of SAR (measured) = 0.683 mW/g

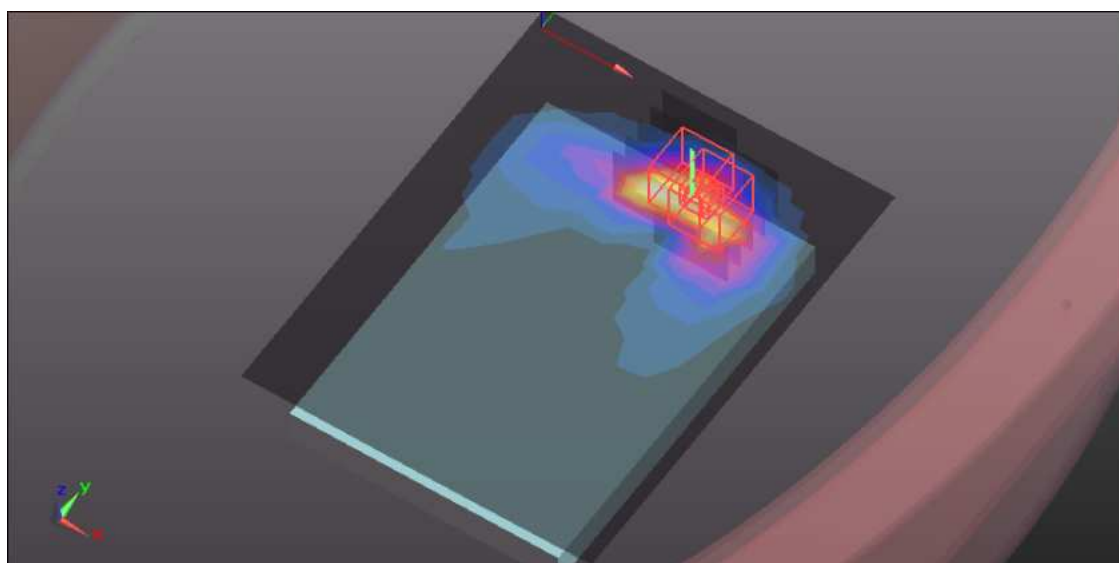
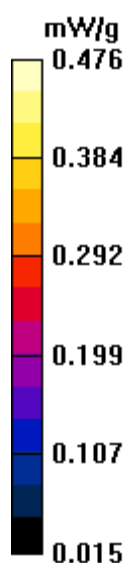

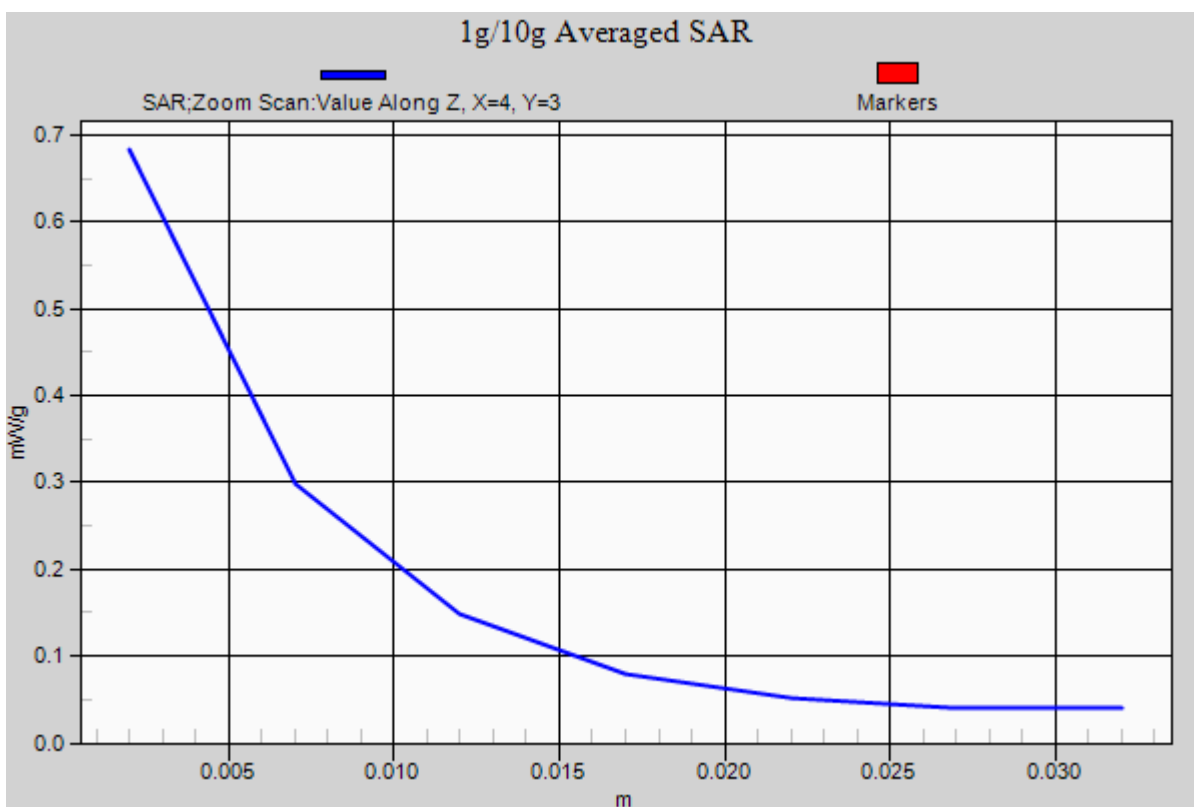

System Performance Check-D2450V2-MSL2450 MHz

DUT: Dipole 2450 MHz ; Type: D2450V2 ; Serial: D2450V2 - SN:716 ; Test Frequency: 2450 MHz

Communication System: CW ; Frequency: 2450 MHz; Duty Cycle: 1:1; Modulation type: CW
 Medium: MSL2450; Medium parameters used: $f = 2450$ MHz; $\sigma = 1.98$ mho/m; $\epsilon_r = 53.86$; $\rho = 1000$ kg/m³ ; Liquid level : 150 mm
 Phantom section: Flat Section ; Separation distance : 10 mm (The feet point of the dipole to the Phantom) Air temp. : 22.8 degrees ; Liquid temp. : 21.6 degrees

DASY5 Configuration:

- Probe: EX3DV4 - SN3650; ConvF(7.05, 7.05, 7.05); Calibrated: 2011/1/24
- Sensor-Surface: 2mm (Mechanical Surface Detection)
- Electronics: DAE3 Sn510; Calibrated: 2010/10/4
- Phantom: ELI 4.0; Type: QDOVA001BA; Serial: 1043
- Measurement SW: DASY52, Version 52.6 (1); SEMCAD X Version 14.4.2 (2595)

System Performance Check at Frequencies above 1 GHz/d=10mm, Pin=250 mW, dist=2.0mm (EX-Probe)/Area Scan (7x7x1): Measurement grid: dx=15mm, dy=15mm
 Maximum value of SAR (measured) = 18.981 mW/g

System Performance Check at Frequencies above 1 GHz/d=10mm, Pin=250 mW, dist=2.0mm (EX-Probe)/Zoom Scan (7x7x7)/Cube 0: Measurement grid: dx=5mm, dy=5mm, dz=5mm

Reference Value = 101.6 V/m; Power Drift = 0.02 dB

Peak SAR (extrapolated) = 30.371 W/kg

SAR(1 g) = 13.9 mW/g; SAR(10 g) = 6.27 mW/g

Maximum value of SAR (measured) = 15.766 mW/g

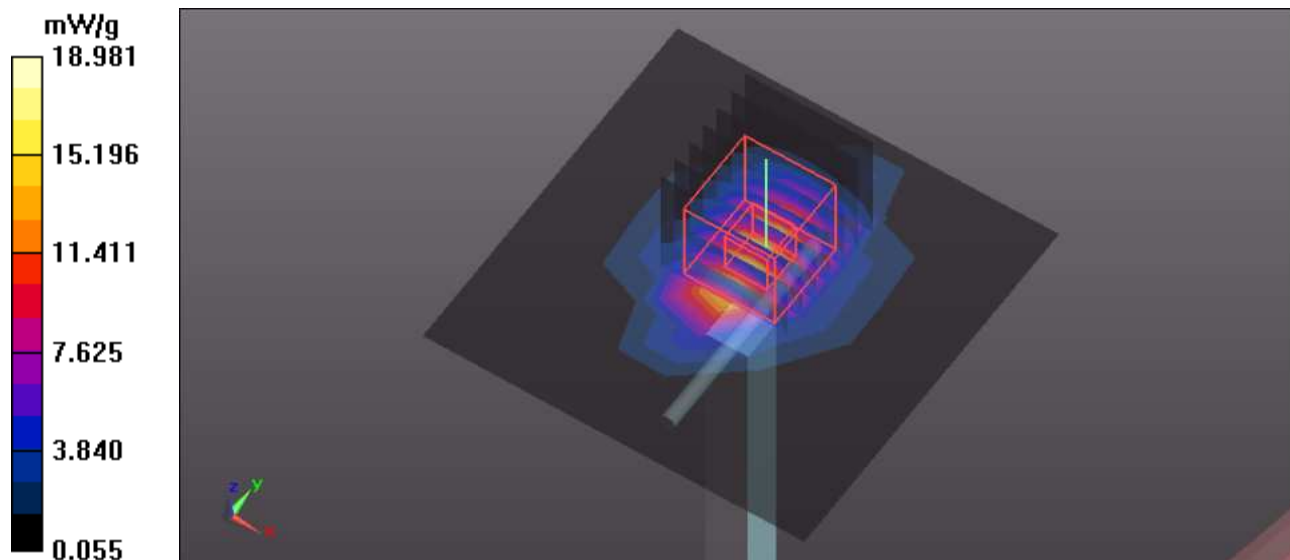

APPENDIX B: BV ADT SAR MEASUREMENT SYSTEM

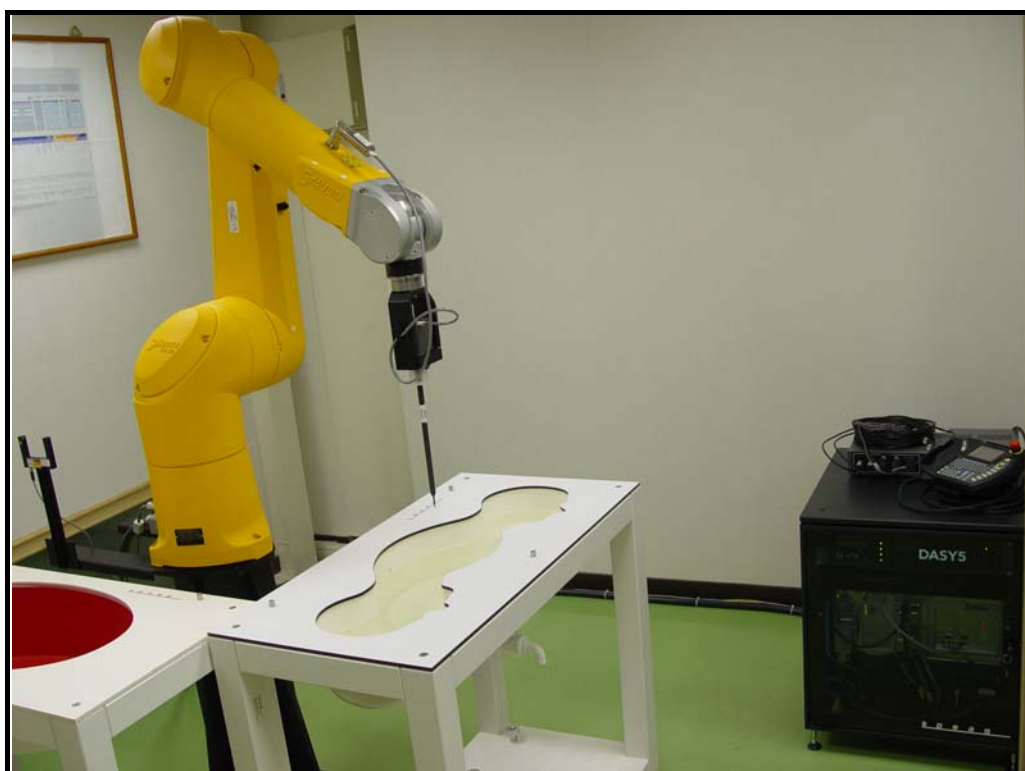

APPENDIX C: PHOTOGRAPHS OF SYSTEM VALIDATION





APPENDIX D: SYSTEM CERTIFICATE & CALIBRATION

D1: PHANTOM

Certificate of Conformity / First Article Inspection

Item	Oval Flat Phantom ELI 4.0
Type No	QD OVA 001 B
Series No	1003 and higher
Manufacturer	SPEAG Zeughausstrasse 43 CH-8004 Zürich Switzerland

Tests

Complete tests were made on the prototype units QD OVA 001 AA 1001, QD OVA 001 AB 1002, pre-series units QD OVA 001 BA 1003-1005 as well as on the series units QD OVA 001 BB, 1006 ff.

Test	Requirement	Details	Units tested
Dimensions	Compliant with the standard IEC 62209 – 2 [1] requirements	Dimensions of bottom for 300 MHz – 6 GHz: longitudinal = 600 mm (max. dimension) width = 400 mm (min dimension) depth = 190 mm Shape: ellipse	Prototypes, Samples
Material thickness	Compliant with the standard IEC 62209 – 2 [1] requirements	Bottom plate: 2.0mm +/- 0.2mm	Prototypes, All items
Material parameters	Dielectric parameters for required frequencies	300 MHz – 6 GHz Rel. permittivity = 4 +/-1, Loss tangent ≤ 0.05	Material sample
Material resistivity	The material has been tested to be compatible with the liquids defined in the standards if handled and cleaned according to the instructions. Observe Technical Note for material compatibility.	DEGMBE based simulating liquids	Equivalent phantoms, Material sample
Sagging	Compliant with the requirements according to the standard. Sagging of the flat section when filled with tissue simulating liquid	< 1% typical < 0.8% if filled with 155mm of HSL900 and without DUT below	Prototypes, Sample testing

Standards

- [1] IEC 62209 – 2, Draft Version 0.9, "Evaluation of Human Exposure to Radio Frequency Fields from Handheld and Body-Mounted Wireless Communication Devices in the Frequency Range of 30 MHz to 6 GHz: Human models, Instrumentation and Procedures Part 2: Procedure to determine the Specific Absorption Rate (SAR) for ... including accessories and multiple transmitters", December 2004

Conformity

Based on the sample tests above, we certify that this item is in compliance with the standard [1].

Date

07.07.2005

s p e a g

Signature / Stamp

Schmid & Partner Engineering AG
Zeughausstrasse 43, 8004 Zurich, Switzerland
Phone +41 1 245 9700, Fax +41 1 245 9779
info@speag.com, http://www.speag.com



A D T

D2: DOSIMETRIC E-FIELD PROBE



Accredited by the Swiss Accreditation Service (SAS)
 The Swiss Accreditation Service is one of the signatories to the EA
 Multilateral Agreement for the recognition of calibration certificates

Accreditation No.: **SCS 108**

Client **B.V. ADT (Auden)**

Certificate No: **EX3-3650_Jan11**

CALIBRATION CERTIFICATE

Object **EX3DV4 - SN:3650**

Calibration procedure(s) **QA CAL-01.v7, QA CAL-14.v3, QA CAL-23.v4 and QA CAL-25.v3
 Calibration procedure for dosimetric E-field probes**

Calibration date: **January 24, 2011**

This calibration certificate documents the traceability to national standards, which realize the physical units of measurements (SI).
 The measurements and the uncertainties with confidence probability are given on the following pages and are part of the certificate.

All calibrations have been conducted in the closed laboratory facility: environment temperature (22 ± 3)°C and humidity < 70%.

Calibration Equipment used (M&TE critical for calibration)

Primary Standards	ID #	Cal Date (Certificate No.)	Scheduled Calibration
Power meter E4419B	GB41293874	1-Apr-10 (No. 217-01136)	Apr-11
Power sensor E4412A	MY41495277	1-Apr-10 (No. 217-01136)	Apr-11
Power sensor E4412A	MY41498087	1-Apr-10 (No. 217-01136)	Apr-11
Reference 3 dB Attenuator	SN: S5054 (3c)	30-Mar-10 (No. 217-01159)	Mar-11
Reference 20 dB Attenuator	SN: S5086 (20b)	30-Mar-10 (No. 217-01161)	Mar-11
Reference 30 dB Attenuator	SN: S5129 (30b)	30-Mar-10 (No. 217-01160)	Mar-11
Reference Probe ES3DV2	SN: 3013	29-Dec-10 (No. ES3-3013_Dec10)	Dec-11
DAE4	SN: 660	20-Apr-10 (No. DAE4-660_Apr10)	Apr-11
Secondary Standards	ID #	Check Date (in house)	Scheduled Check
RF generator HP 8648C	US3642U01700	4-Aug-99 (in house check Oct-09)	In house check: Oct-11
Network Analyzer HP 8753E	US37390585	18-Oct-01 (in house check Oct-10)	In house check: Oct-11

Calibrated by: **Katja Pokovic** Name: **Katja Pokovic** Function: **Technical Manager**

Approved by: **Fin Bomholt** Name: **Fin Bomholt** Function: **R&D Director**

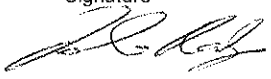
Signature: 

Issued: January 25, 2011

This calibration certificate shall not be reproduced except in full without written approval of the laboratory.



Accredited by the Swiss Accreditation Service (SAS)

The Swiss Accreditation Service is one of the signatories to the EA
Multilateral Agreement for the recognition of calibration certificates

Accreditation No.: **SCS 108**

Glossary:

TSL	tissue simulating liquid
NORM _{x,y,z}	sensitivity in free space
ConvF	sensitivity in TSL / NORM _{x,y,z}
DCP	diode compression point
CF	crest factor (1/duty_cycle) of the RF signal
A, B, C	modulation dependent linearization parameters
Polarization φ	φ rotation around probe axis
Polarization ϑ	ϑ rotation around an axis that is in the plane normal to probe axis (at measurement center), i.e., $\vartheta = 0$ is normal to probe axis

Calibration is Performed According to the Following Standards:

- IEEE Std 1528-2003, "IEEE Recommended Practice for Determining the Peak Spatial-Averaged Specific Absorption Rate (SAR) in the Human Head from Wireless Communications Devices: Measurement Techniques", December 2003
- IEC 62209-1, "Procedure to measure the Specific Absorption Rate (SAR) for hand-held devices used in close proximity to the ear (frequency range of 300 MHz to 3 GHz)", February 2005

Methods Applied and Interpretation of Parameters:

- NORM_{x,y,z}**: Assessed for E-field polarization $\vartheta = 0$ ($f \leq 900$ MHz in TEM-cell; $f > 1800$ MHz: R22 waveguide). NORM_{x,y,z} are only intermediate values, i.e., the uncertainties of NORM_{x,y,z} does not effect the E^2 -field uncertainty inside TSL (see below *ConvF*).
- NORM(f)_{x,y,z}** = NORM_{x,y,z} * *frequency_response* (see Frequency Response Chart). This linearization is implemented in DASY4 software versions later than 4.2. The uncertainty of the frequency response is included in the stated uncertainty of *ConvF*.
- DCP_{x,y,z}**: DCP are numerical linearization parameters assessed based on the data of power sweep with CW signal (no uncertainty required). DCP does not depend on frequency nor media.
- A_{x,y,z}; B_{x,y,z}; C_{x,y,z}; VR_{x,y,z}**: A, B, C are numerical linearization parameters assessed based on the data of power sweep for specific modulation signal. The parameters do not depend on frequency nor media. VR is the maximum calibration range expressed in RMS voltage across the diode.
- ConvF and Boundary Effect Parameters**: Assessed in flat phantom using E-field (or Temperature Transfer Standard for $f \leq 800$ MHz) and inside waveguide using analytical field distributions based on power measurements for $f > 800$ MHz. The same setups are used for assessment of the parameters applied for boundary compensation (alpha, depth) of which typical uncertainty values are given. These parameters are used in DASY4 software to improve probe accuracy close to the boundary. The sensitivity in TSL corresponds to NORM_{x,y,z} * ConvF whereby the uncertainty corresponds to that given for ConvF. A frequency dependent ConvF is used in DASY version 4.4 and higher which allows extending the validity from ± 50 MHz to ± 100 MHz.
- Spherical isotropy (3D deviation from isotropy)**: in a field of low gradients realized using a flat phantom exposed by a patch antenna.
- Sensor Offset**: The sensor offset corresponds to the offset of virtual measurement center from the probe tip (on probe axis). No tolerance required.

Probe EX3DV4

SN:3650

Manufactured:	March 18, 2008
Last calibrated:	July 5, 2008
Recalibrated:	January 24, 2011

Calibrated for DASYS/EASY Systems

(Note: non-compatible with DASYS2 system!)

DASY/EASY - Parameters of Probe: EX3DV4 SN:3650**Basic Calibration Parameters**

	Sensor X	Sensor Y	Sensor Z	Unc (k=2)
Norm ($\mu\text{V}/(\text{V}/\text{m})^2$) ^A	0.45	0.40	0.49	$\pm 10.1\%$
DCP (mV) ^B	93.4	96.5	95.5	

Modulation Calibration Parameters

UID	Communication System Name	PAR		A dB	B dBuV	C	VR mV	Unc ^E (k=2)
10000	CW	0.00	X	0.00	0.00	1.00	137.0	$\pm 3.4\%$
			Y	0.00	0.00	1.00	141.2	
			Z	0.00	0.00	1.00	144.7	

The reported uncertainty of measurement is stated as the standard uncertainty of measurement multiplied by the coverage factor $k=2$, which for a normal distribution corresponds to a coverage probability of approximately 95%.

^A The uncertainties of NormX,Y,Z do not affect the E^2 -field uncertainty inside TSL (see Pages 5 and 6).

^B Numerical linearization parameter: uncertainty not required.

^E Uncertainty is determined using the maximum deviation from linear response applying recatangular distribution and is expressed for the square of the field value.

DASY/EASY - Parameters of Probe: EX3DV4 SN:3650

Calibration Parameter Determined in Head Tissue Simulating Media

f [MHz]	Validity [MHz] ^c	Permittivity	Conductivity	ConvF X	ConvF Y	ConvF Z	Alpha	Depth Unc (k=2)
750	± 50 / ± 100	41.9 ± 5%	0.89 ± 5%	9.46	9.46	9.46	0.43	0.72 ± 11.0%
835	± 50 / ± 100	41.5 ± 5%	0.90 ± 5%	8.95	8.95	8.95	0.55	0.67 ± 11.0%
1450	± 50 / ± 100	40.5 ± 5%	1.20 ± 5%	8.86	8.86	8.86	0.78	0.64 ± 11.0%
1750	± 50 / ± 100	40.1 ± 5%	1.37 ± 5%	8.17	8.17	8.17	0.75	0.60 ± 11.0%
1950	± 50 / ± 100	40.0 ± 5%	1.40 ± 5%	7.57	7.57	7.57	0.57	0.66 ± 11.0%
2450	± 50 / ± 100	39.2 ± 5%	1.80 ± 5%	7.10	7.10	7.10	0.36	0.88 ± 11.0%
2600	± 50 / ± 100	39.0 ± 5%	1.96 ± 5%	6.93	6.93	6.93	0.38	0.88 ± 11.0%
5200	± 50 / ± 100	36.0 ± 5%	4.66 ± 5%	4.69	4.69	4.69	0.40	1.80 ± 13.1%
5300	± 50 / ± 100	35.9 ± 5%	4.76 ± 5%	4.33	4.33	4.33	0.45	1.80 ± 13.1%
5500	± 50 / ± 100	35.6 ± 5%	4.96 ± 5%	4.42	4.42	4.42	0.45	1.80 ± 13.1%
5600	± 50 / ± 100	35.5 ± 5%	5.07 ± 5%	3.96	3.96	3.96	0.60	1.80 ± 13.1%
5800	± 50 / ± 100	35.3 ± 5%	5.27 ± 5%	4.27	4.27	4.27	0.45	1.80 ± 13.1%

^c The validity of ± 100 MHz only applies for DASY v4.4 and higher (see Page 2). The uncertainty is the RSS of the ConvF uncertainty at calibration frequency and the uncertainty for the indicated frequency band.

DASY/EASY - Parameters of Probe: EX3DV4 SN:3650

Calibration Parameter Determined in Body Tissue Simulating Media

f [MHz]	Validity [MHz] ^c	Permittivity	Conductivity	ConvF X	ConvF Y	ConvF Z	Alpha	Depth Unc (k=2)
750	± 50 / ± 100	55.5 ± 5%	0.96 ± 5%	9.25	9.25	9.25	0.53	0.71 ± 11.0%
835	± 50 / ± 100	55.2 ± 5%	0.97 ± 5%	9.12	9.12	9.12	0.36	0.88 ± 11.0%
1450	± 50 / ± 100	54.0 ± 5%	1.30 ± 5%	7.97	7.97	7.97	0.71	0.63 ± 11.0%
1750	± 50 / ± 100	53.4 ± 5%	1.49 ± 5%	7.46	7.46	7.46	0.78	0.61 ± 11.0%
1950	± 50 / ± 100	53.3 ± 5%	1.52 ± 5%	7.52	7.52	7.52	0.79	0.59 ± 11.0%
2450	± 50 / ± 100	52.7 ± 5%	1.95 ± 5%	7.05	7.05	7.05	0.54	0.74 ± 11.0%
2600	± 50 / ± 100	52.5 ± 5%	2.16 ± 5%	6.92	6.92	6.92	0.45	0.80 ± 11.0%
5200	± 50 / ± 100	49.0 ± 5%	5.30 ± 5%	4.25	4.25	4.25	0.50	1.90 ± 13.1%
5300	± 50 / ± 100	48.9 ± 5%	5.42 ± 5%	3.96	3.96	3.96	0.50	1.90 ± 13.1%
5500	± 50 / ± 100	48.6 ± 5%	5.65 ± 5%	3.76	3.76	3.76	0.55	1.90 ± 13.1%
5600	± 50 / ± 100	48.5 ± 5%	5.77 ± 5%	3.55	3.55	3.55	0.58	1.90 ± 13.1%
5800	± 50 / ± 100	48.2 ± 5%	6.00 ± 5%	3.86	3.86	3.86	0.60	1.90 ± 13.1%

^c The validity of ± 100 MHz only applies for DASY v4.4 and higher (see Page 2). The uncertainty is the RSS of the ConvF uncertainty at calibration frequency and the uncertainty for the indicated frequency band.

Frequency Response of E-Field

(TEM-Cell:ifi110 EXX, Waveguide: R22)

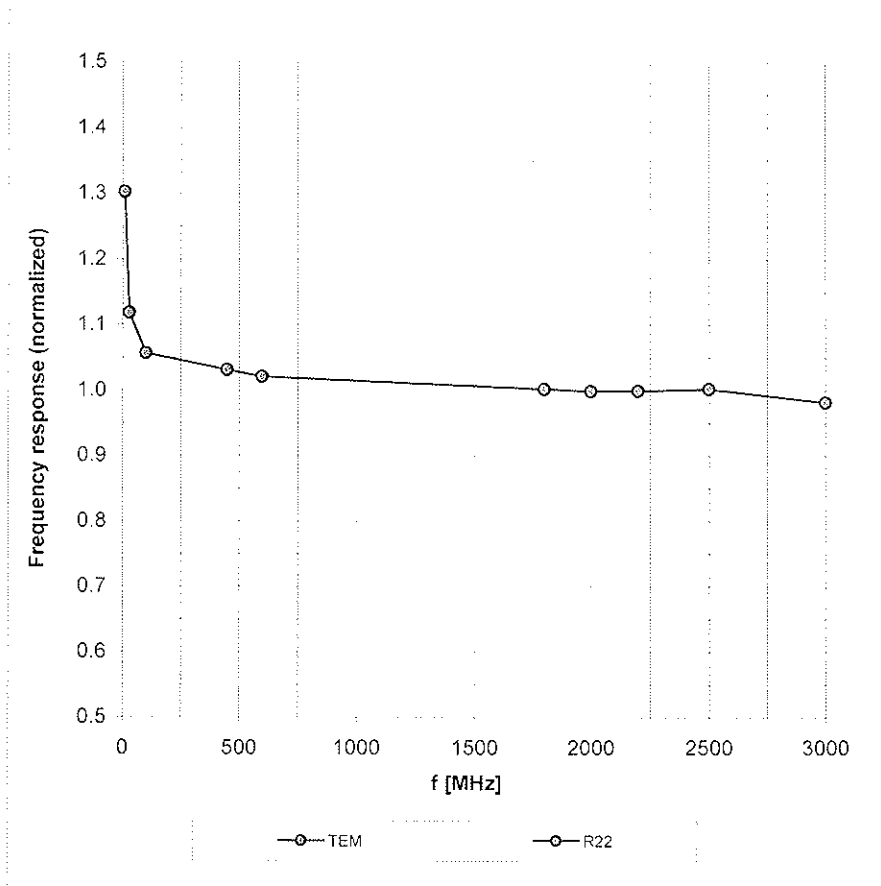

Uncertainty of Frequency Response of E-field: $\pm 6.3\%$ (k=2)

Receiving Pattern (ϕ), $\vartheta = 0^\circ$

f = 600 MHz, TEM ifi110EXX

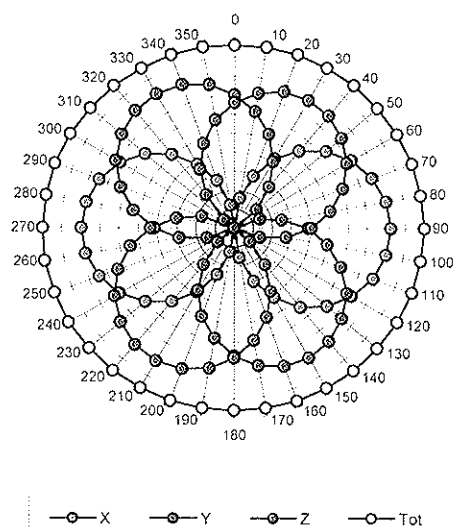

f = 1800 MHz, WG R22

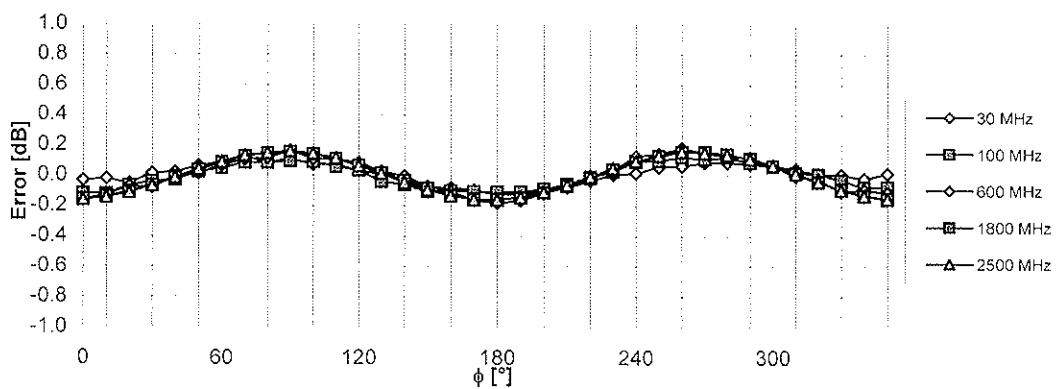
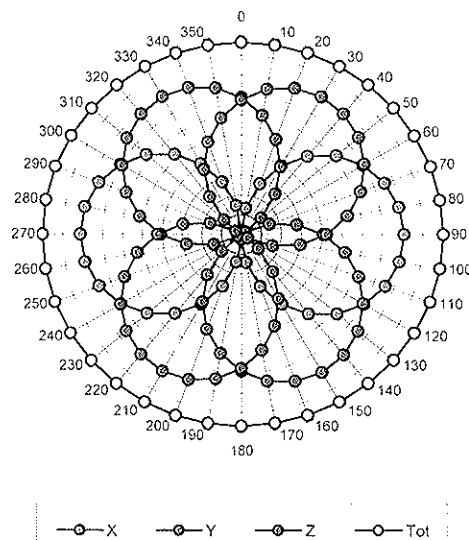

Uncertainty of Axial Isotropy Assessment: $\pm 0.5\%$ (k=2)

Dynamic Range f(SAR_{head})

(TEM cell, f = 900 MHz)

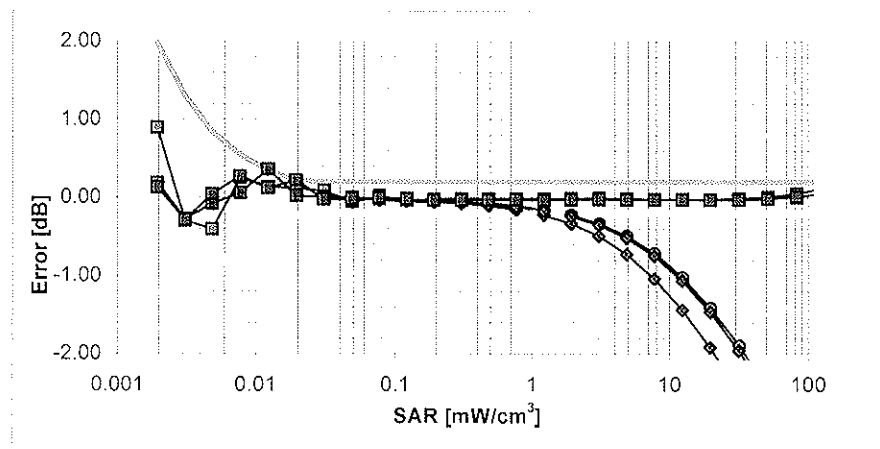
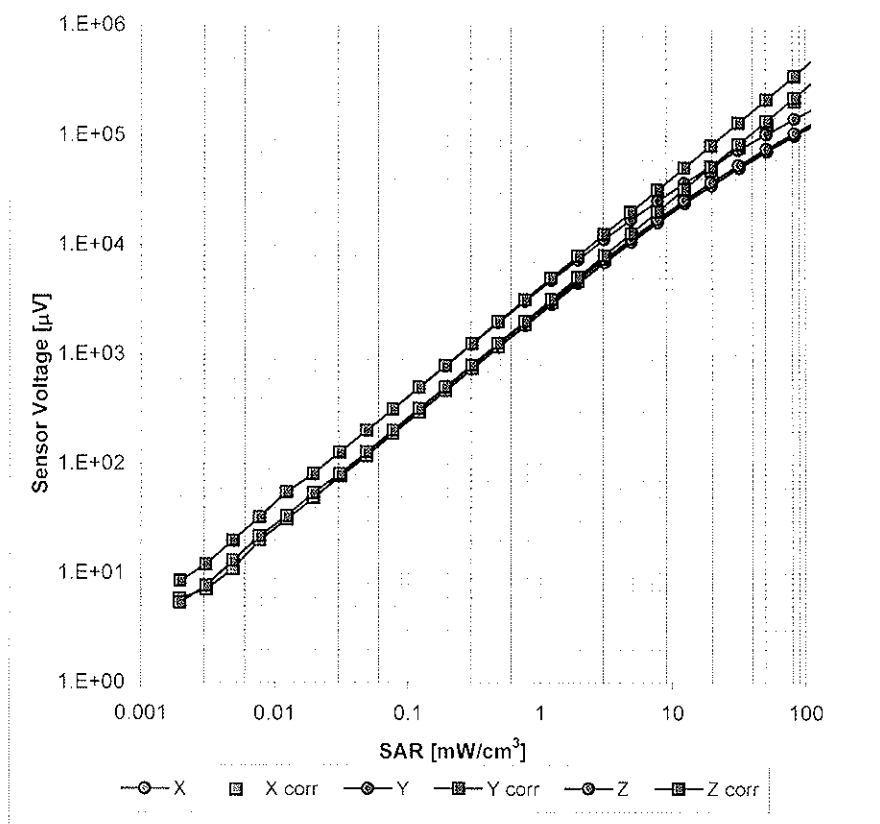

Uncertainty of Linearity Assessment: ± 0.6% (k=2)

Conversion Factor Assessment

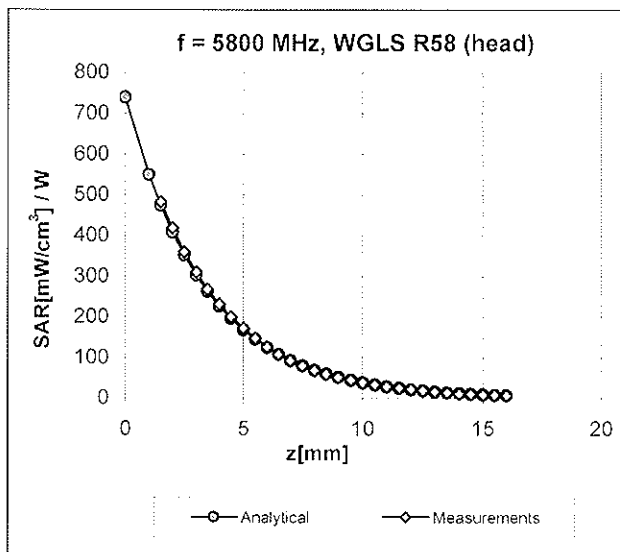
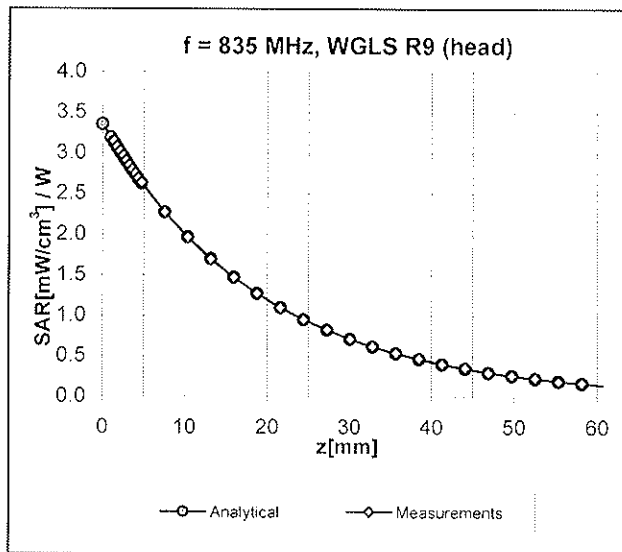

Deviation from Isotropy in HSL

Error (ϕ , ϑ), f = 900 MHz

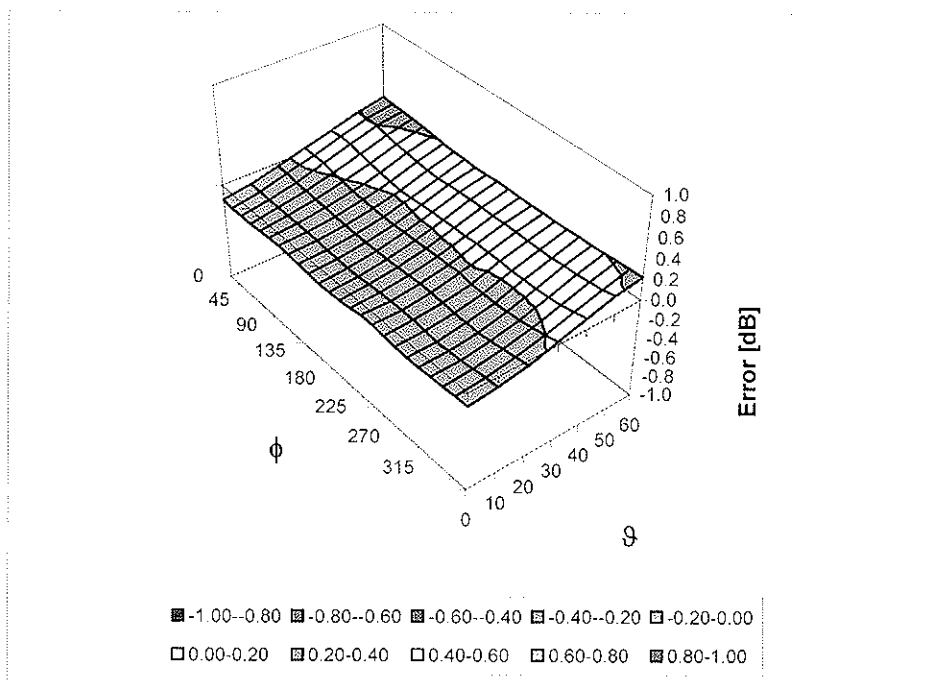

Uncertainty of Spherical Isotropy Assessment: $\pm 2.6\%$ (k=2)

Other Probe Parameters

Sensor Arrangement	Triangular
Connector Angle (°)	Not applicable
Mechanical Surface Detection Mode	enabled
Optical Surface Detection Mode	disabled
Probe Overall Length	337 mm
Probe Body Diameter	10 mm
Tip Length	9 mm
Tip Diameter	2.5 mm
Probe Tip to Sensor X Calibration Point	1 mm
Probe Tip to Sensor Y Calibration Point	1 mm
Probe Tip to Sensor Z Calibration Point	1 mm
Recommended Measurement Distance from Surface	2 mm



A D T

D3: DAE

IMPORTANT NOTICE

USAGE OF THE DAE 3

The DAE unit is a delicate, high precision instrument and requires careful treatment by the user. There are no serviceable parts inside the DAE. Special attention shall be given to the following points:

Battery Exchange: The battery cover of the DAE3 unit is connected to a fragile 3-pin battery connector. Customer is responsible to apply utmost caution not to bend or damage the connector when changing batteries.

Shipping of the DAE: Before shipping the DAE to SPEAG for calibration the customer shall remove the batteries and pack the DAE in an antistatic bag. This antistatic bag shall then be packed into a larger box or container which protects the DAE from impacts transportation. The package shall be marked to indicate that a fragile instrument is inside.

E-Stop Failures: Touch detection may be malfunctioning due to broken magnets in the E-stop. Rough handling of the E-stop may lead to damage of these magnets. Touch and collision errors are often caused by dust and dirt accumulated in the E-stop. To prevent E-stop failure, Customer shall always mount the probe to the DAE carefully and keep the DAE unit in a non-dusty environment if not used for measurements.

Repair: Minor repairs are performed at no extra cost during the annual calibration. However, SPEAG reserves the right to charge for any repair especially if rough unprofessional handling caused the defect.

DASY Configuration Files: Since the exact values of the DAE input resistances, as measured during the calibration procedure of a DAE unit, are not used by the DASY software, a nominal value of 200 MOhm is given in the corresponding configuration file.

Important Note:

Warranty and calibration is void if the DAE unit is disassembled partly or fully by the Customer.

Important Note:

Never attempt to grease or oil the E-stop assembly. Cleaning and readjusting of the E-stop assembly is allowed by certified SPEAG personnel only and is part of the annual calibration procedure.

Important Note:

To prevent damage of the DAE probe connector pins, use great care when installing the probe to the DAE. Carefully connect the probe with the connector notch oriented in the mating position. Avoid any rotational movement of the probe body versus the DAE while turning the locking nut of the connector. The same care shall be used when disconnecting the probe from the DAE.



Accredited by the Swiss Accreditation Service (SAS)
The Swiss Accreditation Service is one of the signatories to the EA
Multilateral Agreement for the recognition of calibration certificates

Accreditation No.: **SCS 108**

Client **ADT (Auden)**

Certificate No: **DAE3-510_Oct10**

CALIBRATION CERTIFICATE

Object **DAE3 - SD 000 D03 AA - SN: 510**

Calibration procedure(s) **QA CAL-06.v22
Calibration procedure for the data acquisition electronics (DAE)**

Calibration date: **October 4, 2010**

This calibration certificate documents the traceability to national standards, which realize the physical units of measurements (SI).
The measurements and the uncertainties with confidence probability are given on the following pages and are part of the certificate.

All calibrations have been conducted in the closed laboratory facility: environment temperature (22 ± 3)°C and humidity < 70%.

Calibration Equipment used (M&TE critical for calibration)

Primary Standards	ID #	Cal Date (Certificate No.)	Scheduled Calibration
Keithley Multimeter Type 2001	SN: 0810278	28-Sep-10 (No:10376)	Sep-11
Secondary Standards	ID #	Check Date (in house)	Scheduled Check
Calibrator Box V1.1	SE UMS 006 AB 1004	07-Jun-10 (in house check)	In house check: Jun-11

Calibrated by: **Dominique Steffen**

Function
Technician

Signature

Approved by: **Fin Bomholt**

R&D Director

Issued: October 4, 2010

This calibration certificate shall not be reproduced except in full without written approval of the laboratory.



Accredited by the Swiss Accreditation Service (SAS)
The Swiss Accreditation Service is one of the signatories to the EA
Multilateral Agreement for the recognition of calibration certificates

Accreditation No.: **SCS 108**

Glossary

DAE data acquisition electronics
Connector angle information used in DASY system to align probe sensor X to the robot coordinate system.

Methods Applied and Interpretation of Parameters

- *DC Voltage Measurement:* Calibration Factor assessed for use in DASY system by comparison with a calibrated instrument traceable to national standards. The figure given corresponds to the full scale range of the voltmeter in the respective range.
- *Connector angle:* The angle of the connector is assessed measuring the angle mechanically by a tool inserted. Uncertainty is not required.
- The following parameters as documented in the Appendix contain technical information as a result from the performance test and require no uncertainty.
 - *DC Voltage Measurement Linearity:* Verification of the Linearity at +10% and -10% of the nominal calibration voltage. Influence of offset voltage is included in this measurement.
 - *Common mode sensitivity:* Influence of a positive or negative common mode voltage on the differential measurement.
 - *Channel separation:* Influence of a voltage on the neighbor channels not subject to an input voltage.
 - *AD Converter Values with inputs shorted:* Values on the internal AD converter corresponding to zero input voltage
 - *Input Offset Measurement:* Output voltage and statistical results over a large number of zero voltage measurements.
 - *Input Offset Current:* Typical value for information; Maximum channel input offset current, not considering the input resistance.
 - *Input resistance:* Typical value for information: DAE input resistance at the connector, during internal auto-zeroing and during measurement.
 - *Low Battery Alarm Voltage:* Typical value for information. Below this voltage, a battery alarm signal is generated.
 - *Power consumption:* Typical value for information. Supply currents in various operating modes.

DC Voltage Measurement

A/D - Converter Resolution nominal

High Range: 1LSB = 6.1 μ V, full range = -100...+300 mV

Low Range: 1LSB = 61nV, full range = -1.....+3mV

DASY measurement parameters: Auto Zero Time: 3 sec; Measuring time: 3 sec

Calibration Factors	X	Y	Z
High Range	404.204 \pm 0.1% (k=2)	404.261 \pm 0.1% (k=2)	404.619 \pm 0.1% (k=2)
Low Range	3.97841 \pm 0.7% (k=2)	3.96431 \pm 0.7% (k=2)	3.98318 \pm 0.7% (k=2)

Connector Angle

Connector Angle to be used in DASY system	280.0 $^{\circ}$ \pm 1 $^{\circ}$
---	-------------------------------------

Appendix

1. DC Voltage Linearity

High Range		Reading (μV)	Difference (μV)	Error (%)
Channel X	+ Input	200002.6	1.33	0.00
Channel X	+ Input	20001.52	1.72	0.01
Channel X	- Input	-19997.99	1.81	-0.01
Channel Y	+ Input	200010.4	0.89	0.00
Channel Y	+ Input	20000.89	1.39	0.01
Channel Y	- Input	-19998.10	1.60	-0.01
Channel Z	+ Input	200007.2	-1.37	-0.00
Channel Z	+ Input	19998.21	-1.29	-0.01
Channel Z	- Input	-20001.73	-2.13	0.01

Low Range		Reading (μV)	Difference (μV)	Error (%)
Channel X	+ Input	2000.1	0.23	0.01
Channel X	+ Input	200.27	0.27	0.13
Channel X	- Input	-199.76	0.04	-0.02
Channel Y	+ Input	2000.8	0.66	0.03
Channel Y	+ Input	199.56	-0.44	-0.22
Channel Y	- Input	-200.06	-0.16	0.08
Channel Z	+ Input	1999.4	-0.75	-0.04
Channel Z	+ Input	199.53	-0.57	-0.28
Channel Z	- Input	-201.06	-1.16	0.58

2. Common mode sensitivity

DASY measurement parameters: Auto Zero Time: 3 sec; Measuring time: 3 sec

	Common mode Input Voltage (mV)	High Range Average Reading (μV)	Low Range Average Reading (μV)
Channel X	200	17.87	16.44
	- 200	-15.36	-17.11
Channel Y	200	14.99	14.97
	- 200	-16.63	-16.47
Channel Z	200	-8.65	-8.74
	- 200	7.23	7.63

3. Channel separation

DASY measurement parameters: Auto Zero Time: 3 sec; Measuring time: 3 sec

	Input Voltage (mV)	Channel X (μV)	Channel Y (μV)	Channel Z (μV)
Channel X	200	-	4.37	-3.14
Channel Y	200	6.07	-	3.36
Channel Z	200	3.03	-0.24	-

4. AD-Converter Values with inputs shorted

DASY measurement parameters: Auto Zero Time: 3 sec; Measuring time: 3 sec

	High Range (LSB)	Low Range (LSB)
Channel X	15917	15639
Channel Y	16112	16210
Channel Z	16121	16322

5. Input Offset Measurement

DASY measurement parameters: Auto Zero Time: 3 sec; Measuring time: 3 sec

Input 10M Ω

	Average (μ V)	min. Offset (μ V)	max. Offset (μ V)	Std. Deviation (μ V)
Channel X	0.61	0.06	2.59	0.30
Channel Y	1.72	-0.56	3.01	0.39
Channel Z	-1.94	-2.73	-0.59	0.30

6. Input Offset Current

Nominal Input circuitry offset current on all channels: <25fA

7. Input Resistance (Typical values for information)

	Zeroing (kOhm)	Measuring (MOhm)
Channel X	200	200
Channel Y	200	200
Channel Z	200	200

8. Low Battery Alarm Voltage (Typical values for information)

Typical values	Alarm Level (VDC)
Supply (+ Vcc)	+7.9
Supply (- Vcc)	-7.6

9. Power Consumption (Typical values for information)

Typical values	Switched off (mA)	Stand by (mA)	Transmitting (mA)
Supply (+ Vcc)	+0.01	+6	+14
Supply (- Vcc)	-0.01	-8	-9



D4: SYSTEM VALIDATION DIPOLE



Accredited by the Swiss Accreditation Service (SAS)
The Swiss Accreditation Service is one of the signatories to the EA
Multilateral Agreement for the recognition of calibration certificates

Accreditation No.: **SCS 108**

Client **B.V. ADT (Auden)**

Certificate No: **D2450V2-716_Jan11**

CALIBRATION CERTIFICATE

Object **D2450V2 - SN: 716**

Calibration procedure(s) **QA CAL-05.v8
Calibration procedure for dipole validation kits**

Calibration date: **January 26, 2011**

This calibration certificate documents the traceability to national standards, which realize the physical units of measurements (SI).
The measurements and the uncertainties with confidence probability are given on the following pages and are part of the certificate.

All calibrations have been conducted in the closed laboratory facility: environment temperature $(22 \pm 3)^\circ\text{C}$ and humidity $< 70\%$.

Calibration Equipment used (M&TE critical for calibration)

Primary Standards	ID #	Cal Date (Certificate No.)	Scheduled Calibration
Power meter EPM-442A	GB37480704	06-Oct-10 (No. 217-01266)	Oct-11
Power sensor HP 8481A	US37292783	06-Oct-10 (No. 217-01266)	Oct-11
Reference 20 dB Attenuator	SN: 5086 (20g)	30-Mar-10 (No. 217-01158)	Mar-11
Type-N mismatch combination	SN: 5047.2 / 06327	30-Mar-10 (No. 217-01162)	Mar-11
Reference Probe ES3DV3	SN: 3205	30-Apr-10 (No. ES3-3205_Apr10)	Apr-11
DAE4	SN: 601	10-Jun-10 (No. DAE4-601_Jun10)	Jun-11
Secondary Standards	ID #	Check Date (in house)	Scheduled Check
Power sensor HP 8481A	MY41092317	18-Oct-02 (in house check Oct-09)	In house check: Oct-11
RF generator R&S SMT-06	100005	4-Aug-99 (in house check Oct-09)	In house check: Oct-11
Network Analyzer HP 8753E	US37390585 S4206	18-Oct-01 (in house check Oct-10)	In house check: Oct-11

Calibrated by:	Name	Function	Signature
	Dimce Iliev	Laboratory Technician	
Approved by:	Katja Pokovic	Technical Manager	

Issued: January 27, 2011

This calibration certificate shall not be reproduced except in full without written approval of the laboratory.



Accredited by the Swiss Accreditation Service (SAS)
The Swiss Accreditation Service is one of the signatories to the EA
Multilateral Agreement for the recognition of calibration certificates

Accreditation No.: **SCS 108**

Glossary:

TSL	tissue simulating liquid
ConvF	sensitivity in TSL / NORM x,y,z
N/A	not applicable or not measured

Calibration is Performed According to the Following Standards:

- IEEE Std 1528-2003, "IEEE Recommended Practice for Determining the Peak Spatial-Averaged Specific Absorption Rate (SAR) in the Human Head from Wireless Communications Devices: Measurement Techniques", December 2003
- IEC 62209-1, "Procedure to measure the Specific Absorption Rate (SAR) for hand-held devices used in close proximity to the ear (frequency range of 300 MHz to 3 GHz)", February 2005
- Federal Communications Commission Office of Engineering & Technology (FCC OET), "Evaluating Compliance with FCC Guidelines for Human Exposure to Radiofrequency Electromagnetic Fields; Additional Information for Evaluating Compliance of Mobile and Portable Devices with FCC Limits for Human Exposure to Radiofrequency Emissions", Supplement C (Edition 01-01) to Bulletin 65

Additional Documentation:

- DASY4/5 System Handbook

Methods Applied and Interpretation of Parameters:

- Measurement Conditions:* Further details are available from the Validation Report at the end of the certificate. All figures stated in the certificate are valid at the frequency indicated.
- Antenna Parameters with TSL:* The dipole is mounted with the spacer to position its feed point exactly below the center marking of the flat phantom section, with the arms oriented parallel to the body axis.
- Feed Point Impedance and Return Loss:* These parameters are measured with the dipole positioned under the liquid filled phantom. The impedance stated is transformed from the measurement at the SMA connector to the feed point. The Return Loss ensures low reflected power. No uncertainty required.
- Electrical Delay:* One-way delay between the SMA connector and the antenna feed point. No uncertainty required.
- SAR measured:* SAR measured at the stated antenna input power.
- SAR normalized:* SAR as measured, normalized to an input power of 1 W at the antenna connector.
- SAR for nominal TSL parameters:* The measured TSL parameters are used to calculate the nominal SAR result.

Measurement Conditions

DASY system configuration, as far as not given on page 1.

DASY Version	DASY5	V52.6
Extrapolation	Advanced Extrapolation	
Phantom	Modular Flat Phantom V5.0	
Distance Dipole Center - TSL	10 mm	with Spacer
Zoom Scan Resolution	dx, dy, dz = 5 mm	
Frequency	2450 MHz \pm 1 MHz	

Head TSL parameters

The following parameters and calculations were applied.

	Temperature	Permittivity	Conductivity
Nominal Head TSL parameters	22.0 °C	39.2	1.80 mho/m
Measured Head TSL parameters	(22.0 \pm 0.2) °C	37.9 \pm 6 %	1.74 mho/m \pm 6 %
Head TSL temperature during test	(20.5 \pm 0.2) °C	----	----

SAR result with Head TSL

SAR averaged over 1 cm ³ (1 g) of Head TSL	Condition	
SAR measured	250 mW input power	13.6 mW / g
SAR normalized	normalized to 1W	54.4 mW / g
SAR for nominal Head TSL parameters	normalized to 1W	54.8 mW /g \pm 17.0 % (k=2)

SAR averaged over 10 cm ³ (10 g) of Head TSL	condition	
SAR measured	250 mW input power	6.37 mW / g
SAR normalized	normalized to 1W	25.5 mW / g
SAR for nominal Head TSL parameters	normalized to 1W	25.5 mW /g \pm 16.5 % (k=2)

Body TSL parameters

The following parameters and calculations were applied.

	Temperature	Permittivity	Conductivity
Nominal Body TSL parameters	22.0 °C	52.7	1.95 mho/m
Measured Body TSL parameters	(22.0 ± 0.2) °C	52.5 ± 6 %	1.96 mho/m ± 6 %
Body TSL temperature during test	(20.8 ± 0.2) °C	----	----

SAR result with Body TSL

SAR averaged over 1 cm ³ (1 g) of Body TSL	Condition	
SAR measured	250 mW input power	13.4 mW / g
SAR normalized	normalized to 1W	53.6 mW / g
SAR for nominal Body TSL parameters	normalized to 1W	53.3 mW / g ± 17.0 % (k=2)

SAR averaged over 10 cm ³ (10 g) of Body TSL	condition	
SAR measured	250 mW input power	6.22 mW / g
SAR normalized	normalized to 1W	24.9 mW / g
SAR for nominal Body TSL parameters	normalized to 1W	24.8 mW / g ± 16.5 % (k=2)

Appendix

Antenna Parameters with Head TSL

Impedance, transformed to feed point	55.0 Ω + 2.1 j Ω
Return Loss	- 25.7 dB

Antenna Parameters with Body TSL

Impedance, transformed to feed point	50.1 Ω + 4.4 j Ω
Return Loss	- 27.2 dB

General Antenna Parameters and Design

Electrical Delay (one direction)	1.143 ns
----------------------------------	----------

After long term use with 100W radiated power, only a slight warming of the dipole near the feedpoint can be measured.

The dipole is made of standard semirigid coaxial cable. The center conductor of the feeding line is directly connected to the second arm of the dipole. The antenna is therefore short-circuited for DC-signals.

No excessive force must be applied to the dipole arms, because they might bend or the soldered connections near the feedpoint may be damaged.

Additional EUT Data

Manufactured by	SPEAG
Manufactured on	September 10, 2002

DASY5 Validation Report for Head TSL

Date/Time: 24.01.2011 13:05:38

Test Laboratory: SPEAG, Zurich, Switzerland

DUT: Dipole 2450 MHz; Type: D2450V2; Serial: D2450V2 - SN:716

Communication System: CW; Frequency: 2450 MHz; Duty Cycle: 1:1

Medium: HSL U12 BB

Medium parameters used: $f = 2450$ MHz; $\sigma = 1.75$ mho/m; $\epsilon_r = 38.1$; $\rho = 1000$ kg/m³

Phantom section: Flat Section

Measurement Standard: DASY5 (IEEE/IEC/ANSI C63.19-2007)

DASY5 Configuration:

- Probe: ES3DV3 - SN3205; ConvF(4.53, 4.53, 4.53); Calibrated: 30.04.2010
- Sensor-Surface: 3mm (Mechanical Surface Detection)
- Electronics: DAE4 Sn601; Calibrated: 10.06.2010
- Phantom: Flat Phantom 5.0 (front); Type: QD000P50AA; Serial: 1001
- Measurement SW: DASY52, V52.6.1 Build (408)
- Postprocessing SW: SEMCAD X, V14.4.2 Build (2595)

Pin=250 mW /d=10mm, dist=3.0mm (ES-Probe)/Zoom Scan (7x7x7) /Cube 0: Measurement grid: dx=5mm, dy=5mm, dz=5mm

Reference Value = 103.2 V/m; Power Drift = 0.05 dB

Peak SAR (extrapolated) = 27.976 W/kg

SAR(1 g) = 13.6 mW/g; SAR(10 g) = 6.37 mW/g

Maximum value of SAR (measured) = 17.366 mW/g

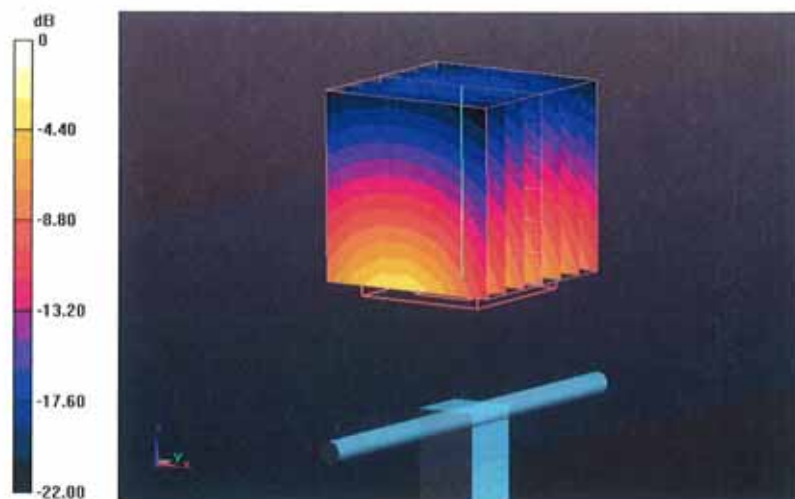

0 dB = 17.370mW/g

Impedance Measurement Plot for Head TSL

24 Jan 2011 10:25:33

CH1 S11 1 U FS 4: 55.020 Ω 2.0840 Ω 135.38 μH 2 450.000 000 MHz

*
De1
CA

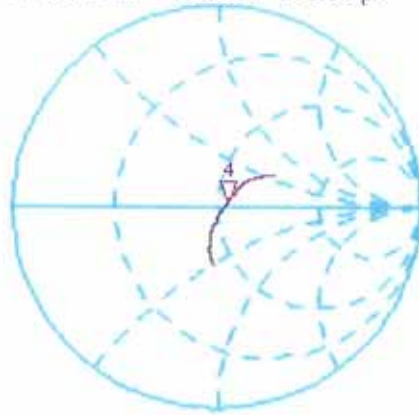

avg
16
↑

CH2 S11 LOG 5 dB/REF -20 dB 4: -25.719 dB 2 450.000 000 MHz

CA
avg
16
↑

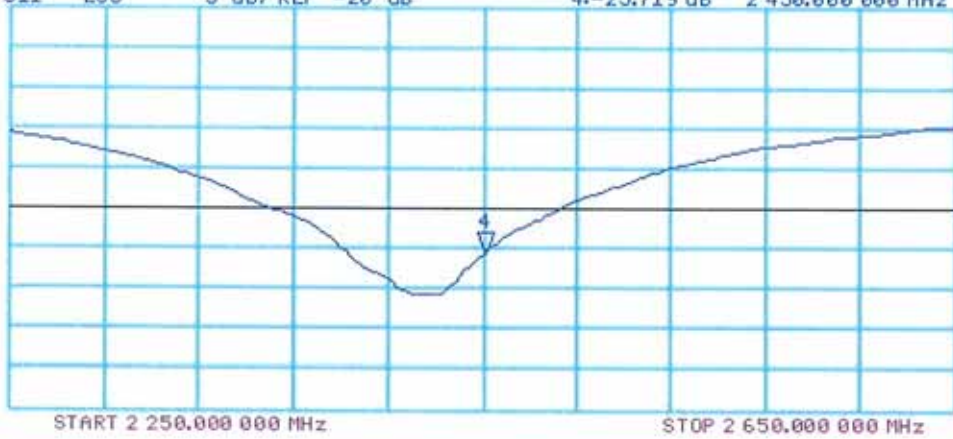

DASY5 Validation Report for Body TSL

Date/Time: 26.01.2011 13:56:41

Test Laboratory: SPEAG, Zurich, Switzerland

DUT: Dipole 2450 MHz; Type: D2450V2; Serial: D2450V2 - SN:716

Communication System: CW; Frequency: 2450 MHz; Duty Cycle: 1:1

Medium: MSL U12 BB

Medium parameters used: $f = 2450$ MHz; $\sigma = 1.97$ mho/m; $\epsilon_r = 52.7$; $\rho = 1000$ kg/m³

Phantom section: Flat Section

Measurement Standard: DASY5 (IEEE/IEC/ANSI C63.19-2007)

DASY5 Configuration:

- Probe: ES3DV3 - SN3205; ConvF(4.31, 4.31, 4.31); Calibrated: 30.04.2010
- Sensor-Surface: 3mm (Mechanical Surface Detection)
- Electronics: DAE4 Sn601; Calibrated: 10.06.2010
- Phantom: Flat Phantom 5.0 (back); Type: QD000P50AA; Serial: 1002
- Measurement SW: DASY52, V52.6.1 Build (408)
- Postprocessing SW: SEMCAD X, V14.4.2 Build (2595)

Pin=250 mW /d=10mm, dist=3.0mm (ES-Probe)/Zoom Scan (7x7x7) /Cube 0: Measurement grid: dx=5mm, dy=5mm, dz=5mm

Reference Value = 97.445 V/m; Power Drift = -0.06 dB

Peak SAR (extrapolated) = 28.276 W/kg

SAR(1 g) = 13.4 mW/g; SAR(10 g) = 6.22 mW/g

Maximum value of SAR (measured) = 17.680 mW/g

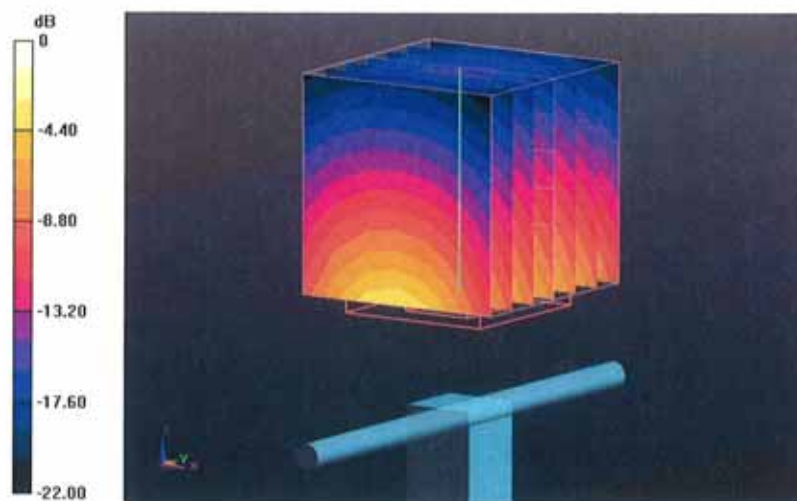

0 dB = 17.680mW/g

Impedance Measurement Plot for Body TSL

26 Jan 2011 10:53:07

CH1 S11 1 U FS 4: 50.141 Ω 4.3887 Ω 285.09 μH 2 450.000 000 MHz

*
Del

CA

avg
16

↑

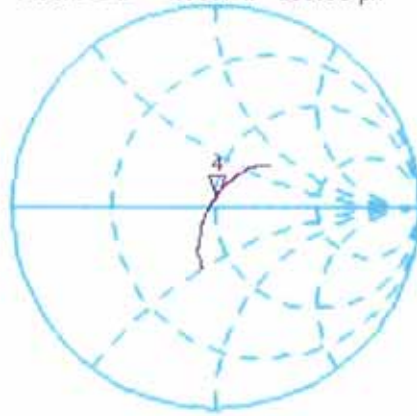

CH2 S11 LOG 5 dB/REF -20 dB 4:-27.158 dB 2 450.000 000 MHz

CA

avg
16

↑

