

FRONT OF DEVICE

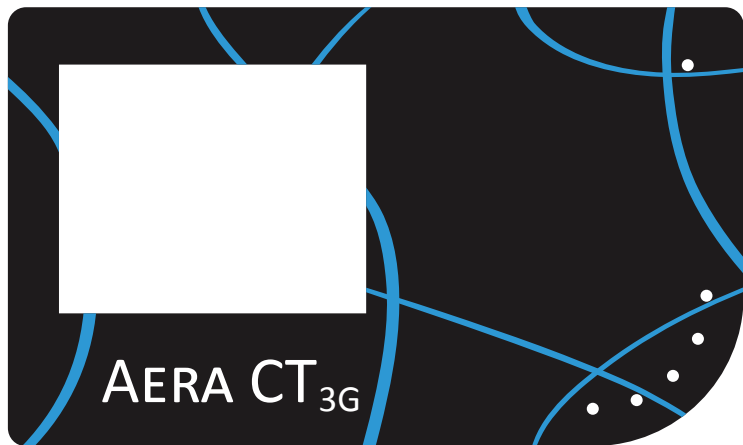

BACK OF DEVICE

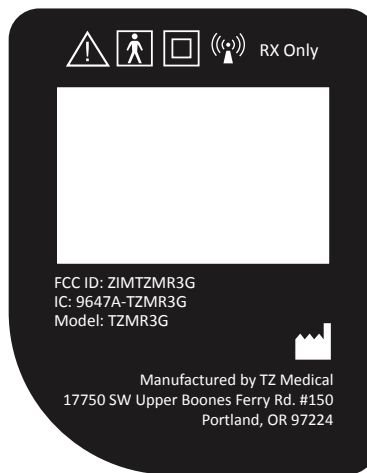

FRONT OF DEVICE

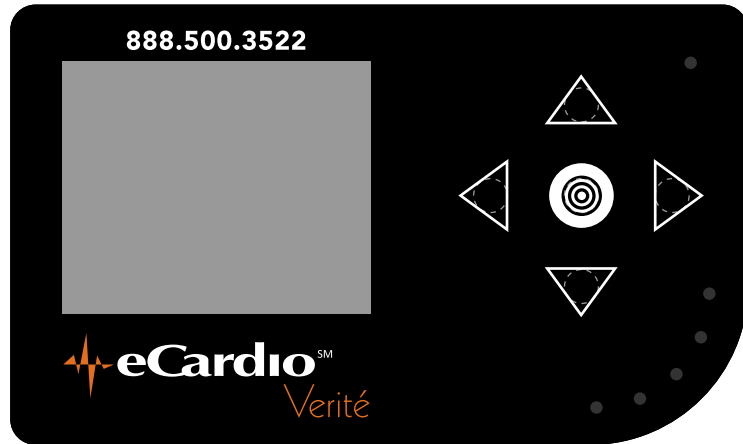

BACK OF DEVICE

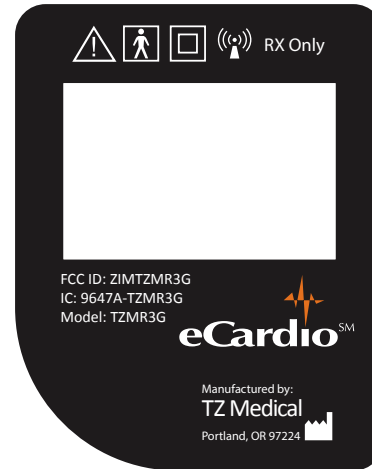

FRONT OF DEVICE



BACK OF DEVICE

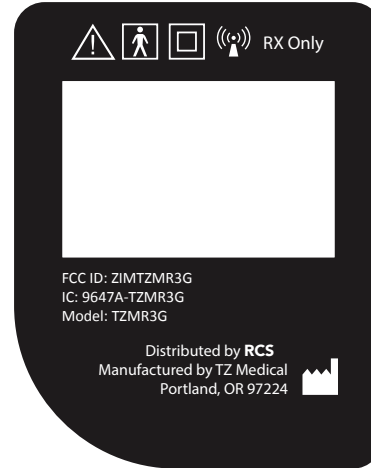

FRONT OF DEVICE

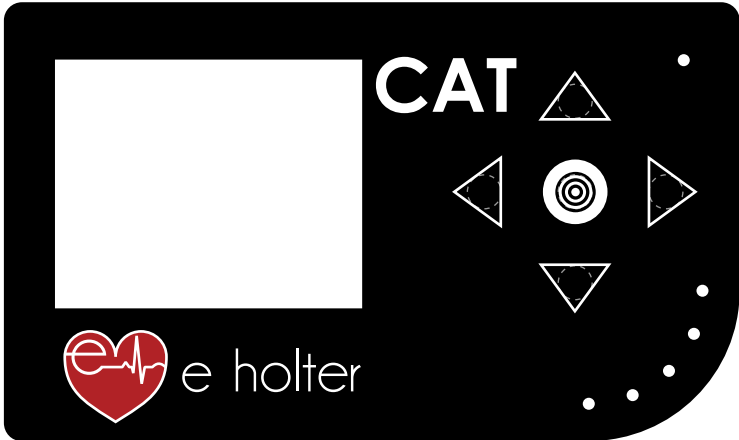

BACK OF DEVICE

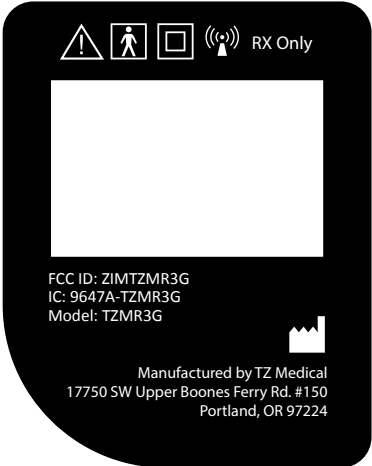

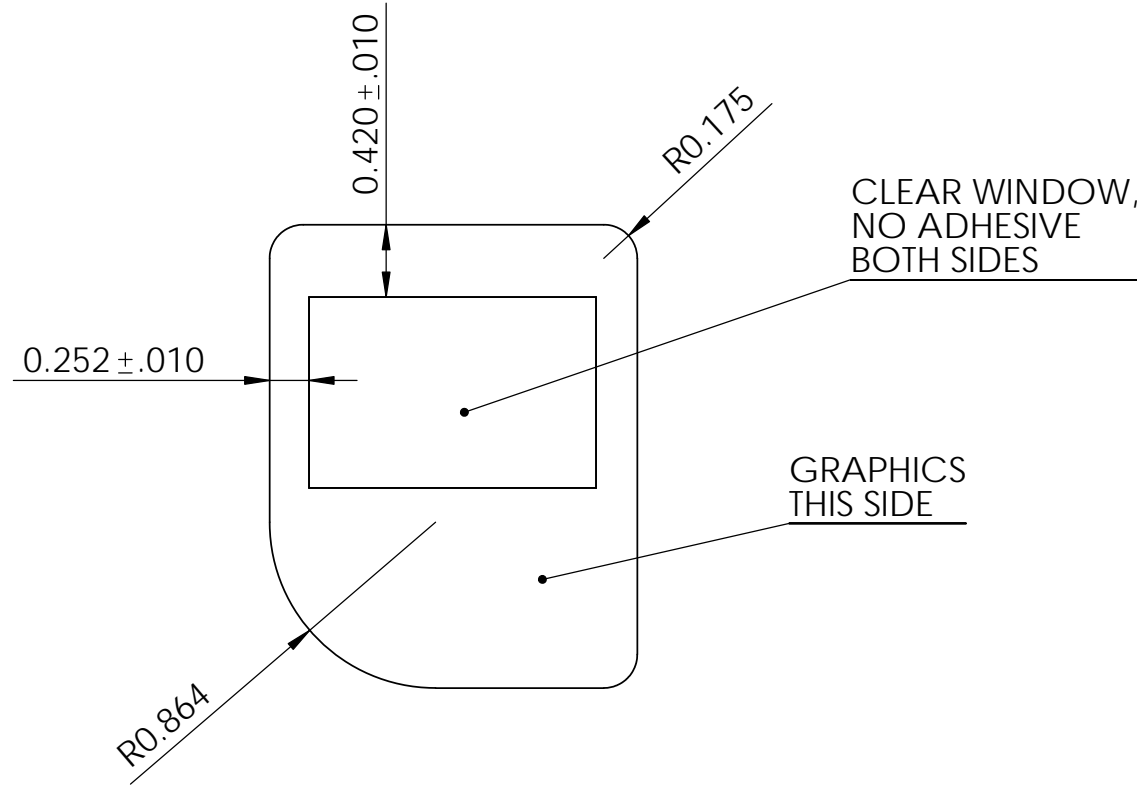

VENDOR:	Craftsman
VENDOR PART NUMBER:	7414-02

MATERIAL:
 0.10" clear Marnot XL Polycarbonate
 0.002" Adhesive: 3M 467MP
 Ruff Tex overprint

GRAPHICS:
 Refer to file# 10133 "Aera Labels" for printing graphics

**NOTE: THIS PART MUST COMPLY WITH THE
 COSMETIC STANDARD FOR FINISHED PARTS
 DOCUMENT # 11660**

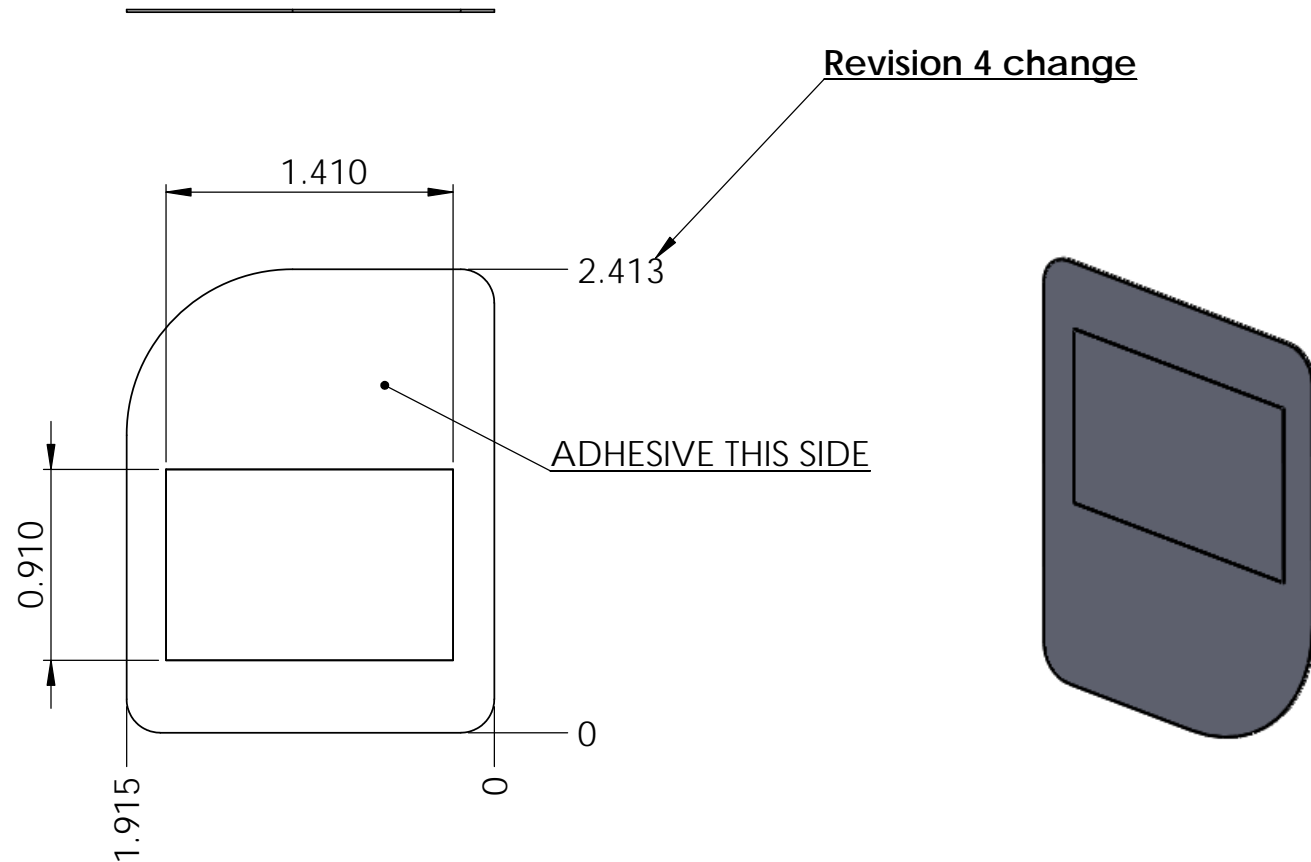

DRAWN BY: AH	UNLESS OTHERWISE SPECIFIED:	TZ Medical Inc. (503) 639-0282		
COMMENTS:	DIMENSIONS ARE IN INCHES TOLERANCES: FRACTIONAL ± 1/64 ANGULAR: MACH ± 0.5 BEND ± 1 TWO PLACE DECIMAL ± 0.01 THREE PLACE DECIMAL ± 0.001	TITLE: Bottom Label		
	INTERPRET GEOMETRIC TOLERANCING PER:	SIZE B	DWG. NO. 7414-02	REV 4
PROPRIETARY AND CONFIDENTIAL THE INFORMATION CONTAINED IN THIS DRAWING IS THE SOLE PROPERTY OF TZ MEDICAL INC. ANY REPRODUCTION IN PART OR AS A WHOLE WITHOUT THE WRITTEN PERMISSION OF TZ MEDICAL INC IS PROHIBITED.	MATERIAL: FINISH:	SCALE: 1:1	WEIGHT:	SHEET 2 OF 2
DO NOT SCALE DRAWING				

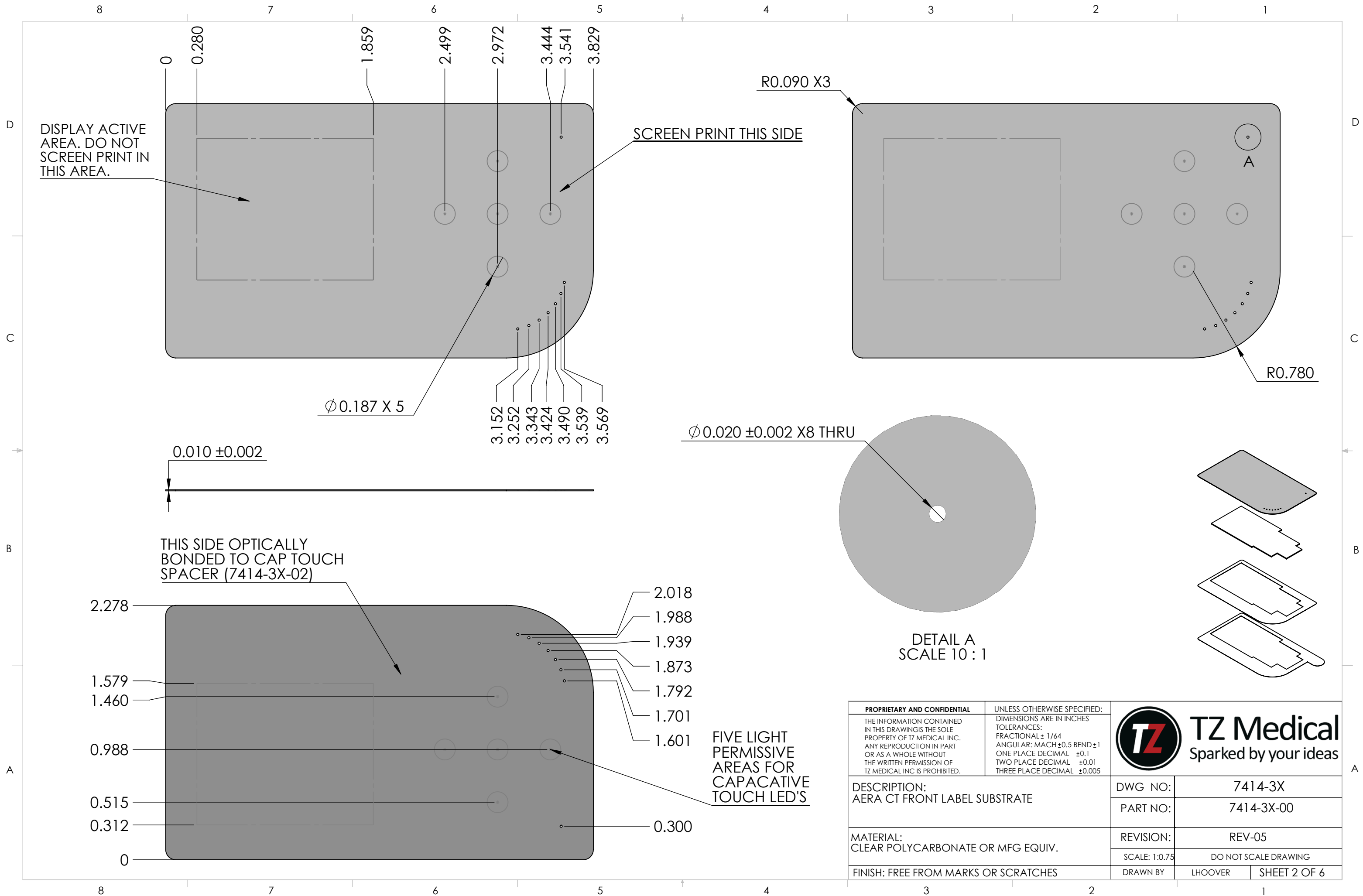

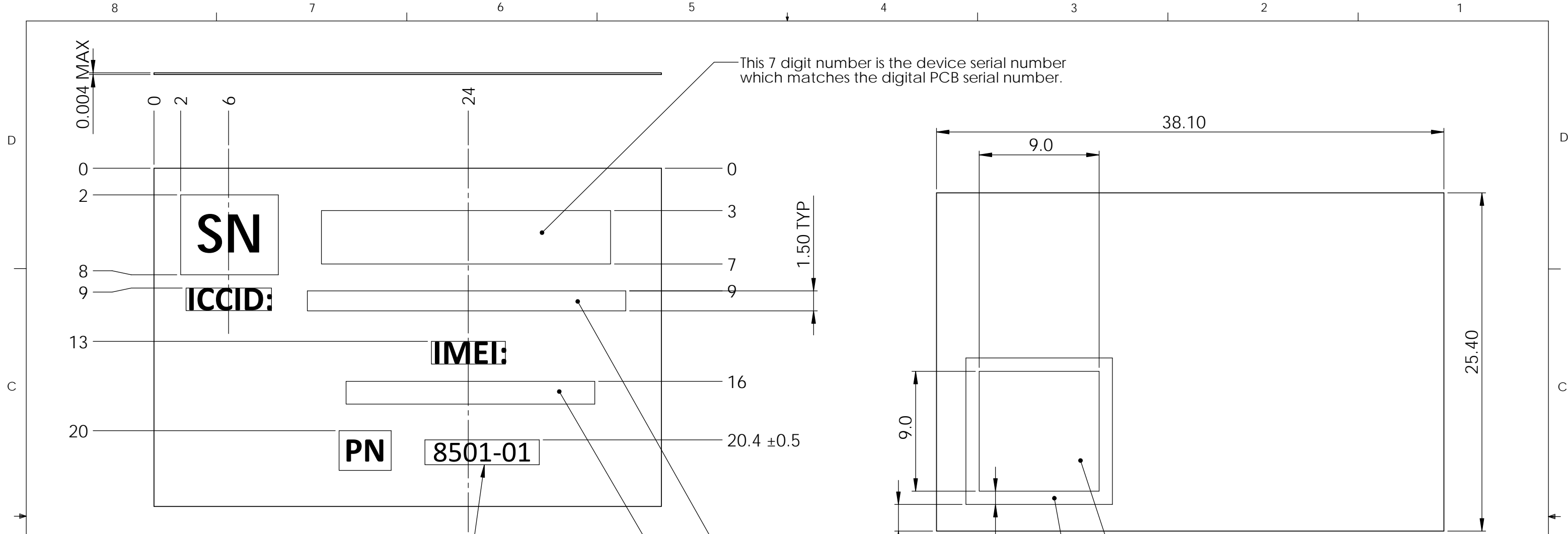

This is the TZ Medical finished part number
NOT the Aera CT Box Build part number

EXAMPLE SERIAL LABEL



WHITE TEXT ON A
BLACK BACKGROUND

Scannable 2D Barcode created in Semacode
with the following format (with no spaces):
SN;ICCID;IMEI;Model

White background behind the 2D barcode.

This 20 digit number is a unique identifier printed on each SIM card.
This field is used to identify which SIM card has been installed
in the finished device.

This 15 digit number is a unique identifier printed on each wireless module.
This field is used to identify which wireless module has been installed
in the finished device.

DRAWN BY: RW	UNLESS OTHERWISE SPECIFIED:	TZ Medical Inc. (503) 639-0282	
COMMENTS:	DIMENSIONS ARE IN MM TOLERANCES: FRACTIONAL ± 1/64 ANGULAR: MACH ± 0.5 BEND ± 1 WHOLE NUMBER: ± 0.5 ONE PLACE DECIMAL ± 0.1 TWO PLACE DECIMAL ± 0.01	TITLE: Serial Label	
	INTERPRET GEOMETRIC TOLERANCING PER:	SIZE B	DWG. NO. 7414-03
PROPRIETARY AND CONFIDENTIAL THE INFORMATION CONTAINED IN THIS DRAWING IS THE SOLE PROPERTY OF TZ MEDICAL INC. ANY REPRODUCTION IN PART OR AS A WHOLE WITHOUT THE WRITTEN PERMISSION OF TZ MEDICAL INC IS PROHIBITED.	MATERIAL DIRECT THERMAL ADHESIVE FINISH	REV B	WEIGHT:
DO NOT SCALE DRAWING		SHEET 23 OF 37	