

# RF Test Report

Test in accordance with  
Federal Communications Commission(FCC)  
CFR TITLE 47, Parts 2, 22, 24  
&  
Industry Canada (IC), RSS-GEN, 132,133

Product Name : PDS5-US  
Model No.: PDS5-US  
FCC ID : QIPPS5-US  
IC : 7830A-PDS5-US

Applicant : Gemalto M2M GmbH.  
Address : Siemensdamm 50 Berlin 13629 Germany

Date of Receipt : 01-30-2015  
Test Date : 01-31-2015~02-06-2015  
Issued Date : 02-06-2015  
Report No. : UL05420150130FCC/IC039-1  
Report Version : V1.0

**Notes:**

The test results only relate to these samples which have been tested.  
Partly using this report will not be admitted unless been allowed by Unilab.  
Unilab is only responsible for the complete report with the reported stamp of Unilab.

## Test Report Certification

Issued Date : 02-06-2015  
Report No. : UL05420150130FCC/IC039-1

Product Name : PDS5-US  
Applicant : Gemalto M2M GmbH.  
Address : Siemensdamm 50 Berlin 13629 Germany  
Manufacturer : Gemalto M2M GmbH.  
Address : Siemensdamm 50 Berlin 13629 Germany  
Model No. : PDS5-US  
EUT Voltage : MIN: 3.3V, NOR: 3.8V, MAX: 4.5V  
Brand Name : N/A  
FCC ID: QIPPDS5-US  
IC: 7830A-PDS5-US  
Applicable Standard : ANSI/TIA-603-C-2004; FCC CFR Title 47 Part 2;  
FCC CFR Title 47 Part 22 Subpart H;  
FCC CFR Title 47 Part24 Subpart E;  
RSS-GEN Issue 4; Industry Canada RSS-132, Issue 3;  
Industry Canada RSS-133, Issue 6;  
Test Result : Complied  
Performed Location : Unilab (Shanghai) Co., Ltd.  
FCC 2.948 register number is 714465  
IC register number is 11025A-1  
No. 1350, Lianxi Rd. Pudong New District, Shanghai, China  
TEL: +86-21-50275125 FAX: +86-21-50277862

Documented By :

*Andy Wei*

(Technical Engineer: Andy Wei)

Reviewed By :

*Forest Cao*

(Senior Engineer: Forest Cao)

Approved By :

*Eva Wang*

(Supervisor: Eva Wang)

## TABLE OF CONTENTS

SUMMARY OF TEST RESULT .....	4
1. General Information.....	5
1.1. EUT Description .....	5
1.2. Mode of Operation.....	6
1.3. Tested System Details.....	7
1.4. Configuration of Tested System .....	8
1.5. EUT Exercise Software.....	8
2. Technical Test .....	9
2.1. Test Environment .....	9
3. Peak Output Power.....	10
3.1. Test Equipment .....	10
3.2. Test Setup.....	10
3.3. Limit.....	11
3.4. Test Procedure .....	12
3.5. Uncertainty .....	12
3.6. Test Result .....	13
4. Spurious Emission .....	18
4.1. Test Equipment .....	18
4.2. Test Setup .....	18
4.3. Limit.....	19
4.4. Test Procedure .....	20
4.5. Uncertainty .....	20
4.6. Test Result .....	21
5. Receiver Spurious Emission for RSS 132/133.....	26
5.1. Test Equipment .....	26
5.2. Test Setup .....	26
5.3. Limit.....	27
5.4. Test Procedure .....	27
5.5. Uncertainty .....	28
5.6. Test Result .....	29
6. Spurious Emission At Antenna Terminals (+/- 1MHz).....	53
6.1. Test Equipment .....	53
6.2. Test Setup .....	53
6.3. Limit.....	54
6.4. Test Procedure .....	54
6.5. Uncertainty .....	54
6.6. Test Result .....	55
7. Attachment.....	61

## SUMMARY OF TEST RESULT

Report Section	SPECIFICATION		Description	Limit	Result
	FCC CFR 47	IC			
3	part2.1046	N/A	Conducted Output Power	N/A	PASS
3	part 22.913(a)(2)	RSS-132, 5.4	Effective Radiated Power	<7 Watts	PASS
3	part 24.232(c)	RSS-133, 6.4	Equivalent Isotropic Radiated Power	<2 Watts	PASS
4	part 2.1053 part 22.917(a) part 24.238(a)	RSS-GEN, 4.9 RSS-132, 5.5 RSS-133, 6.5 RSS-139, 6.5	Field Strength of Supurious Radiation	<43+10lg(P[Watts])	PASS
5	/	RSS-132,5.6 RSS-133,6.6	Receiver Spurious Emission	See section 5.3	PASS
6	part 2.1051 part 22.917(a) part 24.238(a)	RSS-132, 5.5 RSS-133, 6.5 RSS-139, 6.5	Band Edge Measurement	<43+10lg(P[Watts])	PASS

Note: The final design Rev2.x of PDS5-US products was a revision from last builds of PDS5-US Rev1.x. The variant builds took use of the same PCB layer-up, 2D drawing and the hardware core. The schematics of RF part as well as the major logic unit were kept unchanged. The noticeable minor change from PDS5-US Rev 1.x is the “emergency off circuit” added onto Rev2.x. The noticeable minor change from PDS5-US Rev 1.x is the “emergency off circuit” added onto Rev2.x., and the Hardware Version from A2.1 to B2.1, Software Version from 03.000 to 03.001, so Unilab perform four RF test items for PDS5-US in the test report.

## 1. General Information

### 1.1. EUT Description

Product Name:	PDS5-US
Model Name:	PDS5-US
Hardware Version:	B2.1
Software Version:	03.001
RF Exposure Environment:	Uncontrolled
<b>GSM/ EDGE</b>	
Support Band:	GSM850/PCS1900
GPRS/EDGE Class:	12
Tx Frequency Range:	GSM 850: 824.2MHz to 848.8MHz PCS 1900: 1850.2MHz to 1909.8MHz
Rx Frequency Range:	GSM 850: 869.2MHz to 893.8MHz PCS 1900: 1930.2MHz to 1989.8MHz
Type of modulation:	GSM/GPRS for GMSK EDGE for 8PSK
Antenna Type:	Connector
Antenna Peak Gain:	GSM 850:2.15dBi PCS 1900: 2.15dBi
<b>WCDMA</b>	
Support Band:	WCDMA Band II
Tx Frequency Range:	WCDMA Band II : 1850MHz ~1910MHz
Rx Frequency Range:	WCDMA Band II : 1930MHz ~1990MHz
Type of modulation:	WCDMA(UMTS): QPSK
Antenna Type:	Connector
Antenna Peak Gain:	WCDMA Band II : 2.15dBi
Support Band:	WCDMA Band V
Tx Frequency Range:	WCDMA Band V: 824MHz ~849MHz
Rx Frequency Range:	WCDMA Band V: 869MHz ~894MHz
Type of modulation:	WCDMA(UMTS): QPSK
Antenna Type:	Connector
Antenna Peak Gain:	WCDMA Band V: 2.15dBi

## 1.2. Mode of Operation

Unilab has verified the construction and function in typical operation. EUT is inlink mode with base station emulator at maximum power level. All the test modes were carried out with the EUT in normal operation, which was shown in this test report is the worst test mode and defined as:

Test Mode		
Band	Radiated TCs	Conducted TCs
GSM 850	GSM Link EDGE 8 Link	GSM Link EDGE 8 Link
GSM1900	GSM Link EDGE 8 Link	GSM Link EDGE 8 Link
WCDMA Band V	RMC 12.2Kbps Link	RMC 12.2Kbps Link
WCDMA Band II	RMC 12.2Kbps Link	RMC 12.2Kbps Link

Note:

1. Regards to the frequency band operation: the lowest, middle and highest frequency of channel were selected to perform the test, then shown on this report.
2. The maximum power levels are GSM for GMSK link, EDGE multi-slot class 8 mode for 8PSK link, RMC 12.2Kbps mode for WCDMA Band V and RMC 12.2Kbps mode for WCDMA Band II, only these modes were used for all tests.
3. For the ERP/EIRP and radiated emission test, every axis (X, Y, Z) was verified, and show the worst (Z axis) result on this report.

**The conducted power table is as follows:**

Conducted Power (Unit: dBm)						
Band	GSM 850			GSM 1900		
Channel	128	189	251	512	661	810
Frequency	824.2	836.4	848.8	1850.2	1880	1909.8
GSM (GMSK, 1 Tx slot) CS1	32.70	32.62	32.47	29.51	29.57	29.65
GPRS (GMSK, 1 Tx slot) CS1	32.67	32.59	32.44	29.48	29.53	29.62
GPRS (GMSK, 2 Tx slot) CS1	29.77	29.67	29.53	26.43	26.46	26.54
GPRS (GMSK, 3 Tx slot) CS1	27.83	27.73	27.60	24.59	24.63	24.71
GPRS (GMSK, 4 Tx slot) CS1	26.72	26.65	26.46	23.38	23.40	23.47
EDGE (8-PSK, 1 Tx slot) CS1	26.76	26.57	26.23	25.22	25.18	25.38
EDGE (8-PSK, 2 Tx slot) CS1	24.28	24.33	24.11	22.17	22.34	22.27
EDGE(8-PSK, 3 Tx slot) CS1	22.08	22.10	22.35	20.56	20.73	20.74
EDGE(8-PSK, 4 Tx slot) CS1	21.01	20.64	20.59	19.13	19.28	19.08

Band	WCDMA V			WCDMA II		
TX Channel	4132	4182	4233	9262	9400	9538
RX Channel	4357	4407	4458	9662	9800	9938
Frequency	826.4	836.4	846.6	1852.4	1880	1907.6
RMC 12.2Kbps	23.96	24.00	23.80	24.11	23.58	23.42
AMC 12.2Kbps	23.93	24.02	23.78	24.08	23.55	23.40
HSDPA Subtest-1	23.86	23.91	23.73	23.95	23.51	23.52
HSDPA Subtest-2	23.43	23.56	23.31	23.01	22.97	22.91
HSDPA Subtest-3	22.97	23.06	22.90	22.49	22.46	22.53
HSDPA Subtest-4	22.51	22.63	22.48	22.08	21.99	22.06
HSUPA Subtest-1	23.89	23.93	23.95	24.11	23.57	23.48
HSUPA Subtest-2	23.42	23.44	23.48	23.57	23.46	23.54
HSUPA Subtest-3	22.36	22.52	22.63	22.67	22.40	22.45
HSUPA Subtest-4	21.78	21.86	21.71	21.85	21.82	21.94

### 1.3. Tested System Details

The types for all equipments, plus descriptions of all cables used in the tested system (including inserted cards) are:

Product	Manufacturer	Model	Serial No.	Power Cord
1   Agilent8960	Agilent	E5515C	GB46581718	N/A

### 1.4. Configuration of Tested System

Connection Diagram

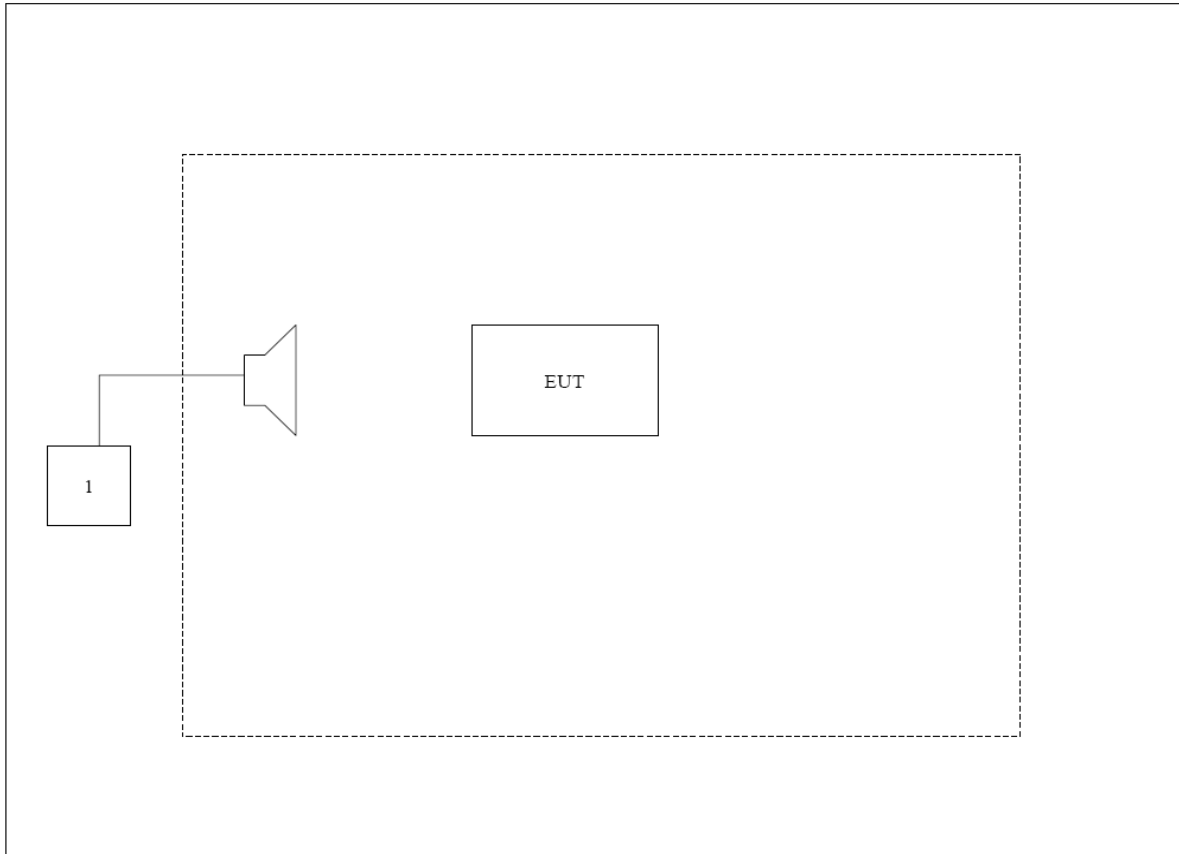

### 1.5. EUT Exercise Software

1	Setup the EUT and simulators as shown on above.
2	Turn on the power of all equipment.
3	EUT Communicate with E5515C, then select channel to test.



## 2. Technical Test

### 2.1. Test Environment

Items	Required (IEC 68-1)	Actual
Temperature (°C)	15-35	25
Humidity (%RH)	25-75	53
Barometric pressure (mbar)	860-1060	950-1000

### 3. Peak Output Power

#### 3.1. Test Equipment

Instrument	Manufacturer	Model	Serial No.	Cali. Due Date
Spectrum Analyzer	Agilent	N9038A	MY51210142	07/27/2015
Radio Communication Tester	Agilent	E5515C	GB46581718	10/23/2015
Signal Generator	Agilent	N5183A	MY50140938	01/02/2016
Preamplifier	CEM	EM30180	3008A0245	02/28/2015
DC Power Supply	Agilent	6612C	MY43002989	03/03/2015
Bilog Antenna	Schwarzbeck	VULB9160	9160-3316	07/19/2015
VHF-UHF-Biconical Antenna	Schwarzbeck	VUBA9117	9117-263	07/19/2015
Broad-Band Horn Antenna	Schwarzbeck	BBHA9120D	9120D-942	07/19/2015
Broad-Band Horn Antenna	Schwarzbeck	BBHA9120D	9120D-943	07/19/2015

The measure equipment had been calibrated once a year.

#### 3.2. Test Setup

Conducted Power Measurement:

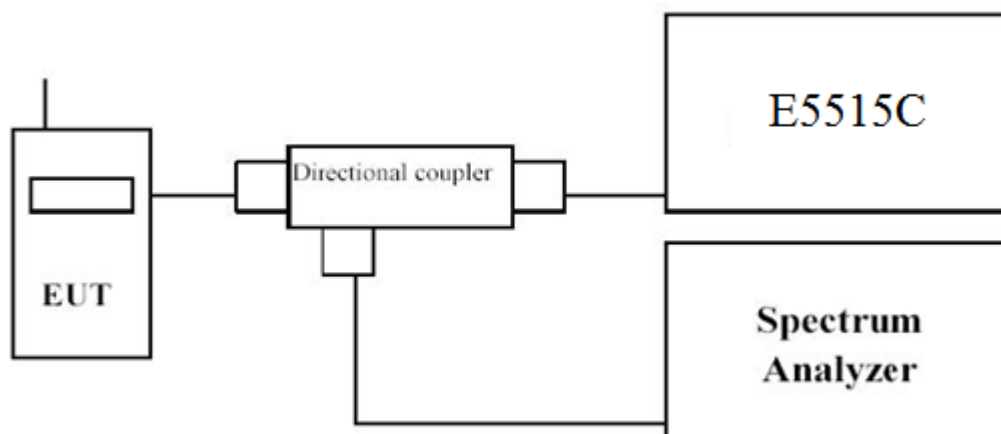

Radiated Spurious Measurement: below 1GHz

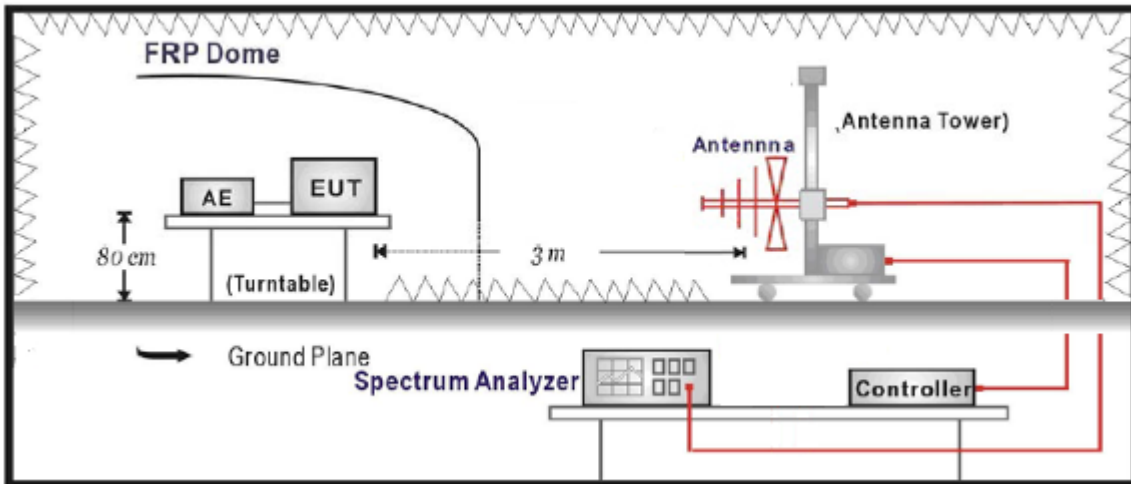

Radiated Spurious Measurement: above 1GHz

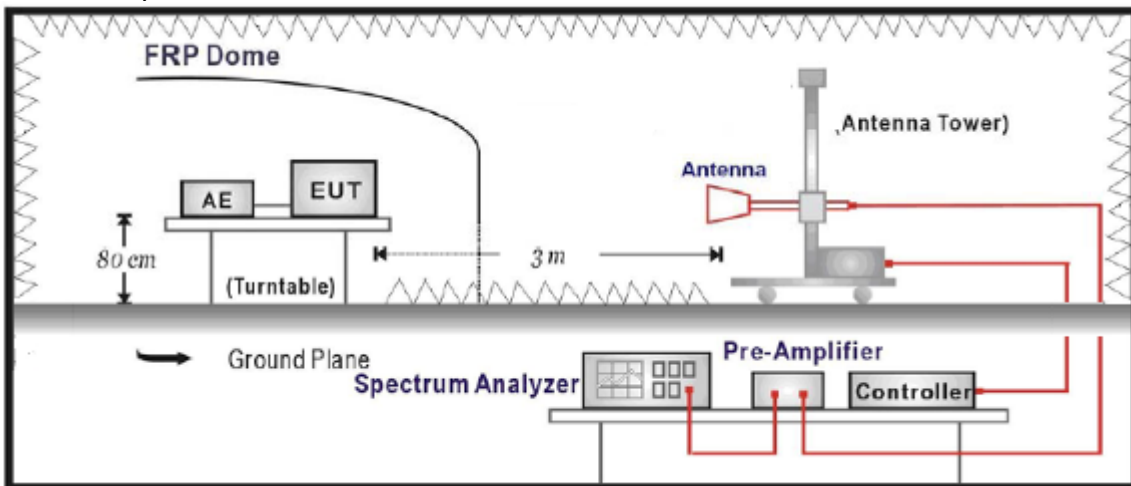

### 3.3. Limit

**For FCC Part 22.913(a)(2):**

The ERP of mobile transmitters and auxiliary test transmitters must not exceed 7 Watts.

**For FCC Part 24.232(c):**

The EIRP of mobile transmitters and auxiliary test transmitters must not exceed 2 Watts.

### 3.4. Test Procedure

#### **Conducted Power Measurement:**

- a. Place the EUT on a bench and set it in transmitting mode.
- b. Connect a low loss RF cable from the antenna port to a spectrum analyzer and E5515C by a Directional Couple.
- c. EUT Communicate with E5515C, then selects a channel for testing.
- d. Add a correction factor to the display of spectrum, and then test.

#### **Radiated Power Measurement:**

- a. The EUT shall be placed at the specified height on a support, and in the position closest to normal use as declared by provider.
- b. The test antenna shall be oriented initially for vertical polarization and shall be chosen to correspond to the frequency of the transmitter
- c. The output of the test antenna shall be connected to the measuring receiver.
- d. The transmitter shall be switched on and the measuring receiver shall be tuned to the frequency of the transmitter under test.
- e. The test antenna shall be raised and lowered through the specified range of height until a maximum signal level is detected by the measuring receiver.
- f. The transmitter shall then be rotated through 360° in the horizontal plane, until the maximum signal level is detected by the measuring receiver.
- g. The test antenna shall be raised and lowered again through the specified range of height until a maximum signal level is detected by the measuring receiver.
- h. The maximum signal level detected by the measuring receiver shall be noted.
- i. The transmitter shall be replaced by a substitution antenna.
- j. The substitution antenna shall be orientated for vertical polarization and the length of the substitution antenna shall be adjusted to correspond to the frequency of the transmitter.
- k. The substitution antenna shall be connected to a calibrated signal generator.
- l. If necessary, the input attenuator setting of the measuring receiver shall be adjusted in order to increase the sensitivity of the measuring receiver.
- m. The test antenna shall be raised and lowered through the specified range of height to ensure that the maximum signal is received.
- n. The input signal to the substitution antenna shall be adjusted to the level that produces a level detected by the measuring receiver, that is equal to the level noted while the transmitter radiated power was measured, corrected for the change of input attenuator setting of the measuring receiver.
- o. The measurement shall be repeated with the test antenna and the substitution antenna orientated for horizontal polarization.
- p. The measure of the effective radiated power is the larger of the two levels recorded at the input to the substitution antenna, corrected for gain of the substitution antenna if necessary.
- q. Test site anechoic chamber refer to ANSI C63.4: 2009.

### 3.5. Uncertainty

The measurement uncertainty is defined as for Conducted Power Measurement  $\pm 1.1$  dB,  
for Radiated Power Measurement  $\pm 3.1$  dB

### 3.6. Test Result

The following table shows the conducted power measured:

Table 1

GSM850				
Modes	Channel	Frequency (MHz)	Conducted Power (dBm)	Conducted Power (W)
GSM850 (GSM)	128(Low)	824.2	32.70	1.86
	189(Mid)	836.4	32.62	1.83
	251(High)	848.8	32.47	1.77
GSM850 (EDGE 8)	128(Low)	824.2	26.76	0.47
	189(Mid)	836.4	26.57	0.45
	251(High)	848.8	26.23	0.42

Table 2

GSM1900				
Modes	Channel	Frequency (MHz)	Conducted Power (dBm)	Conducted Power (W)
GSM1900 (GSM)	512(Low)	1850.2	29.51	0.89
	661(Mid)	1880.0	29.57	0.91
	810(High)	1909.8	29.65	0.92
GSM1900 (EDGE 8)	512(Low)	1850.2	25.22	0.33
	661(Mid)	1880.0	25.18	0.33
	810(High)	1909.8	25.38	0.35

Table 3

WCDMA				
Modes	Channel	Frequency (MHz)	Conducted Power (dBm)	Conducted Power (W)
WCDMA Band V	4132(Low)	826.4	23.96	0.25
	4182(Mid)	836.4	24.02	0.25
	4233(High)	846.6	23.80	0.24
WCDMA Band II	9262(Low)	1852.4	24.11	0.26
	9400(Mid)	1880.0	23.58	0.23
	9538(High)	1907.6	23.42	0.22

the following table shows the Radiated power measured :

GSM850 (GSM Link)

Frequency (MHz)	Ant. Pol. (H/V)	SG Reading (dBm)	Cable Loss (dB)	Gain (dBd)	ERP (dBm)	ERP (W)
Low Channel 128 (824.20MHz)						
824.2	H	39.15	3.83	-2.99	32.33	1.71
824.2	V	38.41	3.83	-2.99	31.59	1.44
Middle Channel 189 (836.40MHz)						
836.4	H	39.96	3.96	-3.04	32.45	1.56
836.4	V	38.25	3.96	-3.04	31.25	1.33
High Channel 251 (848.80MHz)						
848.8	H	39.45	3.97	-3.10	32.38	1.73
848.8	V	38.68	3.97	-3.10	31.61	1.45

GSM850 (EDGE 8 Link)

Frequency (MHz)	Ant. Pol. (H/V)	SG Reading (dBm)	Cable Loss (dB)	Gain (dBd)	ERP (dBm)	ERP (W)
Low Channel 128 (824.20MHz)						
824.2	H	33.46	3.83	-2.99	26.64	0.46
824.2	V	32.27	3.83	-2.99	25.45	0.35
Middle Channel 189 (836.40MHz)						
836.4	H	33.38	3.96	-3.04	26.38	0.43
836.4	V	32.31	3.96	-3.04	25.31	0.40
High Channel 251 (848.80MHz)						
848.8	H	33.62	3.97	-3.10	26.55	0.45
848.8	V	32.45	3.97	-3.10	25.38	0.35

GSM1900 (GSM Link)

Frequency (MHz)	Ant. Pol. (H/V)	SG Reading (dBm)	Cable Loss (dB)	Gain (dBi)	EIRP (dBm)	EIRP (W)
Low Channel 512(1850.20MHz)						
1850.2	H	25.48	6.26	10.40	29.62	0.92
1850.2	V	24.24	6.26	10.40	28.38	0.69
Middle Channel 661 (1880.00MHz)						
1880.0	H	25.23	6.19	10.43	29.47	0.89
1880.0	V	24.22	6.19	10.43	28.46	0.70
High Channel 810 (1909.80MHz)						
1909.8	H	25.28	6.15	10.44	29.57	0.91
1909.8	V	24.32	6.15	10.44	28.61	0.73

GSM1900 (EDGE 8 Link)

Frequency (MHz)	Ant. Pol. (H/V)	SG Reading (dBm)	Cable Loss (dB)	Gain (dBi)	EIRP (dBm)	EIRP (W)
Low Channel 512(1850.20MHz)						
1850.2	H	20.98	6.26	10.40	25.12	0.33
1850.2	V	20.17	6.26	10.40	24.31	0.27
Middle Channel 661 (1880.00MHz)						
1880.0	H	20.89	6.19	10.43	25.13	0.32
1880.0	V	20.02	6.19	10.43	24.26	0.27
High Channel 810 (1909.80MHz)						
1909.8	H	21.06	6.15	10.44	25.35	0.34
1909.8	V	20.09	6.15	10.44	24.38	0.27



WCDMA Band V

Frequency (MHz)	Ant. Pol. (H/V)	SG Reading (dBm)	Cable Loss (dB)	Gain (dBd)	ERP (dBm)	ERP (W)
Low Channel 4132(826.4MHz)						
826.4	H	30.82	3.83	-2.99	24.00	0.27
826.4	V	29.13	3.83	-2.99	22.31	0.17
Middle Channel 4182 (836.4MHz)						
836.4	H	31.05	3.96	-3.04	24.05	0.25
836.4	V	30.1	3.96	-3.04	23.10	0.20
High Channel 4233 (846.6MHz)						
846.6	H	30.99	3.97	-3.10	23.92	0.25
846.6	V	29.12	3.97	-3.10	22.05	0.16

WCDMA Band II

Frequency (MHz)	Ant. Pol. (H/V)	SG Reading (dBm)	Cable Loss (dB)	Gain (dBi)	EIRP (dBm)	EIRP (W)
Low Channel 9262(1852.40MHz)						
1850.2	H	20.04	6.26	10.40	24.18	0.26
1850.2	V	19.08	6.26	10.40	23.22	0.21
Middle Channel 9400 (1880.00MHz)						
1880.0	H	19.38	6.19	10.43	23.62	0.23
1880.0	V	18.22	6.19	10.43	22.46	0.18
High Channel 9538 (1907.60MHz)						
1909.8	H	19.27	6.15	10.44	23.56	0.23
1909.8	V	18.12	6.15	10.44	22.41	0.17

## 4.Spurious Emission

### 4.1. Test Equipment

Instrument	Manufacturer	Model	Serial No.	Cali. Due Date
Spectrum Analyzer	Agilent	N9038A	MY51210142	07/27/2015
Radio Communication Tester	Agilent	E5515C	GB46581718	10/23/2015
Signal Generator	Agilent	N5183A	MY50140938	01/02/2016
Preamplifier	CEM	EM30180	3008A0245	02/28/2015
Loop Antenna	Schwarzbeck	FMZB1519	1519-020	03/26/2015
Bilog Antenna	Schwarzbeck	VULB9160	9160-3316	07/19/2015
VHF-UHF-Biconical Antenna	Schwarzbeck	VUBA9117	9117-263	07/19/2015
Broad-Band Horn Antenna	Schwarzbeck	BBHA9120D	9120D-942	07/19/2015
Broad-Band Horn Antenna	Schwarzbeck	BBHA9120D	9120D-943	07/19/2015

The measure equipment had been calibrated once a year.

### 4.2. Test Setup

Radiated Spurious Measurement: below 30MHz

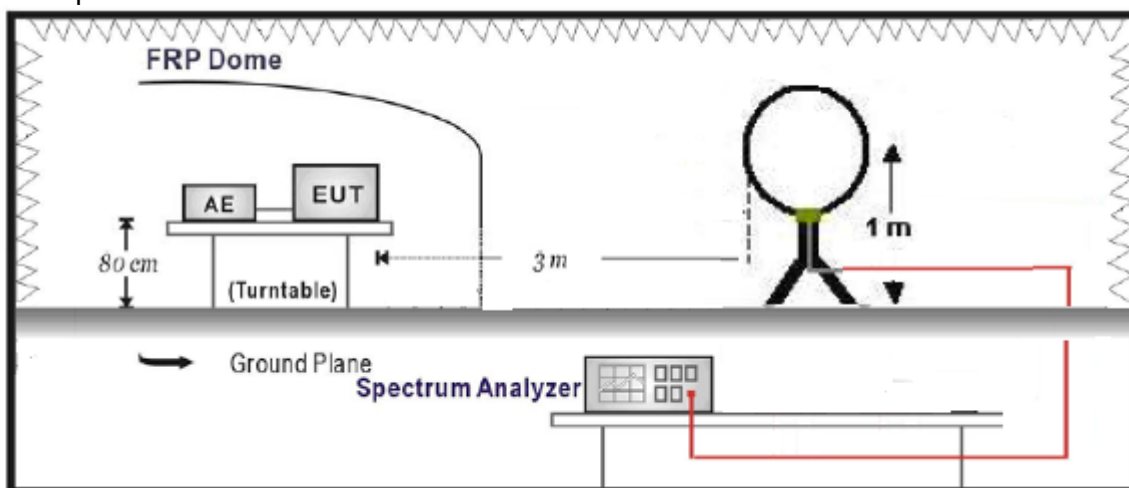

Radiated Spurious Measurement: 30MHz to 1GHz

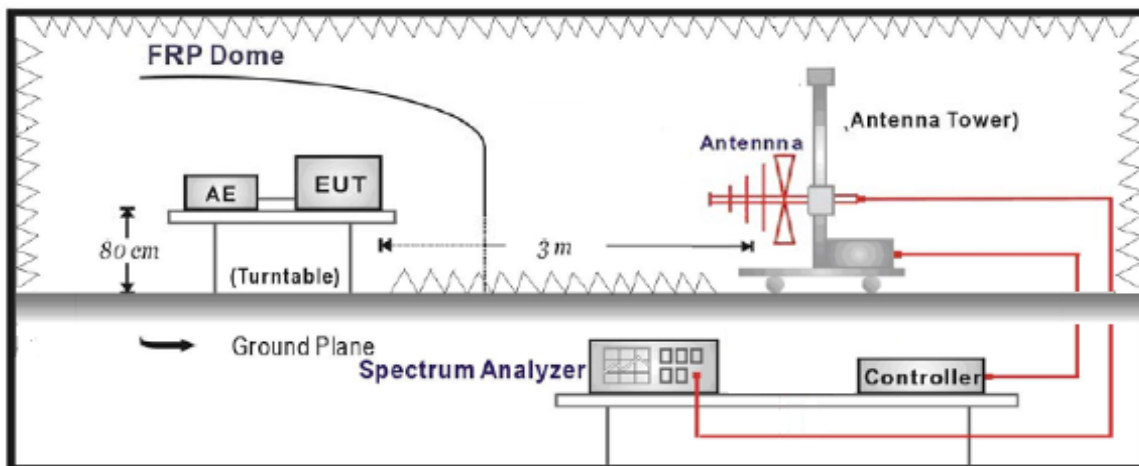

Radiated Spurious Measurement: above 1GHz

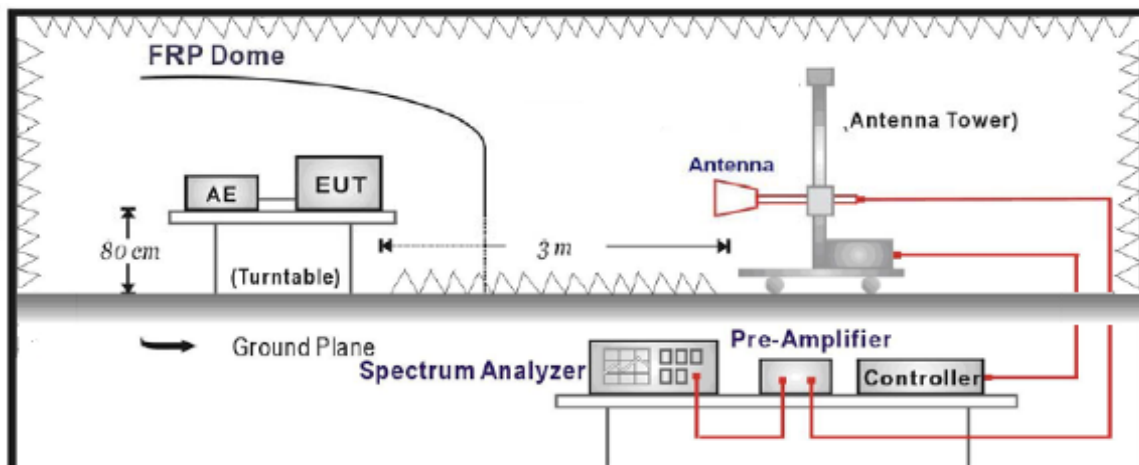

**4.3. Limit**

The power of any emission outside of the authorized operating frequency ranges must be attenuated below the transmitting power (P) by a factor of at least  $43 + 10\log(P)$  dB.

#### 4.4. Test Procedure

##### **Radiated Spurious Measurement:**

- a. The EUT shall be placed at the specified height on a support, and in the position closest to normal use as declared by provider.
- b. The test antenna shall be oriented initially for vertical polarization and shall be chosen to correspond to the frequency of the transmitter
- c. The output of the test antenna shall be connected to the measuring receiver. The transmitter shall be switched on and the measuring receiver shall be tuned to the frequency of the transmitter under test.
- d. The test antenna shall be raised and lowered through the specified range of height until a maximum signal level is detected by the measuring receiver.
- e. The transmitter shall then be rotated through 360° in the horizontal plane, until the maximum signal level is detected by the measuring receiver.
- f. The test antenna shall be raised and lowered again through the specified range of height until a maximum signal level is detected by the measuring receiver.
- h. The maximum signal level detected by the measuring receiver shall be noted.
- i. The transmitter shall be replaced by a substitution antenna.
- j. The substitution antenna shall be orientated for vertical polarization and the length of the substitution antenna shall be adjusted to correspond to the frequency of the transmitter.
- k. The substitution antenna shall be connected to a calibrated signal generator.
- l. If necessary, the input attenuator setting of the measuring receiver shall be adjusted in order to increase the sensitivity of the measuring receiver.
- m. The test antenna shall be raised and lowered through the specified range of height to ensure that the maximum signal is received.
- n. The input signal to the substitution antenna shall be adjusted to the level that produces a level detected by the measuring receiver, that is equal to the level noted while the transmitter radiated power was measured, corrected for the change of input attenuator setting of the measuring receiver.
- o. The measurement shall be repeated with the test antenna and the substitution antenna orientated for horizontal polarization.
- p. The measure of the effective radiated power is the larger of the two levels recorded at the input to the substitution antenna, corrected for gain of the substitution antenna if necessary.
- q. The frequency range was checked up to 10<sup>th</sup> harmonic.
- r. Test site anechoic chamber refer to ANSI/TIA-603-C-2004.

#### 4.5. Uncertainty

The measurement uncertainty is defined as 3.2 dB for Radiated Power Measurement.

## 4.6. Test Result

### Radiated Spurious Measurement:

#### GSM850 (GSM Link), 9KHz to 30MHz

The low frequency, which started from 9KHz to 30MHz, was pre-scanned and the result which was 20dB lower than the limit line, and that was not reported per 2.1057 (c).

#### GSM850 (GSM Link), 30MHz to 1GHz

Frequency (MHz)	Ant. Pol. (H/V)	SG Reading (dBm)	Cable Loss (dB)	Gain (dBd)	ERP (dBm)	Limit (dBm)	Margin (dB)
Middle Channel 189 (836.40MHz)							
686	H	-44.34	3.08	-2.81	-50.23	-13.00	-37.23
686	V	-41.23	3.08	-2.81	-47.12	-13.00	-34.12

#### GSM850 (GSM Link), Above 1GHz

Frequency (MHz)	Ant. Pol. (H/V)	SG Reading (dBm)	Cable Loss (dB)	Gain (dBd)	ERP (dBm)	Limit (dBm)	Margin (dB)
Middle Channel 189 (836.40MHz)							
1672.8	H	-44.13	6.13	-2.59	-52.85	-13.00	-39.85
1672.8	V	-43.82	6.13	-2.59	-52.54	-13.00	-39.54
2509.2	H	-53.5	7.32	-2.86	-63.68	-13.00	-50.68
2509.2	V	-51.06	7.32	-2.86	-61.24	-13.00	-48.24

**GSM850 (EDGE 8 Link), 9KHz to 30MHz**

The low frequency, which started from 9KHz to 30MHz, was pre-scanned and the result which was 20dB lower than the limit line, and that was not reported per 2.1057 (c).

**GSM850 (EDGE 8 Link), 30MHz to 1GHz**

Frequency (MHz)	Ant. Pol. (H/V)	SG Reading (dBm)	Cable Loss (dB)	Gain (dBd)	ERP (dBm)	Limit (dBm)	Margin (dB)
Middle Channel 189 (836.40MHz)							
692	H	-45.05	3.11	-2.82	-50.98	-13.00	-37.98
692	V	-43.74	3.11	-2.82	-49.67	-13.00	-36.67

**GSM850 (EDGE 8 Link), Above 1GHz**

Frequency (MHz)	Ant. Pol. (H/V)	SG Reading (dBm)	Cable Loss (dB)	Gain (dBd)	ERP (dBm)	Limit (dBm)	Margin (dB)
Middle Channel 189 (836.40MHz)							
1672.8	H	-46.5	6.13	-2.59	-55.22	-13.00	-42.22
1672.8	V	-45.95	6.13	-2.59	-54.67	-13.00	-41.67
2509.2	H	-55.5	7.32	-2.86	-65.68	-13.00	-52.68
2509.2	V	-51.78	7.32	-2.86	-61.96	-13.00	-48.96

**GSM1900 (GSM Link), 9KHz to 30MHz**

The low frequency, which started from 9KHz to 30MHz, was pre-scanned and the result which was 20dB lower than the limit line, and that was not reported per 2.1057 (c).

**GSM 1900 (GSM Link), 30MHz to 1GHz**

Frequency (MHz)	Ant. Pol. (H/V)	SG Reading (dBm)	Cable Loss (dB)	Gain (dBi)	EIRP (dBm)	Limit (dBm)	Margin (dB)
Middle Channel 661 (1880.00MHz)							
671	H	-45.82	3.01	-2.83	-51.66	-13.00	-38.66
671	V	-44.3	3.01	-2.83	-50.14	-13.00	-37.14

**GSM 1900 (GSM Link), Above 1GHz**

Frequency (MHz)	Ant. Pol. (H/V)	SG Reading (dBm)	Cable Loss (dB)	Gain (dBi)	EIRP (dBm)	Limit (dBm)	Margin (dB)
Middle Channel 661 (1880.00MHz)							
3760	H	-48.45	8.85	-3.28	-60.58	-13.00	-47.58
3760	V	-46.51	8.85	-3.28	-58.64	-13.00	-45.64
5640	H	-40.47	10.79	-3.98	-55.24	-13.00	-42.24
5640	V	-42.12	10.79	-3.98	-56.89	-13.00	-43.89

**GSM1900 (EDGE 8 Link), 9KHz to 30MHz**

The low frequency, which started from 9KHz to 30MHz, was pre-scanned and the result which was 20dB lower than the limit line, and that was not reported per 2.1057 (c).

**GSM1900 (EDGE 8 Link), 30MHz to 1GHz**

Frequency (MHz)	Ant. Pol. (H/V)	SG Reading (dBm)	Cable Loss (dB)	Gain (dBi)	EIRP (dBm)	Limit (dBm)	Margin (dB)
Middle Channel 661 (1880.00MHz)							
681	H	-44.75	3.08	-2.85	-50.68	-13.00	-37.68
681	V	-42.23	3.08	-2.85	-48.16	-13.00	-35.16

**GSM1900 (EDGE 8 Link), Above 1GHz**

Frequency (MHz)	Ant. Pol. (H/V)	SG Reading (dBm)	Cable Loss (dB)	Gain (dBi)	EIRP (dBm)	Limit (dBm)	Margin (dB)
Middle Channel 661 (1880.00MHz)							
3760	H	-49.74	8.85	-3.28	-61.87	-13.00	-48.87
3760	V	-46.23	8.85	-3.28	-58.36	-13.00	-45.36
5640	H	-47.46	10.79	-3.98	-62.23	-13.00	-49.23
5640	V	-46.64	10.79	-3.98	-61.41	-13.00	-48.41

**WCDMA Band V 9KHz to 30MHz**

The low frequency, which started from 9KHz to 30MHz, was pre-scanned and the result which was 20dB lower than the limit line, and that was not reported per 2.1057 (c).

**WCDMA Band V 30MHz to 1GHz**

Frequency (MHz)	Ant. Pol. (H/V)	SG Reading (dBm)	Cable Loss (dB)	Gain (dBd)	ERP (dBm)	Limit (dBm)	Margin (dB)
Middle Channel 4182 (836.40MHz)							
734	H	-53.55	3.19	-2.89	-59.63	-13.00	-46.63
734	V	-51.31	3.19	-2.89	-57.39	-13.00	-44.39

**WCDMA Band V Above 1GHz**

Frequency (MHz)	Ant. Pol. (H/V)	SG Reading (dBm)	Cable Loss (dB)	Gain (dBd)	ERP (dBm)	Limit (dBm)	Margin (dB)
Middle Channel 4182 (836.40MHz)							
1672.8	H	-53.8	6.13	-2.59	-62.52	-13.00	-49.52
1672.8	V	-44.65	6.13	-2.59	-53.37	-13.00	-40.37
2509.2	H	-52.07	7.32	-2.86	-62.25	-13.00	-49.25
2509.2	V	-54.41	7.32	-2.86	-64.59	-13.00	-51.59
3345.6	H	-55.04	8.43	-3.79	-67.26	-13.00	-54.26
3345.6	V	-56.4	8.43	-3.79	-68.62	-13.00	-55.62



**WCDMA Band II 9KHz to 30MHz**

The low frequency, which started from 9KHz to 30MHz, was pre-scanned and the result which was 20dB lower than the limit line, and that was not reported per 2.1057 (c).

**WCDMA Band II 30MHz to 1GHz**

Frequency (MHz)	Ant. Pol. (H/V)	SG Reading (dBm)	Cable Loss (dB)	Gain (dBi)	EIRP (dBm)	Limit (dBm)	Margin (dB)
Middle Channel 9400 (1880MHz)							
711	H	-55.18	3.17	-2.88	-61.23	-13.00	-48.23
711	V	-50.88	3.17	-2.88	-56.93	-13.00	-43.93

**WCDMA Band II Above 1GHz**

Frequency (MHz)	Ant. Pol. (H/V)	SG Reading (dBm)	Cable Loss (dB)	Gain (dBi)	EIRP (dBm)	Limit (dBm)	Margin (dB)
Middle Channel 9400 (1880MHz)							
3760	H	-56.09	8.85	-3.28	-68.22	-13.00	-55.22
3760	V	-54.26	8.85	-3.28	-66.39	-13.00	-53.39
5640	H	-54.81	10.79	-3.98	-69.58	-13.00	-56.58
5640	V	-57.76	10.79	-3.98	-72.53	-13.00	-59.53
7520	H	-57.19	12.93	-3.03	-73.15	-13.00	-60.15
7520	V	-55.4	12.93	-3.03	-71.36	-13.00	-58.36

## 5. Receiver Spurious Emission for RSS 132/133

### 5.1. Test Equipment

Instrument	Manufacturer	Model	Serial No.	Cali. Due Date
Spectrum Analyzer	Agilent	N9038A	MY51210142	2014.12.17
Radio Communication Tester	Agilent	E5515C	GB46581718	2015.10.24
Signal Generator	Agilent	N5183A	MY50140938	2015.01.03
Preamplifier	CEM	EM30180	3008A0245	2015.02.28
Loop Antenna	Schwarzbeck	FMZB1519	1519-020	2015.03.26
Bilog Antenna	Schwarzbeck	VULB9160	9160-3316	2015.07.19
VHF-UHF-Biconical Antenna	Schwarzbeck	VUBA9117	9117-263	2015.07.19
Broad-Band Horn Antenna	Schwarzbeck	BBHA9120D	9120D-942	2015.07.19
Broad-Band Horn Antenna	Schwarzbeck	BBHA9120D	9120D-943	2015.07.19

The measure equipment had been calibrated once a year.

### 5.2. Test Setup

Below 1GHz Test Setup

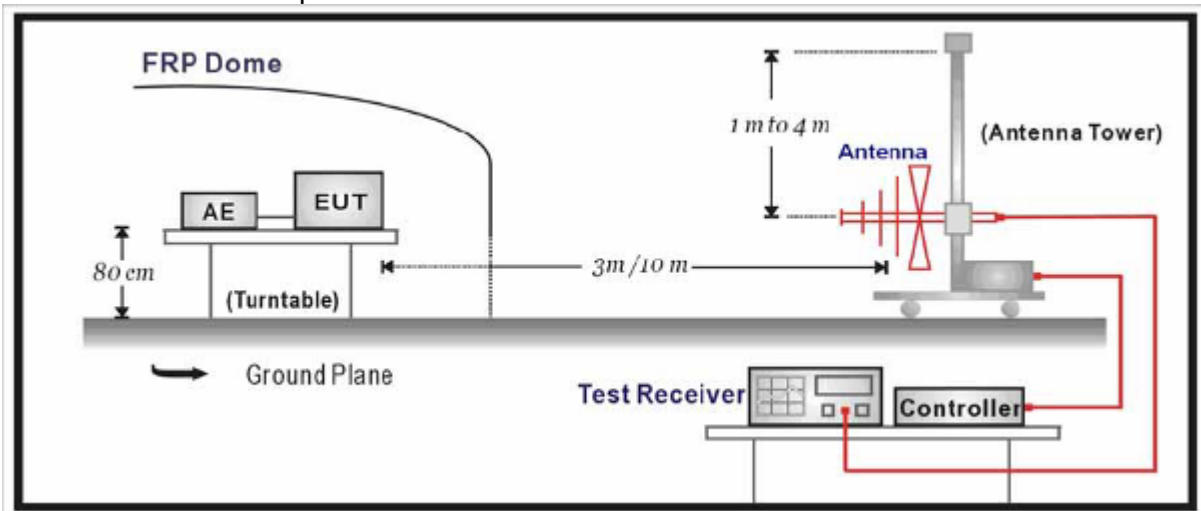

Above 1GHz Test Setup

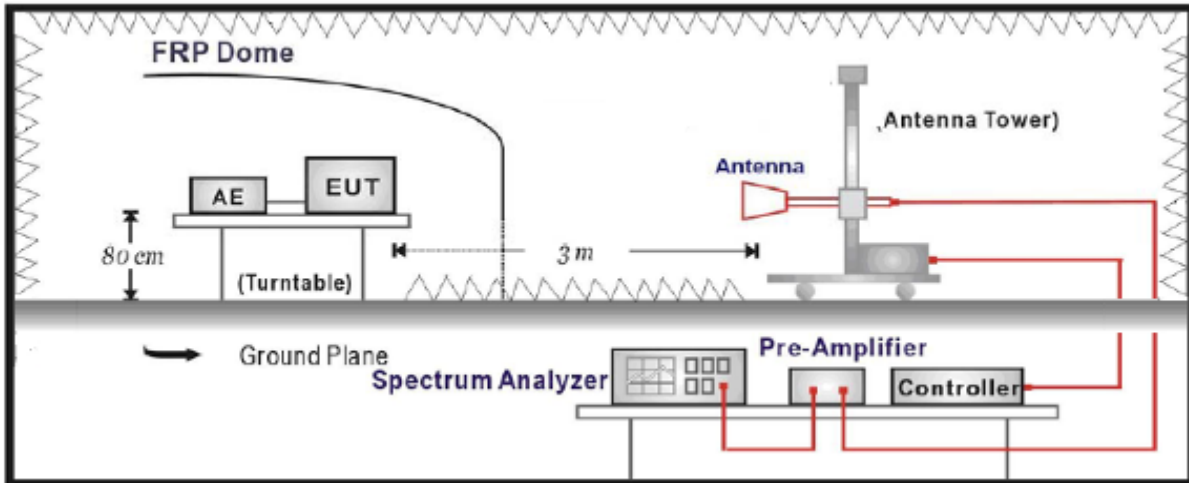

### 5.3. Limit

According to Standard RSS132/133 refer to RSS-Gen Issu 3.

Field Strength micro-volts/m at 3 meters		
Frequency (MHz)	Distance (m)	Level (dBuV/m)
30 - 88	3	40
88 - 216	3	43.5
216 - 960	3	46
Above 960	3	54

Note 1: The lower limit shall apply at the transition frequency.

Note 2: Distance refers to the distance in meters between the measuring instrument antenna and the closed point of any part of the device or system.

Note 3: E field strength (dBuV/m) = 20 log E field strength (uV/m).

### 5.4. Test Procedure

The EUT and its simulators are placed on a turn table which is 0.8 meter above ground. The turn table can rotate 360 degrees to determine the position of the maximum emission level. The EUT was positioned such that the distance from antenna to the EUT was 3 meters. The antenna can move up and down between 1 meter and 4 meters to find out the maximum emission level. Both horizontal and vertical polarization of the antenna are set on measurement. In order to find the maximum emission, all of the interface cables must be manipulated on radiated measurement. On any frequency or frequencies below or equal to 1000 MHz, the radiated limits shown are based on measuring equipment employing a quasi-peak detector function and above 100MHz, the radiated limits shown are based measuring equipment employing an average detector function.

When average radiated emission measurement are included emission measurement Above 1000 MHz, there also is a limit on the radio frequency emissions, as measured using instrumentation with a peak detector function, corresponding to 20 dB above the maximum permitted average limit.

**Note:** When measurement above 1GHz, the horn antenna will bend down a little (as horn antenna have the narrow beamwidth) in order to find the maximum emission of EUT.

## **5.5. Uncertainty**

The measurement uncertainty is defined as 3.1 dB for Radiated Power Measurement.

### 5.6. Test Result

No significant emissions measurable. Plots reported here represent the worse case emissions.

#### GSM 850(IDLE)

**GSM850 Normal Voltage Condition at Middle Channel**

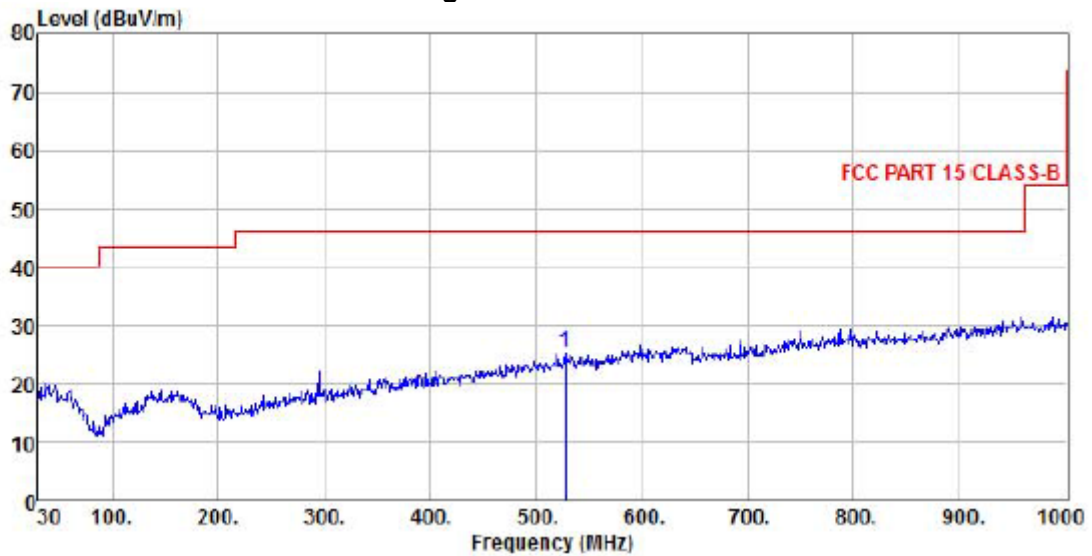

```

Site       : chamber
Condition  : FCC PART 15 CLASS-B 3m VULB9160 HORIZONTAL
EUT       :
Model Name : PD55-US
Temp/Humi  : 22°C / 53 %
Power Rating: DC 12V
Mode      : GSM 850
Memo      : IDLE
    
```

	ReadAntenna	Cable Preamp	Limit	Over	
Freq	Level	Factor	Loss	Factor	Level
MHz	dBuV	dB/m	dB	dB	dBuV/m
1 pp 527.61	4.75	17.43	3.14	0.00	25.32
					46.00
					-20.68
					Peak

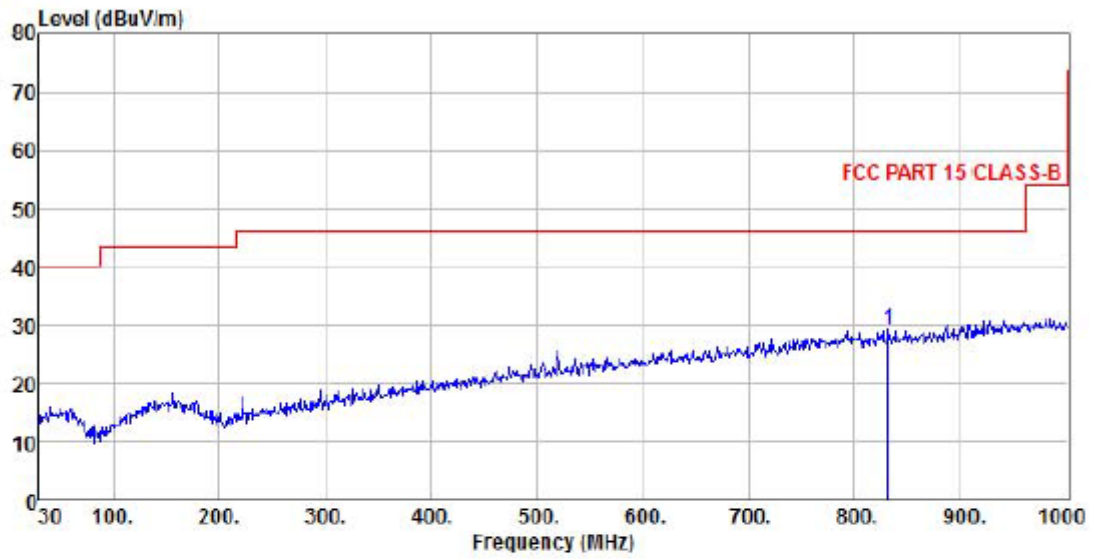

Site : chamber  
 Condition : FCC PART 15 CLASS-B 3m VULB9160 VERTICAL  
 EUT :  
 Model Name : PD55-US  
 Temp/Humi : 22°C / 53 %  
 Power Rating: DC 12V  
 Mode : GSM 850  
 Memo : IDLE

	Read Freq	Antenna Level	Antenna Factor	Cable Loss	Preamp Factor	Level	Limit Line	Over Limit	Remark
	MHz	dBuV	dB/m	dB	dB	dBuV/m	dBuV/m	dB	
1 pp	832.19	3.18	21.97	3.95	0.00	29.10	46.00	-16.90	Peak

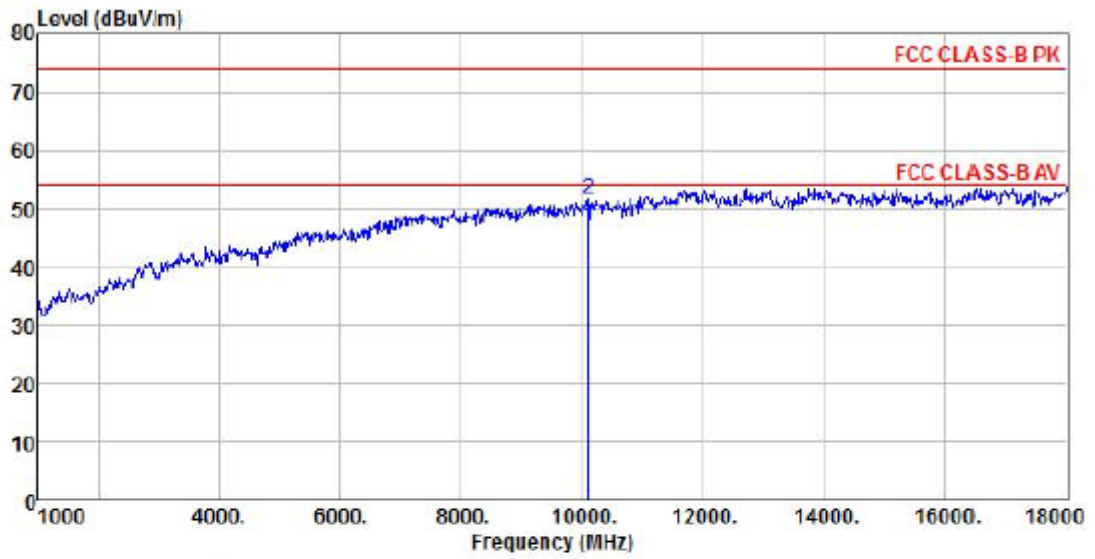

Site : chamber  
 Condition : FCC CLASS-B PK 3m BBHA9120D(942) HORIZONTAL  
 EUT :  
 Model Name : PDS5-US  
 Temp/Humi : 22°C / 53 %  
 Power Rating: DC 12V  
 Mode : GSM 850  
 Memo : IDLE

	ReadAntenna	Cable	Preamp	Limit	Over			
Freq	Level	Factor	Loss	Factor	Level	Line	Limit	Remark
MHz	dBuV	dB/m	dB	dB	dBuV/m	dBuV/m	dB	
1 pp 10112.00	32.48	38.69	15.16	39.34	46.99	54.00	-7.01	Average
2 pk 10112.00	37.27	38.69	15.16	39.34	51.78	74.00	-22.22	Peak

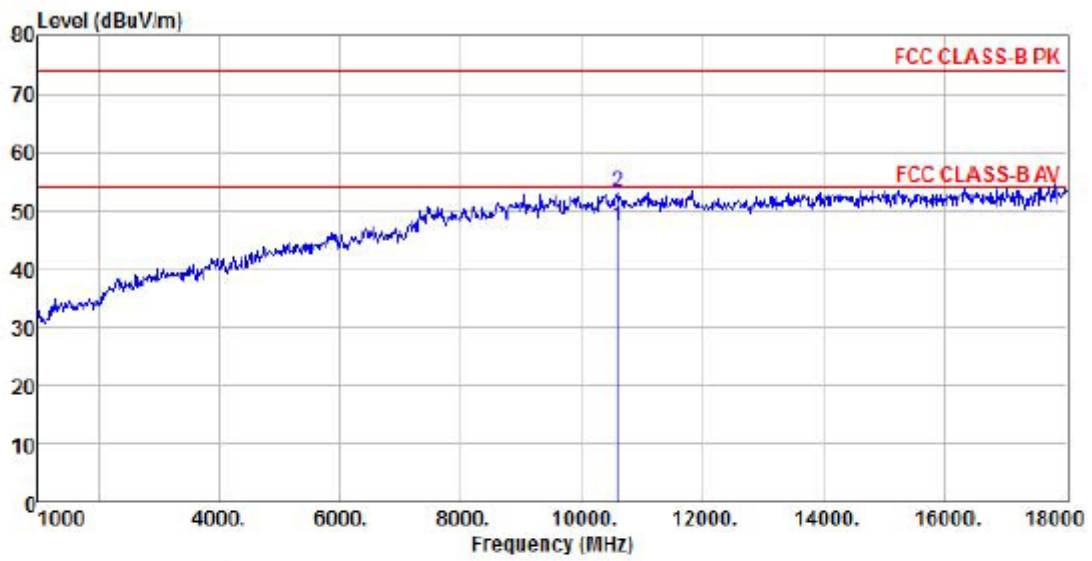

Site : chamber  
 Condition : FCC CLASS-B PK 3m BBHA9120D(942) VERTICAL  
 EUT :  
 Model Name : PD55-US  
 Temp/Humi : 22°C / 53 %  
 Power Rating: DC 12V  
 Mode : GSM 850  
 Memo : IDLE

	ReadAntenna	Cable	Preamp		Limit	Over		
Freq	Level	Factor	Loss	Factor	Level	Line	Limit	Remark
MHz	dBuV	dB/m	dB	dB	dBuV/m	dBuV/m	dB	
1 pp 10588.00	31.26	39.66	15.50	39.10	47.32	54.00	-6.68	Average
2 pk 10588.00	36.94	39.66	15.50	39.10	53.00	74.00	-21.00	Peak



**EDGE 850(IDLE Link 8)**

**EGPRS850 Normal Voltage Condition at Middle Channel**

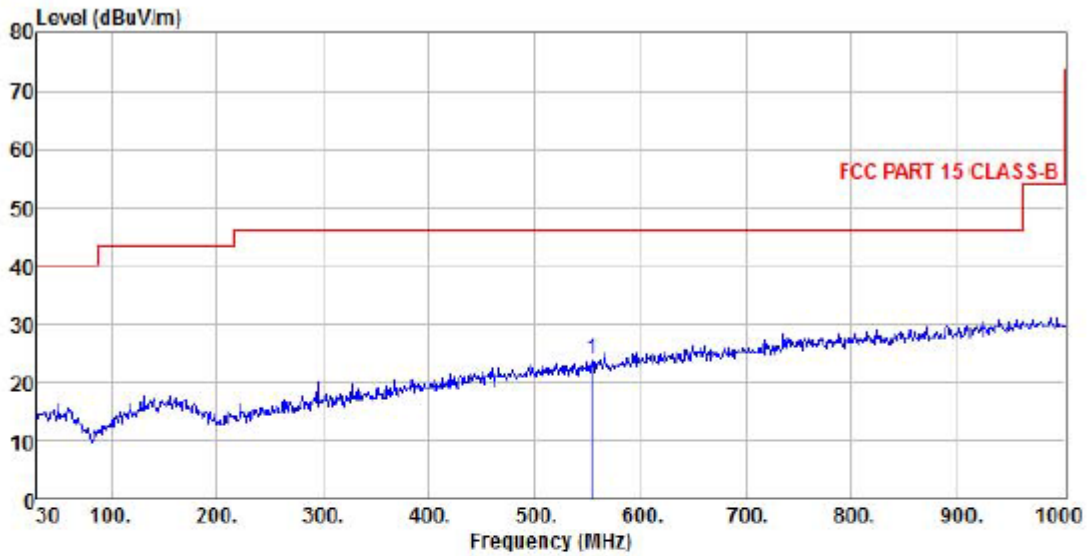

Site : chamber  
 Condition : FCC PART 15 CLASS-B 3m VULB9160 HORIZONTAL  
 EUT :  
 Model Name : PD55-US  
 Temp/Humi : 22°C / 53 %  
 Power Rating: DC 12V  
 Mode : EDGE 850  
 Memo : IDLE

	Read	Antenna	Cable	Preamp	Limit	Over	
Freq	Level	Factor	Loss	Factor	Level	Line	Limit Remark
MHz	dBuV	dB/m	dB	dB	dBuV/m	dBuV/m	dB
1 pp 554.77	2.62	18.02	3.20	0.00	23.84	46.00	-22.16 Peak

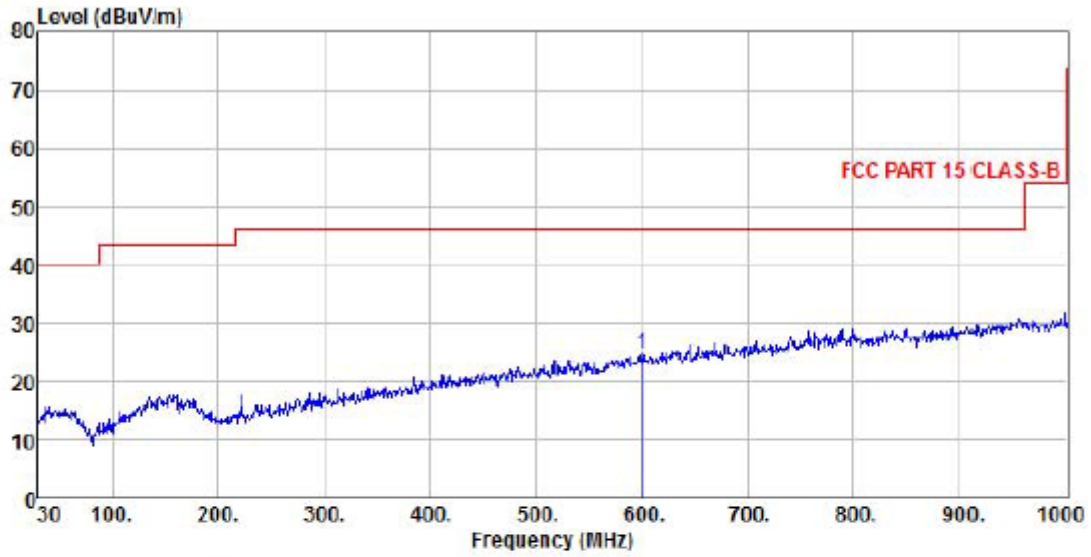

Site : chamber  
 Condition : FCC PART 15 CLASS-B 3m VULB9160 VERTICAL  
 EUT :  
 Model Name : PD55-US  
 Temp/Humi : 22°C / 53 %  
 Power Rating: DC 12V  
 Mode : EDGE 850  
 Memo : IDLE

	Read	Antenna	Cable	Preamp		Limit	Over	
Freq	Level	Factor	Loss	Factor	Level	Line	Limit	Remark
MHz	dBuV	dB/m	dB	dB	dBuV/m	dBuV/m	dB	
1 pp 600.36	2.22	19.16	3.34	0.00	24.72	46.00	-21.28	Peak

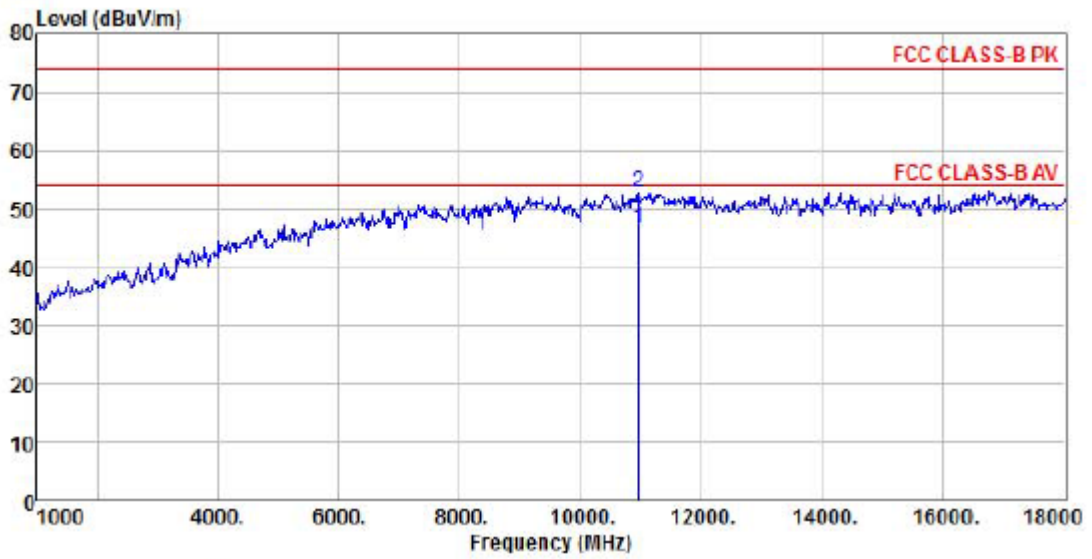

Site : chamber  
 Condition : FCC CLASS-B PK 3m BBHA9120D(942) HORIZONTAL  
 EUT :  
 Model Name : PD55-US  
 Temp/Humi : 22°C / 53 %  
 Power Rating: DC 12V  
 Mode : EDGE 850  
 Memo : IDLE

	ReadAntenna	Cable	Preamp		Limit	Over		
Freq	Level	Factor	Loss	Factor	Level	Line	Limit	Remark
MHz	dBuV	dB/m	dB	dB	dBuV/m	dBuV/m	dB	
1 pp 10962.00	29.49	40.31	15.70	38.92	46.58	54.00	-7.42	Average
2 pk 10962.00	35.80	40.31	15.70	38.92	52.89	74.00	-21.11	Peak

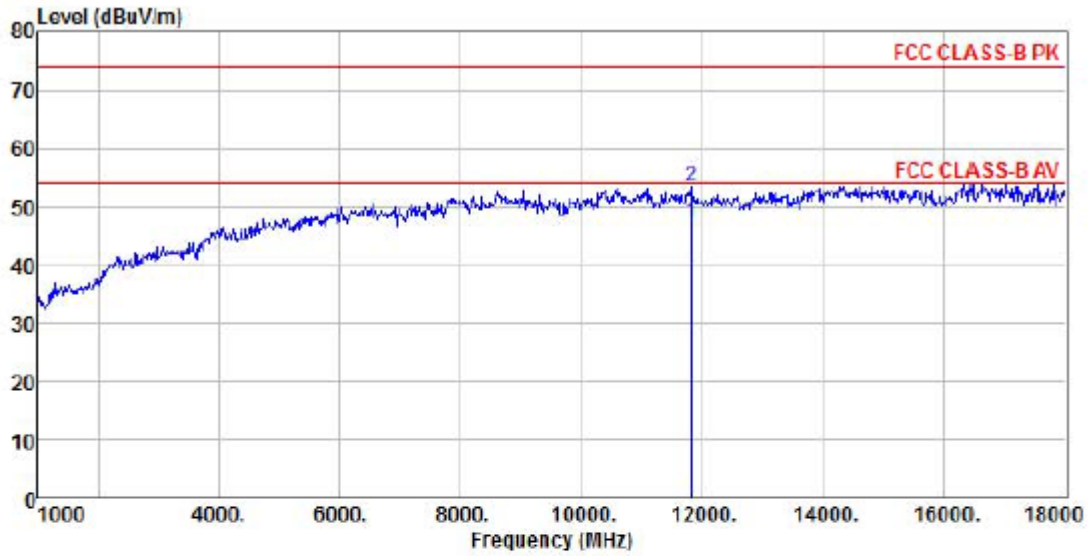

Site : chamber  
 Condition : FCC CLASS-B PK 3m BBHA9120D(942) VERTICAL  
 EUT :  
 Model Name : PD55-US  
 Temp/Humi : 22°C / 53 %  
 Power Rating: DC 12V  
 Mode : EDGE 850  
 Memo : IDLE

	ReadAntenna	Cable	Preamp	Limit	Over			
Freq	Level	Factor	Loss	Factor	Level	Line	Limit	Remark
MHz	dBuV	dB/m	dB	dB	dBuV/m	dBuV/m	dB	
1 pp 11829.00	30.77	39.35	16.42	39.32	47.22	54.00	-6.78	Average
2 pk 11829.00	36.84	39.35	16.42	39.32	53.29	74.00	-20.71	Peak

**PCS 1900(IDLE)**

**GSM1900 Normal Voltage Condition at Middle Channel**

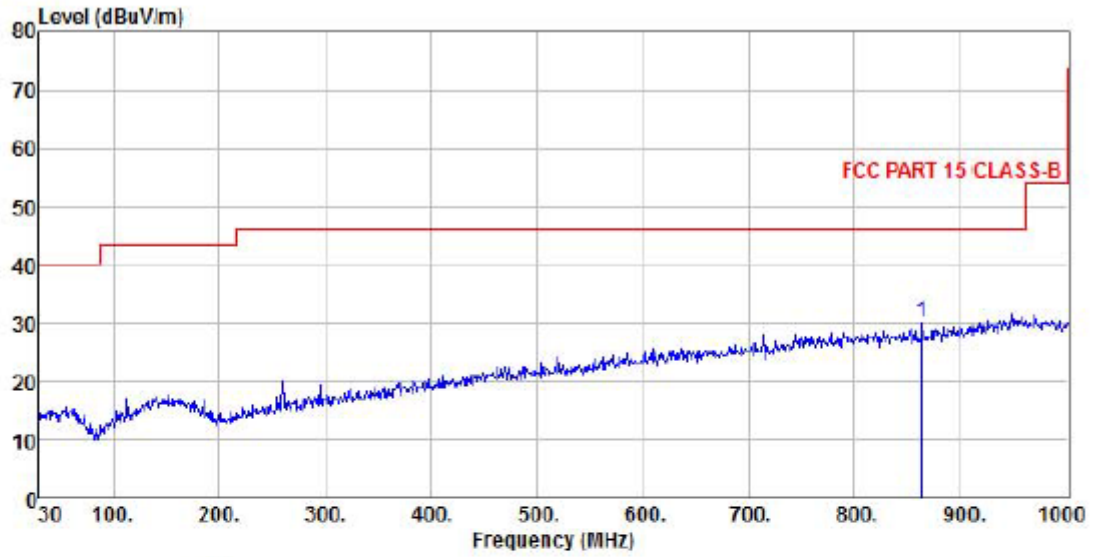

Site : chamber  
 Condition : FCC PART 15 CLASS-B 3m VULB9160 HORIZONTAL  
 EUT :  
 Model Name : PD55-US  
 Temp/Humi : 22°C / 53 %  
 Power Rating: DC 12V  
 Mode : PCS 1900  
 Memo : IDLE

	Read Freq	Antenna Level	Antenna Factor	Cable Loss	Preamp Factor	Level	Limit Line	Over Limit	Remark
	MHz	dBuV	dB/m	dB	dB	dBuV/m	dBuV/m	dB	
1 pp	863.23	3.90	22.06	4.00	0.00	29.96	46.00	-16.04	Peak

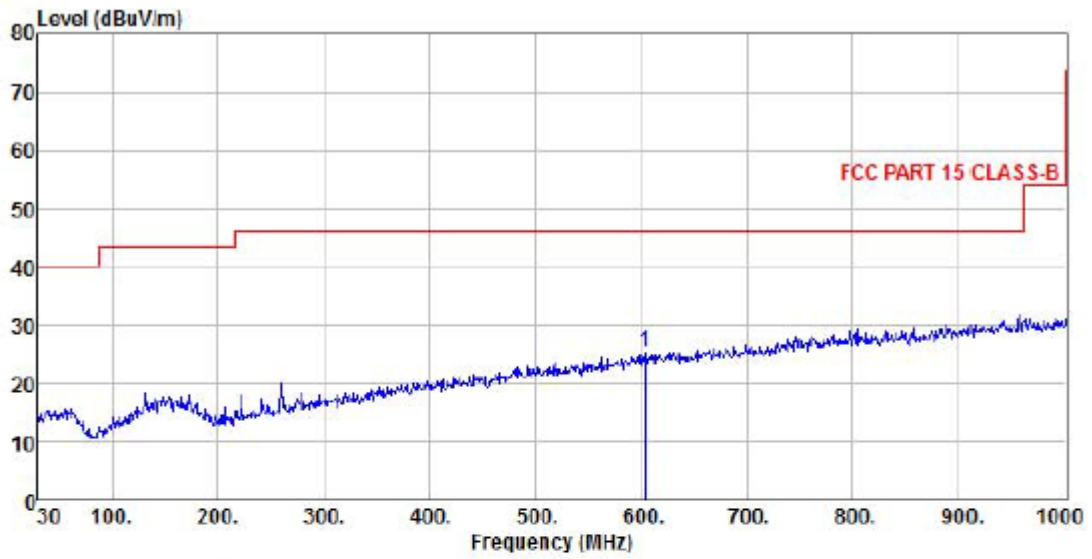

Site : chamber  
 Condition : FCC PART 15 CLASS-B 3m VULB9160 VERTICAL  
 EUT :  
 Model Name : PD55-US  
 Temp/Humi : 22°C / 53 %  
 Power Rating: DC 12V  
 Mode : PCS 1900  
 Memo : IDLE

	Read	Antenna	Cable	Preamp		Limit	Over	
Freq	Level	Factor	Loss	Factor	Level	Line	Limit	Remark
MHz	dBuV	dB/m	dB	dB	dBuV/m	dBuV/m	dB	
1 pp 604.24	2.88	19.17	3.35	0.00	25.40	46.00	-20.60	Peak

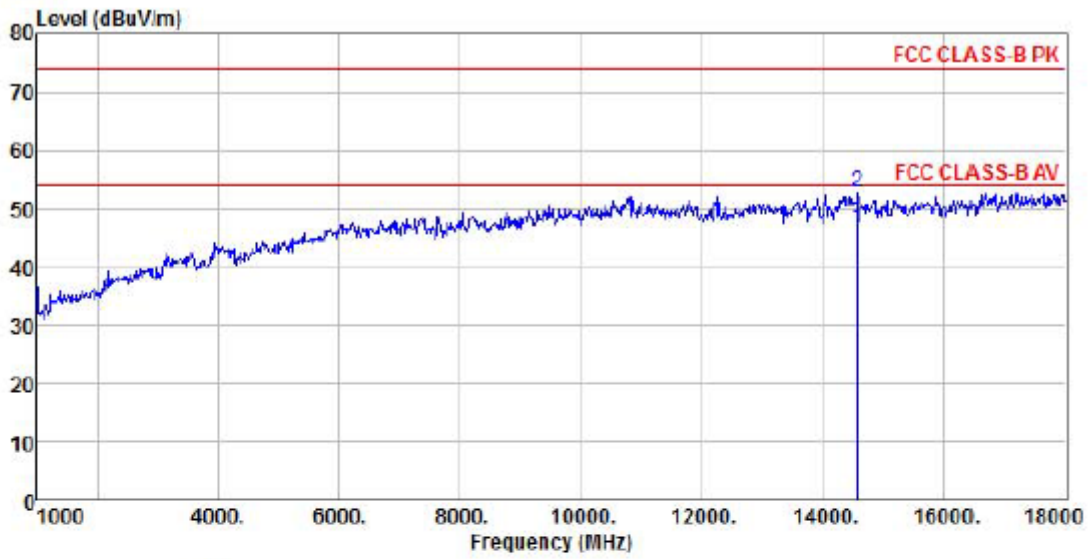

Site : chamber  
 Condition : FCC CLASS-B PK 3m BBHA9120D(942) HORIZONTAL  
 EUT :  
 Model Name : PD55-US  
 Temp/Humi : 22°C / 53 %  
 Power Rating: DC 12V  
 Mode : PCS 1900  
 Memo : IDLE

	ReadAntenna	Cable	Preamp		Limit	Over		
Freq	Level	Factor	Loss	Factor	Level	Line	Limit	Remark
MHz	dBuV	dB/m	dB	dB	dBuV/m	dBuV/m	dB	
1 pp 14583.00	23.62	42.46	18.68	38.12	46.64	54.00	-7.36	Average
2 pk 14583.00	29.89	42.46	18.68	38.12	52.91	74.00	-21.09	Peak

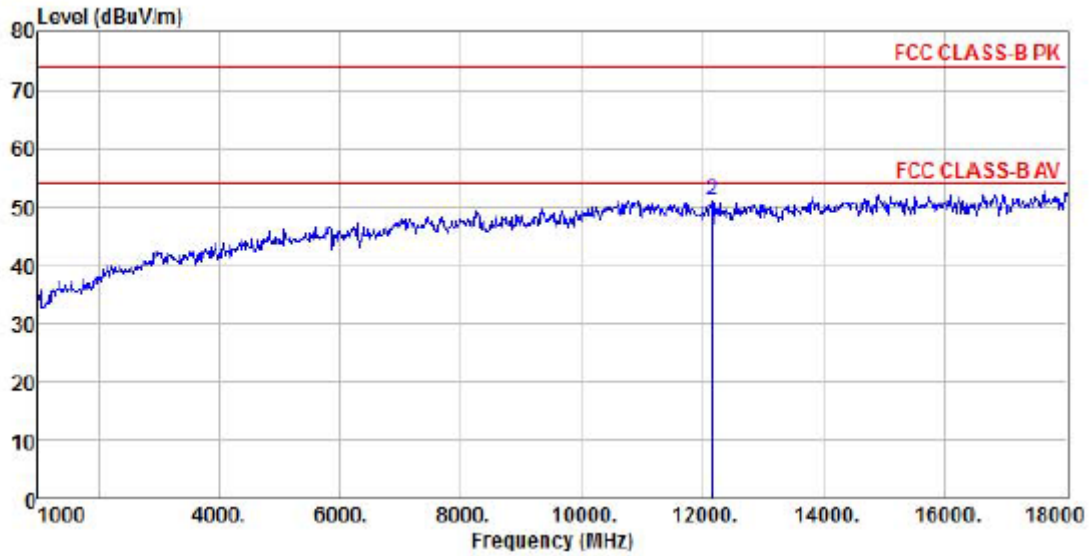

Site : chamber  
 Condition : FCC CLASS-B PK 3m BBHA9120D(942) VERTICAL  
 EUT :  
 Model Name : PD55-US  
 Temp/Humi : 22°C / 53 %  
 Power Rating: DC 12V  
 Mode : PCS 1900  
 Memo : IDLE

	Freq	Read Level	Antenna Factor	Cable Loss	Preamp Factor	Level	Limit Line	Over Limit	Remark
	MHz	dBuV	dB/m	dB	dB	dBuV/m	dBuV/m	dB	
1	pp 12152.00	30.82	39.33	16.34	39.25	47.24	54.00	-6.76	Average
2	pk 12152.00	34.77	39.33	16.34	39.25	51.19	74.00	-22.81	Peak



**EDGE 1900(IDLE Link 8)**

**EGPRS1900 Normal Voltage Condition at Middle Channel**

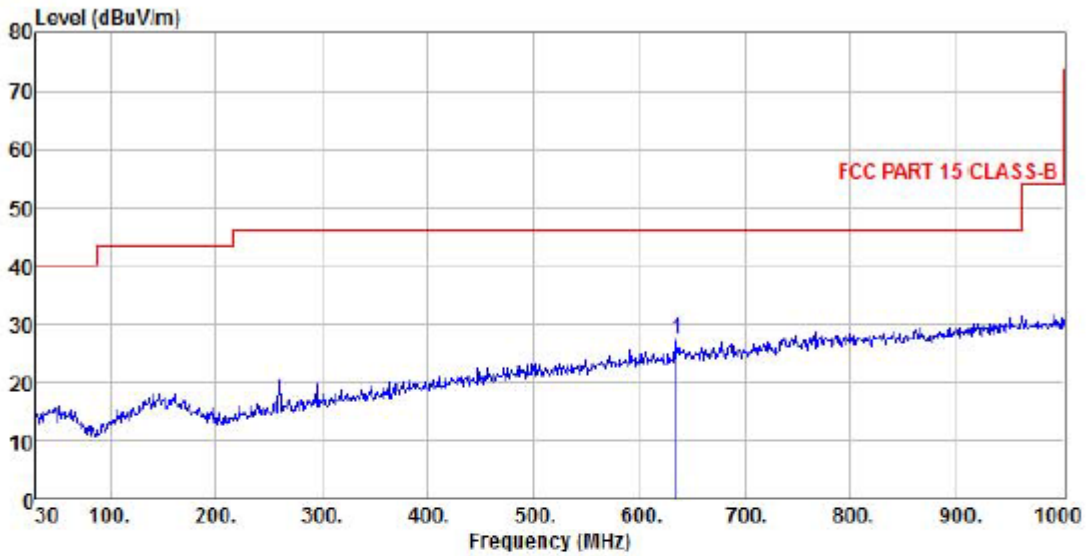

Site : chamber  
 Condition : FCC PART 15 CLASS-B 3m VULB9160 HORIZONTAL  
 EUT :  
 Model Name : PD55-US  
 Temp/Humi : 22°C / 53 %  
 Power Rating: DC 12V  
 Mode : EDGE 1900  
 Memo : IDLE

	ReadAntenna	Cable	Preamp	Limit	Over		
Freq	Level	Factor	Loss	Factor	Level	Line	
MHz	dBuV	dB/m	dB	dB	dBuV/m	dBuV/m	
1 pp 635.28	4.63	19.37	3.50	0.00	27.50	46.00	-18.50 Peak

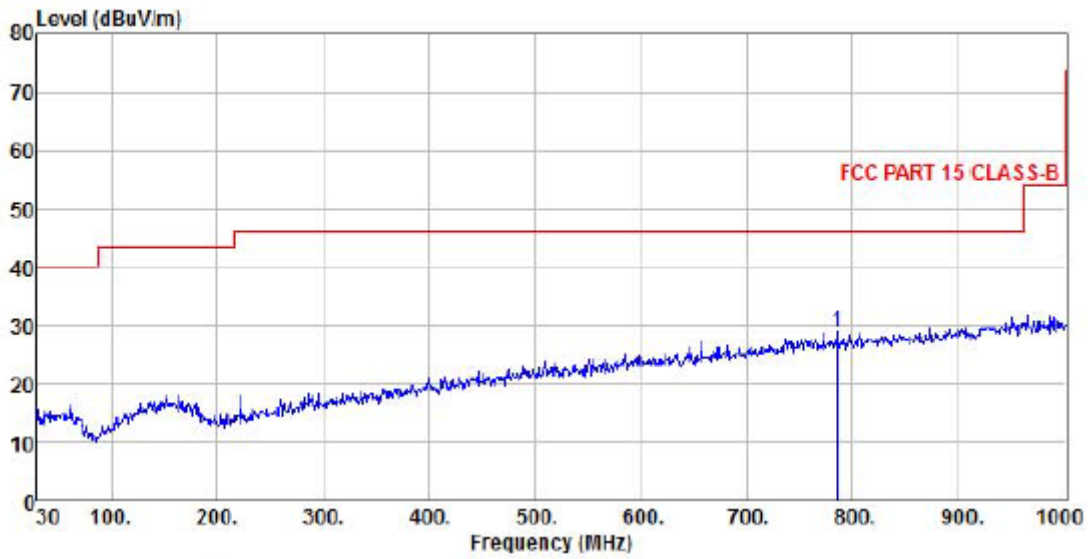

Site : chamber  
 Condition : FCC PART 15 CLASS-B 3m VULB9160 VERTICAL  
 EUT :  
 Model Name : PDS5-US  
 Temp/Humi : 22°C / 53 %  
 Power Rating: DC 12V  
 Mode : EDGE 1900  
 Memo : IDLE

	ReadAntenna	Cable	Preamp		Limit	Over	
Freq	Level	Factor	Loss	Factor	Level	Line	Limit Remark
MHz	dBuV	dB/m	dB	dB	dBuV/m	dBuV/m	dB
1 pp 785.63	3.44	21.56	3.83	0.00	28.83	46.00	-17.17 Peak

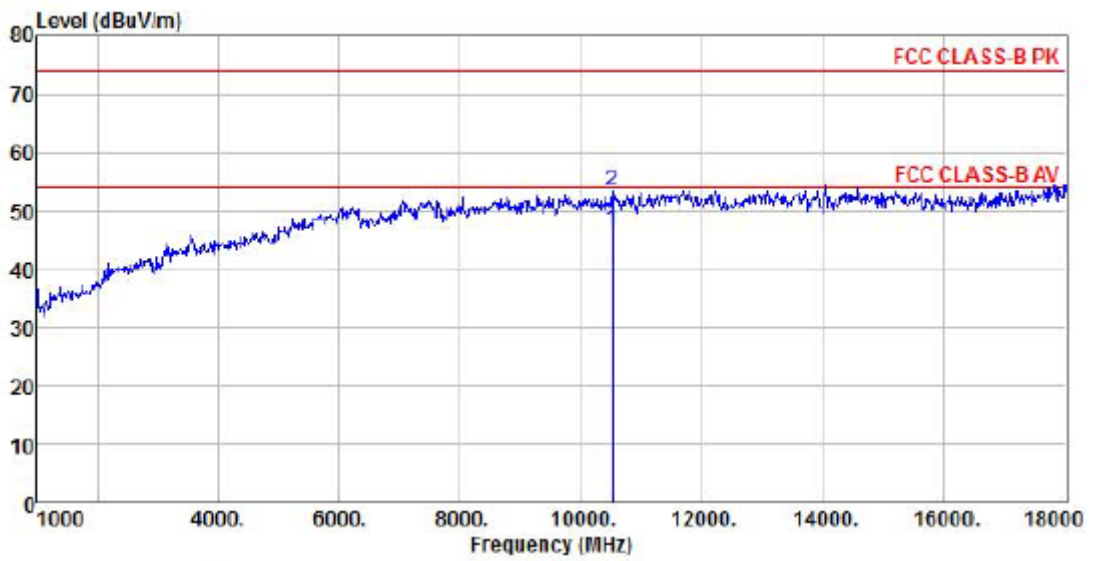

Site : chamber  
 Condition : FCC CLASS-B PK 3m BBHA9120D(942) HORIZONTAL  
 EUT :  
 Model Name : PD55-US  
 Temp/Humi : 22°C / 53 %  
 Power Rating: DC 12V  
 Mode : EDGE 1900  
 Memo : IDLE

	ReadAntenna	Cable	Preamp	Limit	Over				
Freq	Level	Factor	Loss	Factor	Level	Line	Limit	Remark	
MHz	dBuV	dB/m	dB	dB	dBuV/m	dBuV/m	dB		
1 pp 10520.00	30.86	39.62	15.43	39.14	46.77	54.00	-7.23	Average	
2 pk 10520.00	37.37	39.62	15.43	39.14	53.28	74.00	-20.72	Peak	

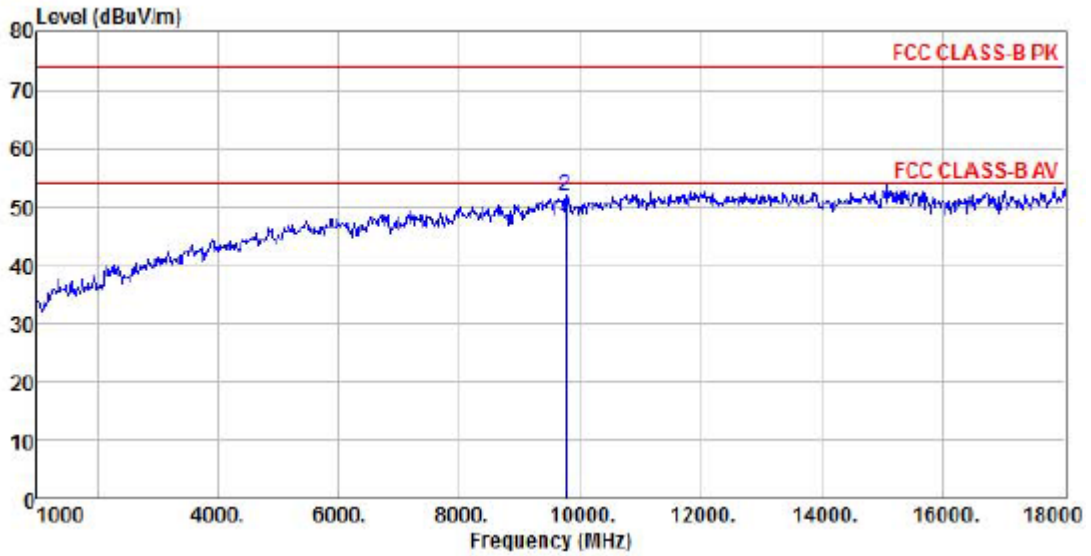

Site : chamber  
 Condition : FCC CLASS-B PK 3m BBHA9120D(942) VERTICAL  
 EUT :  
 Model Name : PD55-US  
 Temp/Humi : 22°C / 53 %  
 Power Rating: DC 12V  
 Mode : EDGE 1900  
 Memo : IDLE

	Freq	Read Level	Antenna Factor	Cable Loss	Preamp Factor	Level	Limit Line	Over Limit	Remark
	MHz	dBuV	dB/m	dB	dB	dBuV/m	dBuV/m	dB	
1 pp	9755.00	33.63	38.45	14.39	39.83	46.64	54.00	-7.36	Average
2 pk	9755.00	38.99	38.45	14.39	39.83	52.00	74.00	-22.00	Peak

**WCDMA BAND V(IDLE)**

**WCDMA BAND V Normal Voltage Condition at Middle Channel**

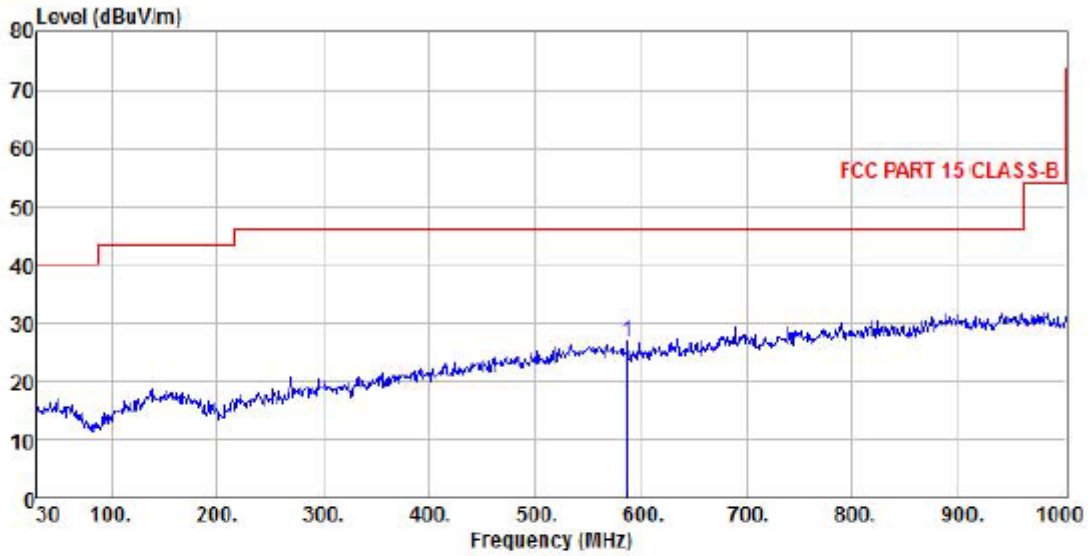

Site : chamber  
 Condition : FCC PART 15 CLASS-B 3m VULB9160 HORIZONTAL  
 EUT :  
 Model Name : PD55-US  
 Temp/Humi : 22°C / 53 %  
 Power Rating: DC 12V  
 Mode : WCDMA BAND V  
 Memo : IDLE

	ReadAntenna	Cable	Preamp		Limit	Over	
Freq	Level	Factor	Loss	Factor	Level	Line	Limit Remark
MHz	dBuV	dB/m	dB	dB	dBuV/m	dBuV/m	dB
1 pp 586.78	4.80	18.78	3.30	0.00	26.88	46.00	-19.12 Peak

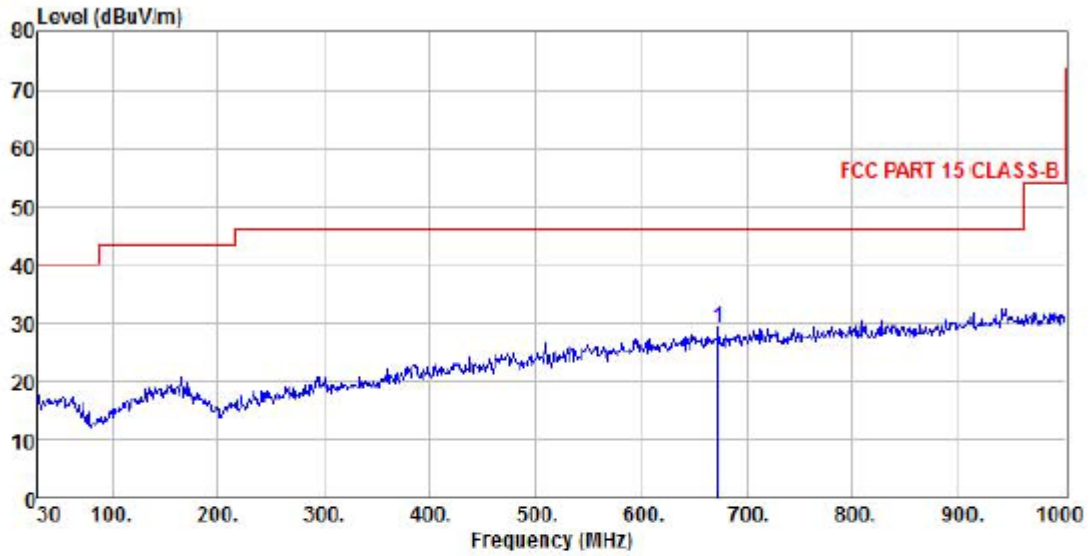

Site : chamber  
 Condition : FCC PART 15 CLASS-B 3m VULB9160 VERTICAL  
 EUT :  
 Model Name : PD55-US  
 Temp/Humi : 22°C / 53 %  
 Power Rating: DC 12V  
 Mode : WCDMA BAND V  
 Memo : IDLE

	ReadAntenna	Cable	Preamp		Limit	Over	
Freq	Level	Factor	Loss	Factor	Level	Line	Limit Remark
MHz	dBuV	dB/m	dB	dB	dBuV/m	dBuV/m	dB
1 pp 673.11	5.74	19.80	3.56	0.00	29.10	46.00	-16.90 Peak

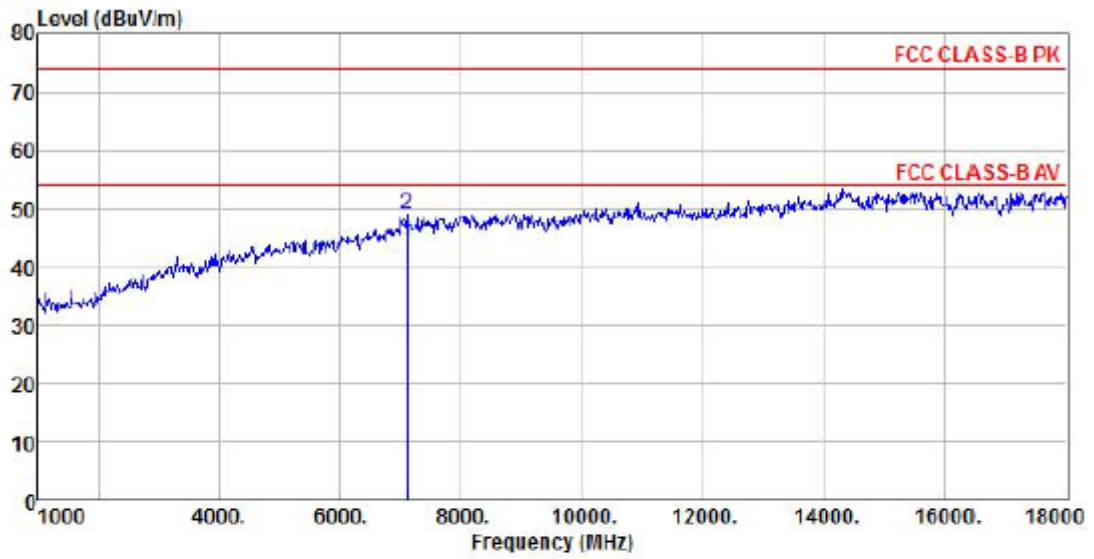

Site : chamber  
 Condition : FCC CLASS-B PK 3m BBHA9120D(942) HORIZONTAL  
 EUT :  
 Model Name : PD55-US  
 Temp/Humi : 22°C / 53 %  
 Power Rating: DC 12V  
 Mode : WCDMA BAND V  
 Memo : IDLE

	ReadAntenna	Cable	Preamp		Limit	Over		
Freq	Level	Factor	Loss	Factor	Level	Line	Limit	Remark
MHz	dBuV	dB/m	dB	dB	dBuV/m	dBuV/m	dB	
1 pp 7103.00	32.36	36.06	12.47	36.66	44.23	54.00	-9.77	Average
2 pk 7103.00	37.06	36.06	12.47	36.66	48.93	74.00	-25.07	Peak

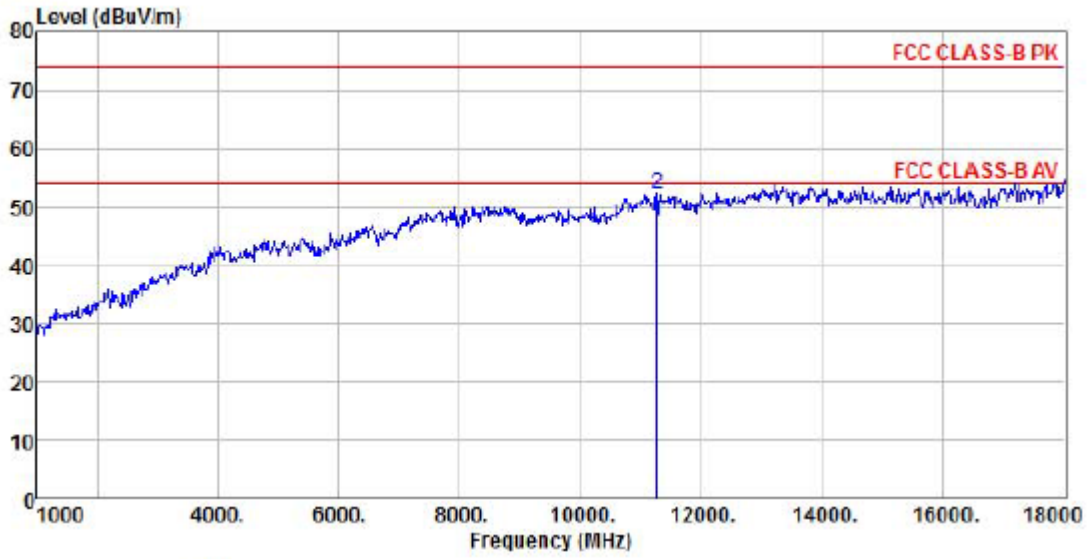

Site : chamber  
 Condition : FCC CLASS-B PK 3m BBHA9120D(942) VERTICAL  
 EUT :  
 Model Name : PD55-US  
 Temp/Humi : 22°C / 53 %  
 Power Rating: DC 12V  
 Mode : WCDMA BAND V  
 Memo : IDLE

	ReadAntenna	Cable	Preamp		Limit	Over		
Freq	Level	Factor	Loss	Factor	Level	Line	Limit	Remark
MHz	dBuV	dB/m	dB	dB	dBuV/m	dBuV/m	dB	
1 pp 11268.00	30.51	39.96	16.17	39.04	47.60	54.00	-6.40	Average
2 pk 11268.00	35.16	39.96	16.17	39.04	52.25	74.00	-21.75	Peak



**WCDMA BAND II(IDLE)**

**WCDMA BAND II Normal Voltage Condition at Middle Channel**

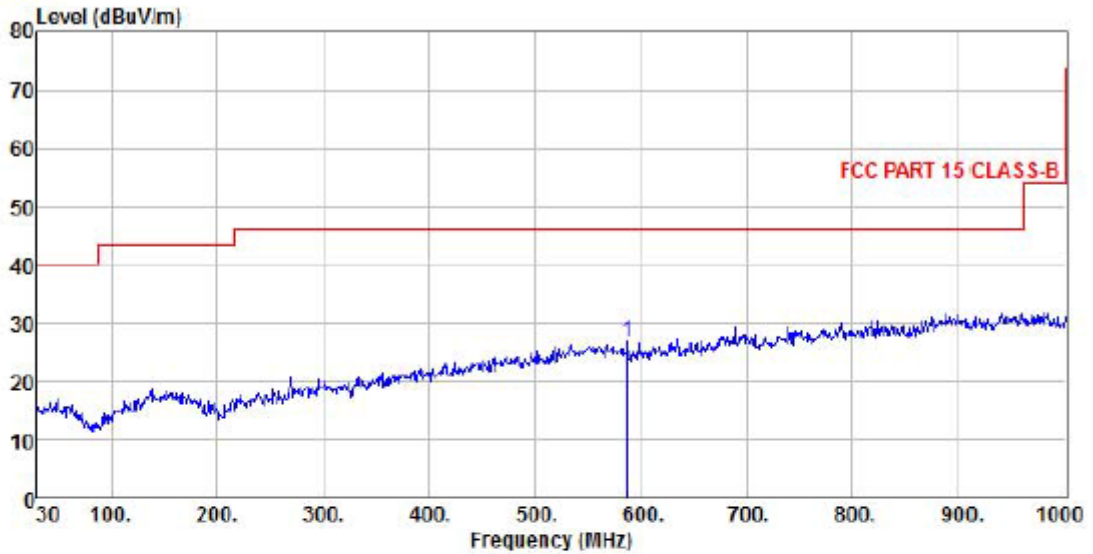

Site : chamber  
 Condition : FCC PART 15 CLASS-B 3m VULB9160 HORIZONTAL  
 EUT :  
 Model Name : PD55-US  
 Temp/Humi : 22°C / 53 %  
 Power Rating: DC 12V  
 Mode : WCDMA BAND V  
 Memo : IDLE

	ReadAntenna	Cable	Preamp		Limit	Over	
Freq	Level	Factor	Loss	Factor	Level	Line	Limit
MHz	dBuV	dB/m	dB	dB	dBuV/m	dBuV/m	dB
1 pp 586.78	4.80	18.78	3.30	0.00	26.88	46.00	-19.12 Peak

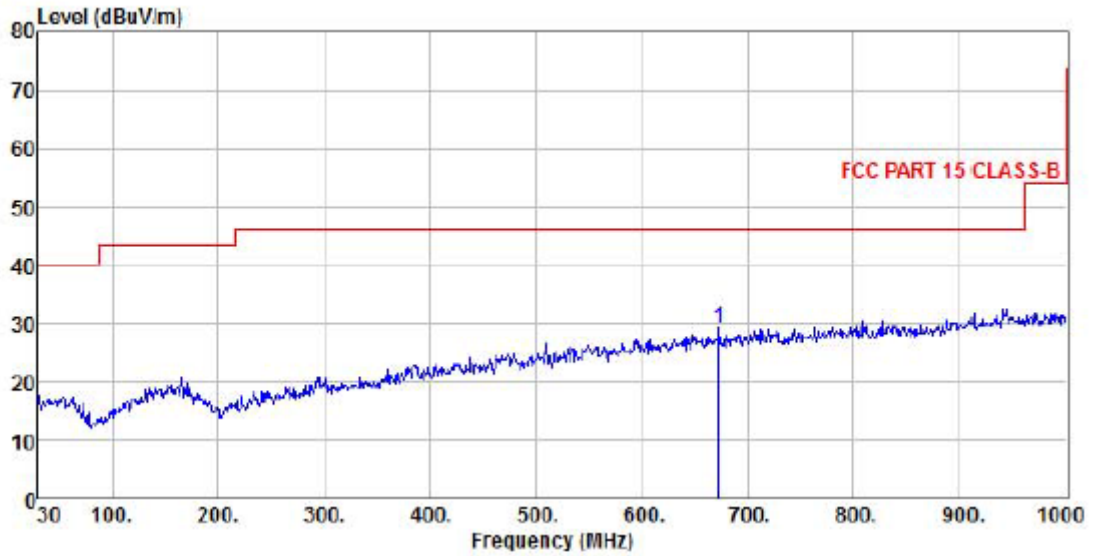

Site : chamber  
 Condition : FCC PART 15 CLASS-B 3m VULB9160 VERTICAL  
 EUT :  
 Model Name : PD55-US  
 Temp/Humi : 22°C / 53 %  
 Power Rating: DC 12V  
 Mode : WCDMA BAND V  
 Memo : IDLE

	ReadAntenna	Cable	Preamp		Limit	Over	
Freq	Level	Factor	Loss	Factor	Level	Line	Limit Remark
MHz	dBuV	dB/m	dB	dB	dBuV/m	dBuV/m	dB
1 pp 673.11	5.74	19.80	3.56	0.00	29.10	46.00	-16.90 Peak

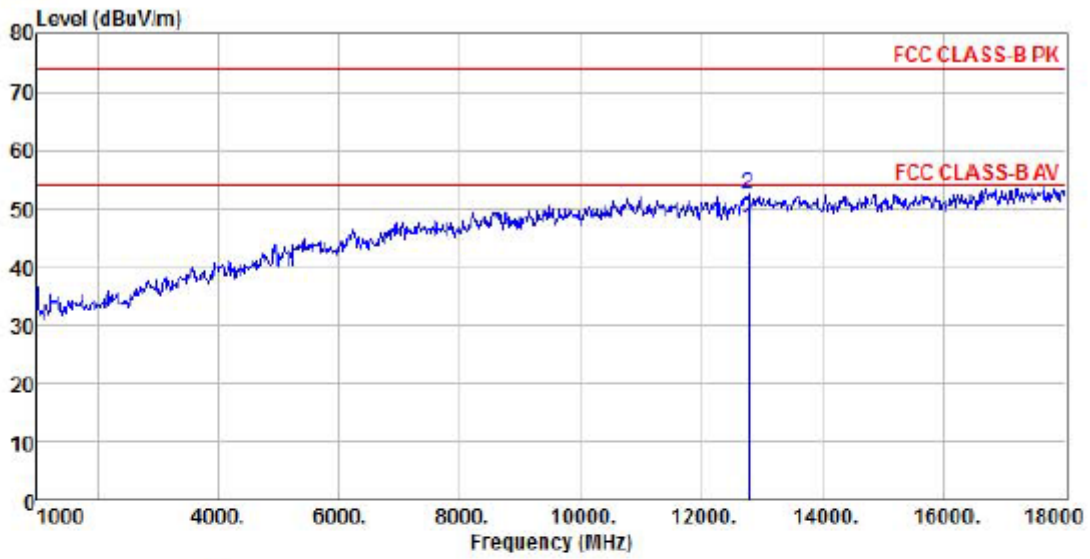

Site : chamber  
 Condition : FCC CLASS-B PK 3m BBHA9120D(942) HORIZONTAL  
 EUT :  
 Model Name : PD55-US  
 Temp/Humi : 22°C / 53 %  
 Power Rating: DC 12V  
 Mode : WCDMA BAND II  
 Memo : IDLE

	ReadAntenna	Cable	Preamp		Limit	Over		
Freq	Level	Factor	Loss	Factor	Level	Line	Limit	
MHz	dBuV	dB/m	dB	dB	dBuV/m	dBuV/m	dB	
1 pp 12764.00	29.09	39.08	17.22	38.64	46.75	54.00	-7.25	Average
2 pk 12764.00	34.94	39.08	17.22	38.64	52.60	74.00	-21.40	Peak

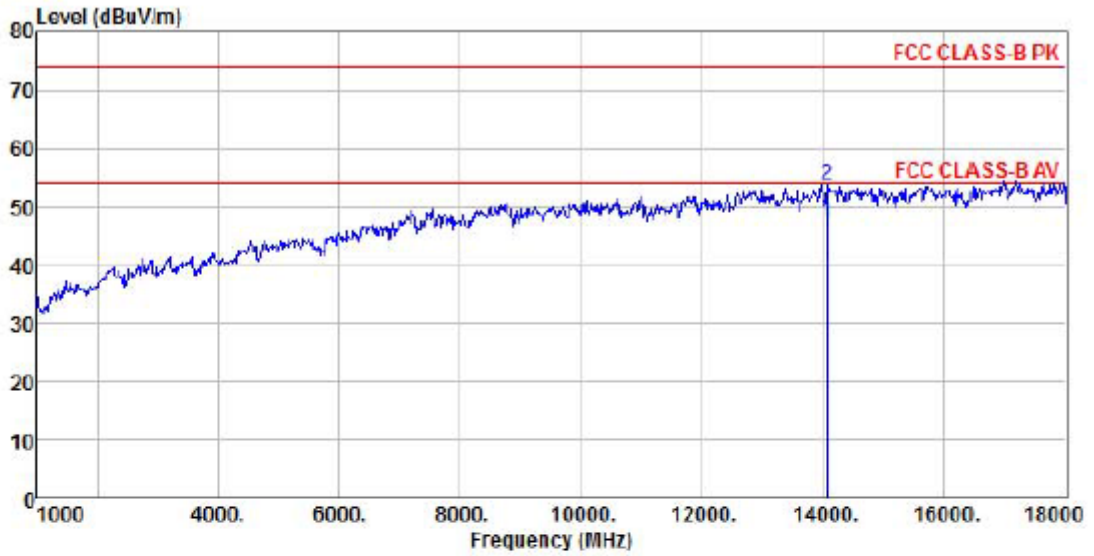

Site : chamber  
 Condition : FCC CLASS-B PK 3m BBHA9120D(942) VERTICAL  
 EUT :  
 Model Name : PD55-US  
 Temp/Humi : 22°C / 53 %  
 Power Rating: DC 12V  
 Mode : WCDMA BAND II  
 Memo : IDLE

Freq	ReadAntenna		Cable Preamp		Limit	Over	Remark
	Level	Factor	Loss	Factor			
MHz	dBuV	dB/m	dB	dB	dBuV/m	dBuV/m	dB
1 pp 14073.00	25.81	41.98	18.12	38.63	47.28	54.00	-6.72 Average
2 pk 14073.00	32.21	41.98	18.12	38.63	53.68	74.00	-20.32 Peak

## 6.Spurious Emission At Antenna Terminals (+/- 1MHz)

### 6.1. Test Equipment

Instrument	Manufacturer	Model	Serial No	Cal. Date
Radio Communication Tester	Agilent	E5515C	GB46581718	2015.10.24
Spectrum Analyzer	Agilent	N9038A	MY51210142	2014.12.17
DC Power Supply	Agilent	6612C	MY43002989	2015.03.03

The measure equipment had been calibrated once a year.

### 6.2. Test Setup

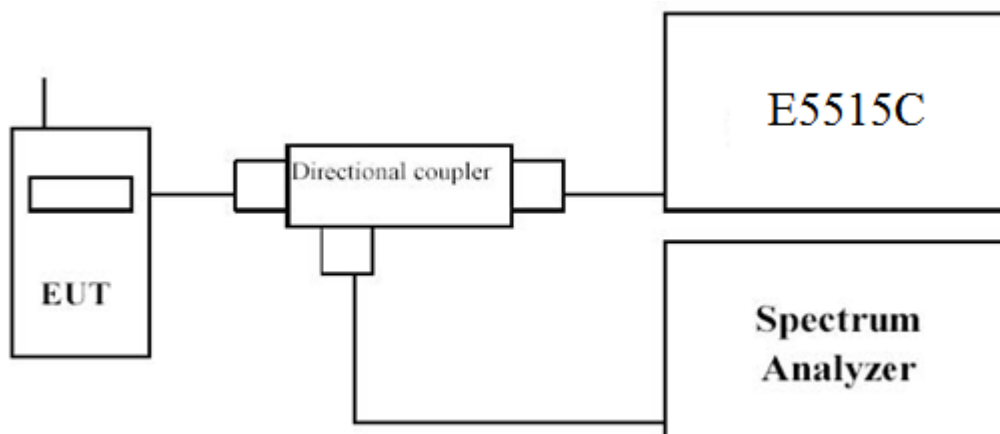

### **6.3. Limit**

The power of any emission outside of the authorized operating frequency ranges must be attenuated below the transmitting power (P) by a factor of at least  $43 + 10\log(P)$  dB.

### **6.4. Test Procedure**

In the 1MHz bands immediately outside and adjacent to the frequency block a resolution bandwidth of at least one percent of the emission bandwidth of the fundamental emission of the transmitter may be employed to measure the out of band Emissions.

### **6.5. Uncertainty**

The measurement uncertainty is defined as  $\pm 1.2$  dB.

### 6.6. Test Result

GSM850 (GSM Link), Channel 128

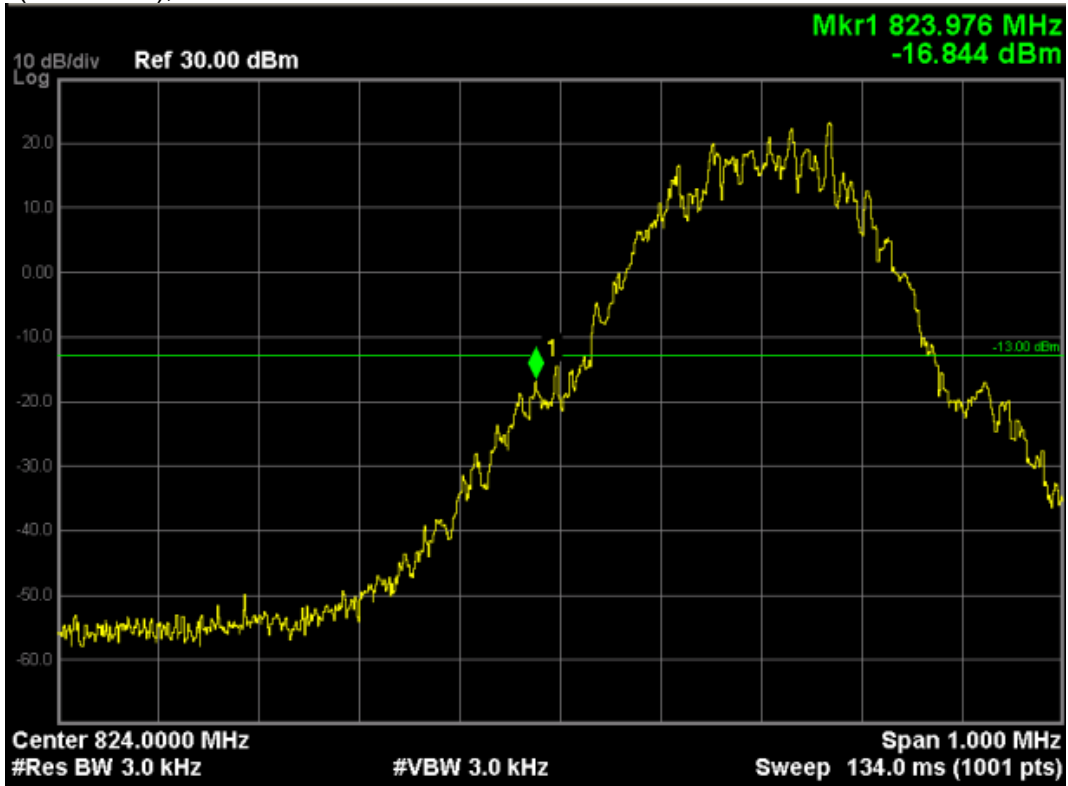

GSM850 (GSM Link), Channel 251

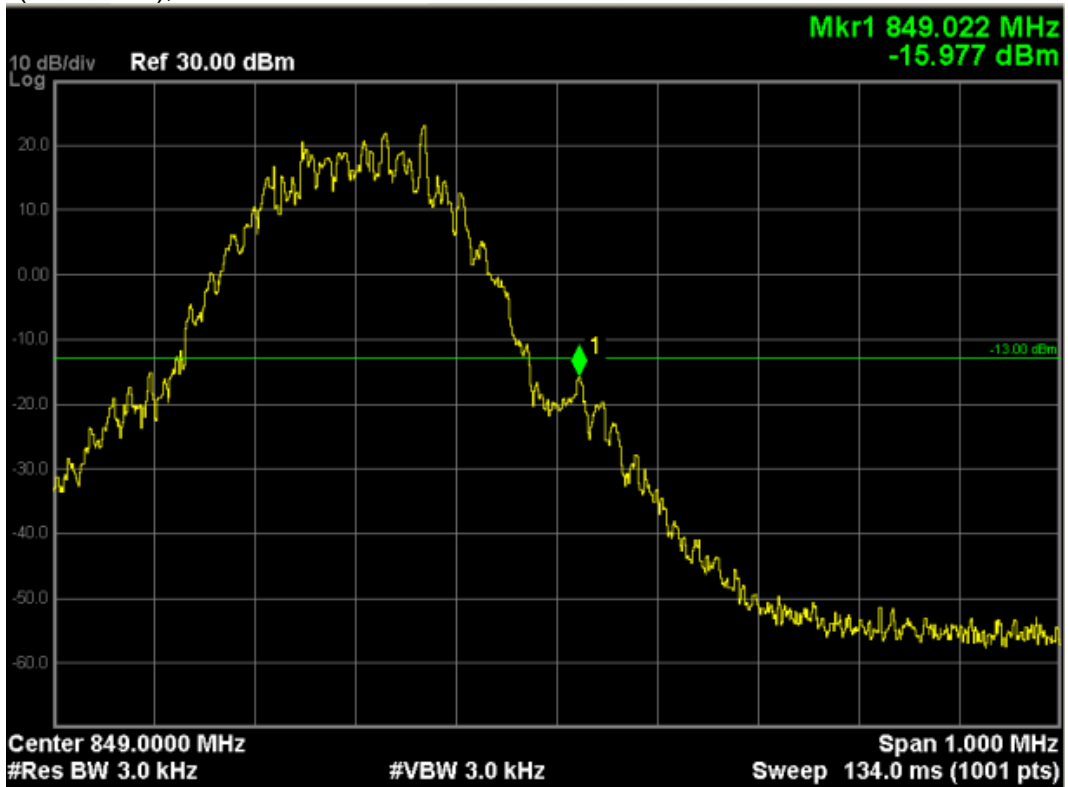

GSM850 (EDGE 8 Link), Channel 128

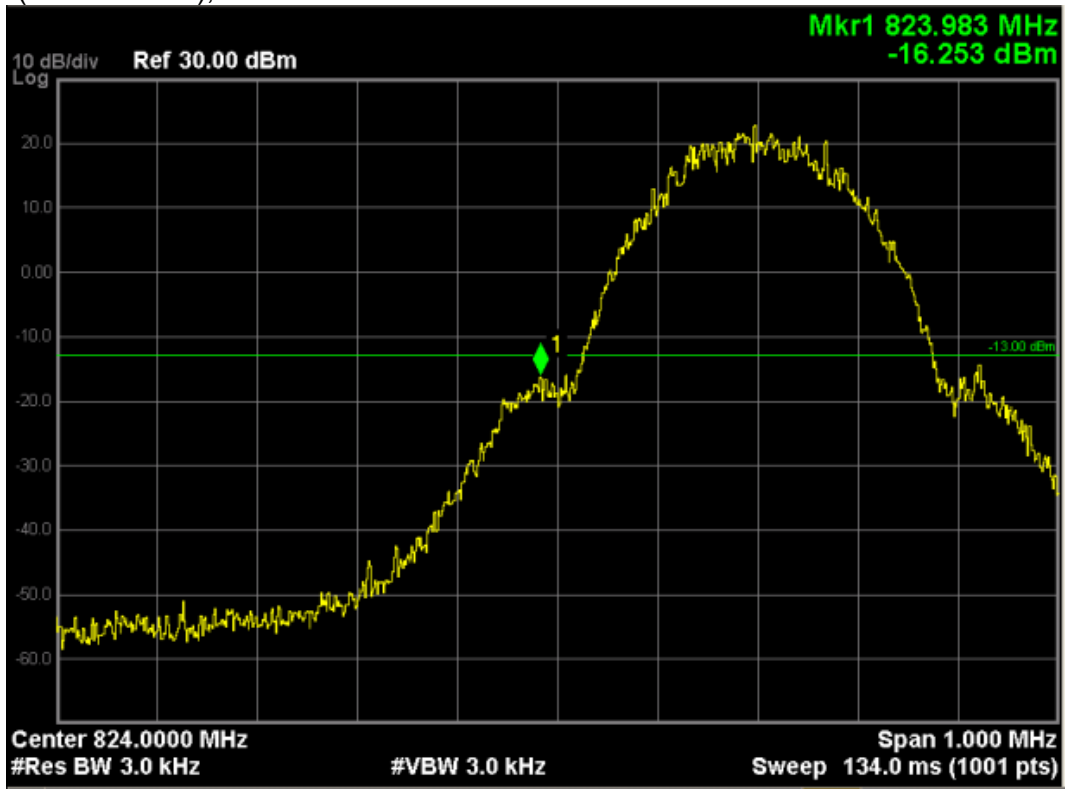

GSM850 (EDGE 8 Link), Channel 251

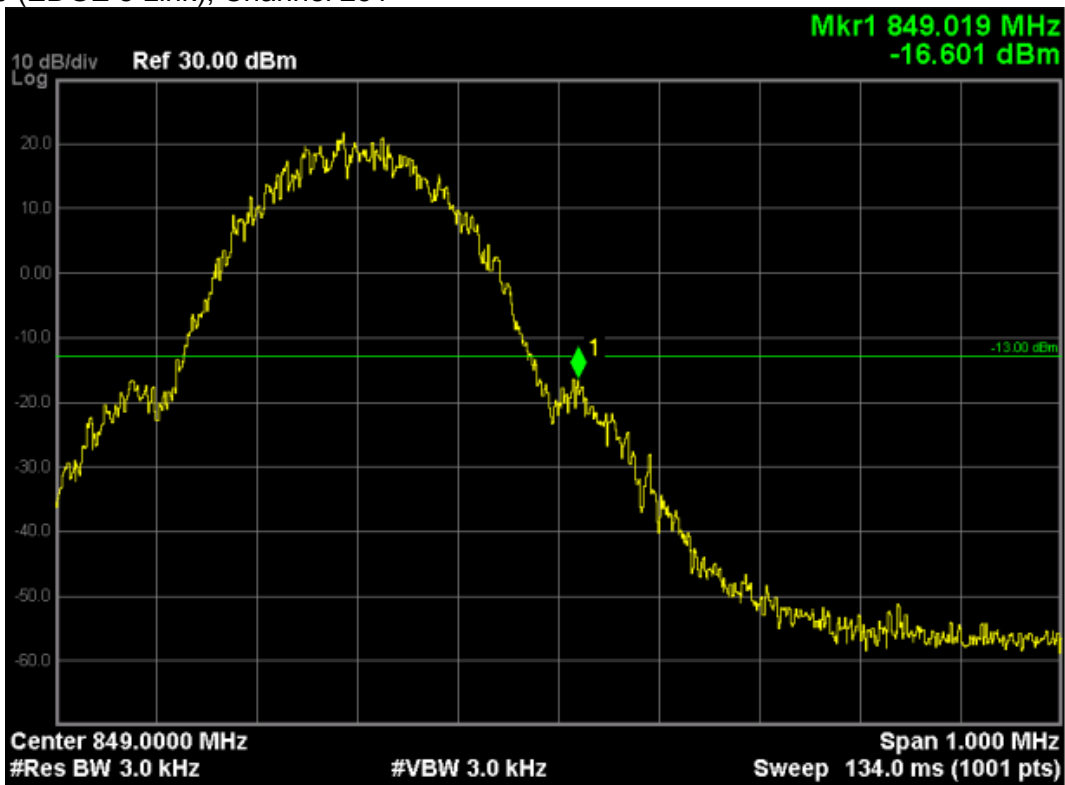



GSM 1900 (GSM Link), Channel 512

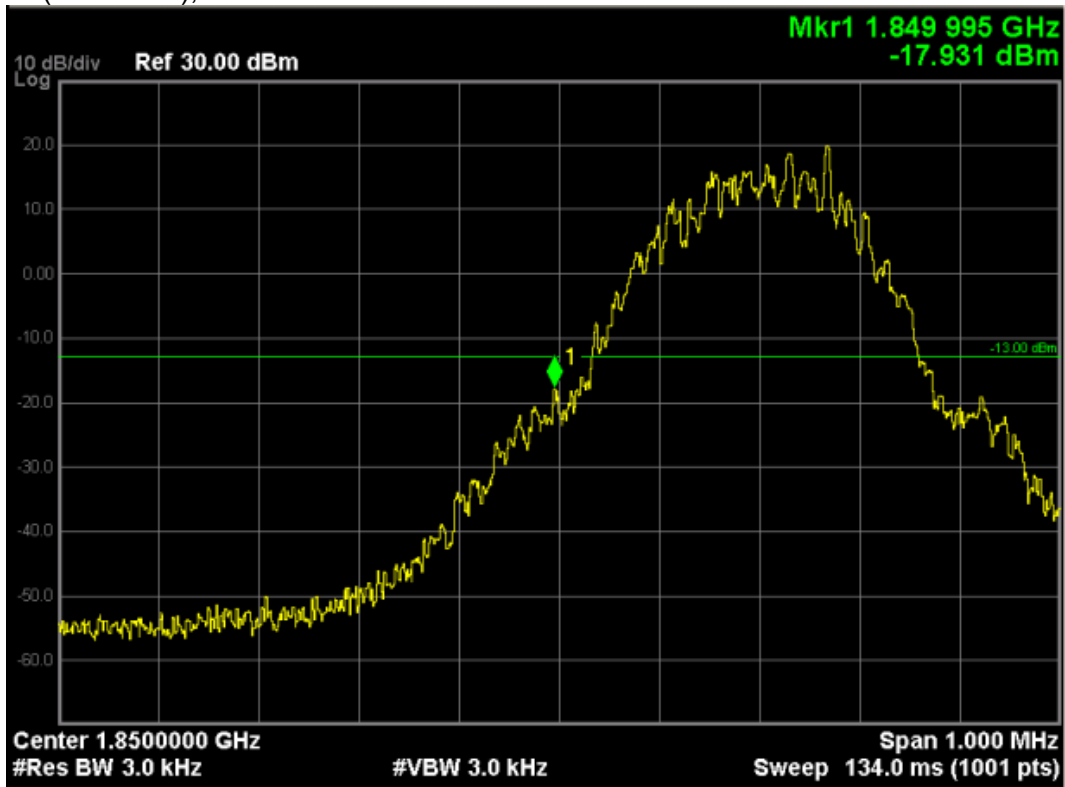

GSM 1900 (GSM Link), Channel 810

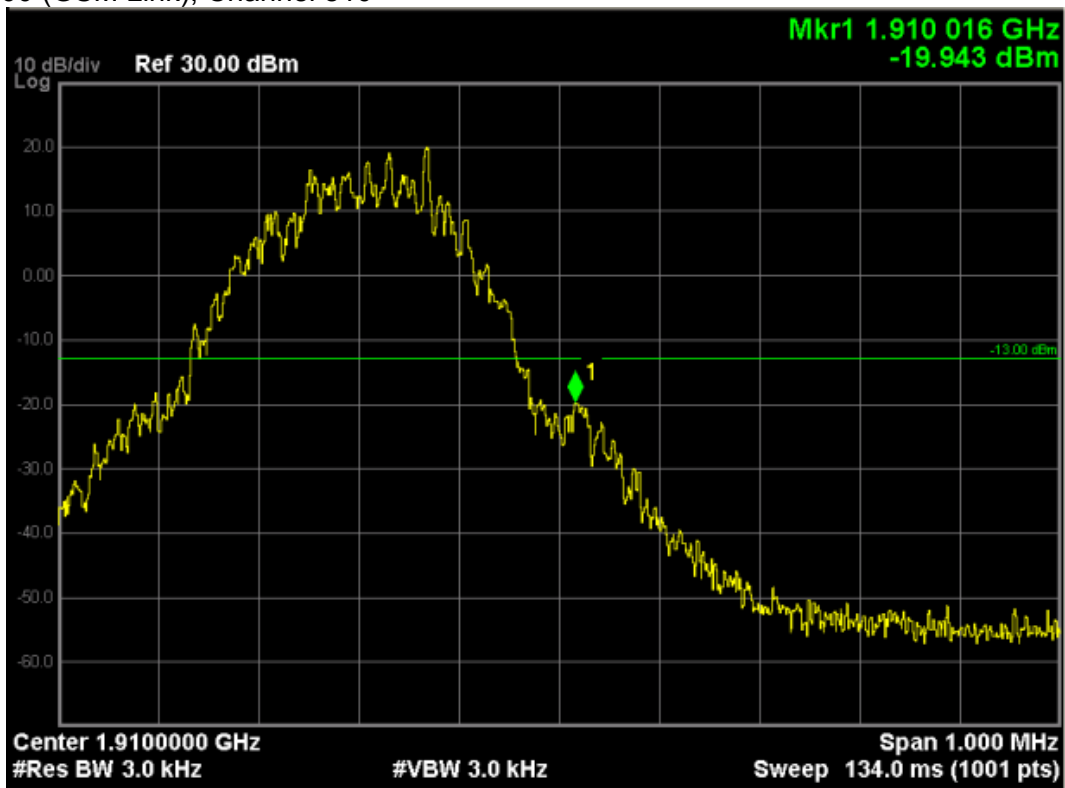

GSM1900 (EDGE 8 Link), Channel 512

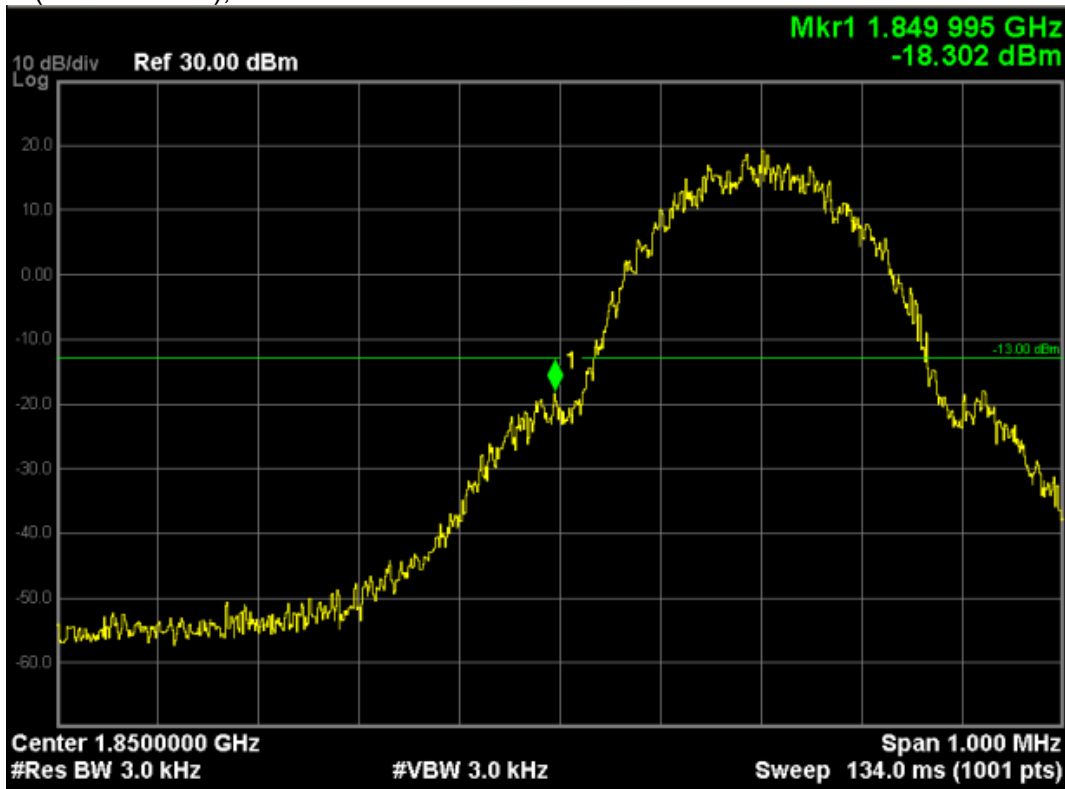

GSM1900 (EDGE 8 Link), Channel 810

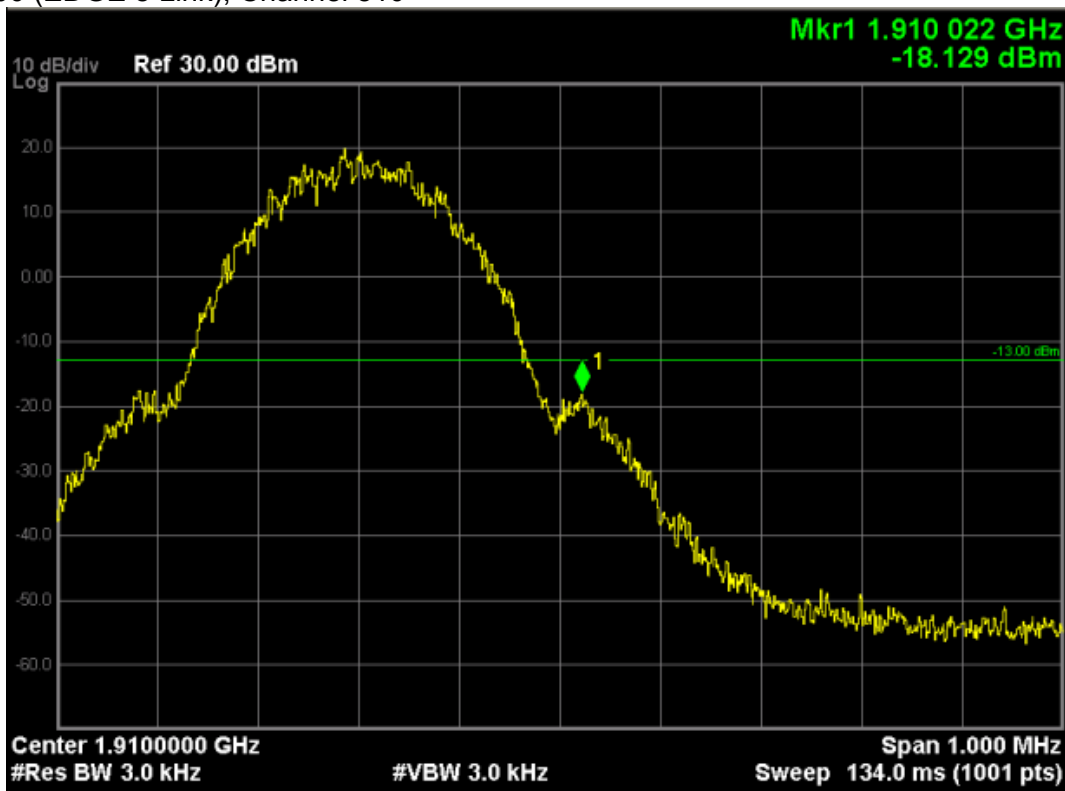

WCDMA Band V, Channel 4132

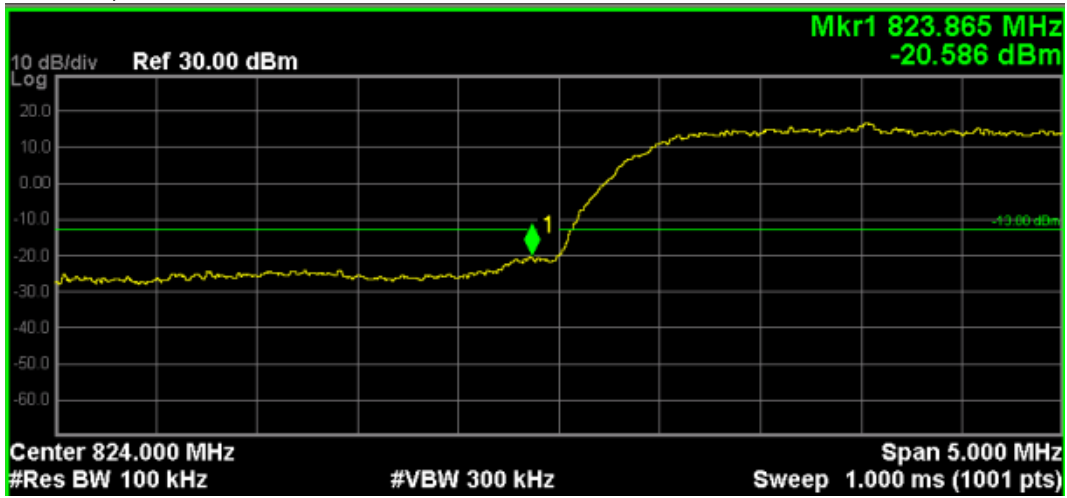

WCDMA Band V, Channel 4233



WCDMA Band II, Channel 9262

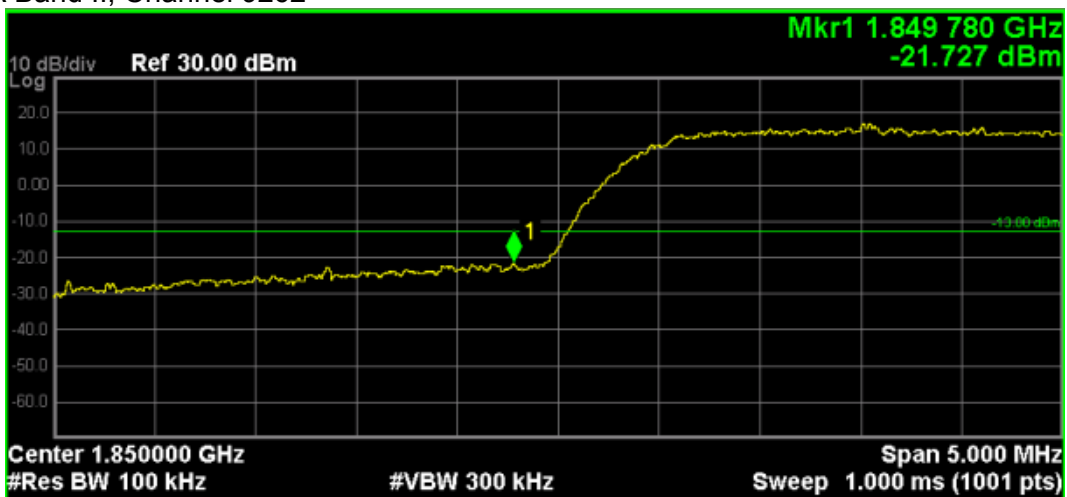

WCDMA Band II, Channel 9538

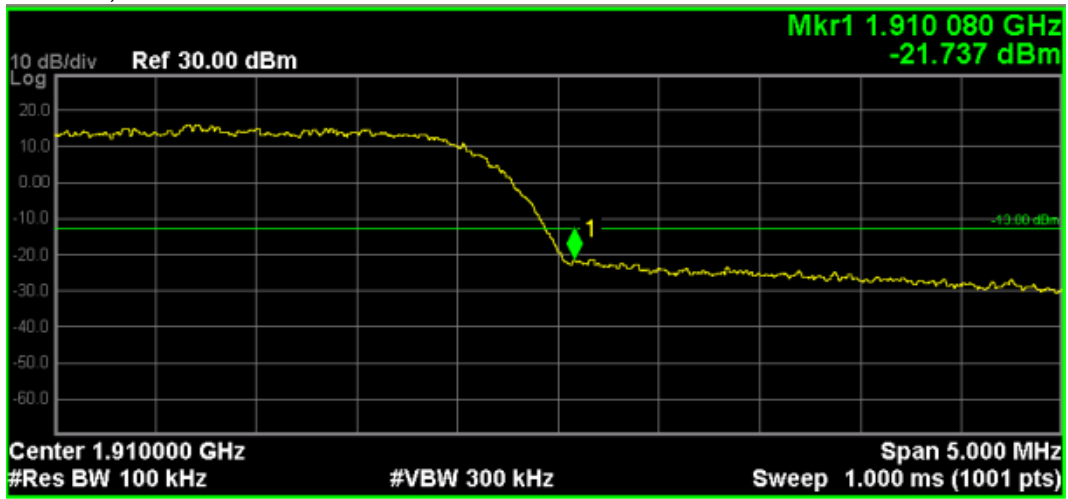

## **7. Attachment**

### **PHOTOGRAPHS OF TEST SETUP**

Please refer to the file named “QIPPDS5-US\_Part22&24 Setup Photos”.

### **PHOTOGRAPHS OF EUT**

Please refer to the two files named “QIPPDS5-US \_EUT External Photos” and “QIPPDS5-US \_EUT Internal Photos”.

----End of the report----