



SAR Test Report

FOR:

Manufacturer: TZ Medical, Inc.
Model Numbers: H40L
FCC ID: ZIMH40L
ISED ID: 9647A- H40L

Test Report #: SAR_TZMED-013-19001

Date of Report: 2020-05-06



CETECOM Inc.

411 Dixon Landing Road • Milpitas, CA 95035 • U.S.A.

Phone: + 1 (408) 586 6200 • Fax: + 1 (408) 586 6299 • E-mail: info@cetecom.com • <http://www.cetecom.com>

CETECOM Inc. is a Delaware Corporation with Corporation number: 2905571

TABLE OF CONTENTS

1. Assessment	4
2. Administrative Data	5
2.1. Identification of the Testing Laboratory Issuing the SAR Test Report	5
2.2. Identification of the Client and Manufacturer	5
3. Equipment under Test (EUT)	6
3.1. General Specification of the Equipment under Test	6
3.2. Identification of the Equipment under Test (EUT)	7
3.3. Identification of Accessory equipment	7
4. Subject of Investigation	8
4.1. The IEEE Standard C95.1 and the FCC Exposure Criteria	8
4.2. SAR Limit	8
5. Measurement Procedure	9
5.1. General Requirements	9
5.2. Body-worn and Other Configurations	9
5.3. System Check	9
5.4. Procedure for assessing the peak spatial-average SAR	10
5.5. Determination of the largest peak spatial-average SAR	12
5.6. SAR Scaling Using the Tune-Up Scaling Factor	12
6. The Measurement System	13
6.1. Robot system specification	13
6.2. Isotropic E-Field Probe for Dosimetric Measurements	14
6.3. Data Acquisition Electronics	14
6.4. Phantoms	14
6.5. Interpolation and Extrapolation schemes	14
7. Uncertainty Assessment	15
7.1. Measurement Uncertainty Budget According to IEEE 1528:2013	15
8. Test results summary	16
8.1. Conducted Power measurement results	16
8.2. Tune Up factor to manufacturer tolerances	16
8.3. Scaling factor based on non-continuous transmission	17

8.4.	SAR results for handheld use case measured at touch distance	18
8.5.	SAR results for body worn use case with holster at touch distance	20
8.6.	Conducted Power measurement screenshots	22
8.9.1	LTE 2.....	22
8.9.2	LTE 4.....	23
8.9.3	LTE 5.....	23
8.9.4	LTE 7.....	24
8.9.5	LTE 12.....	24
8.9.6	WCDMA II	25
8.9.7	WCDMA IV	25
8.9.8	WCDMA V	26
9.	References	27
10.	Report History.....	28

1. Assessment

The following device was evaluated against the limits for general population uncontrolled exposure specified in FCC 2.1093 according to measurement procedures specified in FCC regulation as listed in chapter 5 and IEEE 1528:2013 as well as the limits from RSS102 and no deviations were ascertained during the course of the tests performed.

The highest reported peak spatial SAR values found for the device are:

1.76 W/kg in 10g of tissue vs a limit of 4W/kg for handheld operation and

1.31 W/kg in 1g of tissue vs a limit of 1.6 W/kg for body worn operation with the holster supplied with the DUT

System validation results and liquid parameter measurements are in Appendix A of this report.

Setup pictures are in Appendix B of this report.

List of equipment used and calibration information are in Appendix C of this report.

Manufacturer	Description	Model #
TZ Medical, Inc.	Ambulator Electrocardiograph Monitor	H40L

Responsible for report and evaluation:

2020-05-06	Franz Engert	
Date	Name	Signature

The test results of this test report relate exclusively to the test item specified in Section 3.

CETECOM Inc. USA does not assume responsibility for any conclusions and generalizations drawn from the test results with regard to other specimens or samples of the type of the equipment represented by the test item. The test report may only be reproduced or published in full. Reproduction or publication of extracts from the report requires the prior written approval of CETECOM Inc. USA.

2. Administrative Data

2.1. Identification of the Testing Laboratory Issuing the SAR Test Report

Company Name	CETECOM Inc.
Department	Compliance
Address	411 Dixon Landing Road Milpitas, CA 95035 U.S.A.
Telephone	+1 (408) 586 6200
Fax	+1 (408) 586 6299
Responsible Project Manager	Cathy Palacios

2.2. Identification of the Client and Manufacturer

	Client	Manufacturer
Company	TZ Medical, Inc.	Same as Client
Street Address	17750 SW Upper Boones Ferry RD STE 150	-
City/Zip Code	Portland Oregon / 97224	-
Country	USA	-

3. Equipment under Test (EUT)

3.1. General Specification of the Equipment under Test

Model No	H40L
Model Name	Clarus 40L
FCC ID	ZIMH40L
ISED ID	9647A-H40L
Product Type	Portable
Prototype/Production	Production
RF Exposure Environment	General / Uncontrolled
HW Version	1.0
SW Version	1.7 Used for SAR measurement. 1.9 used for verification of power reduction on LTE 7.
Exposure Conditions	Body worn with holster, touching front, left and right side of device Handheld touching all sides except side with connector for sensor cables
Supported Radios	LTE Bands 2,4,5,7,12 WCDMA Bands II, IV, V GPRS 850, 1900
Power Back-Off Modes	None
Simultaneous Transmission Configurations	None
Date of Testing	2/10/2020 to 03/18/2020

3.2. Identification of the Equipment under Test (EUT)

EUT #	Serial Number	HW Version	SW Version	Comment
1	H3R3000014	1.0	1.7	Used for SAR testing and power verification after conversion to conducted unit
2	H3R3000014	1.0	1.9	After update to 1.9 verified power reduction by 1 dB for LTE 7.

3.3. Identification of Accessory equipment

AE #	Type	Manufacturer	Serial Number	Comments
1	Sensor Cable	TZ Medical, Inc.	NA	Electrodes to pick up bio electrical signals when placed on body.
2	Holster	TZ Medical, Inc.	NA	Supplied with the product. Belt Clip type.

4. Subject of Investigation

The objective of the measurements done by CETECOM Inc. was the dosimetric assessment of the EUT described in section 3. The tests were performed in configurations for devices operated next to a person's body. The examinations were carried out with the dosimetric assessment system DASY52 described in Section 6.

4.1. The IEEE Standard C95.1 and the FCC Exposure Criteria

The limits are set by CFR 47 FCC rule parts 1.1307 and 2.1093, following the recommendations in IEEE C95.1-1999 (ANSI/IEEE C95.1-1999), "IEEE Standard for Safety Levels with Respect to Human Exposure to Radio Frequency Electromagnetic Fields, 3 kHz to 300 GHz."

4.2. SAR Limit

In this report the comparison between the exposure limits and the SAR data is made using the spatial peak SAR.

Having in mind a worst case consideration, the SAR limit is valid for uncontrolled environment and portable transmitters. The SAR values have to be averaged over a mass of 1g (SAR_{1g}) and/or 10g (SAR_{10g}) with the shape of a cube.

Standard	Exposure Condition	Average SAR (W/kg)	Mass Average (g)
FCC CFR 47 Part 2.1093 (d)(2)	Partial-Body	1.6	1
FCC CFR 47 Part 2.1093 (d)(2)	Hands, Wrists, Feet and Ankles	4.0	10

5. Measurement Procedure

The Federal Communications Commission (FCC) requires routine dosimetric assessment of mobile telecom-communications devices, either by laboratory measurement techniques or by computational modeling, prior to equipment authorization or use. The measurement procedure shall be performed according to IEEE 1528:2013. The following KDB publications have additionally been applied:

865664 D01 V01R04 – SAR measurement 100 MHz to 6 GHz
941225 D05 V02R04 – SAR for LTE Devices
941225 D05A V01R02 LTE Rel. 10 KDB Inquiry Sheet

5.1. General Requirements

SAR evaluation was performed in a laboratory with an environment which avoids influence on SAR measurements by ambient EM sources and any reflection from the environment itself. The ambient temperature was in the range of 18°C to 25°C and 30-70% humidity. Simulating liquid temperature did not deviate more than 2°C throughout SAR evaluation.

5.2. Body-worn and Other Configurations

Test Position

The body-worn configurations shall be tested with the supplied accessories (belt-clips, holsters, etc.) attached to the device in normal use configuration. Devices with a headset output shall be tested with a connected headset.

Test to be Performed

For purpose of determining test requirements, accessories may be divided into two categories: those that do not contain metallic components and those that do. For multiple accessories that do not contain metallic components, the device may be tested only with that accessory which provides the closest spacing to the body. For multiple accessories that contain metallic components, the device must be tested with each accessory that contains a unique metallic component. If multiple accessories share an identical metallic component, only the accessory that provides the closest spacing to the body must be tested. If the manufacturer provides none body-worn accessories a separation distance of 1.5 cm between the back of the device and the flat phantom is recommended. Other separation distances may be used, but they shall not exceed 2.5 cm. In these cases, the device may use body-worn accessories that provide a separation distance greater than that tested for the device provided however that the accessory contains no metallic components.

For devices with retractable antenna the SAR test shall be performed with the antenna fully extended and fully retracted. Other factors that may affect the exposure shall also be tested. For example, optional antennas or optional battery packs which may significantly change the volume, lengths, flip open/closed, etc. of the device, or any other accessories which might have the potential to considerably increase the peak spatial-average SAR value.

5.3. System Check

The purpose of the system check is to verify that the system operates within its specifications. System check is performed within 24 hours prior to compliance testing for each liquid type and frequency band. The system check result is verified to be within $\pm 10\%$ of the reference dipole source as measured during calibration of the dipole.

Phantom Set-Up

A flat phantom is used with the same tissue-equivalent liquid that will be used during compliance testing. The dipole feed point is placed at the centre of the flat phantom and the dipole arms are aligned with the major axis.

Standard Source

A reference dipole source is used to irradiate the phantom. The dipole is placed under the bottom of the phantom and centred with its axis parallel to the longest dimension of the phantom. A low loss spacer is used to establish the correct distance between the top

surface of the dipole and the bottom surface of the phantom. For frequencies below 1 GHz, a spacing of 15 mm is used. For frequencies above 1 GHz, a spacing of 10 mm is used. The dipole has a return loss of less than -20 dB at the resonant frequency.

System Check Procedure

The test set-up is as follows:

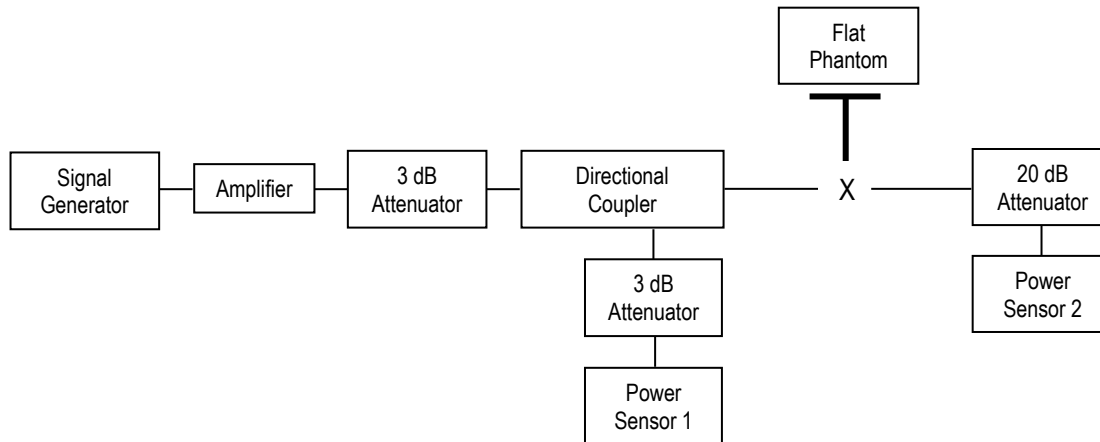

1. The cable at the output of the directional coupler is connected to the 20 dB attenuator.
2. The signal generator is adjusted until the desired input power to the dipole is measured at power sensor 2. The forward power of the directional coupler is measured with power sensor 1 and noted for step 4.
3. The cable at the output of the directional coupler is connected to the dipole source.
4. The signal generator is adjusted until power sensor 1 measures the same power as in step 2.
5. A SAR measurement is performed with the dipole source radiating.
6. During the system check test, the power measured by power sensor 1 is monitored to ensure the power does not drift.
7. At the conclusion of the SAR measurement, the SAR result is normalized to a dipole input power of 1 W and compared to the 1 W reference SAR value in the dipole calibration report. The difference between the measured SAR and the reference SAR is verified to be within $\pm 10\%$.

5.4. Procedure for assessing the peak spatial-average SAR

Step 1: Power reference measurement:

Prior to the SAR test, a local SAR measurement should be taken at a user-selected spatial reference point to monitor power variations during testing.

Step 2: Area scan

The measurement procedures for evaluating SAR associated with wireless handsets typically start with a coarse measurement grid in order to determine the approximate location of the local peak SAR values. This is referred to as the "area scan" procedure. The SAR distribution is scanned along the inside surface of typically half of the head of the phantom but at least larger than the areas projected (normal to the phantom's surface) by the handset and antenna. An example grid is given in Figure 4. The distance between the measured points and phantom surface should be less than 8 mm, and should remain constant (variation less than ± 1 mm) during the entire scan in order to determine the locations of the local peak SAR with sufficient precision. The distance between the measurement points should enable the detection of the location of local maximum with an accuracy of better than half the linear dimension of the tissue cube after interpolation. The approximate locations of the peak SARs should be determined from area scan. Since a given amplitude local peak with steep gradients may produce lower spatial-average SAR than slightly lower amplitude peaks with less steep gradients, it is necessary to evaluate the other peaks as well. However, since the spatial gradients of local SAR peaks are a function of wavelength inside the tissue simulating liquid and incident magnetic field strength, it is not necessary to evaluate peaks that are less than -2dB of the local maximum. Two-dimensional spline algorithms [Press, et al, 1996], [Brishoual, 2001] are typically used to determine the peaks and gradients within the scanned area. If the peak is closer than one-half of the linear dimension of the 1 g or 10 g tissue cube to the scan border, the measurement area should be enlarged if possible, e.g., by tilting the probe or the phantom (see Figure 5).

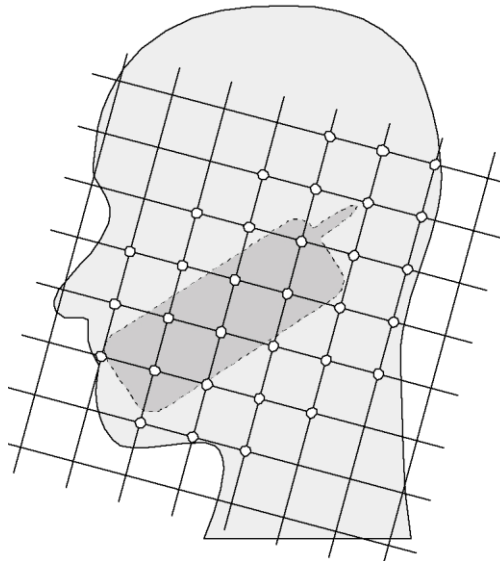

Figure 4 – Example of an area scan including the position of the handset. The scanned area (white dots) should be larger than the area projected by the handset and antenna.

The SPEAG DASY SAR system uses a mechanical sensor detection to find the phantom surface. To decrease test time, the DASY software allows the operator to choose an option where the SAR probe will reuse measurement locations from a previous identical area scan. With this option enabled, the DASY system will not use mechanical sensor detection to find the phantom surface. Locations of each measurement point of the area scan is taken at the same locations as an identical area scan if one is available. Area scans that reused location of measurement points is noted in the result plots under DASY Configuration > Sensor-Surface.

Step 3: Zoom scan

In order to assess the peak spatial SAR values averaged over a 1 g and 10 g cube, fine resolution volume scans, called "zoom scans", are performed at the peak SAR locations determined during the "area scan." The zoom scan volume should have at least 1.5 times the linear dimension of either a 1 g or a 10 g tissue cube for whichever peak spatial-average SAR is being evaluated. The peak local SAR locations that were determined in the area scan (interpolated value) should be on the centerline of the zoom scans. The centerline is the line that is normal to the surface and in the center of the volume scan. If this is not possible, the zoom scan can be shifted but not by more than half the dimension of the 1 g or a 10 g tissue cube.

The maximum spatial-average SAR is determined by a numerical analysis of the SAR values obtained in the volume of the zoom scan, whereby interpolation (between measured points) and extrapolation (between surface and closest measured points) routines should be applied. A 3-D-spline algorithm [Press, et al, 1996], [Kreyszig, 1983], [Brishoual, 2001] can be used for interpolation and a trapezoidal algorithm for the integration (averaging). Scan resolutions of larger than 2 mm can be used provided the uncertainty is evaluated according to E (see E.5).

In some areas of the phantom, such as the jaw and upper head region, the angle of the probe with respect to the line normal to the surface might become large, e.g., at angles larger than $\pm 30^\circ$ (see Figure 5), which may increase the boundary effect to an unacceptable level. In these cases, a change in the orientation of the probe and/or the phantom is recommended during the zoom scan so that the angle between the probe housing tube and the line normal to the surface is significantly reduced ($<30^\circ$).

Step 4: Power reference measurement

The local SAR should be measured at exactly the same location as in Step 1. The absolute value of the measurement drift (the difference between the SAR measured in Step 4 and Step 1) should be recorded in the uncertainty budget. It is recommended that the drift be kept within $\pm 5\%$. If this is not possible, even with repeat testing, additional information may be used to demonstrate the power stability during the test. Power reference measurements can be taken after each zoom scan, if more than one zoom scan is needed. However, the drift should always be referred to the initial state with fully charged battery.

5.5. Determination of the largest peak spatial-average SAR

In order to determine the largest value of the peak spatial-average SAR of a handset, all device positions, configurations and operational modes should be tested for each frequency band according to steps 1 to 3 below.

Step 1: The tests of 6.4 should be conducted at the channel that is closest to the center of the transmit frequency band (*f_c*) for:

- a) All device positions (cheek and tilt, for both left and right sides of the SAM phantom,
- b) All configurations for each device position in (a), e.g. antenna extended and retracted, and
- c) All operational modes for each device position in (a) and configuration in (b) in each frequency band, e.g. analog and digital.

If more than three frequencies need to be tested, (i.e., $N_c > 3$), then all frequencies, configurations and modes must be tested for all of the above positions.

Step 2: For the condition providing highest spatial peak SAR determined in Step 1 conduct all tests of 6.4 at all other test frequencies, e.g. lowest and highest frequencies. In addition, for all other conditions (device position, configuration and operational mode) where the spatial peak SAR value determined in Step 1 is within 3dB of the applicable SAR limit, it is recommended that all other test frequencies should be tested as well.

Step 3: Examine all data to determine the largest value of the peak spatial-average SAR found in Steps 1 to 2.

5.6. SAR Scaling Using the Tune-Up Scaling Factor

Conducted output power is tested to check if the EUT is transmitting at the maximum power allowed according to the declared maximum power including tune-up power tolerances. When the conducted output power is less than the maximum output power including tolerance, the measured SAR values are scaled up to the maximum output power including tolerance to ensure all production units are within SAR limits.

The tune-up power scaling factor is a multiplicative factor. The tune-up power scaling factor is calculated as:

$$10^{[(\text{Maximum Output Power Including Tolerance} - \text{Measured Conducted Output Power}) / 10]}$$

Where

Maximum Output Power Including Tolerance: dBm

Measured Conducted Output Power: dBm

Example SAR scaling calculation:

Measured Conducted Output Power (dBm)	Maximum Output Power Including Tolerance (dBm)	Tune-Up Power Scaling Factor	Measured 1g SAR (W/kg)	Scaled/Reported SAR value (W/kg)
32.0	32.5	1.12	1.0	1.12

6. The Measurement System

6.1. Robot system specification

The SAR measurement system being used is the SPEAG DASY52 system, which consists of a Stäubli TX90XL 6-axis robot arm and CS8c controller, SPEAG SAR Probe, Data Acquisition Electronics, and SAM Twin Phantom. The robot is used to articulate the probe to programmed positions inside the phantom to obtain the SAR readings from the EUT.

The system is controlled remotely from a PC, which contains the software to control the robot and data acquisition equipment. The software also displays the data obtained from test scans.

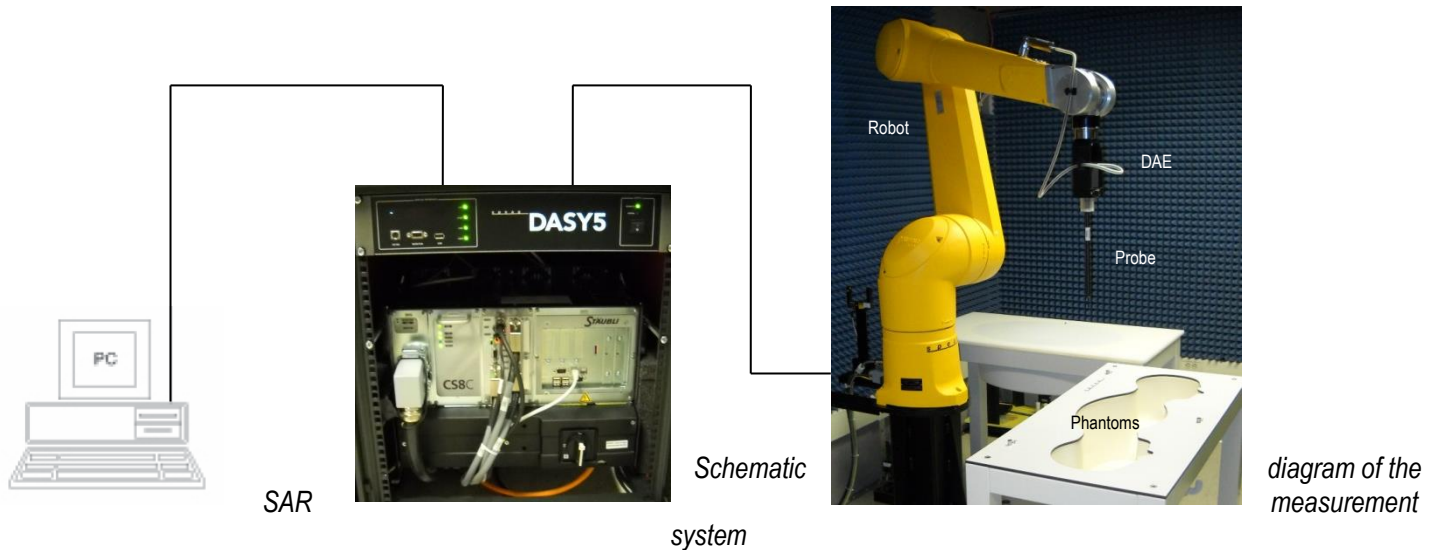

In operation, the system first does an area (2D) scan at a fixed depth within the liquid from the inside wall of the phantom. When the maximum SAR point has been found, the system will then carry out a 3D scan centered at that point to determine volume averaged SAR level.

6.2. Isotropic E-Field Probe for Dosimetric Measurements

The probes are constructed using three orthogonal dipole sensors arranged on an interlocking, triangular prism core. The probes have built-in shielding against static charges and are contained within a PEEK cylindrical enclosure material at the tip. Probe calibration is described in the probe's calibration certificate.

6.3. Data Acquisition Electronics

The DAE contains a signal amplifier, multiplexer, 16bit A/D converter and control logic. It uses an optical link for communication with the DASY5 system. The DAE has a dynamic range of -100 to 300 mV. It also contains a two step probe touch detector for mechanical surface detection and emergency robot stop.

6.4. Phantoms

The Twin SAM V4.0 Phantom is designed to specifications defined in IEEE 1528, and IEC/EN 62209-1. It enables the dosimetric evaluation of left and right hand phone usage as well as body mounted usage at the flat phantom region. The material shell thickness is 2mm +/- 0.2 mm at the flat section and 6mm +/- 0.2 mm at the ear reference point. The relative permativity is 3.5 +/- 0.5 and the loss tangent is ≤ 0.05 for frequencies ≤ 6 GHz.

Additionally, the Oval Flat ELI V4.0 Phantom is designed to specification defined in IEEE 1528, and IEC/EN 62209-2. It enables the dosimetric evaluation of body mounted usage. The material thickness is 2mm +/- 0.2 mm. For frequencies ≤ 6 GHz, the relative permativity is 4 +/- 1 and the loss tangent is ≤ 0.05 . The bottom plate is 600 x 400 mm elliptical shape with a depth of 190 mm.

6.5. Interpolation and Extrapolation schemes

The interpolation, extrapolation and maximum search routines are all based on the modified Quadratic Shepard's method. The interpolation scheme combines a least-square fitted function method and a weighted average method which are the two basic types of computational interpolation and approximation. The routines construct a once-continuously differentiable function that interpolates the measurement values.

7. Uncertainty Assessment

The uncertainty budget is included as required and as applicable for the FCC when the highest measured SAR in a band is $\geq 1.5\text{W/kg}$ per KDB 865664 section 2.8.2.

7.1. Measurement Uncertainty Budget According to IEEE 1528:2013

The uncertainty values for components specified were evaluated according to the procedures of *IEEE 1528-2013*, *NIST 1297 1994 edition* and *ISO Guide to the Expression of Uncertainty in Measurements (GUM)*.

a	b	c	d	$e = f(d,k)$	f	g	$h = c \times f / e$	$i = c \times f / e$	k
Uncertainty Component	Sec.	Tol. (%)	Prob. Dist.	Div.	c_i (1-g)	c_i (10-g)	1-g u_i (%)	10-g u_i (%)	v_i
Measurement System									
Probe Calibration	E2.1	6.55	N	1	1	1	6.55	6.55	∞
Axial Isotropy	E2.2	4.7	R	$\sqrt{3}$	0.7	0.7	1.9	1.9	∞
Hemispherical Isotropy	E2.2	9.6	R	$\sqrt{3}$	0.7	0.7	3.9	3.9	∞
Boundary Effect	E2.3	2	R	$\sqrt{3}$	1	1	1.2	1.2	∞
Linearity	E2.4	4.7	R	$\sqrt{3}$	1	1	2.7	2.7	∞
System Detection Limits	E2.4	1	R	$\sqrt{3}$	1	1	0.6	0.6	∞
Probe Modulation Response	E2.5	2.4	R	$\sqrt{3}$	1	1	1.4	1.4	∞
Readout Electronics	E2.6	0.3	N	1	1	1	0.3	0.3	∞
Response Time	E2.7	0.8	R	$\sqrt{3}$	1	1	0.5	0.5	∞
Integration Time	E2.8	2.6	R	$\sqrt{3}$	1	1	1.5	1.5	∞
RF Ambient Noise	E6.1	3	R	$\sqrt{3}$	1	1	1.7	1.7	∞
RF Ambient Reflections	E6.1	3	R	$\sqrt{3}$	1	1	1.7	1.7	∞
Probe Positioner Mechanical Tolerance	E6.2	0.8	R	$\sqrt{3}$	1	1	0.5	0.5	∞
Probe Positioning with respect to Phantom Shell	E6.3	6.7	R	$\sqrt{3}$	1	1	3.9	3.9	∞
Extrapolation, interpolation and Integration Algorithms for Max. SAR Evaluation	E5.2	4	R	$\sqrt{3}$	1	1	2.3	2.3	∞
Test sample Related									
Test Sample Positioning	E4.2	2.9	N	1	1	1	2.9	2.9	145
Device Holder Uncertainty	E4.1	3.6	N	1	1	1	3.6	3.6	5
Output Power Variation - SAR drift measurement	E2.9	5	R	$\sqrt{3}$	1	1	2.9	2.9	∞
SAR Power Scaling	E.6.5	0	R	$\sqrt{3}$	1	1	0.0	0.0	∞
Phantom and Tissue Parameters									
Phantom Uncertainty (shape and thickness tolerances)	E3.1	6.6	R	$\sqrt{3}$	1	1	3.8	3.8	∞
Uncertainty in SAR Correction	E.3.2	1.9	R	$\sqrt{3}$	1	0.84	1.9	1.6	∞
Liquid Conductivity Target - tolerance	E3.3	2.5	R	$\sqrt{3}$	0.78	0.71	2.0	1.8	∞
Liquid Permittivity Target tolerance	E3.3	2.5	R	$\sqrt{3}$	0.26	0.26	0.7	0.7	∞
Liquid Conductivity - Temp uncertainty	E3.4	3.4	N	$\sqrt{3}$	0.78	0.71	2.7	2.4	∞
Liquid Permittivity - Temp uncertainty	E3.4	0.4	N	$\sqrt{3}$	0.23	0.26	0.1	0.1	∞
Combined Standard Uncertainty			RSS				12.7	12.6	748
Expanded Uncertainty (95% CONFIDENCE INTERVAL)			$k=2.00705$				25.4	25.2	

8. Test results summary

8.1. Conducted Power measurement results

The following conducted RMS powers were measured on the test sample after completion of SAR measurements and conversion of sample into a conducted unit. Measurement instrument used was R&S CMW 500. Screenshots of Power measurements are available in section 8.9.

Band	Center Frequency (MHz)	Bandwidth of signal	Power measured [dBm]
LTE-2	1880	10MHz	22.07
LTE-4	1732.5	10MHz	22.24
LTE-5	836.5	10MHz	21.98
LTE-7	2535.0	10MHz	22.5
LTE-12	707.5	10MHz	22.30
WCDMA II	1880	5MHz	24.68
WCDMA IV	1732.5	5MHz	24.70
WCDMA V	826.4	5MHz	24.69
GPRS 850 4TS	536.5	200kHz	32.50
GPRS 1900 4TS	1880	200kHz	32.40

8.2. Tune Up factor to manufacturer tolerances

Conducted measurement results are scaled up to the maximum available power from the integrated module PLS62-W from Gemalto. This will provide for worst case scenario encountered with regards to tolerances of the device.

Band	Center Frequency (MHz)	Power measured [dBm]	Maximum Tune Up Tolerance [dBm]	Tune up factor [dB]	Tune up factor [lin]
LTE-2	1880	22.07	25	3	2
LTE-4	1732.5	22.24	25	3	2
LTE-5	836.5	21.98	25	3	2
LTE-7	2535.0	22.50	24*	1.5	1.42
LTE-12	707.5	22.30	25	3	2
WCDMA II	1880	24.68	25	0.5	1.12
WCDMA IV	1732.5	24.70	25	0.5	1.12
WCDMA V	826.4	24.69	25	0.5	1.12
GPRS 850 4TS	536.5	32.50	35	2.5	1.78
GPRS 1900 4TS	1880	31.40	32	0.5	1.12

* The power of the certified module is reduced by 1dB through AT command from SW of the product during configuration of the module as compared to default configuration of module from the default 23 dBm output to 22 dBm output. The power measurement of 22.5dBm as well as the SAR measurement was performed with default module configuration. The 1 dB reduction was verified to reduce the power by 1.05 dB after converting the device under test to conducted unit. To account for the 1 dB reduction the maximum tune up tolerance is reduce by 1 dB.

Output power (according to release 99)	Class 4 (+33dBm \pm 2dB) for EGSM850 Class 4 (+33dBm \pm 2dB) for EGSM900 Class 1 (+30dBm \pm 2dB) for GSM1800 Class 1 (+30dBm \pm 2dB) for GSM1900 Class E2 (+27dBm \pm 3dB) for GSM 850 8-PSK Class E2 (+26dBm \pm 3dB) for GSM 900 8-PSK Class E2 (+26dBm +3 /-4dB) for GSM 1800 8-PSK Class E2 (+26dBm +3 /-4dB) for GSM 1900 8-PSK
Output power (according to Release 99)	Class 3 (+24dBm +1/-3dB) for UMTS 800, WCDMA FDD BdXIX Class 3 (+24dBm +1/-3dB) for UMTS 850, WCDMA FDD BdV Class 3 (+24dBm +1/-3dB) for UMTS 900, WCDMA FDD BdVIII Class 3 (+24dBm +1/-3dB) for UMTS AWS, WCDMA FDD BdIV Class 3 (+24dBm +1/-3dB) for UMTS 1800, WCDMA FDD BdIX Class 3 (+24dBm +1/-3dB) for UMTS 1900, WCDMA FDD BdII Class 3 (+24dBm +1/-3dB) for UMTS 2100, WCDMA FDD BdI
Output power (according to Release 8)	Class 3 (+23dBm \pm 2dB) for LTE 700, LTE FDD Bd12 <MFBI Bd17> Class 3 (+23dBm \pm 2dB) for LTE 700, LTE FDD Bd28 Class 3 (+23dBm \pm 2dB) for LTE 800, LTE FDD Bd18 Class 3 (+23dBm \pm 2dB) for LTE 800, LTE FDD Bd19 Class 3 (+23dBm \pm 2dB) for LTE 800, LTE FDD Bd20 Class 3 (+23dBm \pm 2dB) for LTE 850, LTE FDD Bd5 Class 3 (+23dBm \pm 2dB) for LTE 900, LTE FDD Bd8 Class 3 (+23dBm \pm 2dB) for LTE AWS, LTE FDD Bd4 Class 3 (+23dBm \pm 2dB) for LTE 1800, LTE FDD Bd3 Class 3 (+23dBm \pm 2dB) for LTE 1900, LTE FDD Bd2 Class 3 (+23dBm \pm 2dB) for LTE 2100, LTE FDD Bd1 Class 3 (+23dBm \pm 2dB) for LTE 2600, LTE FDD Bd7

8.3. Scaling factor based on non-continuous transmission

LTE:
 Based on declaration by manufacturer as the device is limited to transmit for no more than 3 minutes inside any 6 minute window. This results in a duty cycle of 0.5.

WCDMA:
 No reduction of duty cycle within a 6 minute window.

GPRS:
 No reduction of duty cycle within a 6 minute window. The duty factor of 0.5 is already considered by dasy5.2 when setting up the modulation scheme.

8.4. SAR results for handheld use case measured at touch distance

Side of product / RAT	SAR result [W/kg] [10g]	Drift [dB] ⁽¹⁾	Scaling factor Tune Up	Scaling factor duty cycle	Reported SAR [W/kg] [10g]	Limit [W/kg] [10g]	Verdict
Front / UMTS V	0.533	-0.18	1.12	1	0.597	4	PASS
Left / UMTS V	0.343	-0.15	1.12	1	0.384	4	PASS
Right / UMTS V	0.165	-0.29	1.12	1	0.185	4	PASS
Back / UMTS V	0.765	-0.18	1.12	1	0.857	4	PASS
Top / UMTS V	0.176	-0.54	1.12	1	0.197	4	PASS
Front / UMTS II	1.21	-0.11	1.12	1	1.355	4	PASS
Left / UMTS II	0.29	-0.22	1.12	1	0.325	4	PASS
Right / UMTS II	0.497	0.01	1.12	1	0.557	4	PASS
Back / UMTS II	1.57	-0.11	1.12	1	1.758	4	PASS
Top / UMTS II	0.388	-0.73	1.12	1	0.435	4	PASS
Front / UMTS IV	0.643	0.15	1.12	1	0.720	4	PASS
Left / UMTS IV	0.174	0.07	1.12	1	0.195	4	PASS
Right / UMTS IV	0.281	-0.08	1.12	1	0.315	4	PASS
Back / UMTS IV	0.188	0.2	1.12	1	0.211	4	PASS
Top / UMTS IV	0.105	0.02	1.12	1	0.118	4	PASS

Front / GPRS 850	0.208	0.02	1.78	1	0.370	4	PASS
Left / GPRS 850	0.145	-0.03	1.78	1	0.258	4	PASS
Right / GPRS 850	0.064	0.16	1.78	1	0.114	4	PASS
Back / GPRS 850	0.273	0.01	1.78	1	0.486	4	PASS
Top / GPRS 850	0.057	-0.31	1.78	1	0.101	4	PASS
Front / GPRS 1900	0.579	0.07	1.12	1	0.648	4	PASS
Left / GPRS 1900	0.156	0.36	1.12	1	0.175	4	PASS
Right / GPRS 1900	0.411	-0.11	1.12	1	0.460	4	PASS
Back / GPRS 1900	0.786	-0.02	1.12	1	0.880	4	PASS
Top / GPRS 1900	0.204	0.09	1.12	1	0.228	4	PASS

Front / LTE 2	0.746	0.5	2	0.5	0.746	4	PASS
Left / LTE 2	0.177	-0.19	2	0.5	0.177	4	PASS
Right / LTE 2	0.575	-0.16	2	0.5	0.575	4	PASS
Back / LTE 2	0.941	0.02	2	0.5	0.941	4	PASS
Top / LTE 2	0.271	0.03	2	0.5	0.271	4	PASS
Front / LTE 4	1.19	0.16	2	0.5	1.190	4	PASS
Left / LTE 4	0.183	0.03	2	0.5	0.183	4	PASS
Right / LTE 4	0.712	-0.02	2	0.5	0.712	4	PASS
Back / LTE 4	1.18	0.14	2	0.5	1.180	4	PASS
Top / LTE 4	0.491	-0.06	2	0.5	0.491	4	PASS
Front / LTE 5	0.459	-0.09	2	0.5	0.459	4	PASS
Left / LTE 5	0.105	-0.58	2	0.5	0.105	4	PASS
Right / LTE 5	0.211	-0.14	2	0.5	0.211	4	PASS
Back / LTE 5	0.509	-0.06	2	0.5	0.509	4	PASS
Top / LTE 5	0.154	-0.38	2	0.5	0.154	4	PASS
Front / LTE 7	2.2	0.03	1.42	0.5	1.562	4	PASS
Left / LTE 7	1.06	0.33	1.42	0.5	0.753	4	PASS
Right / LTE 7	0.846	0.09	1.42	0.5	0.601	4	PASS
Back / LTE 7	1.47	0.29	1.42	0.5	1.044	4	PASS
Top / LTE 7	1.52	0.26	1.42	0.5	1.079	4	PASS
Front / LTE 12	0.329	-0.11	2	0.5	0.329	4	PASS
Left / LTE 12	0.103	0.17	2	0.5	0.103	4	PASS
Right / LTE 12	0.24	0	2	0.5	0.240	4	PASS
Back / LTE 12	0.561	-0.25	2	0.5	0.561	4	PASS
Top / LTE 12	0.129	-0.13	2	0.5	0.129	4	PASS

- 1) In a few instance a 0.3dB drift as specified in IEEE 1528:2013 has been exceeded. In the worst case a -0.73 dB drift has been observed for UMTS II Top the measurement yielding a 0.34 W/kg in 10 g of tissue. This drift is related to the output power stability of the device under test. At 0.34 W/kg a factor of 1.2 increase will deliver a 0.4 W/kg which provides significant margin to the 4 W/kg limit.

8.5. SAR results for body worn use case with holster at touch distance

Results without holster have been used wherever these results were sufficient to show compliance to the limits. Detailed results are listed in Appendix A of this report. When body worn with holster the front, left and right side of the product as indicated in Appendix B are close to the body.

Side of product / RAT	SAR result [W/kg] [1g]	Drift [dB] ⁽¹⁾	Scaling factor Tune Up	Scaling factor duty cycle	Reported SAR [W/kg] [1g]	Limit [W/kg] [1g]	Verdict
Front / UMTS V	0.801	-0.18	1.12	1	0.897	1.6	PASS
Left / UMTS V	0.525	-0.15	1.12	1	0.588	1.6	PASS
Right / UMTS V	0.268	-0.29	1.12	1	0.300	1.6	PASS
Front / UMTS II	0.662	-0.07	1.12	1	0.741	1.6	PASS
Left / UMTS II	0.521	-0.22	1.12	1	0.584	1.6	PASS
Right / UMTS II	0.893	0.01	1.12	1	1.000	1.6	PASS
Front / UMTS IV	0.804	-0.11	1.12	1	0.900	1.6	PASS
Left / UMTS IV	0.296	0.07	1.12	1	0.332	1.6	PASS
Right / UMTS IV	0.496	-0.08	1.12	1	0.556	1.6	PASS

Front / GPRS 850	0.318	0.02	1.78	1	0.566	1.6	PASS
Left / GPRS 850	0.224	-0.03	1.78	1	0.399	1.6	PASS
Right / GPRS 850	0.106	0.16	1.78	1	0.189	1.6	PASS
Front / GPRS 1900	1.12	0.07	1.12	1	1.254	1.6	PASS
Left / GPRS 1900	0.275	0.36	1.12	1	0.308	1.6	PASS
Right / GPRS 1900	0.722	-0.11	1.12	1	0.809	1.6	PASS

Front / LTE 2	0.387	0.08	2	0.5	0.387	1.6	PASS
Left / LTE 2	0.329	-0.19	2	0.5	0.329	1.6	PASS
Right / LTE 2	1.03	-0.16	2	0.5	1.030	1.6	PASS
Front / LTE 4	0.551	-0.2	2	0.5	0.551	1.6	PASS
Left / LTE 4	0.328	0.03	2	0.5	0.328	1.6	PASS
Right / LTE 4	1.21	-0.02	2	0.5	1.210	1.6	PASS
Front / LTE 5	0.731	-0.09	2	0.5	0.731	1.6	PASS
Left / LTE 5	0.176	-0.58	2	0.5	0.176	1.6	PASS
Right / LTE 5	0.312	-0.14	2	0.5	0.312	1.6	PASS
Front / LTE 7	1.15	-0.07	1.42	0.5	0.817	1.6	PASS
Left / LTE 7	1.85	0.42	1.42	0.5	1.314	1.6	PASS
Right / LTE 7	1.35	-0.06	1.42	0.5	0.959	1.6	PASS
Front / LTE 12	0.836	-0.11	2	0.5	0.836	1.6	PASS
Left / LTE 12	0.18	0.17	2	0.5	0.180	1.6	PASS
Right / LTE 12	0.358	0	2	0.5	0.358	1.6	PASS

- 1) In a few instance a 0.3dB drift as specified in IEEE 1528:2013 has been exceeded. In the worst case a -0.58 dB drift has been observed for LTE 5 Left with the measurement yielding a 0.18 W/kg in 1 g of tissue. This drift is related to the output power stability of the device under test. At 0.18 W/kg a factor of 1.14 increase will deliver a 0.21 W/kg which provides significant margin to the 1.6 W/kg limit.

8.6. Conducted Power measurement screenshots

8.9.1 LTE 2

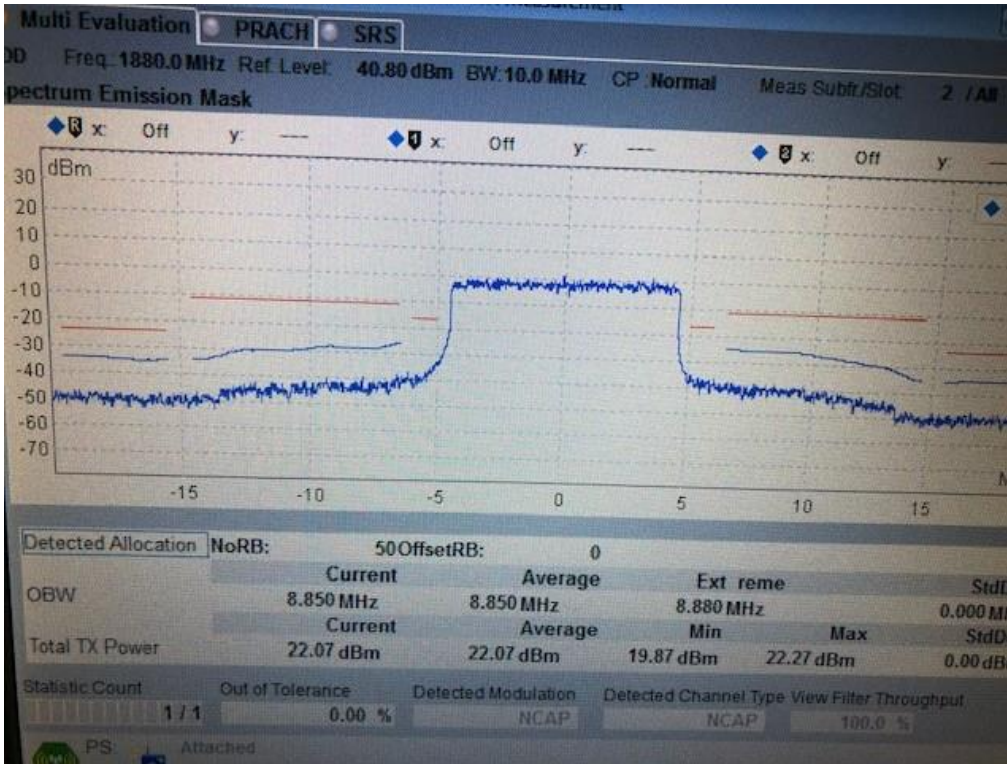

8.9.2 LTE 4

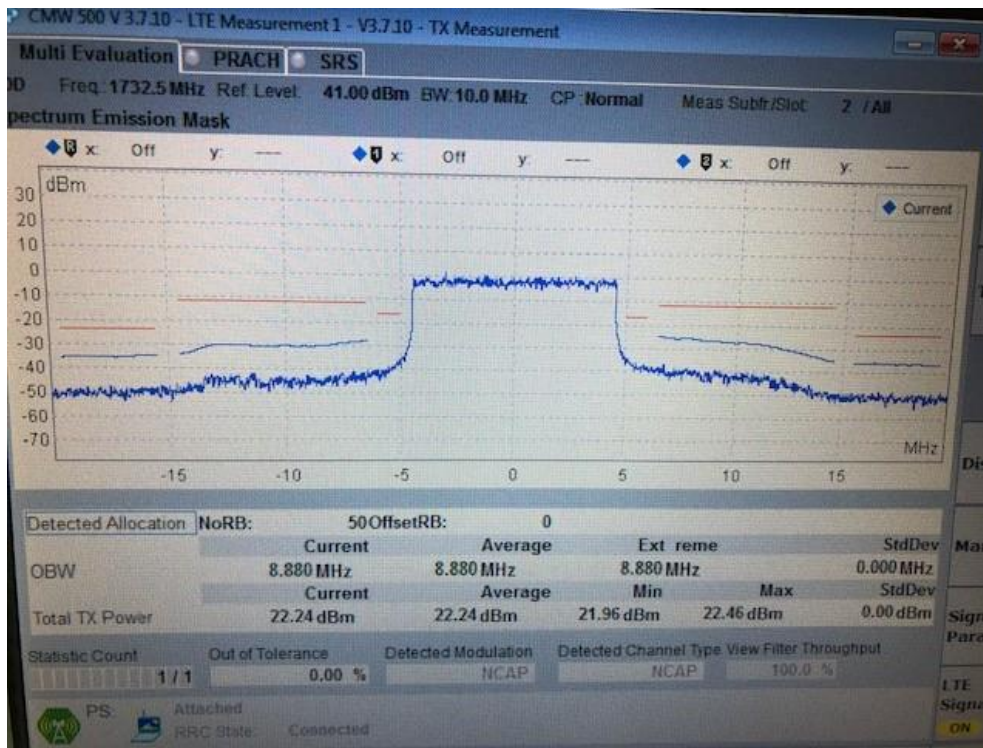

8.9.3 LTE 5

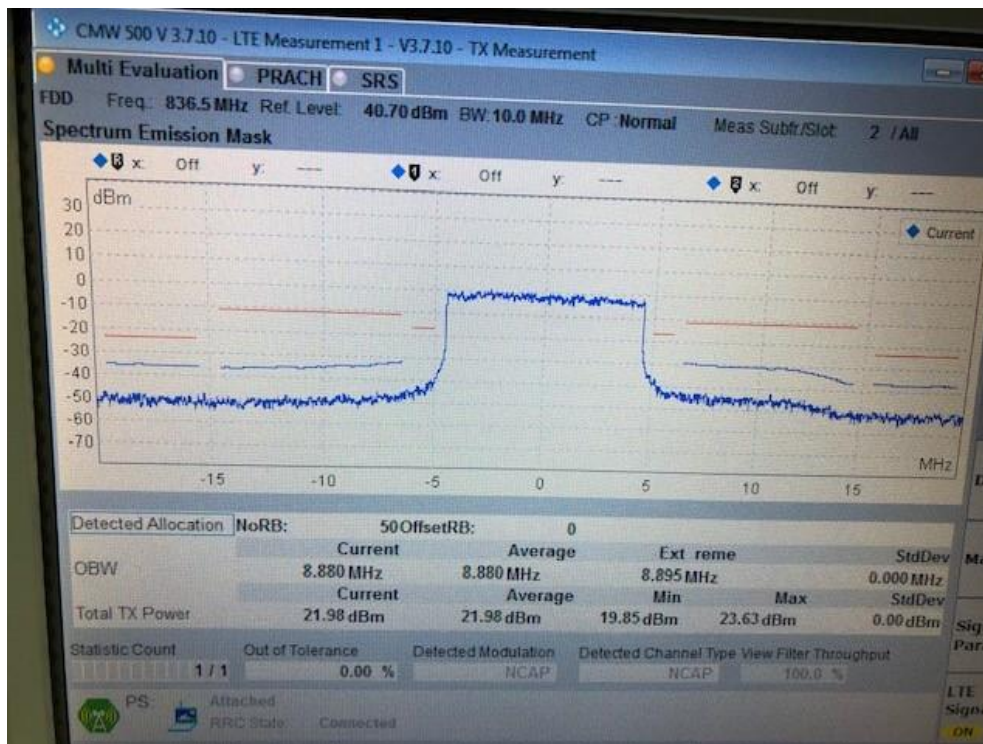

8.9.4 LTE 7

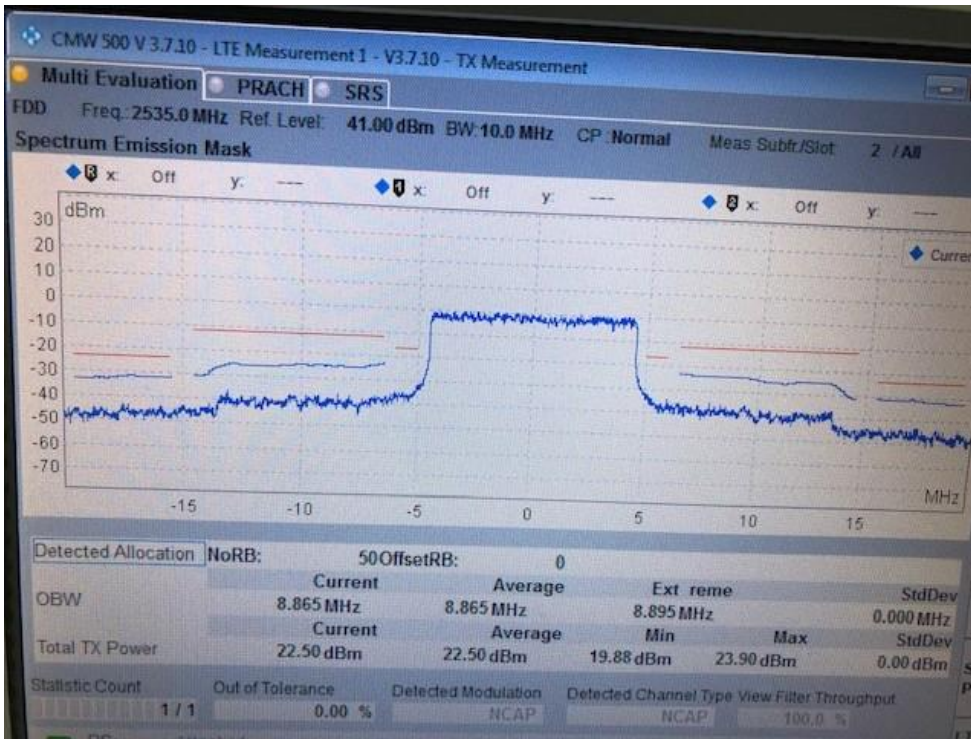

8.9.5 LTE 12

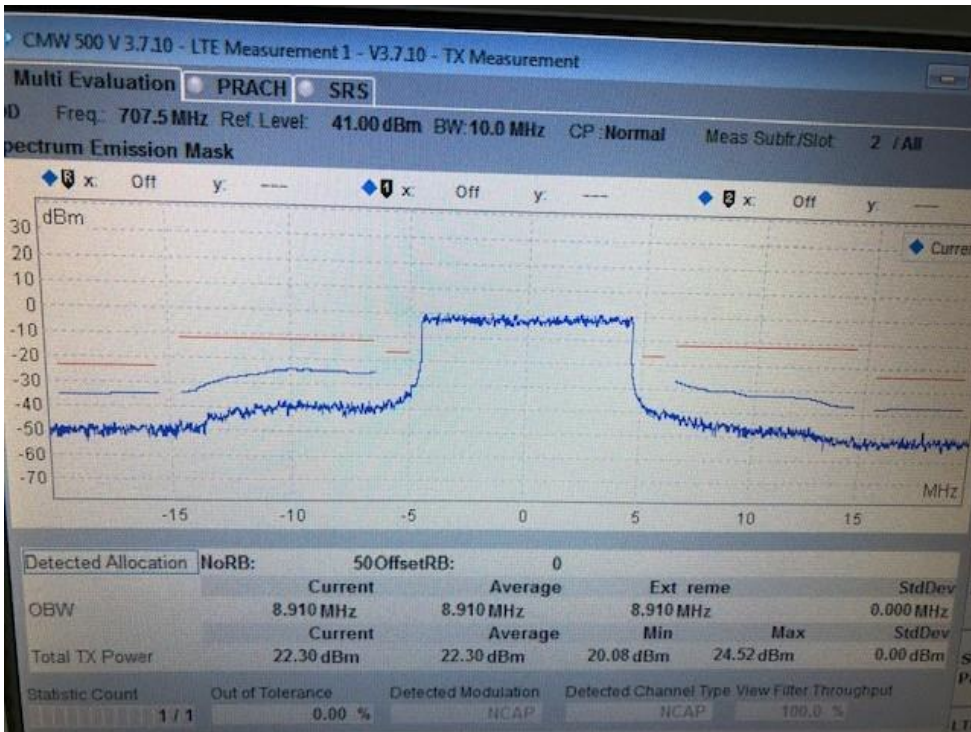

8.9.6 WCDMA II

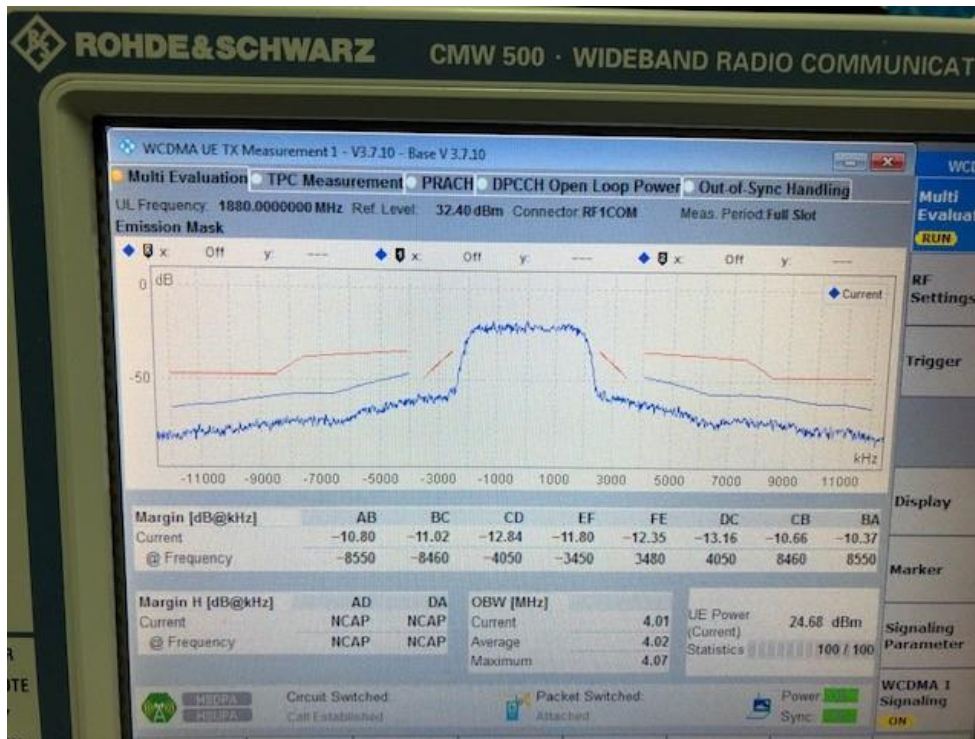

8.9.7 WCDMA IV

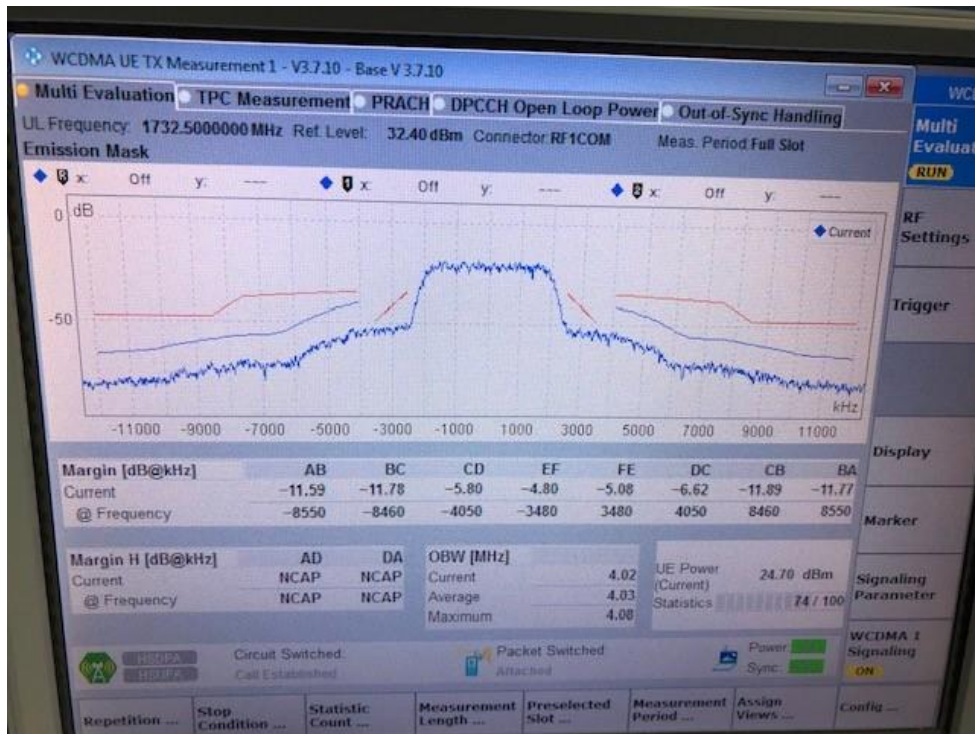

8.9.8 WCDMA V

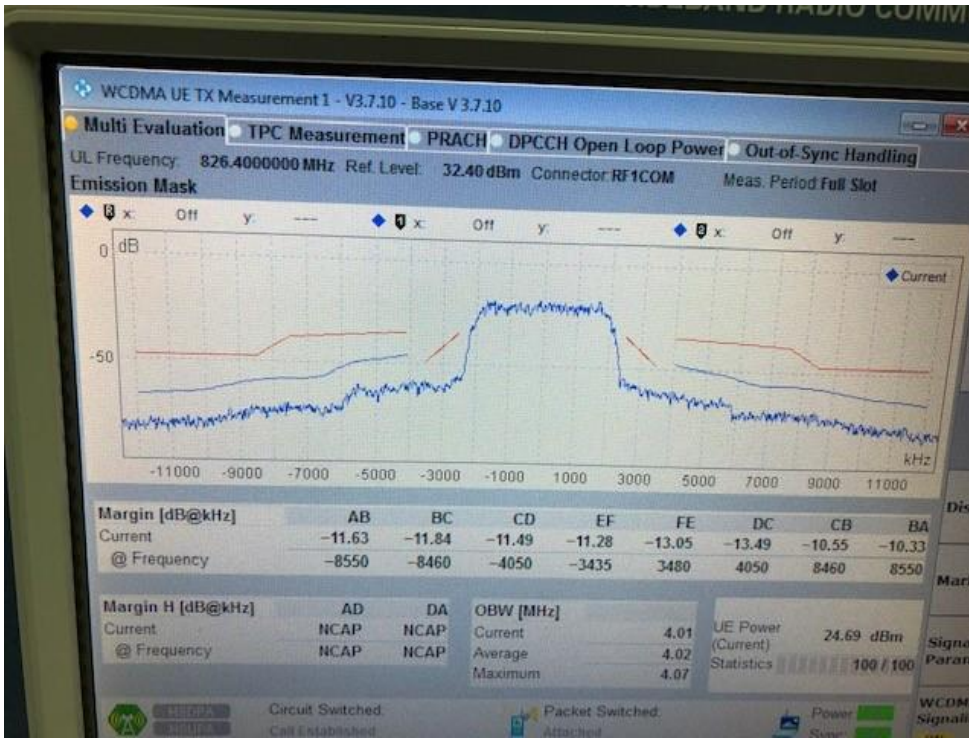

9. References

1. [IEEE 1999] IEEE Std C95.1-1999: IEEE Standard for Safety Levels with Respect to Human Exposure to Radio Frequency Electromagnetic Fields, 3 kHz to 300 GHz, Inst. of Electrical and Electronics Engineers, Inc., December 1998.
2. [IEEE 2013] IEEE Std 1528-2013: IEEE Recommended Practice for Determining the Peak Spatial-Average Specific Absorption Rate (SAR) in the Human Head From Wireless Communications Devices: Measurement Techniques. Inst. of Electrical and Electronics Engineers, Inc., June 2013.
3. [NIST 1994] NIST: Guidelines for Evaluating and Expressing the Uncertainty of NIST Measurement Results, Technical Note 1297 (TN1297), United States Department of Commerce Technology Administration, National Institute of Standards and Technology, September 1994.
4. SPEAG DASYS System Handbook
5. [FCC 20XX] Various FCC KDB Publications,
< <http://transition.fcc.gov/oet/ea/eameasurements.html#sar> >

10. Report History

Date	Report Name	Changes to Report	Report prepared by
05/06/2020	SAR-TZMED-013-19001	Initial	Franz Engert