

Table of Contents

1. Introduction	4
1.1 What is LPS8v2	4



Table of Contents:

- [1. Introduction](#)
 - [1.1 What is LPS8v2](#)
 - [1.2 Specifications](#)
 - [1.3 Features](#)
 - [1.4 LED Indicators](#)
 - [1.5 Button Intruction](#)

- [2. Quick Start](#)
 - [2.1 Access and Configure LPS8-V2](#)
 - [2.1.1 Find IP address of LPS8-V2](#)
 - [Method 1: Connect via LPS8-V2 WiFi](#)
 - [Method 2: Connect via Ethernet with DHCP IP from the router](#)
 - [Method 3: Connect via LPS8-V2 Fallback IP](#)
 - [Method 4: Connect via WiFi with DHCP IP from the router](#)
 - [2.1.2 Access Configure Web UI](#)
 - [2.2 Typical Network Setup](#)
 - [2.2.1 Overview](#)
 - [2.2.2 Use WAN port to access Internet](#)
 - [2.2.3 Access the Internet as a WiFi Client](#)
 - [2.2.4 Use built-in 4G modem for internet access](#)
 - [2.2.5 Check Internet connection](#)
 - [2.3 The LPS8-V2 is registered and connected to The Things Network](#)
 - [2.3.1 Select your area frequency](#)
 - [2.3.2 Get the only gateway EUJ](#)
 - [2.3.3 Register the gateway to The Things Network](#)
- [3. Web Configure Pages](#)
 - [3.1 Home](#)
 - [3.2 LoRa Settings](#)
 - [3.2.1 LoRa --> LoRa](#)
 - [3.3 LoRaWAN Settings](#)
 - [3.3.1 LoRaWAN --> LoRaWAN Semtech UDP](#)
 - [3.3.2 LoRaWAN --> LoRaWAN Basic Station](#)
 - [3.4 Network Settings](#)
 - [3.4.1 Network --> WiFi](#)
 - [3.4.2 Network --> System Status](#)
 - [3.4.3 Network --> Network](#)
 - [3.4.4 Network --> Cellular](#)
 - [3.5 System](#)
 - [3.5.1 System --> System Overview](#)
 - [3.5.2 System --> System General](#)
 - [3.5.3 System --> Backup/Restore](#)
 - [3.5.4 System --> Reboot / Reset](#)
 - [3.5.5 System --> Remoteit](#)
 - [3.5.6 System --> Package Management](#)
- [4. Build-in Server](#)
 - [1\). LoRaWAN Network Server: ChirpStack-V4](#)
 - [2\). Application Network Server: Node-Red](#)
 - [3\). Troubleshooting:](#)
 - [If the URL does not jump properly.](#)
 - [How to install InfluxDB, Grafana.](#)
 - [How to upgrade the gateway node.js to the latest version.](#)
 - [How to batch register device on the built-in Chirpstack network server](#)
 - [Why my gateway is not Chirpstack?](#)
 - [How to disable the built-in server](#)
 - [How to choose the Chirpstack server frequency SubBand](#)
- [5. Watch Dog](#)
- [6. How users can access LPS8-V2 using serial USB](#)
- [7. OTA System Update](#)
 - [7.1 Auto-update method](#)
 - [7.2 Manual upgrade method](#)
- [8. FAQ](#)
 - [8.1 How to change Hostname](#)
 - [8.2 Build-in The Things Network migrate to ChirpStack](#)
 - [Method 1: Using the Linux shell](#)
 - [Method 2: Flash a new image](#)
 - [8.3 How to reduce the 4g data consumed](#)
 - [8.4 How to connect the helium blockchain as a Data-only hotspot](#)

- [8.5 How to change built-in LoRaWAN Server from ChirpStack v4 to TTN Stack v3.](#)
- [8.6 How do I view gateway logs](#)
 - [8.6.1 LoRaWAN Log:](#)
 - [Semtech UDP Log :](#)
 - [Station Log:](#)
 - [8.6.2 4G Log](#)
 - [8.6.3 Dmesg Log](#)
 - [8.6.4 Record Log](#)
 - [8.6.5 View gateway logs via Linux Command](#)
- [8.7 DIN Mount Reference:](#)
- [9. Trouble Shooting](#)
 - [9.1 I can't log in to the built-in Server TTN Stack which shows 'Login failed'.](#)
 - [9.2 The built-in TTN status is "Not Running" and the URI is "dragino-123456". How users fix this problem](#)
 - [9.3 Fallback IP does not work, how can users check](#)
 - [9.4 Click "Manual Update", why there is no response?](#)
 - [9.5 Why the LPS8V2's Access Point does not do not appear & Fallback IP unable to access](#)
 - [9.6 How to reset the built-in server](#)
- [10. Supports](#)
- [11. Reference](#)
- [12. Order Info](#)
- [13. Manufacturer Info](#)
- [14. FCC Warning](#)

1. Introduction

1.1 What is LPS8v2

The LPS8v2 is an **open-source LoRaWAN Gateway**. It lets you bridge LoRa wireless network to an IP network via **WiFi, Ethernet or Cellular Network** (via Optional 4G module). The LoRa wireless allows users to send data and reach extremely long ranges at low data rates.

The LPS8v2 is fully compatible with LoRaWAN protocol. It supports different kinds of LoRaWAN Network Connections such as: **Semtech UDP Packet Forwarder, LoRaWAN Basic Station, ChirpStack MQTT Bridge**, and so on. This makes LPS8V2 work with most LoRaWAN platforms in the market.

LPS8v2 also includes a **built-in LoRaWAN Server and IoT server**, which provide the possibility for the system integrator to deploy the IoT service without cloud service or 3rd servers.

Different countries use different LoRaWAN frequency bands. LPS8v2 has these bands pre-configured. Users can also customize the frequency bands to use in their own LoRa network.

LPS8v2 supports **remote management**. System Integrator can easy to remote monitor the gateway and maintain it.

1.2 Specifications

Hardware System:

- CPU: Quad-core Cortex-A7 1.2Ghz
- RAM: 512MB
- eMMC: 4GB

Interface:

- 10M/100M RJ45 Ports x 1
- Multi-Channel LoRaWAN Wireless
- WiFi 802.11 b/g/n
- Sensitivity: -140dBm

- Max Output Power: 27dBm

Operating Condition:

- Work Temperature: -20 ~ 70 °C
- Storage Temperature: -20 ~ 70 °C
- Power Input: 5V, 2A, DC

1.3 Features

- Open Source Debian system
- Managed by Web GUI, SSH via WAN or WiFi
- Remote Management
- Auto-provisioning for batch deployment and management
- LoRaWAN Gateway
- 10 programmable parallel demodulation paths
- Pre-configured to support different LoRaWAN regional settings.
- Allow customizing LoRaWAN regional parameters.
- Different kinds of LoRaWAN Connections such as
 - Semtech UDP Packet Forwarder
 - LoRaWAN Basic Station
 - ChirpStack-Gateway-Bridge (MQTT)
- Built-in **ChirpStack** local LoRaWAN server
- Built-in **Node-Red** local Application server

1.4 LED Indicators

LPS8-V2 has totally four LEDs, They are:

Power LED: This RED LED will be solid if the device is properly powered

ETH LED: This RGB LED will blink GREEN when the ETH port is connecting

SYS LED: This RGB LED will show different colors in different states:

SOLID GREEN: The device is alive with a LoRaWAN server connection.

BLINKING GREEN: a) Device has internet connection but no LoRaWAN Connection. or b) Device is in booting stage, in this stage, it will BLINKING GREEN for several seconds and then with BLINKING GREEN together

SOLID RED: Device doesn't have an Internet connection.

WIFI LED: This LED shows the WIFI interface connection status.

1.5 Button Intruction

LPS8-V2 has a black toggle button, which is:

Long press 4-5s : the gateway will reload the Network and Initialize wifi configuration

LED status: ETH LED will BLINKIND BULE Until the reload is finished.

Long press more than 10s: the gateway will restore the factory settings.

LED status: ETH LED will SOLID BULE Until the restore is finished.

Note: Restoring factory Settings does not erase data from the LPS8-V2 built-in server

See this link for steps on how to clear data from the built-in server: [How to reset the built-in server](#)

When the gateway restores the factory settings is complete,
The WiFi configuration will enable WiFi Access Point by default.
The other configuration will be restored to the default configuration.

2. Quick Start

The LPS8-V2 supports network access via Ethernet or Wi-Fi connection and runs without a network.
In most cases, the first thing you need to do is make the lps8-v2 accessible to the network.

2.1 Access and Configure LPS8-V2

2.1.1 Find IP address of LPS8-V2

Method 1: Connect via LPS8-V2 WiFi

Since software version **230524**, At the first boot of LPS8-V2, it will auto generate a WiFi network called **dragino-xxxxxx** with password:

dragino.dragino

User can use a PC to connect to this WiFi network. The PC will get an IP address 10.130.1.xxx and the LPS8-V2 has the default IP **10.130.1.1**





Method 2: Connect via Ethernet with DHCP IP from the router

Connect the LPS8-V2 Ethernet port to your router and LPS8-V2 can obtain an IP address from your router. In the router's management portal, you should be able to find what IP address the router has assigned to the LPS8-V2.

You can also use this IP to connect.



Method 3: Connect via LPS8-V2 Fallback IP

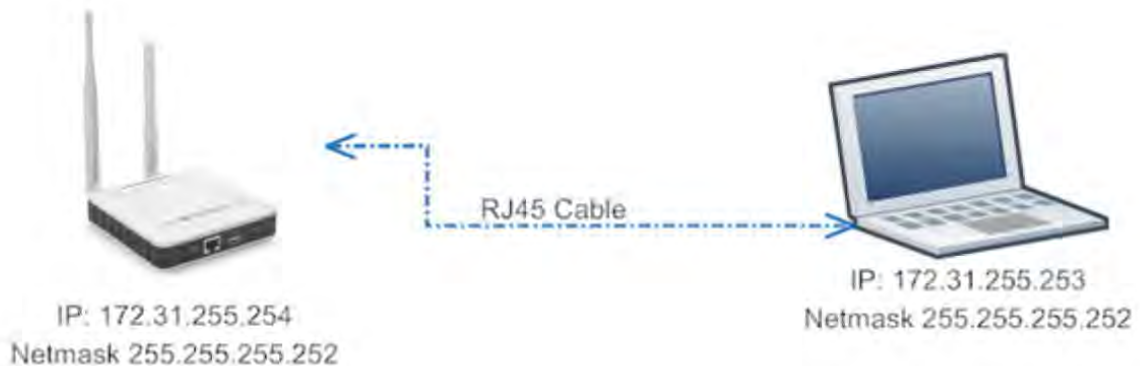

Steps to connect via fallback IP:

1. Connect the PC's Ethernet port to LPS8-V2's WAN port
2. Configure PC's Ethernet port has IP: 172.31.255.253 and Netmask: 255.255.255.252

Settings --> Network & Internet --> Ethernet --> Change advanced sharing options --> Double-click "Ethernet" --> Internet Protocol Version 4 (TCP/IPv4)

As in the below photo:

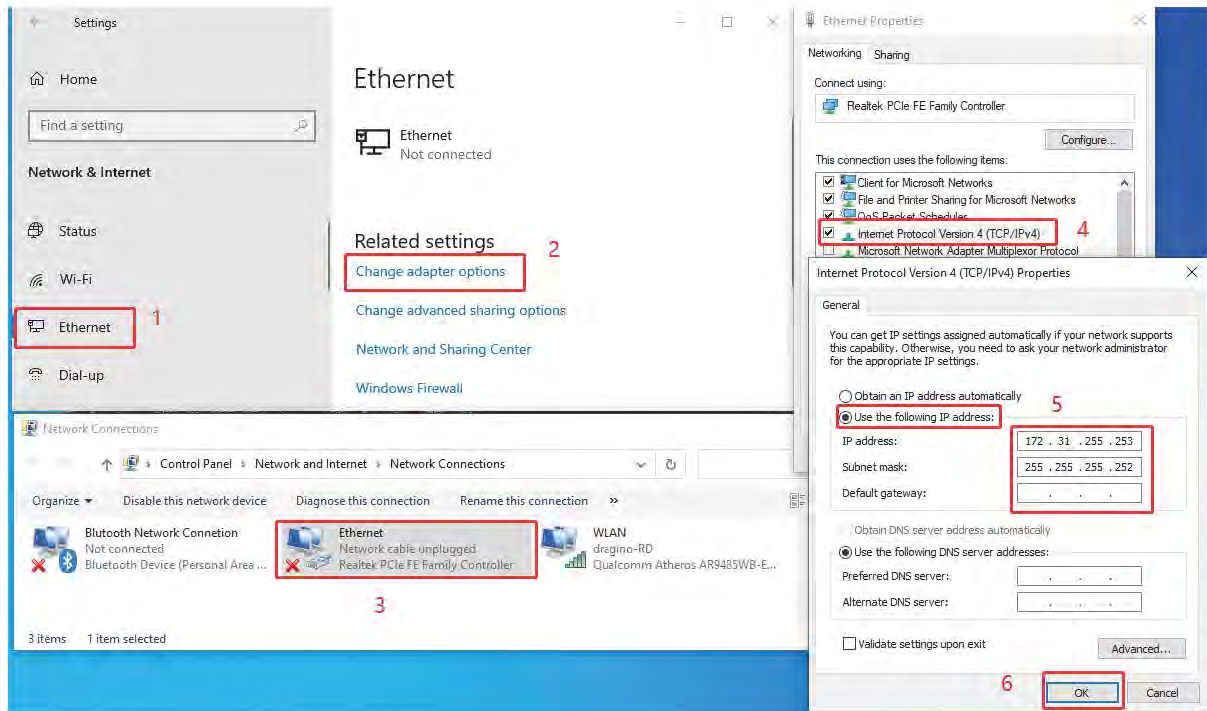

Configure computer Ethernet port steps video: [fallback ip.mp4](#)

If you still can't access the LPS8-V2 fallback ip, follow this connection to debug : [Trouble Shooting](#)

3. In the PC, use IP address 172.31.255.254 to access the LPS8-V2 via Web or Console.



Method 4: Connect via WiFi with DHCP IP from the router



Fill in the WiFi information by checking the box and clicking **Save&Apply**



Wi-Fi configuration successful

The screenshot shows the 'WiFi WAN Client Settings' page in the DRAGINO web interface. The navigation bar at the top includes 'LoRa', 'LoRaWAN', 'Network', 'System', 'LogRead', 'Home', and 'Logout'. The main heading is 'WiFi'. Under 'WiFi WAN Client Settings', there is a checkbox for 'Enable WiFi WAN Client' which is checked. Below it are input fields for 'Host WiFi SSID' (containing 'PDCN') and 'Passphrase' (containing '*****'). A 'WiFi Survey' dropdown menu is set to 'Choose WiFi SSID...'. A status message indicates: '[2K Device 'wlan0' successfully activated with '65c55b4a-774c-4522-a072-9981126db405''. At the bottom are 'Save&Apply' and 'Cancel' buttons.

The screenshot shows the 'System Overview' page in the DRAGINO web interface. The navigation bar is the same as in the previous screenshot. The main heading is 'System Overview'. The central part of the page features a diagram of the 'Model LPS8-V2' gateway device connected to various services: 'Internet', 'LoRa', 'WiFi', 'Eth', 'LoRaWAN', and 'WiFi Access Point'. Each connection is represented by a circular icon with a green checkmark, indicating that the service is active. In the bottom left corner, there is a 'WiFi Internet' status box with the following details: SSID: PDCN, IP Addr: 192.168.123.55, TX Bytes: 3.4KB, RX Bytes: 780.6KB, Signal: signal:-17dBm, and Bit Rate: rxbitrate:135.0MB/s txbitrate:135.0MB/s.

2.1.2 Access Configure Web UI

Web Interface

Open a browser on the PC and type the LPS8-V2 ip address (depends on your connect method)

http://IP_ADDRESS or <http://172.31.255.254>(Fallback IP)

You will see the login interface of LPS8-V2 as shown below.

The account details for Web Login are:

User Name: root

Password: dragino



2.2 Typical Network Setup

2.2.1 Overview

LPS8-V2 supports flexible network set up for different environment. This section describes the typical network topology can be set in LPS8-V2. The typical network set up includes:

- **WAN Port Internet Mode**
- **WiFi Client Mode**
- **Cellular Mode**

2.2.2 Use WAN port to access Internet

By default, the LPS8-V2 is set to use the WAN port to connect to an upstream network. When you connect the LPS8-V2's WAN port to an upstream router, LPS8-V2 will get an IP address from the router and have Internet access via the upstream router. The network status can be checked in the **home page**.



2.2.3 Access the Internet as a WiFi Client

In the WiFi Client Mode, LPS8-V2 acts as a WiFi client and gets DHCP from an upstream router via WiFi.

The settings for WiFi Client is under page [Network](#) --> [Wi-Fi](#)

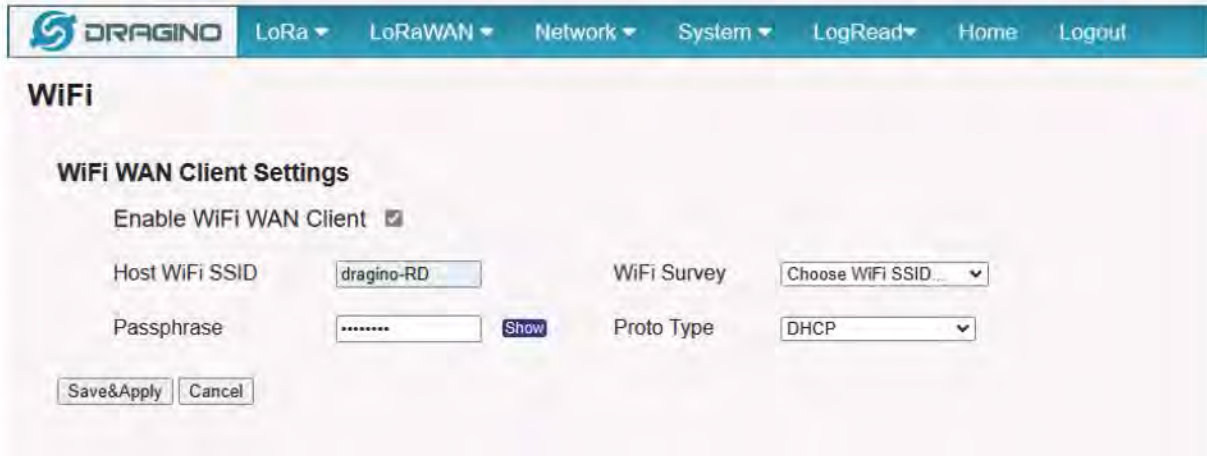

In the WiFi Survey Choose the WiFi AP, and input the Passphrase then click **Save & Apply** to connect.

2.2.4 Use built-in 4G modem for internet access

Since **Hardware version HP0C 1.4**

Users can see whether LPS8v2 has EC25 on the label of the gateway to determine whether there is 3G/4G Cellular modem.

If the LPS8-V2 has 3G/4G Cellular modem, user can use it as main internet connection or back up.

First, install the Micro SIM card as below direction

Second, Power off/ ON LPS8-V2 to let it detect the SIM card.



The set up page is **Network --> Cellular**

While use the cellular as Backup WAN, device will use Cellular for internet connection while WAN port or WiFi is not valid and switch back to WAN port or WiFi after they recover.

Cellular Settings

Enable Cellular WAN
 Use Cellular as Backup WAN

APN

Service

Dial Number



Pincode

Username

Password

2.2.5 Check Internet connection

In the **home** page, we can check the Internet connection.

- GREEN Tick  : This interface has Internet connection.
- Yellow Tick  : This interface has IP address but don't use it for internet connection.
- RED Cross  : This interface doesn't connected or no internet.



2.3 The LPS8-V2 is registered and connected to The Things Network

2.3.1 Select your area frequency

First, you need to set the frequency plan in LPS8-V2 to match the end node we use, so to receive the LoRaWAN packets from the LoRaWAN sensor.

The screenshot shows the 'LoRa Configura' web interface. At the top, there is a navigation bar with the DRAGINO logo and menu items: LoRa, LoRaWAN, Network, System, LogRead, Home, and Logout. Below the navigation bar, the page title is 'LoRa Configura' with a 'LoRa' sub-tab. The main content area includes a 'Debug Level' dropdown set to 'Low'. Under the 'Radio Settings' section, there are fields for 'Keep Alive Period (sec)' (30) and 'Frequency Plan'. A dropdown menu for 'Frequency Plan' is open, showing a list of options: EU868 Europe 868Mhz (863-870), CN470 China 470MHz (470-510), US915 United States 915Mhz (902-928), AU915 Australia 915Mhz (915-928), IN865 India 865MHz (865-867), KR920 Korea 920MHz (920-923), AS923 Asia AS923-1, AS923 Asia AS923-2, AS923 Asia AS923-3, AS923 Asia AS923-4, RU864 Russia 864MHz (864-870), and Customized Bands. The 'EU868 Europe 868Mhz (863-870)' option is selected. To the right of the dropdown, there are two input fields: one containing '450' and another containing '114.240000'. Below the dropdown, there are buttons for 'Save&Apply', 'Disable', and 'Cancel'. The 'Current Mode' is set to 'LoRaWAN Semtec'.

2.3.2 Get the only gateway EUI

Every LPS8-V2 has a unique gateway id. The ID can be found on LoRaWAN Semtech page:

The screenshot shows the 'LoRaWAN Configuration' page for a 'LoRaWAN Semtech UDP' gateway. The interface includes a navigation bar with 'LoRa', 'LoRaWAN', 'Network', 'System', 'LogRead', 'Home', and 'Logout' options. The main content area is titled 'LoRaWAN Configuration' and features a dropdown menu for 'LoRaWAN Basic Station'. Below this, there are several sections: 'General Settings' with fields for 'Email' (dragino@dragino.com) and 'Gateway EUI' (884041f-df-e24000b); 'Primary LoRaWAN Server' with dropdowns for 'Service Provider' (The Things Network V3) and 'Server Address' (eu1.cloud.thethings.network), and input fields for 'Uplink Port' and 'Downlink Port' (both 1700); 'Primary Packet Filter' with 'Fport Filter' and 'DevAddr Filter' (both 0); 'Secondary LoRaWAN Server' with 'Service Provider' set to 'Disable'; and 'Secondary Packet Filter' with 'Fport Filter' and 'DevAddr Filter' (both 0). At the bottom, the 'Current Mode' is 'LoRaWAN Semtech UDP', and there are 'Save&Apply' and 'Cancel' buttons.

Note: Choose the cluster that corresponds to a specific Gateway server address

- # **Europe 1:** corresponding Gateway server address: **eu1.cloud.thethings.network**
- # **North America 1:** corresponding Gateway server address: **nam1.cloud.thethings.network**
- # **Australia 1:** corresponding Gateway server address: **au1.cloud.thethings.network**
- # **Legacy V2 Console:** TTN v2 shuts down in December 2021

Primary LoRaWAN Server

Service Provider	<input type="text" value="The Things Network V3"/>	Server Address	<input type="text" value="eu1.cloud.thethings.network"/> <input type="text" value="eu1.cloud.thethings.network"/> <input type="text" value="nam1.cloud.thethings.network"/> <input type="text" value="au1.cloud.thethings.network"/>
Uplink Port	<input type="text" value="1700"/>	Downlink Port	

Primary Packet Filter

Fport Filter ?	<input type="text" value="0"/>	DevAddr Filter ?	<input type="text" value="0"/>
----------------	--------------------------------	------------------	--------------------------------

2.3.3 Register the gateway to The Things Network

Login to The Things Network

<https://console.cloud.thethings.network/>

Add the gateway

Welcome back, xiaoye0! 🙌

Walk right through to your applications and/or gateways.

Need help? Have a look at our [Documentation](#) or [Get support](#).

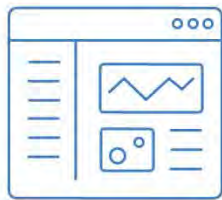

Go to applications

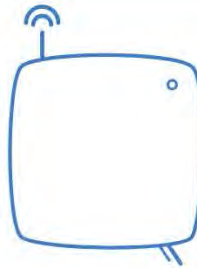

Go to gateways

Get it online

3. Web Configure Pages

3.1 Home

Shows the system running status:



3.2 LoRa Settings

3.2.1 LoRa --> LoRa

This page shows the LoRa Radio Settings. There is a set of default frequency bands according to LoRaWAN protocol, and users can customize the band* as well.

Different LPS8v2 hardware versions can support different frequency ranges:

- **868**: valid frequency: 863Mhz ~ 870Mhz. for bands EU868, RU864, IN865, or KZ865.
- **915**: valid frequency: 902Mhz ~ 928Mhz. for bands US915, AU915, AS923 or KR920

After the user choose the frequency plan, the user can see the actual frequency is used by checking the page [LogRead --> LoRa Log](#)

LoRa Configuration

Debug Level

Radio Settings

Keep Alive Period (sec)

Frequency Plan

Static GPS coordinates ?

Enable Static GPS

Latitude

Current Mode: **LoRaWAN Semtec**

- EU868 Europe 868Mhz (863~870)
- EU868 Europe 868Mhz (863~870)
- CN470 China 470MHz (470~510)
- US915 United States 915Mhz (902~928)**
- AU915 Australia 915Mhz (915~928)
- IN865 India 865MHz (865~867)
- KR920 Korea 920MHz (920~923)
- AS923 Asia AS923-1
- AS923 Asia AS923-2
- AS923 Asia AS923-3
- AS923 Asia AS923-4
- RU864 Russia 864MHz (864~870)
- Customized Bands

Note *: See this instruction for how to customize the frequency band: [How to customized LoRaWAN frequency band - DRAGINO](#)

3.3 LoRaWAN Settings

3.3.1 LoRaWAN --> LoRaWAN Semtech UDP

This page is for the connection set up to a general LoRaWAN Network server such as [TTN](#), [ChirpStack](#), etc.

LoRa ▾ LoRaWAN ▾ Network ▾ System ▾ LogRead ▾ Home Logout

LoRaWAN Configuration

General Settings

Email

Gateway EUI

Primary LoRaWAN Server

Service Provider Server Address

Uplink Port Downlink Port

Primary Packet Filter

Fport Filter ? DevAddr Filter ?

Secondary LoRaWAN Server

Service Provider

Secondary Packet Filter

Fport Filter ? DevAddr Filter ?

Current Mode: **LoRaWAN Semtech UDP**

3.3.2 LoRaWAN --> LoRaWAN Basic Station

This page is for the connection set up to the TTN Basic Station, AWS-IoT, etc.

The screenshot shows the 'LoRaWAN -- Basic Station' configuration page. At the top is a navigation bar with the DRAGINO logo and menu items: LoRa, LoRaWAN, Network, System, LogRead, Home, and Logout. The main heading is 'LoRaWAN -- Basic Station'. Below it is the 'General Settings' section with fields for 'Email' (dragino@dragino.com) and 'Gateway ID' (a84041FDfE24000b). A 'Restore ?' button is next to the Gateway ID, with a 'Restore_Configuration' button to its right. The 'Primary LoRaWAN Server' section includes a 'Service Provider' dropdown menu set to 'The Things Network -- Basic Station'. Below this are fields for 'Server URI' (example: https://eu1.cloud.thethings.network:443), 'Sever CUPS' (example: NNSXS.2WT4MDZ3R24GFIRNJB6A3OKZWPRNT6HZLXM3PXI.JT42TOKFSA), and 'CUPS trust'. The 'CUPS trust' field shows a red error message: 'Not Found CA certificate,User can clicking DEFAULTde CERTIFICATE to install certificate', with a 'DEFAULT_CERTIFICATE' button to its right. At the bottom, a status line reads 'Current Mode: LoRaWAN Semtech UDP Click Save & Apply will change to mode: LoRaWAN Basic Station', followed by 'Save&Apply' and 'Cancel' buttons.

Please see this instruction to know more detail and a demo for how to use of LoRaWAN Basic Station: [Use of LoRaWAN Basic Station - DRAGINO](#)

3.4 Network Settings

3.4.1 Network --> WiFi

Users can configure the wifi WAN and enable Wifi Access Point on this interface

DRAGINO LoRa LoRaWAN Network System Server LogRead Home Logout

WiFi Settings

WiFi Mode

WiFi WAN Client Settings

Enable WiFi WAN Client

Host WiFi SSID WiFi Survey

Passphrase Proto Type

3.4.2 Network --> System Status

System Status

Network / WiFi Status

```

eth0: connected to Wired connection 1
"eth0"
ethernet (dwmac-sun8i), 02:81:8F:3E:1A:15, hw, mtu 1500
ip4 default
inet4 10.130.2.22/24
route4 10.130.2.0/24 metric 100
route4 default via 10.130.2.1 metric 100
inet6 fe80::52f5:c37e:e26b:9039/64
route6 fe80::/64 metric 1024

br-af3e3e44fb1b: connected (externally) to br-af3e3e44fb1b
"br-af3e3e44fb1b"
bridge, 02:42:25:DE:18:58, sw, mtu 1500
inet4 172.18.0.1/16
route4 172.18.0.0/16 metric 0
inet6 fe80::42:25ff:fede:1858/64
route6 fe80::/64 metric 256

docker0: connected (externally) to docker0
"docker0"
bridge, 02:42:EE:06:DB:1C, sw, mtu 1500
inet4 172.17.0.1/16
route4 172.17.0.0/16 metric 0

wlan0: disconnected
"Ralink MT7601U"
wifi (mt7601u), 30:7B:C9:51:C3:4A, hw, mtu 1500

veth632a869: unmanaged
"veth632a869"
ethernet (veth), 2E:55:34:EC:17:A4, sw, mtu 1500

vetha711dc8: unmanaged
"vetha711dc8"
ethernet (veth), 96:F3:44:55:D9:47, sw, mtu 1500
    
```

Refresh

3.4.3 Network --> Network

In the **Network --> Network** interface, Users can set the Ethernet WAN static ip address.

The screenshot shows the 'Network' configuration page. At the top, there is a navigation bar with the DRAGINO logo and menu items: LoRa, LoRaWAN, Network, System, LogRead, Home, and Logout. The main heading is 'Network'. Underneath, there is a section titled 'Ethernet WAN Settings'. The 'Mode' is set to 'Static'. There are four input fields: 'IP Address', 'Gateway', 'Netmask', and 'DNS'. A 'Save&Apply' button is located at the bottom left of the settings area.

3.4.4 Network --> Cellular

In the **Network --> Cellular** interface, Users can Enable Cellular WAN and configure Cellular.

Note: APN cannot be empty.

The screenshot shows the 'Cellular Settings' configuration page. At the top, there is a navigation bar with the DRAGINO logo and menu items: LoRa, LoRaWAN, Network, System, LogRead, Home, and Logout. The main heading is 'Cellular Settings'. There is a checkbox labeled 'Enable Cellular WAN' which is checked. Below this are several input fields: 'APN' (containing '3gnet'), 'Service' (a dropdown menu showing 'UMTS / GPRS'), 'Dial Number' (containing '*99#'), 'Pincode' (containing 'SIM Pincode'), 'Username' (containing 'SIM Acct Username'), and 'Password' (containing 'SIM Acct Password'). A 'Show' button is located to the right of the Password field. At the bottom, there are 'Save&Apply' and 'Cancel' buttons.

After the configuration is complete, return to the Home interface and put the mouse on the Cell icon to check the Cellular state.



Note: Known bugs: 4g consumes a lot of data which has been fixed by the package: dragino-ui-230716

[Reduce data method](#)

3.5 System

3.5.1 System --> System Overview

Shows the system info:

DRAGINO LoRa LoRaWAN Network System Server LogRead Home Logout

System Overview

Device Model: LPS8-V2
Hostname: dragino-2d5d26
FWD version: Release:2023-08-05 08:49:02, Version:2.8.7
Cellular : Not Detected
System Time: Tue Oct 31 08:28:46 UTC 2023
Uptime: 32 days
Load Avg: 56, 3 users, load average
Memory: Free Memory: 113028 / Total Memory: 503640kB
IoT Service: lorawan
ETH0 MAC: a8:40:41:24:00:01
WiFi MAC: 30:7b:c9:52:01:9c

Internet Connection OK 

LoRaWAN Connection OK 

3.5.2 System --> System General

In the **System-> System General** interface, Users can customize the configuration System Password and set Timezone.

In addition, Users can customize the FallBack IP address.

3.5.3 System --> Backup/Restore

3.5.4 System --> Reboot / Reset

In the **System-> Reboot / Reset** interface, users can restart or reset the gateway.

ETH LED will SOLID BLUE Until the restore is finished.

When the gateway restores the factory settings is complete,

The WiFi configuration will enable WiFi Access Point by default.

The other configuration will be restored to the default configuration.



3.5.5 System --> Remoteit

In the **System-> Remoteit** interface, users can configure the gateway to be accessed remotely via Remote.it.

the users can refer to this link to configure them: [Monitor & Remote Access Gateway](#)

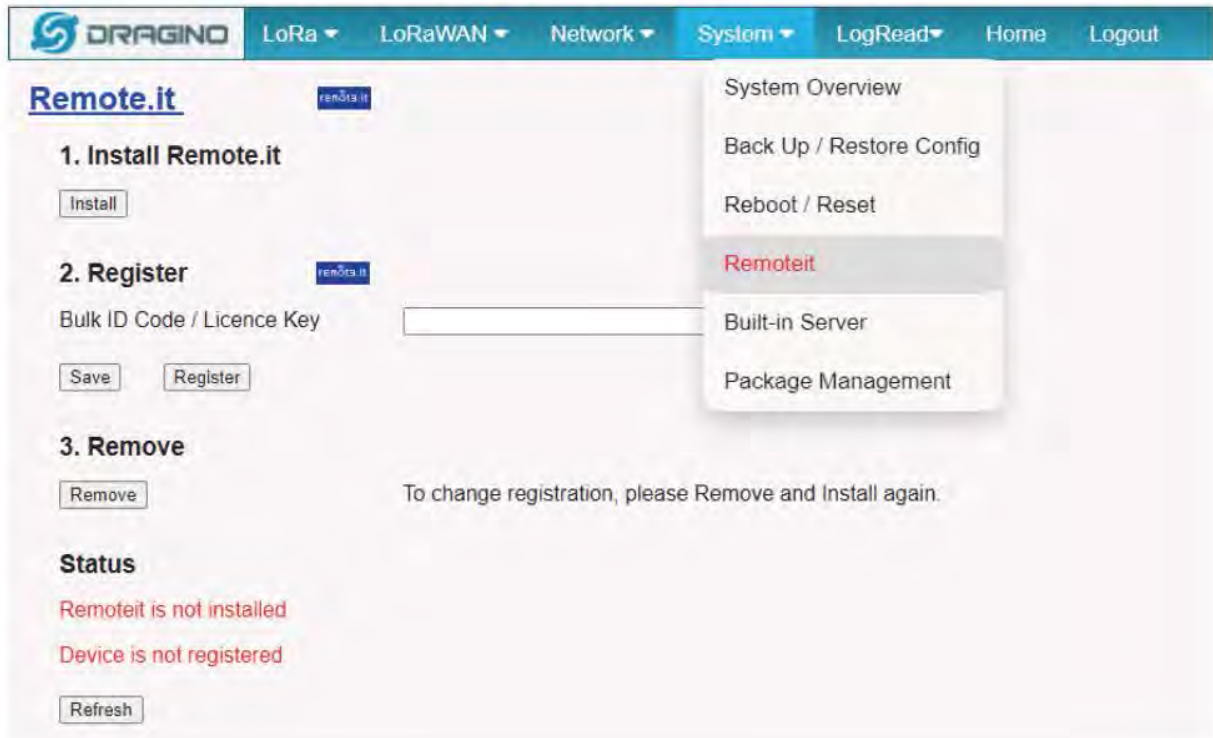

3.5.6 System --> Package Management

In the **System --> Package Management** interface, Users can check the current version of Core Packages.

DRAGINO LoRa LoRaWAN Network System LogRead Home Logout

Package Management

General Settings

Enable update every boot

Enable update every day midnight

Core Packages

Name	Current Version
dragino-httpd :	2022-12-02
dragino-ui :	2023-02-06
draginofwd :	2022-10-23
draginoups :	2023-01-06
dragino-fallback :	23.01.05
armbian-bsp-cli-draginohp0z :	22.05.2

Package Auto-Update Log

4. Build-in Server

After the v1.7-230606 version, the LPS8-V2 default factory pre-installed the LoRaWAN Server: **ChirpStack-V4**, Application Server: **Node-Red**.

1). LoRaWAN Network Server: ChirpStack-V4

The screenshot shows the DRAGINO web interface for the 'Built-In Network Server' configuration. The navigation bar at the top includes 'LoRa', 'LoRaWAN', 'Network', 'System', 'Server', 'LogRead', 'Home', and 'Logout'. The 'Server' menu is expanded, showing 'Network Server' (selected) and 'Application Server'. The main content area displays the following configuration details:

Platform Provider	Chirpstack
Enable	<input checked="" type="checkbox"/> <input type="button" value="Launch"/>
Service Status	Running
Server Versions	Chirpstack V4
Reset Chirstack	<input type="button" value="Reset"/>
Frequency Plan	<input type="text" value="EU868"/>

Below the configuration table, there is a link for [Management](#) and a button.

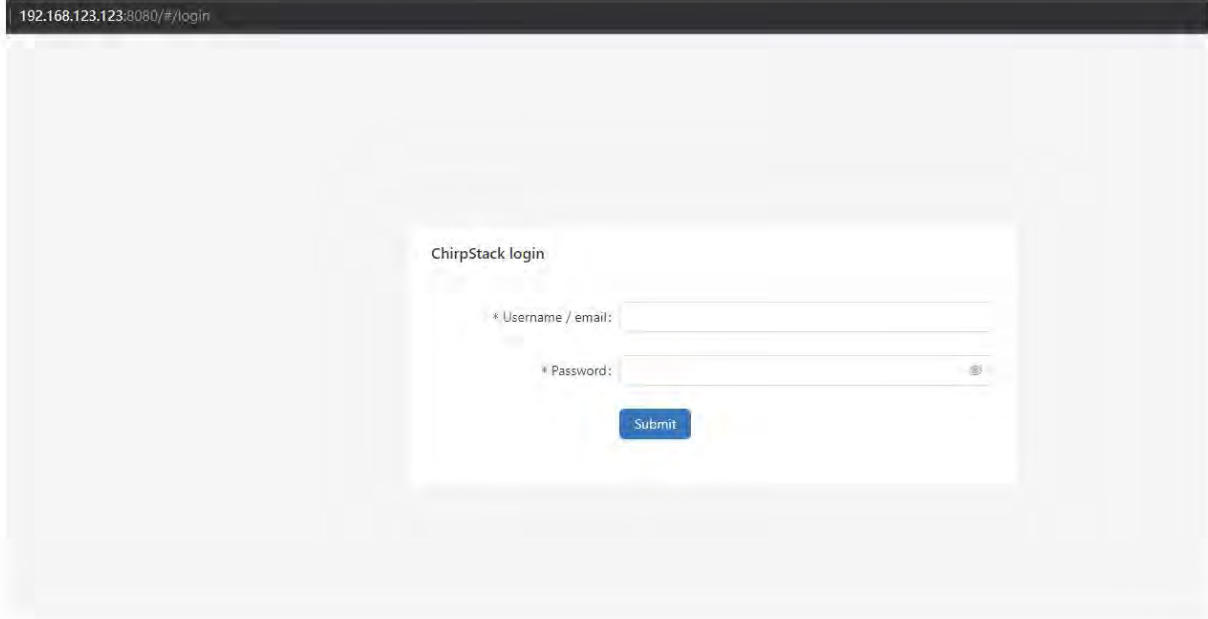

Note: The user can access the ChirpStack-V4 via click the 'Launch' button, and the login account: **admin/admin**

For more information on server operations see [Register LPSV2 to the built-in Chirpstack](#)

2). Application Network Server: **Node-Red**

The screenshot shows the DRAGINO web interface. At the top, there is a navigation menu with the following items: LoRa, LoRaWAN, Network, System, Server, LogRead, Home, and Logout. The 'Server' menu is currently open, showing two options: 'Network Server' and 'Application Server', with 'Application Server' selected. Below the navigation, the main heading is 'Built-In Application Server'. The configuration details are as follows:

Platform Provider	Node-Red
Enable	<input checked="" type="checkbox"/> Launch
Service Status	Running
Node-RED Versions	v3.0.2
Nodejs Versions	v12.22.9
npm Versions	8.5.1

At the bottom of the configuration section, there is a 'Save&Apply' button.

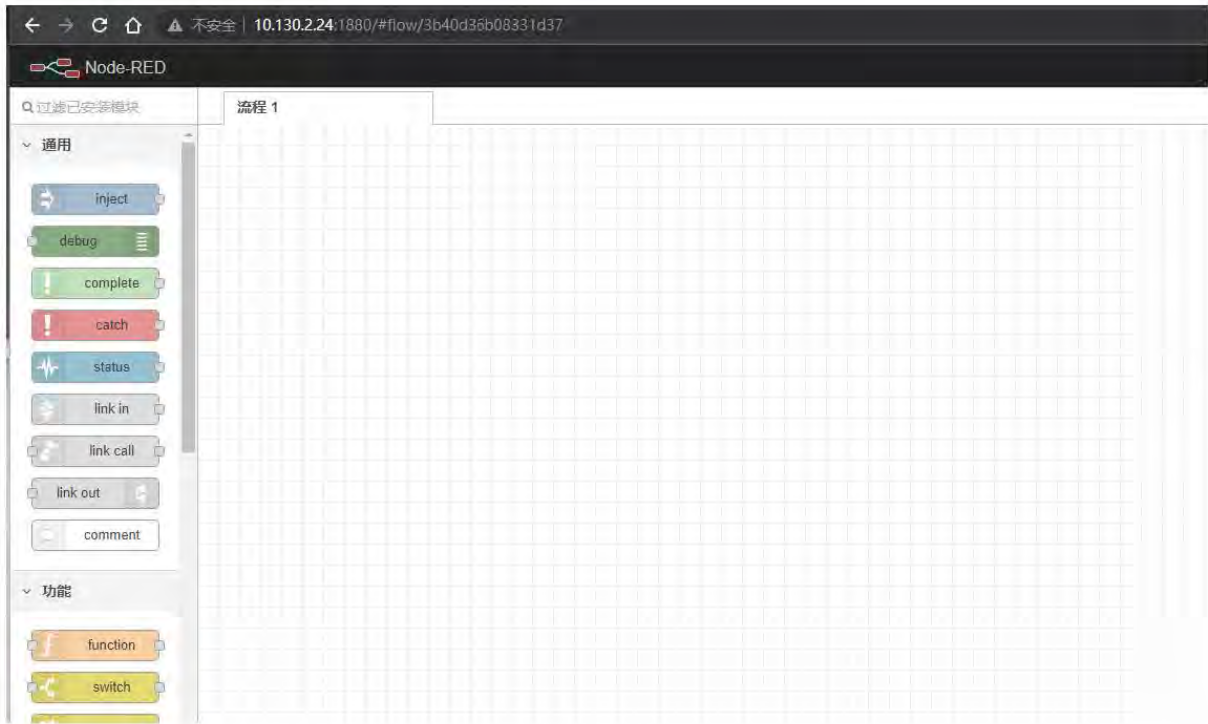

Note: The user can access the Node-RED via click the 'Launch' button

3). Troubleshooting:

If the URL does not jump properly.

For the ChirpStack, you can use the local IP address and the port is **8080** to access it.

For the Node-Red, you can use the local IP address and the port is **1880** to access it.

How to install InfluxDB, Grafana.

The LPS8V2 is not pre-installed with InfluxDB and Grafana, the users can install them, see [InfluxDB](#)

How to upgrade the gateway node.js to the latest version.

The user can upgrade nodejs, see [Upgrade Nodejs](#)

How to batch register device on the built-in Chirpstack network server

The user can register devices in batch on the gateway Web UI, see [Batch Register](#)

Why my gateway is not Chirpstack?

After June '23, the default factory LPS8V2 pre-installed Chirpstack-V4 instead of The Things Stack, the users can migrate to Chirpstack-V4, see [Change TTN Stack v3 to ChirpStack](#)

How to disable the built-in server

Use the following commands to start and stop the TTNv3 service:

```
# start  
systemctl start ttnstack  
  
# stop  
systemctl stop ttnstack  
  
# enable  
systemctl enable ttnstack  
  
#disable  
systemctl disable ttnstack
```

Use the following commands to start and stop the Node-Red service:

```
# start  
systemctl start nodered  
  
# stop  
systemctl stop nodered  
  
# enable  
systemctl enable nodered  
  
#disable  
systemctl disable nodered
```

How to choose the Chirpstack server frequency SubBand

The user has to choose a SubBand if using CN470, US915, AU915, or AS923.

Note: Since the subbands of the Chirpstack are counted from 0, us915_1 of the Chirpstack is equal to US915 FSB2, so if your LoRa Rdio is using the US915 FSB2 you have to choose the us915_1 as the Chirpstack FSB.

The screenshot shows the 'Built-In Network Server' configuration page in the DRAGINO web interface. The navigation bar at the top includes 'LoRa', 'LoRaWAN', 'Network', 'System', 'Server', 'LogRead', 'Home', and 'Logout'. The main content area is titled 'Built-In Network Server' and contains the following configuration options:

- Platform Provider:** Chirpstack
- Enable:**
- Service Status:** **Running**
- Server Versions:** **Chirpstack V4**
- Frequency Plan:** US915 (dropdown menu)
- Frequency Sub Band:** us915_1 (dropdown menu)
-

The dropdown menu for 'Frequency Sub Band' is open, showing the following options: us915_0, us915_1 (highlighted), us915_2, us915_3, us915_4, us915_5, us915_6, and us915_7.

When the configuration is complete, click "**Save&Apply**".

Note: When adding the device profile, the selected Region configuration is also calculated from 0, so setting it to us915_1 corresponds to US915 Sub Band 2.

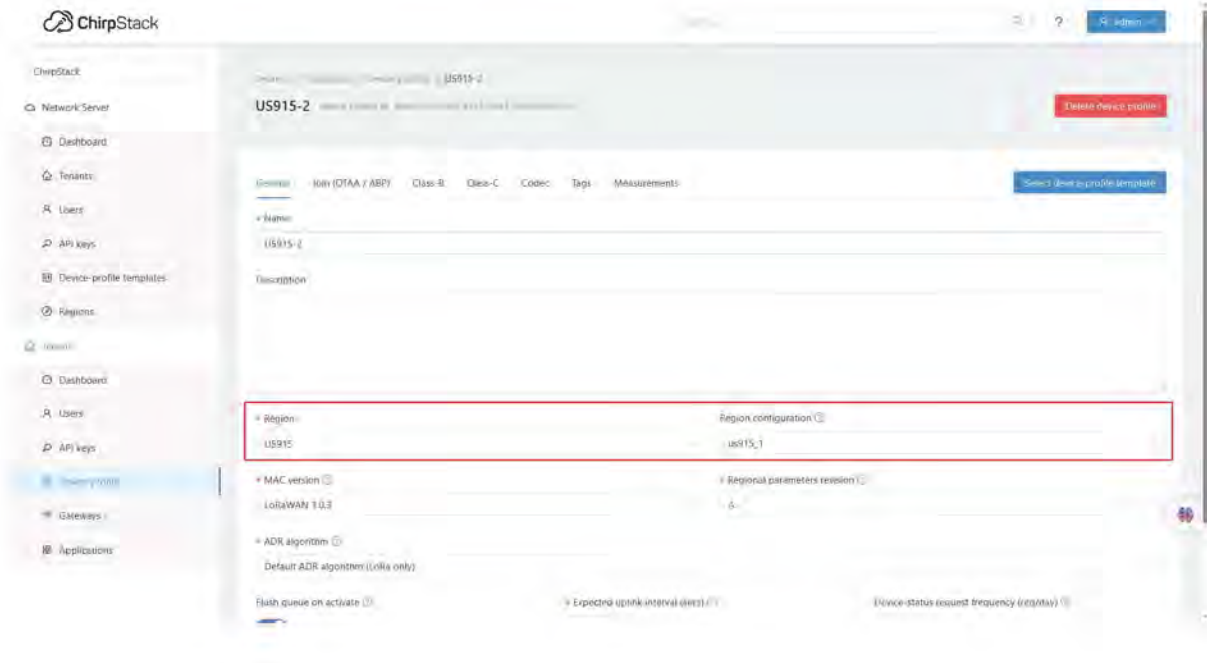

5. Watch Dog

LPS8-V2 supports the Watch Dog but is not enabled by the previous releases(2023-11-24)

The uses can be via the below method to enable Watch Dog:

```
wget -P /tmp/ http://repo.dragino.com/release/tool/watchdog/enable_watchdog.sh && chmod +x /tmp/enable_watchdog.sh && /tmp/enable_watchdog.sh
```

```

root@dragino-265d26:~# wget -P /tmp/ http://repo.dragino.com/release/tool/watchdog/enable_watchdog.sh && chmod +x /tmp/enable_watchdog.sh && /tmp/enable_watchdog.sh
--2023-11-24 03:18:34-- http://repo.dragino.com/release/tool/watchdog/enable_watchdog.sh
Resolving repo.dragino.com (repo.dragino.com)... 47.89.8.92
Connecting to repo.dragino.com (repo.dragino.com)|47.89.8.92|:80... connected.
HTTP request sent, awaiting response... 200 OK
Length: 287 [application/octet-stream]
Saving to: '/tmp/enable_watchdog.sh'

enable_watchdog.sh 100%[=====] 287 --.-KB/s 1in 0s

2023-11-24 03:18:40 (4.38 MB/s) = '/tmp/enable_watchdog.sh' saved [287/287]

--2023-11-24 03:18:40-- http://repo.dragino.com/release/tool/watchdog/basic_dog
Resolving repo.dragino.com (repo.dragino.com)... 47.89.8.92
Connecting to repo.dragino.com (repo.dragino.com)|47.89.8.92|:80... connected.
HTTP request sent, awaiting response... 200 OK
Length: 7976 (7.8k) [application/octet-stream]
Saving to: '/usr/bin/basic_dog.1'

basic_dog.1 100%[=====] 7.79K --.-KB/s 1in 0s

2023-11-24 03:18:40 (114 MB/s) = '/usr/bin/basic_dog.1' saved [7976/7976]

--2023-11-24 03:18:40-- http://repo.dragino.com/release/tool/watchdog/draginowatchdog.service
Resolving repo.dragino.com (repo.dragino.com)... 47.89.8.92
Connecting to repo.dragino.com (repo.dragino.com)|47.89.8.92|:80... connected.
HTTP request sent, awaiting response... 200 OK
Length: 136 [application/octet-stream]
Saving to: '/usr/lib/systemd/system/draginowatchdog.service.1'

draginowatchdog.service.1 100%[=====] 136 --.-KB/s 1in 0s

2023-11-24 03:18:40 (2.70 MB/s) = '/usr/lib/systemd/system/draginowatchdog.service.1' saved [136/136]

Created symlink /etc/systemd/system/multi-user.target.wants/draginowatchdog.service - /lib/systemd/system/draginowatchdog.service.
root@dragino-265d26:~#
root@dragino-265d26:~#
root@dragino-265d26:~#
root@dragino-265d26:~# systemctl status draginowatchdog
● draginowatchdog.service - dragino watch dog
   Loaded: loaded (/lib/systemd/system/draginowatchdog.service; enabled; vendor preset: enabled)
   Active: active (running) since Fri 2023-11-24 03:18:42 UTC; 21s ago
     Main PID: 2278 (basic_dog)
       Tasks: 1 (limit: 502)
        Memory: 128.0K
           CPU: 1ms
      CGroup: /system.slice/draginowatchdog.service
              └─1278 /usr/bin/basic_dog
    
```

6. How users can access LPS8-V2 using serial USB

USB TTL to LPS8-V2 Connection:

Port 1 of the UART on the LPS8-V2 is GND

TXD <--> UART RXD (Gray line)

RXD <--> UART TXD (White line)

GND <--> GND (Black line)

LPS8v2 UART connection photo

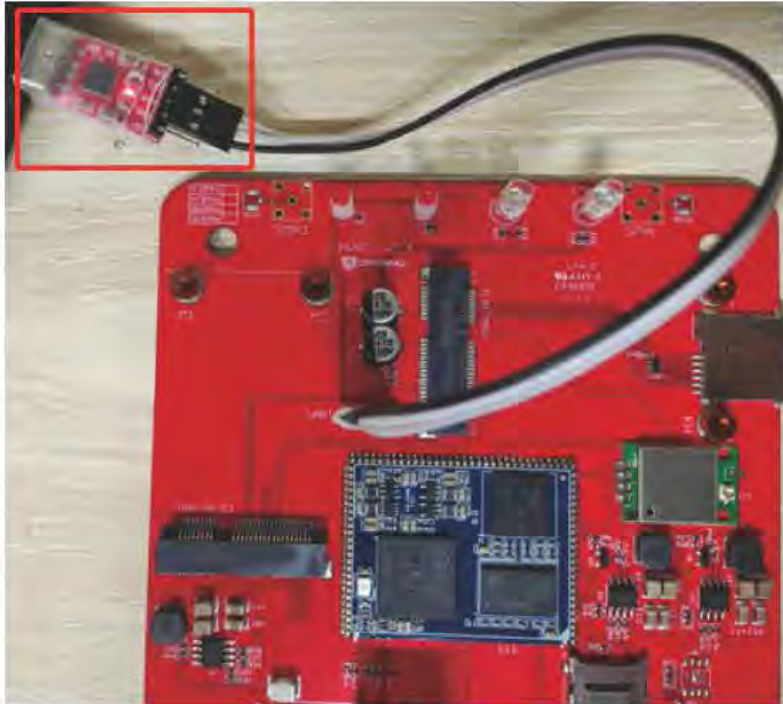

In the PC, you can use the serial port tool (such as [putty](#) in Windows), you need to set the serial baud rate to **115200** to access the serial console for LPS8v2. LPS8v2 will output system info once power on as below:

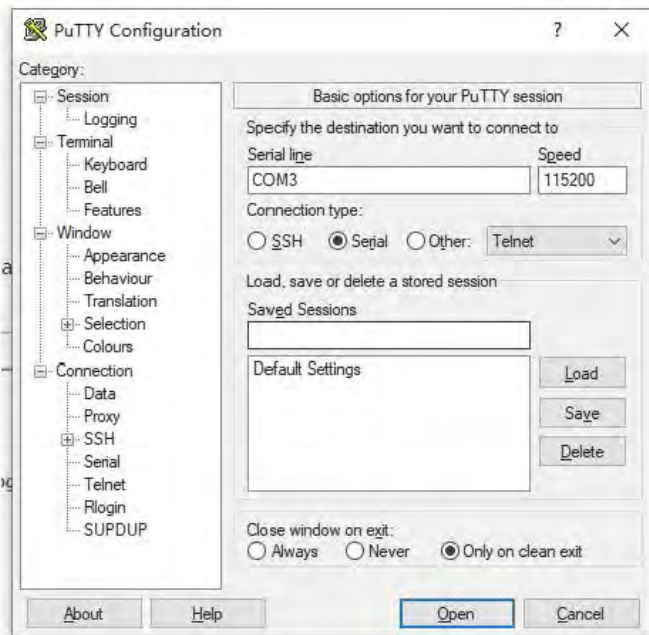

```
root@dragino-240059:~#
U-Boot SPL 2021.10-armbian (Jul 07 2022 - 04:27:17 +0000)
DRAM: 512 MiB
Trying to boot from MMC2

U-Boot 2021.10-armbian (Jul 07 2022 - 04:27:17 +0000) Allwinner Technology

CPU:   Allwinner H3 (SUN8I 1680)
Model: Dragino HotSpot Zero
DRAM:  512 MiB
MMC:   mmc@1c0f000: 0, mmc@1c10000: 2, mmc@1c11000: 1
Loading Environment from FAT... Unable to use mmc 1:1... In:   serial
Out:   serial
Err:   serial
Net:   phy interface0
eth0:  ethernet@1c30000
Card did not respond to voltage select! : -110
Couldn't find partition mmc 0
Card did not respond to voltage select! : -110
Couldn't find partition mmc 0
starting USB...
Bus usb@1c1a000: USB EHCI 1.00
Bus usb@1c1a400: USB OHCI 1.0
Bus usb@1c1b000: USB EHCI 1.00
Bus usb@1c1b400: USB OHCI 1.0
Bus usb@1c1c000: USB EHCI 1.00
Bus usb@1c1c400: USB OHCI 1.0
Bus usb@1c1d000: USB EHCI 1.00
Bus usb@1c1d400: USB OHCI 1.0
scanning bus usb@1c1a000 for devices... 1 USB Device(s) found
scanning bus usb@1c1a400 for devices... 1 USB Device(s) found
scanning bus usb@1c1b000 for devices... 1 USB Device(s) found
scanning bus usb@1c1b400 for devices... 1 USB Device(s) found
scanning bus usb@1c1c000 for devices... 1 USB Device(s) found
scanning bus usb@1c1c400 for devices... 1 USB Device(s) found
scanning bus usb@1c1d000 for devices... 2 USB Device(s) found
scanning bus usb@1c1d400 for devices... 1 USB Device(s) found
scanning usb for storage devices... 0 Storage Device(s) found
Autoboot in 1 seconds, press <Space> to stop
switch to partitions #0, OK
mmc1(part 0) is current device
Scanning mmc 1:1...
Found U-Boot script /boot/boot.scr
3772 bytes read in 1 ms (3.6 MiB/s)
## Executing script at 43100000
U-boot loaded from eMMC or secondary SD
Card did not respond to voltage select! : -110
Boot script loaded from mmc
202 bytes read in 1 ms (197.3 KiB/s)
11639090 bytes read in 249 ms (44.6 MiB/s)
7829384 bytes read in 167 ms (44.7 MiB/s)
found mainline kernel configuration
```

7. OTA System Update

LPS8v2 supports system auto-update via OTA, please see [this URL](#) for the detail of this feature.

7.1 Auto-update method

The default, each gateway will enable the auto-update function.

this function will be triggered every boot and every midnight.

Users can enable/disable it via Web Page

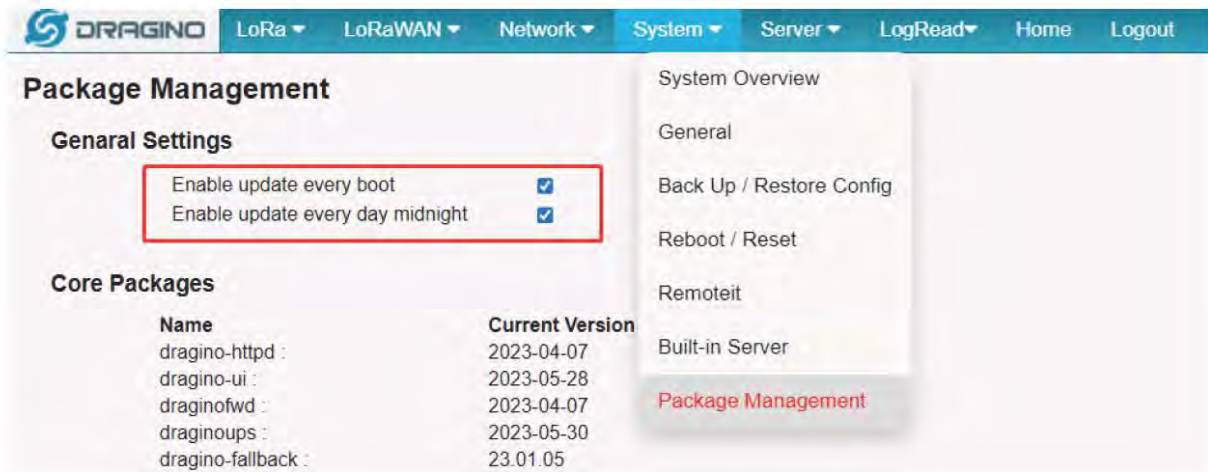

7.2 Manual upgrade method

1). Using the Linux command to upgrade the system

apt update && apt install *dragino*

2). Upgrade the system via the Web page button of "Manual Update"

Note: this method needs about 10 mins, so you will get the log after 10 mins.

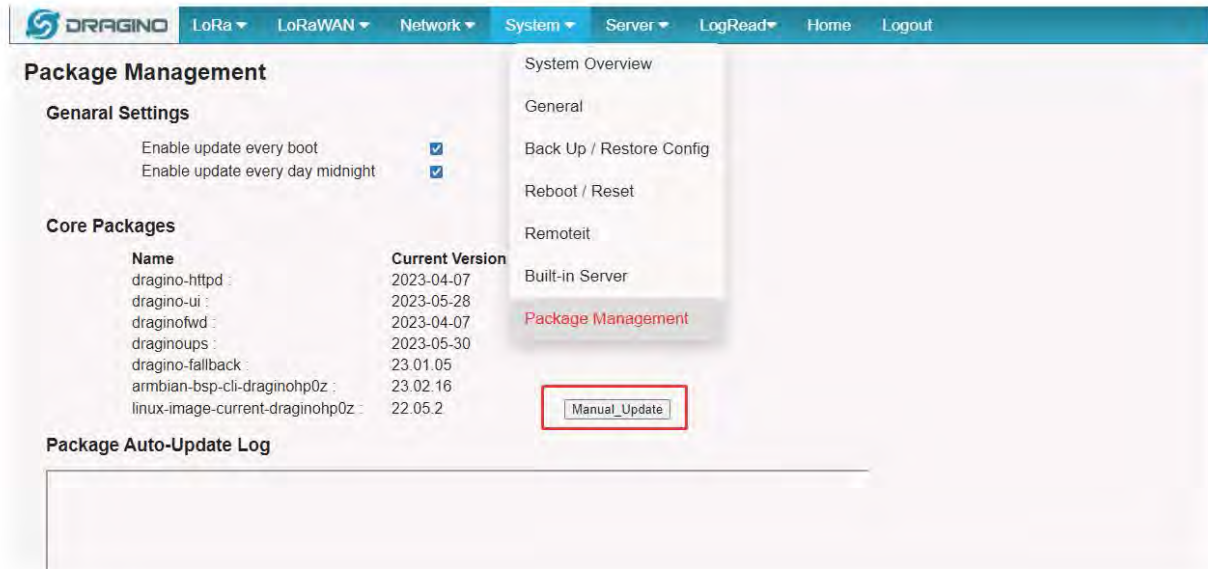

8. FAQ

8.1 How to change Hostname

By default, Hostname is dragino-xxxxxx, If the user needs to change the hostname, the user needs to access the linux console of LPS8v2 and enter the following command:

```
hostnamectl set-hostname dragino-123456
```

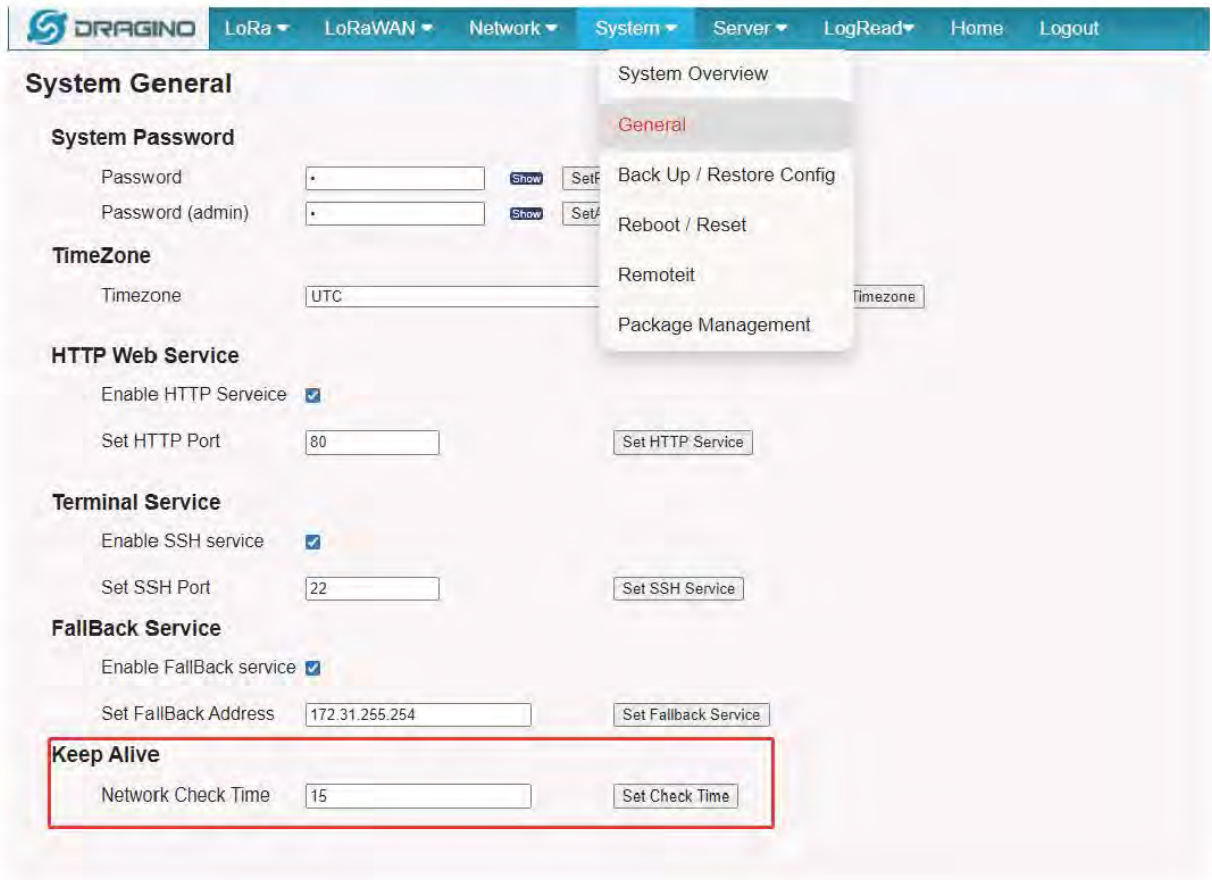
2. Change the LoRa status package interval time: It does not affect the connection between the gateway and the server, just the status packet interval

The screenshot shows the 'LoRa Configura' web interface. At the top, there is a navigation bar with the DRAGINO logo and menu items: LoRa, LoRaWAN, Network, System, Server, LogRead, Home, and Logout. The main heading is 'LoRa Configura' with a 'LoRa' sub-heading. Below this, there is a 'Debug Level' dropdown set to 'Low'. The 'Radio Settings' section contains a 'Stat Package Period (sec)' input field with the value '30', which is highlighted with a red box. Below it is a 'Frequency Plan' dropdown set to 'EU868 Europe 868Mhz (863-870)'. The 'Static GPS coordinates ?' section includes checkboxes for 'Enable Static GPS' (unchecked), and input fields for 'Latitude' (22.700000), 'Longitude' (114.240000), and 'Altitude (m)' (450). At the bottom, it shows 'Current Mode: LoRaWAN Semtech UDP' and buttons for 'Save&Apply', 'Disable', and 'Cancel'.

3. Disable the auto-update:

The screenshot shows the 'Package Management' web interface. At the top, there is a navigation bar with the DRAGINO logo and menu items: LoRa, LoRaWAN, Network, System, Server, LogRead, Home, and Logout. The main heading is 'Package Management'. Below this, the 'General Settings' section is highlighted with a red box. It contains two checkboxes: 'Enable update every boot' (checked) and 'Enable update every day midnight' (checked). A 'SAVE' button is located to the right of these checkboxes. Below the 'General Settings' is the 'Core Packages' section, which is a table listing various packages and their current versions. At the bottom right of this section is a 'Manual_Update' button. The 'Package Auto-Update Log' section is visible at the bottom but is empty.

Name	Current Version
dragino-httpd :	2023-04-07
dragino-ui :	2023-07-16
draginofwd :	2023-04-07
draginoups :	2023-06-30
dragino-fallback :	23.01.05
armbian-bsp-cli-draginohp0z :	23.02.16
linux-image-current-draginohp0z :	22.05.2

8.4 How to connect the helium blockchain as a Data-only hotspot

apt update && apt install helium-gateway

8.5 How to change built-in LoRaWAN Server from ChirpStack v4 to TTN Stack v3.

By default, the LPS8v2's built-in server is ChirpStack v4,

If the user needs to change the built-in server from ChirpStack v4 to TTN Stack v3, the User needs to download the image and flash it to the LPS8v2 gateway:

<https://www.dropbox.com/scl/fi/qwtaw4i4dqonzramr93e4/dragino-LPS8V2-TTN-231124.rar?rlkey=nrftikd1h8en6j07vzbhbj9ui&dl=0>

Image flash steps: [How to flash a new image\(OS\) to the gateway\(LPS8V2\)](#)

8.6 How do I view gateway logs

8.6.1 LoRaWAN Log:

Semtech UDP Log :

When the gateway starts LoRaWAN Semtech UDP, users can check the logs of the Semtech UDP in the **LogRead** --> **System Log** interface

DRAGINO LoRa LoRaWAN Network System Server LogRead Home Logout

System Log

LoRa Log
Gateway Traffic
System Log
Record Log

USB Devices:

```

Bus 008 Device 001: ID 1d6b:0001 Linux Foundation 1.1 root hub
Bus 004 Device 003: ID 148f:7601 Ralink Technology, Corp. MT7601U Wireless Adapter
Bus 004 Device 001: ID 1d6b:0002 Linux Foundation 2.0 root hub
Bus 007 Device 001: ID 1d6b:0001 Linux Foundation 1.1 root hub
Bus 003 Device 001: ID 1d6b:0002 Linux Foundation 2.0 root hub
Bus 006 Device 001: ID 1d6b:0001 Linux Foundation 1.1 root hub
Bus 002 Device 001: ID 1d6b:0002 Linux Foundation 2.0 root hub
Bus 005 Device 001: ID 1d6b:0001 Linux Foundation 1.1 root hub
    
```

Boot Info:

```

[1608979.483316] eth0: renamed from vethc890f81
[1608979.507183] IPv6: ADDRCONF(NETDEV_CHANGE): vethbf2belf: link becomes ready
[1608979.507433] br-f8865b8def50: port 6(vethbf2belf) entered blocking state
[1608979.507459] br-f8865b8def50: port 6(vethbf2belf) entered forwarding state
[1608980.062144] br-f8865b8def50: port 6(vethbf2belf) entered disabled state
[1608980.063348] vethc890f81: renamed from eth0
[1608980.135216] br-f8865b8def50: port 6(vethbf2belf) entered disabled state
[1608980.138507] device vethbf2belf left promiscuous mode
[1608980.138560] br-f8865b8def50: port 6(vethbf2belf) entered disabled state
[1609039.944186] overlaysfs: disabling nfs_export due to index=off
    
```

Previous Log: lorawan

```

Oct 17 03:20:48 dragino-2d5d26 fwd[16343]: PKTUP [secondary_server] JSON: [{"rxpk":{"jver":1,"tmst":2350260279,"time":"2023-10-17T03:20:48.710786Z","chan":2,"rfch":1,"freq":868.500000,"mid":0,"stat":1,"modu":"LORA","dadr":"SF12BW125","codr":"4/5","rssi":-76,"lsnr":3.8,"foff":-558,"rssi":-75,"size":25,"data":"gCb///+BakNAqHj0oNZXEAKh89As0q05A=="}]}]
Oct 17 03:20:48 dragino-2d5d26 fwd[16343]: PKTUP [primary_server] JSON: [{"rxpk":{"jver":1,"tmst":2350260279,"time":"2023-10-17T03:20:48.710851Z","chan":2,"rfch":1,"freq":868.500000,"mid":0,"stat":1,"modu":"LORA","dadr":"SF12BW125","codr":"4/5","rssi":-76,"lsnr":3.8,"foff":-558,"rssi":-75,"size":25,"data":"gCb///+BakNAqHj0oNZXEAKh89As0q05A=="}]}]
Oct 17 03:20:48 dragino-2d5d26 fwd[16343]: INFO [primary_server-up] PUSH_ACK received in 1 ms
Oct 17 03:20:48 dragino-2d5d26 fwd[16343]: CONF_UP:{"ADDR":"FFFFFF66","Size":25,"Rssi":-75,"snr":4,"FCtrl":{"ADR":1,"ACK":0,"FPending":0,"FoptsLen":1,"FCnt":2410,"FPort":2,"MIC":"E48E4AB3"}
Oct 17 03:20:48 dragino-2d5d26 fwd[16343]: lgw_receive:1323: INFO: RSSI temperature offset applied: 1.472 dB (current temperature 33.8 C)
Oct 17 03:20:48 dragino-2d5d26 fwd[16343]: lgw_receive:1326: INFO: nb pkt found:1 left:0
Oct 17 03:20:48 dragino-2d5d26 fwd[16343]: INFO [primary_server-up] received packages from mote: FFFFFFFAA (fcnt=51596)
Oct 17 03:20:48 dragino-2d5d26 fwd[16343]: PKTUP [primary_server] JSON: [{"rxpk":{"jver":1,"tmst":2350448884,"time":"2023-10-17T03:20:48.901937Z","chan":1,"rfch":1,"freq":868.300000,"mid":2,"stat":1,"modu":"LORA","dadr":"SF12BW125","codr":"4/5","rssi":-79,"lsnr":8.8,"foff":-308,"rssi":-78,"size":24,"data":"QKr///+AjMkCn0j0fhWFK/wjvJTezXU"}]}]
Oct 17 03:20:48 dragino-2d5d26 fwd[16343]: INFO [primary_server-up] PUSH_ACK received in 1 ms
    
```

Station Log:

When the gateway starts Basic Station, users can check the logs of the station in the **LogRead --> System Log** interface

The screenshot shows the DRAGINO web interface. At the top, there is a navigation bar with the DRAGINO logo and menu items: LoRa, LoRaWAN, Network, System, LogRead, Home, and Logout. Below the navigation bar, the 'System Log' section is active, with a dropdown menu showing options: LoRa Log, Gateway Traffic, System Log (highlighted), and Record Log. The main content area is divided into two sections: 'USB Devices:' and 'Boot Info:'. The 'USB Devices:' section lists several USB devices with their IDs and descriptions. The 'Boot Info:' section shows the Linux boot process logs. Below these sections, the 'Previous Log: station' section is highlighted with a red border, displaying a detailed log of network events including packet reception and transmission statistics.

System Log

USB Devices:

```
Bus 008 Device 001: ID 1d6b:0001 Linux Foundation 1.1 root hub
Bus 004 Device 002: ID 149f:7601 Realtek Technology, Corp. MT7601U Wireless Adapter
Bus 004 Device 001: ID 1d6b:0002 Linux Foundation 2.0 root hub
Bus 007 Device 001: ID 1d6b:0001 Linux Foundation 1.1 root hub
Bus 003 Device 001: ID 1d6b:0002 Linux Foundation 2.0 root hub
Bus 006 Device 001: ID 1d6b:0001 Linux Foundation 1.1 root hub
Bus 002 Device 002: ID 2c7c:0125 Quectel Wireless Solutions Co., Ltd. EC25 LTE modem
Bus 002 Device 001: ID 1d6b:0002 Linux Foundation 2.0 root hub
```

Boot Info:

```
[ 0.000000] Booting Linux on physical CPU 0x0
[ 0.000000] Linux version 5.15.43-r700 (root@1c2ad345ab57) (arm-linux-gnueabi-hf-gcc (GNU Toolchain for the A-profile Architecture 8.3-2019.03 (arm-rel-8.36)) 8.3.0, GNU ld (GNU Toolchain for the A-profile Architecture 8.3-2019.03 (arm-rel-8.36)) 2.32.0.20190321) #22.05.2 SMP Thu Sep 21 03:32:54 UTC 2023
[ 0.000000] CPU: ARMv7 Processor [410fc075] revision 5 (ARMv7), cr=50c5387d
[ 0.000000] CPU: div instructions available: patching division code
[ 0.000000] CPU: PIPT / VIPT nonaliasing data cache, VIPT aliasing instruction cache
[ 0.000000] OF: fdt: Machine model M700
[ 0.000000] Memory policy: Data cache writealloc
[ 0.000000] cma: Reserved 104 MiB at 0x57400000
[ 0.000000] Zone ranges:
```

Previous Log: station

```
F0pts=[] 02D3ED69..1230 mic=-1536678225 (24 bytes)
2023-10-17 02:12:16.866 [RAL:DEBU] [CRC FAIL] 868.300MHz -1.50/-102.5 SF12/BW125 (mod=16/dr=12/bw=4) xtick=bf094ce2 (3205057634) 25 bytes:
8022FFFFFFf81B0090D0288B4BC78925CF48E1AD764D0A0E87F
2023-10-17 02:12:17.892 [S2E:VERB] RX 868.3MHz DR0 SF12/BW125 snr=3.5 rssi=-98 xtime=0xC90006BF18EB97 - updf mhdr=80 DevAddr=FFFFFFF7 FCtrl=81 FCnt=2383
F0pts=[0D] 029C5449..AF3D mic=-844766740 (25 bytes)
2023-10-17 02:12:19.675 [S2E:VERB] RX 868.3MHz DR5 SF7/BW125 snr=10.8 rssi=-114 xtime=0xC90006BF345F93 - updf mhdr=40 DevAddr=002F1FD1 FCtrl=80 FCnt=16730
F0pts=[] 02D0839F..92D6 mic=-759554165 (24 bytes)
2023-10-17 02:12:21.990 [S2E:VERB] RX 868.1MHz DR5 SF7/BW125 snr=12.5 rssi=-110 xtime=0xC90006BF57B969 - updf mhdr=40 DevAddr=00750E4B FCtrl=C0 FCnt=25393
F0pts=[] 02C55E2C..D4DA mic=-722967603 (24 bytes)
2023-10-17 02:12:22.569 [SYN:INFO] MCU/SX130X drift stats: min: +0.0ppm q50: +1.4ppm q80: +11.9ppm max: +14.8ppm - threshold q90: -12.9ppm
2023-10-17 02:12:22.590 [SYN:INFO] Mean MCU drift vs SX130X#0: 1.3ppm
2023-10-17 02:12:22.890 [RAL:DEBU] [CRC FAIL] 868.500MHz 1.75/-115.5 SF12/BW125 (mod=16/dr=12/bw=4) xtick=bf624ce7 (3210890471) 24 bytes:
40AFFFFFFF806BC902956C1AD2AC655F62928BF6C23C486D
2023-10-17 02:12:24.037 [RAL:DEBU] [CRC FAIL] 868.500MHz -3.50/-108.5 SF12/BW125 (mod=16/dr=12/bw=4) xtick=bf76c4a5 (3212231845) 25 bytes:
80334F0FEE102D38FC035EB1A30063770B49455161D4CCEEBB
2023-10-17 02:12:24.707 [S2E:VERB] RX 868.5MHz DR0 SF12/BW125 snr=5.8 rssi=-104 xtime=0xC90006BF80F8A6 - updf mhdr=80 DevAddr=FFFFFFF2 FCtrl=81 FCnt=2481
F0pts=[0D] 02B4D935..3F1C mic=-1918622993 (25 bytes)
2023-10-17 02:12:24.731 [S2E:VERB] RX 868.1MHz DR0 SF12/BW125 snr=8.8 rssi=-99 xtime=0xC90006BF815DEC - updf mhdr=80 DevAddr=FFFFFFF7 FCtrl=81 FCnt=2384
F0pts=[0D] 02EC923B..2311 mic=1034066505 (25 bytes)
```

8.6.2 4G Log

The user needs to access the Linux console of the gateway and enter the following command:

```
cat /var/log/qmllog.txt
```

```
root@m700-24d12d:~# cat /var/log/qmi.log.txt
[10-16_03:17:10:214] Find /sys/bus/usb/devices/2-1 idVendor=0x2c7c idProduct=0x125, bus=0x002, dev=0x002
[10-16_03:17:10:215] Auto find qmichannel = /dev/cdc-wdm0
[10-16_03:17:10:215] Auto find usbnet_adapter = wwan0
[10-16_03:17:10:215] netcard driver = qmi_wwan, driver version = 5.15.43-m700
[10-16_03:17:10:222] Modem works in QMI mode
[10-16_03:17:10:370] cdc_wdm_fd = 8
[10-16_03:17:10:453] Get clientWDS = 20
[10-16_03:17:10:485] Get clientDMS = 1
[10-16_03:17:10:520] Get clientNAS = 4
[10-16_03:17:10:550] Get clientUIM = 1
[10-16_03:17:10:582] Get clientWDA = 1
[10-16_03:17:10:618] requestBaseBandVersion EC25EFAR06A16M4G
[10-16_03:17:10:742] requestGetSIMStatus SIMStatus: SIM_READY
[10-16_03:17:10:742] requestSetProfile[1] 3gnet///0
[10-16_03:17:10:808] requestGetProfile[1] 3gnet///0
[10-16_03:17:10:839] requestRegistrationState2 MCC: 460, MNC: 1, PS: Attached, DataCap: LTE
[10-16_03:17:10:870] requestQueryDataCall IPv4ConnectionStatus: DISCONNECTED
[10-16_03:17:10:870] ifconfig wwan0 0.0.0.0
[10-16_03:17:10:889] ifconfig wwan0 down
[10-16_03:17:10:998] requestSetupDataCall WdsConnectionIPv4Handle: 0x8729f850
[10-16_03:17:11:127] ifconfig wwan0 up
[10-16_03:17:11:156] busybox udhcpc -f -n -q -t 5 -i wwan0
[10-16_03:43:47:086] File:q_l_raw_ip_mode_check Line:136 udhcpc fail to get ip address, try next:
[10-16_03:43:47:086] ifconfig wwan0 down
[10-16_03:43:47:106] echo Y > /sys/class/net/wwan0/qmi/raw_ip
[10-16_03:43:47:106] ifconfig wwan0 up
[10-16_03:43:47:124] busybox udhcpc -f -n -q -t 5 -i wwan0
[10-16_03:47:03:742] requestQueryDataCall IPv4ConnectionStatus: DISCONNECTED
[10-16_03:47:03:743] ifconfig wwan0 0.0.0.0
[10-16_03:47:03:758] ifconfig wwan0 down
[10-16_03:47:03:934] requestRegistrationState2 MCC: 0, MNC: 0, PS: Detached, DataCap: UNKNOWN
[10-16_03:47:08:286] requestRegistrationState2 MCC: 460, MNC: 0, PS: Detached, DataCap: UNKNOWN
[10-16_03:47:08:319] requestRegistrationState2 MCC: 460, MNC: 0, PS: Detached, DataCap: UNKNOWN
[10-16_03:47:57:313] QmiWwanThread exit
[10-16_03:47:57:314] qmi_main exit
[10-16_03:48:27:602] Find /sys/bus/usb/devices/2-1 idVendor=0x2c7c idProduct=0x125, bus=0x002, dev=0x002
[10-16_03:48:27:604] Auto find qmichannel = /dev/cdc-wdm0
[10-16_03:48:27:604] Auto find usbnet_adapter = wwan0
[10-16_03:48:27:604] netcard driver = qmi_wwan, driver version = 5.15.43-m700
[10-16_03:48:27:604] Modem works in QMI mode
[10-16_03:48:27:621] cdc_wdm_fd = 8
[10-16_03:48:27:710] Get clientWDS = 20
[10-16_03:48:27:742] Get clientDMS = 1
[10-16_03:48:27:774] Get clientNAS = 4
[10-16_03:48:27:807] Get clientUIM = 1
[10-16_03:48:27:838] Get clientWDA = 1
[10-16_03:48:27:870] requestBaseBandVersion EC25EFAR06A16M4G
[10-16_03:48:27:999] requestGetSIMStatus SIMStatus: SIM_ABSENT
[10-16_03:48:27:999] requestSetProfile[1] 3gnet///0
[10-16_03:48:28:064] requestGetProfile[1] 3gnet///0
[10-16_03:48:28:095] requestRegistrationState2 MCC: 460, MNC: 0, PS: Detached, DataCap: UNKNOWN
[10-16_03:48:28:127] requestQueryDataCall IPv4ConnectionStatus: DISCONNECTED
[10-16_03:48:28:145] ifconfig wwan0 0.0.0.0
[10-16_03:48:28:145] ifconfig wwan0 down
[10-16_03:55:52:899] QmiWwanThread exit
[10-16_03:55:52:901] qmi_main exit
```

8.6.3 Dmesg Log

Users can check the logs of the Dmesg in the LogRead --> System Log interface:

System Log

LoRa Log
Gateway Traffic
System Log
Record Log

USB Devices:

```
Bus 008 Device 001: ID 1d6b:0001 Linux Foundation 1.1 root hub
Bus 004 Device 002: ID 148f:7601 Ralink Technology, Corp. MT7601U Wireless Adapter
Bus 004 Device 001: ID 1d6b:0002 Linux Foundation 2.0 root hub
Bus 007 Device 001: ID 1d6b:0001 Linux Foundation 1.1 root hub
Bus 003 Device 001: ID 1d6b:0002 Linux Foundation 2.0 root hub
Bus 006 Device 001: ID 1d6b:0001 Linux Foundation 1.1 root hub
Bus 002 Device 002: ID 2c7c:0125 Quectel Wireless Solutions Co., Ltd. EC25 LTE modem
Bus 002 Device 001: ID 1d6b:0002 Linux Foundation 2.0 root hub
```

Boot Info:

```
[ 16.527695] dvmac-sun8i 1c30000.ethernet eth0: No Safety Features support found
[ 16.527726] dvmac-sun8i 1c30000.ethernet eth0: No MAC Management Counters available
[ 16.527739] dvmac-sun8i 1c30000.ethernet eth0: PTP not supported by HW
[ 16.534420] dvmac-sun8i 1c30000.ethernet eth0: configuring for phy/mii link mode
[ 16.539976] dvmac-sun8i 1c30000.ethernet eth0: Link is Up - 100Mbps/Full - flow control rx/tx
[ 16.540348] IPv6: ADDRCONF(NETDEV_CHANGE): eth0: link becomes ready
[ 33.786196] vcc3v0: disabling
[61592.464305] dvmac-sun8i 1c30000.ethernet eth0: Link is Down
[61660.048368] dvmac-sun8i 1c30000.ethernet eth0: Link is Up - 100Mbps/Full - flow control rx/tx
```

Previous Log: station

```
2023-10-16 19:42:08.002 [S2E:VERB] RX 868.5MHz DR0 SF12/BW125 snr=4.5 rssi=-113 xtime=0xC900014BC25731 - updf mhdr=80 DevAddr=FFFFFFF3 FCtrl=81 FCnt=64917
Fopts=[0D] 024A8B41..DC67 mic=740548861 (25 bytes)
2023-10-16 19:42:08.997 [S2E:VERB] RX 868.3MHz DR0 SF12/BW125 snr=7.8 rssi=-105 xtime=0xC900014BD19993 - updf mhdr=80 DevAddr=FFFFFFF6 FCtrl=81 FCnt=64926
Fopts=[0D] 02E68464..4C0A mic=1633235622 (25 bytes)
2023-10-16 19:42:10.095 [S2E:VERB] RX 868.1MHz DR0 SF12/BW125 snr=8.2 rssi=-101 xtime=0xC900014BE256F3 - updf mhdr=80 DevAddr=FFFFFFF7 FCtrl=81 FCnt=64947
Fopts=[0D] 02D5930D..28F5 mic=907600284 (25 bytes)
2023-10-16 19:42:10.096 [_____] INFO lgw_receive:1326: INFO: nb pkt found:1 left:0
lgw_receive:1323: INFO: RSSI temperature offset applied: 1.786 dB (current temperature 39.4 C)
lgw_receive:1326: INFO: nb pkt found:1 left:0
lgw_receive:1323: INFO: RSSI temperature offset applied: 1.782 dB (current temperature 39.4 C)
lgw_receive:1326: INFO: nb pkt found:1 left:0
lgw_receive:1323: INFO: RSSI temperature offset applied: 1.786 dB (current temperature 39.4 C)
lgw_receive:1326: INFO: nb pkt found:1 left:0
lgw_receive:1323: INFO: RSSI temperature offset applied: 1.782 dB (current temperature 39.4 C)
lgw_receive:1326: INFO: nb pkt found:1 left:0
lgw_receive:1323: INFO: RSSI temperature offset applied: 1.786 dB (current temperature 39.4 C)
lgw_receive:1326: INFO: nb pkt found:1 left:0
lgw_receive:1323: INFO: RSSI temperature offset applied: 1.782 dB (current temperature 39.4 C)
lgw_receive:1326: INFO: nb pkt found:1 left:0
lgw_receive:1323: INFO: RSSI temperature offset applied: 1.786 dB (current temperature 39.4 C)
lgw_receive:1326: INFO: nb pkt found:1 left:0
lgw_receive:1323: INFO: RSSI temperature offset applied: 1.782 dB (current temperature 39.4 C)
```

8.6.4 Record Log

Users can record DMESE logs and LoRaWAN logs on the **LogRead -->Record Log** interface

Record Log

LoRa Log
Gateway Traffic
System Log
Record Log

StartLog StopLog ResetLog

[Download Log File](#)

8.6.5 View gateway logs via Linux Command

Semtech UDP Log :

journalctl -u draginofwd -f

```
root@dragino-240057:~# journalctl -u draginofwd -f
root@dragino-240057:~# journalctl -u draginofwd -f
Dec 07 08:44:04 dragino-240057 fwd[144]: PKTUP: [secondary_server] 350n: ["stat":{"time":"2023-12-07 08:44:04 GMT","rxnb":0,"rxpk":0,"rxfw":0,"ackr":90.4,"dwnb":0,"txnb":0,"pfrn":"SK1302","ma11":"",
desc: "Dragino LoRaWAN Gateway"}]
Dec 07 08:44:04 dragino-240057 fwd[144]: INFO- [primary_server-up] PUSH_ACK received in 230 ms
Dec 07 08:44:04 dragino-240057 fwd[144]: INFO- [primary_server-down] PULL_ACK received in 231 ms
Dec 07 08:44:04 dragino-240057 fwd[144]: INFO- [primary_server-down] PULL_ACK received in 231 ms
Dec 07 08:44:04 dragino-240057 fwd[144]: INFO- [primary_server-down] PULL_ACK received in 231 ms
Dec 07 08:44:04 dragino-240057 fwd[144]: INFO- [primary_server-down] PULL_ACK received in 231 ms
Dec 07 08:44:04 dragino-240057 fwd[144]: INFO- [primary_server-down] PULL_ACK received in 231 ms
Dec 07 08:44:04 dragino-240057 fwd[144]: #####[PKT_SERV] no report of this service #####
Dec 07 08:44:04 dragino-240057 fwd[144]: PKTUP: [primary_server] 350n: ["stat":{"time":"2023-12-07 08:44:04 GMT","rxnb":0,"rxpk":0,"rxfw":0,"ackr":90.4,"dwnb":0,"txnb":0,"pfrn":"SK1302","ma11":"",
desc: "Dragino LoRaWAN Gateway"}]
Dec 07 08:44:04 dragino-240057 fwd[144]: PKTUP- [secondary_server] 350n: ["stat":{"time":"2023-12-07 08:44:04 GMT","rxnb":0,"rxpk":0,"rxfw":0,"ackr":90.4,"dwnb":0,"txnb":0,"pfrn":"SK1302","ma11":"",
desc: "Dragino LoRaWAN Gateway"}]
Dec 07 08:44:04 dragino-240057 fwd[144]: INFO- [primary_server-up] PUSH_ACK received in 230 ms
Dec 07 08:44:04 dragino-240057 fwd[144]: INFO- [primary_server-down] PULL_ACK received in 231 ms
Dec 07 08:44:04 dragino-240057 fwd[144]: INFO- [primary_server-down] PULL_ACK received in 231 ms
Dec 07 08:44:04 dragino-240057 fwd[144]: INFO- [primary_server-down] PULL_ACK received in 231 ms
Dec 07 08:44:04 dragino-240057 fwd[144]: INFO- [primary_server-down] PULL_ACK received in 231 ms
Dec 07 08:44:04 dragino-240057 fwd[144]: INFO- [primary_server-down] PULL_ACK received in 231 ms
Dec 07 08:44:04 dragino-240057 fwd[144]: #####[PKT_SERV] no report of this service #####
Dec 07 08:44:04 dragino-240057 fwd[144]: PKTUP- [primary_server] 350n: ["stat":{"time":"2023-12-07 08:44:04 GMT","rxnb":0,"rxpk":0,"rxfw":0,"ackr":90.4,"dwnb":0,"txnb":0,"pfrn":"SK1302","ma11":"",
desc: "Dragino LoRaWAN Gateway"}]
Dec 07 08:44:04 dragino-240057 fwd[144]: PKTUP- [secondary_server] 350n: ["stat":{"time":"2023-12-07 08:44:04 GMT","rxnb":0,"rxpk":0,"rxfw":0,"ackr":90.4,"dwnb":0,"txnb":0,"pfrn":"SK1302","ma11":"",
desc: "Dragino LoRaWAN Gateway"}]
Dec 07 08:46:09 dragino-240057 fwd[144]: INFO- [primary_server-up] PUSH_ACK received in 230 ms
Dec 07 08:46:09 dragino-240057 fwd[144]: INFO- [primary_server-down] PULL_ACK received in 231 ms
Dec 07 08:46:09 dragino-240057 fwd[144]: INFO- [primary_server-down] PULL_ACK received in 231 ms
Dec 07 08:46:09 dragino-240057 fwd[144]: INFO- [primary_server-down] PULL_ACK received in 231 ms
Dec 07 08:46:09 dragino-240057 fwd[144]: INFO- [primary_server-down] PULL_ACK received in 231 ms
Dec 07 08:46:09 dragino-240057 fwd[144]: INFO- [primary_server-down] PULL_ACK received in 231 ms
Dec 07 08:46:09 dragino-240057 fwd[144]: INFO- [primary_server-up] received packages from node: 760A0102 (FCnt=15501)
Dec 07 08:46:09 dragino-240057 fwd[144]: PKTUP- [primary_server] 350n: {"rxpk":{"lver":1,"tsm":"024418731","time":"2023-12-07T08:44:43.125370Z","chan":9,"rfch":1,"freq":909.100000,"mid":8,"stat":1,
"modu":"ORA","datr":"SF7B212","codr":"4/5","rssi":-111,"snr":5.8,"foff":-3965,"rssi2":-112,"size":127,"data":"0A00YAD1FW/gvCjX6Xt+eLrGL#F09eAD"}]}
Dec 07 08:46:09 dragino-240057 fwd[144]: INFO- [secondary_server] 350n: {"rxpk":{"lver":1,"tsm":"024418731","time":"2023-12-07T08:44:43.125370Z","chan":9,"rfch":1,"freq":909.100000,"mid":8,"stat":1,
"modu":"ORA","datr":"SF7B212","codr":"4/5","rssi":-111,"snr":5.8,"foff":-3965,"rssi2":-112,"size":127,"data":"0A00YAD1FW/gvCjX6Xt+eLrGL#F09eAD"}]}
Dec 07 08:46:09 dragino-240057 fwd[144]: UNCONF_UP: {"ADDR":"760A0102","size":127,"rssi":-112,"snr":5.8,"FCRr":{"ADR":1,"ACK":0,"FFpending":0,"FoptsLen":11},"FCnt":15501,"Port":2,"MIC":"0A0E65
FE"}]
Dec 07 08:46:09 dragino-240057 fwd[144]: INFO- [primary_server-up] PUSH_ACK received in 230 ms
Dec 07 08:46:09 dragino-240057 fwd[144]: INFO- [primary_server-down] PULL_ACK received in 231 ms
Dec 07 08:46:09 dragino-240057 fwd[144]: INFO- [primary_server-down] PULL_ACK received in 231 ms
root@dragino-240057:~#
```

Station Log:

tail -f /var/log/station.log

```
root@dragino-240057:~# tail -f /var/log/station.log
root@dragino-240057:~# tail -f /var/log/station.log
2023-12-06 08:19:37.048 [SVN:INFO] MCU SX130X drift stats: min: -2.4ppm q50: -7.1ppm p80: -17.6ppm max: -17.6ppm = threshold q80: -15.9ppm
2023-12-06 08:19:37.994 [SVN:INFO] Near MCU drift vs SX130X: -4.1ppm
2023-12-06 08:19:42.165 [SVN:VERB] Time sync rejected: quality=302 threshold=322
2023-12-06 08:19:44.266 [SVN:WARN] Repeated excessive clock drifts between MCU/SX130X (3 retries): 37.8ppm (threshold 15.9ppm)
2023-12-06 08:19:46.367 [SVN:VERB] Time sync rejected: quality=326 threshold=322
2023-12-06 08:19:46.467 [SVN:VERB] Time sync rejected: quality=303 threshold=322
2023-12-06 08:19:51.618 [SVN:WARN] Repeated excessive clock drifts between MCU/SX130X (6 retries): 38.0ppm (threshold 15.9ppm)
2023-12-06 08:19:56.870 [SVN:VERB] Time sync rejected: quality=356 threshold=322
2023-12-06 08:20:11.573 [SVN:VERB] Time sync rejected: quality=398 threshold=322
2023-12-06 08:20:31.669 [SVN:VERB] rx 904.3MHz DR3 9F/bw125 sr=7.8 rssi=-128 txtime=0x58000000000000 - updt whdr=80 devadr=760E5C64 acrr=1=80 fcnt=6253 fpts=[] 03=8c7d...f081 efc=333986688 (2# by
1#)
```

Dmesg Log:

dmesg

```
tes)
#
root@dragino-2400571:~# dmesg
[ 0.000000] Booting Linux on physical CPU 0x0
[ 0.000000] Linux version 5.15.43-dra81gmp02 (root@2ba7d880000) (arm-linux-gnueabihf-gcc (GNU Toolchain for the A-profile Architecture 8.3-2019.03 (arm-re1-8.36)) 2.32.0.20190321) #22.05.2 SMP wed oct 19 08:27:12 UTC 2022
[ 0.000000] CPU: ARMv7 Processor [410fc075] revision 5 (ARMv7), cr=50c5387d
[ 0.000000] CPU: dtb instructions available: patching divison code
[ 0.000000] CPU: PIPT / VIPT nonaliasing data cache, VIPT aliasing instruction cache
[ 0.000000] DR: fdt: machine model: dragino hotspot zero
[ 0.000000] Memory policy: data cache w/italoc
[ 0.000000] cma: Reserved 104 MiB at 0x57400000
[ 0.000000] Zone ranges:
[ 0.000000] Normal [mem 0x0000000040000000-0x000000005fffffff]
[ 0.000000] HighMem empty
[ 0.000000] Movable zone start for each node
[ 0.000000] Early memory node ranges
[ 0.000000] node 0: [mem 0x0000000040000000-0x000000005fffffff]
[ 0.000000] Initmem setup node 0 [mem 0x0000000040000000-0x000000005fffffff]
[ 0.000000] psci: probing for conduit method from DT.
[ 0.000000] psci: using psci v0.1 function ids from DT
[ 0.000000] percpu: Embedded 18 pages/cpu s36748 r8192 d20396 u65536
[ 0.000000] pcpu-alloc: s36748 r8192 d20396 u65536 alloc=16*4096
[ 0.000000] pcpu-alloc: [0] 0 [0] 1 [0] 2 [0] 3
[ 0.000000] Built 1 zonelists, mobility grouping on. Total pages: 129920
[ 0.000000] Kernel command line: root=uuid=ba752252-dbf5-44be-94cb-3218eabcfd1 net.ifnames=0 rootwait rootfstype=ext4 console=ttyS0,115200 console=tty1 hdmiaudio=EDID:0 dtparam.screen0_output_mode=i182x1080p60 consoleblank=0 loglevel=1 ubootpart= ubootsource=mmc usb-storage quirks=0x2537:0x1066;u,0x2537:0x1068;u sunxi_ve_mem_reserve=0 sunxi_g2d_mem_reserve=0 sunxi_fb_mem_reserve=16 cgroup_
enable-memory_swapaccount=1
[ 0.000000] Unknown kernel command line parameters "consoleblank=0 ubootpart= ubootsource=mmc sunxi_ve_mem_reserve=0 sunxi_g2d_mem_reserve=0 sunxi_fb_mem_reserve=16 cgroup_enable-memory", will be
passed to user space.
[ 0.000000] dentry cache hash table entries: 65536 (order: 6, 262144 bytes, linear)
[ 0.000000] Inode-cache hash table entries: 32768 (order: 5, 131072 bytes, linear)
[ 0.000000] mem auto-init: stack:off, heap alloc:on, heap free:off
[ 0.000000] Memory: 384752K/524288K available (0% kernel code, 1379K rdata, 3016K rodata, 1024K init, 307K bss, 33040K reserved, 106496K cma-reserved, 0K highmem)
[ 0.000000] random: get_random_u32 called from __kmem_cache_create+0x1b/0x2b0 with crng_init=0
[ 0.000000] Slab: mfillpanda, order=0-3, mtrr:objects=0, lru=4, nodes=1
[ 0.000000] kmemleak: allocating 41093 entries in 121 pages.
```

8.7 DIN Mount Reference:



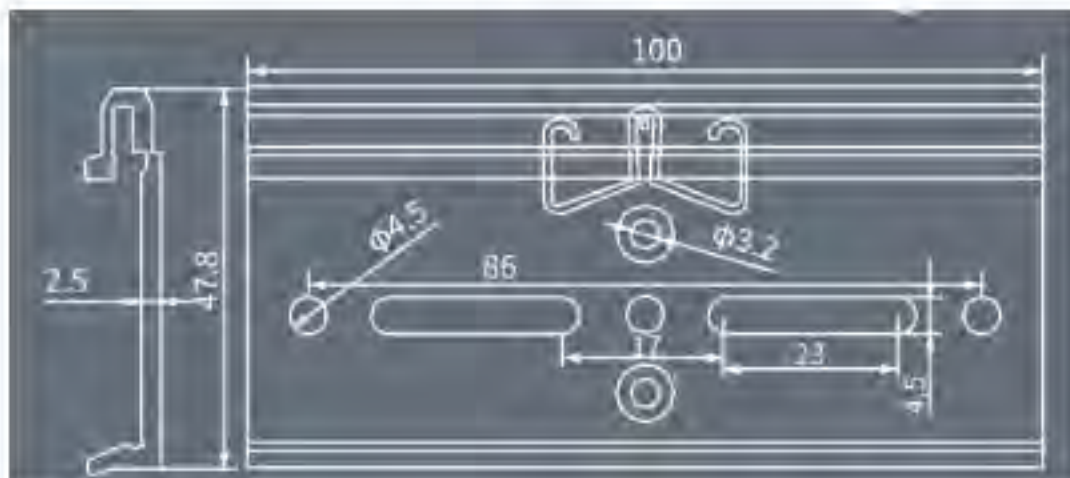

9. Trouble Shooting

9.1 I can't log in to the built-in Server TTN Stack which shows 'Login failed'.

Login failed

There was an error causing the login to fail. This might be due to server-side misconfiguration or a browser cookie problem. Please try logging in again. If the error persists, please contact an administrator.

We're sorry for the inconvenience.

[← Back to login](#)

Error ID: error:pkg/web/oauthclient:exchange

Correlation ID: 853ff836a8f84d578d6290ebdc658b4b

[↑ Technical details](#)

```
{
  "code": 0,
  "message": "error:pkg/web/oauthclient:exchange (token exchange refused)",
  "details": {
    {
      "@type": "type.googleapis.com/ttn.lorawan.v3.ErrorDetails",
      "namespace": "pkg/web/oauthclient",
      "name": "exchange",
      "message_format": "token exchange refused",
      "correlation_id": "853ff836a8f84d578d6290ebdc658b4b",
      "cause": {
        "namespace": "pkg/errors",
        "name": "request",
        "message_format": "request to {url} failed",
        "attributes": {
          "op": "Post",
          "url": "http://dragino-9d65cd:8080/oauth/token"
        }
      }
    }
  }
}
```

 Copy to clipboard

This is caused by the inconsistency between the built-in TTN-Stack domain configuration and your login URL.

By default, ttn-stack uses the gateway's domain name for URL resolution, but in some networks, they prefer to resolve IP-v4 addresses.

So you can change the domain name of the TTN-Stack configuration to the IPv4 address.

Click the update URL button to configure the URL with the current eth port address.

Built-in Server

Type	Name	Status	URL	
LoRaWAN-Server	TTN-Stack	Running	http://10.130.2.22:8080/console	<input type="button" value="Update URL"/> <input type="button" value="Restart TTN"/>
Application-Server	Node-Red	Running	http://dragino-3e1a15:1880	<input type="button" value="Restart NodeRed"/>

9.2 The built-in TTN status is "Not Running" and the URI is "dragino-123456". How users fix this problem

When this problem occurs, click "Update To DEFAULT", this problem will be fixed.

Built-in Server

Type	Name	Status	URL	
LoRaWAN-Server	TTN-Stack	Not Running	http://dragino-123456:8080/console	<input type="button" value="Update To ETH"/> <input type="button" value="Update To WLAN"/> <input type="button" value="Update To DEFAULT"/> <input type="button" value="Restart THE TTN"/>
Application-Server	Node-Red	Running	http://dragino-2407bf:1880	<input type="button" value="Restart NodeRed"/>

9.3 Fallback IP does not work, how can users check

When the computer has completed the above fallback IP configuration, the LPS8v2 Web UI is still not accessible via fallback IP.

1. Check whether the configuration is correct

Run the CMD command to ipconfig and ping 172.31.255.254.

If this fails, the user needs to reconfigure.

```
Media State . . . . . : Media disconnected
Connection-specific DNS Suffix . :

Wireless LAN adapter 本地连接* 2:

Media State . . . . . : Media disconnected
Connection-specific DNS Suffix . :

Ethernet adapter Ethernet:

Connection-specific DNS Suffix . :
Link-local IPv6 Address . . . . . : fe80::7ce6:f39d:bfcc:5b71%5
IPv4 Address. . . . . : 172.31.255.253
Subnet Mask . . . . . : 255.255.255.252
Default Gateway . . . . . :

Wireless LAN adapter WLAN:

Connection-specific DNS Suffix . :
Link-local IPv6 Address . . . . . : fe80::d477:393b:a910:d30b%14
IPv4 Address. . . . . : 10.130.2.141
Subnet Mask . . . . . : 255.255.255.0
Default Gateway . . . . . : 10.130.2.1

Ethernet adapter Bluetooth Network Connection:

Media State . . . . . : Media disconnected
Connection-specific DNS Suffix . :

C:\Users\Administrator>ipconfig
```

```
C:\Users\Administrator>ping 172.31.255.254

Pinging 172.31.255.254 with 32 bytes of data:
Reply from 172.31.255.254: bytes=32 time=1ms TTL=64
Reply from 172.31.255.254: bytes=32 time<1ms TTL=64
Reply from 172.31.255.254: bytes=32 time<1ms TTL=64
Reply from 172.31.255.254: bytes=32 time<1ms TTL=64

Ping statistics for 172.31.255.254:
    Packets: Sent = 4, Received = 4, Lost = 0 (0% loss),
    Approximate round trip times in milli-seconds:
        Minimum = 0ms, Maximum = 1ms, Average = 0ms

C:\Users\Administrator>
```

2. Check whether the firewall is disabled

If the firewall is not down, this will affect access to the gateway.

9.4 Click "Manual_Update", why there is no response?

When you click "Manual_Update", the gateway will finish updating within 10 minutes and display the update log.

DRAGINO
LoRa ▾
LoRaWAN ▾
Network ▾
System ▾
LogRead ▾
Home
Logout

Package Management

General Settings

Enable update every boot
 Enable update every day midnight
 SAVE

Core Packages

Name	Current Version
dragino-httpd :	2023-04-07
dragino-ui :	2023-05-24
draginofwd :	2023-04-07
draginoups :	2023-05-24
dragino-fallback :	23.01.05
armbian-bsp-cli-draginohp0z :	23.02.16
linux-image-current-draginohp0z :	22.05.2

Manual_Update

Package Auto-Update Log

```

=====
2023-05-26 01:01
installed dragino-ui

WARNING: apt does not have a stable CLI interface. Use with caution in scripts.

Reading package lists...
Building dependency tree...
Reading state information...
The following packages will be upgraded:
  dragino-ui
1 upgraded, 0 newly installed, 0 to remove and 2 not upgraded.
Need to get 1,796 kB of archives.
After this operation, 0 B of additional disk space will be used.
Get:1 http://repo.dragino.com jammy/main armhf dragino-ui all 2023-05-24 [1,796 kB]
debconf: unable to initialize frontend: Dialog
  
```

9.5 Why the LPS8V2's Access Point does not do not appear & Fallback IP unable to access

Earlier versions of the LPS8V2 which missing the AP driver and not installed the fallback package, so the users have to do an extra update.

`apt update && apt install *dragino*`

`wget -P /tmp/ http://repo.dragino.com/release/hp0c-packages/linux-image-current-draginohp0z_22.05.2_armhf.deb && dpkg -i /tmp/linux-image-current-draginohp0z_22.05.2_armhf.deb`

9.6 How to reset the built-in server

1) Build-in The Things Network

Refer to this link to delete the Built-in server's device.

[Delete devices from Build-in The Things Network](#)

2) Build-in Chirpstack

Users need to click "Reset" on the Server-->NetServer interface, ChirpStack will be reset.

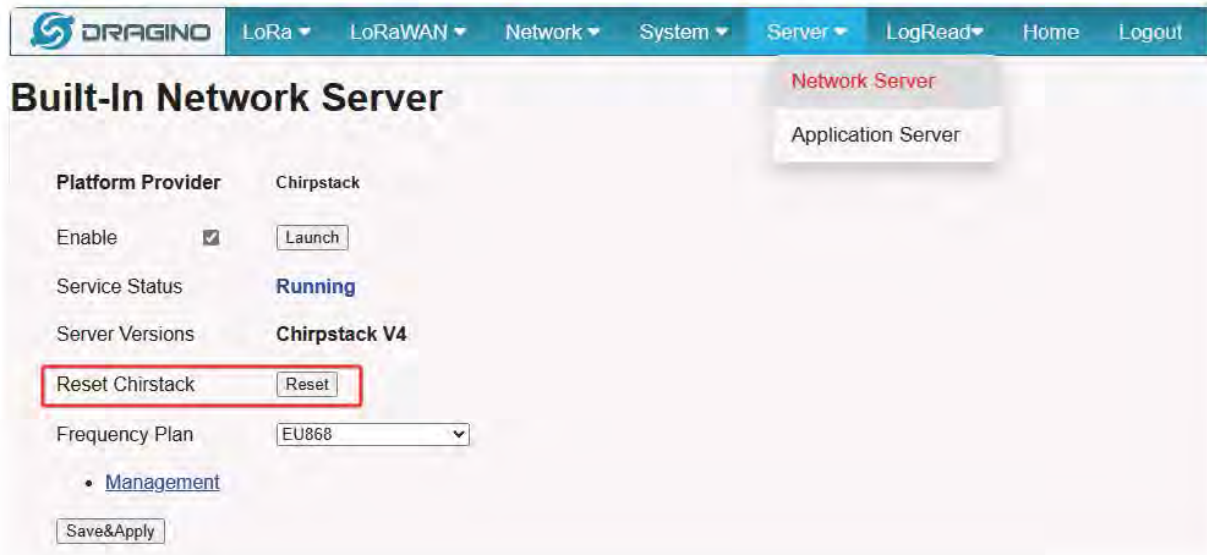

10. Supports

If you are experiencing issues and can't solve them, you can send mail to support@dragino.com.

With your question as detailed as possible. We will reply and help you in the shortest.

11. Reference

- Install Tago Core: Refer **Install Tago Core in LPS8v2** in [Instruction](#).
- [Advance OS Reference Guide for LPS8v2](#).

12. Order Info

LPS8v2-XXX-YYY

XXX: Frequency Band

- **AS923**: LoRaWAN AS923 band

- **AU915:** LoRaWAN AU915 band
- **EU868:** LoRaWAN EU868 band
- **KR920:** LoRaWAN KR920 band
- **US915:** LoRaWAN US915 band
- **IN865:** LoRaWAN IN865 band

YYY: 4G Cellular Option

- **EC25-E:** EMEA, Korea, Thailand, India
- **EC25-AFX:** America:Verizon, AT&T(FirstNet), U.S.Cellular; Canada:Telus
- **EC25-AUX:** Latin America, New Zeland, Taiwan
- **EC25-J:** Japan, DOCOMO, SoftBank, KDDI

More info about valid bands, please see [EC25-E product page](#).

13. Manufacturer Info

Shenzhen Dragino Technology Development co. LTD

Room 202, Block B, BCT Incubation Bases (BaoChengTai), No.8 CaiYunRoad

LongCheng Street, LongGang District ; Shenzhen 518116,China

14. FCC Warning

This equipment has been tested and found to comply with the limits for a Class B digital device, pursuant to Part 15 of the FCC Rules. These limits are designed to provide reasonable protection against harmful interference in a residential installation. This equipment generates uses and can radiate radio frequency energy and, if not installed and used in accordance with the instructions, may cause harmful interference to radio communications. However, there is no guarantee that interference will not occur in a particular installation. If this equipment does cause harmful interference to radio or television reception, which can be determined by turning the equipment off and on, the user is encouraged to try to correct the interference by one or more of the following measures:

- Reorient or relocate the receiving antenna.
- Increase the separation between the equipment and receiver.
- Connect the equipment into an outlet on a circuit different from that to which the receiver is connected.
- Consult the dealer or an experienced radio/TV technician for help.

Changes or modifications not expressly approved by the party responsible for compliance could void the user's authority to operate the equipment.

The antenna(s) used for this transmitter must be installed to provide a separation distance of at least 20 cm from all persons and must not be co-located or operating in conjunction with any other antenna or transmitter.

Contains FCC ID: ZHZR8601