



## LPS8 LoRaWAN Gateway User Manual

---

### Document Version: 1.1

Firmware Version: LG02\_LG08--build-v5.3.1581838658-20200216-1539

Version	Description	Date
1.0	Release	2019-Aug-10
1.0.1	Add trouble shooting for wifi AP not access issue	2019-Sep-23
1.0.2	Change the HTTP Port and SSH port for firmware version > v5.3	2019-Oct-26
1.1.0	Add more features such packet filter, remote access	2020-Mar-02
1.1.1	Polish network access description to make it clear	2020-Mar-16

## Table of Contents

<b>1</b>	<b>Introduction</b> .....	<b>4</b>
1.1	<i>What is the LPS8</i> .....	4
1.2	<i>Specifications</i> .....	5
1.3	<i>Features</i> .....	5
1.4	<i>Hardware System Structure</i> .....	6
1.5	<i>LPS8 Applications</i> .....	7
<b>2</b>	<b>Access and Configure LPS8</b> .....	<b>8</b>
2.1	<i>Connect via WiFi</i> .....	8
2.2	<i>Connect via Ethernet</i> .....	8
2.3	<i>Access Configure Web UI</i> .....	8
<b>3</b>	<b>Typical Network Setup</b> .....	<b>10</b>
3.1	<i>Overview</i> .....	10
3.2	<i>Use WAN port to access Internet</i> .....	10
3.3	<i>Access the Internet as a WiFi Client</i> .....	11
3.4	<i>Check Internet connection</i> .....	12
<b>4</b>	<b>Example: Configure as a LoRaWAN gateway</b> .....	<b>13</b>
4.1	<i>Create a gateway in TTN Server</i> .....	14
4.2	<i>Configure LPS8 to connect to TTN</i> .....	16
4.3	<i>Configure frequency</i> .....	17
4.4	<i>Add a LoRaWAN End Device</i> .....	18
<b>5</b>	<b>More features</b> .....	<b>20</b>
5.1	<i>Packet Filtering</i> .....	20
5.2	<i>Remote Access</i> .....	20
5.3	<i>More instructions</i> .....	20
<b>6</b>	<b>Linux System</b> .....	<b>21</b>
6.1	<i>SSH Access for Linux console</i> .....	21
6.2	<i>Edit and Transfer files</i> .....	22

---

6.3	File System.....	22
6.4	Package maintenance system .....	23
<b>7</b>	<b>Upgrade Linux Firmware .....</b>	<b>24</b>
7.1	Upgrade via Web UI .....	24
7.2	Upgrade via Linux console.....	24
<b>8</b>	<b>FAQ.....</b>	<b>26</b>
8.1	How can I configure for a customized frequency band?.....	26
8.2	Can I make my own firmware for LPS8? Where can I find the source code of LPS8? .....	31
8.3	Can I use 868Mhz version for 915Mhz bands?.....	31
<b>9</b>	<b>Trouble Shooting.....</b>	<b>32</b>
9.1	I get kernel error when install new package, how to fix? .....	32
9.2	How to recover the LPS8 if the firmware crashes.....	33
9.3	I configured LPS8 for WiFi access and lost its IP. What to do now?.....	34
9.4	I connect to the LPS8's SSID but LPS8 didn't assign DHCP IP to my laptop? .....	34
<b>10</b>	<b>Order Info .....</b>	<b>35</b>
<b>11</b>	<b>Packing Info .....</b>	<b>36</b>
<b>12</b>	<b>Support.....</b>	<b>36</b>
<b>13</b>	<b>Reference.....</b>	<b>36</b>
<b>14</b>	<b>FCC Warning .....</b>	<b>37</b>

# 1 Introduction

## 1.1 What is the LPS8

The LPS8 is an **open source** LoRaWAN Gateway. It lets you bridge LoRa wireless network to an IP network via **WiFi, Ethernet**. The LoRa wireless allows users to send data and reach extremely long ranges at low data-rates.

The LPS8 uses **Semtech packet forwarder** and fully compatible with LoRaWAN protocol. It includes a **SX1308 LoRa concentrator**, which provides 10 programmable parallel demodulation paths.

LPS8 has **pre-configured standard LoRaWAN frequency bands** to use for different countries. User can also **customize the frequency bands** to use in their own LoRa network.

### LPS8 In a LoRaWAN IoT Network:

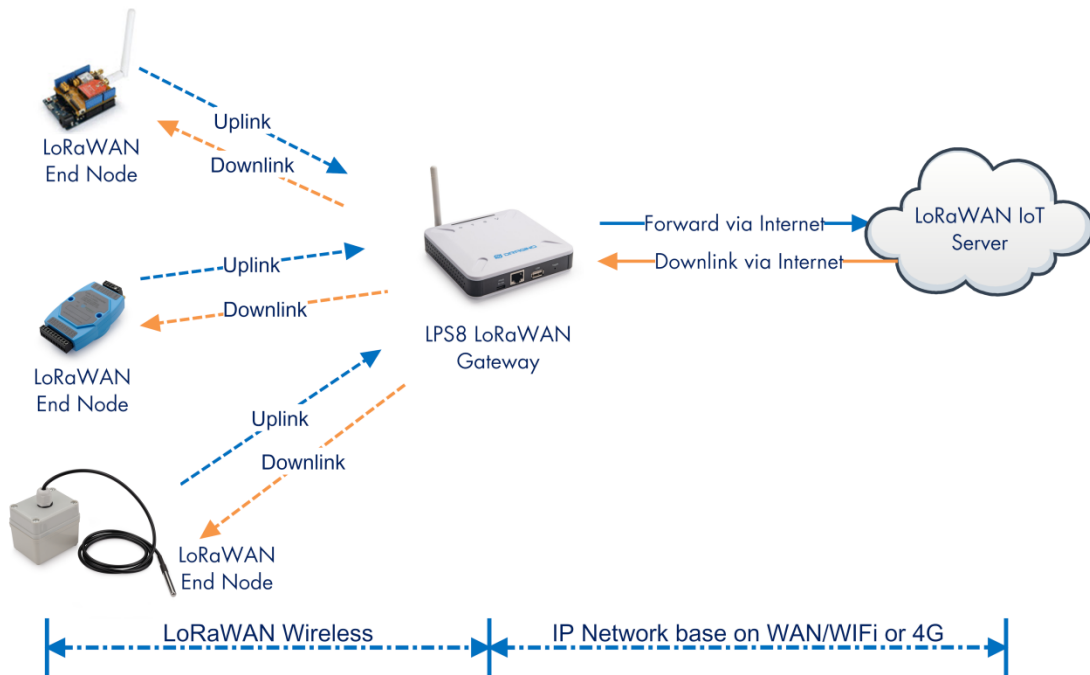

## 1.2 Specifications

### Hardware System:

#### Linux Part:

- 400Mhz ar9331 processor
- 64MB RAM
- 16MB Flash

### Interface:

- 10M/100M RJ45 Ports x 1
- WiFi : 802.11 b/g/n
- LoRaWAN Wireless
- Power Input: 5V DC, 2A
- USB 2.0 host connector x 1

### WiFi Spec:

- IEEE 802.11 b/g/n
- Frequency Band: 2.4 ~ 2.462GHz
- Tx power:
  - ✓ 11n tx power : mcs7/15: 11db mcs0 : 17db
  - ✓ 11b tx power: 18db
  - ✓ 11g 54M tx power: 12db
  - ✓ 11g 6M tx power: 18db
- Wifi Sensitivity
  - ✓ 11g 54M : -71dbm
  - ✓ 11n 20M : -67dbm

### LoRa Spec:

- Up to -140 dBm sensitivity with SX1257 Tx/Rx front-end
- 70 dB CW interferer rejection at 1 MHz offset
- Able to operate with negative SNR, CCR up to 9dB
- Emulates 49 x LoRa demodulators and 1 x (G)FSK demodulator
- Dual digital TX & RX radio front-end interfaces
- 10 programmable parallel demodulation paths
- Dynamic data-rate (DDR) adaptation
- True antenna diversity or simultaneous dual-band operation

## 1.3 Features

- ✓ Open Source OpenWrt system
- ✓ Managed by Web GUI, SSH via WAN or WiFi

- ✓ Emulates 49x LoRa demodulators
- ✓ LoRaWAN Gateway
- ✓ 10 programmable parallel demodulation paths

### 1.4 Hardware System Structure

#### LPS8 System Overview:

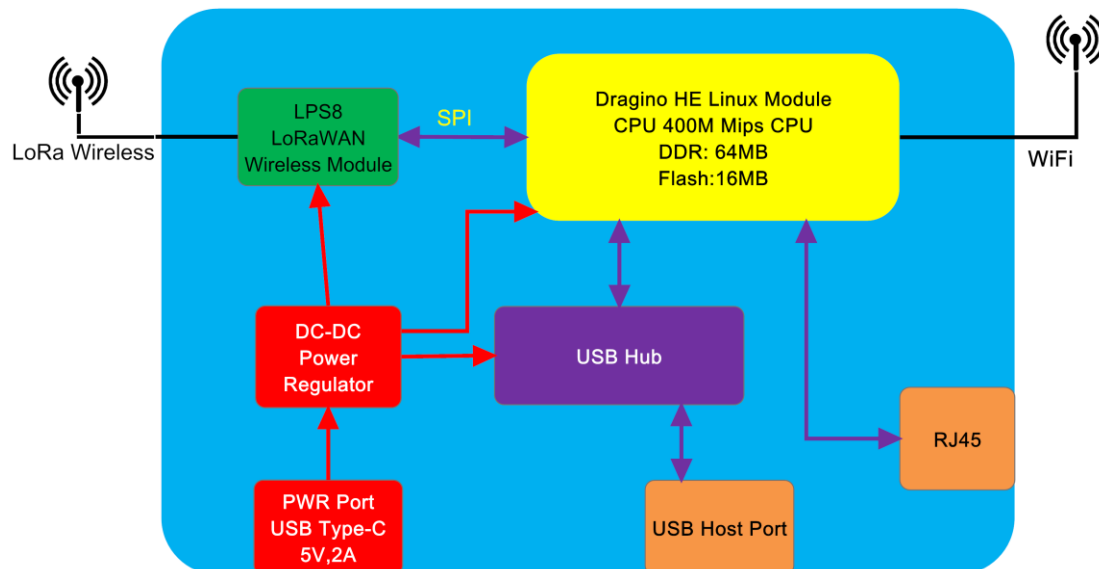

## 1.5 LPS8 Applications



## 2 Access and Configure LPS8

The LPS8 is configured as a WiFi Access Point by factory default. You can access and configure the LPS8 after connecting to its WiFi network, or via its WAN Ethernet port.

### 2.1 Connect via WiFi

At the first boot of LPS8, it will auto generate a WiFi network called **dragino-xxxxxx**

**Note:** In latest version firmware, it has been password protected and the password is:

**dragino+dragino**

You can use a PC to connect to this WiFi network. The PC will get an IP address 10.130.1.xxx and the LPS8 has the default IP **10.130.1.1**



**Note:** If device has been configured to work in WiFi Client Mode, the WiFi AP mode will be disable and user can't see the dragino wifi SSID.

### 2.2 Connect via Ethernet

Alternatively, you can connect your PC to the LPS8 WAN port via Ethernet cable and obtain an IP address via DHCP. User can see this ip address from uplink router.

The WAN port also has a [fall back ip address](#) for access if user doesn't connect to uplink router.

### 2.3 Access Configure Web UI

#### Web Interface

Open a browser on the PC and type in the LPS8 ip address (depends on your connect method)

<http://10.130.1.1/> (Access via WiFi AP network)

or

[http://IP\\_ADDRESS](http://IP_ADDRESS) or [http://IP\\_ADDRESS:8000](http://IP_ADDRESS:8000) (The web port has been changed to 8000 in **WAN interface**(WAN port or WiFi Client Mode) since firmware 5.3.xxx firmware)

You will see the login interface of LPS8 as shown below.

The account details for Web Login are:

**User Name:** root

**Password:** dragino



dragino-168cb0 - LuCI x

10.130.1.1/cgi-bin/luci/admin

dragino-168cb0

## Authorization Required

Please enter your username and password.

Username

Password

DRAGINO TECHNOLOGY CO., LIMITED

### 3 Typical Network Setup

#### 3.1 Overview

The LPS8 supports flexible network set up for different environments. This section describes the typical network topology can be set in LPS8. The network set up includes:

- ✓ **WAN Port Internet Mode**
- ✓ **WiFi Client Mode**
- ✓ **WiFi AP Mode**

#### 3.2 Use WAN port to access Internet

By default, the LPS8 is set to use the WAN port to connect to an upstream network. When you connect the LPS8’s WAN port to an upstream router, the LPS8 will get an IP address from the router and have Internet access via the upstream router. The network status can be checked as below:

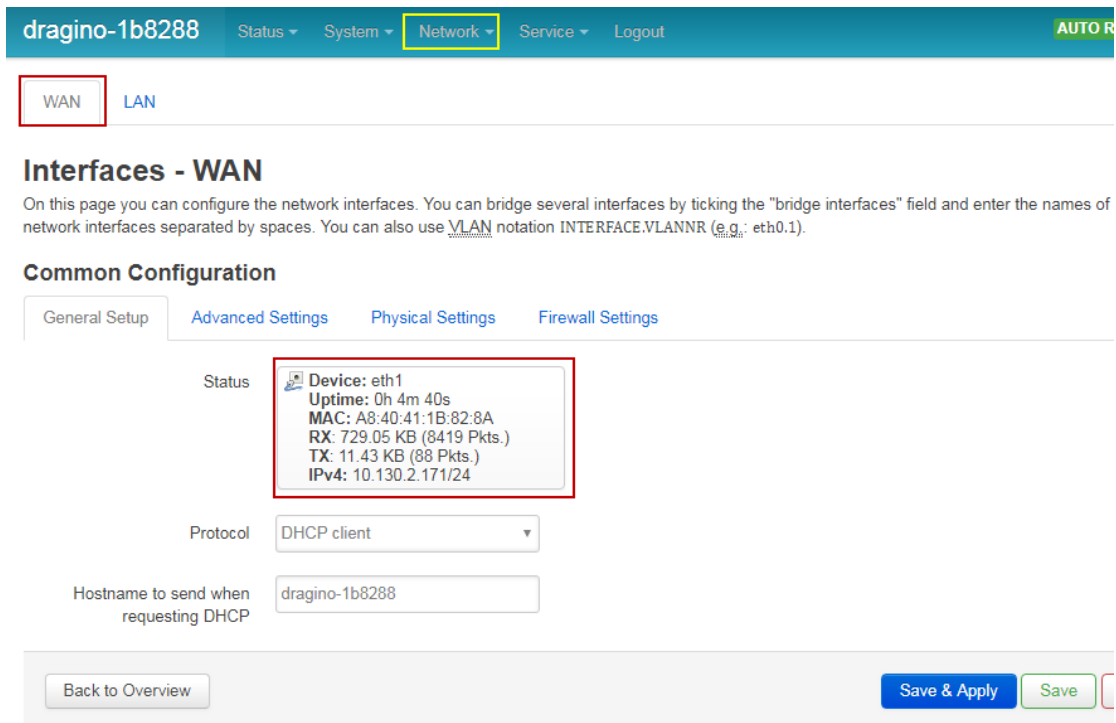

The screenshot shows the web interface for a device named 'dragino-1b8288'. The 'Network' menu is selected. Under 'Network', the 'WAN' tab is active. The page title is 'Interfaces - WAN'. Below the title, there is a note: 'On this page you can configure the network interfaces. You can bridge several interfaces by ticking the "bridge interfaces" field and enter the names of network interfaces separated by spaces. You can also use VLAN notation INTERFACE.VLANNR (e.g.: eth0.1)'. Under 'Common Configuration', there are four tabs: 'General Setup', 'Advanced Settings', 'Physical Settings', and 'Firewall Settings'. The 'Advanced Settings' tab is selected. It shows the 'Status' of the device: 'Device: eth1', 'Uptime: 0h 4m 40s', 'MAC: A8:40:41:1B:82:8A', 'RX: 729.05 KB (8419 Pkts.)', 'TX: 11.43 KB (88 Pkts.)', and 'IPv4: 10.130.2.171/24'. The 'Protocol' is set to 'DHCP client'. The 'Hostname to send when requesting DHCP' is 'dragino-1b8288'. At the bottom, there are buttons for 'Back to Overview', 'Save & Apply', and 'Save'.

### 3.3 Access the Internet as a WiFi Client.

In the WiFi Client Mode, the LPS8 acts as a WiFi client and gets DHCP from an upstream router via WiFi.

The steps to set up as a WiFi Client are as below:

#### Step1:

In Network -> Wireless, select Radio0 interface and scan.

dragino-1b8288 Status System **Network** Service Logout AUTO REFRESH ON

radio0: Master "dragino-1b8288"

#### Wireless Overview

radio0	<b>Generic MAC80211 802.11bgn</b> Channel: 11 (2.462 GHz)   Bitrate: ? Mbit/s	Restart	<b>Scan</b>	Add
0%	SSID: dragino-1b8288   Mode: Master BSSID: A8:40:41:1B:82:88   Encryption: None	Disable	Edit	Remove

#### Step2:

Select the Wireless AP and join:

dragino-1b8288 Status System Network Service Logout AUTO REFRESH ON

#### Join Network: Wireless Scan

Signal	SSID	Channel	Mode	BSSID	Encryption	
100%	dragino-office	8	Master	50:64:2B:1A:B8:4D	mixed WPA/WPA2 - PSK	<b>Join Network</b>
84%	ChinaNet-gLnb	2	Master	A4:29:40:66:F4:E7	mixed WPA/WPA2 - PSK	Join Network

dragino-1b8288 Status System Network Service Logout

#### Joining Network: "dragino-office"

Replace wireless configuration

Check this option to delete the existing networks from this radio.

WPA passphrase:  \*

Specify the secret encryption key here.

Name of the new network:

The allowed characters are: a-z, A-Z, 0-9 and \_

Create / Assign firewall-zone:

Choose the firewall zone you want to assign to this interface. Select *unspecified* to remove the interface from the associated zone or fill out the *create* field to define a new zone and attach the interface to it.

### Step3:

In the Network->Wireless page, disable WiFi AP network. This step is important, the LPS WiFi interface can only WiFi AP or WiFi Client mode at a time.

**Note:** After doing that, you will lose connection if your PC connects to the LPS8 via LPS8's WiFi network.

After successful association, the WiFi network interface can be seen in the same page:

The screenshot shows the network configuration page for 'dragino-1b8288'. It features a top navigation bar with 'Status', 'System', 'Network', 'Service', and 'Logout' menus, and an 'AUTO REFRESH ON' indicator. Below the navigation, there are tabs for 'WAN', 'WWAN', and 'LAN'. The main section is titled 'Interfaces' and lists three interfaces:

- LAN (br-lan):** Protocol: Static address, Uptime: 2h 0m 4s, MAC: A8:40:41:1B:82:8B, RX: 1.40 MB (13346 Pkts.), TX: 2.79 MB (10321 Pkts.), IPv4: 10.130.1.1/24. Buttons: Restart, Stop, Edit, Delete.
- WAN (eth1):** Protocol: DHCP client, MAC: A8:40:41:1B:82:8A, RX: 4.30 MB (51840 Pkts.), TX: 55.77 KB (429 Pkts.). Buttons: Restart, Stop, Edit, Delete.
- WWAN (Client "dragino-office"):** Protocol: DHCP client, Uptime: 0h 6m 6s, MAC: A8:40:41:1B:82:88, RX: 549.38 KB (5659 Pkts.), TX: 14.90 KB (94 Pkts.), IPv4: 10.130.2.169/24. Buttons: Restart, Stop, Edit, Delete.

At the bottom, there is an 'Add new interface...' button and a 'Save & Apply' button.

### 3.4 Check Internet connection

You can use the diagnostics page to check and analyze the Internet connection as shown below.

The screenshot shows the 'Diagnostics' page for 'dragino-1b8288'. The 'Network Utilities' section includes input fields for 'openwrt.org' and buttons for 'Traceroute' and 'Nslookup'. Below these, there is a text area displaying the results of a ping test:

```

PING openwrt.org (139.59.209.225): 56 data bytes
64 bytes from 139.59.209.225: seq=0 ttl=45 time=386.898 ms
64 bytes from 139.59.209.225: seq=1 ttl=45 time=401.656 ms
64 bytes from 139.59.209.225: seq=2 ttl=45 time=387.708 ms
64 bytes from 139.59.209.225: seq=3 ttl=45 time=378.894 ms
64 bytes from 139.59.209.225: seq=4 ttl=45 time=384.156 ms

--- openwrt.org ping statistics ---
5 packets transmitted, 5 packets received, 0% packet loss
round-trip min/avg/max = 378.894/387.862/401.656 ms
    
```

## 4 Example: Configure as a LoRaWAN gateway

LPS8 is fully compatible with LoRaWAN protocol. It uses the legacy Semtech Packet forwarder to forward the LoRaWAN packets to server. The structure is as below.

### LPS8 In a LoRaWAN IoT Network:

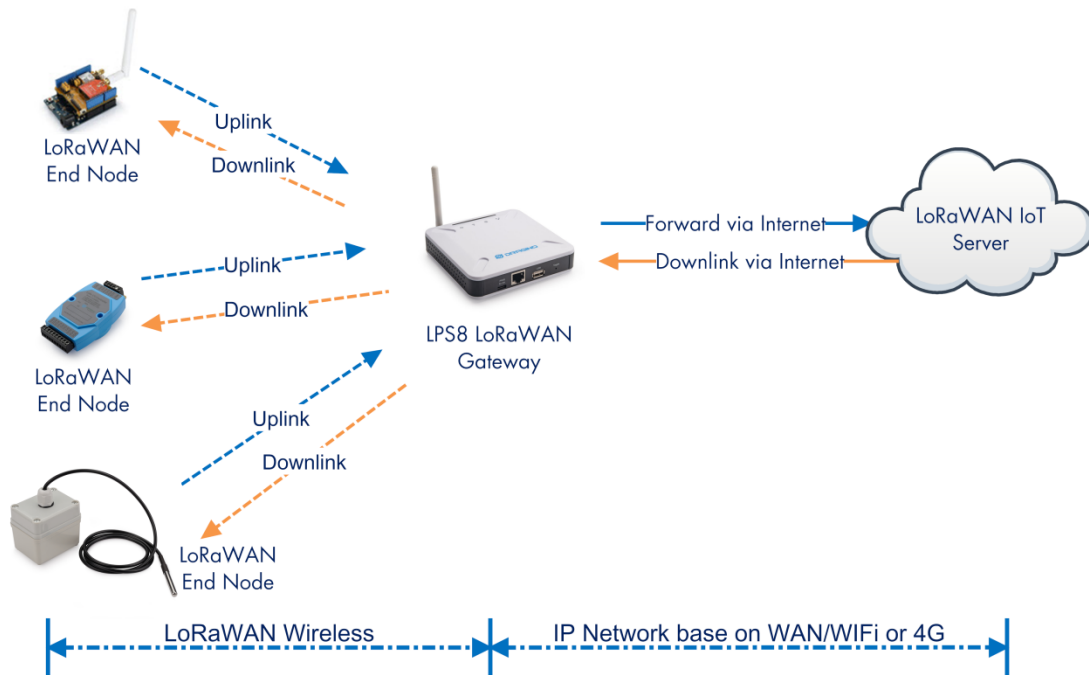

This chapter describes how to use the LPS8 to work with

[TheThingsNetwork \(TTN\) LoRaWAN Server](http://www.thethingsnetwork.org) ([www.thethingsnetwork.org](http://www.thethingsnetwork.org))

## 4.1 Create a gateway in TTN Server

### Step 1: Get a Unique gateway ID.

Every LPS8 has a unique gateway id. The ID can be found at LoRaWAN page:

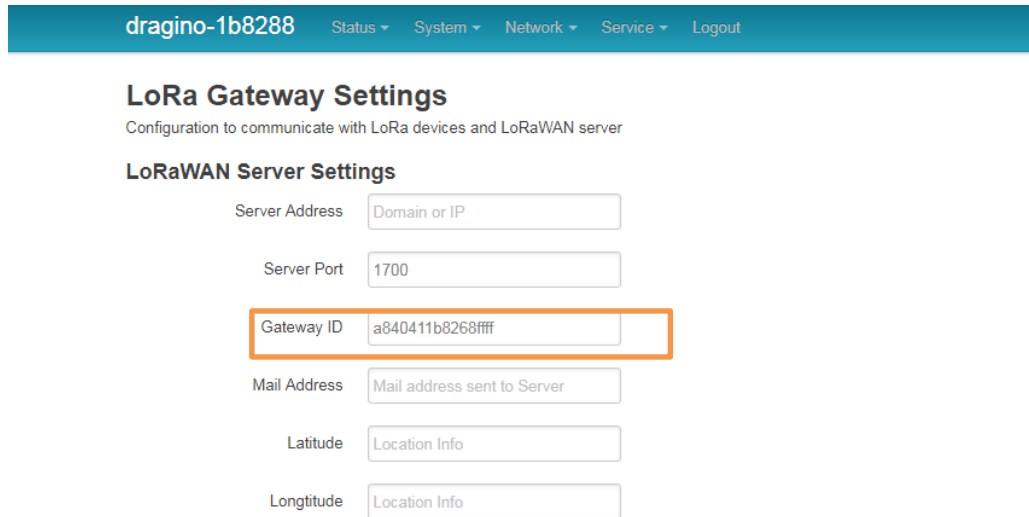

dragino-1b8288 Status System Network Service Logout

### LoRa Gateway Settings

Configuration to communicate with LoRa devices and LoRaWAN server

#### LoRaWAN Server Settings

Server Address	Domain or IP
Server Port	1700
Gateway ID	a840411b8268ffff
Mail Address	Mail address sent to Server
Latitude	Location Info
Longitude	Location Info

The example gateway id is: **a840411b8268ffff**

### Step 2: Sign up a user account in TTN server

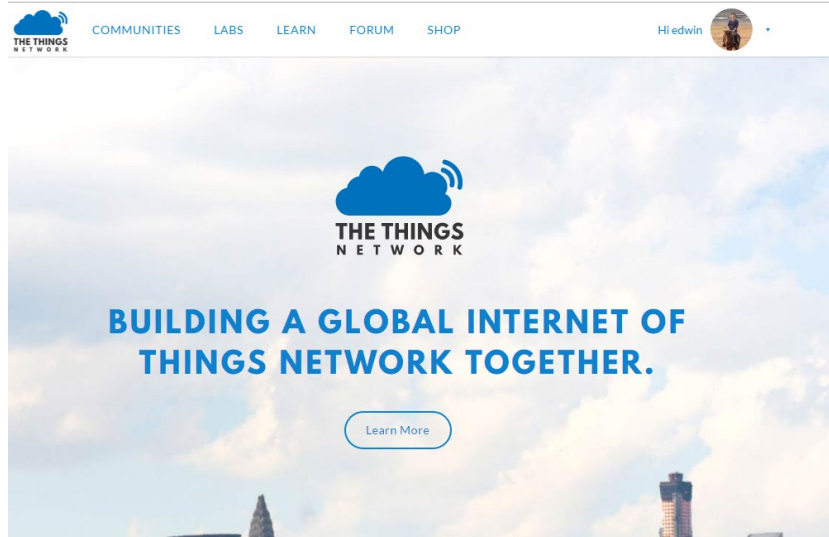

### Step 3: Create a Gateway

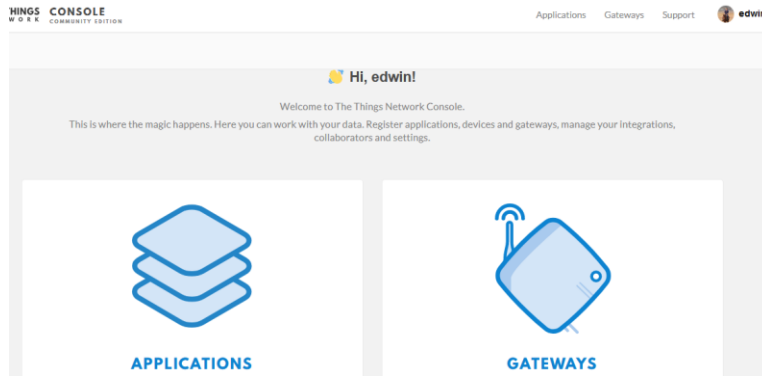

Click on the Gateways icon to open the page below:

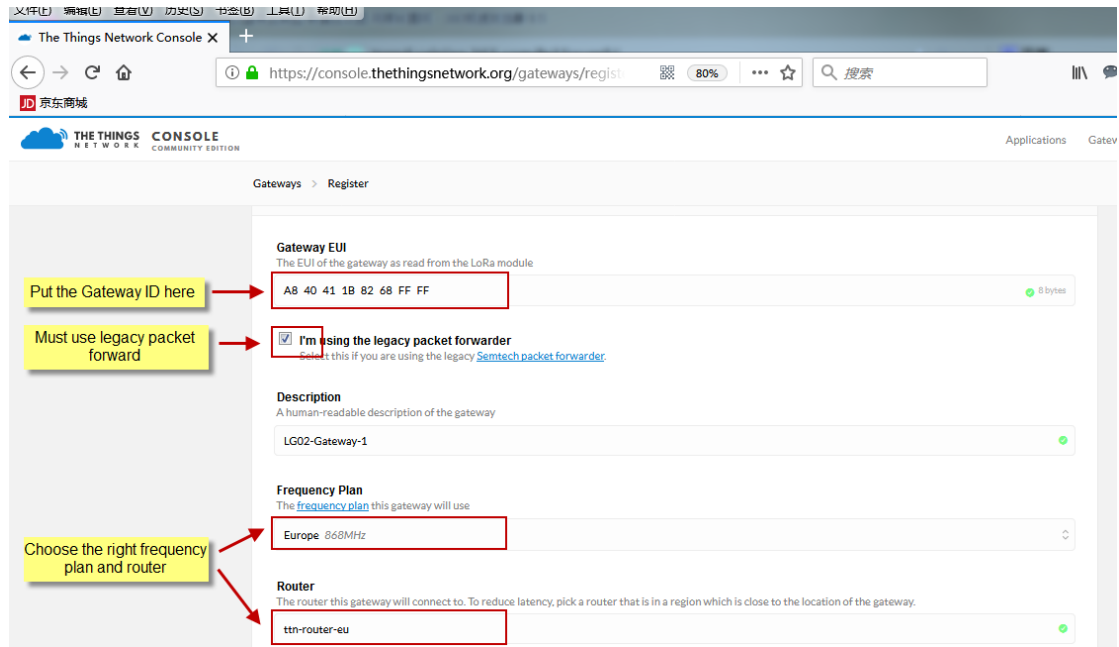

After creating the gateway, you can see the gateway info, as below.

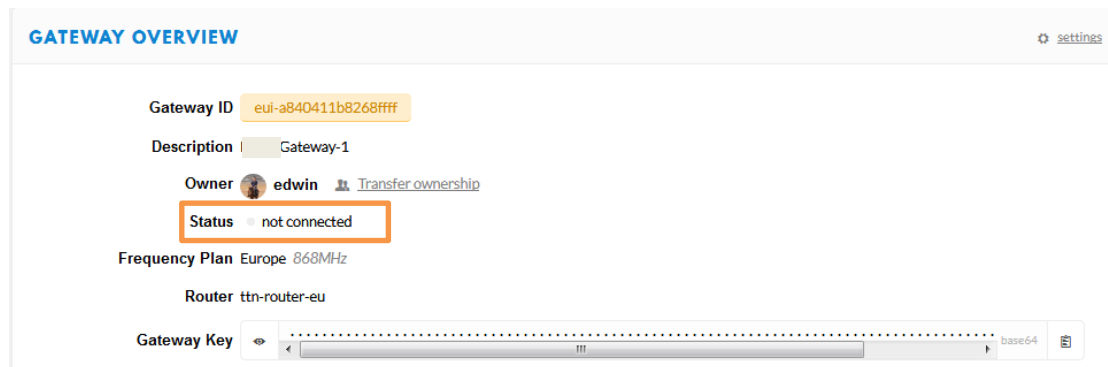

## 4.2 Configure LPS8 to connect to TTN

You can now configure the LPS8 to let it connect to TTN network.  
Make sure your LPS8 has a working Internet Connection first.

### Step1: Configure LPS8 to act as raw forwarder

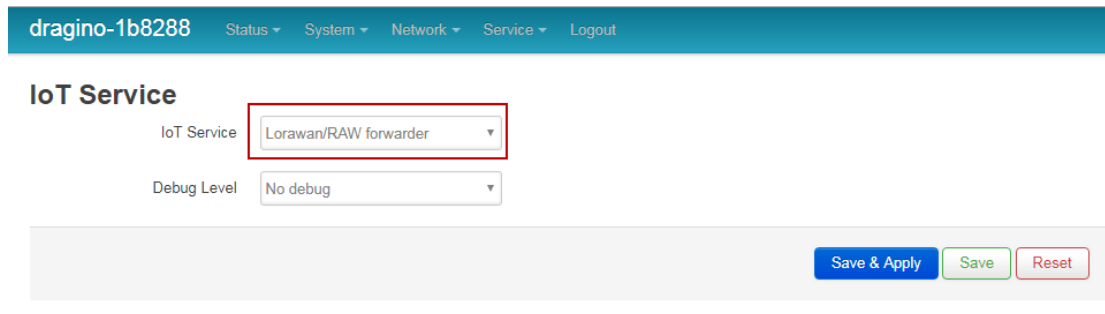

The screenshot shows the 'IoT Service' configuration page. At the top, there is a navigation bar with 'dragino-1b8288', 'Status', 'System', 'Network', 'Service', and 'Logout'. The main content area has a title 'IoT Service'. Below the title, there are two dropdown menus: 'IoT Service' set to 'Lorawan/RAW forwarder' and 'Debug Level' set to 'No debug'. At the bottom right, there are three buttons: 'Save & Apply' (blue), 'Save' (green), and 'Reset' (red).

DRAGINO TECHNOLOGY CO., LIMITED

### Step2: Input server info and gateway id

Choose the correct the server address and gateway ID.



The screenshot shows the 'LoRa Gateway Settings' page. At the top, there is a navigation bar with 'dragino-1b8288', 'Status', 'System', 'Network', 'Service', and 'Logout'. The main content area has a title 'LoRa Gateway Settings' and a subtitle 'Configuration to communicate with LoRa devices and LoRaWAN server'. Below the subtitle, there is a section 'LoRaWAN Server Settings' with several input fields: 'Service Provider' (dropdown, 'The Things Network'), 'Server Address' (dropdown, 'ttn-router-eu'), 'Server Port' (text input, '1700'), 'Gateway ID' (text input, 'a840411b8268ffff'), 'Mail Address' (text input, 'edwin@dragino.com'), 'Latitude' (text input, '22.73'), and 'Longitude' (text input, '114.23').



### Check Result

After making the above settings, the LPS8 should be able to connect to TTN. Below is the result seen from TTN:

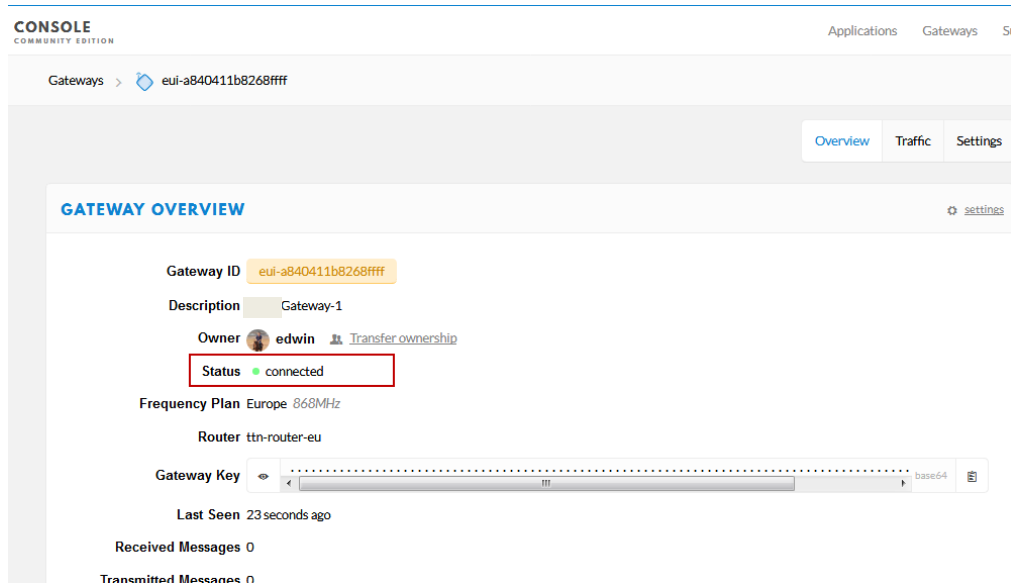

### 4.3 Configure frequency

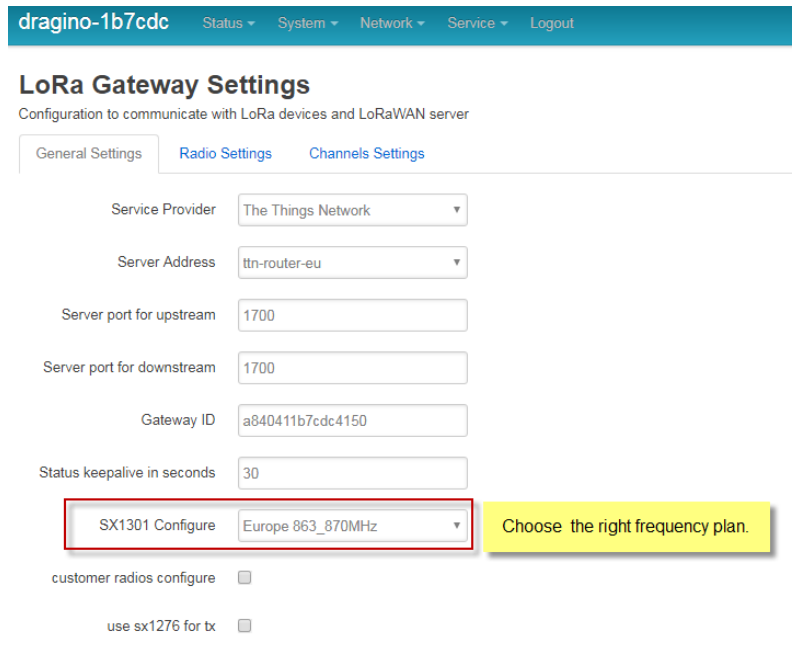

After making the settings above, the LPS8 will be able to act as a LoRaWAN gateway.

## 4.4 Add a LoRaWAN End Device

This section shows how to add a LoRaWAN End device to a LoRaWAN network and see the data from TTN web site.

We use LT-33222-L IO Controller as a reference device - the setup for other LoRaWAN devices will be similar.



**Step 1:** Create a Device definition in TTN with the OTAA keys from the example LT-33222-L IO Controller device.

Three codes are required to define the device in TTN:

- ✓ DEV EUI - Unique ID code for a particular device.
- ✓ APP EUI - ID code for an Application defined in TTN.
- ✓ APP Key - Unique key to secure communications with a particular device.

A set of these codes are stored in each device by the manufacturer as the default codes for that particular device. Each device is shipped with a sticker with the default Device EUI as shown below.



Note: You may be able to change these codes in a device by using a configuration facility on the device e.g. the LT-33222 uses a serial port access and a series of AT commands. Changing the codes may be necessary in the case where you have to use codes assigned by a LoRa WAN server.

For the TTN server, you can use the codes set in the device as in the following example.

Select **Add Application** to open the screen below.

Note that there is an APP EUI already created by TTN, but this is not the one set in the device. To add the APP EUI for the LT33222 device, select **Manage EUIs** and **Add EUI**, then enter the required code.

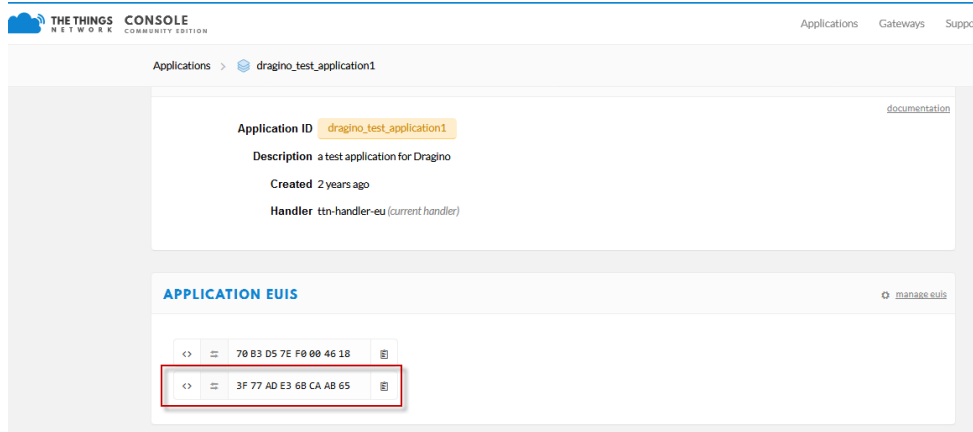

Select **Devices** and **Register Device** to open the screen below.

Enter the **Device EUI** and **APP KEY** codes, then select the App EUI from the list. Check that all three codes match those shown on the device label before saving the configuration.

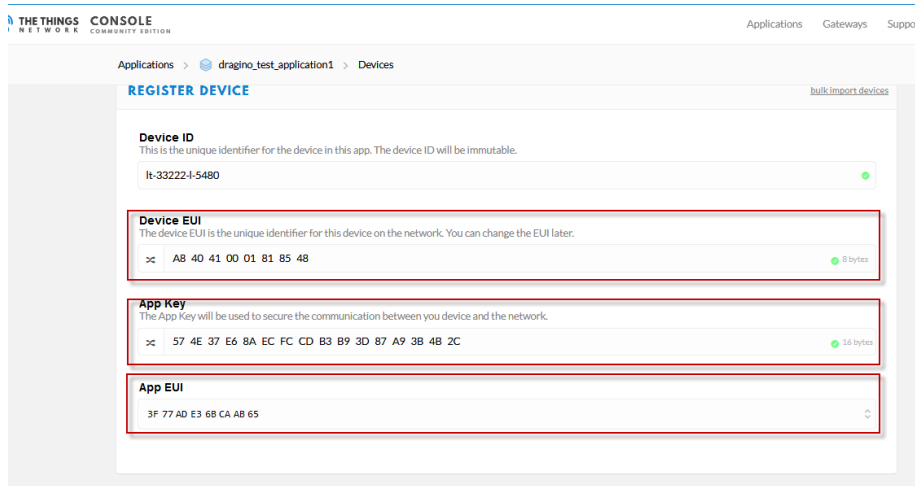

**Step 2:** Power on LT-33222 device and it will automatically join the TTN network. After joining successfully, it will start to upload messages to the TTN. Select the Data tab and you will see the data appearing in the panel.

Note that it may take some time for the device data to appear in the TTN display.

ONSOLE  
COMMUNITY EDITION

Applications Gateways St

Applications > dragino\_test\_application1 > Devices > It-33222-I-5362 > Data

Overview Data Settings

**APPLICATION DATA** || pause clear

Filters: uplink downlink activation ack error

time	counter	port		payload
16:54:53	0	2	retry	00 02 01 36 04 C1 04 C2 38
16:54:47			dev addr: 26 01 2C 6B app eui: FCDEC9B2D32FA6 61 dev eui: A8 40 41 00	
16:54:40			dev addr: 26 01 2C 85 app eui: FCDEC9B2D32FA6 61 dev eui: A8 40 41 00	
16:54:33			dev addr: 26 01 2E EC app eui: FCDEC9B2D32FA6 61 dev eui: A8 40 41 00	

## 5 More features

### 5.1 Packet Filtering

Drop unwanted packets:

See [http://wiki.dragino.com/index.php?title=Main\\_Page#Filter\\_unwanted\\_LoRaWAN\\_packets](http://wiki.dragino.com/index.php?title=Main_Page#Filter_unwanted_LoRaWAN_packets)

### 5.2 Remote Access

Remote Access Devices for management:

See

[http://wiki.dragino.com/index.php?title=Main\\_Page#Remote\\_Access\\_Gateway\\_via\\_Reverse\\_SSH](http://wiki.dragino.com/index.php?title=Main_Page#Remote_Access_Gateway_via_Reverse_SSH)

### 5.3 More instructions

[http://wiki.dragino.com/index.php?title=Main\\_Page#LoRa.2FLoRaWAN\\_Gateway\\_Instruction](http://wiki.dragino.com/index.php?title=Main_Page#LoRa.2FLoRaWAN_Gateway_Instruction)

## 6 Linux System

The LPS8 is based on the OpenWrt Linux system. It is open source, and users are free to configure and modify the Linux settings.

### 6.1 SSH Access for Linux console

You can access the Linux console via the SSH protocol. Make sure your PC and the LPS8 are connected to the same network, then use a SSH tool (such as [putty](#) in Windows) to access it.

IP address: IP address of LPS8

Port: 22 or 2222 (SSH port in WAN interface has been change to 2222 since firmware 5.3.xx, for security reason)

User Name: **root**

Password: **dragino** (default)

After logging in, you will be in the Linux console and can enter commands as shown below.

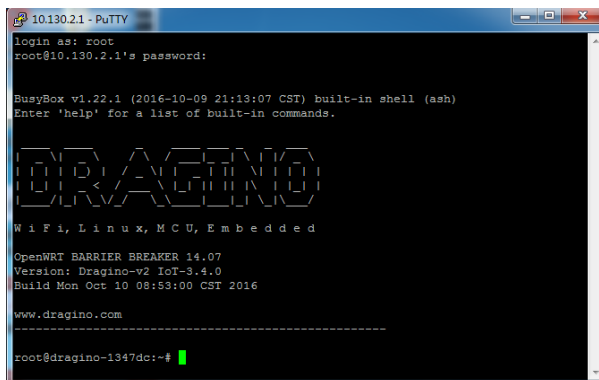

```
10.130.2.1 - PuTTY
login as: root
root@10.130.2.1's password:

BusyBox v1.22.1 (2016-10-09 21:13:07 CST) built-in shell (ash)
Enter 'help' for a list of built-in commands.

DRAGINO
W i F i , L i n u x , M C U , E m b e d d e d
OpenWRT BARRIER BREAKER 14.07
Version: Dragino-v2 IoT-3.4.0
Build Mon Oct 10 08:53:00 CST 2016
www.dragino.com
-----
root@dragino-13d7dc:~#
```

## 6.2 Edit and Transfer files

The LPS8 supports the **SCP protocol** and has a built-in **SFTP server**. There are many ways to edit and transfer files using these protocols.

In Windows, one of the easiest methods is using the [WinSCP](#) utility.

After establishing access via WinSCP to the device, you can use an FTP style window to drag / drop files to the LPS8, or edit the files directly in the windows.

Screenshot is as below:

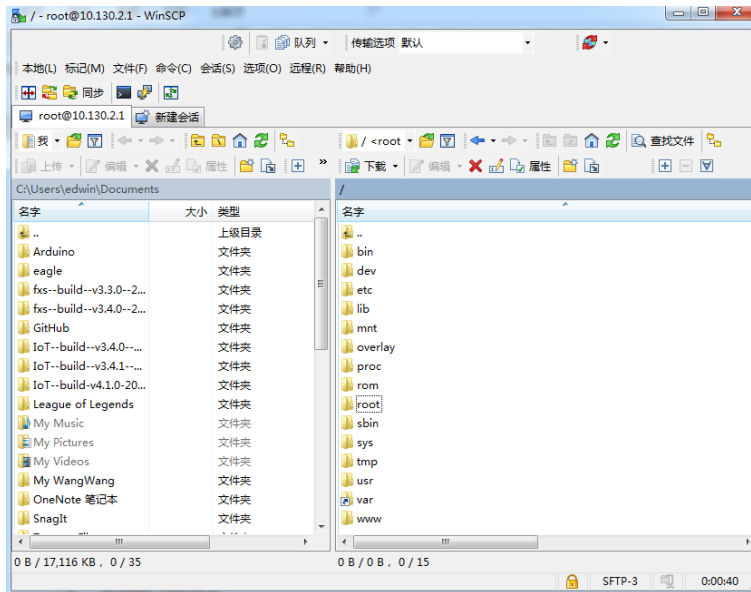

## 6.3 File System

The LPS8 has a 16MB flash and a 64MB RAM. The `/var` and `/tmp` directories are in the RAM, so contents stored in `/tmp` and `/var` will be erased after rebooting the device. Other directories are in the flash and will remain after reboot.

The Linux system uses around 8MB ~10MB flash size which means there is not much room for user to store data in the LPS8 flash.

You can use an external USB flash memory device to extend the size of flash memory for storage.

## 6.4 Package maintenance system

LPS8 uses the OpenWrt [OPKG package maintenance system](#). There are more than 3000+ packages available in our package server for users to install for their applications. For example, if you want to add the *iperf* tool, you can install the related packages and configure LPS8 to use *iperf*.

Below are some example *opkg* commands. For more information please refer to the [OPKG package maintain system](#) (<https://wiki.openwrt.org/doc/techref/opkg>)

In Linux Console run:

```
root@dragino-169d30:~# opkg update // to get the latest packages list
```

```
root@dragino-169d30:~# opkg list //shows the available packages
```

```
root@dragino-169d30:~# opkg install iperf // install iperf
```

The system will automatically install the required packages as shown below.

```
root@dragino-169d30:/etc/opkg# opkg install iperf
```

```
Installing iperf (2.0.12-1) to root...
```

```
Downloading http://downloads.openwrt.org/snapshots/packages/mips\_24kc/base/iperf\_2.0.12-1\_mips\_24kc.ipk
```

```
Installing uclibcxx (0.2.4-3) to root...
```

```
Downloading http://downloads.openwrt.org/snapshots/packages/mips\_24kc/base/uclibcxx\_0.2.4-3\_mips\_24kc.ipk
```

```
Configuring uclibcxx.
```

```
Configuring iperf.
```

## 7 Upgrade Linux Firmware

We keep improving the LPS8 Linux side firmware for new features and bug fixes.

The latest firmware can be found on [LoRa Gateway Firmware](#),

( [http://www.dragino.com/downloads/index.php?dir=LoRa\\_Gateway/LG02-OLG02/Firmware](http://www.dragino.com/downloads/index.php?dir=LoRa_Gateway/LG02-OLG02/Firmware) )

The Change Log can be found here: [Firmware Change Log](#).

( [http://www.dragino.com/downloads/downloads/LoRa\\_Gateway/LG02-OLG02/Firmware/ChangeLog](http://www.dragino.com/downloads/downloads/LoRa_Gateway/LG02-OLG02/Firmware/ChangeLog) )

The file named as **xxxxx-xxxxx-squashfs-sysupgrade.bin** is the upgrade Image. There are different methods to upgrade, as below.

### 7.1 Upgrade via Web UI

Go to the page: **Web → System → Back Up and flash firmware**

Select the required image and click **Flash Image**. The image will be uploaded to the device, and then click **Process Update** to upgrade.

**NOTE:** You normally need to **uncheck** the **Keep Settings** checkbox when doing an upgrade to ensure that there is no conflict between the old settings and the new firmware. The new firmware will start up with its default settings.

The system will automatically boot into the new firmware after upgrade.

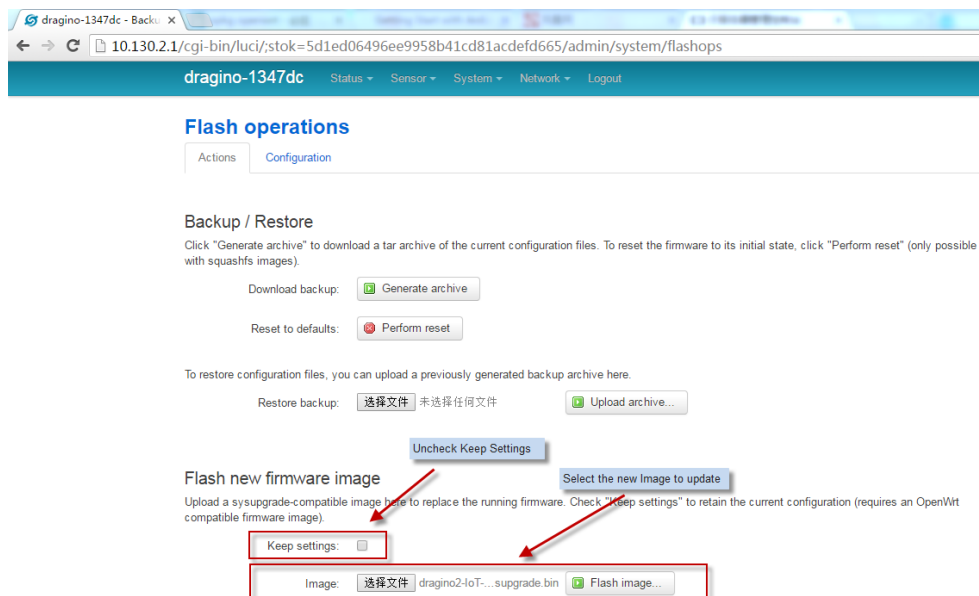

### 7.2 Upgrade via Linux console



---

SCP the firmware to the system **/var** directory and then run

```
root@OpenWrt:~# /sbin/sysupgrade -n /var/Your_Image
```

**NOTE:** it is important to transfer the image in the /var directory, otherwise it may exceed the available flash size.

## 8 FAQ

### 8.1 How can I configure for a customized frequency band?

You can customize your LoRaWAN channel on LPS8. For example if you want to set the gateway to meet the India LoRoIT frequency band:

LoRoit Frequency plan for India

Channel	Frequency	Modulation / BW	
0	865.400 MHz	MultiSF	125 kHz
1	865.600 MHz	MultiSF	125 kHz
2	865.800 MHz	MultiSF	125 kHz
3	866.000 MHz	MultiSF	125 kHz
4	866.200 MHz	MultiSF	125 kHz
5	866.400 MHz	MultiSF	125 kHz
6	866.600 MHz	MultiSF	125 kHz
7	866.800 MHz	MultiSF	125 kHz
LoRa	865.700 MHz	SF7	250 kHz
FSK	865.700 MHz	FSK	250 kHz, 64 kbps
RX2 channel (downlink)			
RX2	865.200 MHz	SF12	125 kHz

### Step 1: Choose Frequency Band to use “Customized Bands”

## LoRa Gateway Settings

Configuration to communicate with LoRa devices and LoRaWAN server

General Settings   Radio Settings   Channels Settings

IoT Service	LoRaWan/RAW forwarder
Debug Level	Little message output
Service Provider	The Things Network
Server Address	ttn-router-eu
Server port for upstream	1700
Server port for downstream	1700
Gateway ID	a840411b7e104150
Status keepalive in seconds	30
Frequency Plan	Customized Bands

### Step 2: Configure Radio 0 & 1 Frequency

The LPS8 has two Radios from SX1308. You can configure these eight channels based on these two radios. Go to the Radio Settings page and enable Radio 0 to 865700000 and enable Radio 1 to 866500000.

General Settings	Radio Settings	Channels Settings
radio 0 enable	<input checked="" type="checkbox"/>	
Radio_0 frequency	865700000	
Radio_0 for tx	<input checked="" type="checkbox"/>	
Radio_0 tx min frequency	863000000	
Radio_0 tx max frequency	870000000	
radio 1 enable	<input checked="" type="checkbox"/>	
Radio_1 frequency	866500000	
Radio_1 for tx	<input type="checkbox"/>	

**Step 3: Configure Channel Frequency.**

What we need to configure for LoRa is 0~7 multiSF channel frequency and LoRa frequency as per LoRa frequency plan.

Each Channel Configure include below parameters:

- ✓ Radio used for this channel.
- ✓ Channel IF, frequency shift base on Radio Frequency.

Below are the settings for the LoRa frequency plan:

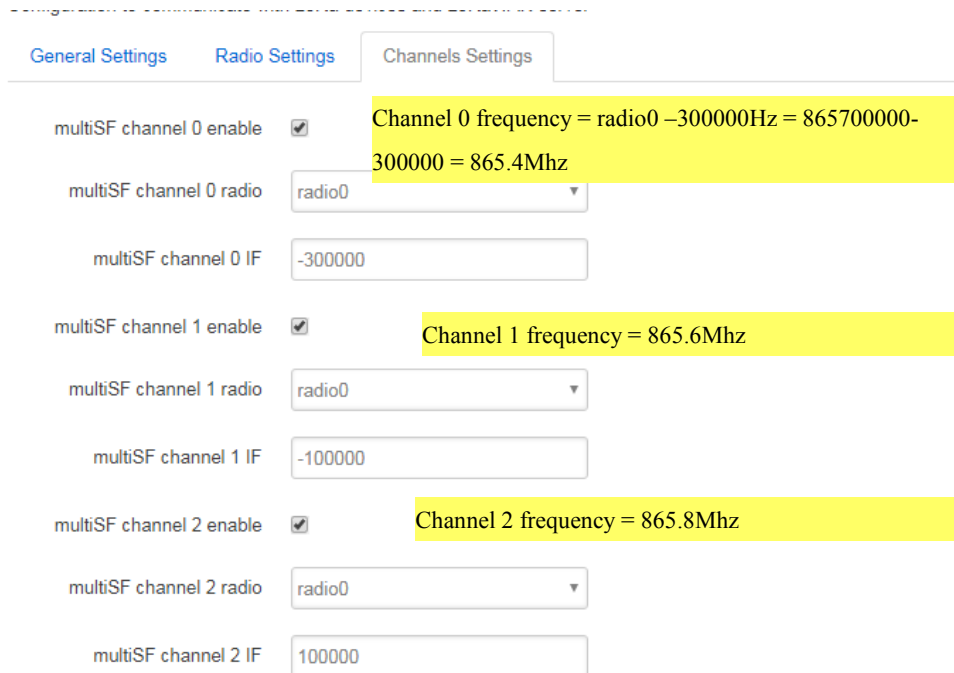

Channel	Enabled	Radio	IF	Frequency
multiSF channel 0	<input checked="" type="checkbox"/>	radio0	-300000	Channel 0 frequency = radio0 - 300000Hz = 865700000 - 300000 = 865.4Mhz
multiSF channel 1	<input checked="" type="checkbox"/>	radio0	-100000	Channel 1 frequency = 865.6Mhz
multiSF channel 2	<input checked="" type="checkbox"/>	radio0	100000	Channel 2 frequency = 865.8Mhz

multiSF channel 3 enable	<input checked="" type="checkbox"/>	Channel 3 frequency = 866.0Mhz
multiSF channel 3 radio	<input type="text" value="radio0"/>	
multiSF channel 3 IF	<input type="text" value="300000"/>	
multiSF channel 4 enable	<input checked="" type="checkbox"/>	Channel 4 frequency = 866.2Mhz
multiSF channel 4 radio	<input type="text" value="radio1"/>	
multiSF channel 4 IF	<input type="text" value="-300000"/>	
multiSF channel 5 enable	<input checked="" type="checkbox"/>	Channel 5 frequency = 866.4Mhz
multiSF channel 5 radio	<input type="text" value="radio1"/>	
multiSF channel 5 IF	<input type="text" value="-100000"/>	
multiSF channel 6 enable	<input checked="" type="checkbox"/>	Channel 6 frequency = 866.6Mhz
multiSF channel 6 radio	<input type="text" value="radio1"/>	
multiSF channel 6 IF	<input type="text" value="100000"/>	
multiSF channel 7 enable	<input checked="" type="checkbox"/>	Channel 7 frequency = 866.8Mhz
multiSF channel 7 radio	<input type="text" value="radio1"/>	
multiSF channel 7 IF	<input type="text" value="300000"/>	
lorastd channel enable	<input checked="" type="checkbox"/>	Channel LoRaSTDfrequency = 865.7Mhz, SF7, BW250Khz
LoRa channel radio	<input type="text" value="radio0"/>	
LoRa channel IF	<input type="text" value="0"/>	
LoRa channel SF	<input type="text" value="7"/>	
LoRa channel BW	<input type="text" value="250k"/>	

**Step 4: Save & Apply & check result in logread page.****Logread**

[FreqINFO](#) [Report](#) [RxTxJson](#) [ErrorMsg](#)

```
SX1301 Channels frequency
-----
chan_multiSF_0
LORA MAC, 125kHz, all SF, 865400000 Hz
-----
chan_multiSF_1
LORA MAC, 125kHz, all SF, 865600000 Hz
-----
chan_multiSF_2
LORA MAC, 125kHz, all SF, 865800000 Hz
-----
chan_multiSF_3
LORA MAC, 125kHz, all SF, 866000000 Hz
-----
chan_multiSF_4
LORA MAC, 125kHz, all SF, 866200000 Hz
-----
chan_multiSF_5
LORA MAC, 125kHz, all SF, 866400000 Hz
-----
```

## 8.2 Can I make my own firmware for LPS8?

### Where can I find the source code of LPS8?

Yes, You can make your own firmware for the LPS8 for branding purposes or to add customized applications.

The LPS8 source code and compile instructions can be found at:

[https://github.com/dragino/openwrt\\_lede-18.06](https://github.com/dragino/openwrt_lede-18.06)

## 8.3 Can I use 868Mhz version for 915Mhz bands?

It is possible but the distance will be very short, you can select US915 frequency band in 868Mhz version hardware. It will work but you will see the performance is greatly decreased because the 868Mhz version has an RF filter for band 863~870Mhz, all other frequencies will have high attenuation.

## 9 Troubleshooting

### 9.1 I get kernel error when install new package, how to fix?

In some cases, when installing a package with *opkg*, it will generate a kernel error such as below due to a mismatch in the kernel ID:

```
root@dragino-16c538:~# opkg install kmod-dragino2-si3217x_3.10.49+0.2-1_ar71xx.ipk
Installing kmod-dragino2-si3217x (3.10.49+0.2-1) to root...
Collected errors:
* satisfy_dependencies_for: Cannot satisfy the following dependencies for kmod-dragino2-si3217x:
*   kernel (= 3.10.49-1-4917516478a753314254643facdf360a) *
* opkg_install_cmd: Cannot install package kmod-dragino2-si3217x.
```

In this case, you can use the `-force-depends` option to install such package as long as the actual kernel version is the same.

```
Opkg install kmod-dragino2-si3217x_3.10.49+0.2-1_ar71xx.ipk -force-depends
```



## 9.2 How to recover the LPS8 if the firmware crashes

LPS8 provides the user with full control on its Linux system, so it is possible that the device will brick and can't boot after an improper modification in some boot files. In this case, the user can recover the whole Linux system by uploading a new firmware via Web Failsafe mode.

Procedure is as below:

- Use an RJ45 cable to connect the PC to LPS8's WAN port directly.
- Set the PC to a static IP of 192.168.255.x, Netmask 255.255.255.0
- Press and hold the toggle button and power on the device.
- All LEDs of the device will blink, release the toggle button after **four** blinks
- All LEDs will then blink very fast once, this means that the device has detected a network connection and will enter into the Web-Failsafe mode. Your PC should be able to ping 192.168.255.1 after device enters this mode.
- Open 192.168.255.1 in web browser.
- Select a [squashfs-sysupgrade](#) type firmware and update firmware.

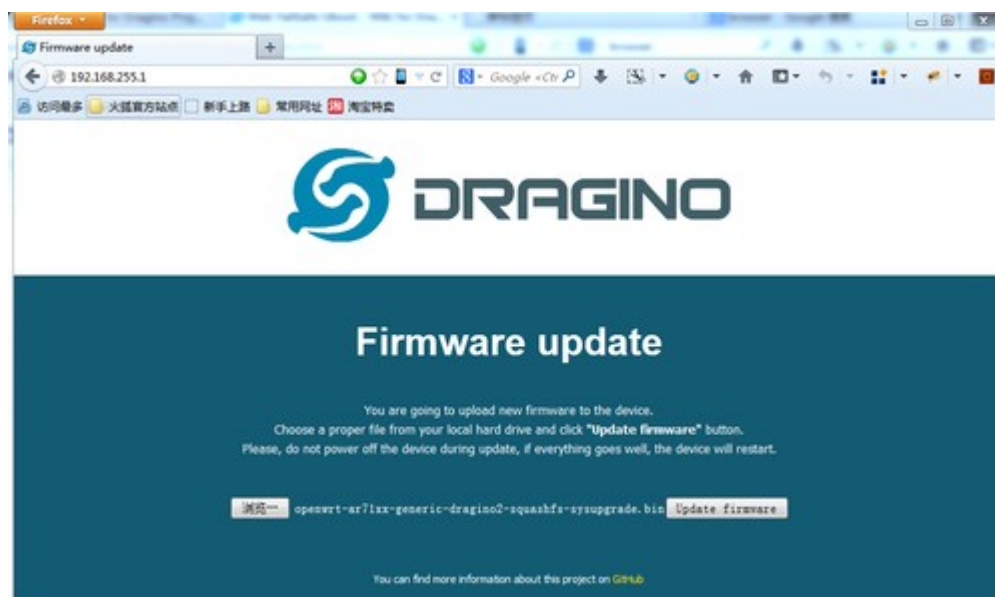

**Note:** If you see all LEDs blink very fast in Step 5, this means the network connection is established. If in this case, the PC is still not able to see the web page, you can debug as follows:

- ✓ Try different browser.
- ✓ Check if your PC is set to static IP address of 192.168.255.x
- ✓ Check if you have connected two RJ45 cables to device. If so, remove the unused one

### 9.3 I configured LPS8 for WiFi access and lost its IP. What to do now?

The LPS8 has a fall-back IP address on its WAN port. This IP is always enabled so you can use the fall-back IP to access LPS8 no matter what the WiFi IP is. The fall back IP is useful for connecting and debug the unit.

(Note: fallback IP can be disabled in the WAN and DHCP page)

Steps to connect via fall back IP:

1. Connect PC's Ethernet port to LG01's WAN port
2. Configure PC's Ethernet port has  
IP: 172.31.255.253 and  
Netmask: 255.255.255.252

As below photo:

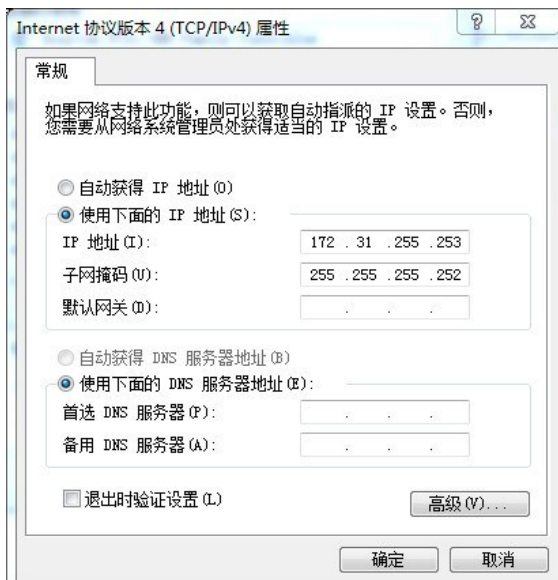

3. In the PC, use IP address 172.31.255.254 to access the LPS8 via Web or Console. Please note the latest firmware has use port 8000 for http and 2222 for ssh access.

### 9.4 I connect to the LPS8's SSID but LPS8 didn't assign DHCP IP to my laptop?

This is a known bug for the firmware version before 2019-09-23 for LPS, the issue was fixed since version: LG02\_LG08--build-v5.2.1569218466-20190923-1402.

In the old version, user can use the [fall back ip method](#) to access and configure the device.

## 10 Order Info

### **PART: LPS8-XXX-YYY:**

#### **XXX: Frequency Band**

- **868**: valid frequency: 863Mhz ~ 870Mhz. for band EU868 or IN865.
- **915**: valid frequency: 902Mhz ~ 928Mhz. for bands US915, AU915, AS923 or KR920

## 11 Packing Info

### Package Includes:

- ✓ LPS8 LoRa Gateway x 1
- ✓ Stick Antenna for LoRa RF part. Frequency is one of 470 or 868 or 915Mhz depends the model ordered
- ✓ Packaging with environmental protection paper box

### Dimension and weight:

- ✓ Device Size: 12 x 12 x 2.5 cm
- ✓ Device Weight:
- ✓ Package Size / pcs :
- ✓ Weight / pcs :
- ✓ Carton dimension:
- ✓ Weight / carton :

## 12 Support

- Try to see if your questions already answered in the [wiki](#).
- Support is provided Monday to Friday, from 09:00 to 18:00 GMT+8.  
Due to different timezones we cannot offer live support. However, your questions will be answered as soon as possible in the before mentioned schedule.
- Provide as much information as possible regarding your enquiry (product models, accurately describe your problem and steps to replicate it etc) and send a mail to:

[support@dragino.com](mailto:support@dragino.com)

## 13 Reference

- ✧ Source code for LPS8 LoRa Gateway  
[https://github.com/dragino/openwrt\\_lede-18.06](https://github.com/dragino/openwrt_lede-18.06)
- ✧ OpenWrt official Wiki  
<http://www.openwrt.org/>
- ✧ Firmware  
[http://www.dragino.com/downloads/index.php?dir=LoRa\\_Gateway/LPS8-OLPS8/Firmware/](http://www.dragino.com/downloads/index.php?dir=LoRa_Gateway/LPS8-OLPS8/Firmware/)

## 14 FCC Warning

This device complies with part 15 of the FCC Rules. Operation is subject to the following two conditions:

- (1) This device may not cause harmful interference, and
- (2) this device must accept any interference received, including interference that may cause undesired operation

This equipment has been tested and found to comply with the limits for a Class B digital device, pursuant to Part 15 of the FCC Rules. These limits are designed to provide reasonable protection against harmful interference in a residential installation. This equipment generates uses and can radiate radio frequency energy and, if not installed and used in accordance with the instructions, may cause harmful interference to radio communications. However, there is no guarantee that interference will not occur in a particular installation. If this equipment does cause harmful interference to radio or television reception, which can be determined by turning the equipment off and on, the user is encouraged to try to correct the interference by one or more of the following measures:

- Reorient or relocate the receiving antenna.
- Increase the separation between the equipment and receiver.
- Connect the equipment into an outlet on a circuit different from that to which the receiver is connected.
- Consult the dealer or an experienced radio/TV technician for help.

Changes or modifications not expressly approved by the party responsible for compliance could void the user's authority to operate the equipment.

To maintain compliance with FCC's RF Exposure guidelines, This equipment should be installed and operated with minimum distance between 20cm the radiator your body: Use only the supplied antenna.