

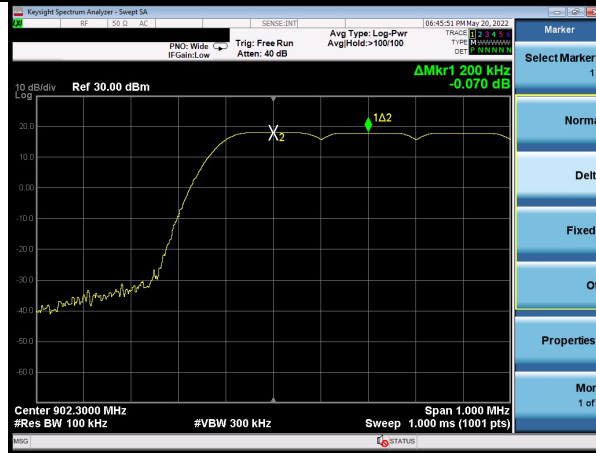

Test plot as follows:

Modulation mode:	125KHz Bandwidth
------------------	------------------



Lowest channel

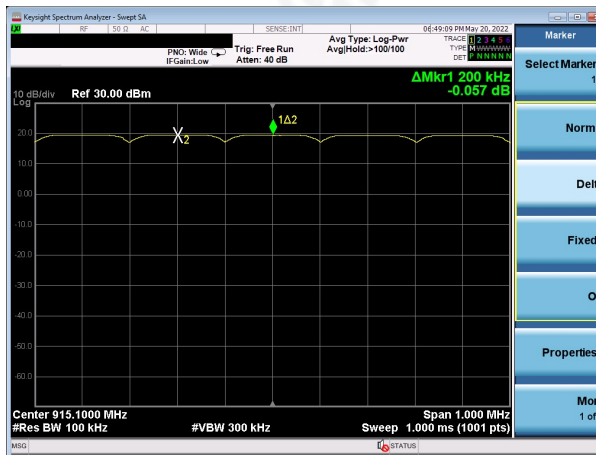

Middle channel



Highest channel



Test mode:

250KHz Bandwidth

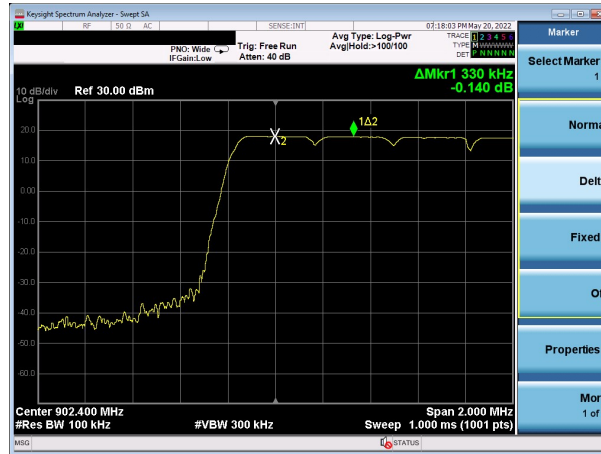

Lowest channel

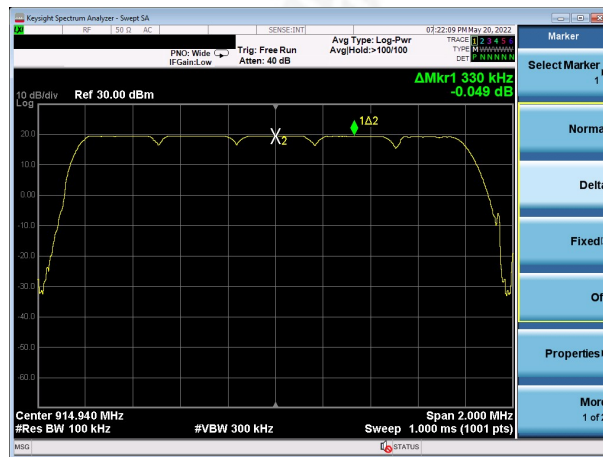

Middle channel



Highest channel



4.5 Hopping Channel Number

Test Requirement:	FCC Part15 C Section 15.247 (a)(1)
Test Method:	ANSI C63.10:2013
Receiver setup:	RBW=100kHz, VBW=300kHz, Frequency range=2400MHz-2483.5MHz, Detector=Peak
Limit:	If the 20 dB bandwidth of the hopping channel is less than 250 kHz, the system shall use at least 50 hopping frequencies. If the 20 dB bandwidth of the hopping channel is 250 kHz or greater, the system shall use at least 25 hopping frequencies
Test setup:	
Test Instruments:	Refer to section 6.0 for details
Test mode:	Refer to section 5.2 for details
Test results:	Pass

Measurement Data:

Mode	Hopping channel numbers	Limit	Result
125KHz Bandwidth	128	50	Pass
250KHz Bandwidth	77	25	Pass

125KHz

250KHz

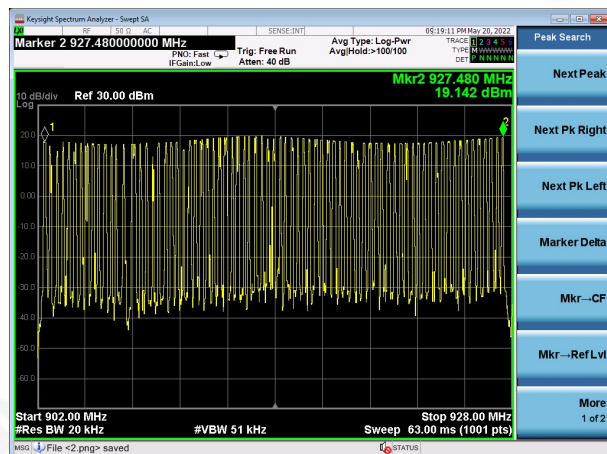
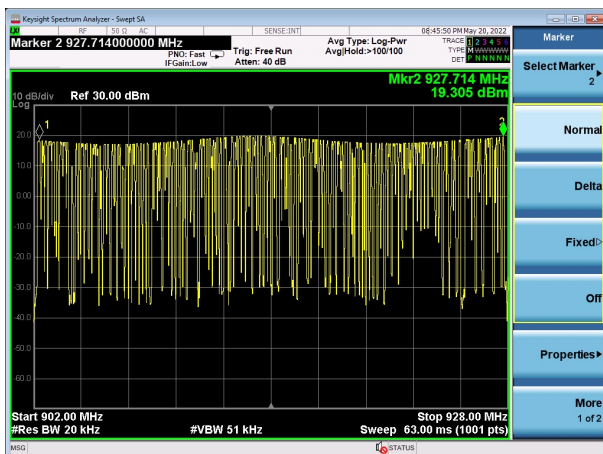

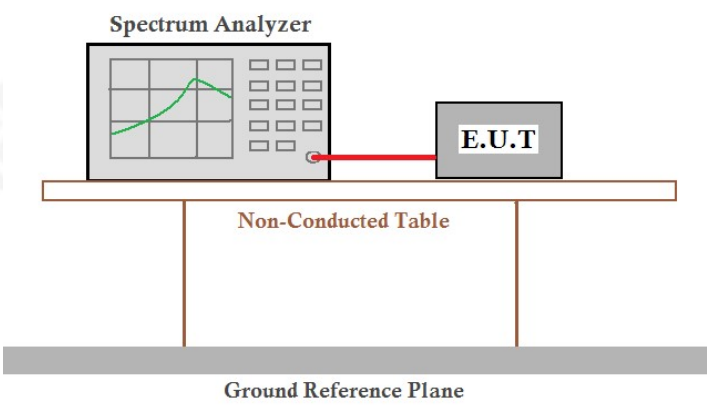

4.6 Dwell Time

Test Requirement:	FCC Part15 C Section 15.247 (a)(1)
Test Method:	ANSI C63.10:2013
Receiver setup:	RBW=10kHz, VBW=30kHz, Span=0Hz, Detector=Peak
Limit:	0.4 Second
Test setup:	 <p>The diagram illustrates the test setup. A Spectrum Analyzer is connected via a red cable to an E.U.T. (Equipment Under Test). Both are placed on a Non-Conducted Table. Below the table is a Ground Reference Plane.</p>
Test Instruments:	Refer to section 6.0 for details
Test mode:	Refer to section 5.2 for details
Test results:	Pass

Measurement Data

Mode	Ton(ms)	Tcycle(ms)	Dwell time(ms)	Limit(ms)	Result
125kHz Bandwidth	0.576	2.088	71.724	400	Pass
250kHz Bandwidth	0.210	1.020	28.823	400	Pass

Note: Transmit numbers= Continue TX Time/Tcycle
Dwell time=Transmit numbers*Ton



Test plot as follows:

Test Mode: 125KHz Bandwidth

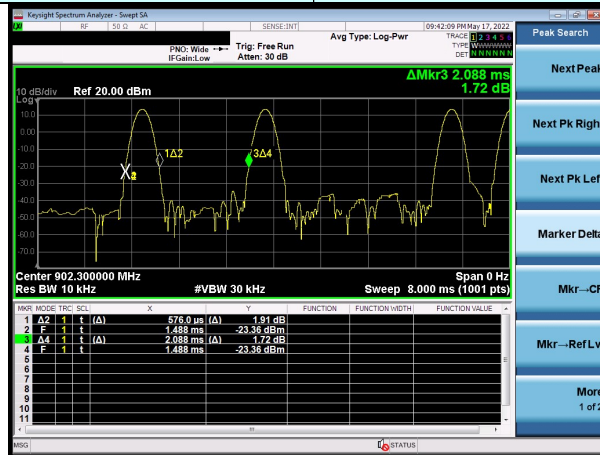

Ton&Tcycle

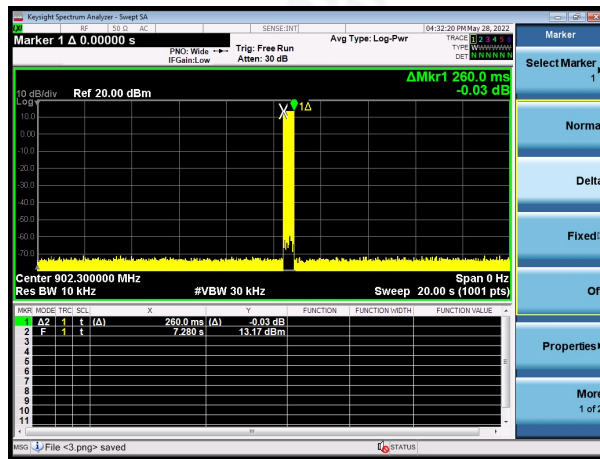

Continue TX Time



Test Mode:

250KHz Bandwidth

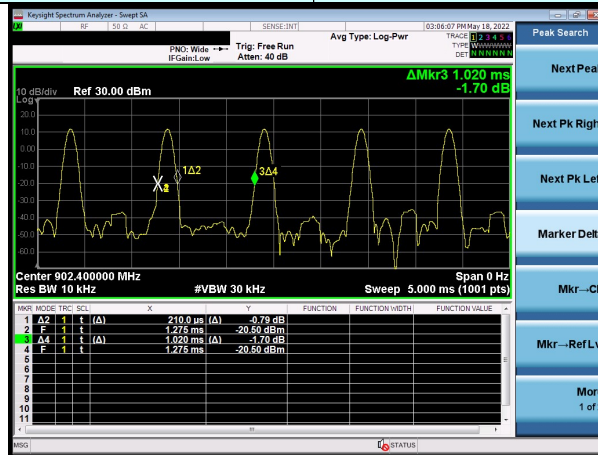

Ton&Tcycle

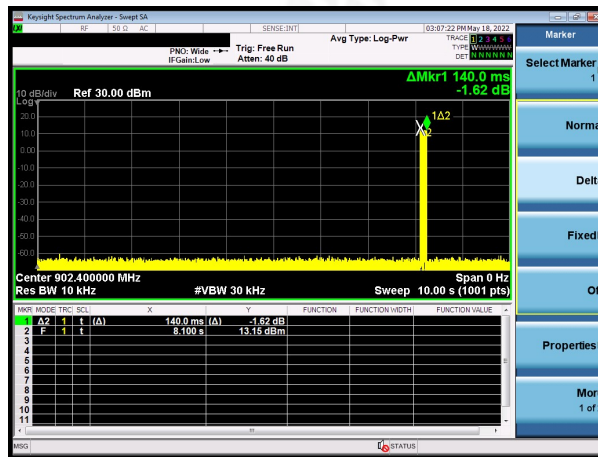

Continue TX Time

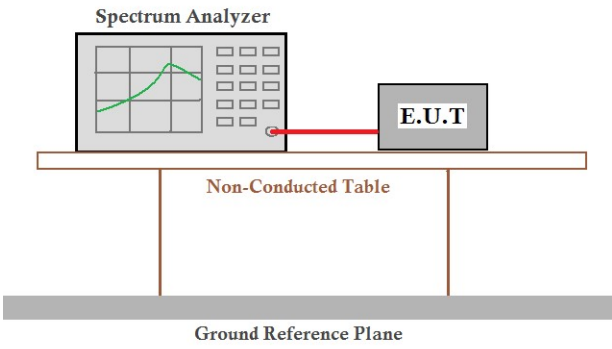

4.7 Band Edge

Test Requirement:	FCC Part15 C Section 15.247 (d)
Test Method:	ANSI C63.10:2013
Receiver setup:	RBW=100kHz, VBW=300kHz, Detector=Peak
Limit:	In any 100 kHz bandwidth outside the frequency band in which the spread spectrum intentional radiator is operating, the radio frequency power that is produced by the intentional radiator shall be at least 20 dB below that in the 100 kHz bandwidth within the band that contains the highest level of the desired power, based on either an RF conducted or a radiated measurement.
Test setup:	 <p>The diagram illustrates the test setup. A Spectrum Analyzer is connected to an E.U.T. (Equipment Under Test) via a red cable. Both are placed on a Non-Conducted Table, which is supported by two legs. Below the table is a Ground Reference Plane.</p>
Test Instruments:	Refer to section 6.0 for details
Test mode:	Refer to section 5.2 for details
Test results:	Pass



Test plot as follows:
125KHz Bandwidth:

Test channel: Lowest channel

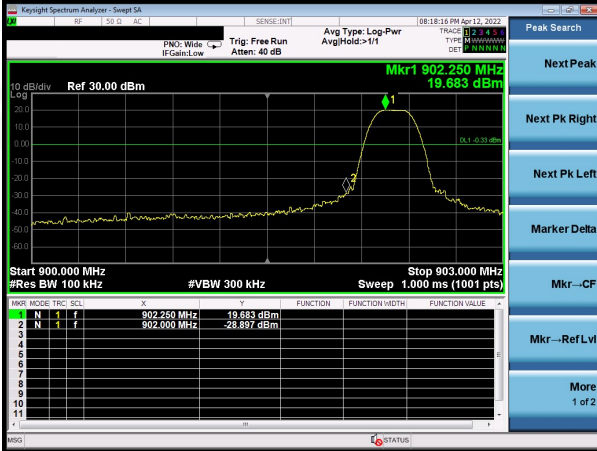

No-hopping mode

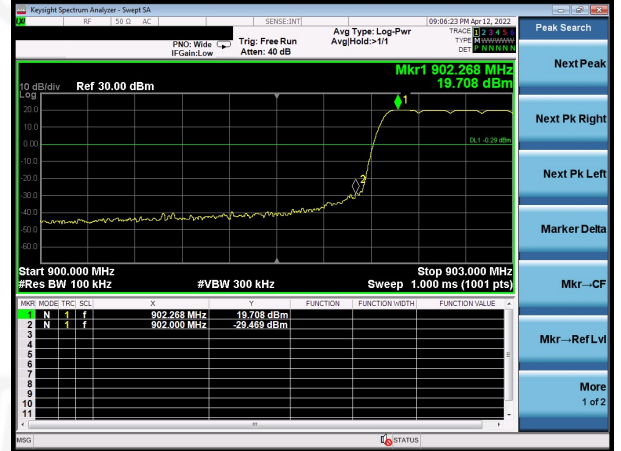

Hopping mode

Test channel: Highest channel

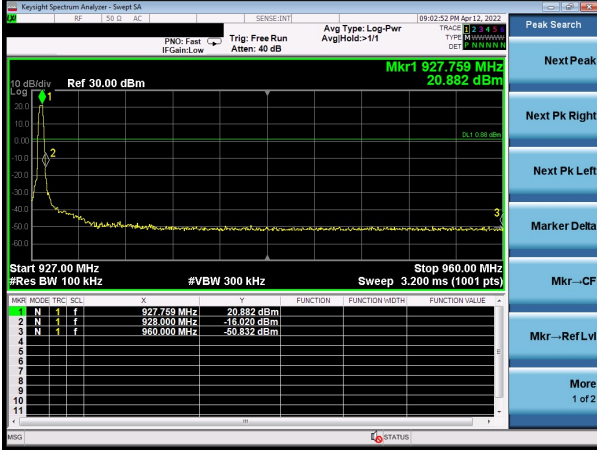

No-hopping mode

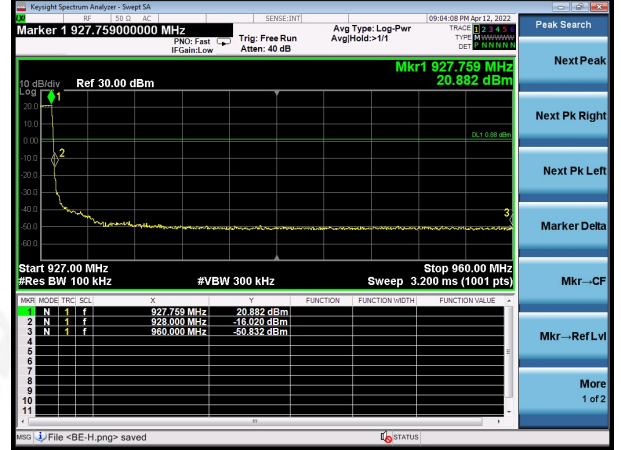

Hopping mode



250KHz Bandwidth:

Test channel:

Lowest channel

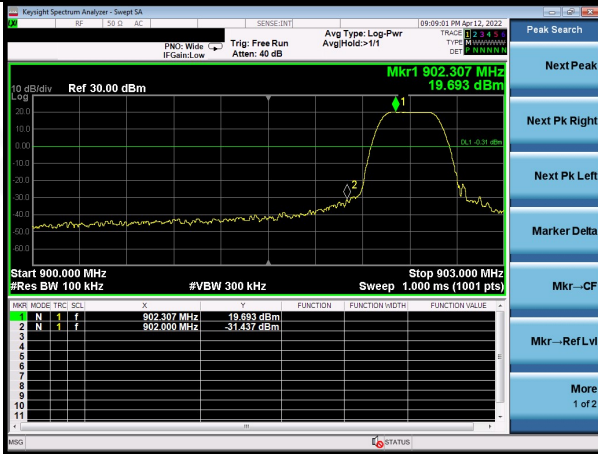

No-hopping mode

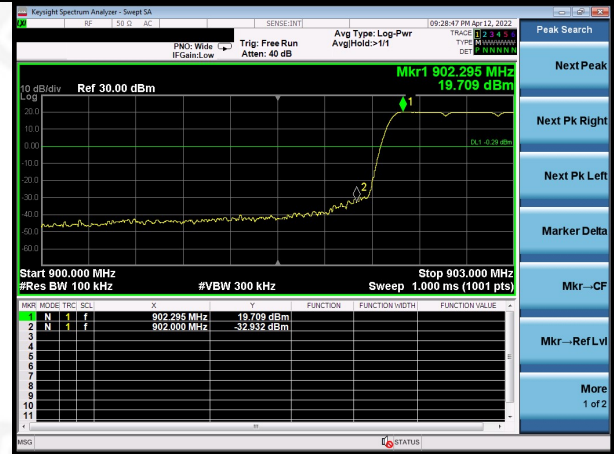

Hopping mode

Test channel:

Highest channel

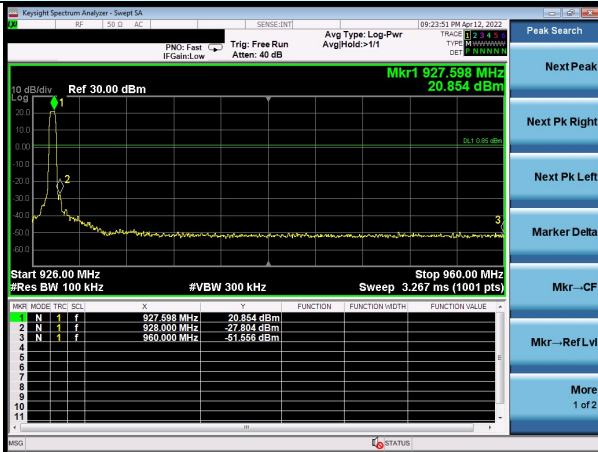

No-hopping mode

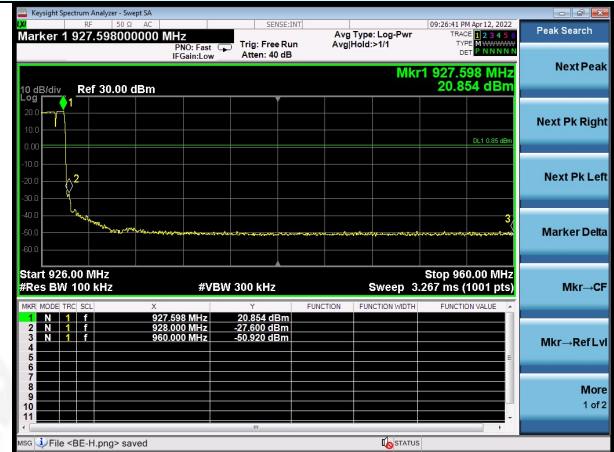

Hopping mode



4.9 Spurious Emission

Conducted Emission Method

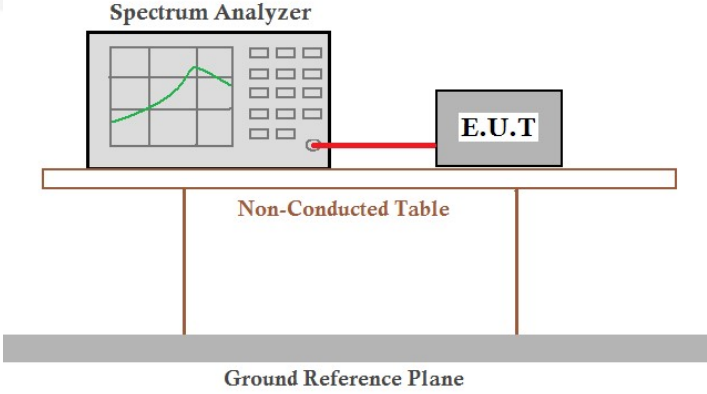
Test Requirement:	FCC Part15 C Section 15.247 (d)
Test Method:	ANSI C63.10:2013
Limit:	In any 100 kHz bandwidth outside the frequency band in which the spread spectrum intentional radiator is operating, the radio frequency power that is produced by the intentional radiator shall be at least 20 dB below that in the 100 kHz bandwidth within the band that contains the highest level of the desired power, based on either an RF conducted or a radiated measurement.
Test setup:	 <p>The diagram illustrates the test setup. A Spectrum Analyzer is connected to an E.U.T. (Equipment Under Test) via a red cable. Both are placed on a Non-Conducted Table, which sits on a Ground Reference Plane.</p>
Test Instruments:	Refer to section 6.0 for details
Test mode:	Refer to section 5.2 for details
Test results:	Pass



125KHz Bandwidth:

Test channel: Lowest channel

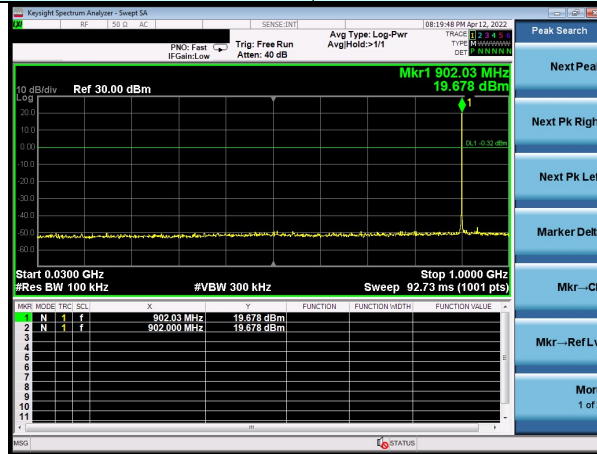

30MHz~10GHz

Test channel: Middle channel

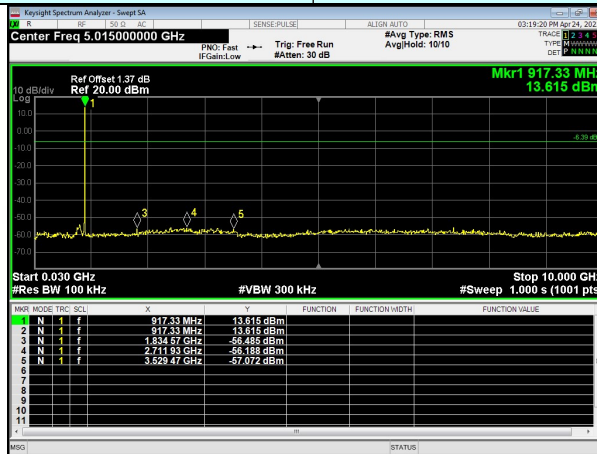

30MHz~10GHz

Test channel: Highest channel

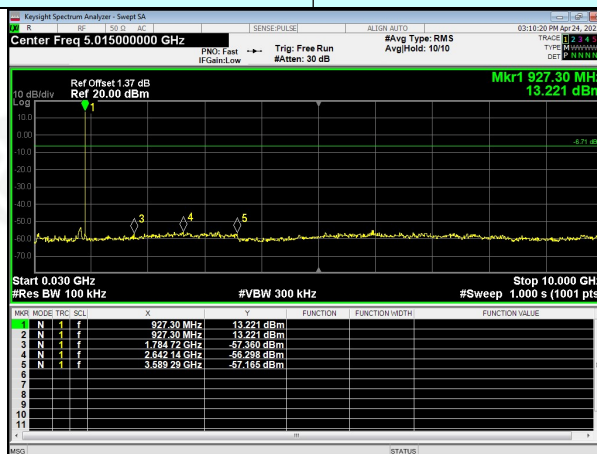

30MHz~10GHz



250KHz Bandwidth:

Test channel: Lowest channel

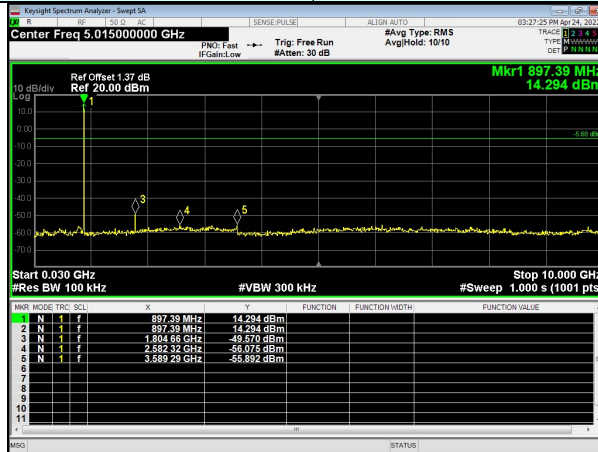

30MHz~10GHz

Test channel: Middle channel

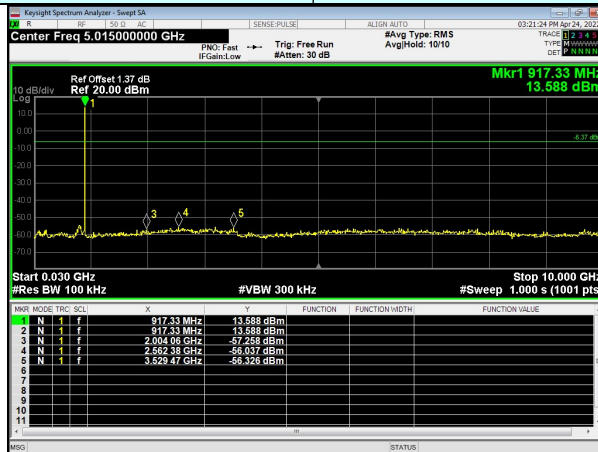

30MHz~10GHz

Test channel: Highest channel

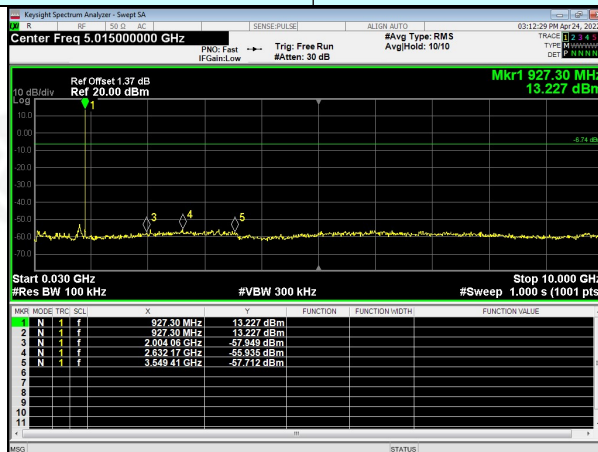

30MHz~10GHz



4.10 Radiated Emission Method

Test Requirement:	FCC Part15 C Section 15.209				
Test Method:	ANSI C63.10:2013				
Test Frequency Range:	9kHz to 25GHz				
Test site:	Measurement Distance: 3m				
Receiver setup:	Frequency	Detector	RBW	VBW	Value
	9KHz-150KHz	Quasi-peak	200Hz	600Hz	Quasi-peak
	150KHz-30MHz	Quasi-peak	9KHz	30KHz	Quasi-peak
	30MHz-1GHz	Quasi-peak	120KHz	300KHz	Quasi-peak
	Above 1GHz	Peak	1MHz	3MHz	Peak
Peak		1MHz	10Hz	Average	
Limit:	Frequency	Limit (uV/m)	Value	Measurement Distance	
	0.009MHz-0.490MHz	2400/F(KHz)	QP	300m	
	0.490MHz-1.705MHz	24000/F(KHz)	QP	30m	
	1.705MHz-30MHz	30	QP	30m	
	30MHz-88MHz	100	QP	3m	
	88MHz-216MHz	150	QP		
	216MHz-960MHz	200	QP		
	960MHz-1GHz	500	QP		
	Above 1GHz	500	Average		
		5000	Peak		
Test setup:	<p>For radiated emissions from 9kHz to 30MHz</p>				

For radiated emissions from 30MHz to1GHz

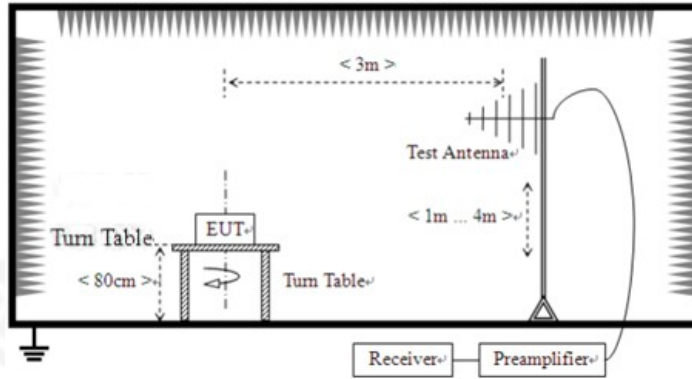

For radiated emissions above 1GHz

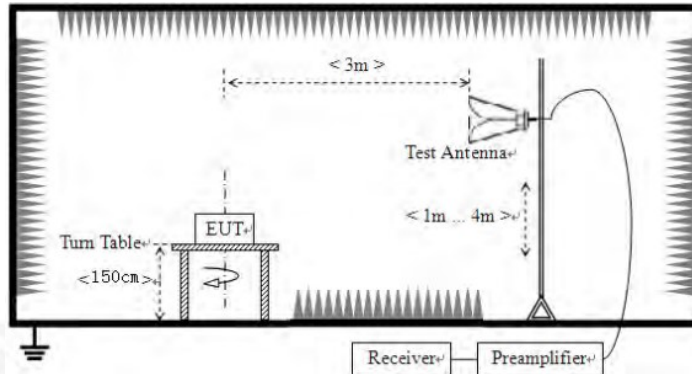

Test Procedure:

1. The EUT was placed on the top of a rotating table (0.8m for below 1G and 1.5m for above 1G) above the ground at a 3 meter camber. The table was rotated 360 degrees to determine the position of the highest radiation.
2. The EUT was set 3 meters away from the interference-receiving antenna, which was mounted on the top of a variable-height antenna tower.
3. The antenna height is varied from one meter to four meters above the ground to determine the maximum value of the field strength. Both horizontal and vertical polarizations of the antenna are set to make the measurement.
4. For each suspected emission, the EUT was arranged to its worst case and then the antenna was tuned to heights from 1 meter to 4 meters and the rota table was turned from 0 degrees to 360 degrees to find the maximum reading.
5. The test-receiver system was set to Peak Detect Function and Specified Bandwidth with Maximum Hold Mode.
6. If the emission level of the EUT in peak mode was 10dB lower than the limit specified, then testing could be stopped and the peak values of the EUT would be reported. Otherwise the emissions that did not have 10dB margin would be re-tested one by one using peak, quasi-peak or average method as specified and then reported in a data sheet.

Test Instruments:

Refer to section 6.0 for details

Test mode:

Refer to section 5.2 for details

Test environment:

Temp.:	25 °C	Humid.:	52%	Press.:	1012mbar
--------	-------	---------	-----	---------	----------

Test voltage:

AC 120V, 60Hz

Test results:

Pass



Measurement data:

Remarks:

1. *Pre-scan all kind of the place mode (X-axis, Y-axis, Z-axis), and found the Y-axis which it is worse case.*

■ **9kHz~30MHz**

The low frequency, which started from 9 kHz to 30 MHz, was pre-scanned and the result which was 20 dB lower than the limit line per 15.31(o) was not reported.



■ Below 1GHz

Pre-scan all test modes, found worst case at lowest channel of 125KHz bandwidth, so only show the worst case on the report.

Horizontal:

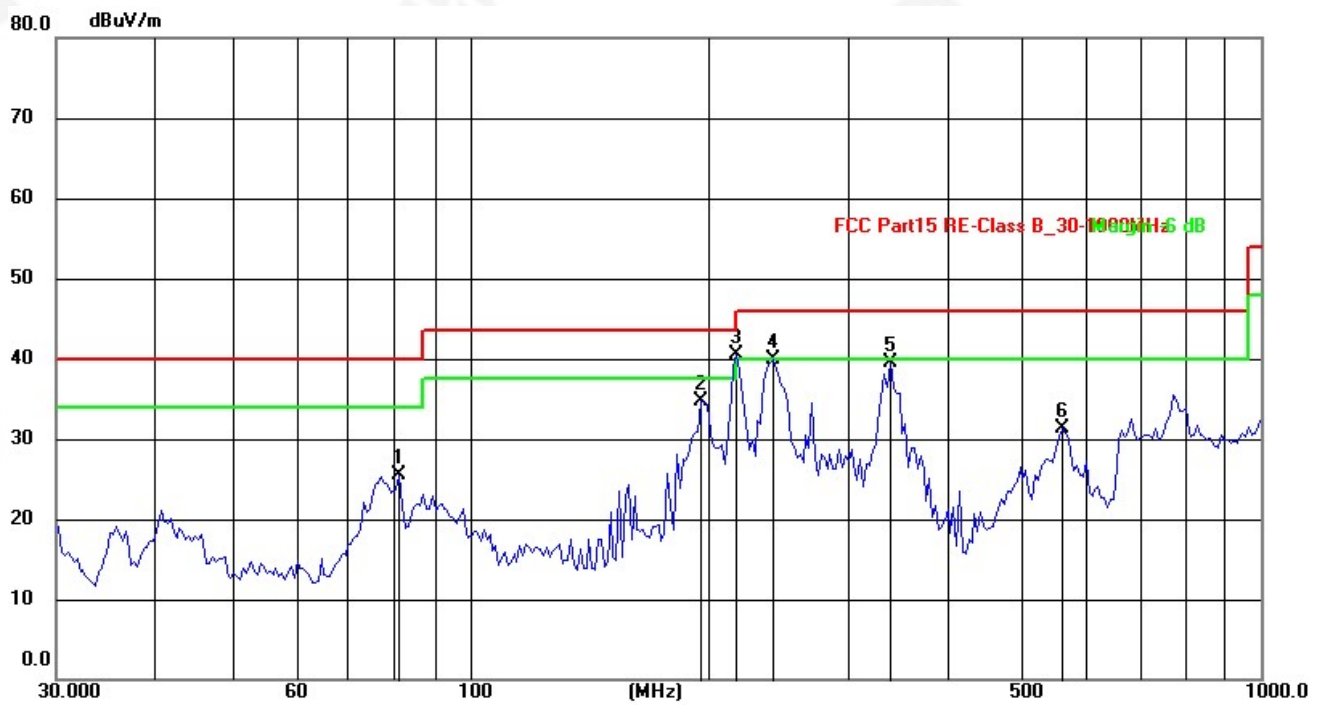

No.	Frequency (MHz)	Reading (dBuV)	Factor (dB/m)	Level (dBuV/m)	Limit (dBuV/m)	Margin (dB)	Detector
1	81.4970	45.08	-19.58	25.50	40.00	-14.50	QP
2	195.8219	54.36	-19.57	34.79	43.50	-8.71	QP
3	217.5443	59.63	-19.09	40.54	46.00	-5.46	QP
4	241.6763	57.62	-17.63	39.99	46.00	-6.01	QP
5	340.1847	58.26	-18.82	39.44	46.00	-6.56	QP
6	560.6928	43.21	-11.93	31.28	46.00	-14.72	QP



Vertical:

80.0 dBuV/m

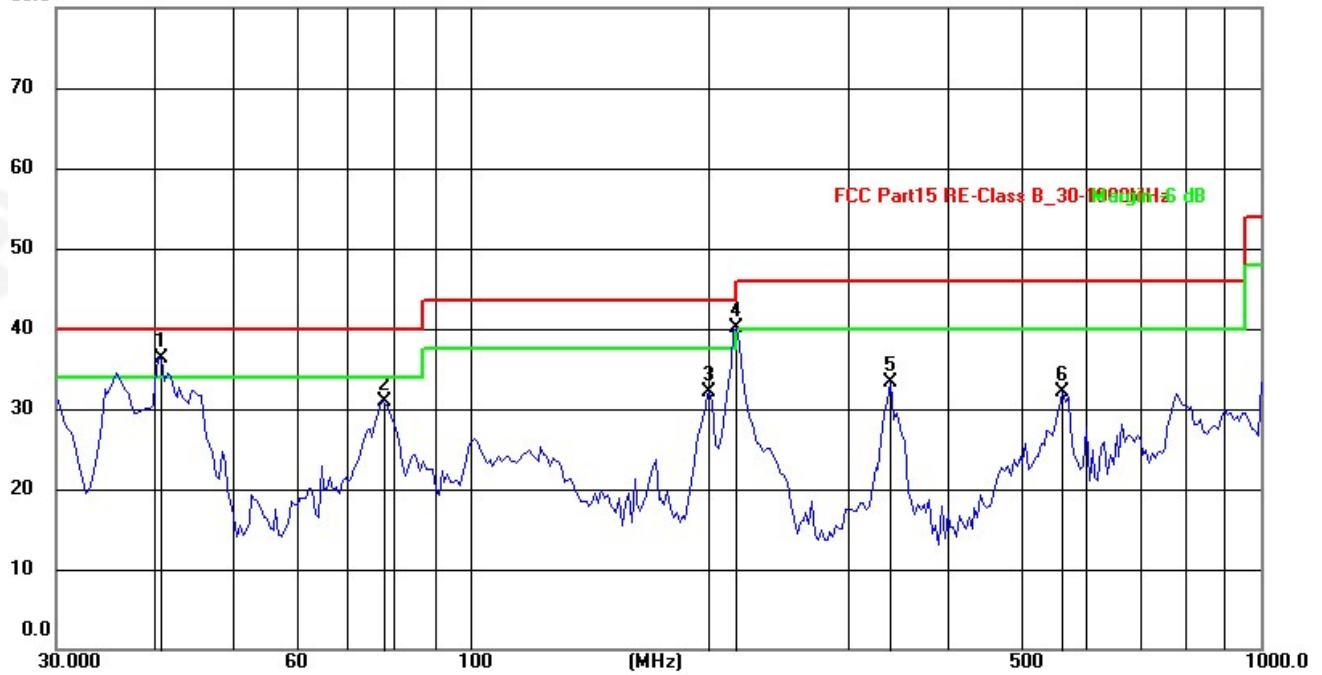

No.	Frequency (MHz)	Reading (dBuV)	Factor (dB/m)	Level (dBuV/m)	Limit (dBuV/m)	Margin (dB)	Detector
1	40.4172	53.21	-16.88	36.33	40.00	-3.67	QP
2	77.3212	52.18	-21.19	30.99	40.00	-9.01	QP
3	201.0402	53.73	-21.69	32.04	43.50	-11.46	QP
4	217.5443	61.73	-21.60	40.13	46.00	-5.87	QP
5	340.1847	52.25	-19.00	33.25	46.00	-12.75	QP
6	560.6928	43.46	-11.27	32.19	46.00	-13.81	QP



■ Above 1GHz

Test channel:	Lowest channel
---------------	----------------

Peak value:

Frequency (MHz)	Read Level (dBuV)	Antenna Factor (dB/m)	Cable Loss (dB)	Preamp Factor (dB)	Level (dBuV/m)	Limit Line (dBuV/m)	Over Limit (dB)	polarization
1804.60	41.19	25.35	4.67	34.04	37.17	74.00	-36.83	Vertical
2706.90	34.94	28.26	5.43	33.25	35.38	74.00	-38.62	Vertical
3609.20	33.71	29.18	7.11	37.34	32.66	74.00	-41.34	Vertical
4511.50	*					74.00		Vertical
5413.80	*					74.00		Vertical
6316.10	*					74.00		Vertical
1804.60	39.78	25.35	4.67	34.04	35.76	74.00	-38.24	Horizontal
2706.90	34.99	28.26	5.43	33.25	35.43	74.00	-38.57	Horizontal
3609.20	32.67	29.18	7.11	37.34	31.62	74.00	-42.38	Horizontal
4511.50	*					74.00		Horizontal
5413.80	*					74.00		Horizontal
6316.10	*					74.00		Horizontal

Average value:

Frequency (MHz)	Read Level (dBuV)	Antenna Factor (dB/m)	Cable Loss (dB)	Preamp Factor (dB)	Level (dBuV/m)	Limit Line (dBuV/m)	Over Limit (dB)	polarization
1804.60	30.27	25.35	4.67	34.04	26.25	54.00	-27.75	Vertical
2706.90	23.81	28.26	5.43	33.25	24.25	54.00	-29.75	Vertical
3609.20	24.06	29.18	7.11	37.34	23.01	54.00	-30.99	Vertical
4511.50	*					54.00		Vertical
5413.80	*					54.00		Vertical
6316.10	*					54.00		Vertical
1804.60	29.31	25.35	4.67	34.04	25.29	54.00	-28.71	Horizontal
2706.90	23.57	28.26	5.43	33.25	24.01	54.00	-29.99	Horizontal
3609.20	22.42	29.18	7.11	37.34	21.37	54.00	-32.63	Horizontal
4511.50	*					54.00		Horizontal
5413.80	*					54.00		Horizontal
6316.10	*					54.00		Horizontal



Test channel:	Middle channel
---------------	----------------

Peak value:

Frequency (MHz)	Read Level (dBuV)	Antenna Factor (dB/m)	Cable Loss (dB)	Preamp Factor (dB)	Level (dBuV/m)	Limit Line (dBuV/m)	Over Limit (dB)	polarization
1830.20	40.23	25.43	4.89	34.12	36.43	74.00	-37.57	Vertical
2745.30	35.00	28.34	5.68	33.57	35.45	74.00	-38.55	Vertical
3660.40	34.73	29.42	7.29	37.66	33.78	74.00	-40.22	Vertical
4575.50	*					74.00		Vertical
5490.60	*					74.00		Vertical
6405.70	*					74.00		Vertical
1830.20	40.63	25.43	4.89	34.12	36.83	74.00	-37.17	Horizontal
2745.30	33.95	28.34	5.68	33.57	34.40	74.00	-39.60	Horizontal
3660.40	33.99	29.42	7.29	37.66	33.04	74.00	-40.96	Horizontal
4575.50	*					74.00		Horizontal
5490.60	*					74.00		Horizontal
6405.70	*					74.00		Horizontal

Average value:

Frequency (MHz)	Read Level (dBuV)	Antenna Factor (dB/m)	Cable Loss (dB)	Preamp Factor (dB)	Level (dBuV/m)	Limit Line (dBuV/m)	Over Limit (dB)	polarization
1830.20	31.08	25.43	4.89	34.12	27.28	54.00	-26.72	Vertical
2745.30	23.32	28.34	5.68	33.57	23.77	54.00	-30.23	Vertical
3660.40	23.98	29.42	7.29	37.66	23.03	54.00	-30.97	Vertical
4575.50	*					54.00		Vertical
5490.60	*					54.00		Vertical
6405.70	*					54.00		Vertical
1830.20	30.74	25.43	4.89	34.12	26.94	54.00	-27.06	Horizontal
2745.30	23.04	28.34	5.68	33.57	23.49	54.00	-30.51	Horizontal
3660.40	23.71	29.42	7.29	37.66	22.76	54.00	-31.24	Horizontal
4575.50	*					54.00		Horizontal
5490.60	*					54.00		Horizontal
6405.70	*					54.00		Horizontal



Test channel:	Highest channel
---------------	-----------------

Peak value:

Frequency (MHz)	Read Level (dBuV)	Antenna Factor (dB/m)	Cable Loss (dB)	Preamp Factor (dB)	Level (dBuV/m)	Limit Line (dBuV/m)	Over Limit (dB)	polarization
1855.40	45.80	25.64	4.75	34.67	41.52	74.00	-32.48	Vertical
2783.10	35.70	28.46	5.87	33.83	36.20	74.00	-37.80	Vertical
3710.80	38.04	29.75	7.59	37.76	37.62	74.00	-36.38	Vertical
4638.50	*					74.00		Vertical
5566.20	*					74.00		Vertical
6493.90	*					74.00		Vertical
1855.40	45.02	25.64	4.75	34.67	40.74	74.00	-33.26	Horizontal
2783.10	34.91	28.46	5.87	33.83	35.41	74.00	-38.59	Horizontal
3710.80	33.59	29.75	7.59	37.76	33.17	74.00	-40.83	Horizontal
4638.50	*					74.00		Horizontal
5566.20	*					74.00		Horizontal
6493.90	*					74.00		Horizontal

Average value:

Frequency (MHz)	Read Level (dBuV)	Antenna Factor (dB/m)	Cable Loss (dB)	Preamp Factor (dB)	Level (dBuV/m)	Limit Line (dBuV/m)	Over Limit (dB)	polarization
1855.40	36.71	25.64	4.75	34.67	32.43	54.00	-21.57	Vertical
2783.10	25.62	28.46	5.87	33.83	26.12	54.00	-27.88	Vertical
3710.80	26.54	29.75	7.59	37.76	26.12	54.00	-27.88	Vertical
4638.50	*					54.00		Vertical
5566.20	*					54.00		Vertical
6493.90	*					54.00		Vertical
1855.40	35.38	25.64	4.75	34.67	31.10	54.00	-22.90	Horizontal
2783.10	24.29	28.46	5.87	33.83	24.79	54.00	-29.21	Horizontal
3710.80	22.85	29.75	7.59	37.76	22.43	54.00	-31.57	Horizontal
4638.50	*					54.00		Horizontal
5566.20	*					54.00		Horizontal
6493.90	*					54.00		Horizontal

Remarks:

1. Final Level =Receiver Read level + Antenna Factor + Cable Loss – Preamplifier Factor
2. “*”, means this data is the too weak instrument of signal is unable to test.
3. The emission levels of other frequencies are very lower than the limit and not show in test report.
4. The test data shows only the worst case 125KHz bandwidth mode.



5. Antenna Requirement

Standard requirement:	FCC Part15 C Section 15.203 /247(c)
15.203 requirement: An intentional radiator shall be designed to ensure that no antenna other than that furnished by the responsible party shall be used with the device. The use of a permanently attached antenna or of an antenna that uses a unique coupling to the intentional radiator, the manufacturer may design the unit so that a broken antenna can be replaced by the user, but the use of a standard antenna jack or electrical connector is prohibited.	
15.247(c) (1)(i) requirement: (i) Systems operating in the 2400-2483.5 MHz band that is used exclusively for fixed. Point-to-point operations may employ transmitting antennas with directional gain greater than 6dBi provided the maximum conducted output power of the intentional radiator is reduced by 1 dB for every 3 dB that the directional gain of the antenna exceeds 6dBi.	
EUT Antenna:	
The antenna is Fibre-glass epoxy antenna, the antennas is 0dBi, reference to the appendix II for details	



6. Test Setup Photo

Reference to the appendix I for details.

7. EUT Constructional Details

Reference to the appendix II for details.

***** END OF REPORT *****