

## FCC Test Report

**Report No.:** RF130903C26I-1

**FCC ID:** ZHV-DTAGA

**Test Model:** DTAGA

**Received Date:** Sep. 03, 2013

**Test Date:** Jan. 30 ~ Feb. 19, 2016

**Issued Date:** Apr. 19, 2016

**Applicant:** Riverbed Technology Inc.

**Address:** 680 Folsom Street San Francisco, California USA 94107

**Issued By:** Bureau Veritas Consumer Products Services (H.K.) Ltd., Taoyuan Branch

**Lab Address:** No. 47-2, 14th Ling, Chia Pau Vil., Lin Kou Dist., New Taipei City, Taiwan (R.O.C.)

**Test Location:** No.19, Hwa Ya 2nd Rd., Wen Hwa Vil., Kwei Shan Dist., Taoyuan City 33383, TAIWAN (R.O.C.)



This report is for your exclusive use. Any copying or replication of this report to or for any other person or entity, or use of our name or trademark, is permitted only with our prior written permission. This report sets forth our findings solely with respect to the test samples identified herein. The results set forth in this report are not indicative or representative of the quality or characteristics of the lot from which a test sample was taken or any similar or identical product unless specifically and expressly noted. Our report includes all of the tests requested by you and the results thereof based upon the information that you provided to us. You have 60 days from date of issuance of this report to notify us of any material error or omission caused by our negligence, provided, however, that such notice shall be in writing and shall specifically address the issue you wish to raise. A failure to raise such issue within the prescribed time shall constitute your unqualified acceptance of the completeness of this report, the tests conducted and the correctness of the report contents. Unless specific mention, the uncertainty of measurement has been explicitly taken into account to declare the compliance or non-compliance to the specification. The report must not be used by the client to claim product certification, approval, or endorsement by TAF or any government agencies.



### Table of Contents

<b>Release Control Record</b> .....	<b>4</b>
<b>1 Certificate of Conformity</b> .....	<b>5</b>
<b>2 Summary of Test Results</b> .....	<b>6</b>
2.1 Measurement Uncertainty.....	6
2.2 Modification Record.....	6
<b>3 General Information</b> .....	<b>7</b>
3.1 General Description of EUT.....	7
3.2 Description of Test Modes.....	9
3.2.1 Test Mode Applicability and Tested Channel Detail.....	10
3.3 Duty Cycle of Test Signal.....	12
3.4 Description of Support Units.....	13
3.4.1 Configuration of System under Test.....	13
3.5 General Description of Applied Standard.....	14
<b>4 Test Types and Results</b> .....	<b>15</b>
4.1 Radiated Emission and Bandedge Measurement.....	15
4.1.1 Limits of Radiated Emission and Bandedge Measurement.....	15
4.1.2 Test Instruments.....	16
4.1.3 Test Procedure.....	17
4.1.4 Deviation from Test Standard.....	17
4.1.5 Test Setup.....	18
4.1.6 EUT Operating Conditions.....	18
4.1.7 Test Results.....	19
4.2 Conducted Emission Measurement.....	38
4.2.1 Limits of Conducted Emission Measurement.....	38
4.2.2 Test Instruments.....	38
4.2.3 Test Procedure.....	39
4.2.4 Deviation from Test Standard.....	39
4.2.5 Test Setup.....	39
4.2.6 EUT Operating Conditions.....	39
4.2.7 Test Results.....	40
4.3 Transmit Power Measurement.....	42
4.3.1 Limits of Transmit Power Measurement.....	42
4.3.2 Test Setup.....	42
4.3.3 Test Instruments.....	42
4.3.4 Test Procedure.....	43
4.3.5 Deviation from Test Standard.....	43
4.3.6 EUT Operating Conditions.....	43
4.3.7 Test Result.....	44
4.4 Peak Power Spectral Density Measurement.....	50
4.4.1 Limits of Peak Power Spectral Density Measurement.....	50
4.4.2 Test Setup.....	50
4.4.3 Test Instruments.....	50
4.4.4 Test Procedure.....	50
4.4.5 Deviation from Test Standard.....	51
4.4.6 EUT Operating Condition.....	51
4.4.7 Test Results.....	52
4.5 Frequency Stability.....	58
4.5.1 Limits of Frequency Stability Measurement.....	58
4.5.2 Test Setup.....	58
4.5.3 Test Instruments.....	58
4.5.4 Test Procedure.....	58
4.5.5 Deviation from Test Standard.....	58
4.5.6 EUT Operating Condition.....	58



4.5.7 Test Results .....	59
4.6 6dB Bandwidth Measurement.....	60
4.6.1 Limits of 6dB Bandwidth Measurement.....	60
4.6.2 Test Setup.....	60
4.6.3 Test Instruments .....	60
4.6.4 Test Procedure .....	60
4.6.5 Deviation from Test Standard .....	60
4.6.6 EUT Operating Condition .....	60
4.6.7 Test Results .....	61
<b>5 Pictures of Test Arrangements.....</b>	<b>63</b>
<b>Appendix – Information on the Testing Laboratories .....</b>	<b>64</b>



A D T

### Release Control Record

Issue No.	Description	Date Issued
RF130903C26I-1	Original release.	Apr. 19, 2016

## 1 Certificate of Conformity

**Product:** Wireless Access Point

**Brand:** riverbed

**Test Model:** DTAGA

**Sample Status:** Engineering sample

**Applicant:** Riverbed Technology Inc.

**Test Date:** Jan. 30 ~ Feb. 19, 2016

**Standard:** 47 CFR FCC Part 15, Subpart E (Section 15.407)  
ANSI C63.10:2013

The above equipment has been tested by **Bureau Veritas Consumer Products Services (H.K.) Ltd., Taoyuan Branch**, and found compliance with the requirement of the above standards. The test record, data evaluation & Equipment Under Test (EUT) configurations represented herein are true and accurate accounts of the measurements of the sample's EMC characteristics under the Conditions specified in this report.

**Prepared by :**  , **Date:** Apr. 19, 2016  
Ivy Lin / Specialist

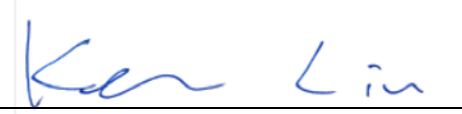
**Approved by :**  , **Date:** Apr. 19, 2016  
Ken Liu / Senior Manager

## 2 Summary of Test Results

47 CFR FCC Part 15, Subpart E (Section 15.407)			
FCC Clause	Test Item	Result	Remarks
15.407(b)(6)	AC Power Conducted Emissions	PASS	Meet the requirement of limit. Minimum passing margin is -17.25dB at 0.35203MHz.
15.407(b) (1/2/3/4/6)	Radiated Emissions & Band Edge Measurement	PASS	Meet the requirement of limit. Minimum passing margin is -1.0dB at 5150.00MHz.
15.407(a)(1/2 /3)	Max Average Transmit Power	PASS	Meet the requirement of limit.
15.407(a)(1/2 /3)	Peak Power Spectral Density	PASS	Meet the requirement of limit.
15.407(e)	6dB bandwidth	PASS	Meet the requirement of limit. (U-NII-3 Band only)
15.407(g)	Frequency Stability	PASS	Meet the requirement of limit.
15.203	Antenna Requirement	PASS	Antenna connector is N-Type. (The device is professionally installed)

### 3 General Information

#### 3.1 General Description of EUT

Product	Wireless Access Point
Brand	<b>riverbed</b>
Test Model	DTAGA
Status of EUT	Engineering sample
Power Supply Rating	48Vdc (PoE)
Modulation Type	256QAM, 64QAM, 16QAM, QPSK, BPSK
Modulation Technology	OFDM
Transfer Rate	802.11a: 54.0/ 48.0/ 36.0/ 24.0/ 18.0/ 12.0/ 9.0/ 6.0Mbps 802.11n: up to 450.0Mbps 802.11ac: up to 1.3Gbps
Operating Frequency	5180 ~ 5240MHz & 5745 ~ 5825MHz
Number of Channel	5180 ~ 5240MHz: 4 for 802.11a, 802.11n (HT20), 802.11ac (VHT20) 2 for 802.11n (HT40), 802.11ac (VHT40) 1 for 802.11ac (VHT80) 5745 ~ 5825MHz: 5 for 802.11a, 802.11n (HT20), 802.11ac (VHT20) 2 for 802.11n (HT40), 802.11ac (VHT40) 1 for 802.11ac (VHT80)
Output Power	5180 ~ 5240MHz: 299.276mW 5745 ~ 5825MHz: 513.511mW
Antenna Type	Dipole antenna with 7.0dBi gain
Antenna Connector	N-Type (The device is professionally installed)
Accessory Device	POE, Adapter
Data Cable Supplied	0.55m non-shielded RJ45 cable without core

**Note:**

- The EUT incorporates a MIMO function. Physically, the EUT provides 3 completed transmitters and 3 receivers.

Modulation Mode	TX Function
802.11a	3TX
802.11n (HT20)	3TX
802.11n (HT40)	3TX
802.11ac (VHT20)	3TX
802.11ac (VHT40)	3TX
802.11ac (VHT80)	3TX

\*The modulation and bandwidth are similar for 802.11n mode for 20MHz/40MHz and 802.11ac mode for 20MHz/40MHz, therefore investigated worst case to representative mode in test report. (Final test mode refer section 3.2.1)

- The EUT uses following PoE.

PoE	
Brand	EnGenius
Model	EPE-48GR
Power Rating	48Vdc, 0.8A, 38.4W Max

Adapter (For PoE)	
Brand	Powertron Electronics Corp.
Model	PA1040-480IB080
Input Power	100-240Vac, 50-60Hz, 1.5A
Output Power	48Vdc, 0.8A, 38.4W Max
Power Line	DC 1.6m power cable with 1 core attached on adapter

- The EUT will install at outdoor area, the highest antenna gain from the horizon above 30 degrees as below, for more detail information please refer to antenna specification and user manual

Antenna	Antenna gain	Antenna install degree
Dipole	-3.88 dBi	

- The above EUT information is declared by manufacturer and for more detailed features description, please refer to the manufacturer's specifications or user's manual.



### 3.2 Description of Test Modes

#### FOR 5180 ~ 5240MHz

4 channels are provided for 802.11a, 802.11n (HT20), 802.11ac (VHT20):

Channel	Frequency	Channel	Frequency
36	5180 MHz	44	5220 MHz
40	5200 MHz	48	5240 MHz

2 channels are provided for 802.11n (HT40), 802.11ac (VHT40):

Channel	Frequency	Channel	Frequency
38	5190 MHz	46	5230 MHz

1 channel is provided for 802.11ac (VHT80):

Channel	Frequency
42	5210 MHz

#### FOR 5745 ~ 5825MHz:

5 channels are provided for 802.11a, 802.11n (HT20), 802.11ac (VHT20):

Channel	Frequency	Channel	Frequency
149	5745 MHz	161	5805 MHz
153	5765 MHz	165	5825 MHz
157	5785 MHz		

2 channels are provided for 802.11n (HT40), 802.11ac (VHT40):

Channel	Frequency	Channel	Frequency
151	5755 MHz	159	5795 MHz

1 channel is provided for 802.11ac (VHT80):

Channel	Frequency
155	5775 MHz

### 3.2.1 Test Mode Applicability and Tested Channel Detail

EUT CONFIGURE MODE	APPLICABLE TO				DESCRIPTION
	RE≥1G	RE<1G	PLC	APCM	
-	√	√	√	√	-

Where **RE≥1G**: Radiated Emission above 1GHz      **RE<1G**: Radiated Emission below 1GHz  
**PLC**: Power Line Conducted Emission      **APCM**: Antenna Port Conducted Measurement

**NOTE:** The EUT had been pre-tested on the positioned of each 3 axis. The worst case was found when positioned on **Z-plane**.

#### Radiated Emission Test (Above 1GHz):

- Pre-Scan has been conducted to determine the worst-case mode from all possible combinations between available modulations, data rates and antenna ports (if EUT with antenna diversity architecture).
- Following channel(s) was (were) selected for the final test as listed below.

EUT CONFIGURE MODE	MODE	FREQ. BAND (MHz)	AVAILABLE CHANNEL	TESTED CHANNEL	MODULATION TECHNOLOGY	MODULATION TYPE	DATA RATE (Mbps)
-	802.11a	5180-5240	36 to 48	36, 40, 48	OFDM	BPSK	6.0
-	802.11n (HT20)		36 to 48	36, 40, 48	OFDM	BPSK	7.2
-	802.11n (HT40)		38 to 46	38, 46	OFDM	BPSK	15.0
-	802.11ac (VHT80)		42	42	OFDM	BPSK	97.5
-	802.11a	5745-5825	149 to 165	149, 157, 165	OFDM	BPSK	6.0
-	802.11n (HT20)		149 to 165	149, 157, 165	OFDM	BPSK	7.2
-	802.11n (HT40)		151 to 159	151, 159	OFDM	BPSK	15.0
-	802.11ac (VHT80)		155	155	OFDM	BPSK	97.5

#### Radiated Emission Test (Below 1GHz):

- Pre-Scan has been conducted to determine the worst-case mode from all possible combinations between available modulations, data rates and antenna ports (if EUT with antenna diversity architecture).
- Following channel(s) was (were) selected for the final test as listed below.

EUT CONFIGURE MODE	MODE	FREQ. BAND (MHz)	AVAILABLE CHANNEL	TESTED CHANNEL	MODULATION TECHNOLOGY	MODULATION TYPE	DATA RATE (Mbps)
-	802.11a	5180-5320 5745-5825	36 to 64 149 to 165	157	OFDM	BPSK	6.0

**Power Line Conducted Emission Test:**

- Pre-Scan has been conducted to determine the worst-case mode from all possible combinations between available modulations, data rates and antenna ports (if EUT with antenna diversity architecture).
- Following channel(s) was (were) selected for the final test as listed below.

EUT CONFIGURE MODE	MODE	FREQ. BAND (MHz)	AVAILABLE CHANNEL	TESTED CHANNEL	MODULATION TECHNOLOGY	MODULATION TYPE	DATA RATE (Mbps)
-	802.11a	5180-5320 5745-5825	36 to 64 149 to 165	157	OFDM	BPSK	6.0

**Antenna Port Conducted Measurement:**

- This item includes all test value of each mode, but only includes spectrum plot of worst value of each mode.
- Pre-Scan has been conducted to determine the worst-case mode from all possible combinations between available modulations, data rates and antenna ports (if EUT with antenna diversity architecture).
- Following channel(s) was (were) selected for the final test as listed below.

EUT CONFIGURE MODE	MODE	FREQ. BAND (MHz)	AVAILABLE CHANNEL	TESTED CHANNEL	MODULATION TECHNOLOGY	MODULATION TYPE	DATA RATE (Mbps)
-	802.11a	5180-5240	36 to 48	36, 40, 48	OFDM	BPSK	6.0
-	802.11n (HT20)		36 to 48	36, 40, 48	OFDM	BPSK	7.2
-	802.11n (HT40)		38 to 46	38, 46	OFDM	BPSK	15.0
-	802.11ac (VHT80)		42	42	OFDM	BPSK	97.5
-	802.11a	5745-5825	149 to 165	149, 157, 165	OFDM	BPSK	6.0
-	802.11n (HT20)		149 to 165	149, 157, 165	OFDM	BPSK	7.2
-	802.11n (HT40)		151 to 159	151, 159	OFDM	BPSK	15.0
-	802.11ac (VHT80)		155	155	OFDM	BPSK	97.5

**Test Condition:**

APPLICABLE TO	ENVIRONMENTAL CONDITIONS	INPUT POWER (POE)	TESTED BY
<b>RE<sub>≥</sub>1G</b>	21deg. C, 64%RH, 18deg. C, 77%RH, 19deg. C, 72%RH	48Vdc	Jones Chang
<b>RE<sub>&lt;</sub>1G</b>	16deg. C, 70%RH	48Vdc	Nick Hsu
<b>PLC</b>	16deg. C, 70%RH	48Vdc	Nick Hsu
<b>APCM</b>	25deg. C, 60%RH	48Vdc	Ted Chang

### 3.3 Duty Cycle of Test Signal

Duty cycle of test signal is < 98 %, duty factor is required

**802.11a:** Duty cycle =  $2.022/2.087 = 0.969$ , Duty factor =  $10 * \log(1/0.969) = 0.14$

**802.11n (HT20):** Duty cycle =  $1.875/1.955 = 0.959$ , Duty factor =  $10 * \log(1/0.959) = 0.18$

**802.11n (HT40):** Duty cycle =  $0.926/0.986 = 0.939$ , Duty factor =  $10 * \log(1/0.939) = 0.27$

**802.11ac (VHT80):** Duty cycle =  $4.140/4.228 = 0.979$ , Duty factor =  $10 * \log(1/0.979) = 0.09$

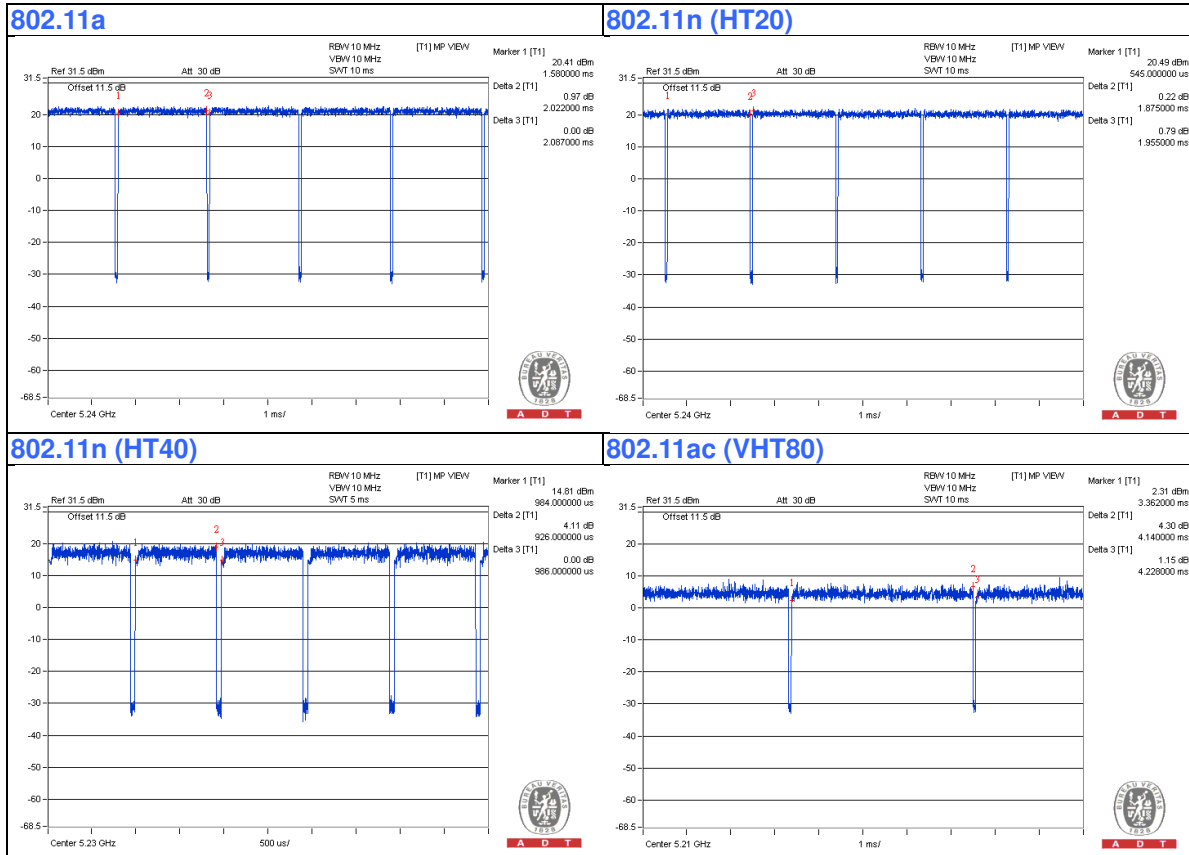

### 3.4 Description of Support Units

The EUT has been tested as an independent unit together with other necessary accessories or support units. The following support units or accessories were used to form a representative test configuration during the tests.

ID	Product	Brand	Model No.	Serial No.	FCC ID	Remarks
A.	Notebook	DELL	E5410	1HC2XM1	FCC DoC Approved	-
B.	Load	NA	NA	NA	NA	-

Note:

1. All power cords of the above support units are non-shielded (1.8m).
2. Item A acted as a communication partner to transfer data.

ID	Descriptions	Qty.	Length (m)	Shielding (Yes/No)	Cores (Qty.)	Remarks
1.	RJ45 cable	1	0.55	N	0	Accessory
2.	RJ45 cable	1	5	N	0	-
3.	RJ45 cable	1	1	N	0	-

#### 3.4.1 Configuration of System under Test

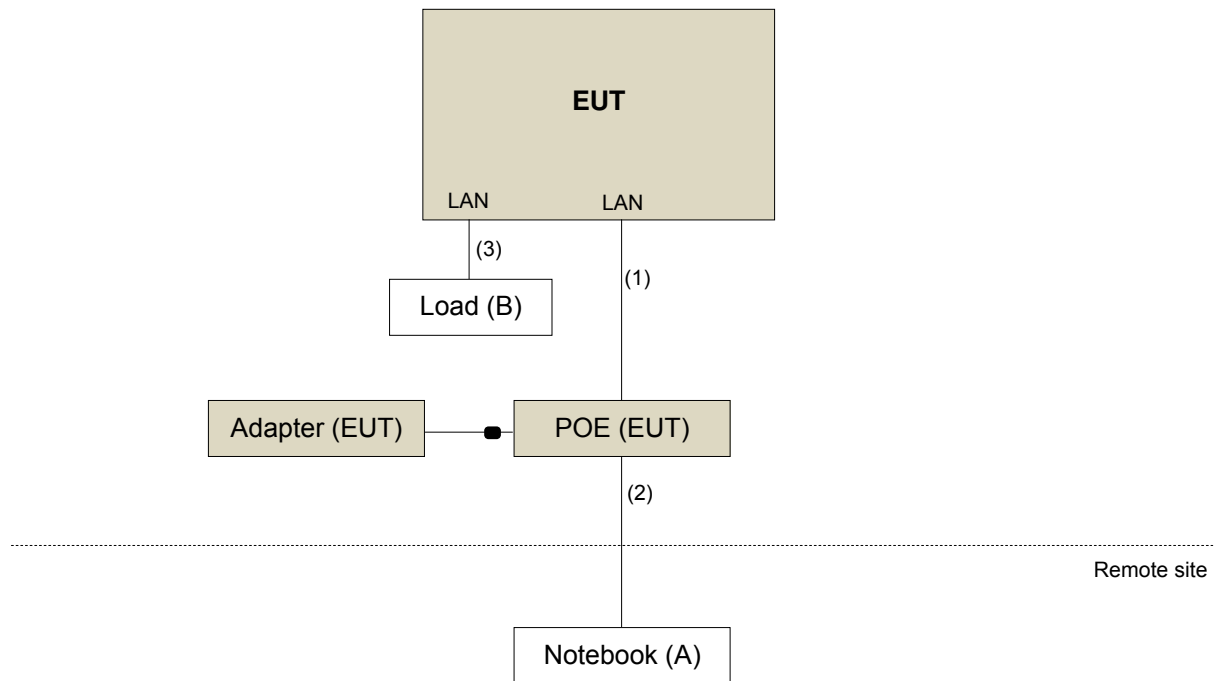

### 3.5 General Description of Applied Standard

The EUT is a RF Product. According to the specifications of the manufacturer, it must comply with the requirements of the following standards:

**FCC Part 15, Subpart E (15.407)**

**789033 D02 General UNII Test Procedure New Rules v01r02**

**662911 D01 Multiple Transmitter Output v02r01**

ANSI C63.10-2013

All test items have been performed and recorded as per the above standards.

**NOTE:** The EUT is also considered as a kind of computer peripheral, because the connection to computer is necessary for typical use. It has been verified to comply with the requirements of FCC Part 15, Subpart B, Class B (DoC). The test report has been issued separately.

## 4 Test Types and Results

### 4.1 Radiated Emission and Bandedge Measurement

#### 4.1.1 Limits of Radiated Emission and Bandedge Measurement

Radiated emissions which fall in the restricted bands must comply with the radiated emission limits specified as below table.

Frequencies (MHz)	Field Strength (microvolts/meter)	Measurement Distance (meters)
0.009 ~ 0.490	2400/F(kHz)	300
0.490 ~ 1.705	24000/F(kHz)	30
1.705 ~ 30.0	30	30
30 ~ 88	100	3
88 ~ 216	150	3
216 ~ 960	200	3
Above 960	500	3

#### NOTE:

1. The lower limit shall apply at the transition frequencies.
2. Emission level (dBuV/m) = 20 log Emission level (uV/m).
3. For frequencies above 1000MHz, the field strength limits are based on average detector, however, the peak field strength of any emission shall not exceed the maximum permitted average limits, specified above by more than 20dB under any Condition of modulation.

#### LIMITS OF UNWANTED EMISSION OUT OF THE RESTRICTED BANDS

APPLICABLE TO	LIMIT	
789033 D02 General UNII Test Procedure New Rules v01r02	FIELD STRENGTH AT 3m	
	PK:74 (dBuV/m)	AV:54 (dBuV/m)
APPLICABLE TO	EIRP LIMIT	EQUIVALENT FIELD STRENGTH AT 3m
15.407(b)(1)	PK:-27 (dBm/MHz)	PK:68.2 (dBuV/m)
15.407(b)(2)		
15.407(b)(3)		
15.407(b)(4)	PK:-27 (dBm/MHz) <sup>*1</sup> PK:-17 (dBm/MHz) <sup>*2</sup>	PK:68.2 (dBuV/m) <sup>*1</sup> PK:78.2 (dBuV/m) <sup>*2</sup>

**NOTE:** <sup>\*1</sup> beyond 10MHz of the band edge <sup>\*2</sup> within 10 MHz of band edge

The following formula is used to convert the equipment isotropic radiated power (eirp) to field strength:

$$E = \frac{1000000\sqrt{30P}}{3} \mu\text{V/m, where } P \text{ is the eirp (Watts).}$$



A D T

## 4.1.2 Test Instruments

Description & Manufacturer	Model No.	Serial No.	Cal. Date	Cal. Due
Test Receiver ROHDE & SCHWARZ	ESIB7	100187	Apr. 10, 2015	Apr. 09, 2016
Spectrum Analyzer ROHDE & SCHWARZ	FSP40	100041	Sep. 02, 2015	Sep. 01, 2016
BILOG Antenna SCHWARZBECK	VULB9168	9168-151	Jan. 07, 2016	Jan. 06, 2017
HORN Antenna SCHWARZBECK	9120D	209	Jan. 20, 2016	Jan. 19, 2017
HORN Antenna SCHWARZBECK	BBHA 9170	BBHA9170241	Jan. 18, 2016	Jan. 17, 2017
Preamplifier Agilent	8447D	2944A10738	Oct. 18, 2015	Oct. 17, 2016
Preamplifier Agilent	8449B	3008A01964	Aug. 22, 2015	Aug. 21, 2016
RF signal cable HUBER+SUHNER	SUCOFLEX 104	Cable-CH3-03 (214378)	Aug. 22, 2015	Aug. 21, 2016
RF signal cable HUBER+SUHNER	SUCOFLEX 106	Cable-CH3-03 (309224+12738)	Aug. 22, 2015	Aug. 21, 2016
Software BV ADT	ADT_Radiated_ V7.6.15.9.4	NA	NA	NA
Antenna Tower inn-co GmbH	MA 4000	013303	NA	NA
Antenna Tower Controller BV ADT	AT100	AT93021702	NA	NA
Turn Table BV ADT	TT100	TT93021702	NA	NA
Turn Table Controller BV ADT	SC100	SC93021702	NA	NA
26GHz ~ 40GHz Amplifier	EM26400	815221	Oct. 18, 2015	Oct. 17, 2016
High Speed Peak Power Meter	ML2495A	0824011	Jul. 09, 2015	Jul. 08, 2016
Power Sensor	MA2411B	0738171	Jul. 09, 2015	Jul. 08, 2016
WIT Standard Temperature And Humidity Chamber	TH-4S-C	W981030	Jun. 08, 2015	Jun. 07, 2016
Loop Antenna R&S	HFH2-Z2	100070	Mar. 06, 2014	Mar. 05, 2016

- Note:
1. The calibration interval of the above test instruments is 12 months and the calibrations are traceable to NML/ROC and NIST/USA.
  2. The calibration interval of the loop antenna is 24 months and the calibrations are traceable to NML/ROC and NIST/USA.
  3. The test was performed in HwaYa Chamber 3.
  4. The horn antenna and preamplifier (model: 8449B) are used only for the measurement of emission frequency above 1GHz if tested.
  5. The FCC Site Registration No. is 988962.
  6. The IC Site Registration No. is IC 7450F-3.



#### 4.1.3 Test Procedure

- a. The EUT was placed on the top of a rotating table 0.8 meters (for below 1GHz) / 1.5 meters (for above 1GHz) above the ground at 3 meter chamber room for test. The table was rotated 360 degrees to determine the position of the highest radiation.
- b. The EUT was set 3 meters away from the interference-receiving antenna, which was mounted on the top of a variable-height antenna tower.
- c. The height of antenna is varied from one meter to four meters above the ground to determine the maximum value of the field strength. Both horizontal and vertical polarizations of the antenna are set to make the measurement.
- d. For each suspected emission, the EUT was arranged to its worst case and then the antenna was tuned to heights from 1 meter to 4 meters and the rotatable table was turned from 0 degrees to 360 degrees to find the maximum reading.
- e. The test-receiver system was set to quasi-peak detect function and specified bandwidth with maximum hold mode when the test frequency is below 1 GHz.
- f. The test-receiver system was set to peak and average detect function and specified bandwidth with maximum hold mode when the test frequency is above 1 GHz. If the peak reading value also meets average limit, measurement with the average detector is unnecessary.

**Note:**

1. The resolution bandwidth and video bandwidth of test receiver/spectrum analyzer is 120kHz for Quasi-peak detection (QP) at frequency below 1GHz.
2. The resolution bandwidth of test receiver/spectrum analyzer is 1 MHz and the video bandwidth is 3 MHz for Peak detection (PK) at frequency above 1GHz.
3. The resolution bandwidth of test receiver/spectrum analyzer is 1MHz and the video bandwidth is 3MHz for RMS Average (Duty cycle < 98%) for Average detection (AV) at frequency above 1GHz, then the measurement results was added to a correction factor ( $10 \log(1/\text{duty cycle})$ ).
4. The resolution bandwidth of test receiver/spectrum analyzer is 1MHz and the video bandwidth is 10Hz (Duty cycle  $\geq 98\%$ ) for Average detection (AV) at frequency above 1GHz.
5. All modes of operation were investigated and the worst-case emissions are reported.

#### 4.1.4 Deviation from Test Standard

No deviation.

#### 4.1.5 Test Setup

<Frequency Range 30MHz~1GHz>

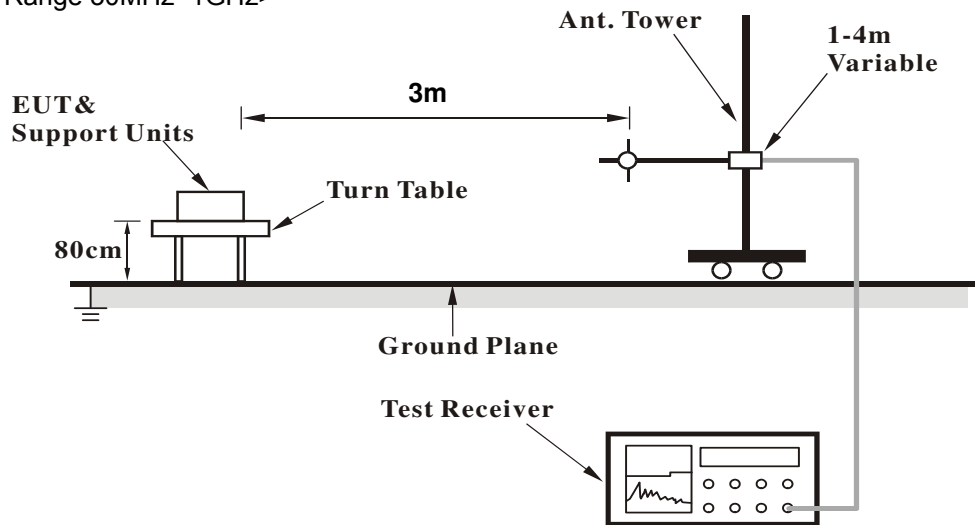

<Frequency Range above 1GHz>

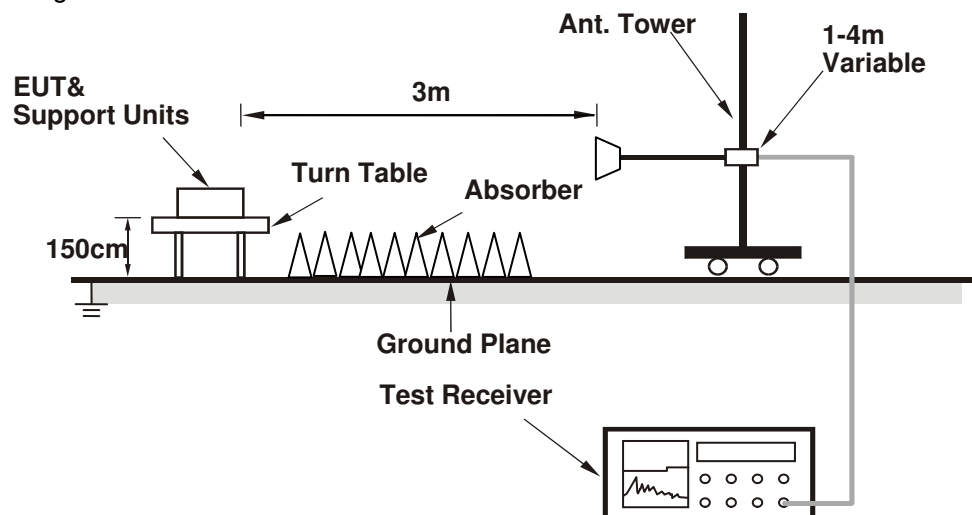

For the actual test configuration, please refer to the attached file (Test Setup Photo).

#### 4.1.6 EUT Operating Conditions

- a. Placed the EUT on the testing table.
- b. Prepared a notebook to act as a communication partner and placed it outside of testing area.
- c. The communication partner connected with EUT via a RJ45 cable and ran a test program (provided by manufacturer) to enable EUT under transmission condition continuously at specific channel frequency.
- d. The communication partner sent data to EUT by command "PING".



4.1.7 Test Results

**ABOVE 1GHz WORST-CASE DATA**

CHANNEL	TX Channel 40	DETECTOR FUNCTION	Peak (PK)
FREQUENCY RANGE	1GHz ~ 40GHz		Average (AV)

**ANTENNA POLARITY & TEST DISTANCE: HORIZONTAL AT 3 M**

NO.	FREQ. (MHz)	EMISSION LEVEL (dBuV/m)	LIMIT (dBuV/m)	MARGIN (dB)	ANTENNA HEIGHT (m)	TABLE ANGLE (Degree)	RAW VALUE (dBuV)	CORRECTION FACTOR (dB/m)
1	5150.00	59.1 PK	74.0	-14.9	1.56 H	58	53.10	6.00
2	5150.00	46.0 AV	54.0	-8.0	1.56 H	58	40.00	6.00
3	*5200.00	108.3 PK			1.76 H	149	68.80	39.50
4	*5200.00	98.3 AV			1.76 H	149	58.80	39.50
5	#10400.00	59.6 PK	74.0	-14.4	2.10 H	88	41.90	17.70
6	#10400.00	46.6 AV	54.0	-7.4	2.10 H	88	28.90	17.70

**ANTENNA POLARITY & TEST DISTANCE: VERTICAL AT 3 M**

NO.	FREQ. (MHz)	EMISSION LEVEL (dBuV/m)	LIMIT (dBuV/m)	MARGIN (dB)	ANTENNA HEIGHT (m)	TABLE ANGLE (Degree)	RAW VALUE (dBuV)	CORRECTION FACTOR (dB/m)
1	5150.00	71.8 PK	74.0	-2.2	1.85 V	84	65.80	6.00
2	5150.00	50.0 AV	54.0	-4.0	1.85 V	84	44.00	6.00
3	*5200.00	125.4 PK			1.86 V	73	85.90	39.50
4	*5200.00	115.0 AV			1.86 V	73	75.50	39.50
5	#10400.00	61.2 PK	74.0	-12.8	1.59 V	202	43.50	17.70
6	#10400.00	48.3 AV	54.0	-5.7	1.59 V	202	30.60	17.70

**REMARKS:**

1. Emission Level(dBuV/m) = Raw Value(dBuV) + Correction Factor(dB/m)
2. Correction Factor(dB/m) = Antenna Factor(dB/m) + Cable Factor(dB)
3. The other emission levels were very low against the limit.
4. Margin value = Emission Level – Limit value
5. " \* ": Fundamental frequency.
6. " # ": The radiated frequency is out of the restricted band.

CHANNEL	TX Channel 48	DETECTOR FUNCTION	Peak (PK)
FREQUENCY RANGE	1GHz ~ 40GHz		Average (AV)

**ANTENNA POLARITY & TEST DISTANCE: HORIZONTAL AT 3 M**

NO.	FREQ. (MHz)	EMISSION LEVEL (dBuV/m)	LIMIT (dBuV/m)	MARGIN (dB)	ANTENNA HEIGHT (m)	TABLE ANGLE (Degree)	RAW VALUE (dBuV)	CORRECTION FACTOR (dB/m)
1	*5240.00	109.1 PK			1.75 H	148	69.50	39.60
2	*5240.00	98.5 AV			1.75 H	148	58.90	39.60
3	5350.00	57.6 PK	74.0	-16.4	2.00 H	148	51.10	6.50
4	5350.00	45.6 AV	54.0	-8.4	2.00 H	148	39.10	6.50
5	#10480.00	61.5 PK	74.0	-12.5	1.60 H	249	42.80	18.70
6	#10480.00	48.6 AV	54.0	-5.4	1.60 H	249	29.90	18.70

**ANTENNA POLARITY & TEST DISTANCE: VERTICAL AT 3 M**

NO.	FREQ. (MHz)	EMISSION LEVEL (dBuV/m)	LIMIT (dBuV/m)	MARGIN (dB)	ANTENNA HEIGHT (m)	TABLE ANGLE (Degree)	RAW VALUE (dBuV)	CORRECTION FACTOR (dB/m)
1	*5240.00	124.5 PK			1.98 V	69	84.90	39.60
2	*5240.00	114.1 AV			1.98 V	69	74.50	39.60
3	5370.00	64.0 PK	74.0	-10.0	1.86 V	76	57.40	6.60
4	5370.00	50.7 AV	54.0	-3.3	1.86 V	76	44.10	6.60
5	#10480.00	62.1 PK	74.0	-11.9	1.68 V	343	43.40	18.70
6	#10480.00	49.2 AV	54.0	-4.8	1.68 V	343	30.50	18.70

**REMARKS:**

1. Emission Level(dBuV/m) = Raw Value(dBuV) + Correction Factor(dB/m)
2. Correction Factor(dB/m) = Antenna Factor(dB/m) + Cable Factor(dB)
3. The other emission levels were very low against the limit.
4. Margin value = Emission Level – Limit value
5. " \* ": Fundamental frequency.
6. " # ": The radiated frequency is out of the restricted band.

CHANNEL	TX Channel 149	DETECTOR FUNCTION	Peak (PK)
FREQUENCY RANGE	1GHz ~ 40GHz		Average (AV)

**ANTENNA POLARITY & TEST DISTANCE: HORIZONTAL AT 3 M**

NO.	FREQ. (MHz)	EMISSION LEVEL (dBuV/m)	LIMIT (dBuV/m)	MARGIN (dB)	ANTENNA HEIGHT (m)	TABLE ANGLE (Degree)	RAW VALUE (dBuV)	CORRECTION FACTOR (dB/m)
1	#5714.00	59.5 PK	74.0	-14.5	1.98 H	12	52.10	7.40
2	#5714.00	47.2 AV	54.0	-6.8	1.98 H	12	39.80	7.40
3	#5722.00	59.9 PK	78.2	-18.3	2.00 H	0	52.50	7.40
4	#5725.00	49.8 PK	78.2	-28.4	2.00 H	0	42.40	7.40
5	*5745.00	103.6 PK			2.31 H	214	63.10	40.50
6	*5745.00	93.6 AV			2.31 H	214	53.10	40.50
7	11490.00	60.6 PK	74.0	-13.4	1.88 H	216	41.90	18.70
8	11490.00	47.7 AV	54.0	-6.3	1.88 H	216	29.00	18.70

**ANTENNA POLARITY & TEST DISTANCE: VERTICAL AT 3 M**

NO.	FREQ. (MHz)	EMISSION LEVEL (dBuV/m)	LIMIT (dBuV/m)	MARGIN (dB)	ANTENNA HEIGHT (m)	TABLE ANGLE (Degree)	RAW VALUE (dBuV)	CORRECTION FACTOR (dB/m)
1	#5714.90	70.2 PK	74.0	-3.8	1.10 V	218	62.80	7.40
2	#5714.90	52.4 AV	54.0	-1.6	1.10 V	218	45.00	7.40
3	#5722.00	75.8 PK	78.2	-2.4	1.09 V	299	68.40	7.40
4	#5725.00	64.9 PK	78.2	-13.3	1.09 V	299	57.50	7.40
5	*5745.00	117.9 PK			1.06 V	222	77.40	40.50
6	*5745.00	108.3 AV			1.06 V	222	67.80	40.50
7	11490.00	61.2 PK	74.0	-12.8	2.09 V	199	42.50	18.70
8	11490.00	48.3 AV	54.0	-5.7	2.09 V	199	29.60	18.70

**REMARKS:**

1. Emission Level(dBuV/m) = Raw Value(dBuV) + Correction Factor(dB/m)
2. Correction Factor(dB/m) = Antenna Factor(dB/m) + Cable Factor(dB)
3. The other emission levels were very low against the limit.
4. Margin value = Emission Level – Limit value
5. " \* ": Fundamental frequency.
6. " # ": The radiated frequency is out of the restricted band.

CHANNEL	TX Channel 157	DETECTOR FUNCTION	Peak (PK)
FREQUENCY RANGE	1GHz ~ 40GHz		Average (AV)

**ANTENNA POLARITY & TEST DISTANCE: HORIZONTAL AT 3 M**

NO.	FREQ. (MHz)	EMISSION LEVEL (dBuV/m)	LIMIT (dBuV/m)	MARGIN (dB)	ANTENNA HEIGHT (m)	TABLE ANGLE (Degree)	RAW VALUE (dBuV)	CORRECTION FACTOR (dB/m)
1	#5580.00	60.3 PK	74.0	-13.7	1.80 H	305	53.20	7.10
2	#5580.00	48.9 AV	54.0	-5.1	1.80 H	305	41.80	7.10
3	*5785.00	108.3 PK			2.38 H	214	67.70	40.60
4	*5785.00	97.5 AV			2.38 H	214	56.90	40.60
5	11570.00	60.5 PK	74.0	-13.5	1.56 H	83	41.80	18.70
6	11570.00	47.6 AV	54.0	-6.4	1.56 H	83	28.90	18.70

**ANTENNA POLARITY & TEST DISTANCE: VERTICAL AT 3 M**

NO.	FREQ. (MHz)	EMISSION LEVEL (dBuV/m)	LIMIT (dBuV/m)	MARGIN (dB)	ANTENNA HEIGHT (m)	TABLE ANGLE (Degree)	RAW VALUE (dBuV)	CORRECTION FACTOR (dB/m)
1	#5712.20	70.8 PK	74.0	-3.2	1.00 V	297	63.40	7.40
2	#5712.20	52.5 AV	54.0	-1.5	1.00 V	297	45.10	7.40
3	*5785.00	122.5 PK			1.14 V	216	81.90	40.60
4	*5785.00	112.0 AV			1.14 V	216	71.40	40.60
5	11570.00	62.4 PK	74.0	-11.6	3.24 V	0	43.70	18.70
6	11570.00	50.7 AV	54.0	-3.3	3.24 V	0	32.00	18.70

**REMARKS:**

1. Emission Level(dBuV/m) = Raw Value(dBuV) + Correction Factor(dB/m)
2. Correction Factor(dB/m) = Antenna Factor(dB/m) + Cable Factor(dB)
3. The other emission levels were very low against the limit.
4. Margin value = Emission Level – Limit value
5. " \* ": Fundamental frequency.
6. " # ": The radiated frequency is out of the restricted band.

CHANNEL	TX Channel 165	DETECTOR FUNCTION	Peak (PK)
FREQUENCY RANGE	1GHz ~ 40GHz		Average (AV)

**ANTENNA POLARITY & TEST DISTANCE: HORIZONTAL AT 3 M**

NO.	FREQ. (MHz)	EMISSION LEVEL (dBuV/m)	LIMIT (dBuV/m)	MARGIN (dB)	ANTENNA HEIGHT (m)	TABLE ANGLE (Degree)	RAW VALUE (dBuV)	CORRECTION FACTOR (dB/m)
1	*5825.00	104.0 PK			2.31 H	219	63.40	40.60
2	*5825.00	93.7 AV			2.31 H	219	53.10	40.60
3	#5850.00	51.0 PK	78.2	-27.2	1.89 H	233	43.40	7.60
4	#5853.00	59.4 PK	78.2	-18.8	1.89 H	233	51.70	7.70
5	#5861.00	58.3 PK	74.0	-15.7	1.98 H	263	50.60	7.70
6	#5861.00	46.8 AV	54.0	-7.2	1.98 H	263	39.10	7.70
7	11650.00	60.7 PK	74.0	-13.3	1.60 H	42	41.50	19.20
8	11650.00	47.8 AV	54.0	-6.2	1.60 H	42	28.60	19.20

**ANTENNA POLARITY & TEST DISTANCE: VERTICAL AT 3 M**

NO.	FREQ. (MHz)	EMISSION LEVEL (dBuV/m)	LIMIT (dBuV/m)	MARGIN (dB)	ANTENNA HEIGHT (m)	TABLE ANGLE (Degree)	RAW VALUE (dBuV)	CORRECTION FACTOR (dB/m)
1	*5825.00	120.0 PK			1.00 V	218	79.40	40.60
2	*5825.00	109.3 AV			1.00 V	218	68.70	40.60
3	#5850.00	62.0 PK	78.2	-16.2	1.40 V	211	54.40	7.60
4	#5853.00	73.3 PK	78.2	-4.9	1.40 V	211	65.60	7.70
5	#5860.10	68.9 PK	74.0	-5.1	1.24 V	81	61.20	7.70
6	#5860.10	52.2 AV	54.0	-1.8	1.24 V	81	44.50	7.70
7	11650.00	62.4 PK	74.0	-11.6	2.95 V	359	43.20	19.20
8	11650.00	48.8 AV	54.0	-5.2	2.95 V	359	29.60	19.20

**REMARKS:**

1. Emission Level(dBuV/m) = Raw Value(dBuV) + Correction Factor(dB/m)
2. Correction Factor(dB/m) = Antenna Factor(dB/m) + Cable Factor(dB)
3. The other emission levels were very low against the limit.
4. Margin value = Emission Level – Limit value
5. " \* ": Fundamental frequency.
6. " # ": The radiated frequency is out of the restricted band.



**802.11n (HT20)**

CHANNEL	TX Channel 36	DETECTOR FUNCTION	Peak (PK)
FREQUENCY RANGE	1GHz ~ 40GHz		Average (AV)

ANTENNA POLARITY & TEST DISTANCE: HORIZONTAL AT 3 M								
NO.	FREQ. (MHz)	EMISSION LEVEL (dBuV/m)	LIMIT (dBuV/m)	MARGIN (dB)	ANTENNA HEIGHT (m)	TABLE ANGLE (Degree)	RAW VALUE (dBuV)	CORRECTION FACTOR (dB/m)
1	5150.00	56.6 PK	74.0	-17.4	1.79 H	83	50.60	6.00
2	5150.00	45.1 AV	54.0	-8.9	1.79 H	83	39.10	6.00
3	*5180.00	104.9 PK			1.95 H	150	65.50	39.40
4	*5180.00	94.3 AV			1.95 H	150	54.90	39.40
5	#10360.00	59.2 PK	74.0	-14.8	2.11 H	144	41.40	17.80
6	#10360.00	46.2 AV	54.0	-7.8	2.11 H	144	28.40	17.80

ANTENNA POLARITY & TEST DISTANCE: VERTICAL AT 3 M								
NO.	FREQ. (MHz)	EMISSION LEVEL (dBuV/m)	LIMIT (dBuV/m)	MARGIN (dB)	ANTENNA HEIGHT (m)	TABLE ANGLE (Degree)	RAW VALUE (dBuV)	CORRECTION FACTOR (dB/m)
1	5150.00	72.0 PK	74.0	-2.0	1.92 V	104	66.00	6.00
2	5150.00	52.7 AV	54.0	-1.3	1.92 V	104	46.70	6.00
3	*5180.00	120.9 PK			2.03 V	76	81.50	39.40
4	*5180.00	110.7 AV			2.03 V	76	71.30	39.40
5	#10360.00	59.8 PK	74.0	-14.2	1.80 V	200	42.00	17.80
6	#10360.00	47.0 AV	54.0	-7.0	1.80 V	200	29.20	17.80

**REMARKS:**

1. Emission Level(dBuV/m) = Raw Value(dBuV) + Correction Factor(dB/m)
2. Correction Factor(dB/m) = Antenna Factor(dB/m) + Cable Factor(dB)
3. The other emission levels were very low against the limit.
4. Margin value = Emission Level – Limit value
5. " \* ": Fundamental frequency.
6. " # ": The radiated frequency is out of the restricted band.

CHANNEL	TX Channel 40	DETECTOR FUNCTION	Peak (PK)
FREQUENCY RANGE	1GHz ~ 40GHz		Average (AV)

**ANTENNA POLARITY & TEST DISTANCE: HORIZONTAL AT 3 M**

NO.	FREQ. (MHz)	EMISSION LEVEL (dBuV/m)	LIMIT (dBuV/m)	MARGIN (dB)	ANTENNA HEIGHT (m)	TABLE ANGLE (Degree)	RAW VALUE (dBuV)	CORRECTION FACTOR (dB/m)
1	*5200.00	107.3 PK			1.86 H	109	67.80	39.50
2	*5200.00	97.3 AV			1.86 H	109	57.80	39.50
3	#10400.00	59.5 PK	74.0	-14.5	1.95 H	120	41.80	17.70
4	#10400.00	46.5 AV	54.0	-7.5	1.95 H	120	28.80	17.70

**ANTENNA POLARITY & TEST DISTANCE: VERTICAL AT 3 M**

NO.	FREQ. (MHz)	EMISSION LEVEL (dBuV/m)	LIMIT (dBuV/m)	MARGIN (dB)	ANTENNA HEIGHT (m)	TABLE ANGLE (Degree)	RAW VALUE (dBuV)	CORRECTION FACTOR (dB/m)
1	5150.00	72.3 PK	74.0	-1.7	2.08 V	85	66.30	6.00
2	5150.00	51.5 AV	54.0	-2.5	2.08 V	85	45.50	6.00
3	*5200.00	124.4 PK			2.05 V	83	84.90	39.50
4	*5200.00	114.2 AV			2.05 V	83	74.70	39.50
5	#10400.00	60.4 PK	74.0	-13.6	1.80 V	143	42.70	17.70
6	#10400.00	47.5 AV	54.0	-6.5	1.80 V	143	29.80	17.70

**REMARKS:**

1. Emission Level(dBuV/m) = Raw Value(dBuV) + Correction Factor(dB/m)
2. Correction Factor(dB/m) = Antenna Factor(dB/m) + Cable Factor(dB)
3. The other emission levels were very low against the limit.
4. Margin value = Emission Level – Limit value
5. " \* ": Fundamental frequency.
6. " # ": The radiated frequency is out of the restricted band.



CHANNEL	TX Channel 48	DETECTOR FUNCTION	Peak (PK)
FREQUENCY RANGE	1GHz ~ 40GHz		Average (AV)

**ANTENNA POLARITY & TEST DISTANCE: HORIZONTAL AT 3 M**

NO.	FREQ. (MHz)	EMISSION LEVEL (dBuV/m)	LIMIT (dBuV/m)	MARGIN (dB)	ANTENNA HEIGHT (m)	TABLE ANGLE (Degree)	RAW VALUE (dBuV)	CORRECTION FACTOR (dB/m)
1	*5240.00	109.3 PK			1.99 H	149	69.70	39.60
2	*5240.00	98.7 AV			1.99 H	149	59.10	39.60
3	5350.00	59.8 PK	74.0	-14.2	1.99 H	89	53.30	6.50
4	5350.00	46.8 AV	54.0	-7.2	1.99 H	89	40.30	6.50
5	#10480.00	60.7 PK	74.0	-13.3	1.58 H	77	42.00	18.70
6	#10480.00	47.8 AV	54.0	-6.2	1.58 H	77	29.10	18.70

**ANTENNA POLARITY & TEST DISTANCE: VERTICAL AT 3 M**

NO.	FREQ. (MHz)	EMISSION LEVEL (dBuV/m)	LIMIT (dBuV/m)	MARGIN (dB)	ANTENNA HEIGHT (m)	TABLE ANGLE (Degree)	RAW VALUE (dBuV)	CORRECTION FACTOR (dB/m)
1	*5240.00	124.0 PK			2.03 V	86	84.40	39.60
2	*5240.00	113.5 AV			2.03 V	86	73.90	39.60
3	5350.00	64.0 PK	74.0	-10.0	1.90 V	114	57.50	6.50
4	5350.00	49.3 AV	54.0	-4.7	1.90 V	114	42.80	6.50
5	#10400.00	60.6 PK	74.0	-13.4	1.69 V	345	42.90	17.70
6	#10400.00	47.7 AV	54.0	-6.3	1.69 V	345	30.00	17.70

**REMARKS:**

1. Emission Level(dBuV/m) = Raw Value(dBuV) + Correction Factor(dB/m)
2. Correction Factor(dB/m) = Antenna Factor(dB/m) + Cable Factor(dB)
3. The other emission levels were very low against the limit.
4. Margin value = Emission Level – Limit value
5. " \* ": Fundamental frequency.
6. " # ": The radiated frequency is out of the restricted band.

CHANNEL	TX Channel 149	DETECTOR FUNCTION	Peak (PK)
FREQUENCY RANGE	1GHz ~ 40GHz		Average (AV)

**ANTENNA POLARITY & TEST DISTANCE: HORIZONTAL AT 3 M**

NO.	FREQ. (MHz)	EMISSION LEVEL (dBuV/m)	LIMIT (dBuV/m)	MARGIN (dB)	ANTENNA HEIGHT (m)	TABLE ANGLE (Degree)	RAW VALUE (dBuV)	CORRECTION FACTOR (dB/m)
1	#5714.00	57.5 PK	74.0	-16.5	2.14 H	27	50.10	7.40
2	#5714.00	46.0 AV	54.0	-8.0	2.14 H	27	38.60	7.40
3	#5722.00	59.1 PK	78.2	-19.1	2.09 H	88	51.70	7.40
4	#5725.00	50.1 PK	78.2	-28.1	2.09 H	88	42.70	7.40
5	*5745.00	106.3 PK			2.45 H	196	65.80	40.50
6	*5745.00	95.8 AV			2.45 H	196	55.30	40.50
7	11490.00	60.9 PK	74.0	-13.1	1.77 H	123	42.20	18.70
8	11490.00	47.7 AV	54.0	-6.3	1.77 H	123	29.00	18.70

**ANTENNA POLARITY & TEST DISTANCE: VERTICAL AT 3 M**

NO.	FREQ. (MHz)	EMISSION LEVEL (dBuV/m)	LIMIT (dBuV/m)	MARGIN (dB)	ANTENNA HEIGHT (m)	TABLE ANGLE (Degree)	RAW VALUE (dBuV)	CORRECTION FACTOR (dB/m)
1	#5714.90	70.6 PK	74.0	-3.4	1.05 V	216	63.20	7.40
2	#5714.90	52.9 AV	54.0	-1.1	1.05 V	216	45.50	7.40
3	#5722.00	74.3 PK	78.2	-3.9	1.00 V	326	66.90	7.40
4	#5725.00	61.9 PK	78.2	-16.3	1.00 V	326	54.50	7.40
5	*5745.00	117.2 PK			1.07 V	327	76.70	40.50
6	*5745.00	106.9 AV			1.07 V	327	66.40	40.50
7	11490.00	61.0 PK	74.0	-13.0	1.55 V	212	42.30	18.70
8	11490.00	47.9 AV	54.0	-6.1	1.55 V	212	29.20	18.70

**REMARKS:**

1. Emission Level(dBuV/m) = Raw Value(dBuV) + Correction Factor(dB/m)
2. Correction Factor(dB/m) = Antenna Factor(dB/m) + Cable Factor(dB)
3. The other emission levels were very low against the limit.
4. Margin value = Emission Level – Limit value
5. " \* ": Fundamental frequency.
6. " # ": The radiated frequency is out of the restricted band.



CHANNEL	TX Channel 157	DETECTOR FUNCTION	Peak (PK)
FREQUENCY RANGE	1GHz ~ 40GHz		Average (AV)

ANTENNA POLARITY & TEST DISTANCE: HORIZONTAL AT 3 M

NO.	FREQ. (MHz)	EMISSION LEVEL (dBuV/m)	LIMIT (dBuV/m)	MARGIN (dB)	ANTENNA HEIGHT (m)	TABLE ANGLE (Degree)	RAW VALUE (dBuV)	CORRECTION FACTOR (dB/m)
1	*5785.00	107.0 PK			2.16 H	143	66.40	40.60
2	*5785.00	95.9 AV			2.16 H	143	55.30	40.60
3	11570.00	61.7 PK	74.0	-12.3	2.00 H	8	43.00	18.70
4	11570.00	49.0 AV	54.0	-5.0	2.00 H	8	30.30	18.70

ANTENNA POLARITY & TEST DISTANCE: VERTICAL AT 3 M

NO.	FREQ. (MHz)	EMISSION LEVEL (dBuV/m)	LIMIT (dBuV/m)	MARGIN (dB)	ANTENNA HEIGHT (m)	TABLE ANGLE (Degree)	RAW VALUE (dBuV)	CORRECTION FACTOR (dB/m)
1	#5714.90	70.1 PK	74.0	-3.9	1.26 V	299	62.70	7.40
2	#5714.90	52.1 AV	54.0	-1.9	1.26 V	299	44.70	7.40
3	*5785.00	123.8 PK			1.08 V	297	83.20	40.60
4	*5785.00	113.1 AV			1.08 V	297	72.50	40.60
5	11570.00	62.2 PK	74.0	-11.8	3.23 V	359	43.50	18.70
6	11570.00	49.5 AV	54.0	-4.5	3.23 V	359	30.80	18.70

REMARKS:

1. Emission Level(dBuV/m) = Raw Value(dBuV) + Correction Factor(dB/m)
2. Correction Factor(dB/m) = Antenna Factor(dB/m) + Cable Factor(dB)
3. The other emission levels were very low against the limit.
4. Margin value = Emission Level – Limit value
5. " \* ": Fundamental frequency.
6. " # ": The radiated frequency is out of the restricted band.



CHANNEL	TX Channel 165	DETECTOR FUNCTION	Peak (PK)
FREQUENCY RANGE	1GHz ~ 40GHz		Average (AV)

**ANTENNA POLARITY & TEST DISTANCE: HORIZONTAL AT 3 M**

NO.	FREQ. (MHz)	EMISSION LEVEL (dBuV/m)	LIMIT (dBuV/m)	MARGIN (dB)	ANTENNA HEIGHT (m)	TABLE ANGLE (Degree)	RAW VALUE (dBuV)	CORRECTION FACTOR (dB/m)
1	*5825.00	105.4 PK			2.48 H	193	64.80	40.60
2	*5825.00	95.1 AV			2.48 H	193	54.50	40.60
3	#5850.00	50.2 PK	78.2	-28.0	2.01 H	322	42.60	7.60
4	#5853.00	59.8 PK	78.2	-18.4	2.00 H	322	52.10	7.70
5	#5861.00	58.1 PK	74.0	-15.9	1.97 H	316	50.40	7.70
6	#5861.00	46.8 AV	54.0	-7.2	1.97 H	316	39.10	7.70
7	11650.00	61.5 PK	74.0	-12.5	1.91 H	245	42.30	19.20
8	11650.00	48.3 AV	54.0	-5.7	1.91 H	245	29.10	19.20

**ANTENNA POLARITY & TEST DISTANCE: VERTICAL AT 3 M**

NO.	FREQ. (MHz)	EMISSION LEVEL (dBuV/m)	LIMIT (dBuV/m)	MARGIN (dB)	ANTENNA HEIGHT (m)	TABLE ANGLE (Degree)	RAW VALUE (dBuV)	CORRECTION FACTOR (dB/m)
1	*5825.00	120.2 PK			1.00 V	296	79.60	40.60
2	*5825.00	110.0 AV			1.00 V	296	69.40	40.60
3	#5850.00	49.5 PK	78.2	-28.7	1.18 V	78	41.90	7.60
4	#5853.00	71.5 PK	78.2	-6.7	1.18 V	78	63.80	7.70
5	#5860.10	68.4 PK	74.0	-5.6	1.26 V	265	60.70	7.70
6	#5860.10	52.3 AV	54.0	-1.7	1.26 V	265	44.60	7.70
7	11650.00	61.8 PK	74.0	-12.2	1.76 V	185	42.60	19.20
8	11650.00	48.7 AV	54.0	-5.3	1.76 V	185	29.50	19.20

**REMARKS:**

1. Emission Level(dBuV/m) = Raw Value(dBuV) + Correction Factor(dB/m)
2. Correction Factor(dB/m) = Antenna Factor(dB/m) + Cable Factor(dB)
3. The other emission levels were very low against the limit.
4. Margin value = Emission Level – Limit value
5. " \* ": Fundamental frequency.
6. " # ": The radiated frequency is out of the restricted band.

**802.11n (HT40)**

CHANNEL	TX Channel 38	DETECTOR FUNCTION	Peak (PK)
FREQUENCY RANGE	1GHz ~ 40GHz		Average (AV)

ANTENNA POLARITY & TEST DISTANCE: HORIZONTAL AT 3 M								
NO.	FREQ. (MHz)	EMISSION LEVEL (dBuV/m)	LIMIT (dBuV/m)	MARGIN (dB)	ANTENNA HEIGHT (m)	TABLE ANGLE (Degree)	RAW VALUE (dBuV)	CORRECTION FACTOR (dB/m)
1	5150.00	46.9 PK	74.0	-27.1	1.97 H	150	40.90	6.00
2	5150.00	44.1 AV	54.0	-9.9	1.97 H	150	38.10	6.00
3	*5190.00	99.7 PK			1.97 H	81	60.30	39.40
4	*5190.00	90.0 AV			1.97 H	81	50.60	39.40
5	#10380.00	58.3 PK	74.0	-15.7	1.80 H	344	40.60	17.70
6	#10380.00	45.5 AV	54.0	-8.5	1.80 H	344	27.80	17.70

ANTENNA POLARITY & TEST DISTANCE: VERTICAL AT 3 M								
NO.	FREQ. (MHz)	EMISSION LEVEL (dBuV/m)	LIMIT (dBuV/m)	MARGIN (dB)	ANTENNA HEIGHT (m)	TABLE ANGLE (Degree)	RAW VALUE (dBuV)	CORRECTION FACTOR (dB/m)
1	5150.00	68.0 PK	74.0	-6.0	1.95 V	140	62.00	6.00
2	5150.00	52.8 AV	54.0	-1.2	1.95 V	140	46.80	6.00
3	*5190.00	112.4 PK			1.88 V	103	73.00	39.40
4	*5190.00	102.9 AV			1.88 V	103	63.50	39.40
5	#10380.00	59.3 PK	74.0	-14.7	1.75 V	150	41.60	17.70
6	#10380.00	46.3 AV	54.0	-7.7	1.75 V	150	28.60	17.70

**REMARKS:**

1. Emission Level(dBuV/m) = Raw Value(dBuV) + Correction Factor(dB/m)
2. Correction Factor(dB/m) = Antenna Factor(dB/m) + Cable Factor(dB)
3. The other emission levels were very low against the limit.
4. Margin value = Emission Level – Limit value
5. " \* ": Fundamental frequency.
6. " # ": The radiated frequency is out of the restricted band.



CHANNEL	TX Channel 46	DETECTOR FUNCTION	Peak (PK)
FREQUENCY RANGE	1GHz ~ 40GHz		Average (AV)

**ANTENNA POLARITY & TEST DISTANCE: HORIZONTAL AT 3 M**

NO.	FREQ. (MHz)	EMISSION LEVEL (dBuV/m)	LIMIT (dBuV/m)	MARGIN (dB)	ANTENNA HEIGHT (m)	TABLE ANGLE (Degree)	RAW VALUE (dBuV)	CORRECTION FACTOR (dB/m)
1	*5230.00	107.1 PK			1.96 H	85	67.50	39.60
2	*5230.00	97.6 AV			1.96 H	85	58.00	39.60
3	5400.00	57.2 PK	74.0	-16.8	1.99 H	78	50.50	6.70
4	5400.00	46.3 AV	54.0	-7.7	1.99 H	78	39.60	6.70
5	#10460.00	58.8 PK	74.0	-15.2	2.12 H	169	40.30	18.50
6	#10460.00	45.7 AV	54.0	-8.3	2.12 H	169	27.20	18.50

**ANTENNA POLARITY & TEST DISTANCE: VERTICAL AT 3 M**

NO.	FREQ. (MHz)	EMISSION LEVEL (dBuV/m)	LIMIT (dBuV/m)	MARGIN (dB)	ANTENNA HEIGHT (m)	TABLE ANGLE (Degree)	RAW VALUE (dBuV)	CORRECTION FACTOR (dB/m)
1	5150.00	69.3 PK	74.0	-4.7	1.95 V	77	63.30	6.00
2	5150.00	52.2 AV	54.0	-1.8	1.95 V	77	46.20	6.00
3	*5230.00	120.9 PK			1.93 V	86	81.30	39.60
4	*5230.00	111.5 AV			1.93 V	86	71.90	39.60
5	#10460.00	60.2 PK	74.0	-13.8	1.66 V	193	41.70	18.50
6	#10460.00	47.0 AV	54.0	-7.0	1.66 V	193	28.50	18.50

**REMARKS:**

1. Emission Level(dBuV/m) = Raw Value(dBuV) + Correction Factor(dB/m)
2. Correction Factor(dB/m) = Antenna Factor(dB/m) + Cable Factor(dB)
3. The other emission levels were very low against the limit.
4. Margin value = Emission Level – Limit value
5. " \* ": Fundamental frequency.
6. " # ": The radiated frequency is out of the restricted band.



CHANNEL	TX Channel 151	DETECTOR FUNCTION	Peak (PK)
FREQUENCY RANGE	1GHz ~ 40GHz		Average (AV)

**ANTENNA POLARITY & TEST DISTANCE: HORIZONTAL AT 3 M**

NO.	FREQ. (MHz)	EMISSION LEVEL (dBuV/m)	LIMIT (dBuV/m)	MARGIN (dB)	ANTENNA HEIGHT (m)	TABLE ANGLE (Degree)	RAW VALUE (dBuV)	CORRECTION FACTOR (dB/m)
1	#5714.00	56.9 PK	74.0	-17.1	2.44 H	231	49.50	7.40
2	#5714.00	45.9 AV	54.0	-8.1	2.44 H	231	38.50	7.40
3	#5722.00	66.7 PK	78.2	-11.5	2.54 H	249	59.30	7.40
4	#5725.00	56.9 PK	78.2	-21.3	2.54 H	249	49.50	7.40
5	*5755.00	99.0 PK			2.68 H	240	58.40	40.60
6	*5755.00	89.3 AV			2.68 H	240	48.70	40.60
7	11510.00	60.1 PK	74.0	-13.9	2.11 H	320	41.40	18.70
8	11510.00	46.9 AV	54.0	-7.1	2.11 H	320	28.20	18.70

**ANTENNA POLARITY & TEST DISTANCE: VERTICAL AT 3 M**

NO.	FREQ. (MHz)	EMISSION LEVEL (dBuV/m)	LIMIT (dBuV/m)	MARGIN (dB)	ANTENNA HEIGHT (m)	TABLE ANGLE (Degree)	RAW VALUE (dBuV)	CORRECTION FACTOR (dB/m)
1	#5714.90	66.5 PK	74.0	-7.5	1.00 V	277	59.10	7.40
2	#5714.90	52.4 AV	54.0	-1.6	1.00 V	277	45.00	7.40
3	#5722.00	65.3 PK	78.2	-12.9	1.16 V	276	57.90	7.40
4	#5725.00	63.3 PK	78.2	-14.9	1.16 V	276	55.90	7.40
5	*5755.00	110.8 PK			1.00 V	296	70.20	40.60
6	*5755.00	101.7 AV			1.00 V	296	61.10	40.60
7	11510.00	60.6 PK	74.0	-13.4	1.50 V	243	41.90	18.70
8	11510.00	47.5 AV	54.0	-6.5	1.50 V	243	28.80	18.70

**REMARKS:**

1. Emission Level(dBuV/m) = Raw Value(dBuV) + Correction Factor(dB/m)
2. Correction Factor(dB/m) = Antenna Factor(dB/m) + Cable Factor(dB)
3. The other emission levels were very low against the limit.
4. Margin value = Emission Level – Limit value
5. " \* ": Fundamental frequency.
6. " # ": The radiated frequency is out of the restricted band.



CHANNEL	TX Channel 159	DETECTOR FUNCTION	Peak (PK)
FREQUENCY RANGE	1GHz ~ 40GHz		Average (AV)

**ANTENNA POLARITY & TEST DISTANCE: HORIZONTAL AT 3 M**

NO.	FREQ. (MHz)	EMISSION LEVEL (dBuV/m)	LIMIT (dBuV/m)	MARGIN (dB)	ANTENNA HEIGHT (m)	TABLE ANGLE (Degree)	RAW VALUE (dBuV)	CORRECTION FACTOR (dB/m)
1	*5795.00	101.8 PK			2.45 H	246	61.20	40.60
2	*5795.00	92.0 AV			2.45 H	246	51.40	40.60
3	#5850.00	52.3 PK	78.2	-25.9	2.19 H	263	44.70	7.60
4	#5853.00	59.4 PK	78.2	-18.8	2.19 H	263	51.70	7.70
5	#5861.00	57.6 PK	74.0	-16.4	2.28 H	77	49.90	7.70
6	#5861.00	46.5 AV	54.0	-7.5	2.28 H	77	38.80	7.70
7	11590.00	60.3 PK	74.0	-13.7	1.46 H	222	41.50	18.80
8	11590.00	47.3 AV	54.0	-6.7	1.46 H	222	28.50	18.80

**ANTENNA POLARITY & TEST DISTANCE: VERTICAL AT 3 M**

NO.	FREQ. (MHz)	EMISSION LEVEL (dBuV/m)	LIMIT (dBuV/m)	MARGIN (dB)	ANTENNA HEIGHT (m)	TABLE ANGLE (Degree)	RAW VALUE (dBuV)	CORRECTION FACTOR (dB/m)
1	*5795.00	116.5 PK			1.20 V	298	75.90	40.60
2	*5795.00	107.1 AV			1.20 V	298	66.50	40.60
3	#5850.00	62.1 PK	78.2	-16.1	1.20 V	301	54.50	7.60
4	#5853.00	71.5 PK	78.2	-6.7	1.20 V	301	63.80	7.70
5	#5860.10	67.2 PK	74.0	-6.8	1.24 V	261	59.50	7.70
6	#5860.10	52.8 AV	54.0	-1.2	1.24 V	261	45.10	7.70
7	11590.00	60.3 PK	74.0	-13.7	1.91 V	165	41.50	18.80
8	11590.00	47.4 AV	54.0	-6.6	1.91 V	165	28.60	18.80

**REMARKS:**

1. Emission Level(dBuV/m) = Raw Value(dBuV) + Correction Factor(dB/m)
2. Correction Factor(dB/m) = Antenna Factor(dB/m) + Cable Factor(dB)
3. The other emission levels were very low against the limit.
4. Margin value = Emission Level – Limit value
5. " \* ": Fundamental frequency.
6. " # ": The radiated frequency is out of the restricted band.

**802.11ac (VHT80)**

CHANNEL	TX Channel 42	DETECTOR FUNCTION	Peak (PK)
FREQUENCY RANGE	1GHz ~ 40GHz		Average (AV)

ANTENNA POLARITY & TEST DISTANCE: HORIZONTAL AT 3 M								
NO.	FREQ. (MHz)	EMISSION LEVEL (dBuV/m)	LIMIT (dBuV/m)	MARGIN (dB)	ANTENNA HEIGHT (m)	TABLE ANGLE (Degree)	RAW VALUE (dBuV)	CORRECTION FACTOR (dB/m)
1	5150.00	55.3 PK	74.0	-18.7	1.89 H	83	49.30	6.00
2	5150.00	44.2 AV	54.0	-9.8	1.89 H	83	38.20	6.00
3	*5210.00	91.4 PK			1.89 H	150	51.90	39.50
4	*5210.00	81.8 AV			1.89 H	150	42.30	39.50
5	#10420.00	58.2 PK	74.0	-15.8	1.53 H	123	40.30	17.90
6	#10420.00	45.1 AV	54.0	-8.9	1.53 H	123	27.20	17.90

ANTENNA POLARITY & TEST DISTANCE: VERTICAL AT 3 M								
NO.	FREQ. (MHz)	EMISSION LEVEL (dBuV/m)	LIMIT (dBuV/m)	MARGIN (dB)	ANTENNA HEIGHT (m)	TABLE ANGLE (Degree)	RAW VALUE (dBuV)	CORRECTION FACTOR (dB/m)
1	5150.00	67.5 PK	74.0	-6.5	2.05 V	99	61.50	6.00
<b>2</b>	<b>5150.00</b>	<b>53.0 AV</b>	<b>54.0</b>	<b>-1.0</b>	<b>2.05 V</b>	<b>99</b>	<b>47.00</b>	<b>6.00</b>
3	*5210.00	107.2 PK			1.84 V	75	67.70	39.50
4	*5210.00	96.6 AV			1.84 V	75	57.10	39.50
5	#10420.00	58.8 PK	74.0	-15.2	1.70 V	111	40.90	17.90
6	#10420.00	45.6 AV	54.0	-8.4	1.70 V	111	27.70	17.90

**REMARKS:**

1. Emission Level(dBuV/m) = Raw Value(dBuV) + Correction Factor(dB/m)
2. Correction Factor(dB/m) = Antenna Factor(dB/m) + Cable Factor(dB)
3. The other emission levels were very low against the limit.
4. Margin value = Emission Level – Limit value
5. " \* ": Fundamental frequency.
6. " # ": The radiated frequency is out of the restricted band.

CHANNEL	TX Channel 155	DETECTOR FUNCTION	Peak (PK)
FREQUENCY RANGE	1GHz ~ 40GHz		Average (AV)

**ANTENNA POLARITY & TEST DISTANCE: HORIZONTAL AT 3 M**

NO.	FREQ. (MHz)	EMISSION LEVEL (dBuV/m)	LIMIT (dBuV/m)	MARGIN (dB)	ANTENNA HEIGHT (m)	TABLE ANGLE (Degree)	RAW VALUE (dBuV)	CORRECTION FACTOR (dB/m)
1	#5714.00	57.3 PK	74.0	-16.7	2.38 H	163	49.90	7.40
2	#5714.00	45.5 AV	54.0	-8.5	2.38 H	163	38.10	7.40
3	#5722.00	60.6 PK	78.2	-17.6	2.56 H	142	53.20	7.40
4	#5725.00	52.1 PK	78.2	-26.1	2.56 H	142	44.70	7.40
5	*5775.00	89.9 PK			2.58 H	141	49.30	40.60
6	*5775.00	81.3 AV			2.58 H	141	40.70	40.60
7	11550.00	59.3 PK	74.0	-14.7	2.12 H	313	40.70	18.60
8	11550.00	46.0 AV	54.0	-8.0	2.12 H	313	27.40	18.60

**ANTENNA POLARITY & TEST DISTANCE: VERTICAL AT 3 M**

NO.	FREQ. (MHz)	EMISSION LEVEL (dBuV/m)	LIMIT (dBuV/m)	MARGIN (dB)	ANTENNA HEIGHT (m)	TABLE ANGLE (Degree)	RAW VALUE (dBuV)	CORRECTION FACTOR (dB/m)
1	#5714.90	71.0 PK	74.0	-3.0	1.18 V	327	63.60	7.40
2	#5714.90	52.7 AV	54.0	-1.3	1.18 V	327	45.30	7.40
3	#5722.00	73.9 PK	78.2	-4.3	1.00 V	79	66.50	7.40
4	#5725.00	62.9 PK	78.2	-15.3	1.00 V	79	55.50	7.40
5	*5775.00	104.5 PK			1.09 V	299	63.90	40.60
6	*5775.00	95.1 AV			1.09 V	299	54.50	40.60
7	11550.00	59.7 PK	74.0	-14.3	1.40 V	345	41.10	18.60
8	11550.00	46.9 AV	54.0	-7.1	1.40 V	345	28.30	18.60

**REMARKS:**

1. Emission Level(dBuV/m) = Raw Value(dBuV) + Correction Factor(dB/m)
2. Correction Factor(dB/m) = Antenna Factor(dB/m) + Cable Factor(dB)
3. The other emission levels were very low against the limit.
4. Margin value = Emission Level – Limit value
5. " \* ": Fundamental frequency.
6. " # ": The radiated frequency is out of the restricted band.

Below 1GHz Worst-Case Data: 802.11a

CHANNEL	TX Channel 157	DETECTOR FUNCTION	Quasi-Peak (QP)
FREQUENCY RANGE	9kHz ~ 1GHz		

ANTENNA POLARITY & TEST DISTANCE: HORIZONTAL AT 3 M

NO.	FREQ. (MHz)	EMISSION LEVEL (dBuV/m)	LIMIT (dBuV/m)	MARGIN (dB)	ANTENNA HEIGHT (m)	TABLE ANGLE (Degree)	RAW VALUE (dBuV)	CORRECTION FACTOR (dB/m)
1	74.62	33.6 QP	40.0	-6.4	1.50 H	198	50.80	-17.20
2	166.00	33.5 QP	43.5	-10.0	1.50 H	130	47.60	-14.10
3	249.60	34.3 QP	46.0	-11.7	1.00 H	249	48.50	-14.20
4	300.16	33.6 QP	46.0	-12.4	1.00 H	178	45.80	-12.20
5	624.85	37.5 QP	46.0	-8.5	1.00 H	183	42.60	-5.10
6	850.39	41.7 QP	46.0	-4.3	2.00 H	247	42.80	-1.10

ANTENNA POLARITY & TEST DISTANCE: VERTICAL AT 3 M

NO.	FREQ. (MHz)	EMISSION LEVEL (dBuV/m)	LIMIT (dBuV/m)	MARGIN (dB)	ANTENNA HEIGHT (m)	TABLE ANGLE (Degree)	RAW VALUE (dBuV)	CORRECTION FACTOR (dB/m)
1	31.28	34.4 QP	40.0	-5.6	1.09 V	191	50.30	-15.90
2	72.67	36.8 QP	40.0	-3.2	2.00 V	159	53.70	-16.90
3	152.39	34.0 QP	43.5	-9.5	1.00 V	304	47.80	-13.80
4	249.60	33.8 QP	46.0	-12.2	2.00 V	236	48.00	-14.20
5	294.32	35.6 QP	46.0	-10.4	2.00 V	236	47.90	-12.30
6	624.85	39.1 QP	46.0	-6.9	1.00 V	30	44.20	-5.10

REMARKS:

1. Emission Level(dBuV/m) = Raw Value(dBuV) + Correction Factor(dB/m)
2. Correction Factor(dB/m) = Antenna Factor(dB/m) + Cable Factor(dB)
3. The other emission levels were very low against the limit.
4. Margin value = Emission Level – Limit value

## 4.2 Conducted Emission Measurement

### 4.2.1 Limits of Conducted Emission Measurement

Frequency (MHz)	Conducted Limit (dBuV)	
	Quasi-peak	Average
0.15 - 0.5	66 - 56	56 - 46
0.50 - 5.0	56	46
5.0 - 30.0	60	50

- Note: 1. The lower limit shall apply at the transition frequencies.  
 2. The limit decreases in line with the logarithm of the frequency in the range of 0.15 to 0.50MHz.

### 4.2.2 Test Instruments

Description & Manufacturer	Model No.	Serial No.	Cal. Date	Cal. Due
Test Receiver ROHDE & SCHWARZ	ESCI	100613	Nov. 16, 2015	Nov. 15, 2016
RF signal cable (with 10dB PAD) Woken	5D-FB	Cable-cond1-01	Dec. 26, 2015	Dec. 25, 2016
LISN ROHDE & SCHWARZ (EUT)	ESH3-Z5	835239/001	Feb. 26, 2015	Feb. 25, 2016
LISN ROHDE & SCHWARZ (Peripheral)	ESH3-Z5	100311	Jul. 24, 2015	Jul. 23, 2016
Software ADT	BV ADT_Cond_ V7.3.7.3	NA	NA	NA

- Note: 1. The calibration interval of the above test instruments is 12 months and the calibrations are traceable to NML/ROC and NIST/USA.  
 2. The test was performed in HwaYa Shielded Room 1.  
 3. The VCCI Site Registration No. is C-2040.

#### 4.2.3 Test Procedure

- a. The EUT was placed 0.4 meters from the conducting wall of the shielded room with EUT being connected to the power mains through a line impedance stabilization network (LISN). Other support units were connected to the power mains through another LISN. The two LISNs provide 50 ohm/ 50uH of coupling impedance for the measuring instrument.
- b. Both lines of the power mains connected to the EUT were checked for maximum conducted interference.
- c. The frequency range from 150kHz to 30MHz was searched. Emission levels under (Limit - 20dB) was not recorded.

**NOTE:** The resolution bandwidth and video bandwidth of test receiver is 9kHz for quasi-peak detection (QP) and average detection (AV) at frequency 0.15MHz-30MHz.

#### 4.2.4 Deviation from Test Standard

No deviation.

#### 4.2.5 Test Setup

#### 4.2.7 Test Results

Phase	Line (L)	Detector Function	Quasi-Peak (QP) / Average (AV)
-------	----------	-------------------	--------------------------------

No	Freq. [MHz]	Corr. Factor (dB)	Reading Value [dB (uV)]		Emission Level [dB (uV)]		Limit [dB (uV)]		Margin (dB)	
			Q.P.	AV.	Q.P.	AV.	Q.P.	AV.	Q.P.	AV.
	1	0.15000	10.01	32.07	24.49	42.08	34.50	66.00	56.00	-23.92
2	0.16955	10.06	30.74	20.18	40.80	30.24	64.98	54.98	-24.19	-24.75
<b>3</b>	<b>0.35203</b>	<b>10.13</b>	<b>28.85</b>	<b>21.54</b>	<b>38.98</b>	<b>31.67</b>	<b>58.91</b>	<b>48.91</b>	<b>-19.94</b>	<b>-17.25</b>
4	0.68176	10.21	23.18	15.07	33.39	25.28	56.00	46.00	-22.61	-20.72
5	0.99065	10.29	20.62	13.16	30.91	23.45	56.00	46.00	-25.09	-22.55
6	18.91800	11.12	19.49	13.91	30.61	25.03	60.00	50.00	-29.39	-24.97

#### REMARKS:

1. Q.P. and AV. are abbreviations of quasi-peak and average individually.
2. The emission levels of other frequencies were very low against the limit.
3. Margin value = Emission level - Limit value
4. Correction factor = Insertion loss + Cable loss
5. Emission Level = Correction Factor + Reading Value.

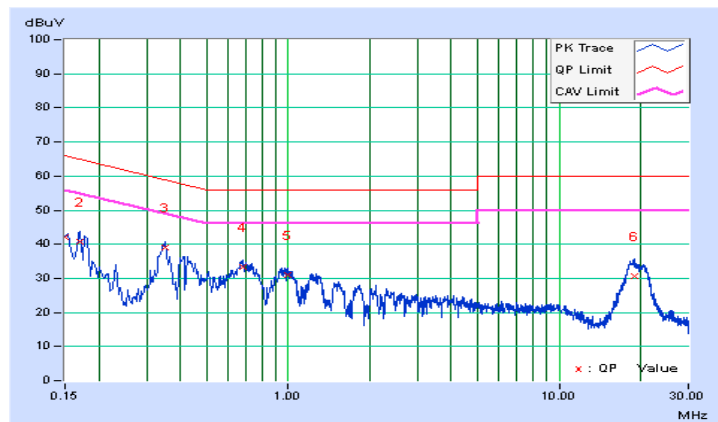



Phase	Neutral (N)	Detector Function	Quasi-Peak (QP) / Average (AV)
-------	-------------	-------------------	--------------------------------

No	Freq. [MHz]	Corr. Factor (dB)	Reading Value [dB (uV)]		Emission Level [dB (uV)]		Limit [dB (uV)]		Margin (dB)	
			Q.P.	AV.	Q.P.	AV.	Q.P.	AV.	Q.P.	AV.
			1	0.15391	10.01	32.45	25.42	42.46	35.43	65.79
2	0.35332	10.12	28.61	21.36	38.73	31.48	58.88	48.88	-20.15	-17.40
3	0.70766	10.19	23.62	15.93	33.81	26.12	56.00	46.00	-22.19	-19.88
4	0.97501	10.23	21.40	14.47	31.63	24.70	56.00	46.00	-24.37	-21.30
5	1.23307	10.24	19.19	12.02	29.43	22.26	56.00	46.00	-26.57	-23.74
6	20.55629	11.01	19.84	15.29	30.85	26.30	60.00	50.00	-29.15	-23.70

**REMARKS:**

1. Q.P. and AV. are abbreviations of quasi-peak and average individually.
2. The emission levels of other frequencies were very low against the limit.
3. Margin value = Emission level - Limit value
4. Correction factor = Insertion loss + Cable loss
5. Emission Level = Correction Factor + Reading Value.

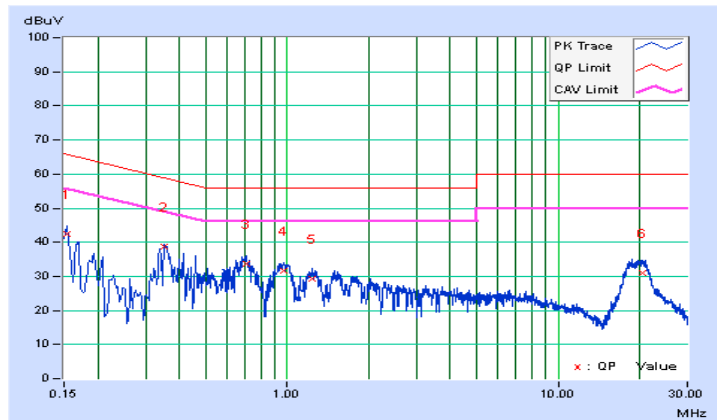

### 4.3 Transmit Power Measurement

#### 4.3.1 Limits of Transmit Power Measurement

Operation Band	EUT Category	LIMIT
U-NII-1	√ Outdoor Access Point	1 Watt (30 dBm) (Max. e.i.r.p)

\*B is the 26 dB emission bandwidth in megahertz

Per KDB 662911 Method of conducted output power measurement on IEEE 802.11 devices,

Array Gain = 0 dB (i.e., no array gain) for  $N_{ANT} \leq 4$ ;

Array Gain = 0 dB (i.e., no array gain) for channel widths  $\geq 40$  MHz for any  $N_{ANT}$ ;

Array Gain =  $5 \log(N_{ANT}/N_{SS})$  dB or 3 dB, whichever is less for 20-MHz channel widths with  $N_{ANT} \geq 5$ .

For power measurements on all other devices: Array Gain =  $10 \log(N_{ANT}/N_{SS})$  dB.

#### 4.3.2 Test Setup

#### 4.3.3 Test Instruments

Refer to section 4.1.2 to get information of above instrument.

#### 4.3.4 Test Procedure

##### FOR AVERAGE POWER MEASUREMENT

###### For 802.11a, 802.11n (HT20), 802.11n (HT40)

Method PM is used to perform output power measurement, trigger and gating function of wide band power meter is enabled to measure max output power of TX on burst. Duty factor is not added to measured value.

###### For 802.11ac (VHT80)

- 1) Set span to encompass the entire 26 dB EBW (or, alternatively, the entire 99% occupied bandwidth) of the signal.
- 2) Set sweep trigger to "free run".
- 3) Set RBW = 1 MHz.
- 4) Set VBW  $\geq$  3 MHz
- 5) Number of points in sweep  $\geq$  2 Span / RBW.
- 6) Sweep time  $\leq$  (number of points in sweep) \* T
- 7) Using emission bandwidth to determine the frequency span for integration the channel bandwidth.
- 8) Detector = RMS.
- 9) Trace mode = max hold.
- 10) Allow max hold to run for at least 60 seconds, or longer as needed to allow the trace to stabilize.

##### FOR OCCUPIED BANDWIDTH

The transmitter output was connected to the spectrum analyzer through an attenuator. The bandwidth of the fundamental frequency was measured by spectrum analyzer with resolution bandwidth in the range of 1% to 5% of the anticipated emission bandwidth, and a video bandwidth at least 3x the resolution bandwidth and set the detector to average. The width of a frequency band such that, below the lower and above the upper frequency limits, the mean powers emitted are each equal to a specified percentage 0.5 %of the total mean power of a given emission.

#### 4.3.5 Deviation from Test Standard

No deviation.

#### 4.3.6 EUT Operating Conditions

The software provided by client to enable the EUT under transmission Condition continuously at lowest, middle and highest channel frequencies individually.

#### 4.3.7 Test Result

### POWER OUTPUT:

#### For U-NII-1 Band (Outdoor Access Point)

##### 802.11a

Chan.	Freq. (MHz)	Conducted Power (dBm)			Total Power (mW)	Total Power (dBm)	Power Limit (dBm)	Gain (dBi)	EIRP (dBm)	EIRP limit (dBm)	Pass / Fail
		Chain 0	Chain 1	Chain 2							
36	5180	17.66	17.70	16.96	166.888	22.22	29.00	-3.88	18.34	21.00	Pass
40	5200	20.28	20.07	19.59	<b>299.276</b>	24.76	29.00	-3.88	20.88	21.00	Pass
48	5240	20.01	20.22	19.42	292.925	24.67	29.00	-3.88	20.79	21.00	Pass

Note:

Gain = 7.00 dBi > 6dBi, so the power limit shall be reduced to  $30 - (7.00 - 6) = 29.00$ dBm.

Gain = -3.88dBi (above 30 degrees from the horizon),

EIRP = conducted power + (-3.88dBi) + array gain = (0 dB (i.e., no array gain) for  $N_{ANT} \leq 4$ ).

##### 802.11n (HT20)

Chan.	Freq. (MHz)	Conducted Power (dBm)			Total Power (mW)	Total Power (dBm)	Power Limit (dBm)	Gain (dBi)	EIRP (dBm)	EIRP limit (dBm)	Pass / Fail
		Chain 0	Chain 1	Chain 2							
36	5180	16.52	16.39	15.79	126.357	21.02	29.00	-3.88	17.14	21.00	Pass
40	5200	20.14	20.01	19.31	288.817	24.61	29.00	-3.88	20.73	21.00	Pass
48	5240	19.82	20.10	19.27	282.797	24.51	29.00	-3.88	20.63	21.00	Pass

Note:

Gain = 7.00 dBi > 6dBi, so the power limit shall be reduced to  $30 - (7.00 - 6) = 29.00$ dBm.

Gain = -3.88dBi (above 30 degrees from the horizon),

EIRP = conducted power + (-3.88dBi) + array gain = (0 dB (i.e., no array gain) for  $N_{ANT} \leq 4$ ).

##### 802.11n (HT40)

Chan.	Freq. (MHz)	Conducted Power (dBm)			Total Power (mW)	Total Power (dBm)	Power Limit (dBm)	Gain (dBi)	EIRP (dBm)	EIRP limit (dBm)	Pass / Fail
		Chain 0	Chain 1	Chain 2							
38	5190	11.62	11.69	11.26	42.644	16.30	29.00	-3.88	12.42	21.00	Pass
46	5230	19.23	19.42	18.54	242.701	23.85	29.00	-3.88	19.97	21.00	Pass

Note:

Gain = 7.00 dBi > 6dBi, so the power limit shall be reduced to  $30 - (7.00 - 6) = 29.00$ dBm.

Gain = -3.88dBi (above 30 degrees from the horizon),

EIRP = conducted power + (-3.88dBi) + array gain = (0 dB (i.e., no array gain) for  $N_{ANT} \leq 4$ ).

##### 802.11ac (VHT80)

Chan.	Freq. (MHz)	Conducted Power (dBm)			Total Power (mW)	Total Power (dBm)	Power Limit (dBm)	Gain (dBi)	EIRP (dBm)	EIRP limit (dBm)	Pass / Fail
		Chain 0	Chain 1	Chain 2							
42	5210	8.77	8.63	8.67	22.191	13.46	29.00	-3.88	9.58	21.00	Pass

Note:

Gain = 7.00 dBi > 6dBi, so the power limit shall be reduced to  $30 - (7.00 - 6) = 29.00$ dBm.

Gain = -3.88dBi (above 30 degrees from the horizon),

EIRP = conducted power + (-3.88dBi) + array gain = (0 dB (i.e., no array gain) for  $N_{ANT} \leq 4$ ).

**For U-NII-3 Band  
802.11a**

Channel	Channel Frequency (MHz)	Maximum Conducted Power (dBm)			Total Power (mW)	Total Power (dBm)	Power Limit (dBm)	Pass / Fail
		Chain 0	Chain 1	Chain 2				
149	5745	17.84	19.34	18.71	221.017	23.44	29.00	Pass
157	5785	22.01	22.64	22.33	<b>513.511</b>	27.11	29.00	Pass
165	5825	18.75	19.29	18.76	235.069	23.71	29.00	Pass

Note: Gain = 7.00dBi > 6dBi, so the power limit shall be reduced to  $30 - (7.00 - 6) = 29.00$ dBm.

**802.11n (HT20)**

Channel	Channel Frequency (MHz)	Maximum Conducted Power (dBm)			Total Power (mW)	Total Power (dBm)	Power Limit (dBm)	Pass / Fail
		Chain 0	Chain 1	Chain 2				
149	5745	16.49	17.95	17.11	158.343	22.00	29.00	Pass
157	5785	21.74	22.08	21.77	461.029	26.64	29.00	Pass
165	5825	17.99	18.72	18.22	203.798	23.09	29.00	Pass

Note: Gain = 7.00dBi > 6dBi, so the power limit shall be reduced to  $30 - (7.00 - 6) = 29.00$ dBm.

**802.11n (HT40)**

Channel	Channel Frequency (MHz)	Maximum Conducted Power (dBm)			Total Power (mW)	Total Power (dBm)	Power Limit (dBm)	Pass / Fail
		Chain 0	Chain 1	Chain 2				
151	5755	12.89	13.82	13.20	64.446	18.09	29.00	Pass
159	5795	18.67	19.02	18.68	227.21	23.56	29.00	Pass

Note: Gain = 7.00dBi > 6dBi, so the power limit shall be reduced to  $30 - (7.00 - 6) = 29.00$ dBm.

**802.11ac (VHT80)**

Channel	Channel Frequency (MHz)	Maximum Conducted Power (dBm)			Total Power (mW)	Total Power (dBm)	Power Limit (dBm)	Pass / Fail
		Chain 0	Chain 1	Chain 2				
155	5775	10.03	10.38	10.41	31.973	15.05	29.00	Pass

Note: Gain = 7.00dBi > 6dBi, so the power limit shall be reduced to  $30 - (7.00 - 6) = 29.00$ dBm.

**26dB BANDWIDTH:**
**802.11a**

Channel	Channel Frequency (MHz)	26dBc Bandwidth (MHz)			Pass / Fail
		Chain 0	Chain 1	Chain 2	
36	5180	25.00	24.15	25.73	Pass
40	5200	25.19	24.61	25.43	Pass
48	5240	24.41	24.45	24.37	Pass

**802.11n (HT20)**

Channel	Channel Frequency (MHz)	26dBc Bandwidth (MHz)			Pass / Fail
		Chain 0	Chain 1	Chain 2	
36	5180	24.70	25.85	26.03	Pass
40	5200	25.15	25.22	26.51	Pass
48	5240	25.47	25.06	26.41	Pass

**802.11n (HT40)**

Channel	Channel Frequency (MHz)	26dBc Bandwidth (MHz)			Pass / Fail
		Chain 0	Chain 1	Chain 2	
38	5190	48.04	49.32	48.27	Pass
46	5230	48.48	48.51	48.81	Pass

**802.11ac (VHT80)**

Channel	Channel Frequency (MHz)	26dBc Bandwidth (MHz)			Pass / Fail
		Chain 0	Chain 1	Chain 2	
42	5210	96.52	101.75	99.60	Pass

**SPECTRUM PLOT OF WORST VALUE**

**802.11a**

**802.11n (HT20)**

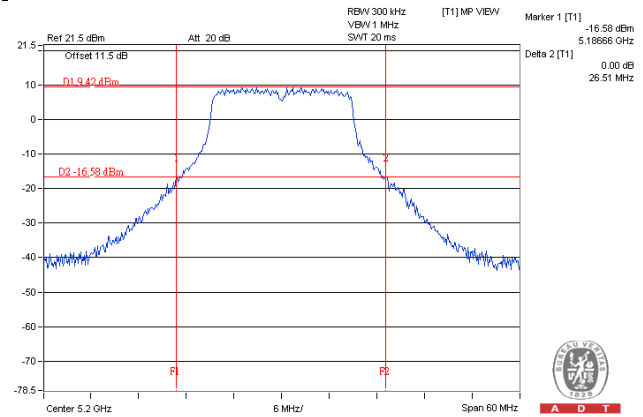
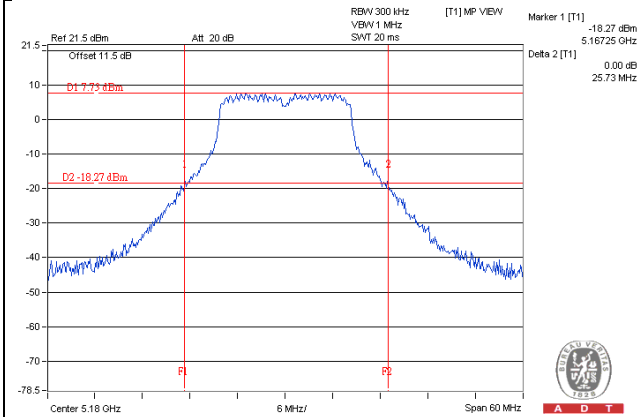

**802.11n (HT40)**

**802.11ac (VHT80)**

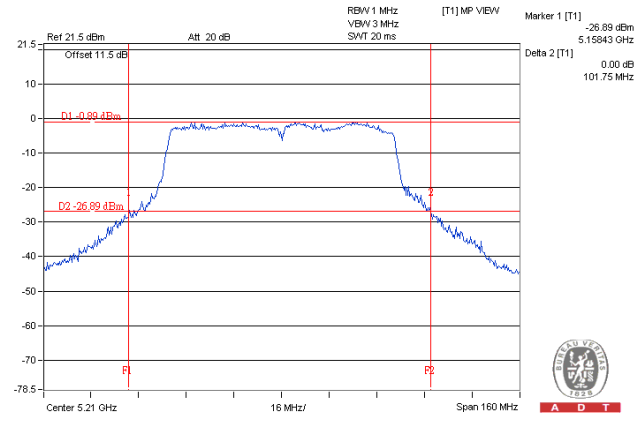
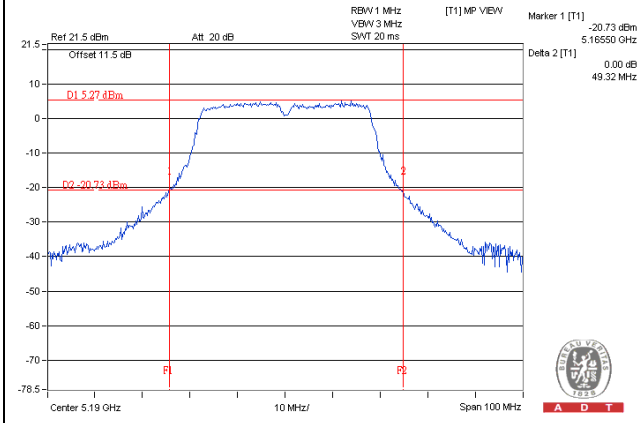

**Occupied Bandwidth:**
**802.11a**

Channel	Channel Frequency (MHz)	Occupied Bandwidth (MHz)			Pass / Fail
		Chain 0	Chain 1	Chain 2	
36	5180	16.92	16.92	17.04	Pass
40	5200	17.04	16.92	17.04	Pass
48	5240	17.04	16.92	17.04	Pass
149	5745	17.04	17.04	17.04	Pass
157	5785	34.20	31.56	31.32	Pass
165	5825	17.04	16.92	17.04	Pass

**802.11n (HT20)**

Channel	Channel Frequency (MHz)	Occupied Bandwidth (MHz)			Pass / Fail
		Chain 0	Chain 1	Chain 2	
36	5180	18.12	18.00	18.00	Pass
40	5200	18.12	18.00	18.00	Pass
48	5240	18.24	18.12	18.12	Pass
149	5745	18.24	18.00	18.00	Pass
157	5785	29.39	26.40	27.96	Pass
165	5825	18.12	18.00	18.00	Pass

**802.11n (HT40)**

Channel	Channel Frequency (MHz)	Occupied Bandwidth (MHz)			Pass / Fail
		Chain 0	Chain 1	Chain 2	
38	5190	37.08	37.08	36.96	Pass
46	5230	36.84	36.96	37.20	Pass
151	5755	36.84	36.96	37.08	Pass
159	5795	36.96	36.84	36.96	Pass

**802.11ac (VHT80)**

Channel	Channel Frequency (MHz)	Occupied Bandwidth (MHz)			Pass / Fail
		Chain 0	Chain 1	Chain 2	
42	5210	75.88	75.88	76.16	Pass
155	5775	75.88	75.88	76.16	Pass



**SPECTRUM PLOT OF WORST VALUE**

**802.11a**

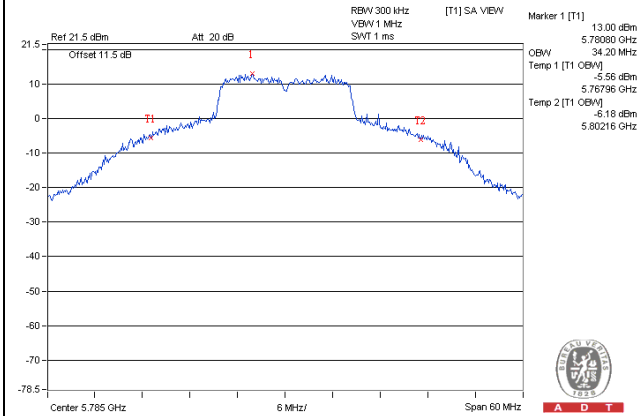

**802.11n (HT20)**

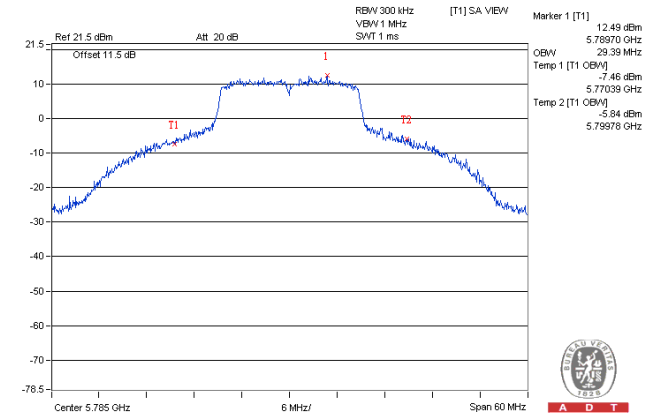

**802.11n (HT40)**

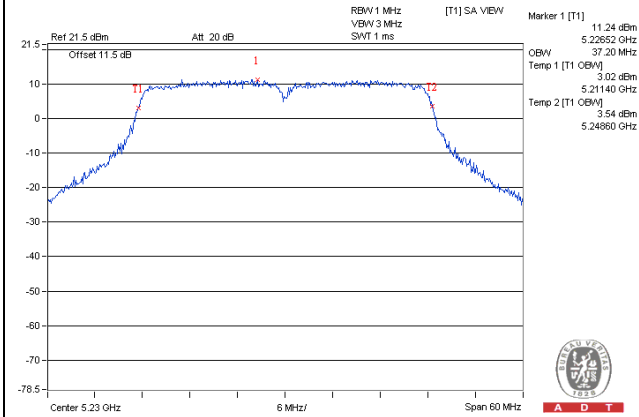

**802.11ac (VHT80)**

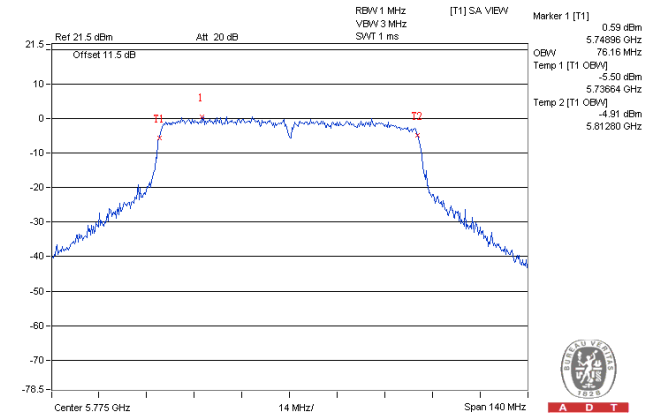

## 4.4 Peak Power Spectral Density Measurement

### 4.4.1 Limits of Peak Power Spectral Density Measurement

Operation Band	EUT Category		LIMIT
U-NII-1	√	Outdoor Access Point	17dBm/ MHz
		Fixed point-to-point Access Point	
		Indoor Access Point	
		Mobile and Portable client device	11dBm/ MHz
U-NII-2A	---		11dBm/ MHz
U-NII-2C	---		11dBm/ MHz
U-NII-3	√		30dBm/ 500kHz

### 4.4.2 Test Setup

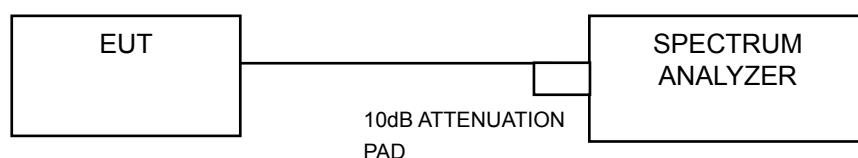

### 4.4.3 Test Instruments

Refer to section 4.1.2 to get information of above instrument.

### 4.4.4 Test Procedure

#### For U-NII-1 band:

Using method SA-2 alternative

- 1) Set span to encompass the entire emission bandwidth (EBW) of the signal.
- 2) Set RBW = 1 MHz, Set VBW ≥ 3 MHz, Detector = RMS
- 3) Set Channel power measure = 1MHz
- 4) Sweep time = 20ms.
- 5) Perform a single sweep.
- 6) Record the max value and add 10 log (1/duty cycle)

#### For U-NII-3 band:

1. Set span to encompass the entire emission bandwidth (EBW) of the signal.
2. Set RBW = 300 kHz, Set VBW ≥ 1 MHz, Detector = RMS
3. Use the peak marker function to determine the maximum power level in any 300 kHz band segment within the fundamental EBW.
4. Scale the observed power level to an equivalent value in 500 kHz by adjusting (reducing) the measured power by a bandwidth correction factor (BWCF) where  $BWCF = 10\log(500\text{ kHz}/300\text{ kHz})$
5. Sweep time = auto, trigger set to "free run".
6. Trace average at least 100 traces in power averaging mode.
7. Record the max value and add 10 log (1/duty cycle)

#### 4.4.5 Deviation from Test Standard

No deviation.

#### 4.4.6 EUT Operating Condition

Same as Item 4.3.6.

#### 4.4.7 Test Results

### For U-NII-1 Band

#### 802.11a

Chan.	Freq. (MHz)	PSD (dBm)			Total PSD w/o duty factor (dBm)	Duty factor	Total PSD with duty factor (dBm)	Max. Limit (dBm)	Pass / Fail
		Chain 0	Chain 1	Chain 2					
36	5180	3.02	3.05	2.58	7.66	0.14	7.80	11.23	Pass
40	5200	5.96	5.16	4.95	10.15	0.14	10.29	11.23	Pass
48	5240	5.83	6.19	4.66	10.38	0.14	10.52	11.23	Pass

**NOTE:**

1. Method 1 of power density measurement of KDB 662911 is using for calculating total power density. Total power density is summing entire spectra across corresponding frequency bins on the various outputs by computer.
2. Directional gain = 7.00dBi + 10log(3) = 11.77dBi > 6dBi, so the power density limit shall be reduced to 17-(11.77-6) = 11.23dBm.
3. Refer to section 3.3 for duty cycle spectrum plot.

#### 802.11n (HT20)

Chan.	Freq. (MHz)	PSD (dBm)			Total PSD w/o duty factor (dBm)	Duty factor	Total PSD with duty factor (dBm)	Max. Limit (dBm)	Pass / Fail
		Chain 0	Chain 1	Chain 2					
36	5180	2.03	1.81	0.55	6.28	0.18	6.46	11.23	Pass
40	5200	5.80	4.63	4.32	9.74	0.18	9.92	11.23	Pass
48	5240	5.58	4.43	4.38	9.61	0.18	9.79	11.23	Pass

**NOTE:**

1. Method 1 of power density measurement of KDB 662911 is using for calculating total power density. Total power density is summing entire spectra across corresponding frequency bins on the various outputs by computer.
2. Directional gain = 7.00dBi + 10log(3) = 11.77dBi > 6dBi, so the power density limit shall be reduced to 17-(11.77-6) = 11.23dBm.
3. Refer to section 3.3 for duty cycle spectrum plot.

**802.11n (HT40)**

Chan.	Freq. (MHz)	PSD (dBm)			Total PSD w/o duty factor (dBm)	Duty factor	Total PSD with duty factor (dBm)	Max. Limit (dBm)	Pass / Fail
		Chain 0	Chain 1	Chain 2					
38	5190	-5.67	-6.24	-6.74	-1.42	0.27	-1.15	11.23	Pass
46	5230	1.99	1.36	0.30	6.05	0.27	6.32	11.23	Pass

**NOTE:**

- Method 1 of power density measurement of KDB 662911 is using for calculating total power density. Total power density is summing entire spectra across corresponding frequency bins on the various outputs by computer.
- Directional gain =  $7.00\text{dBi} + 10\log(3) = 11.77\text{dBi} > 6\text{dBi}$ , so the power density limit shall be reduced to  $17 - (11.77 - 6) = 11.23\text{dBm}$ .
- Refer to section 3.3 for duty cycle spectrum plot.

**802.11ac (VHT80)**

Chan.	Freq. (MHz)	PSD (dBm)			Total PSD w/o duty factor (dBm)	Duty factor	Total PSD with duty factor (dBm)	Max. Limit (dBm)	Pass / Fail
		Chain 0	Chain 1	Chain 2					
42	5210	-12.29	-11.94	-12.44	-7.44	0.09	-7.35	11.23	Pass

**NOTE:**

- Method 1 of power density measurement of KDB 662911 is using for calculating total power density. Total power density is summing entire spectra across corresponding frequency bins on the various outputs by computer.
- Directional gain =  $7.00\text{dBi} + 10\log(3) = 11.77\text{dBi} > 6\text{dBi}$ , so the power density limit shall be reduced to  $17 - (11.77 - 6) = 11.23\text{dBm}$ .
- Refer to section 3.3 for duty cycle spectrum plot.

**SPECTRUM PLOT OF WORST VALUE**

**802.11a / CH 48 / Chain 1**

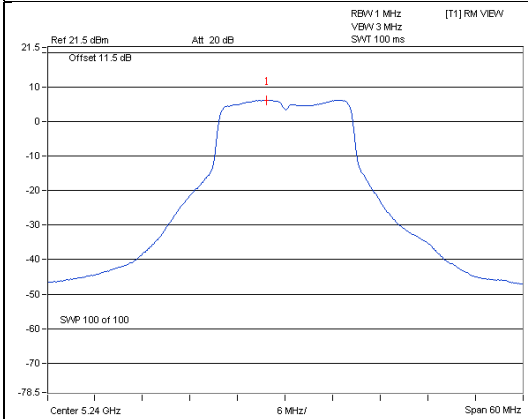

**802.11n (HT20) / CH 40 / Chain 0**

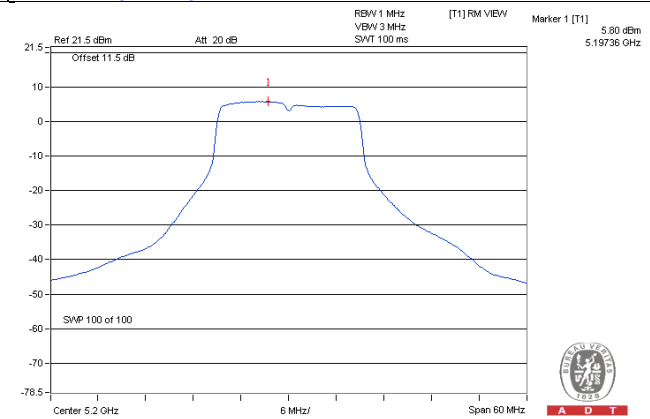

**802.11n (HT40) / CH 46 / Chain 0**

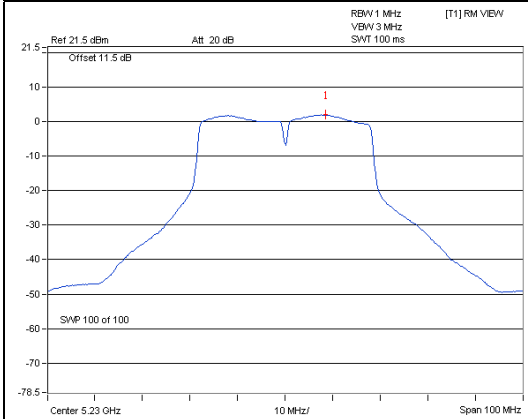

**802.11ac (VHT80) / CH 42 / Chain 1**

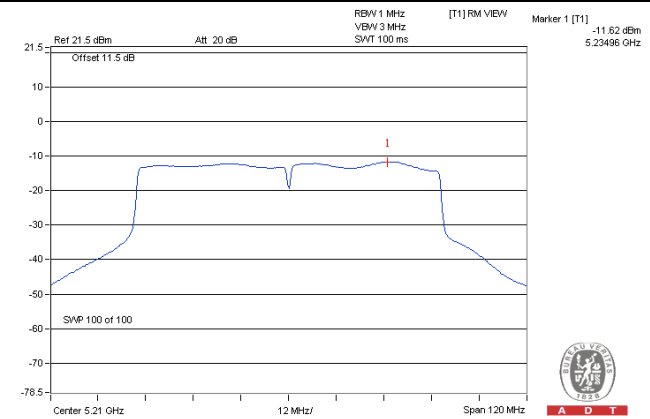

## For U-NII-3 Band

### 802.11a

TX chain	Channel	Freq. (MHz)	PSD (dBm/300kHz)	PSD (dBm/500kHz)	10 log (N=3) dB	Duty factor	Total PSD (dBm/500kHz)	Limit (dBm/500kHz)	Pass /Fail
0	149	5745	-4.75	-2.53	4.77	0.14	2.38	24.23	Pass
	157	5785	-0.64	1.58	4.77	0.14	6.49	24.23	Pass
	165	5825	-3.76	-1.54	4.77	0.14	3.37	24.23	Pass
1	149	5745	-3.18	-0.96	4.77	0.14	3.95	24.23	Pass
	157	5785	-0.35	1.87	4.77	0.14	6.78	24.23	Pass
	165	5825	-2.85	-0.63	4.77	0.14	4.28	24.23	Pass
2	149	5745	-4.22	-2.00	4.77	0.14	2.91	24.23	Pass
	157	5785	-0.59	1.63	4.77	0.14	6.54	24.23	Pass
	165	5825	-3.71	-1.49	4.77	0.14	3.42	24.23	Pass

**NOTE:**

- Method 1 of power density measurement of KDB 662911 is using for calculating total power density. Total power density is summing entire spectra across corresponding frequency bins on the various outputs by computer.
- Directional gain = 7.00dBi + 10log(3) = 11.77 dBi > 6dBi, so the power density limit shall be reduced to 30-(11.77-6) = 24.23dBm.
- Refer to section 3.3 for duty cycle spectrum plot.

### 802.11n (HT20)

TX chain	Channel	Freq. (MHz)	PSD (dBm/300kHz)	PSD (dBm/500kHz)	10 log (N=3) dB	Duty factor	Total PSD (dBm/500kHz)	Limit (dBm/500kHz)	Pass /Fail
0	149	5745	-6.17	-3.95	4.77	0.18	1.00	24.23	Pass
	157	5785	-1.11	1.11	4.77	0.18	6.06	24.23	Pass
	165	5825	-4.76	-2.54	4.77	0.18	2.41	24.23	Pass
1	149	5745	-6.83	-4.61	4.77	0.18	0.34	24.23	Pass
	157	5785	-3.41	-1.19	4.77	0.18	3.76	24.23	Pass
	165	5825	-8.91	-6.69	4.77	0.18	-1.74	24.23	Pass
2	149	5745	-5.42	-3.20	4.77	0.18	1.75	24.23	Pass
	157	5785	-1.20	1.02	4.77	0.18	5.97	24.23	Pass
	165	5825	-4.53	-2.31	4.77	0.18	2.64	24.23	Pass

**NOTE:**

- Method 1 of power density measurement of KDB 662911 is using for calculating total power density. Total power density is summing entire spectra across corresponding frequency bins on the various outputs by computer.
- Directional gain = 7.00dBi + 10log(3) = 11.77 dBi > 6dBi, so the power density limit shall be reduced to 30-(11.77-6) = 24.23dBm.
- Refer to section 3.3 for duty cycle spectrum plot.

**802.11n (HT40)**

TX chain	Channel	Freq. (MHz)	PSD (dBm/300kHz)	PSD (dBm/500kHz)	10 log (N=3) dB	Duty factor	Total PSD (dBm/500kHz)	Limit (dBm/500kHz)	Pass /Fail
0	151	5755	-12.91	-10.69	4.77	0.27	-5.65	24.23	Pass
	159	5795	-7.46	-5.24	4.77	0.27	-0.20	24.23	Pass
1	151	5755	-14.39	-12.17	4.77	0.27	-7.13	24.23	Pass
	159	5795	-9.76	-7.54	4.77	0.27	-2.50	24.23	Pass
2	151	5755	-12.76	-10.54	4.77	0.27	-5.50	24.23	Pass
	159	5795	-7.44	-5.22	4.77	0.27	-0.18	24.23	Pass

**NOTE:**

- Method 1 of power density measurement of KDB 662911 is using for calculating total power density. Total power density is summing entire spectra across corresponding frequency bins on the various outputs by computer.
- Directional gain = 7.00dBi + 10log(3) = 11.77 dBi > 6dBi, so the power density limit shall be reduced to 30-(11.77-6) = 24.23dBm.
- Refer to section 3.3 for duty cycle spectrum plot.

**802.11ac (VHT80)**

TX chain	Channel	Freq. (MHz)	PSD (dBm/300kHz)	PSD (dBm/500kHz)	10 log (N=3) dB	Duty factor	Total PSD (dBm/500kHz)	Limit (dBm/500kHz)	Pass /Fail
0	155	5775	-18.96	-16.74	4.77	0.09	-11.88	24.23	Pass
1	155	5775	-22.79	-20.57	4.77	0.09	-15.71	24.23	Pass
2	155	5775	-19.05	-16.83	4.77	0.09	-11.97	24.23	Pass

**NOTE:**

- Method 1 of power density measurement of KDB 662911 is using for calculating total power density. Total power density is summing entire spectra across corresponding frequency bins on the various outputs by computer.
- Directional gain = 7.00dBi + 10log(3) = 11.77 dBi > 6dBi, so the power density limit shall be reduced to 30-(11.77-6) = 24.23dBm.
- Refer to section 3.3 for duty cycle spectrum plot.

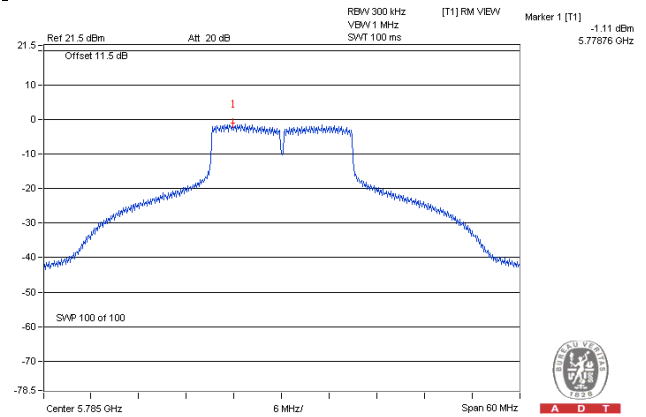
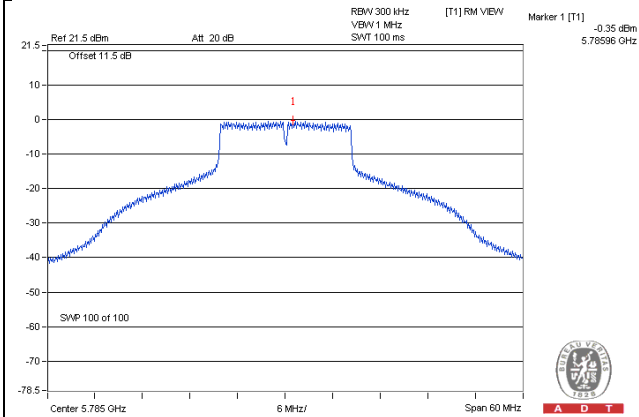
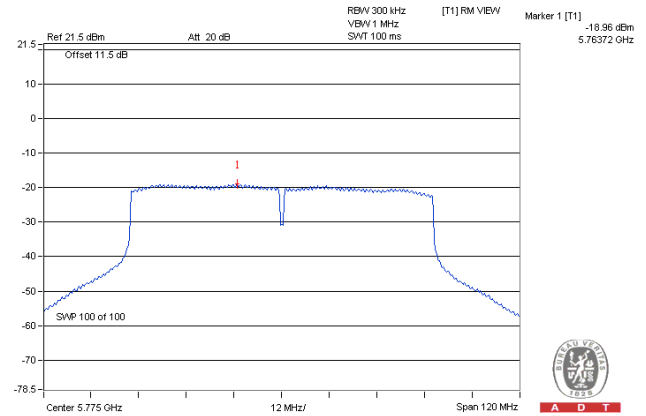
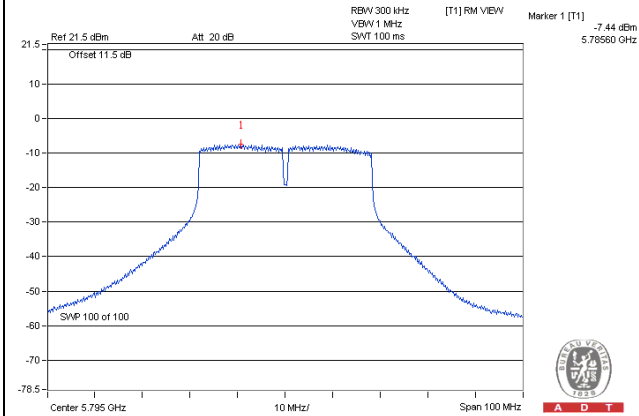

**SPECTRUM PLOT OF WORST VALUE****802.11a****802.11n (HT20)****802.11n (HT40)****802.11ac (VHT80)**

## 4.5 Frequency Stability

### 4.5.1 Limits of Frequency Stability Measurement

The frequency of the carrier signal shall be maintained within band of operation

### 4.5.2 Test Setup

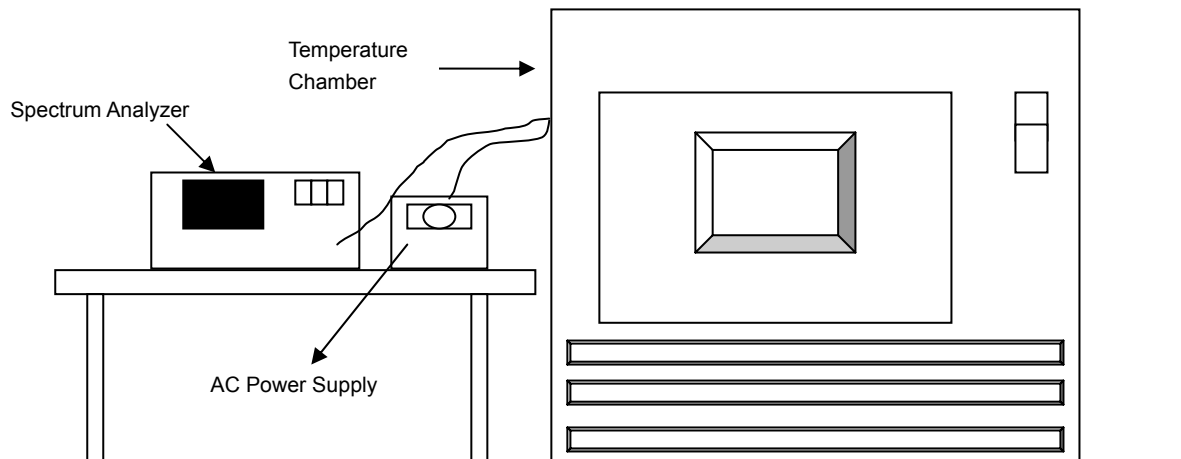

### 4.5.3 Test Instruments

Refer to section 4.1.2 to get information of above instrument.

### 4.5.4 Test Procedure

- The EUT was placed inside the environmental test chamber and powered by nominal AC voltage.
- Turn the EUT on and couple its output to a spectrum analyzer.
- Turn the EUT off and set the chamber to the highest temperature specified.
- Allow sufficient time (approximately 30 min) for the temperature of the chamber to stabilize, turn the EUT on and measure the operating frequency after 2, 5, and 10 minutes.
- Repeat step 2 and 3 with the temperature chamber set to the lowest temperature.
- The test chamber was allowed to stabilize at +20 degree C for a minimum of 30 minutes. The supply voltage was then adjusted on the EUT from 85% to 115% and the frequency record.

### 4.5.5 Deviation from Test Standard

No deviation.

### 4.5.6 EUT Operating Condition

Set the EUT transmit at un-modulation mode to test frequency stability.



#### 4.5.7 Test Results

##### FREQUENCY STABILITY VERSUS TEMP.

OPERATING FREQUENCY: 5240MHz

TEMP.  
(

## 4.6 6dB Bandwidth Measurement

### 4.6.1 Limits of 6dB Bandwidth Measurement

The minimum of 6dB Bandwidth Measurement is 0.5MHz.

### 4.6.2 Test Setup

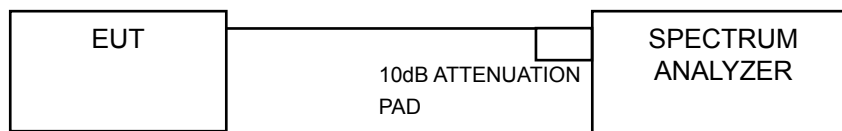

### 4.6.3 Test Instruments

Refer to section 4.1.2 to get information of above instrument.

### 4.6.4 Test Procedure

- Set resolution bandwidth (RBW) = 100kHz
- Set the video bandwidth (VBW)  $\geq 3 \times$  RBW, Detector = Peak.
- Trace mode = max hold.
- Sweep = auto couple.
- Measure the maximum width of the emission that is constrained by the frequencies associated with the two amplitude points (upper and lower) that are attenuated by 6 dB relative to the maximum level measured in the fundamental emission

### 4.6.5 Deviation from Test Standard

No deviation.

### 4.6.6 EUT Operating Condition

The software provided by client to enable the EUT under transmission Condition continuously at lowest, middle and highest channel frequencies individually.

#### 4.6.7 Test Results

##### 802.11a

Channel	Frequency (MHz)	6dB Bandwidth (MHz)			Minimum Limit (MHz)	Pass / Fail
		Chain 0	Chain 1	Chain 2		
149	5745	16.38	16.36	16.39	0.5	Pass
157	5785	16.37	16.39	16.09	0.5	Pass
165	5825	16.40	16.38	16.40	0.5	Pass

##### 802.11n (HT20)

Channel	Frequency (MHz)	6dB Bandwidth (MHz)			Minimum Limit (MHz)	Pass / Fail
		Chain 0	Chain 1	Chain 2		
149	5745	17.60	16.96	17.62	0.5	Pass
157	5785	17.60	17.59	17.61	0.5	Pass
165	5825	16.95	16.59	17.61	0.5	Pass

##### 802.11n (HT40)

Channel	Frequency (MHz)	6dB Bandwidth (MHz)			Minimum Limit (MHz)	Pass / Fail
		Chain 0	Chain 1	Chain 2		
151	5755	35.60	36.05	36.45	0.5	Pass
159	5795	35.58	35.73	35.88	0.5	Pass

##### 802.11ac (VHT80)

Channel	Frequency (MHz)	6dB Bandwidth (MHz)			Minimum Limit (MHz)	Pass / Fail
		Chain 0	Chain 1	Chain 2		
155	5775	73.05	67.07	74.89	0.5	Pass

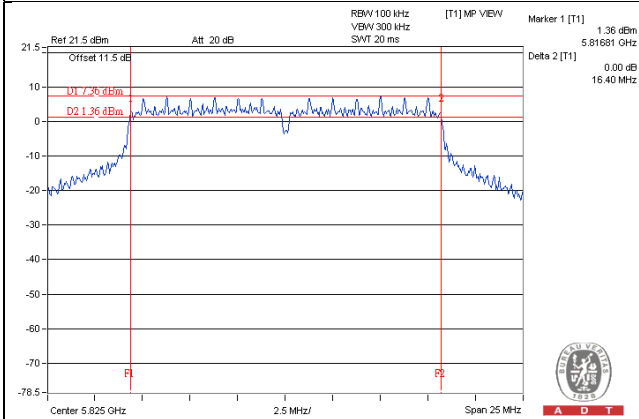
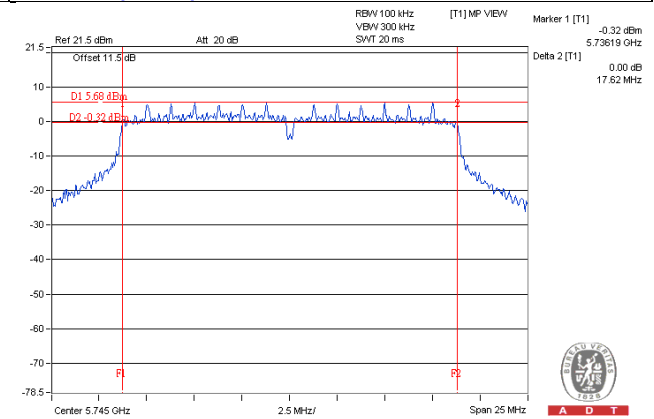
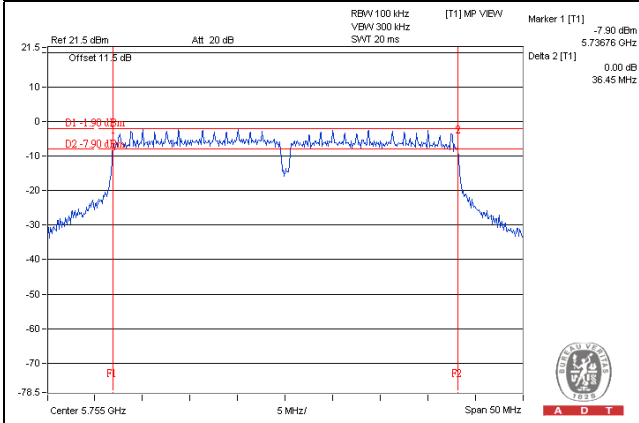
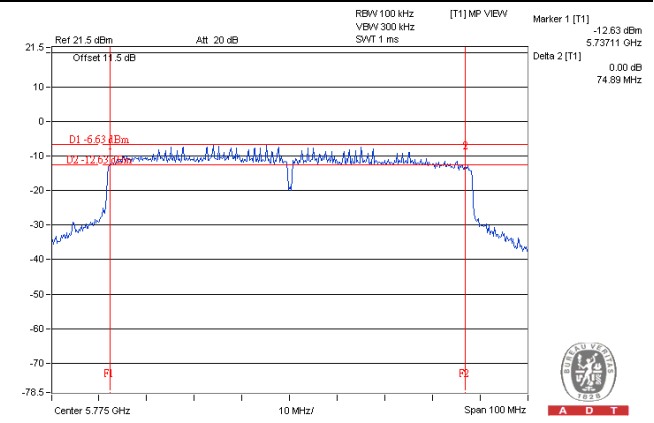
**SPECTRUM PLOT OF WORST VALUE****802.11a****802.11n (HT20)****802.11n (HT40)****802.11ac (VHT80)**



## 5 Pictures of Test Arrangements

Please refer to the attached file (Test Setup Photo).

## Appendix – Information on the Testing Laboratories

We, Bureau Veritas Consumer Products Services (H.K.) Ltd., Taoyuan Branch, were founded in 1988 to provide our best service in EMC, Radio, Telecom and Safety consultation. Our laboratories are accredited and approved according to ISO/IEC 17025.

If you have any comments, please feel free to contact us at the following:

**Linko EMC/RF Lab**

Tel: 886-2-26052180

Fax: 886-2-26051924

**Hsin Chu EMC/RF/Telecom Lab**

Tel: 886-3-6668565

Fax: 886-3-6668323

**Hwa Ya EMC/RF/Safety Lab**

Tel: 886-3-3183232

Fax: 886-3-3270892

**Email:** [service.adt@tw.bureauveritas.com](mailto:service.adt@tw.bureauveritas.com)

**Web Site:** [www.bureauveritas-adt.com](http://www.bureauveritas-adt.com)

The address and road map of all our labs can be found in our web site also.

--- END ---