

FCC Test Report

Report No.: RF130903C26I

FCC ID: ZHV-DTAGA

Test Model: DTAGA

Received Date: Sep. 03, 2013

Test Date: Sep. 06 ~ Oct. 07, 2013 (Radiated emission below 1GHz & conducted emission tests)

Mar. 28 ~ Apr. 12, 2016 (All tests except Radiated emission below 1GHz & conducted emission tests)

Issued Date: Apr. 19, 2016

Applicant: Riverbed Technology Inc.

Address: 680 Folsom Street San Francisco, California USA 94107

Issued By: Bureau Veritas Consumer Products Services (H.K.) Ltd., Taoyuan Branch

Lab Address: No. 47-2, 14th Ling, Chia Pau Vil., Lin Kou Dist., New Taipei City, Taiwan, R.O.C.

Test Location: No.19, Hwa Ya 2nd Rd., Wen Hwa Vil., Kwei Shan Dist., Taoyuan City 33383, TAIWAN (R.O.C.)



This report is for your exclusive use. Any copying or replication of this report to or for any other person or entity, or use of our name or trademark, is permitted only with our prior written permission. This report sets forth our findings solely with respect to the test samples identified herein. The results set forth in this report are not indicative or representative of the quality or characteristics of the lot from which a test sample was taken or any similar or identical product unless specifically and expressly noted. Our report includes all of the tests requested by you and the results thereof based upon the information that you provided to us. You have 60 days from date of issuance of this report to notify us of any material error or omission caused by our negligence, provided, however, that such notice shall be in writing and shall specifically address the issue you wish to raise. A failure to raise such issue within the prescribed time shall constitute your unqualified acceptance of the completeness of this report, the tests conducted and the correctness of the report contents. Unless specifically mentioned, the uncertainty of measurement has been explicitly taken into account to declare the compliance or non-compliance to the specification. This report should not be used by the client to claim product certification, approval, or endorsement by TAF or any government agencies.

Table of Contents

Release Control Record	4
1 Certificate of Conformity	5
2 Summary of Test Results	6
2.1 Measurement Uncertainty.....	6
2.2 Modification Record.....	6
3 General Information	7
3.1 General Description of EUT.....	7
3.2 Description of Test Modes.....	8
3.2.1 Test Mode Applicability and Tested Channel Detail.....	9
3.3 Duty Cycle of Test Signal.....	11
3.4 Description of Support Units.....	12
3.4.1 Configuration of System under Test.....	12
3.5 General Description of Applied Standards.....	14
4 Test Types and Results	15
4.1 Radiated Emission and Bandedge Measurement.....	15
4.1.1 Limits of Radiated Emission and Bandedge Measurement.....	15
4.1.2 Test Instruments.....	16
4.1.3 Test Procedures.....	18
4.1.4 Deviation from Test Standard.....	18
4.1.5 Test Set Up.....	19
4.1.6 EUT Operating Conditions.....	19
4.1.7 Test Results.....	20
4.2 Conducted Emission Measurement.....	33
4.2.1 Limits of Conducted Emission Measurement.....	33
4.2.2 Test Instruments.....	33
4.2.3 Test Procedures.....	34
4.2.4 Deviation from Test Standard.....	34
4.2.5 Test Setup.....	34
4.2.6 EUT Operating Conditions.....	34
4.2.7 Test Results.....	35
4.3 6dB Bandwidth Measurement.....	37
4.3.1 Limits of 6dB Bandwidth Measurement.....	37
4.3.2 Test Setup.....	37
4.3.3 Test Instruments.....	37
4.3.4 Test Procedure.....	37
4.3.5 Deviation from Test Standard.....	37
4.3.6 EUT Operating Conditions.....	37
4.3.7 Test Result.....	38
4.4 Conducted Output Power Measurement.....	40
4.4.1 Limits of Conducted Output Power Measurement.....	40
4.4.2 Test Setup.....	40
4.4.3 Test Instruments.....	40
4.4.4 Test Procedures.....	40
4.4.5 Deviation from Test Standard.....	40
4.4.6 EUT Operating Conditions.....	40
4.4.7 Test Results.....	41
4.5 Power Spectral Density Measurement.....	42
4.5.1 Limits of Power Spectral Density Measurement.....	42
4.5.2 Test Setup.....	42
4.5.3 Test Instruments.....	42
4.5.4 Test Procedure.....	42
4.5.5 Deviation from Test Standard.....	43
4.5.6 EUT Operating Condition.....	43



4.5.7 Test Results	44
4.6 Conducted Out of Band Emission Measurement.....	47
4.6.1 Limits of Conducted Out of Band Emission Measurement	47
4.6.2 Test Setup.....	47
4.6.3 Test Instruments	47
4.6.4 Test Procedure	47
4.6.5 Deviation from Test Standard	48
4.6.6 EUT Operating Condition	48
4.6.7 Test Results	48
5 Pictures of Test Arrangements.....	61
Appendix – Information on the Testing Laboratories	62



A D T

Release Control Record

Issue No.	Description	Date Issued
RF130903C26I	Original release.	Apr. 19, 2016

1 Certificate of Conformity

Product: Wireless Access Point

Brand: riverbed

Test Model: DTAGA

Sample Status: Engineering sample

Applicant: Riverbed Technology Inc.

Test Date: Sep. 06 ~ Oct. 07, 2013 (Radiated emission below 1GHz & conducted emission tests)

Mar. 28 ~ Apr. 12, 2016 (All tests except Radiated emission below 1GHz & conducted emission tests)

Standards: 47 CFR FCC Part 15, Subpart C (Section 15.247)

ANSI C63.10:2013

The above equipment has been tested by **Bureau Veritas Consumer Products Services (H.K.) Ltd., Taoyuan Branch**, and found compliance with the requirement of the above standards. The test record, data evaluation & Equipment Under Test (EUT) configurations represented herein are true and accurate accounts of the measurements of the sample's EMC characteristics under the conditions specified in this report.

Prepared by :  , **Date:** Apr. 19, 2016
Ivy Lin / Specialist

Approved by :  , **Date:** Apr. 19, 2016
Ken Liu / Senior Manager

2 Summary of Test Results

47 CFR FCC Part 15, Subpart C (Section 15.247)			
FCC Clause	Test Item	Result	Remarks
15.207	AC Power Conducted Emission	Pass	Meet the requirement of limit. Minimum passing margin is -15.18dB at 4.23047MHz.
15.205 / 15.209 / 15.247(d)	Radiated Emissions and Band Edge Measurement	Pass	Meet the requirement of limit. Minimum passing margin is -0.8dB at 2390.00MHz
15.247(d)	Antenna Port Emission	Pass	Meet the requirement of limit.
15.247(a)(2)	6dB bandwidth	Pass	Meet the requirement of limit.
15.247(b)	Conducted power	Pass	Meet the requirement of limit.
15.247(e)	Power Spectral Density	Pass	Meet the requirement of limit.
15.203	Antenna Requirement	Pass	Antenna connector is N-type. (The device is professionally installed)

3 General Information

3.1 General Description of EUT

Product	Wireless Access Point
Brand	riverbed
Test Model	DTAGA
Sample Status	Engineering sample
Power Supply Rating	48Vdc from PoE
Modulation Type	CCK, DQPSK, DBPSK for DSSS 64QAM, 16QAM, QPSK, BPSK for OFDM
Modulation Technology	DSSS, OFDM
Transfer Rate	802.11b: 11.0/ 5.5/ 2.0/ 1.0Mbps 802.11g: 54.0/ 48.0/ 36.0/ 24.0/ 18.0/ 12.0/ 9.0/ 6.0Mbps 802.11n: up to 450Mbps
Operating Frequency	2412 ~ 2462MHz
Number of Channel	11 for 802.11b, 802.11g, 802.11n (HT20) 7 for 802.11n (HT40)
Output Power	501.054mW
Antenna Type	Dipole antenna with 5dBi gain
Antenna Connector	N-type (The device is professionally installed)
Accessory Device	POE, Adapter
Data Cable Supplied	0.55m non-shielded RJ45 cable without core

Note:

- The EUT incorporates a MIMO function. Physically, the EUT provides 3 completed transmitters and 3 receivers.

Modulation Mode	TX Function
802.11b	3TX
802.11g	3TX
802.11n (HT20)	3TX
802.11n (HT40)	3TX

- The EUT uses following PoE.

PoE	
Brand	EnGenius
Model	EPE-48GR
Power Rating	48Vdc, 0.8A, 38.4W Max

Adapter (For PoE)	
Brand	Powertron Electronics Corp.
Model	PA1040-480IB080
Input Power	100-240Vac, 50-60Hz, 1.5A
Output Power	48Vdc, 0.8A, 38.4W Max
Power Line	DC 1.6m power cable with 1 core attached on adapter

3.2 Description of Test Modes

11 channels are provided for 802.11b, 802.11g and 802.11n (HT20):

Channel	Frequency	Channel	Frequency
1	2412MHz	7	2442MHz
2	2417MHz	8	2447MHz
3	2422MHz	9	2452MHz
4	2427MHz	10	2457MHz
5	2432MHz	11	2462MHz
6	2437MHz		

7 channels are provided for 802.11n (HT40):

Channel	Frequency	Channel	Frequency
3	2422MHz	7	2442MHz
4	2427MHz	8	2447MHz
5	2432MHz	9	2452MHz
6	2437MHz		

3.2.1 Test Mode Applicability and Tested Channel Detail

EUT CONFIGURE MODE	APPLICABLE TO				DESCRIPTION
	RE \geq 1G	RE $<$ 1G	PLC	APCM	
-	√	√	√	√	-

Where **RE \geq 1G**: Radiated Emission above 1GHz & Bandedge Measurement
RE $<$ 1G: Radiated Emission below 1GHz
PLC: Power Line Conducted Emission
APCM: Antenna Port Conducted Measurement

Note:

1. For radiated emission below 1GHz test, the EUT had been pre-tested on the positioned of each 3 axis. The worst case was found when positioned on **Y-plane**.
2. For radiated emission above 1GHz, the EUT had been pre-tested on the positioned of each 3 axis. The worst case was found when positioned on **Z-plane**.

Radiated Emission Test (Above 1GHz):

- Pre-Scan has been conducted to determine the worst-case mode from all possible combinations between available modulations, data rates and antenna ports (if EUT with antenna diversity architecture).
- Following channel(s) was (were) selected for the final test as listed below.

EUT CONFIGURE MODE	MODE	AVAILABLE CHANNEL	TESTED CHANNEL	MODULATION TECHNOLOGY	MODULATION TYPE	DATA RATE (Mbps)
-	802.11b	1 to 11	1, 6, 11	DSSS	DBPSK	1.0
-	802.11g	1 to 11	1, 6, 11	OFDM	BPSK	6.0
-	802.11n (HT20)	1 to 11	1, 6, 11	OFDM	BPSK	7.2
-	802.11n (HT40)	3 to 9	3, 6, 9	OFDM	BPSK	15.0

Radiated Emission Test (Below 1GHz):

- Pre-Scan has been conducted to determine the worst-case mode from all possible combinations between available modulations, data rates and antenna ports (if EUT with antenna diversity architecture).
- Following channel(s) was (were) selected for the final test as listed below.

EUT CONFIGURE MODE	MODE	AVAILABLE CHANNEL	TESTED CHANNEL	MODULATION TECHNOLOGY	MODULATION TYPE	DATA RATE (Mbps)
-	802.11n (HT20)	1 to 11	11	OFDM	BPSK	7.2

Power Line Conducted Emission Test:

- Pre-Scan has been conducted to determine the worst-case mode from all possible combinations between available modulations, data rates and antenna ports (if EUT with antenna diversity architecture).
- Following channel(s) was (were) selected for the final test as listed below.

EUT CONFIGURE MODE	MODE	AVAILABLE CHANNEL	TESTED CHANNEL	MODULATION TECHNOLOGY	MODULATION TYPE	DATA RATE (Mbps)
-	802.11n (HT20)	1 to 11	11	OFDM	BPSK	7.2

Antenna Port Conducted Measurement:

- This item includes all test value of each mode, but only includes spectrum plot of worst value of each mode.
- Pre-Scan has been conducted to determine the worst-case mode from all possible combinations between available modulations, data rates and antenna ports (if EUT with antenna diversity architecture).
- Following channel(s) was (were) selected for the final test as listed below.

EUT CONFIGURE MODE	MODE	AVAILABLE CHANNEL	TESTED CHANNEL	MODULATION TECHNOLOGY	MODULATION TYPE	DATA RATE (Mbps)
-	802.11b	1 to 11	1, 6, 11	DSSS	DBPSK	1.0
-	802.11g	1 to 11	1, 6, 11	OFDM	BPSK	6.0
-	802.11n (HT20)	1 to 11	1, 6, 11	OFDM	BPSK	7.2
-	802.11n (HT40)	3 to 9	3, 6, 9	OFDM	BPSK	15.0

Test Condition:

APPLICABLE TO	ENVIRONMENTAL CONDITIONS	INPUT POWER (POE)	TESTED BY
RE\geq1G	16deg. C, 70%RH	48Vdc	Nick Hsu
RE$<$1G	26deg. C, 67%RH	48Vdc	Cedric Wu
PLC	26deg. C, 67%RH	48Vdc	Alan Wu
APCM	25deg. C, 60%RH	48Vdc	Leo Tsai

3.3 Duty Cycle of Test Signal

Duty cycle of test signal is > 98 %, duty factor is not required.

802.11b: Duty cycle = $12.175/12.235 = 0.995$

Duty cycle of test signal is < 98 %, duty factor shall be considered.

802.11g: Duty cycle = $2.021/2.076 = 0.974$, Duty factor = $10 * \log(1/0.974) = 0.12$

802.11n (HT20): Duty cycle = $1.884/1.935 = 0.974$, Duty factor = $10 * \log(1/0.974) = 0.12$

802.11n (HT40): Duty cycle = $0.926/0.970 = 0.955$, Duty factor = $10 * \log(1/0.955) = 0.20$

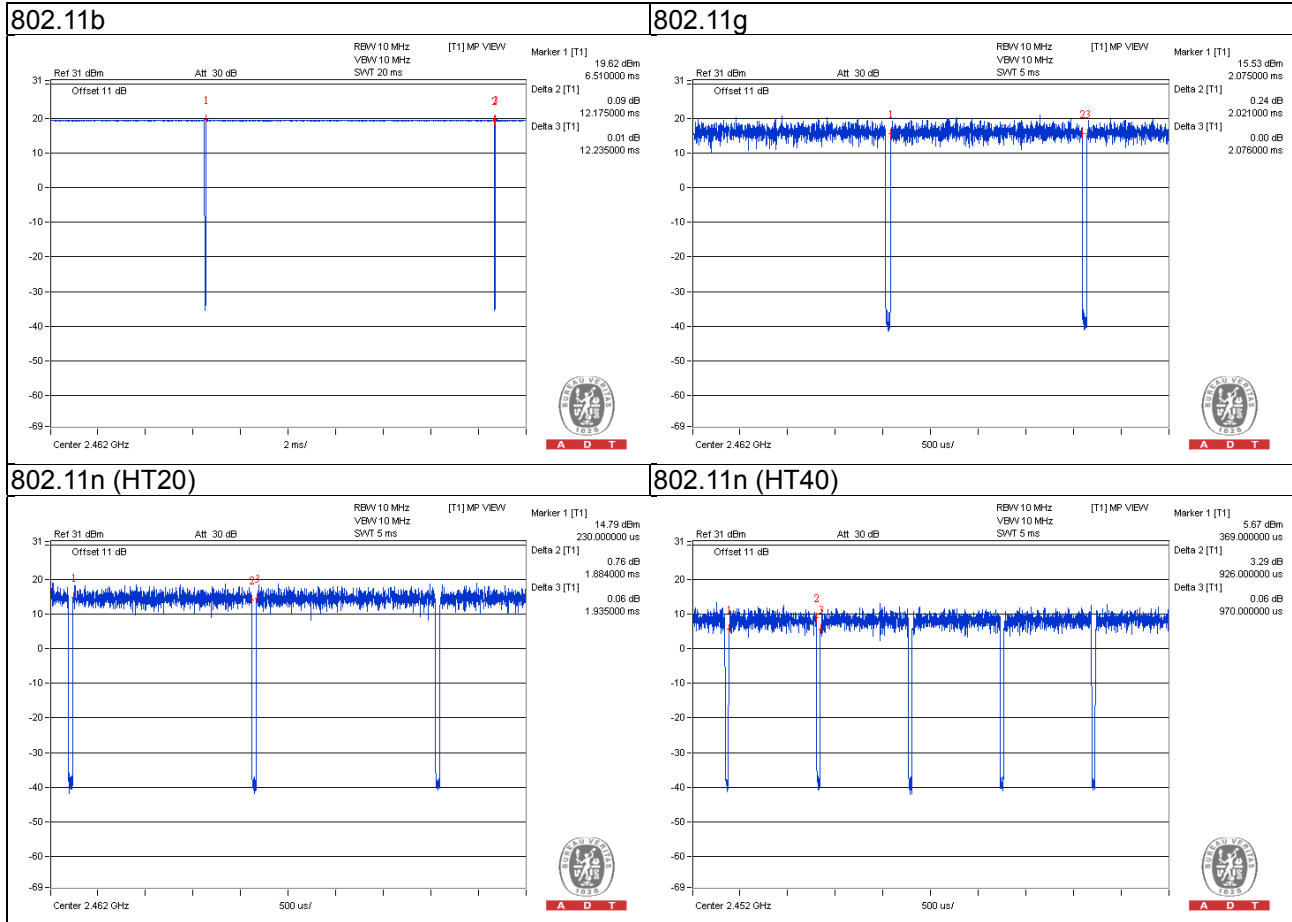

3.4 Description of Support Units

The EUT has been tested as an independent unit together with other necessary accessories or support units. The following support units or accessories were used to form a representative test configuration during the tests.

ID	Product	Brand	Model No.	Serial No.	FCC ID	Remarks
A.	Notebook	DELL	E5410	6RP2YM1	FCC DoC Approved	-
B.	Notebook	DELL	E5410	1HC2XM1	FCC DoC Approved	-
C.	Load	NA	NA	NA	NA	-

Note:

1. All power cords of the above support units are non-shielded (1.8m).
2. Item A acted as communication partners to transfer data.

ID	Descriptions	Qty.	Length (m)	Shielding (Yes/No)	Cores (Qty.)	Remarks
1.	RJ45	1	1.8	N	0	-
2.	RJ45	1	10	N	0	-
3.	Ground cable	1	1.7	N	0	-
4.	RJ45 cable	1	0.55	N	0	Accessory
5.	RJ45 cable	1	5	N	0	-
6.	RJ45 cable	1	1	N	0	-

3.4.1 Configuration of System under Test

Radiated emission below 1GHz & conducted emission tests

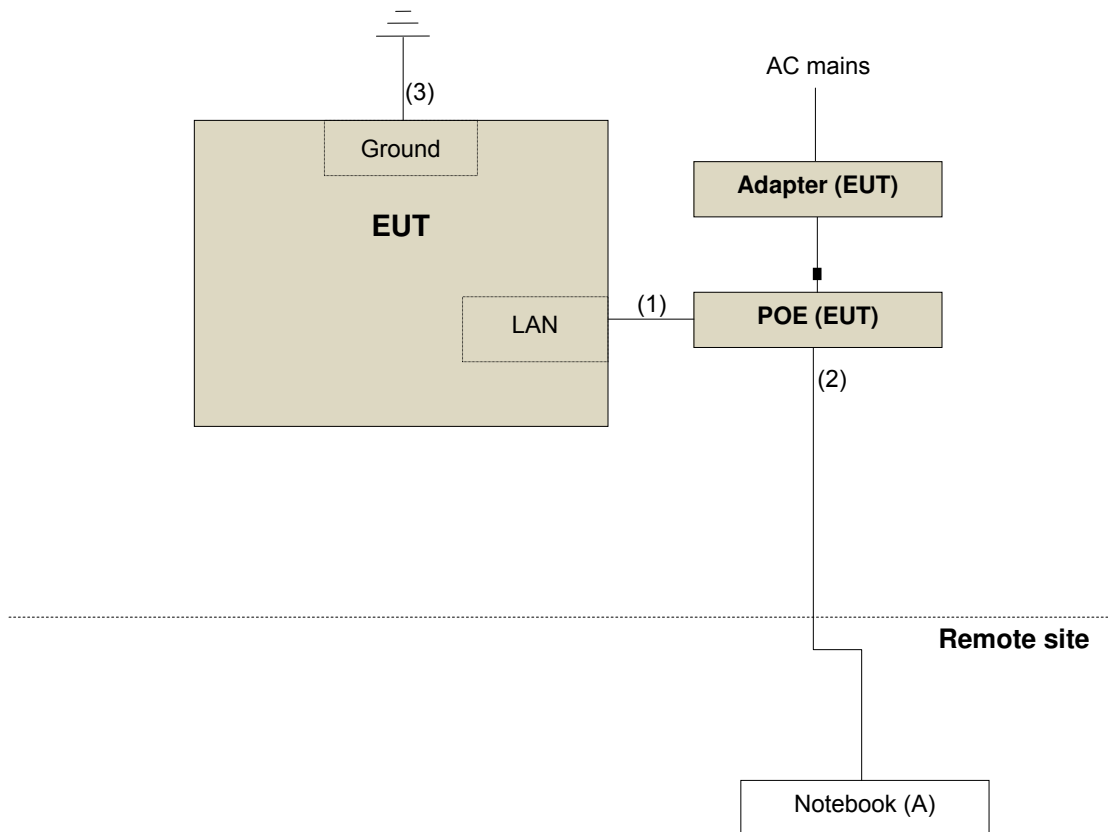

Radiated emission above 1GHz test

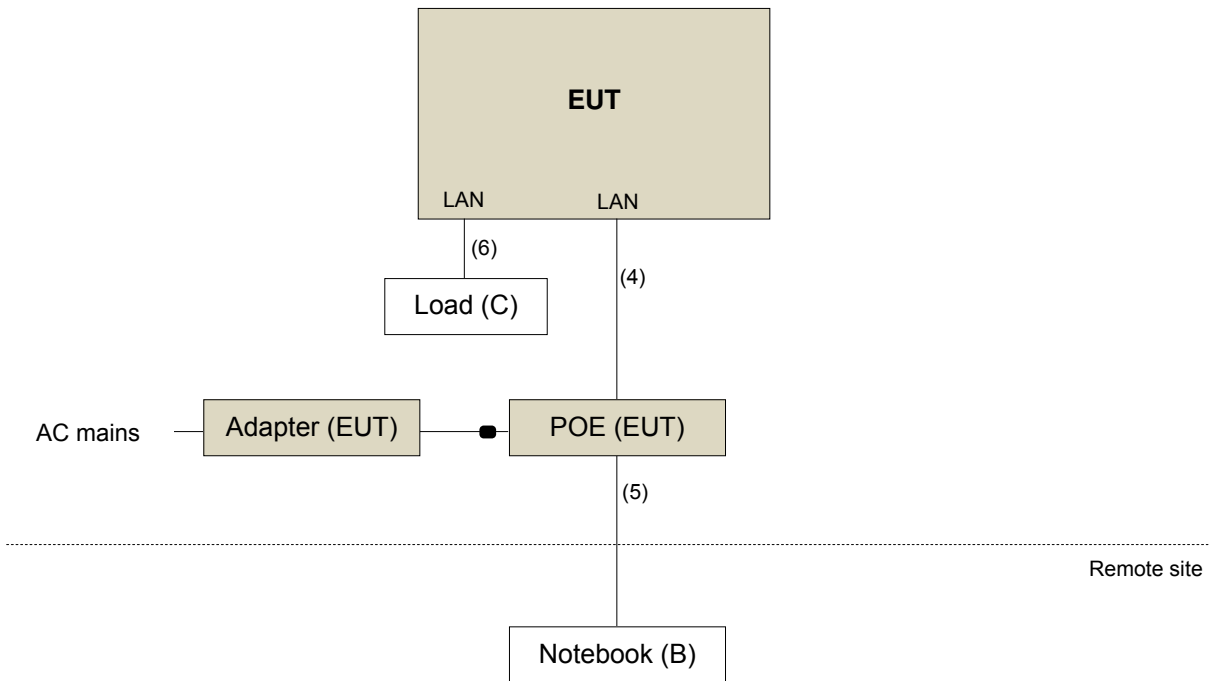

3.5 General Description of Applied Standards

The EUT is a RF Product. According to the specifications of the manufacturer, it must comply with the requirements of the following standards:

FCC Part 15, Subpart C (15.247)

558074 D01 DTS Meas Guidance v03r05

662911 D01 Multiple Transmitter Output v02r01

ANSI C63.10-2013

All test items have been performed and recorded as per the above standards.

Note: The EUT is also considered as a kind of computer peripheral, because the connection to computer is necessary for typical use. It has been verified to comply with the requirements of FCC Part 15, Subpart B, Class B (DoC). The test report has been issued separately.

4 Test Types and Results

4.1 Radiated Emission and Bandedge Measurement

4.1.1 Limits of Radiated Emission and Bandedge Measurement

Radiated emissions which fall in the restricted bands must comply with the radiated emission limits specified as below table. Other emissions shall be at least 30dB below the highest level of the desired power:

Frequencies (MHz)	Field Strength (microvolts/meter)	Measurement Distance (meters)
0.009 ~ 0.490	2400/F(kHz)	300
0.490 ~ 1.705	24000/F(kHz)	30
1.705 ~ 30.0	30	30
30 ~ 88	100	3
88 ~ 216	150	3
216 ~ 960	200	3
Above 960	500	3

Note:

1. The lower limit shall apply at the transition frequencies.
2. Emission level (dBuV/m) = 20 log Emission level (uV/m).
3. For frequencies above 1000MHz, the field strength limits are based on average detector, however, the peak field strength of any emission shall not exceed the maximum permitted average limits, specified above by more than 30dB under any condition of modulation.

4.1.2 Test Instruments

Test Date: Sep. 06, 2013

Description & Manufacturer	Model No.	Serial No.	Date of Calibration	Due Date of Calibration
Test Receiver ROHDE & SCHWARZ	ESI7	838496/016	Dec. 25, 2012	Dec. 24, 2013
Spectrum Analyzer ROHDE & SCHWARZ	FSP40	100039	Jan. 31, 2013	Jan. 30, 2014
BILOG Antenna SCHWARZBECK	VULB9168	9168-160	Mar. 20, 2013	Mar. 19, 2014
HORN Antenna SCHWARZBECK	BBHA 9120 D	9120D-404	Dec. 22, 2012	Dec. 21, 2013
HORN Antenna SCHWARZBECK	BBHA 9170	148	Jul. 15, 2013	Jul. 14, 2014
Preamplifier Agilent	8447D	2944A10633	Oct. 25, 2012	Oct. 24, 2013
Preamplifier Agilent	8449B	3008A01964	Oct. 25, 2012	Oct. 24, 2013
RF signal cable HUBER+SUHNNER	SUCOFLEX 104	250723/4	Aug. 23, 2013	Aug. 22, 2014
RF signal cable HUBER+SUHNNER	SUCOFLEX 106	12738/6+309224/4	Aug. 23, 2013	Aug. 22, 2014
Software BV ADT	ADT_Radiated_ V7.6.15.9.4	NA	NA	NA
Antenna Tower inn-co GmbH	MA 4000	013303	NA	NA
Antenna Tower Controller inn-co GmbH	CO2000	017303	NA	NA
Turn Table BV ADT	TT100	TT93021703	NA	NA
Turn Table Controller BV ADT	SC100	SC93021703	NA	NA
High Speed Peak Power Meter	ML2495A	0824011	Jul. 29, 2013	Jul. 28, 2014
Power Sensor	MA2411B	0738171	Jul. 29, 2013	Jul. 28, 2014

- NOTE:**
1. The calibration interval of the above test instruments is 12 months and the calibrations are traceable to NML/ROC and NIST/USA.
 2. The test was performed in HwaYa Chamber 3.
 3. The horn antenna and preamplifier (model: 8449B) are used only for the measurement of emission frequency above 1GHz if tested.
 4. The FCC Site Registration No. is 988962.
 5. The IC Site Registration No. is IC 7450F-3.

Test Date: Mar. 28 ~ Apr. 12, 2016

Description & Manufacturer	Model No.	Serial No.	Cal. Date	Cal. Due
Test Receiver ROHDE & SCHWARZ	ESCI	100424	Oct. 12, 2015	Oct. 11, 2016
Spectrum Analyzer ROHDE & SCHWARZ	FSP40	100041	Sep. 02, 2015	Sep. 01, 2016
BILOG Antenna SCHWARZBECK	VULB9168	9168-171	Jan. 07, 2016	Jan. 06, 2017
HORN Antenna SCHWARZBECK	9120D	209	Jan. 20, 2016	Jan. 19, 2017
HORN Antenna SCHWARZBECK	BBHA 9170	BBHA9170241	Jan. 18, 2016	Jan. 17, 2017
Preamplifier Agilent	8447D	2944A10738	Oct. 18, 2015	Oct. 17, 2016
Preamplifier Agilent	8449B	3008A01964	Aug. 22, 2015	Aug. 21, 2016
RF signal cable HUBER+SUHNER	SUCOFLEX 104	Cable-CH3-03 (214378)	Aug. 22, 2015	Aug. 21, 2016
RF signal cable HUBER+SUHNER	SUCOFLEX 106	Cable-CH3-03 (309224+12738)	Aug. 22, 2015	Aug. 21, 2016
Software BV ADT	ADT_Radiated_ V7.6.15.9.4	NA	NA	NA
Antenna Tower inn-co GmbH	MA 4000	013303	NA	NA
Antenna Tower Controller BV ADT	AT100	AT93021702	NA	NA
Turn Table BV ADT	TT100	TT93021702	NA	NA
Turn Table Controller BV ADT	SC100	SC93021702	NA	NA
High Speed Peak Power Meter	ML2495A	0824011	Jul. 09, 2015	Jul. 08, 2016
Power Sensor	MA2411B	0738171	Jul. 09, 2015	Jul. 08, 2016

- Note:
1. The calibration interval of the above test instruments is 12 months and the calibrations are traceable to NML/ROC and NIST/USA.
 2. The test was performed in HwaYa Chamber 3.
 3. The horn antenna and preamplifier (model: 8449B) are used only for the measurement of emission frequency above 1GHz if tested.
 4. The FCC Site Registration No. is 988962.
 5. The IC Site Registration No. is IC 7450F-3.

4.1.3 Test Procedures

- a. The EUT was placed on the top of a rotating table 0.8 meters (for below 1GHz) / 1.5 meters (for above 1GHz) above the ground at 3 meter chamber room for test. The table was rotated 360 degrees to determine the position of the highest radiation.
- b. The EUT was set 3 meters away from the interference-receiving antenna, which was mounted on the top of a variable-height antenna tower.
- c. The height of antenna is varied from one meter to four meters above the ground to determine the maximum value of the field strength. Both horizontal and vertical polarizations of the antenna are set to make the measurement.
- d. For each suspected emission, the EUT was arranged to its worst case and then the antenna was tuned to heights from 1 meter to 4 meters and the rotatable table was turned from 0 degrees to 360 degrees to find the maximum reading.
- e. The test-receiver system was set to quasi-peak detect function and specified bandwidth with maximum hold mode when the test frequency is below 1 GHz.
- f. The test-receiver system was set to peak and average detect function and specified bandwidth with maximum hold mode when the test frequency is above 1 GHz. If the peak reading value also meets average limit, measurement with the average detector is unnecessary.

Note:

1. The resolution bandwidth and video bandwidth of test receiver/spectrum analyzer is 120kHz for Quasi-peak detection (QP) at frequency below 1GHz.
2. The resolution bandwidth of test receiver/spectrum analyzer is 1 MHz and the video bandwidth is 3 MHz for Peak detection (PK) at frequency above 1GHz.
3. The resolution bandwidth of test receiver/spectrum analyzer is 1MHz and the video bandwidth is 3MHz for RMS Average (Duty cycle < 98%) for Average detection (AV) at frequency above 1GHz, then the measurement results was added to a correction factor ($10 \log(1/\text{duty cycle})$).
4. The resolution bandwidth of test receiver/spectrum analyzer is 1MHz and the video bandwidth is 10Hz (Duty cycle $\geq 98\%$) for Average detection (AV) at frequency above 1GHz.
5. All modes of operation were investigated and the worst-case emissions are reported.

4.1.4 Deviation from Test Standard

No deviation.

4.1.5 Test Set Up

<Frequency Range below 1GHz>

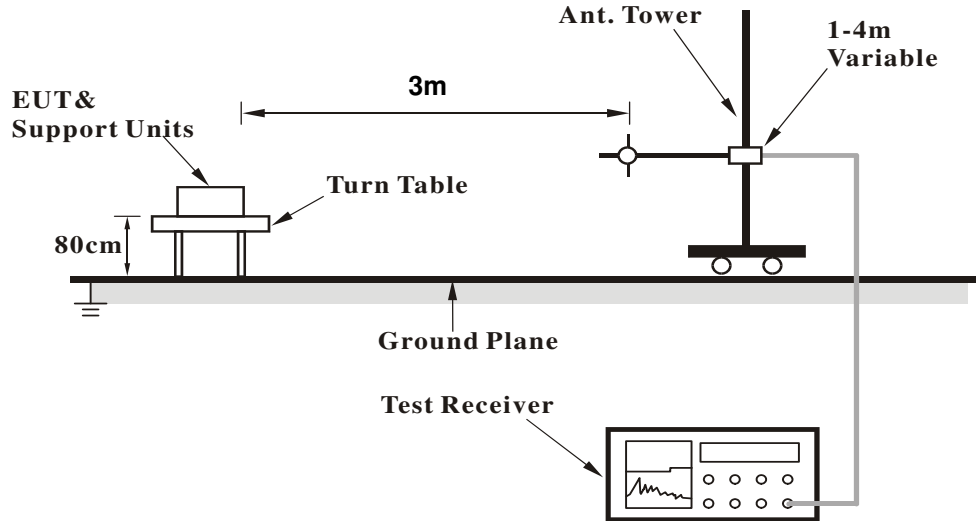

<Frequency Range above 1GHz>

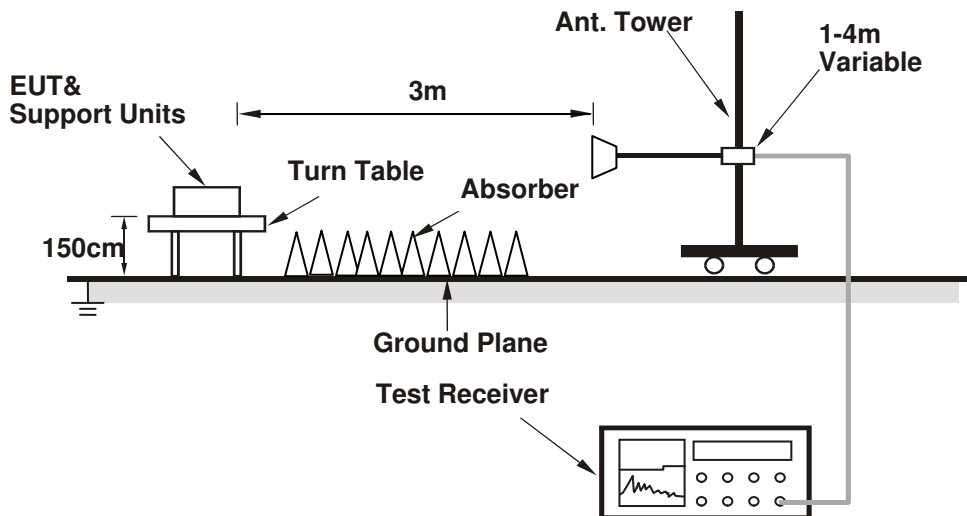

For the actual test configuration, please refer to the attached file (Test Setup Photo).

4.1.6 EUT Operating Conditions

- a. Placed the EUT on the testing table.
- b. Prepared notebook to act as communication partner and placed it outside of testing area.
- c. The communication partner connected with EUT via a RJ45 cable and ran a test program (provided by manufacturer) to enable EUT under transmission condition continuously at specific channel frequency.
- d. The communication partner sent data to EUT by command "PING".

4.1.7 Test Results

Above 1GHz worst-case data:

802.11b

CHANNEL	TX Channel 1	DETECTOR	Peak (PK)
FREQUENCY RANGE	1GHz ~ 25GHz	FUNCTION	Average (AV)

ANTENNA POLARITY & TEST DISTANCE: HORIZONTAL AT 3 M

NO.	FREQ. (MHz)	EMISSION LEVEL (dBuV/m)	LIMIT (dBuV/m)	MARGIN (dB)	ANTENNA HEIGHT (m)	TABLE ANGLE (Degree)	RAW VALUE (dBuV)	CORRECTION FACTOR (dB/m)
1	2372.00	58.5 PK	74.0	-15.5	1.10 H	154	25.80	32.70
2	2372.00	47.0 AV	54.0	-7.0	1.10 H	154	14.30	32.70
3	*2412.00	110.0 PK			1.04 H	144	77.10	32.90
4	*2412.00	106.0 AV			1.04 H	144	73.10	32.90
5	4824.00	47.3 PK	74.0	-26.7	1.23 H	82	41.40	5.90
6	4824.00	34.9 AV	54.0	-19.1	1.23 H	82	29.00	5.90

ANTENNA POLARITY & TEST DISTANCE: VERTICAL AT 3 M

NO.	FREQ. (MHz)	EMISSION LEVEL (dBuV/m)	LIMIT (dBuV/m)	MARGIN (dB)	ANTENNA HEIGHT (m)	TABLE ANGLE (Degree)	RAW VALUE (dBuV)	CORRECTION FACTOR (dB/m)
1	2372.00	63.3 PK	74.0	-10.7	1.70 V	163	30.60	32.70
2	2372.00	52.8 AV	54.0	-1.2	1.70 V	163	20.10	32.70
3	*2412.00	119.4 PK			2.46 V	162	86.50	32.90
4	*2412.00	116.0 AV			2.46 V	162	83.10	32.90
5	4824.00	48.2 PK	74.0	-25.8	1.36 V	72	42.30	5.90
6	4824.00	35.7 AV	54.0	-18.3	1.36 V	72	29.80	5.90

REMARKS:

1. Emission Level(dBuV/m) = Raw Value(dBuV) + Correction Factor(dB/m)
2. Correction Factor(dB/m) = Antenna Factor(dB/m) + Cable Factor(dB)
3. The other emission levels were very low against the limit.
4. Margin value = Emission Level – Limit value
5. " * ": Fundamental frequency.

CHANNEL	TX Channel 6	DETECTOR FUNCTION	Peak (PK)
FREQUENCY RANGE	1GHz ~ 25GHz		Average (AV)

ANTENNA POLARITY & TEST DISTANCE: HORIZONTAL AT 3 M								
NO.	FREQ. (MHz)	EMISSION LEVEL (dBuV/m)	LIMIT (dBuV/m)	MARGIN (dB)	ANTENNA HEIGHT (m)	TABLE ANGLE (Degree)	RAW VALUE (dBuV)	CORRECTION FACTOR (dB/m)
1	2360.00	61.8 PK	74.0	-12.2	1.07 H	147	29.10	32.70
2	2360.00	46.5 AV	54.0	-7.5	1.07 H	147	13.80	32.70
3	*2437.00	110.7 PK			1.35 H	149	77.80	32.90
4	*2437.00	107.1 AV			1.35 H	149	74.20	32.90
5	4874.00	48.8 PK	74.0	-25.2	1.30 H	238	42.80	6.00
6	4874.00	35.6 AV	54.0	-18.4	1.30 H	238	29.60	6.00

ANTENNA POLARITY & TEST DISTANCE: VERTICAL AT 3 M								
NO.	FREQ. (MHz)	EMISSION LEVEL (dBuV/m)	LIMIT (dBuV/m)	MARGIN (dB)	ANTENNA HEIGHT (m)	TABLE ANGLE (Degree)	RAW VALUE (dBuV)	CORRECTION FACTOR (dB/m)
1	2360.00	73.0 PK	74.0	-1.0	1.79 V	156	40.30	32.70
2	2360.00	51.9 AV	54.0	-2.1	1.79 V	156	19.20	32.70
3	*2437.00	122.5 PK			1.63 V	163	89.60	32.90
4	*2437.00	119.1 AV			1.63 V	163	86.20	32.90
5	4874.00	56.7 PK	74.0	-17.3	1.62 V	148	50.70	6.00
6	4874.00	52.7 AV	54.0	-1.3	1.62 V	148	46.70	6.00

REMARKS:

1. Emission Level(dBuV/m) = Raw Value(dBuV) + Correction Factor(dB/m)
2. Correction Factor(dB/m) = Antenna Factor(dB/m) + Cable Factor(dB)
3. The other emission levels were very low against the limit.
4. Margin value = Emission Level – Limit value
5. " * ": Fundamental frequency.

CHANNEL	TX Channel 11	DETECTOR FUNCTION	Peak (PK)
FREQUENCY RANGE	1GHz ~ 25GHz		Average (AV)

ANTENNA POLARITY & TEST DISTANCE: HORIZONTAL AT 3 M

NO.	FREQ. (MHz)	EMISSION LEVEL (dBuV/m)	LIMIT (dBuV/m)	MARGIN (dB)	ANTENNA HEIGHT (m)	TABLE ANGLE (Degree)	RAW VALUE (dBuV)	CORRECTION FACTOR (dB/m)
1	2360.00	65.6 PK	74.0	-8.4	1.70 H	321	32.90	32.70
2	2360.00	45.7 AV	54.0	-8.3	1.70 H	321	13.00	32.70
3	*2462.00	105.9 PK			1.87 H	324	73.00	32.90
4	*2462.00	102.5 AV			1.87 H	324	69.60	32.90
5	2483.50	57.6 PK	74.0	-16.4	1.40 H	306	24.60	33.00
6	2483.50	45.9 AV	54.0	-8.1	1.40 H	306	12.90	33.00
7	4924.00	48.2 PK	74.0	-25.8	1.24 H	238	42.20	6.00
8	4924.00	35.5 AV	54.0	-18.5	1.24 H	238	29.50	6.00

ANTENNA POLARITY & TEST DISTANCE: VERTICAL AT 3 M

NO.	FREQ. (MHz)	EMISSION LEVEL (dBuV/m)	LIMIT (dBuV/m)	MARGIN (dB)	ANTENNA HEIGHT (m)	TABLE ANGLE (Degree)	RAW VALUE (dBuV)	CORRECTION FACTOR (dB/m)
1	2360.00	66.8 PK	74.0	-7.2	1.78 V	357	34.10	32.70
2	2360.00	52.4 AV	54.0	-1.6	1.78 V	357	19.70	32.70
3	*2462.00	120.4 PK			1.80 V	334	87.50	32.90
4	*2462.00	116.6 AV			1.80 V	334	83.70	32.90
5	2483.50	62.9 PK	74.0	-11.1	1.82 V	339	29.90	33.00
6	2483.50	51.4 AV	54.0	-2.6	1.82 V	339	18.40	33.00
7	4924.00	50.1 PK	74.0	-23.9	2.82 V	305	44.10	6.00
8	4924.00	40.7 AV	54.0	-13.3	2.82 V	305	34.70	6.00

REMARKS:

1. Emission Level(dBuV/m) = Raw Value(dBuV) + Correction Factor(dB/m)
2. Correction Factor(dB/m) = Antenna Factor(dB/m) + Cable Factor(dB)
3. The other emission levels were very low against the limit.
4. Margin value = Emission Level – Limit value
5. " * ": Fundamental frequency.

802.11g

CHANNEL	TX Channel 1	DETECTOR FUNCTION	Peak (PK)
FREQUENCY RANGE	1GHz ~ 25GHz		Average (AV)

ANTENNA POLARITY & TEST DISTANCE: HORIZONTAL AT 3 M								
NO.	FREQ. (MHz)	EMISSION LEVEL (dBuV/m)	LIMIT (dBuV/m)	MARGIN (dB)	ANTENNA HEIGHT (m)	TABLE ANGLE (Degree)	RAW VALUE (dBuV)	CORRECTION FACTOR (dB/m)
1	2320.00	56.4 PK	74.0	-17.6	1.14 H	137	23.90	32.50
2	2320.00	46.0 AV	54.0	-8.0	1.14 H	137	13.50	32.50
3	*2412.00	104.5 PK			1.00 H	147	71.60	32.90
4	*2412.00	94.9 AV			1.00 H	147	62.00	32.90
5	4824.00	47.7 PK	74.0	-26.3	1.30 H	108	41.80	5.90
6	4824.00	34.8 AV	54.0	-19.2	1.30 H	108	28.90	5.90
ANTENNA POLARITY & TEST DISTANCE: VERTICAL AT 3 M								
NO.	FREQ. (MHz)	EMISSION LEVEL (dBuV/m)	LIMIT (dBuV/m)	MARGIN (dB)	ANTENNA HEIGHT (m)	TABLE ANGLE (Degree)	RAW VALUE (dBuV)	CORRECTION FACTOR (dB/m)
1	2320.00	65.0 PK	74.0	-9.0	1.83 V	160	32.50	32.50
2	2320.00	52.2 AV	54.0	-1.8	1.83 V	160	19.70	32.50
3	*2412.00	118.5 PK			1.75 V	348	85.60	32.90
4	*2412.00	108.5 AV			1.75 V	348	75.60	32.90
5	4824.00	47.2 PK	74.0	-26.8	1.43 V	256	41.30	5.90
6	4824.00	34.9 AV	54.0	-19.1	1.43 V	256	29.00	5.90

REMARKS:

1. Emission Level(dBuV/m) = Raw Value(dBuV) + Correction Factor(dB/m)
2. Correction Factor(dB/m) = Antenna Factor(dB/m) + Cable Factor(dB)
3. The other emission levels were very low against the limit.
4. Margin value = Emission Level – Limit value
5. " * ": Fundamental frequency.

CHANNEL	TX Channel 6	DETECTOR FUNCTION	Peak (PK)
FREQUENCY RANGE	1GHz ~ 25GHz		Average (AV)

ANTENNA POLARITY & TEST DISTANCE: HORIZONTAL AT 3 M								
NO.	FREQ. (MHz)	EMISSION LEVEL (dBuV/m)	LIMIT (dBuV/m)	MARGIN (dB)	ANTENNA HEIGHT (m)	TABLE ANGLE (Degree)	RAW VALUE (dBuV)	CORRECTION FACTOR (dB/m)
1	2320.00	58.4 PK	74.0	-15.6	1.10 H	145	25.90	32.50
2	2320.00	46.0 AV	54.0	-8.0	1.10 H	145	13.50	32.50
3	*2437.00	110.8 PK			1.00 H	143	77.90	32.90
4	*2437.00	101.2 AV			1.00 H	143	68.30	32.90
5	4874.00	47.4 PK	74.0	-26.6	1.34 H	117	41.40	6.00
6	4874.00	35.3 AV	54.0	-18.7	1.34 H	117	29.30	6.00

ANTENNA POLARITY & TEST DISTANCE: VERTICAL AT 3 M								
NO.	FREQ. (MHz)	EMISSION LEVEL (dBuV/m)	LIMIT (dBuV/m)	MARGIN (dB)	ANTENNA HEIGHT (m)	TABLE ANGLE (Degree)	RAW VALUE (dBuV)	CORRECTION FACTOR (dB/m)
1	2320.00	68.0 PK	74.0	-6.0	1.82 V	156	35.50	32.50
2	2320.00	52.2 AV	54.0	-1.8	1.82 V	156	19.70	32.50
3	*2437.00	120.7 PK			1.72 V	180	87.80	32.90
4	*2437.00	110.8 AV			1.72 V	180	77.90	32.90
5	4874.00	47.8 PK	74.0	-26.2	1.28 V	224	41.80	6.00
6	4874.00	35.2 AV	54.0	-18.8	1.28 V	224	29.20	6.00

REMARKS:

1. Emission Level(dBuV/m) = Raw Value(dBuV) + Correction Factor(dB/m)
2. Correction Factor(dB/m) = Antenna Factor(dB/m) + Cable Factor(dB)
3. The other emission levels were very low against the limit.
4. Margin value = Emission Level – Limit value
5. " * ": Fundamental frequency.

CHANNEL	TX Channel 11	DETECTOR FUNCTION	Peak (PK)
FREQUENCY RANGE	1GHz ~ 25GHz		Average (AV)

ANTENNA POLARITY & TEST DISTANCE: HORIZONTAL AT 3 M

NO.	FREQ. (MHz)	EMISSION LEVEL (dBuV/m)	LIMIT (dBuV/m)	MARGIN (dB)	ANTENNA HEIGHT (m)	TABLE ANGLE (Degree)	RAW VALUE (dBuV)	CORRECTION FACTOR (dB/m)
1	2360.00	57.3 PK	74.0	-16.7	1.40 H	125	24.60	32.70
2	2360.00	46.0 AV	54.0	-8.0	1.40 H	125	13.30	32.70
3	*2462.00	107.2 PK			1.00 H	142	74.30	32.90
4	*2462.00	97.6 AV			1.00 H	142	64.70	32.90
5	2483.50	58.2 PK	74.0	-15.8	1.18 H	143	25.20	33.00
6	2483.50	47.0 AV	54.0	-7.0	1.18 H	143	14.00	33.00
7	4924.00	48.2 PK	74.0	-25.8	1.18 H	59	42.20	6.00
8	4924.00	35.1 AV	54.0	-18.9	1.18 H	59	29.10	6.00

ANTENNA POLARITY & TEST DISTANCE: VERTICAL AT 3 M

NO.	FREQ. (MHz)	EMISSION LEVEL (dBuV/m)	LIMIT (dBuV/m)	MARGIN (dB)	ANTENNA HEIGHT (m)	TABLE ANGLE (Degree)	RAW VALUE (dBuV)	CORRECTION FACTOR (dB/m)
1	2360.00	64.1 PK	74.0	-9.9	1.78 V	153	31.40	32.70
2	2360.00	53.0 AV	54.0	-1.0	1.78 V	153	20.30	32.70
3	*2462.00	119.9 PK			1.77 V	343	87.00	32.90
4	*2462.00	109.5 AV			1.77 V	343	76.60	32.90
5	2483.50	69.3 PK	74.0	-4.7	1.83 V	153	36.30	33.00
6	2483.50	52.2 AV	54.0	-1.8	1.83 V	153	19.20	33.00
7	4924.00	48.0 PK	74.0	-26.0	1.52 V	239	42.00	6.00
8	4924.00	35.3 AV	54.0	-18.7	1.52 V	239	29.30	6.00

REMARKS:

1. Emission Level(dBuV/m) = Raw Value(dBuV) + Correction Factor(dB/m)
2. Correction Factor(dB/m) = Antenna Factor(dB/m) + Cable Factor(dB)
3. The other emission levels were very low against the limit.
4. Margin value = Emission Level – Limit value
5. " * ": Fundamental frequency.

802.11n (HT20)

CHANNEL	TX Channel 1	DETECTOR FUNCTION	Peak (PK)
FREQUENCY RANGE	1GHz ~ 25GHz		Average (AV)

ANTENNA POLARITY & TEST DISTANCE: HORIZONTAL AT 3 M								
NO.	FREQ. (MHz)	EMISSION LEVEL (dBuV/m)	LIMIT (dBuV/m)	MARGIN (dB)	ANTENNA HEIGHT (m)	TABLE ANGLE (Degree)	RAW VALUE (dBuV)	CORRECTION FACTOR (dB/m)
1	2390.00	57.2 PK	74.0	-16.8	1.21 H	150	24.40	32.80
2	2390.00	45.5 AV	54.0	-8.5	1.21 H	150	12.70	32.80
3	*2412.00	104.1 PK			1.06 H	153	71.20	32.90
4	*2412.00	93.4 AV			1.06 H	153	60.50	32.90
5	4824.00	46.1 PK	74.0	-27.9	1.19 H	164	40.20	5.90
6	4824.00	33.2 AV	54.0	-20.8	1.19 H	164	27.30	5.90

ANTENNA POLARITY & TEST DISTANCE: VERTICAL AT 3 M								
NO.	FREQ. (MHz)	EMISSION LEVEL (dBuV/m)	LIMIT (dBuV/m)	MARGIN (dB)	ANTENNA HEIGHT (m)	TABLE ANGLE (Degree)	RAW VALUE (dBuV)	CORRECTION FACTOR (dB/m)
1	2390.00	69.9 PK	74.0	-4.1	1.98 V	340	37.10	32.80
2	2390.00	52.5 AV	54.0	-1.5	1.98 V	340	19.70	32.80
3	*2412.00	116.3 PK			1.94 V	359	83.40	32.90
4	*2412.00	106.6 AV			1.94 V	359	73.70	32.90
5	4824.00	47.8 PK	74.0	-26.2	1.54 V	126	41.90	5.90
6	4824.00	35.2 AV	54.0	-18.8	1.54 V	126	29.30	5.90

REMARKS:

1. Emission Level(dBuV/m) = Raw Value(dBuV) + Correction Factor(dB/m)
2. Correction Factor(dB/m) = Antenna Factor(dB/m) + Cable Factor(dB)
3. The other emission levels were very low against the limit.
4. Margin value = Emission Level – Limit value
5. " * ": Fundamental frequency.
6. " # ": The radiated frequency is out of the restricted band.

CHANNEL	TX Channel 6	DETECTOR FUNCTION	Peak (PK)
FREQUENCY RANGE	1GHz ~ 25GHz		Average (AV)

ANTENNA POLARITY & TEST DISTANCE: HORIZONTAL AT 3 M								
NO.	FREQ. (MHz)	EMISSION LEVEL (dBuV/m)	LIMIT (dBuV/m)	MARGIN (dB)	ANTENNA HEIGHT (m)	TABLE ANGLE (Degree)	RAW VALUE (dBuV)	CORRECTION FACTOR (dB/m)
1	2390.00	58.0 PK	74.0	-16.0	1.11 H	149	25.20	32.80
2	2390.00	46.8 AV	54.0	-7.2	1.11 H	149	14.00	32.80
3	*2437.00	109.3 PK			1.11 H	151	76.40	32.90
4	*2437.00	99.6 AV			1.11 H	151	66.70	32.90
5	4874.00	47.7 PK	74.0	-26.3	1.40 H	90	41.70	6.00
6	4874.00	34.7 AV	54.0	-19.3	1.40 H	90	28.70	6.00

ANTENNA POLARITY & TEST DISTANCE: VERTICAL AT 3 M								
NO.	FREQ. (MHz)	EMISSION LEVEL (dBuV/m)	LIMIT (dBuV/m)	MARGIN (dB)	ANTENNA HEIGHT (m)	TABLE ANGLE (Degree)	RAW VALUE (dBuV)	CORRECTION FACTOR (dB/m)
1	2360.00	70.2 PK	74.0	-3.8	1.91 V	0	37.50	32.70
2	2360.00	53.0 AV	54.0	-1.0	1.91 V	0	20.30	32.70
3	*2437.00	122.0 PK			1.86 V	351	89.10	32.90
4	*2437.00	112.8 AV			1.86 V	351	79.90	32.90
5	4874.00	48.5 PK	74.0	-25.5	1.70 V	70	42.50	6.00
6	4874.00	35.7 AV	54.0	-18.3	1.70 V	70	29.70	6.00

REMARKS:

1. Emission Level(dBuV/m) = Raw Value(dBuV) + Correction Factor(dB/m)
2. Correction Factor(dB/m) = Antenna Factor(dB/m) + Cable Factor(dB)
3. The other emission levels were very low against the limit.
4. Margin value = Emission Level – Limit value
5. " * ": Fundamental frequency.

CHANNEL	TX Channel 11	DETECTOR FUNCTION	Peak (PK)
FREQUENCY RANGE	1GHz ~ 25GHz		Average (AV)

ANTENNA POLARITY & TEST DISTANCE: HORIZONTAL AT 3 M

NO.	FREQ. (MHz)	EMISSION LEVEL (dBuV/m)	LIMIT (dBuV/m)	MARGIN (dB)	ANTENNA HEIGHT (m)	TABLE ANGLE (Degree)	RAW VALUE (dBuV)	CORRECTION FACTOR (dB/m)
1	*2462.00	102.1 PK			1.00 H	153	69.20	32.90
2	*2462.00	92.6 AV			1.00 H	153	59.70	32.90
3	2483.50	57.6 PK	74.0	-16.4	1.22 H	125	24.60	33.00
4	2483.50	46.4 AV	54.0	-7.6	1.22 H	125	13.40	33.00
5	4924.00	47.6 PK	74.0	-26.4	1.37 H	111	41.60	6.00
6	4924.00	34.3 AV	54.0	-19.7	1.37 H	111	28.30	6.00

ANTENNA POLARITY & TEST DISTANCE: VERTICAL AT 3 M

NO.	FREQ. (MHz)	EMISSION LEVEL (dBuV/m)	LIMIT (dBuV/m)	MARGIN (dB)	ANTENNA HEIGHT (m)	TABLE ANGLE (Degree)	RAW VALUE (dBuV)	CORRECTION FACTOR (dB/m)
1	*2462.00	117.1 PK			1.98 V	358	84.20	32.90
2	*2462.00	107.7 AV			1.98 V	358	74.80	32.90
3	2483.50	70.7 PK	74.0	-3.3	1.97 V	0	37.70	33.00
4	2483.50	53.0 AV	54.0	-1.0	1.97 V	0	20.00	33.00
5	4924.00	48.1 PK	74.0	-25.9	1.55 V	320	42.10	6.00
6	4924.00	35.0 AV	54.0	-19.0	1.55 V	320	29.00	6.00

REMARKS:

1. Emission Level(dBuV/m) = Raw Value(dBuV) + Correction Factor(dB/m)
2. Correction Factor(dB/m) = Antenna Factor(dB/m) + Cable Factor(dB)
3. The other emission levels were very low against the limit.
4. Margin value = Emission Level – Limit value
5. " * ": Fundamental frequency.

802.11n (HT40)

CHANNEL	TX Channel 3	DETECTOR FUNCTION	Peak (PK)
FREQUENCY RANGE	1GHz ~ 25GHz		Average (AV)

ANTENNA POLARITY & TEST DISTANCE: HORIZONTAL AT 3 M

NO.	FREQ. (MHz)	EMISSION LEVEL (dBuV/m)	LIMIT (dBuV/m)	MARGIN (dB)	ANTENNA HEIGHT (m)	TABLE ANGLE (Degree)	RAW VALUE (dBuV)	CORRECTION FACTOR (dB/m)
1	2390.00	58.5 PK	74.0	-15.5	2.50 H	200	25.70	32.80
2	2390.00	47.1 AV	54.0	-6.9	2.50 H	200	14.30	32.80
3	*2422.00	100.7 PK			1.64 H	335	67.80	32.90
4	*2422.00	91.3 AV			1.64 H	335	58.40	32.90
5	4844.00	47.4 PK	74.0	-26.6	1.79 H	154	41.60	5.80
6	4844.00	34.6 AV	54.0	-19.4	1.79 H	154	28.80	5.80

ANTENNA POLARITY & TEST DISTANCE: VERTICAL AT 3 M

NO.	FREQ. (MHz)	EMISSION LEVEL (dBuV/m)	LIMIT (dBuV/m)	MARGIN (dB)	ANTENNA HEIGHT (m)	TABLE ANGLE (Degree)	RAW VALUE (dBuV)	CORRECTION FACTOR (dB/m)
1	2390.00	69.8 PK	74.0	-4.2	1.63 V	148	37.00	32.80
2	2390.00	53.2 AV	54.0	-0.8	1.63 V	148	20.40	32.80
3	*2422.00	109.7 PK			1.99 V	342	76.80	32.90
4	*2422.00	100.7 AV			1.99 V	342	67.80	32.90
5	4844.00	48.1 PK	74.0	-25.9	1.66 V	73	42.30	5.80
6	4844.00	35.1 AV	54.0	-18.9	1.66 V	73	29.30	5.80

REMARKS:

1. Emission Level(dBuV/m) = Raw Value(dBuV) + Correction Factor(dB/m)
2. Correction Factor(dB/m) = Antenna Factor(dB/m) + Cable Factor(dB)
3. The other emission levels were very low against the limit.
4. Margin value = Emission Level – Limit value
5. " * ": Fundamental frequency.

CHANNEL	TX Channel 6	DETECTOR FUNCTION	Peak (PK)
FREQUENCY RANGE	1GHz ~ 25GHz		Average (AV)

ANTENNA POLARITY & TEST DISTANCE: HORIZONTAL AT 3 M

NO.	FREQ. (MHz)	EMISSION LEVEL (dBuV/m)	LIMIT (dBuV/m)	MARGIN (dB)	ANTENNA HEIGHT (m)	TABLE ANGLE (Degree)	RAW VALUE (dBuV)	CORRECTION FACTOR (dB/m)
1	2390.00	59.5 PK	74.0	-14.5	2.55 H	202	26.70	32.80
2	2390.00	48.3 AV	54.0	-5.7	2.55 H	202	15.50	32.80
3	*2437.00	103.9 PK			1.68 H	334	71.00	32.90
4	*2437.00	93.5 AV			1.68 H	334	60.60	32.90
5	4874.00	48.1 PK	74.0	-25.9	1.70 H	162	42.10	6.00
6	4874.00	35.6 AV	54.0	-18.4	1.70 H	162	29.60	6.00

ANTENNA POLARITY & TEST DISTANCE: VERTICAL AT 3 M

NO.	FREQ. (MHz)	EMISSION LEVEL (dBuV/m)	LIMIT (dBuV/m)	MARGIN (dB)	ANTENNA HEIGHT (m)	TABLE ANGLE (Degree)	RAW VALUE (dBuV)	CORRECTION FACTOR (dB/m)
1	2390.00	66.7 PK	74.0	-7.3	1.62 V	342	33.90	32.80
2	2390.00	53.0 AV	54.0	-1.0	1.62 V	342	20.20	32.80
3	*2437.00	114.6 PK			1.68 V	359	81.70	32.90
4	*2437.00	105.0 AV			1.68 V	359	72.10	32.90
5	4874.00	49.0 PK	74.0	-25.0	1.38 V	122	43.00	6.00
6	4874.00	35.3 AV	54.0	-18.7	1.38 V	122	29.30	6.00

REMARKS:

1. Emission Level(dBuV/m) = Raw Value(dBuV) + Correction Factor(dB/m)
2. Correction Factor(dB/m) = Antenna Factor(dB/m) + Cable Factor(dB)
3. The other emission levels were very low against the limit.
4. Margin value = Emission Level – Limit value
5. " * ": Fundamental frequency.

CHANNEL	TX Channel 9	DETECTOR FUNCTION	Peak (PK)
FREQUENCY RANGE	1GHz ~ 25GHz		Average (AV)

ANTENNA POLARITY & TEST DISTANCE: HORIZONTAL AT 3 M

NO.	FREQ. (MHz)	EMISSION LEVEL (dBuV/m)	LIMIT (dBuV/m)	MARGIN (dB)	ANTENNA HEIGHT (m)	TABLE ANGLE (Degree)	RAW VALUE (dBuV)	CORRECTION FACTOR (dB/m)
1	*2452.00	99.8 PK			1.68 H	333	66.90	32.90
2	*2452.00	90.0 AV			1.68 H	333	57.10	32.90
3	2483.50	59.1 PK	74.0	-14.9	2.06 H	140	26.10	33.00
4	2483.50	48.0 AV	54.0	-6.0	2.06 H	140	15.00	33.00
5	4904.00	48.5 PK	74.0	-25.5	1.34 H	111	42.60	5.90
6	4904.00	35.8 AV	54.0	-18.2	1.34 H	111	29.90	5.90

ANTENNA POLARITY & TEST DISTANCE: VERTICAL AT 3 M

NO.	FREQ. (MHz)	EMISSION LEVEL (dBuV/m)	LIMIT (dBuV/m)	MARGIN (dB)	ANTENNA HEIGHT (m)	TABLE ANGLE (Degree)	RAW VALUE (dBuV)	CORRECTION FACTOR (dB/m)
1	*2452.00	111.4 PK			1.83 V	345	78.40	33.00
2	*2452.00	102.4 AV			1.83 V	345	69.40	33.00
3	2483.50	71.9 PK	74.0	-2.1	2.09 V	162	38.90	33.00
4	2483.50	53.0 AV	54.0	-1.0	2.09 V	162	20.00	33.00
5	4904.00	48.6 PK	74.0	-25.4	1.59 V	111	42.70	5.90
6	4904.00	35.7 AV	54.0	-18.3	1.59 V	111	29.80	5.90

REMARKS:

1. Emission Level(dBuV/m) = Raw Value(dBuV) + Correction Factor(dB/m)
2. Correction Factor(dB/m) = Antenna Factor(dB/m) + Cable Factor(dB)
3. The other emission levels were very low against the limit.
4. Margin value = Emission Level – Limit value
5. " * ": Fundamental frequency.

Below 1GHz Worst-case Data: 802.11n (HT20)

CHANNEL	TX Channel 11	DETECTOR FUNCTION	Quasi-Peak (QP)
FREQUENCY RANGE	30MHz ~ 1GHz		

ANTENNA POLARITY & TEST DISTANCE: HORIZONTAL AT 3 M								
NO.	FREQ. (MHz)	EMISSION LEVEL (dBuV/m)	LIMIT (dBuV/m)	MARGIN (dB)	ANTENNA HEIGHT (m)	TABLE ANGLE (Degree)	RAW VALUE (dBuV)	CORRECTION FACTOR (dB/m)
1	124.98	30.9 QP	43.5	-12.6	1.50 H	13	46.60	-15.70
2	161.85	35.9 QP	43.5	-7.6	1.50 H	198	49.30	-13.40
3	249.17	38.3 QP	46.0	-7.7	1.00 H	16	52.50	-14.20
4	375.29	38.7 QP	46.0	-7.3	1.00 H	16	49.50	-10.80
5	625.60	32.1 QP	46.0	-13.9	1.25 H	15	37.50	-5.40
6	751.73	33.5 QP	46.0	-12.5	1.00 H	356	36.60	-3.10
ANTENNA POLARITY & TEST DISTANCE: VERTICAL AT 3 M								
NO.	FREQ. (MHz)	EMISSION LEVEL (dBuV/m)	LIMIT (dBuV/m)	MARGIN (dB)	ANTENNA HEIGHT (m)	TABLE ANGLE (Degree)	RAW VALUE (dBuV)	CORRECTION FACTOR (dB/m)
1	37.66	37.3 QP	40.0	-2.7	1.00 V	248	52.40	-15.10
2	66.77	33.0 QP	40.0	-7.0	1.00 V	303	48.70	-15.70
3	161.85	30.3 QP	43.5	-13.2	1.50 V	282	43.70	-13.40
4	249.17	31.1 QP	46.0	-14.9	1.00 V	269	45.30	-14.20
5	375.29	34.1 QP	46.0	-11.9	1.24 V	219	44.90	-10.80
6	751.73	31.6 QP	46.0	-14.4	1.24 V	183	34.70	-3.10

Remarks:

1. Emission Level(dBuV/m) = Raw Value(dBuV) + Correction Factor(dB/m)
2. Correction Factor(dB/m) = Antenna Factor(dB/m) + Cable Factor(dB)
3. The other emission levels were very low against the limit.
4. Margin value = Emission Level – Limit value

4.2 Conducted Emission Measurement

4.2.1 Limits of Conducted Emission Measurement

Frequency (MHz)	Conducted Limit (dBuV)	
	Quasi-peak	Average
0.15 - 0.5	66 - 56	56 - 46
0.50 - 5.0	56	46
5.0 - 30.0	60	50

- Note:** 1. The lower limit shall apply at the transition frequencies.
 2. The limit decreases in line with the logarithm of the frequency in the range of 0.15 to 0.50MHz.

4.2.2 Test Instruments

Test Date: Oct. 07, 2013

Description & Manufacturer	Model No.	Serial No.	Date Of Calibration	Due Date Of Calibration
Test Receiver ROHDE & SCHWARZ	ESCS30	100288	Nov. 09, 2012	Nov. 08, 2013
RF signal cable Woken	5D-FB	Cable-HYCO2-01	Dec. 28, 2012	Dec. 27, 2013
LISN ROHDE & SCHWARZ (EUT)	ESH2-Z5	100100	Dec. 21, 2012	Dec. 20, 2013
LISN ROHDE & SCHWARZ (Peripheral)	ESH3-Z5	100311	Jul. 17, 2013	Jul. 16, 2014
Software ADT	BV ADT_Cond_ V7.3.7.3	NA	NA	NA

- NOTE:** 1. The calibration interval of the above test instruments is 12 months and the calibrations are traceable to NML/ROC and NIST/USA.
 2. The test was performed in HwaYa Shielded Room 2.
 3. The VCCI Site Registration No. is C-2047.

4.2.3 Test Procedures

- a. The EUT was placed 0.4 meters from the conducting wall of the shielded room with EUT being connected to the power mains through a line impedance stabilization network (LISN). Other support units were connected to the power mains through another LISN. The two LISNs provide 50 ohm/ 50uH of coupling impedance for the measuring instrument.
- b. Both lines of the power mains connected to the EUT were checked for maximum conducted interference.
- c. The frequency range from 150kHz to 30MHz was searched. Emission levels under (Limit - 20dB) was not recorded.

Note: The resolution bandwidth and video bandwidth of test receiver is 9kHz for quasi-peak detection (QP) and average detection (AV) at frequency 0.15MHz-30MHz.

4.2.4 Deviation from Test Standard

No deviation.

4.2.5 Test Setup

4.2.7 Test Results

Phase	Line (L)	Detector Function	Quasi-Peak (QP) / Average (AV)
-------	----------	-------------------	--------------------------------

No	Freq. [MHz]	Corr. Factor (dB)	Reading Value [dB (uV)]		Emission Level [dB (uV)]		Limit [dB (uV)]		Margin (dB)	
			Q.P.	AV.	Q.P.	AV.	Q.P.	AV.	Q.P.	AV.
			1	0.15781	0.17	42.88	30.05	43.05	30.22	65.58
2	0.16953	0.17	42.35	30.50	42.52	30.67	64.98	54.98	-22.46	-24.31
3	0.21250	0.17	33.31	22.40	33.48	22.57	63.11	53.11	-29.62	-30.53
4	0.44688	0.21	37.43	27.99	37.64	28.20	56.93	46.93	-19.29	-18.73
5	4.42578	0.37	35.98	29.41	36.35	29.78	56.00	46.00	-19.65	-16.22
6	19.70703	0.63	36.35	33.02	36.98	33.65	60.00	50.00	-23.02	-16.35

Remarks:

1. Q.P. and AV. are abbreviations of quasi-peak and average individually.
2. The emission levels of other frequencies were very low against the limit.
3. Margin value = Emission level - Limit value
4. Correction factor = Insertion loss + Cable loss
5. Emission Level = Correction Factor + Reading Value.

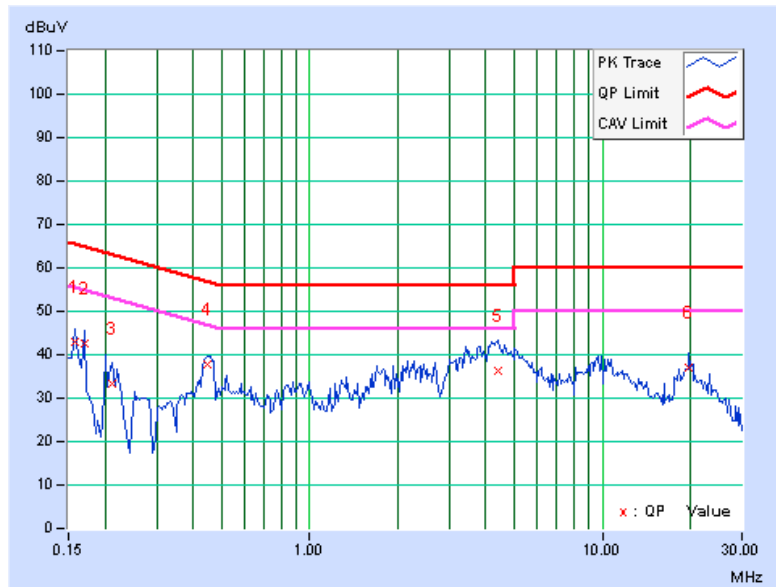

Phase	Neutral (N)	Detector Function	Quasi-Peak (QP) / Average (AV)
-------	-------------	-------------------	--------------------------------

No	Freq. [MHz]	Corr. Factor (dB)	Reading Value [dB (uV)]		Emission Level [dB (uV)]		Limit [dB (uV)]		Margin (dB)	
			Q.P.	AV.	Q.P.	AV.	Q.P.	AV.	Q.P.	AV.
			1	0.16953	0.18	40.54	30.30	40.72	30.48	64.98
2	0.21641	0.19	34.70	23.94	34.89	24.13	62.96	52.96	-28.07	-28.83
3	0.49375	0.25	39.38	25.74	39.63	25.99	56.10	46.10	-16.48	-20.12
4	0.98984	0.23	36.45	26.13	36.68	26.36	56.00	46.00	-19.32	-19.64
5	4.23047	0.39	35.75	30.43	36.14	30.82	56.00	46.00	-19.86	-15.18
6	19.70703	0.72	36.02	33.17	36.74	33.89	60.00	50.00	-23.26	-16.11

Remarks:

1. Q.P. and AV. are abbreviations of quasi-peak and average individually.
2. The emission levels of other frequencies were very low against the limit.
3. Margin value = Emission level - Limit value
4. Correction factor = Insertion loss + Cable loss
5. Emission Level = Correction Factor + Reading Value.

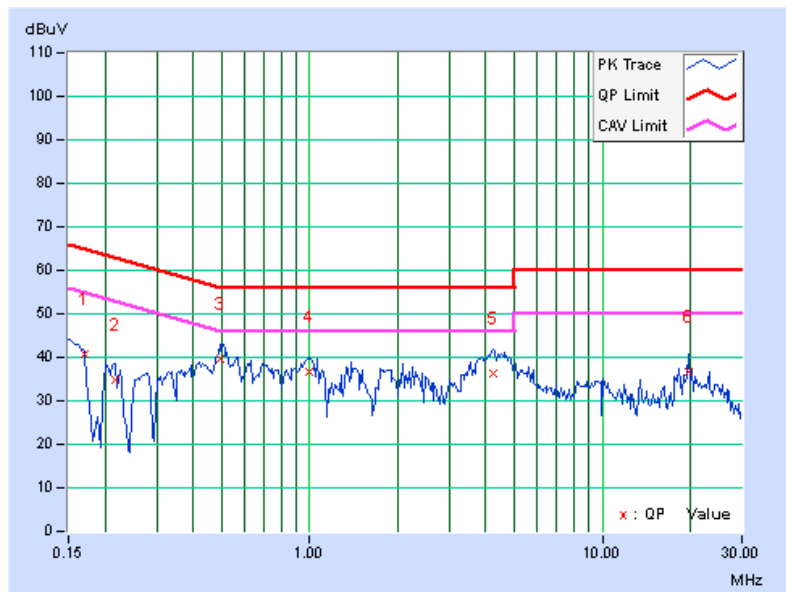

4.3 6dB Bandwidth Measurement

4.3.1 Limits of 6dB Bandwidth Measurement

The minimum of 6dB Bandwidth Measurement is 0.5 MHz.

4.3.2 Test Setup

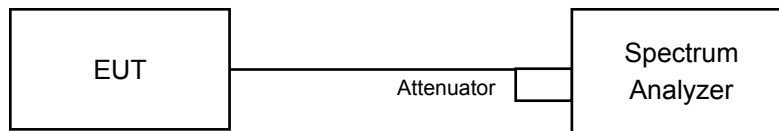

4.3.3 Test Instruments

Refer to section 4.1.2 to get information of above instrument.

4.3.4 Test Procedure

- Set resolution bandwidth (RBW) = 100kHz
- Set the video bandwidth (VBW) $\geq 3 \times$ RBW, Detector = Peak.
- Trace mode = max hold.
- Sweep = auto couple.
- Measure the maximum width of the emission that is constrained by the frequencies associated with the two amplitude points (upper and lower) that are attenuated by 6 dB relative to the maximum level measured in the fundamental emission

4.3.5 Deviation from Test Standard

No deviation.

4.3.6 EUT Operating Conditions

The software provided by client to enable the EUT under transmission condition continuously at lowest, middle and highest channel frequencies individually.

4.3.7 Test Result

802.11b

Channel	Frequency (MHz)	6dB Bandwidth (MHz)			Minimum Limit (MHz)	Pass / Fail
		CHAIN 0	CHAIN 1	CHAIN 2		
1	2412	6.06	6.12	6.09	0.5	Pass
6	2437	6.09	6.10	6.55	0.5	Pass
11	2462	6.08	6.09	6.08	0.5	Pass

802.11g

Channel	Frequency (MHz)	6dB Bandwidth (MHz)			Minimum Limit (MHz)	Pass / Fail
		CHAIN 0	CHAIN 1	CHAIN 2		
1	2412	16.42	16.42	16.41	0.5	Pass
6	2437	16.38	16.38	16.37	0.5	Pass
11	2462	16.39	16.39	16.40	0.5	Pass

802.11n (HT20)

Channel	Frequency (MHz)	6dB Bandwidth (MHz)			Minimum Limit (MHz)	Pass / Fail
		CHAIN 0	CHAIN 1	CHAIN 2		
1	2412	17.62	17.63	17.63	0.5	Pass
6	2437	17.61	17.61	17.62	0.5	Pass
11	2462	17.62	17.61	17.61	0.5	Pass

802.11n (HT40)

Channel	Frequency (MHz)	6dB Bandwidth (MHz)			Minimum Limit (MHz)	Pass / Fail
		CHAIN 0	CHAIN 1	CHAIN 2		
3	2422	36.42	36.44	36.11	0.5	Pass
6	2437	36.36	36.37	36.37	0.5	Pass
9	2452	36.38	36.40	36.17	0.5	Pass

Spectrum Plot of Worst Value

802.11b

802.11g

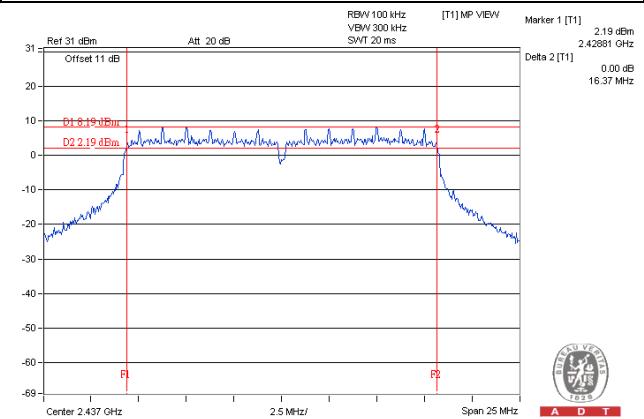
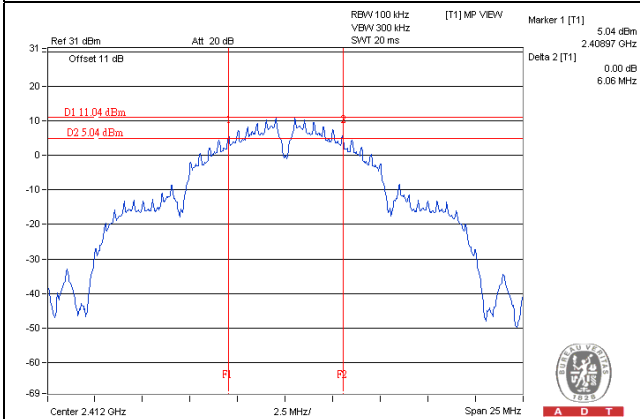

802.11n (HT20)

802.11n (HT40)

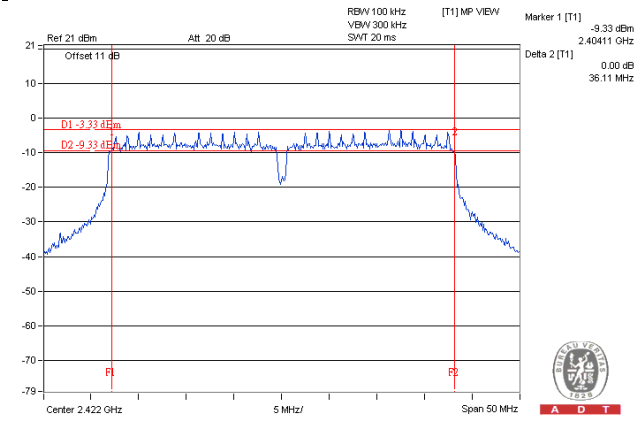
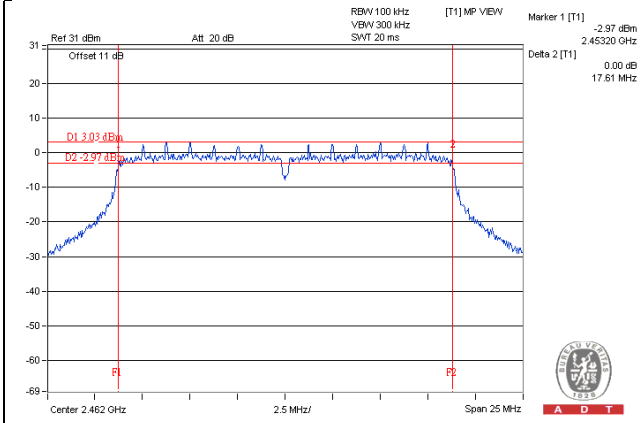

4.4 Conducted Output Power Measurement

4.4.1 Limits of Conducted Output Power Measurement

For systems using digital modulation in the 2400–2483.5 MHz bands: 1 Watt (30dBm)

Per KDB 662911 D01 Multiple Transmitter Output Method of conducted output power measurement on IEEE 802.11 devices,

Array Gain = 0 dB (i.e., no array gain) for $NANT \leq 4$;

Array Gain = 0 dB (i.e., no array gain) for channel widths ≥ 40 MHz for any NANT;

Array Gain = $5 \log(NANT/NSS)$ dB or 3 dB, whichever is less for 20-MHz channel widths with $NANT \geq 5$.

For power measurements on all other devices: Array Gain = $10 \log(NANT/NSS)$ dB.

4.4.2 Test Setup

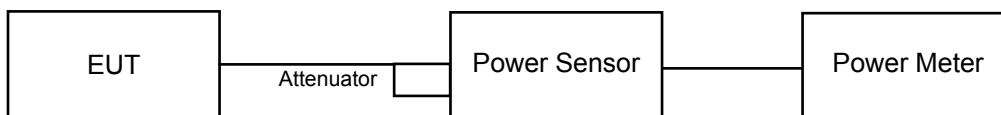

4.4.3 Test Instruments

Refer to section 4.1.2 to get information of above instrument.

4.4.4 Test Procedures

An average power sensor was used on the output port of the EUT. A power meter was used to read the response of the average power sensor. Record the power level.

4.4.5 Deviation from Test Standard

No deviation.

4.4.6 EUT Operating Conditions

Same as Item 4.3.6.

4.4.7 Test Results

802.11b

Channel	Frequency (MHz)	Average Power (dBm)			Total Power (mW)	Total Power (dBm)	Limit (dBm)	Pass/Fail
		Chain 0	Chain 1	Chain 2				
1	2412	18.32	18.79	18.48	214.072	23.31	30	Pass
6	2437	22.52	21.89	22.25	501.054	27.00	30	Pass
11	2462	17.52	17.04	17.86	168.170	22.26	30	Pass

802.11g

Channel	Frequency (MHz)	Average Power (dBm)			Total Power (mW)	Total Power (dBm)	Limit (dBm)	Pass/Fail
		Chain 0	Chain 1	Chain 2				
1	2412	15.33	15.24	15.32	101.58	20.07	30	Pass
6	2437	20.06	19.76	19.79	291.295	24.64	30	Pass
11	2462	16.45	16.02	15.32	118.192	20.73	30	Pass

802.11n (HT20)

Channel	Frequency (MHz)	Average Power (dBm)			Total Power (mW)	Total Power (dBm)	Limit (dBm)	Pass/Fail
		Chain 0	Chain 1	Chain 2				
1	2412	13.55	13.25	13.47	66.014	18.20	30	Pass
6	2437	19.82	19.22	19.01	259.116	24.13	30	Pass
11	2462	15.02	14.49	14.09	85.533	19.32	30	Pass

802.11n (HT40)

Channel	Frequency (MHz)	Average Power (dBm)			Total Power (mW)	Total Power (dBm)	Limit (dBm)	Pass/Fail
		Chain 0	Chain 1	Chain 2				
3	2422	11.72	11.48	11.10	41.801	16.21	30	Pass
6	2437	15.43	15.17	15.58	103.94	20.17	30	Pass
9	2452	12.12	11.61	11.88	46.198	16.65	30	Pass

4.5 Power Spectral Density Measurement

4.5.1 Limits of Power Spectral Density Measurement

The Maximum of Power Spectral Density Measurement is 8dBm.

4.5.2 Test Setup

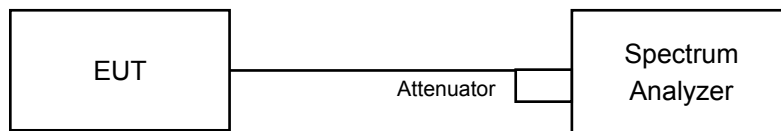

4.5.3 Test Instruments

Refer to section 4.1.2 to get information of above instrument.

4.5.4 Test Procedure

For duty cycle $\geq 98\%$

- a. Set instrument center frequency to DTS channel center frequency.
- b. Set span to at least 1.5 times the OBW.
- c. Set RBW to: $3 \text{ kHz} \leq \text{RBW} \leq 100 \text{ kHz}$.
- d. Set VBW $\geq 3 \times \text{RBW}$.
- e. Detector = power averaging (RMS) or sample detector (when RMS not available).
- f. Ensure that the number of measurement points in the sweep $\geq 2 \times \text{span}/\text{RBW}$.
- g. Sweep time = auto couple.
- h. Employ trace averaging (RMS) mode over a minimum of 100 traces.
- i. Use the peak marker function to determine the maximum amplitude level.

For duty cycle $< 98\%$

- a. Measure the duty cycle (x).
- b. Set instrument center frequency to DTS channel center frequency.
- c. Set span to at least 1.5 times the OBW.
- d. Set RBW to: $3 \text{ kHz} \leq \text{RBW} \leq 100 \text{ kHz}$.
- e. Set VBW $\geq 3 \times \text{RBW}$.
- f. Detector = power averaging (RMS) or sample detector (when RMS not available).
- g. Ensure that the number of measurement points in the sweep $\geq 2 \times \text{span}/\text{RBW}$.
- h. Sweep time = auto couple.
- i. Do not use sweep triggering. Allow sweep to "free run".
- j. Employ trace averaging (RMS) mode over a minimum of 100 traces.
- k. Use the peak marker function to determine the maximum amplitude level.
- l. Add $10 \log (1/x)$, where x is the duty cycle measured in step (a), to the measured PSD to compute the average PSD during the actual transmission time.

4.5.5 Deviation from Test Standard

No deviation.

4.5.6 EUT Operating Condition

Same as Item 4.3.6

4.5.7 Test Results

802.11b

TX chain	Chan.	Freq. (MHz)	PSD (dBm)	10 log (N=3) dB	Total PSD (dBm)	Limit (dBm)	Pass /Fail
0	1	2412	-8.56	4.77	-3.79	4.23	Pass
	6	2437	-5.62	4.77	-0.85	4.23	Pass
	11	2462	-9.86	4.77	-5.09	4.23	Pass
1	1	2412	-8.84	4.77	-4.07	4.23	Pass
	6	2437	-5.53	4.77	-0.76	4.23	Pass
	11	2462	-9.61	4.77	-4.84	4.23	Pass
2	1	2412	-7.09	4.77	-2.32	4.23	Pass
	6	2437	-4.99	4.77	-0.22	4.23	Pass
	11	2462	-7.64	4.77	-2.87	4.23	Pass

NOTE:

- Method 1 of power density measurement of KDB 662911 is using for calculating total power density. Total power density is summing entire spectra across corresponding frequency bins on the various outputs by computer.
- Directional gain = 5dBi + 10log(3) = 9.77dBi > 6dBi , so the power density limit shall be reduced to 8-(9.77-6) = 4.23dBm.

802.11g

TX chain	Chan.	Freq. (MHz)	PSD (dBm)	10 log (N=3) dB	Total PSD w/o Duty Factor (dBm)	Duty Factor	Total PSD with Duty Factor (dBm)	Limit (dBm)	Pass /Fail
0	1	2412	-15.48	4.77	-10.71	0.12	-10.59	4.23	Pass
	6	2437	-11.50	4.77	-6.73	0.12	-6.61	4.23	Pass
	11	2462	-14.82	4.77	-10.05	0.12	-9.93	4.23	Pass
1	1	2412	-13.75	4.77	-8.98	0.12	-8.86	4.23	Pass
	6	2437	-11.64	4.77	-6.87	0.12	-6.75	4.23	Pass
	11	2462	-15.19	4.77	-10.42	0.12	-10.30	4.23	Pass
2	1	2412	-14.66	4.77	-9.89	0.12	-9.77	4.23	Pass
	6	2437	-10.96	4.77	-6.19	0.12	-6.07	4.23	Pass
	11	2462	-14.51	4.77	-9.74	0.12	-9.62	4.23	Pass

NOTE:

- Method 1 of power density measurement of KDB 662911 is using for calculating total power density. Total power density is summing entire spectra across corresponding frequency bins on the various outputs by computer.
- Directional gain = 5dBi + 10log(3) = 9.77dBi > 6dBi , so the power density limit shall be reduced to 8-(9.77-6) = 4.23dBm.
- Refer to section 3.3 for duty cycle spectrum plot.

802.11n (HT20)

TX chain	Chan.	Freq. (MHz)	PSD (dBm)	10 log (N=3) dB	Total PSD w/o Duty Factor (dBm)	Duty Factor	Total PSD with Duty Factor (dBm)	Limit (dBm)	Pass /Fail
0	1	2412	-18.45	4.77	-13.68	0.12	-13.56	4.23	Pass
	6	2437	-11.96	4.77	-7.19	0.12	-7.07	4.23	Pass
	11	2462	-16.97	4.77	-12.20	0.12	-12.08	4.23	Pass
1	1	2412	-12.49	4.77	-7.72	0.12	-7.60	4.23	Pass
	6	2437	-8.23	4.77	-3.46	0.12	-3.34	4.23	Pass
	11	2462	-10.02	4.77	-5.25	0.12	-5.13	4.23	Pass
2	1	2412	-16.22	4.77	-11.45	0.12	-11.33	4.23	Pass
	6	2437	-11.57	4.77	-6.80	0.12	-6.68	4.23	Pass
	11	2462	-14.79	4.77	-10.02	0.12	-9.90	4.23	Pass

NOTE:

- Method 1 of power density measurement of KDB 662911 is using for calculating total power density. Total power density is summing entire spectra across corresponding frequency bins on the various outputs by computer.
- Directional gain = 5dBi + 10log(3) = 9.77dBi > 6dBi , so the power density limit shall be reduced to 8-(9.77-6) = 4.23dBm.
- Refer to section 3.3 for duty cycle spectrum plot.

802.11n (HT40)

TX chain	Chan.	Freq. (MHz)	PSD (dBm)	10 log (N=3) dB	Total PSD w/o Duty Factor (dBm)	Duty Factor	Total PSD with Duty Factor (dBm)	Limit (dBm)	Pass /Fail
0	3	2422	-22.33	4.77	-17.56	0.20	-17.36	4.23	Pass
	6	2437	-12.14	4.77	-7.37	0.20	-7.17	4.23	Pass
	9	2452	-22.33	4.77	-17.56	0.20	-17.36	4.23	Pass
1	3	2422	-22.56	4.77	-17.79	0.20	-17.59	4.23	Pass
	6	2437	-14.69	4.77	-9.92	0.20	-9.72	4.23	Pass
	9	2452	-22.51	4.77	-17.74	0.20	-17.54	4.23	Pass
2	3	2422	-21.91	4.77	-17.14	0.20	-16.94	4.23	Pass
	6	2437	-12.91	4.77	-8.14	0.20	-7.94	4.23	Pass
	9	2452	-21.33	4.77	-16.56	0.20	-16.36	4.23	Pass

NOTE:

- Method 1 of power density measurement of KDB 662911 is using for calculating total power density. Total power density is summing entire spectra across corresponding frequency bins on the various outputs by computer.
- Directional gain = 5dBi + 10log(3) = 9.77dBi > 6dBi , so the power density limit shall be reduced to 8-(9.77-6) = 4.23dBm.
- Refer to section 3.3 for duty cycle spectrum plot.

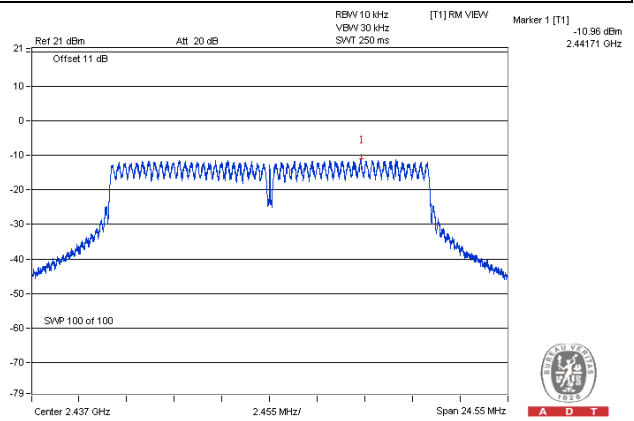
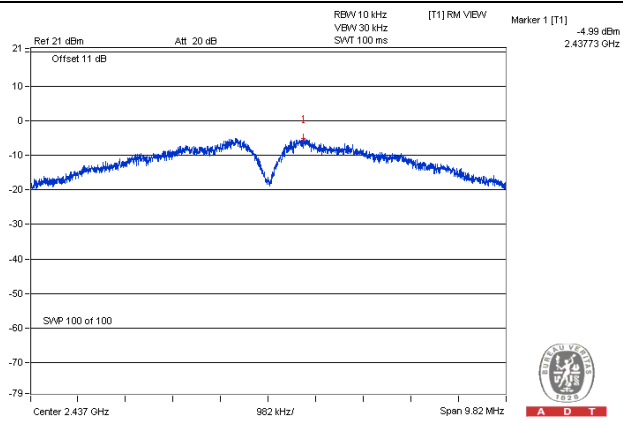
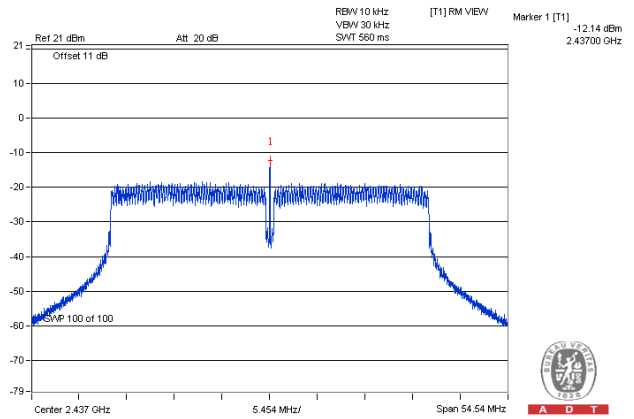
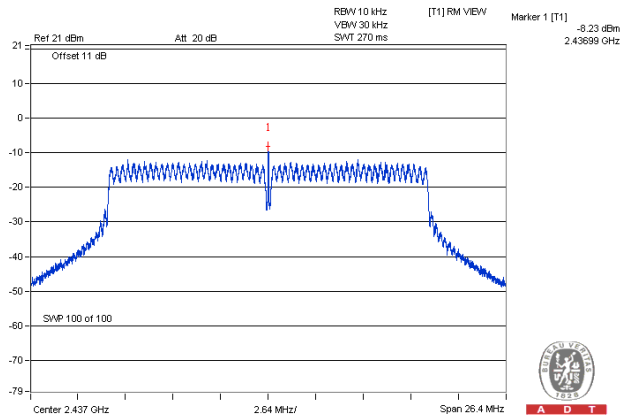
Spectrum Plot of Worst Value**802.11b****802.11g****802.11n (HT20)****802.11n (HT40)**

4.6 Conducted Out of Band Emission Measurement

4.6.1 Limits of Conducted Out of Band Emission Measurement

Below 30dB of the highest emission level of operating band (in 100kHz Resolution Bandwidth).

4.6.2 Test Setup

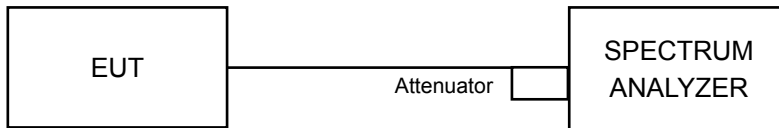

4.6.3 Test Instruments

Refer to section 4.1.2 to get information of above instrument.

4.6.4 Test Procedure

MEASUREMENT PROCEDURE REF

- Set the RBW = 100 kHz.
- Set the VBW \geq 300 kHz.
- Detector = average.
- Sweep time = auto couple.
- Trace mode = max hold.
- Allow trace to fully stabilize.
- Use the peak marker function to determine the maximum power level in any 100 kHz band segment within the fundamental EBW.

MEASUREMENT PROCEDURE OOB

- Set RBW = 100 kHz.
- Set VBW \geq 300 kHz.
- Ensure that the number of measurement points \geq span/RBW
- According to measurement points to set differ measurement span.
- Detector = peak.
- Trace Mode = max hold.
- Sweep = auto couple.

4.6.5 Deviation from Test Standard

No deviation.

4.6.6 EUT Operating Condition

Same as Item 4.3.6

4.6.7 Test Results

The spectrum plots are attached on the following pages. D1 line indicates the highest level, and D2 line indicates the 30dB offset below D1. It shows compliance with the requirement.

802.11b_Chain 0

CH 1

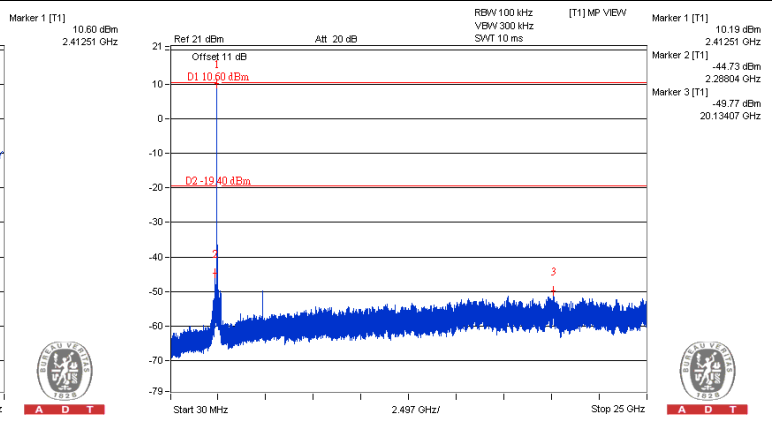
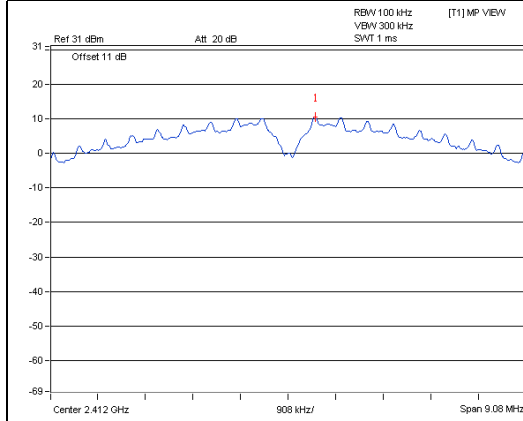

CH 6

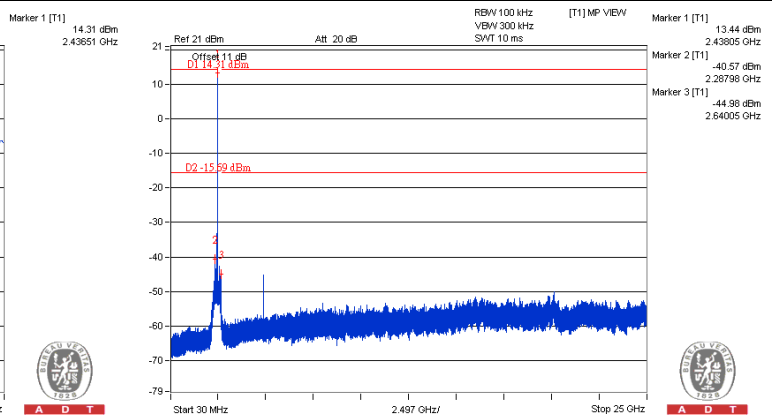
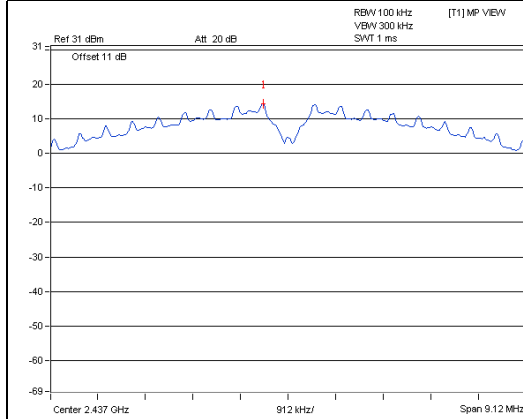

CH 11

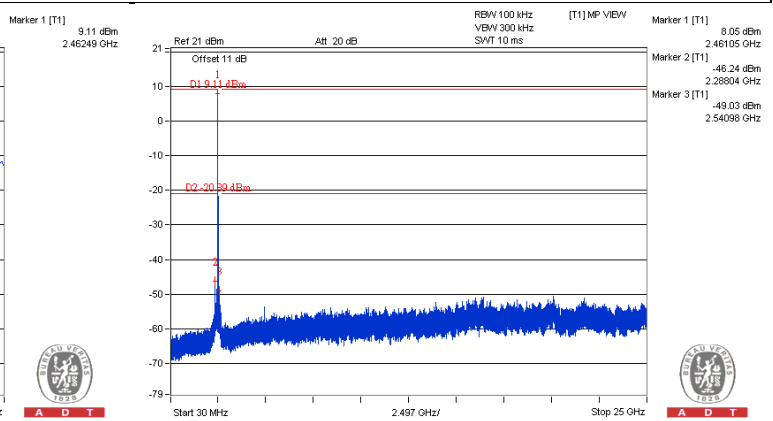
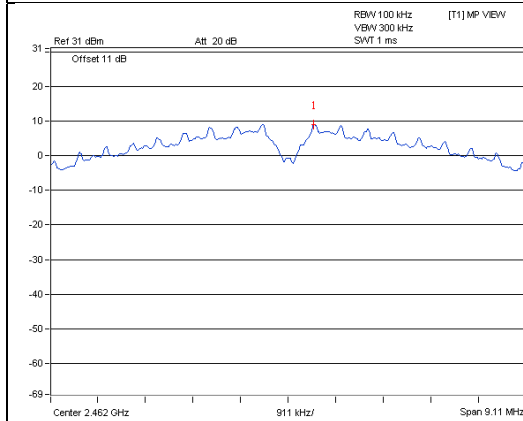

CH 1 Band edge

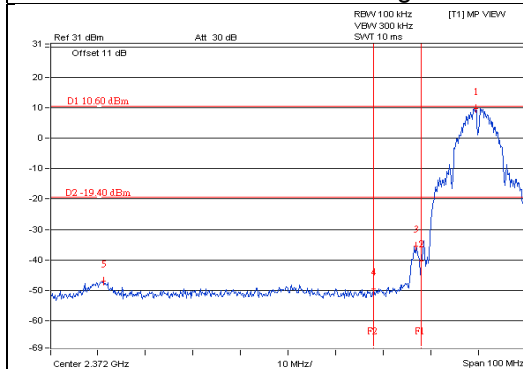

CH 11 Band edge

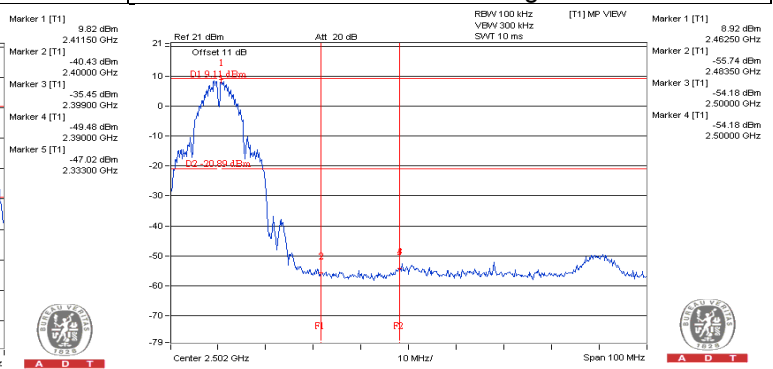

802.11b_Chain 1

CH 1

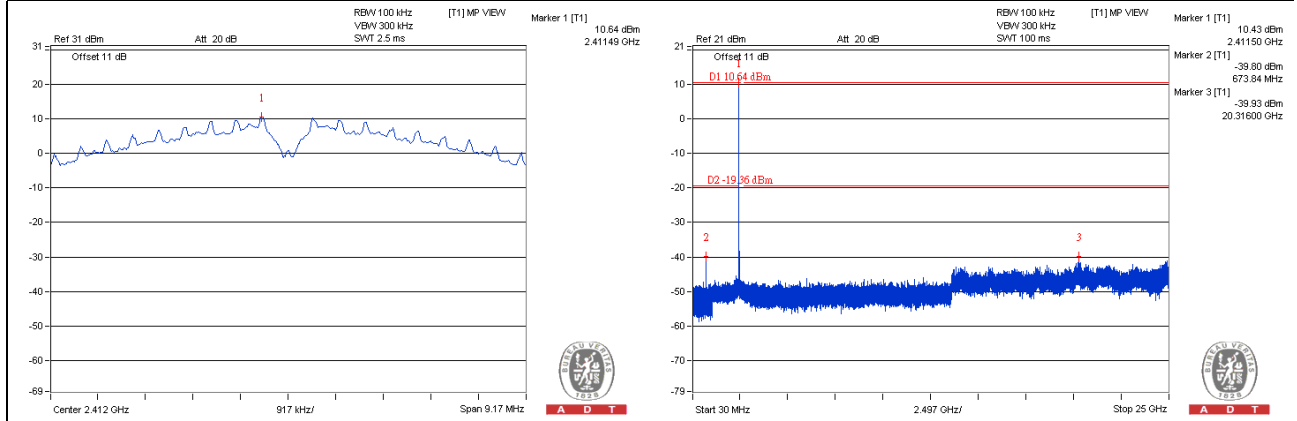

CH 6

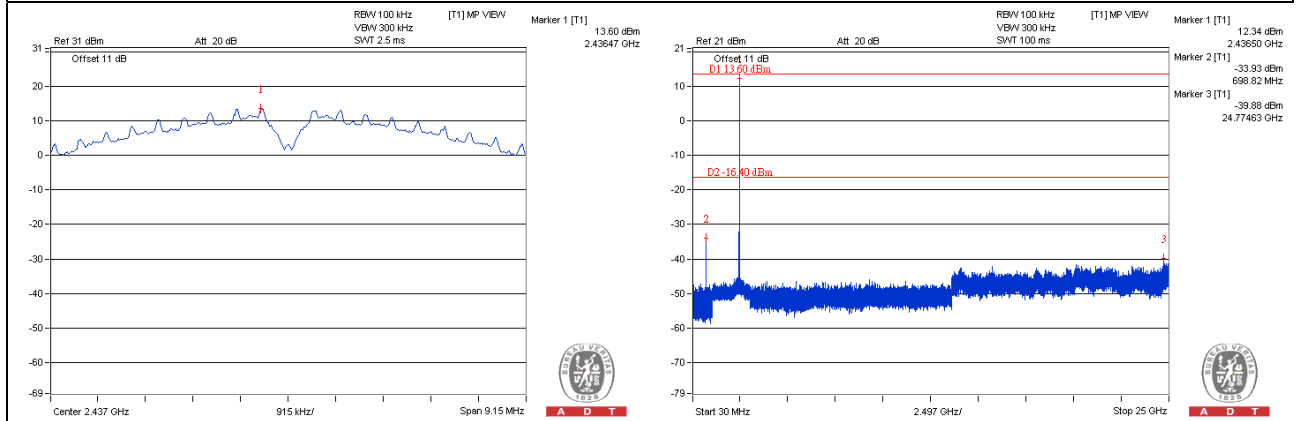

CH 11

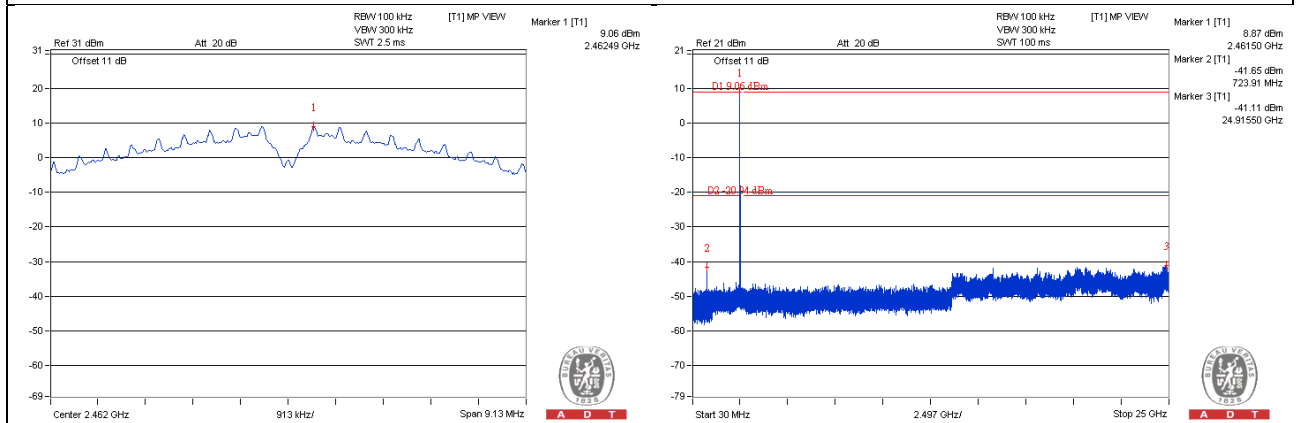

CH 1 Band edge

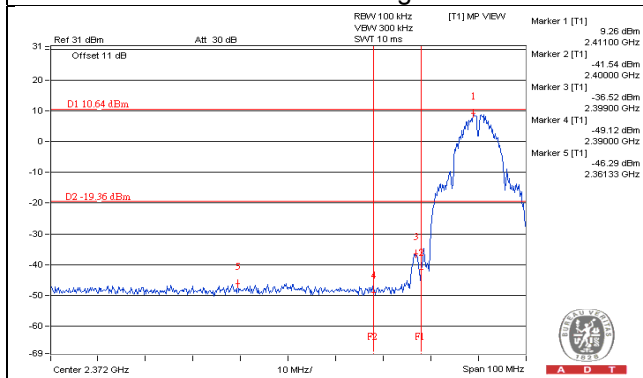

CH 11 Band edge

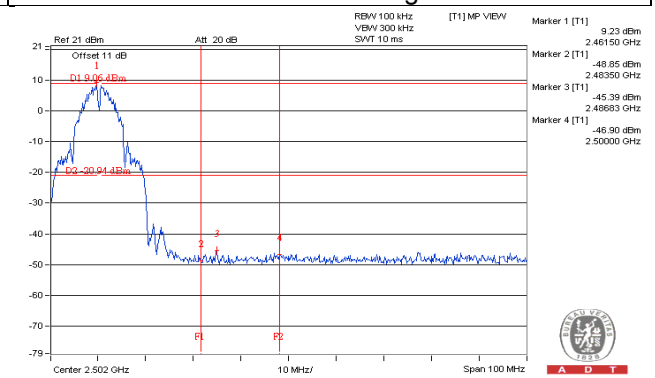

802.11b_Chain 2

CH 1

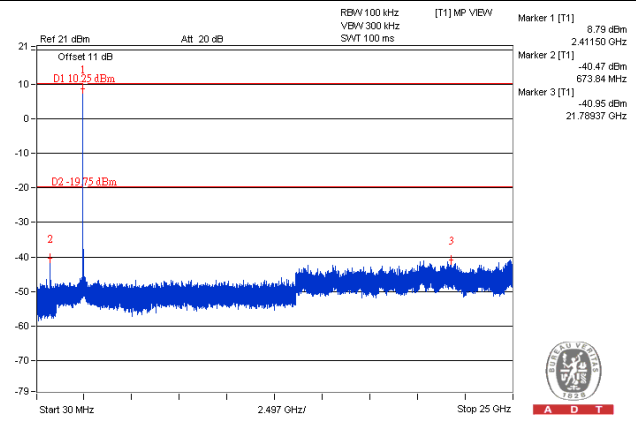
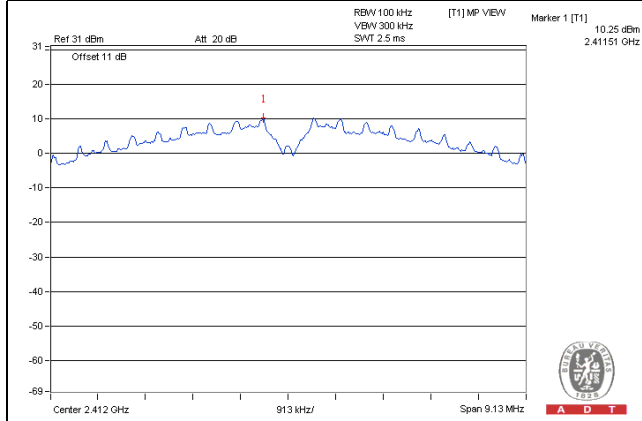

CH 6

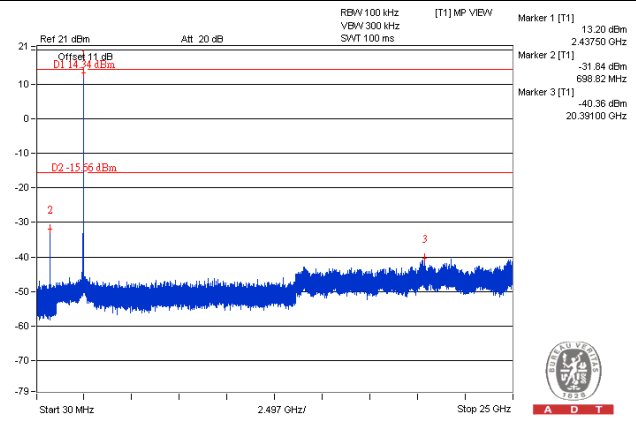
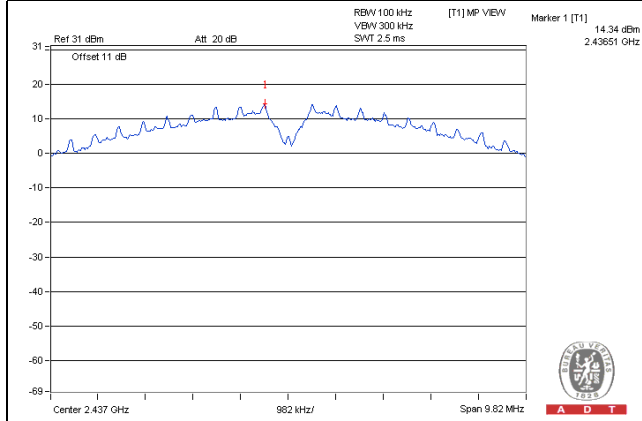

CH 11

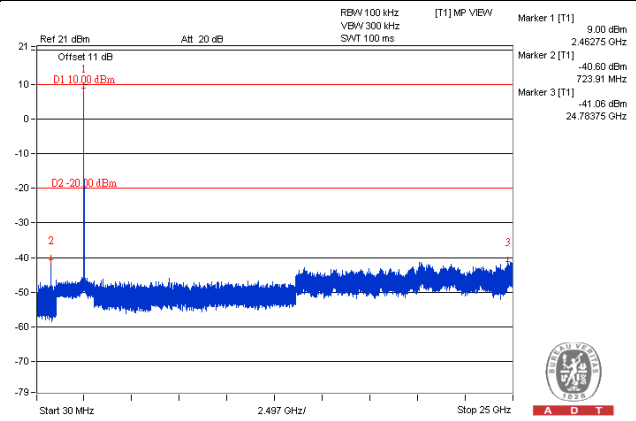
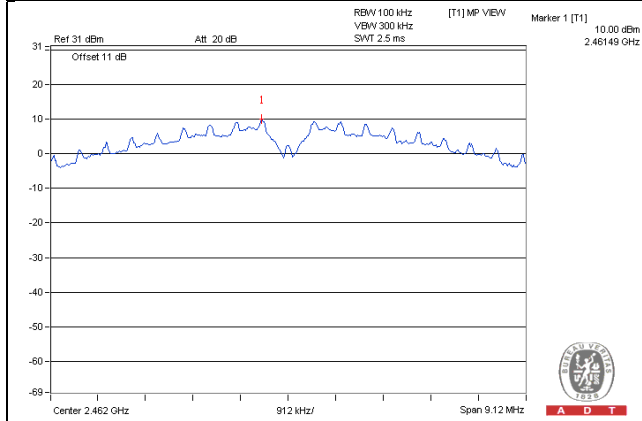

CH 1 Band edge

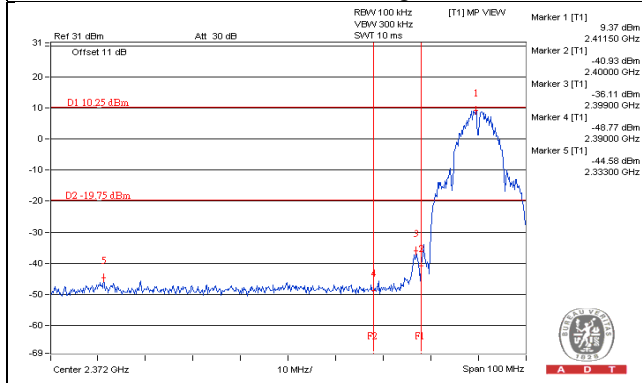

CH 11 Band edge

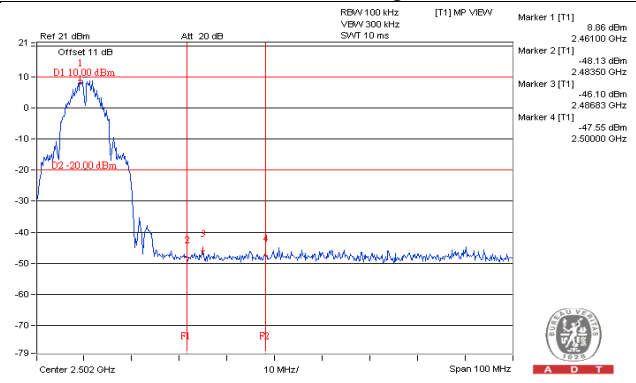

802.11g_Chain 0

CH 1

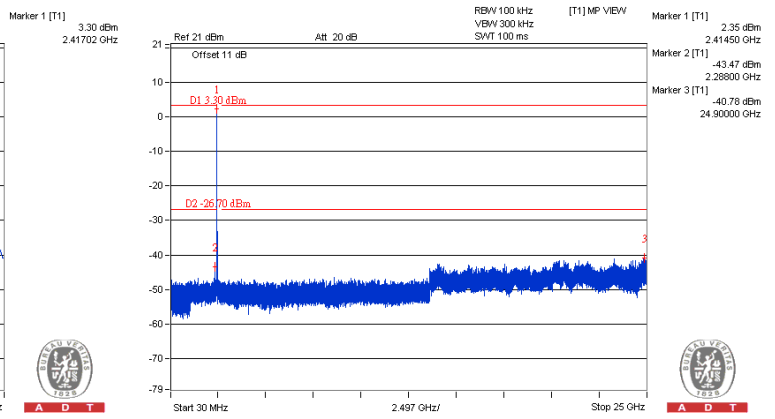
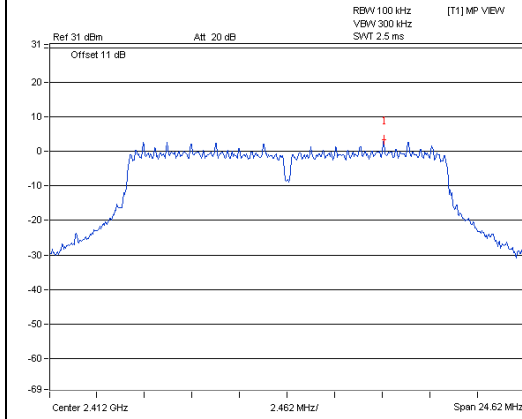

CH 6

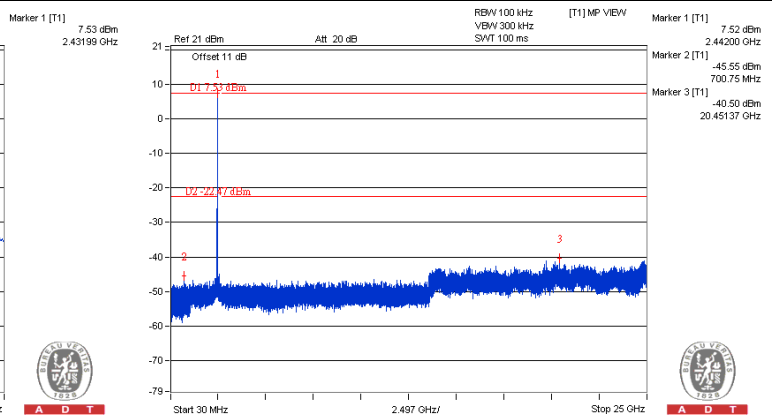
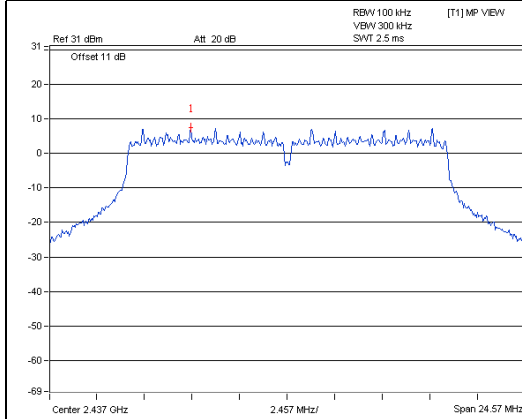

CH 11

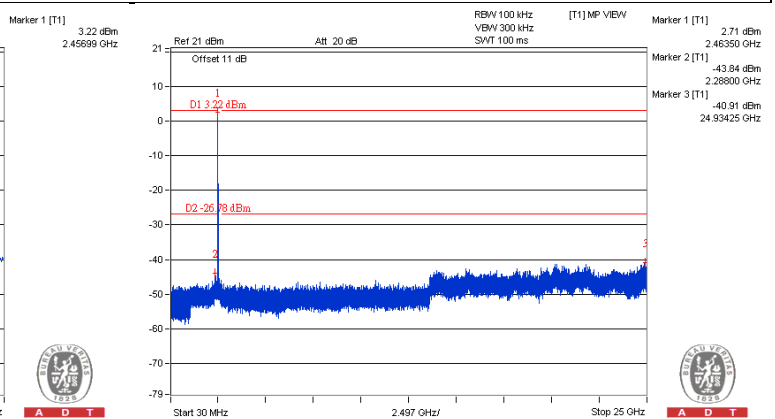
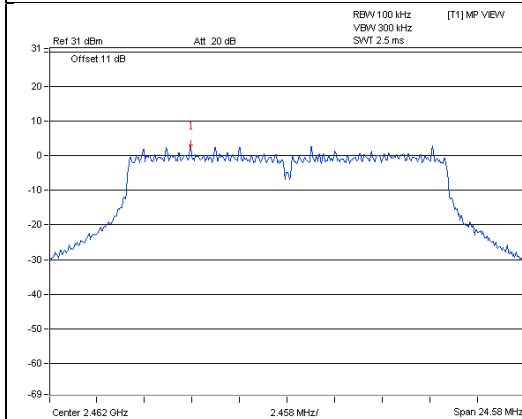

CH 1 Band edge

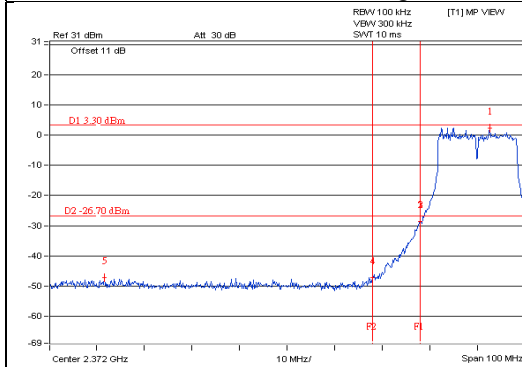

CH 11 Band edge

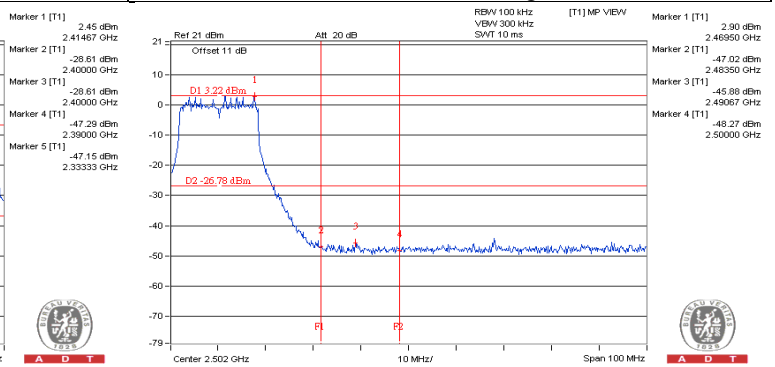

802.11g_Chain 1

CH 1

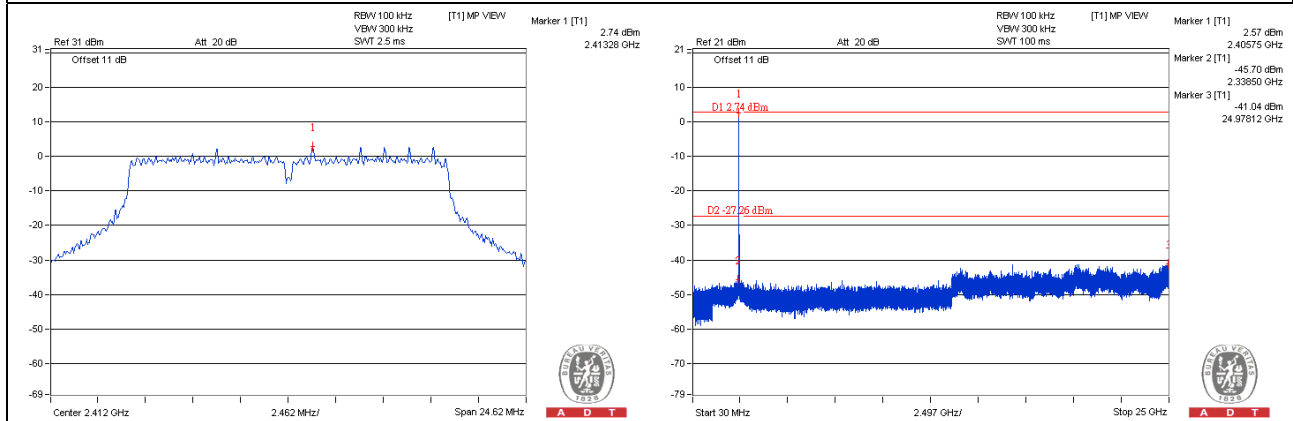

CH 6

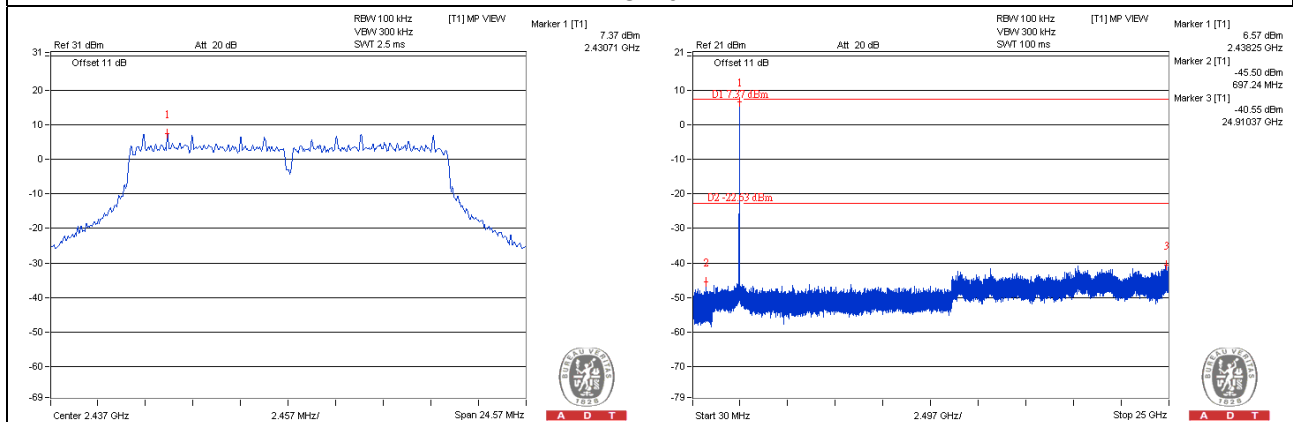

CH 11

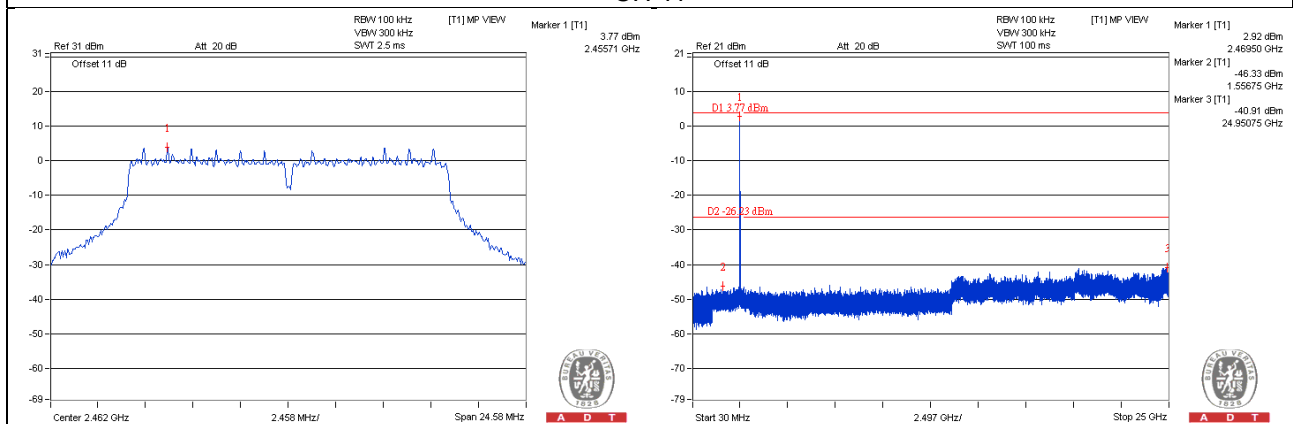

CH 1 Band edge

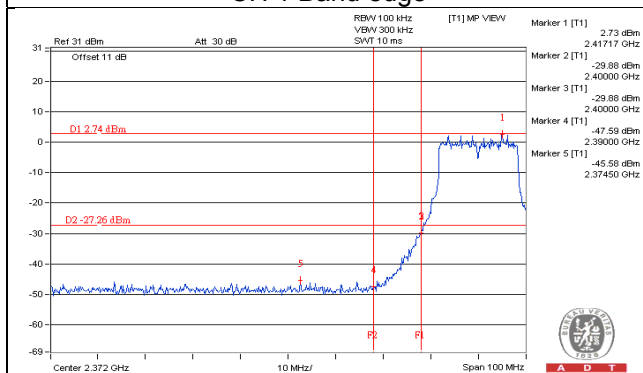

CH 11 Band edge

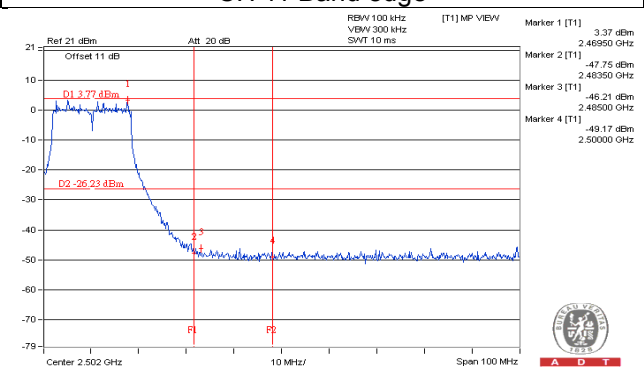

802.11g_Chain 2

CH 1

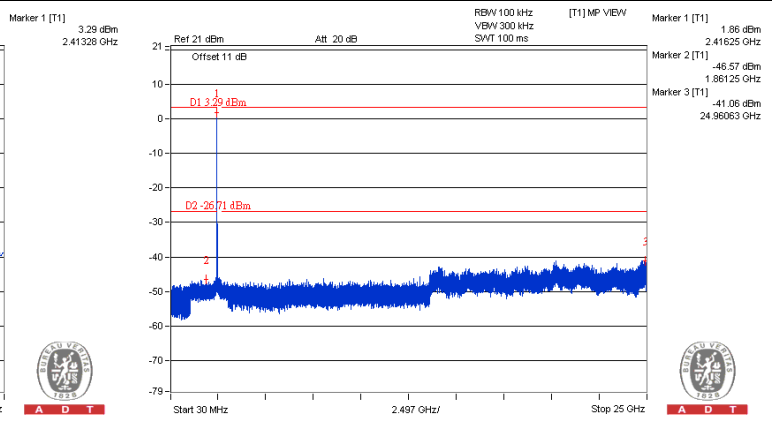
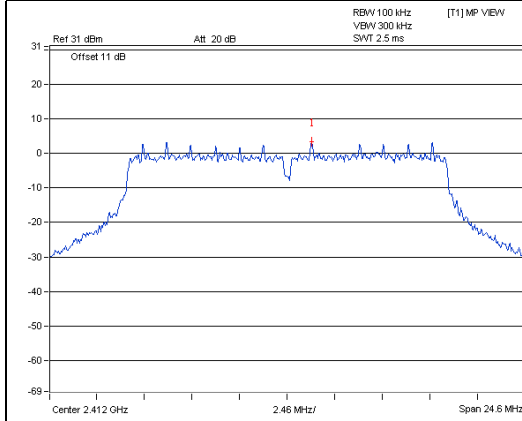

CH 6

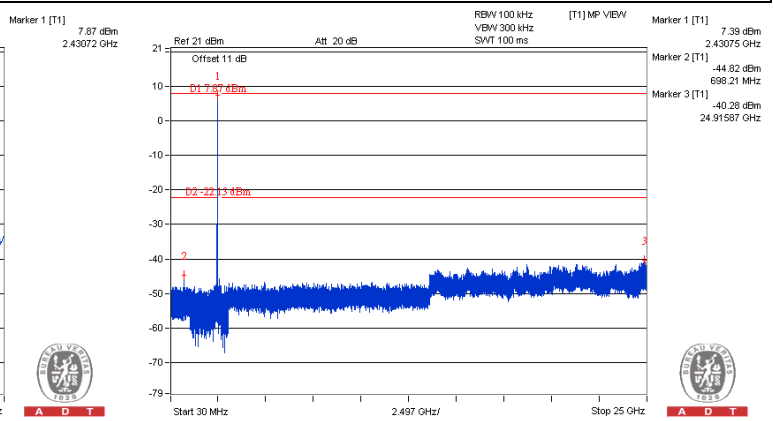
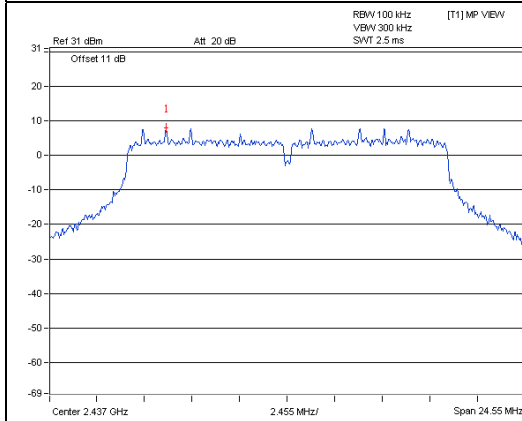

CH 11

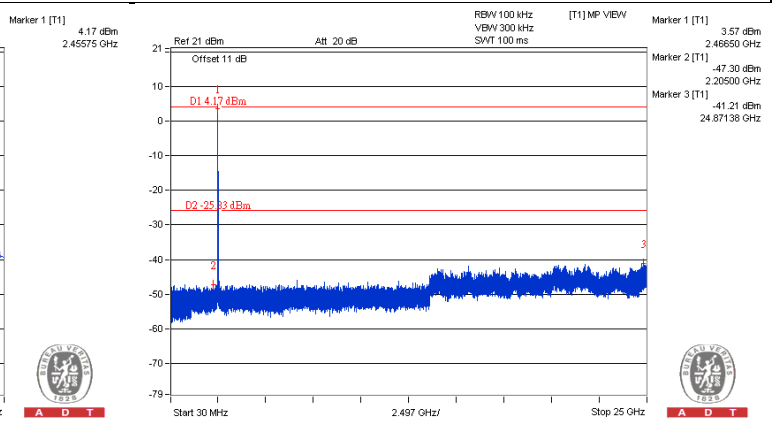
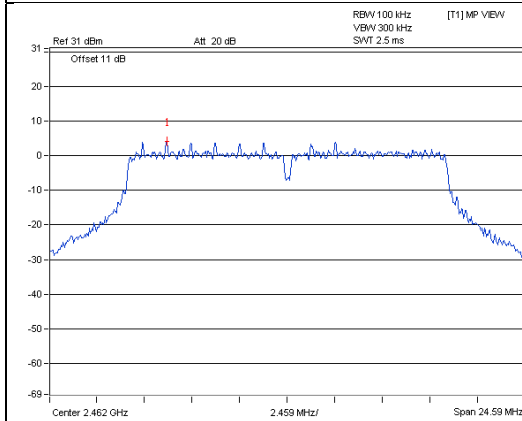

CH 1 Band edge

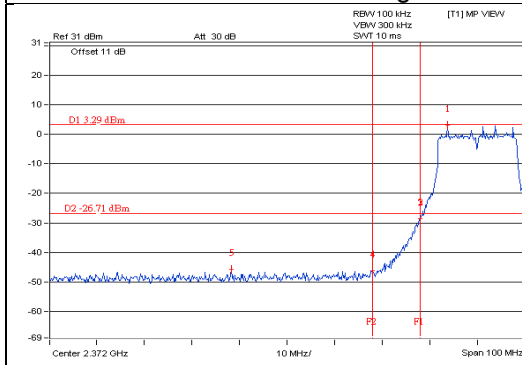

CH 11 Band edge

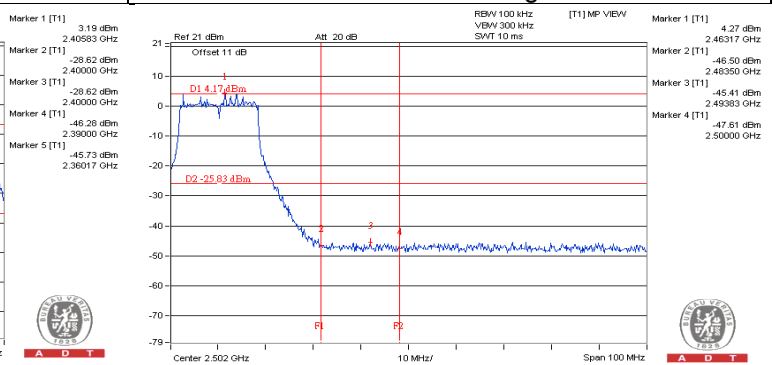

802.11n (HT20)_Chain 0

CH 1

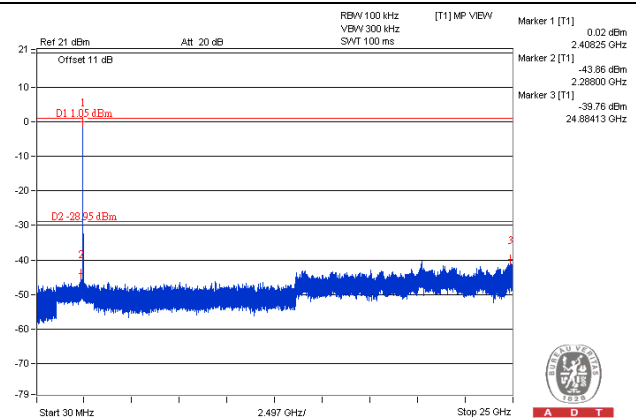
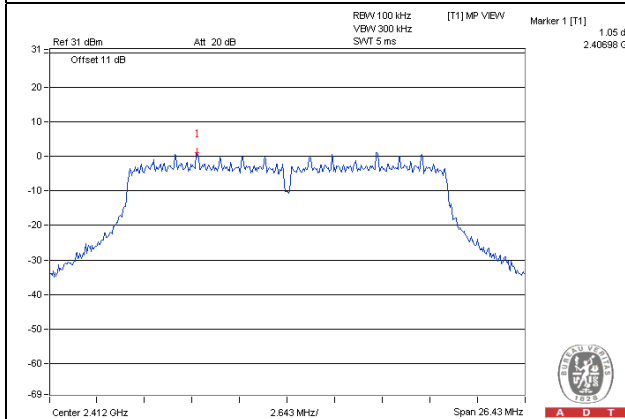

CH 6

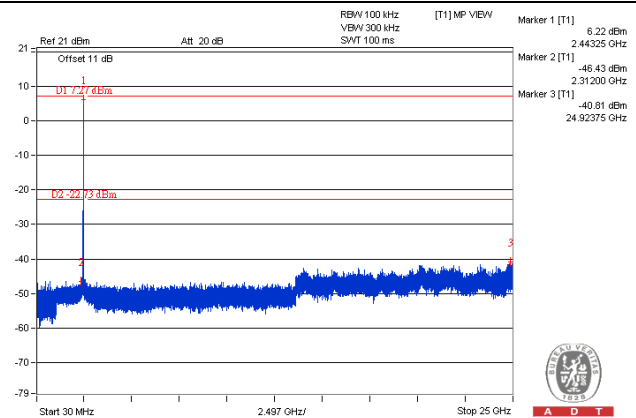
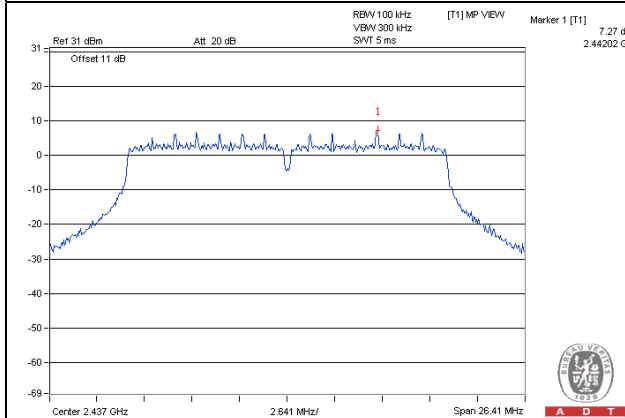

CH 11

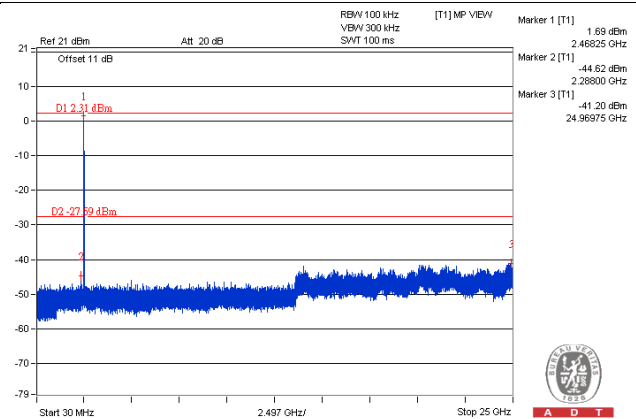
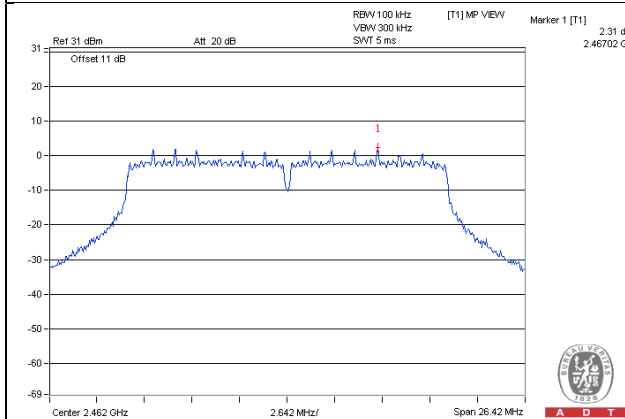

CH 1 Band edge

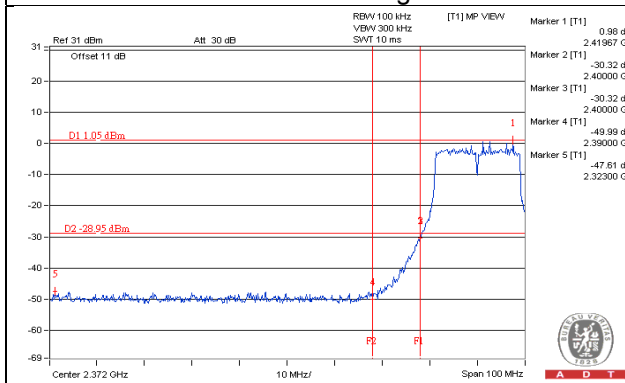

CH 11 Band edge

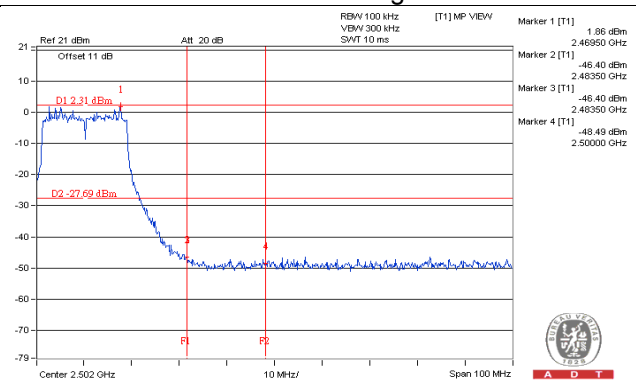

802.11n (HT20)_Chain 1

CH 1

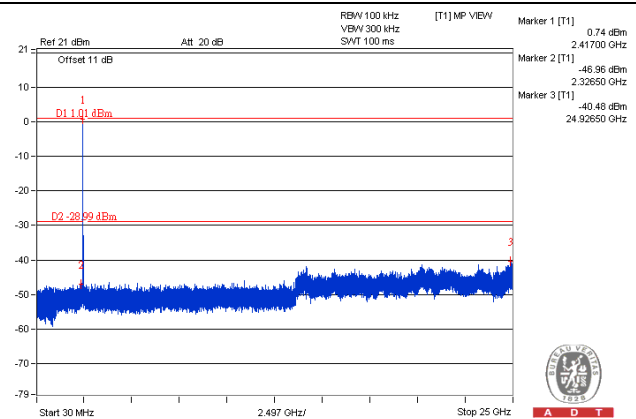
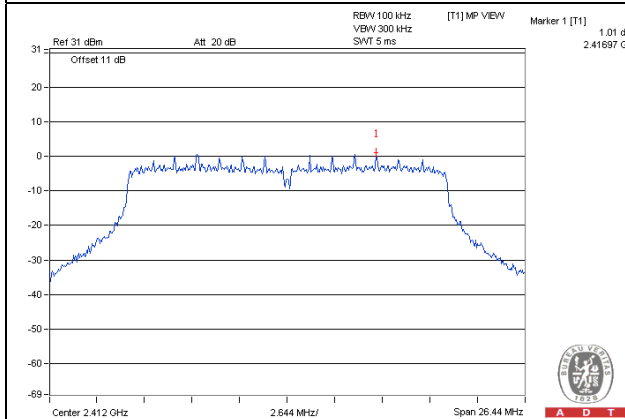

CH 6

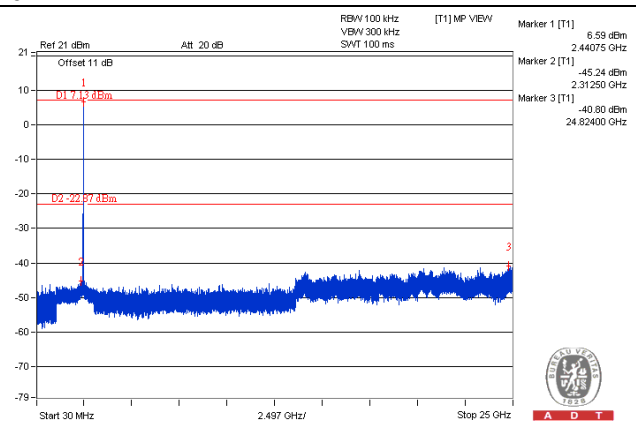
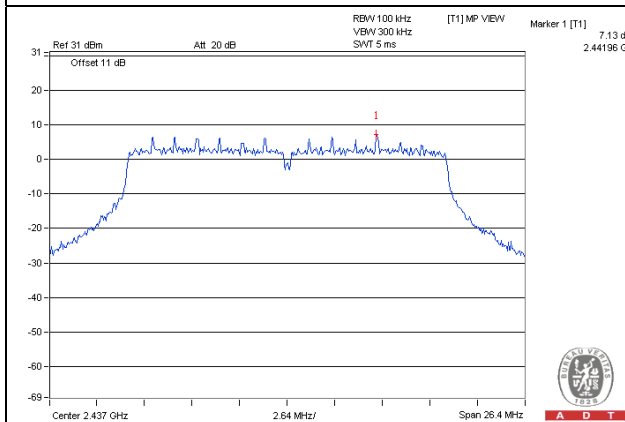

CH 11

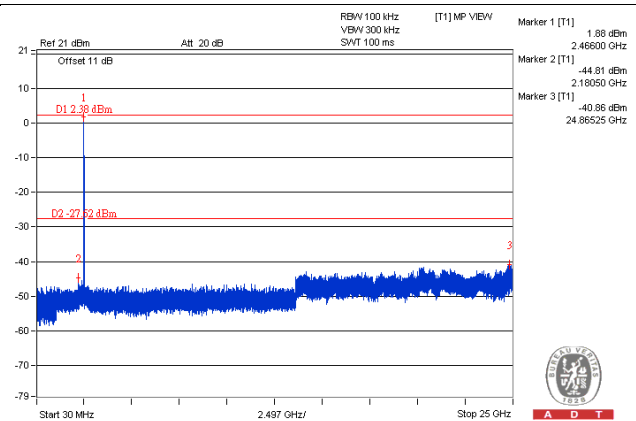
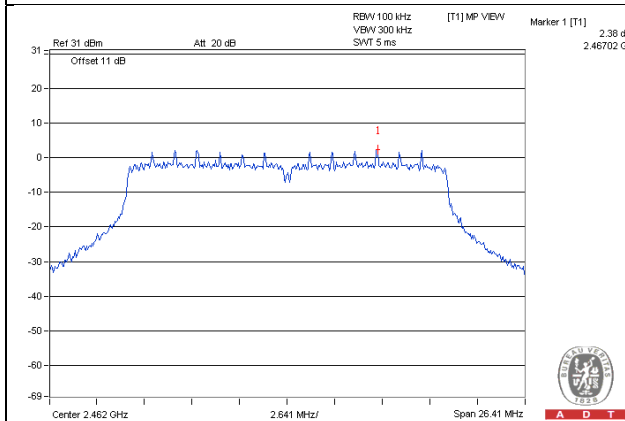

CH 1 Band edge

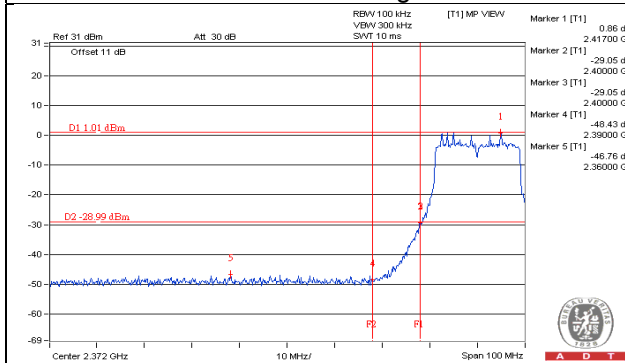

CH 11 Band edge

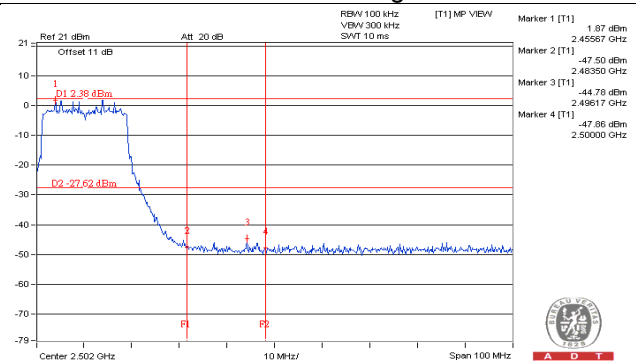

802.11n (HT20)_Chain 2

CH 1

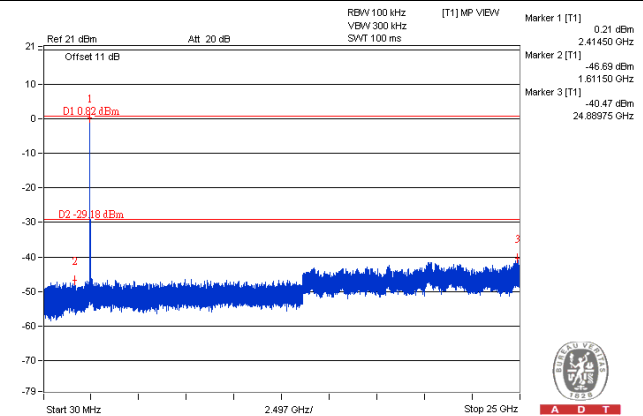
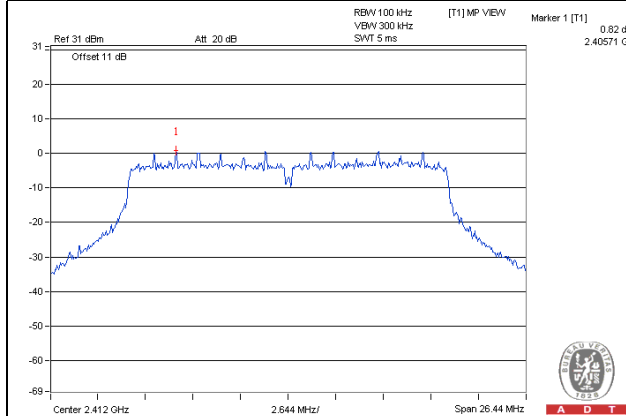

CH 6

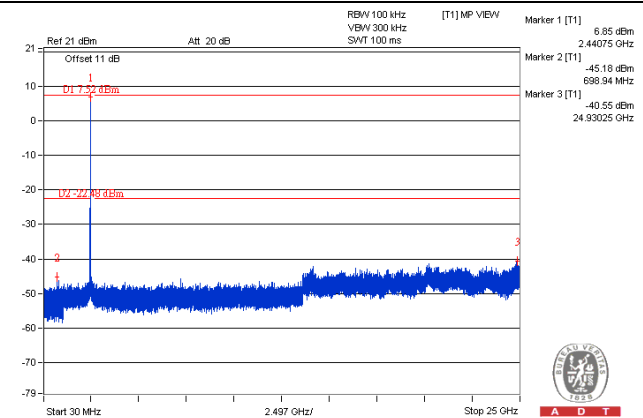
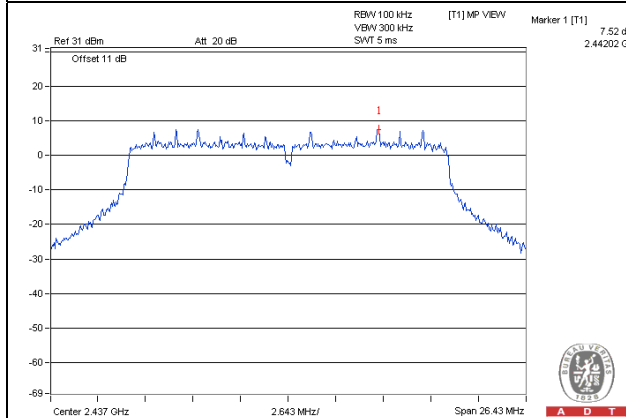

CH 11

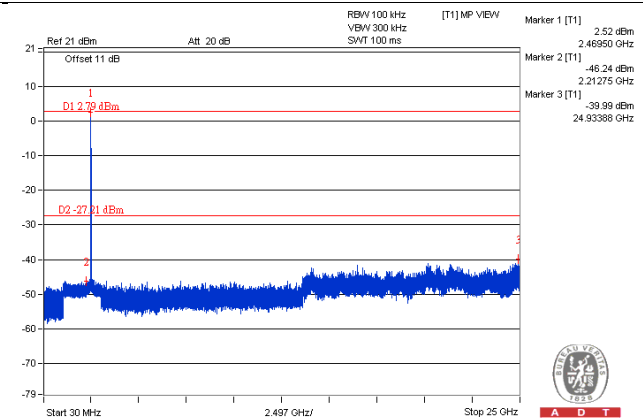
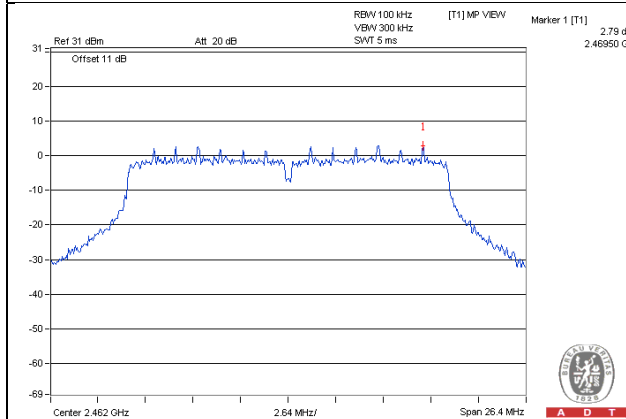

CH 1 Band edge

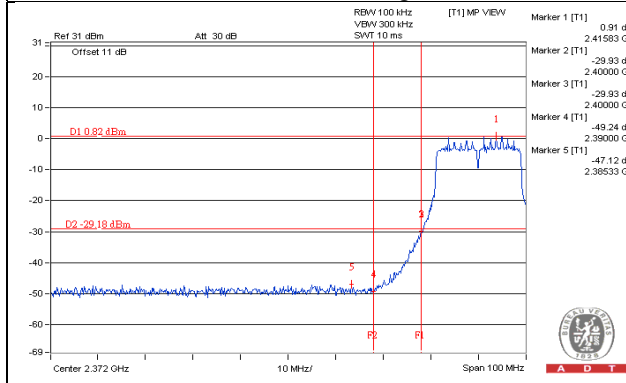

CH 11 Band edge

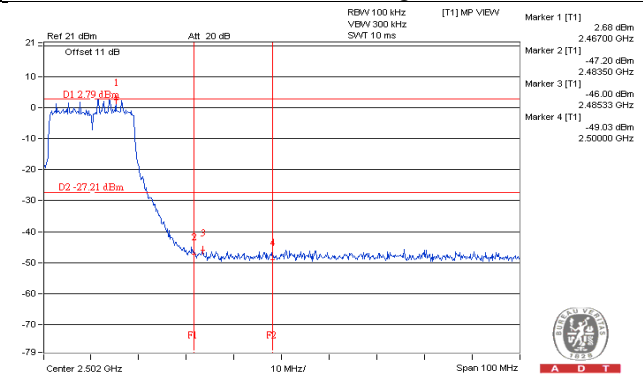

802.11n (HT40)_Chain 0

CH 3

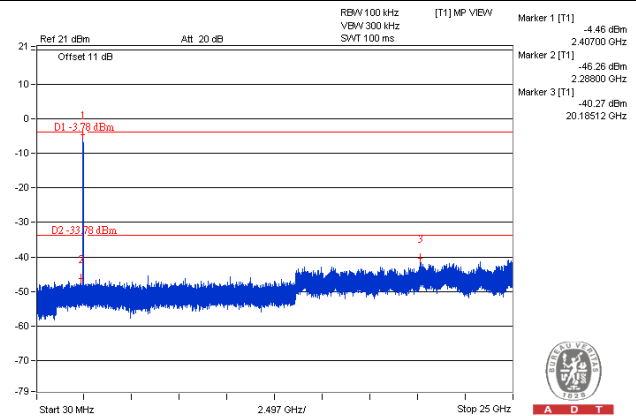
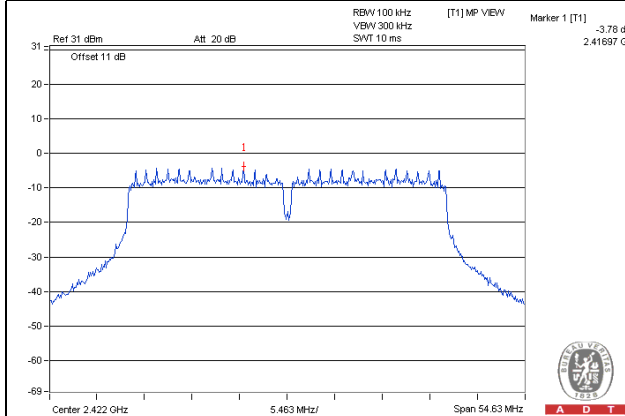

CH 6

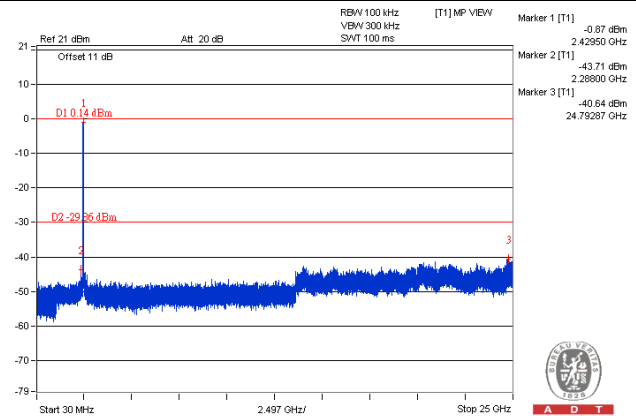
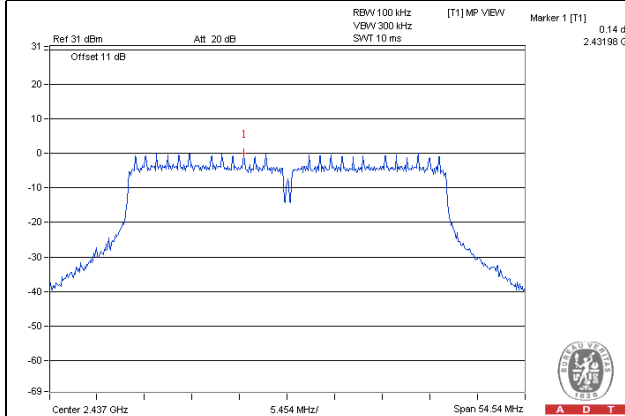

CH 9

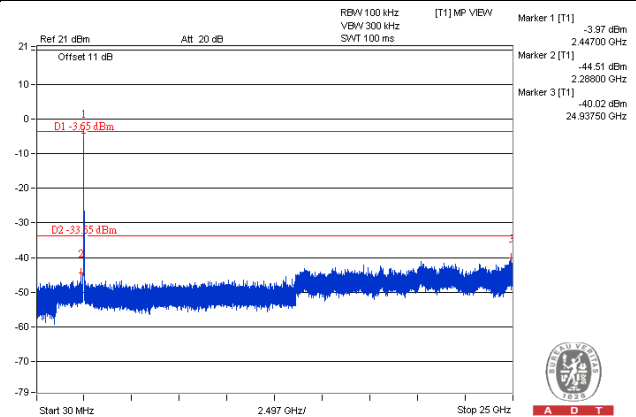
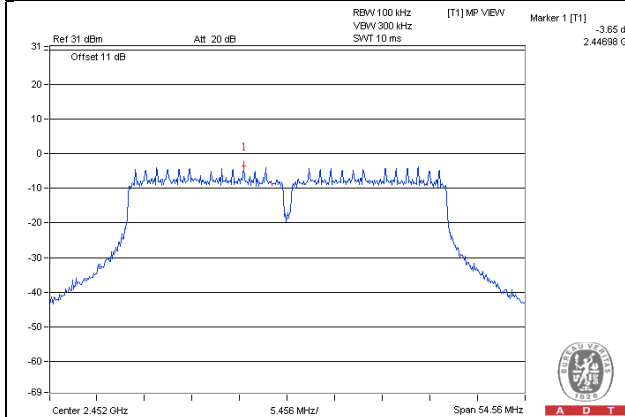

CH 3 Band edge

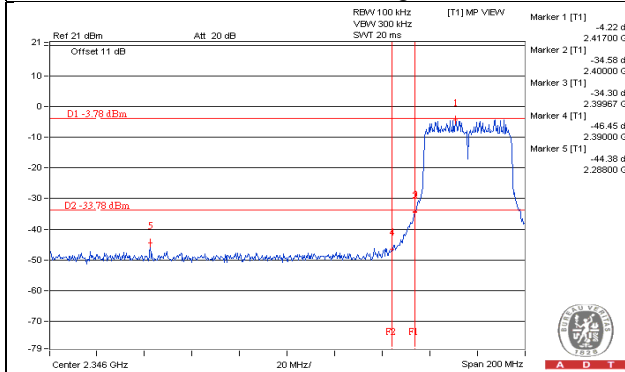

CH 9 Band edge

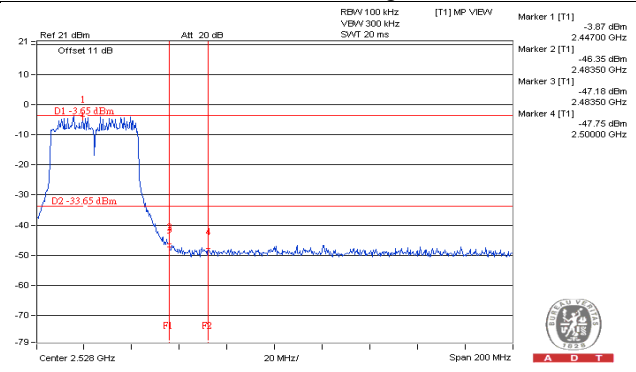

802.11n (HT40)_Chain 1

CH 3

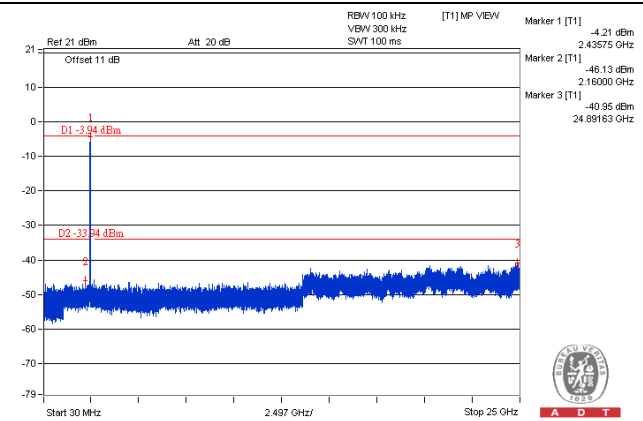
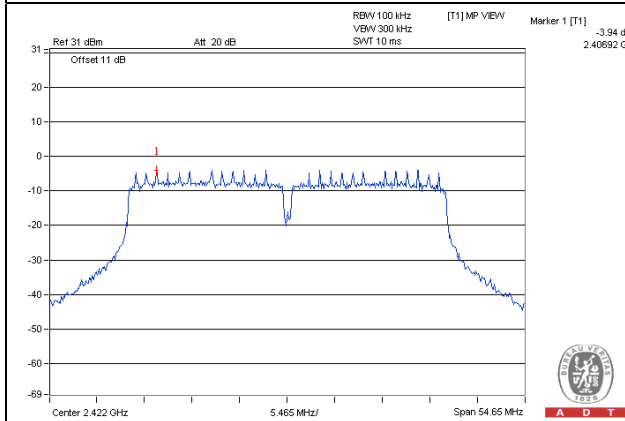

CH 6

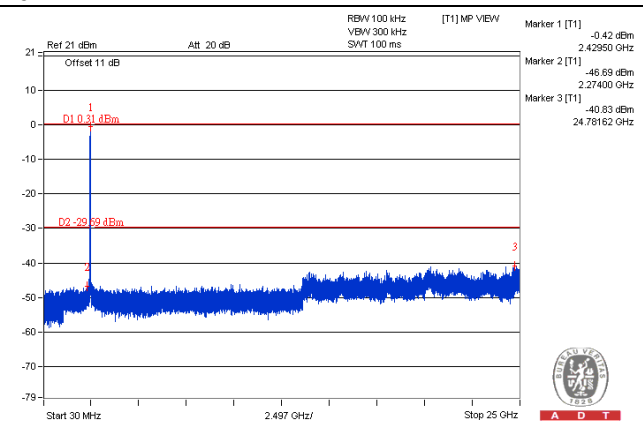
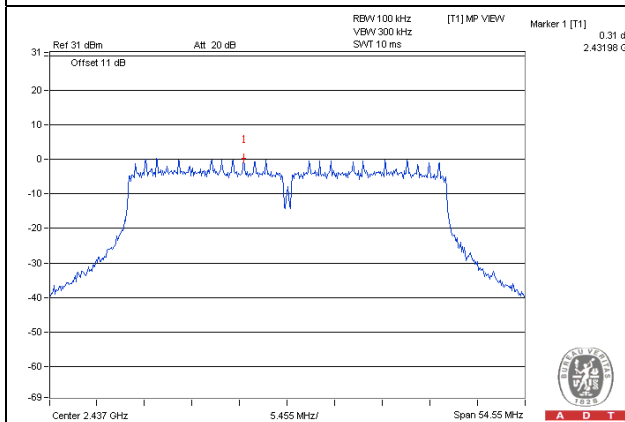

CH 9

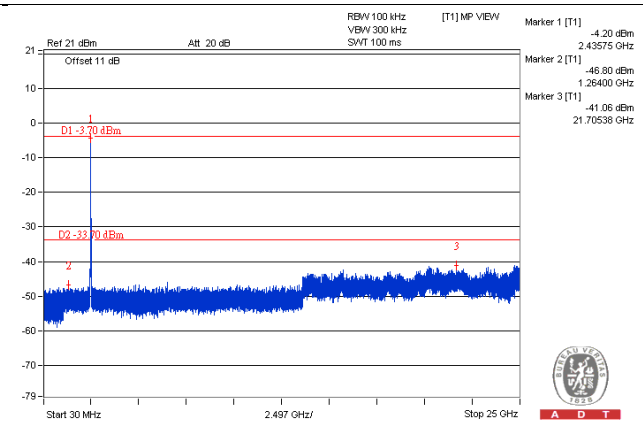
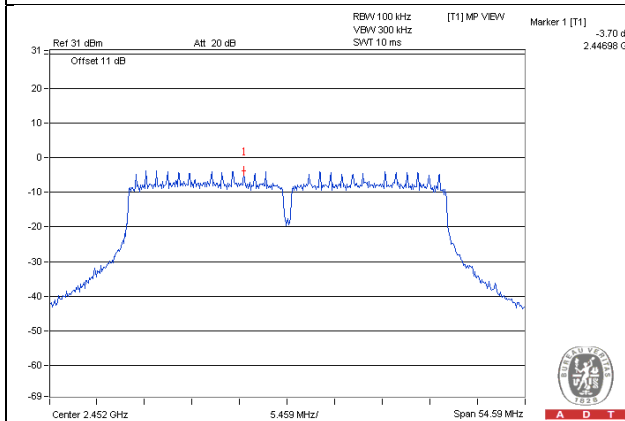

CH 3 Band edge

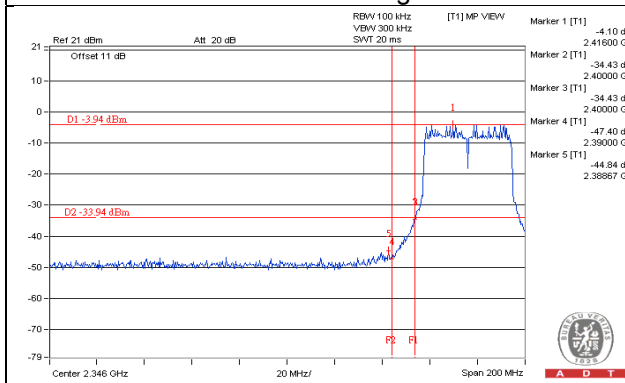

CH 9 Band edge

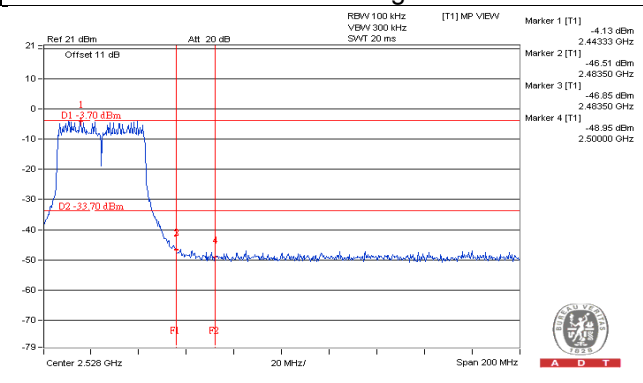

802.11n (HT40)_Chain 2

CH 3

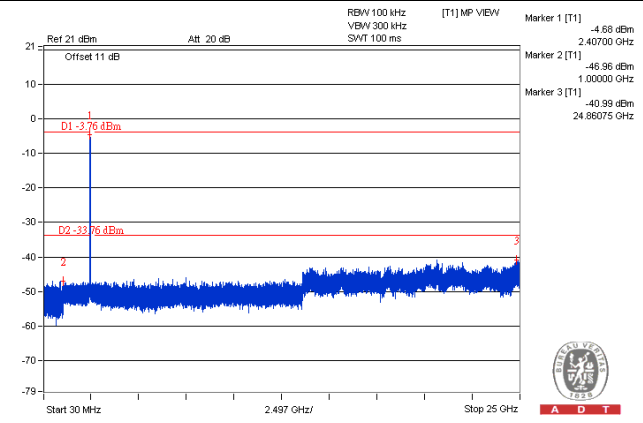
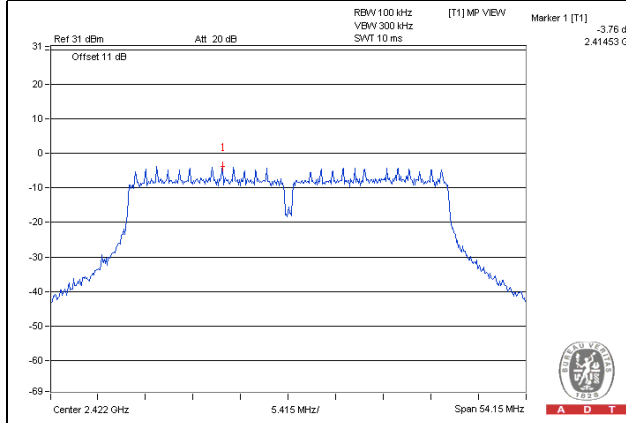

CH 6

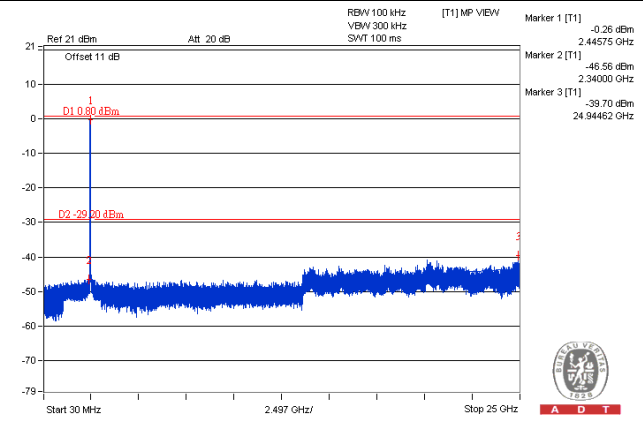
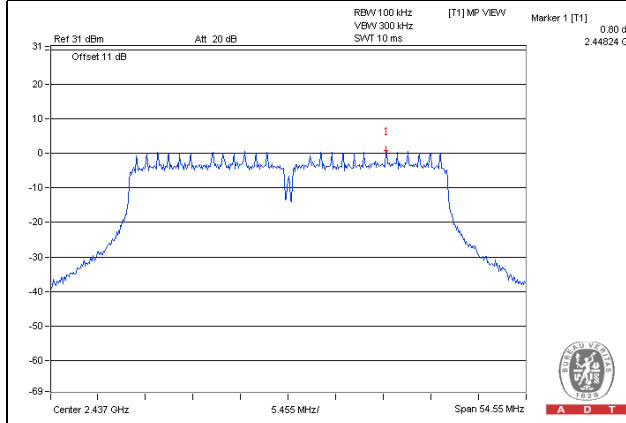

CH 9

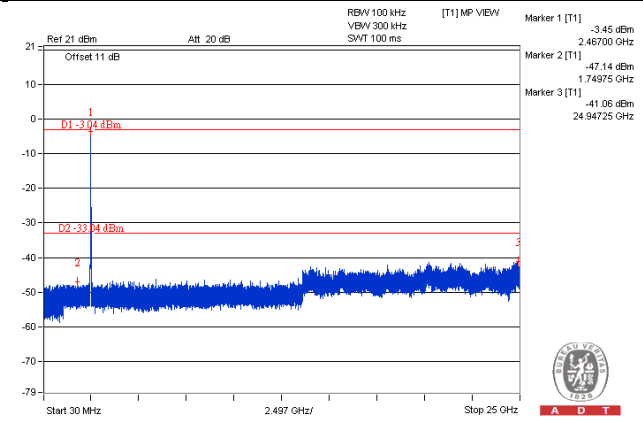
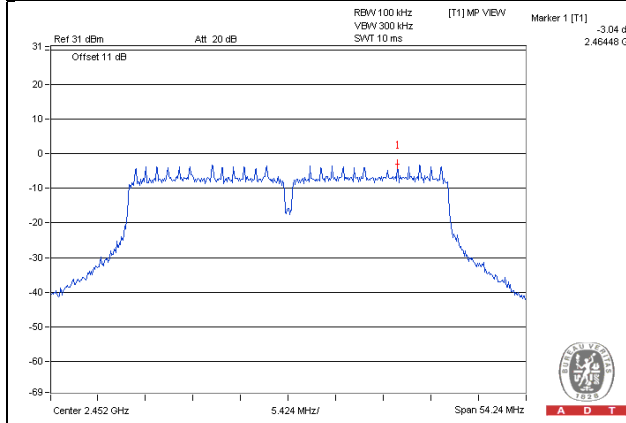

CH 3 Band edge

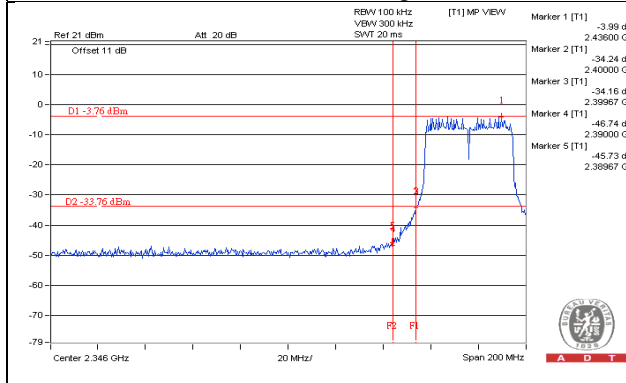

CH 9 Band edge

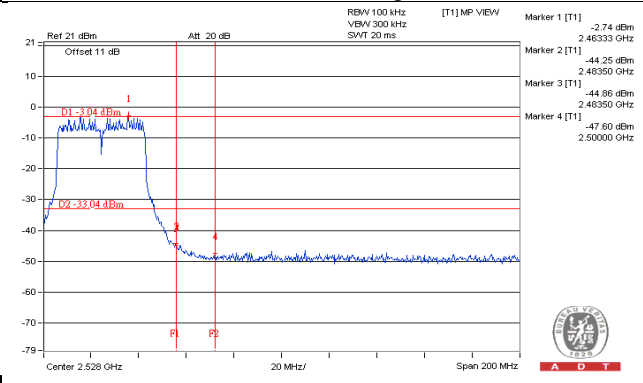

5 Pictures of Test Arrangements

Please refer to the attached file (Test Setup Photo).

Appendix – Information on the Testing Laboratories

We, Bureau Veritas Consumer Products Services (H.K.) Ltd., Taoyuan Branch, were founded in 1988 to provide our best service in EMC, Radio, Telecom and Safety consultation. Our laboratories are accredited and approved according to ISO/IEC 17025.

If you have any comments, please feel free to contact us at the following:

Linko EMC/RF Lab

Tel: 886-2-26052180

Fax: 886-2-26051924

Hsin Chu EMC/RF/Telecom Lab

Tel: 886-3-6668565

Fax: 886-3-6668323

Hwa Ya EMC/RF/Safety Lab

Tel: 886-3-3183232

Fax: 886-3-3270892

Email: service.adt@tw.bureauveritas.com

Web Site: www.bureauveritas-adt.com

The address and road map of all our labs can be found in our web site also.

--- END ---