

## FCC Test Report

**Report No.:** RF140224C17L

**FCC ID:** ZHV-DTAF A

**Test Model:** DTAF A

**Received Date:** Feb. 24, 2014

**Test Date:** Mar. 13 ~ Mar. 20, 2016

**Issued Date:** Apr. 19, 2016

**Applicant:** Riverbed Technology Inc.

**Address:** 680 Folsom Street San Francisco, California USA 94107

**Issued By:** Bureau Veritas Consumer Products Services (H.K.) Ltd., Taoyuan Branch

**Lab Address:** No. 47-2, 14th Ling, Chia Pau Vil., Lin Kou Dist., New Taipei City, Taiwan, R.O.C.

**Test Location:** No.19, Hwa Ya 2nd Rd., Wen Hwa Vil., Kwei Shan Dist., Taoyuan City 33383, TAIWAN (R.O.C.)



This report is for your exclusive use. Any copying or replication of this report to or for any other person or entity, or use of our name or trademark, is permitted only with our prior written permission. This report sets forth our findings solely with respect to the test samples identified herein. The results set forth in this report are not indicative or representative of the quality or characteristics of the lot from which a test sample was taken or any similar or identical product unless specifically and expressly noted. Our report includes all of the tests requested by you and the results thereof based upon the information that you provided to us. You have 60 days from date of issuance of this report to notify us of any material error or omission caused by our negligence, provided, however, that such notice shall be in writing and shall specifically address the issue you wish to raise. A failure to raise such issue within the prescribed time shall constitute your unqualified acceptance of the completeness of this report, the tests conducted and the correctness of the report contents. Unless specific mention, the uncertainty of measurement has been explicitly taken into account to declare the compliance or non-compliance to the specification. This report should not be used by the client to claim product certification, approval, or endorsement by TAF or any government agencies.



## Table of Contents

<b>Release Control Record</b> .....	<b>4</b>
<b>1 Certificate of Conformity</b> .....	<b>5</b>
<b>2 Summary of Test Results</b> .....	<b>6</b>
2.1 Measurement Uncertainty.....	6
2.2 Modification Record.....	6
<b>3 General Information</b> .....	<b>7</b>
3.1 General Description of EUT.....	7
3.2 Description of Test Modes.....	8
3.2.1 Test Mode Applicability and Tested Channel Detail.....	9
3.3 Duty Cycle of Test Signal.....	11
3.4 Description of Support Units.....	12
3.4.1 Configuration of System under Test.....	13
3.5 General Description of Applied Standards.....	14
<b>4 Test Types and Results</b> .....	<b>15</b>
4.1 Radiated Emission and Bandedge Measurement.....	15
4.1.1 Limits of Radiated Emission and Bandedge Measurement.....	15
4.1.2 Test Instruments.....	16
4.1.3 Test Procedures.....	17
4.1.4 Deviation from Test Standard.....	17
4.1.5 Test Set Up.....	18
4.1.6 EUT Operating Conditions.....	18
4.1.7 Test Results.....	19
4.2 Conducted Emission Measurement.....	33
4.2.1 Limits of Conducted Emission Measurement.....	33
4.2.2 Test Instruments.....	33
4.2.3 Test Procedures.....	34
4.2.4 Deviation from Test Standard.....	34
4.2.5 Test Setup.....	34
4.2.6 EUT Operating Conditions.....	34
4.2.7 Test Results.....	35
4.3 6dB Bandwidth Measurement.....	39
4.3.1 Limits of 6dB Bandwidth Measurement.....	39
4.3.2 Test Setup.....	39
4.3.3 Test Instruments.....	39
4.3.4 Test Procedure.....	39
4.3.5 Deviation from Test Standard.....	39
4.3.6 EUT Operating Conditions.....	39
4.3.7 Test Result.....	40
4.4 Conducted Output Power Measurement.....	42
4.4.1 Limits of Conducted Output Power Measurement.....	42
4.4.2 Test Setup.....	42
4.4.3 Test Instruments.....	42
4.4.4 Test Procedures.....	42
4.4.5 Deviation from Test Standard.....	42
4.4.6 EUT Operating Conditions.....	42
4.4.7 Test Results.....	43
4.5 Power Spectral Density Measurement.....	44
4.5.1 Limits of Power Spectral Density Measurement.....	44
4.5.2 Test Setup.....	44
4.5.3 Test Instruments.....	44
4.5.4 Test Procedure.....	44
4.5.5 Deviation from Test Standard.....	45
4.5.6 EUT Operating Condition.....	45



4.5.7 Test Results .....	46
4.6 Conducted Out of Band Emission Measurement.....	49
4.6.1 Limits of Conducted Out of Band Emission Measurement .....	49
4.6.2 Test Setup.....	49
4.6.3 Test Instruments .....	49
4.6.4 Test Procedure .....	49
4.6.5 Deviation from Test Standard .....	50
4.6.6 EUT Operating Condition .....	50
4.6.7 Test Results .....	50
<b>5 Pictures of Test Arrangements.....</b>	<b>63</b>
<b>Appendix – Information on the Testing Laboratories .....</b>	<b>64</b>



A D T

### Release Control Record

Issue No.	Description	Date Issued
RF140224C17L	Original release	Apr. 19, 2016

## 1 Certificate of Conformity

**Product:** Wireless a/b/g/n/AC Access Point

**Brand:** riverbed

**Test Model:** DTAF A

**Sample Status:** Engineering Sample

**Applicant:** Riverbed Technology Inc.

**Test Date:** Mar. 13 ~ Mar. 20, 2016

**Standards:** 47 CFR FCC Part 15, Subpart C (Section 15.247)  
ANSI C63.10:2013

The above equipment has been tested by **Bureau Veritas Consumer Products Services (H.K.) Ltd., Taoyuan Branch**, and found compliance with the requirement of the above standards. The test record, data evaluation & Equipment Under Test (EUT) configurations represented herein are true and accurate accounts of the measurements of the sample's EMC characteristics under the conditions specified in this report.

**Prepared by :** Celine Chou , **Date:** Apr. 19, 2016  
Celine Chou / Specialist

**Approved by :** Ken Liu , **Date:** Apr. 19, 2016  
Ken Liu / Senior Manager

## 2 Summary of Test Results

47 CFR FCC Part 15, Subpart C (Section 15.247)			
FCC Clause	Test Item	Result	Remarks
15.207	AC Power Conducted Emission	Pass	Meet the requirement of limit. Minimum passing margin is -2.01dB at 0.47422MHz.
15.205 / 15.209 / 15.247(d)	Radiated Emissions and Band Edge Measurement	Pass	Meet the requirement of limit. Minimum passing margin is -1.0dB at 2390.00MHz.
15.247(d)	Antenna Port Emission	Pass	Meet the requirement of limit.
15.247(a)(2)	6dB bandwidth	Pass	Meet the requirement of limit.
15.247(b)	Conducted power	Pass	Meet the requirement of limit.
15.247(e)	Power Spectral Density	Pass	Meet the requirement of limit.
15.203	Antenna Requirement	Pass	Antenna connector is IPEX not a standard connector.

### 2.1 Measurement Uncertainty

Where relevant, the following measurement uncertainty levels have been estimated for tests performed on the EUT as specified in CISPR 16-4-2:

Measurement	Frequency	Expanded Uncertainty (k=2) (±)
Conducted Emissions at mains ports	150kHz ~ 30MHz	2.44 dB
Radiated Emissions up to 1 GHz	30MHz ~ 200MHz	3.19 dB
	200MHz ~ 1000MHz	3.21 dB
Radiated Emissions above 1 GHz	1GHz ~ 18GHz	2.29 dB
	18GHz ~ 40GHz	2.29 dB

### 2.2 Modification Record

There were no modifications required for compliance.

### 3 General Information

#### 3.1 General Description of EUT

Product	Wireless a/b/g/n/AC Access Point
Brand	<b>riverbed</b>
Test Model	DTAFA
Sample Status	Engineering Sample
Power Supply Rating	12Vdc from adapter 48Vdc from POE
Modulation Type	CCK, DQPSK, DBPSK for DSSS 64QAM, 16QAM, QPSK, BPSK for OFDM
Modulation Technology	DSSS, OFDM
Transfer Rate	802.11b: 11.0/ 5.5/ 2.0/ 1.0Mbps 802.11g: 54.0/ 48.0/ 36.0/ 24.0/ 18.0/ 12.0/ 9.0/ 6.0Mbps 802.11n: up to 450.0Mbps
Operating Frequency	2412 ~ 2462MHz
Number of Channel	11 for 802.11b, 802.11g, 802.11n (20MHz) 7 for 802.11n (40MHz)
Output Power	739.930mW
Antenna Type	PIFA antenna with 4.0dBi gain
Antenna Connector	IPEX
Accessory Device	Adapter
Data Cable Supplied	NA

Note:

- The EUT incorporates a MIMO function. Physically, the EUT provides 3 completed transmitters and 3 receivers.

Modulation Mode	TX Function
802.11b	3TX
802.11g	3TX
802.11n (20MHz)	3TX
802.11n (40MHz)	3TX

- The EUT consumes power from the following adapter & PoE.

<b>Adapter</b>	
Brand:	Powertron Electronics Corp.
Model:	PA1024-2HUB PA1024-2HU PA1024-120HUB200
Input:	100-240Vac, 50-60Hz, 0.6A
Output:	12Vdc, 2.0A, 24W Max
Power Line:	1.50m non-shielded cable with one core

<b>POE (Support units only)</b>	
Brand:	EnGenius
Model:	NPE-5818
Output:	48Vdc, 0.5A
<b>Adapter for POE (Support units only)</b>	
Brand:	Powertron Electronics Corp.
Model:	PA1024-480DUB050
Input:	100-240V~50-60Hz 0.6A
Output:	48Vdc, 0.5A, 24W Max
Power Line:	1.55m non-shielded cable without core

### 3.2 Description of Test Modes

11 channels are provided for 802.11b, 802.11g and 802.11n (20MHz):

Channel	Frequency	Channel	Frequency
1	2412MHz	7	2442MHz
2	2417MHz	8	2447MHz
3	2422MHz	9	2452MHz
4	2427MHz	10	2457MHz
5	2432MHz	11	2462MHz
6	2437MHz		

7 channels are provided for 802.11n (40MHz):

Channel	Frequency	Channel	Frequency
3	2422MHz	7	2442MHz
4	2427MHz	8	2447MHz
5	2432MHz	9	2452MHz
6	2437MHz		



### 3.2.1 Test Mode Applicability and Tested Channel Detail

EUT CONFIGURE MODE	APPLICABLE TO				DESCRIPTION
	RE $\geq$ 1G	RE $<$ 1G	PLC	APCM	
A	-	√	√	-	Power from adapter
B	√	√	√	√	Power from PoE

Where **RE $\geq$ 1G**: Radiated Emission above 1GHz & Bandedge Measurement  
**RE $<$ 1G**: Radiated Emission below 1GHz  
**PLC**: Power Line Conducted Emission  
**APCM**: Antenna Port Conducted Measurement

Note:

1. The EUT had been pre-tested on the positioned of each 3 axis. The worst case was found when positioned on **Z-plane**.
2. "-" means no effect.

#### Radiated Emission Test (Above 1GHz):

- Pre-Scan has been conducted to determine the worst-case mode from all possible combinations between available modulations, data rates and antenna ports (if EUT with antenna diversity architecture).
- Following channel(s) was (were) selected for the final test as listed below.

EUT CONFIGURE MODE	MODE	AVAILABLE CHANNEL	TESTED CHANNEL	MODULATION TECHNOLOGY	MODULATION TYPE	DATA RATE (Mbps)
B	802.11b	1 to 11	1, 6, 11	DSSS	DBPSK	1.0
B	802.11g	1 to 11	1, 6, 11	OFDM	BPSK	6.0
B	802.11n (20MHz)	1 to 11	1, 6, 11	OFDM	BPSK	7.2
B	802.11n (40MHz)	3 to 9	3, 6, 9	OFDM	BPSK	15.0

#### Radiated Emission Test (Below 1GHz):

- Pre-Scan has been conducted to determine the worst-case mode from all possible combinations between available modulations, data rates and antenna ports (if EUT with antenna diversity architecture).
- Following channel(s) was (were) selected for the final test as listed below.

EUT CONFIGURE MODE	MODE	AVAILABLE CHANNEL	TESTED CHANNEL	MODULATION TECHNOLOGY	MODULATION TYPE	DATA RATE (Mbps)
A, B	802.11g	1 to 11	6	OFDM	BPSK	6.0

#### Power Line Conducted Emission Test:

- Pre-Scan has been conducted to determine the worst-case mode from all possible combinations between available modulations, data rates and antenna ports (if EUT with antenna diversity architecture).
- Following channel(s) was (were) selected for the final test as listed below.

EUT CONFIGURE MODE	MODE	AVAILABLE CHANNEL	TESTED CHANNEL	MODULATION TECHNOLOGY	MODULATION TYPE	DATA RATE (Mbps)
A, B	802.11g	1 to 11	6	OFDM	BPSK	6.0

**Antenna Port Conducted Measurement:**

- This item includes all test value of each mode, but only includes spectrum plot of worst value of each mode.
- Pre-Scan has been conducted to determine the worst-case mode from all possible combinations between available modulations, data rates and antenna ports (if EUT with antenna diversity architecture).
- Following channel(s) was (were) selected for the final test as listed below.

EUT CONFIGURE MODE	MODE	AVAILABLE CHANNEL	TESTED CHANNEL	MODULATION TECHNOLOGY	MODULATION TYPE	DATA RATE (Mbps)
B	802.11b	1 to 11	1, 6, 11	DSSS	DBPSK	1.0
B	802.11g	1 to 11	1, 6, 11	OFDM	BPSK	6.0
B	802.11n (20MHz)	1 to 11	1, 6, 11	OFDM	BPSK	7.2
B	802.11n (40MHz)	3 to 9	3, 6, 9	OFDM	BPSK	15.0

**Test Condition:**

APPLICABLE TO	ENVIRONMENTAL CONDITIONS	INPUT POWER	TESTED BY
<b>RE<math>\geq</math>1G</b>	16deg. C, 70%RH	48Vdc	Nick Hsu
<b>RE<math>&lt;</math>1G</b>	25deg. C, 65%RH	120Vac, 60Hz 48Vdc	Chris Lin
<b>PLC</b>	25deg. C, 65%RH	120Vac, 60Hz 48Vdc	Ted Chang
<b>APCM</b>	24deg. C, 64%RH	48Vdc	Match Tsui

### 3.3 Duty Cycle of Test Signal

802.11b: Duty cycle of test signal is > 98 %

802.11g, 802.11n (20MHz), 802.11n (40MHz): Duty cycle of test signal is < 98%

802.11g: Duty cycle = 2.02/2.08 = 0.971, Duty factor =  $10 * \log(1/0.971) = 0.13$

802.11n (20MHz): Duty cycle = 1.88/1.93 = 0.974, Duty factor =  $10 * \log(1/0.974) = 0.11$

802.11n (40MHz): Duty cycle = 0.922/1 = 0.922, Duty factor =  $10 * \log(1/0.922) = 0.35$

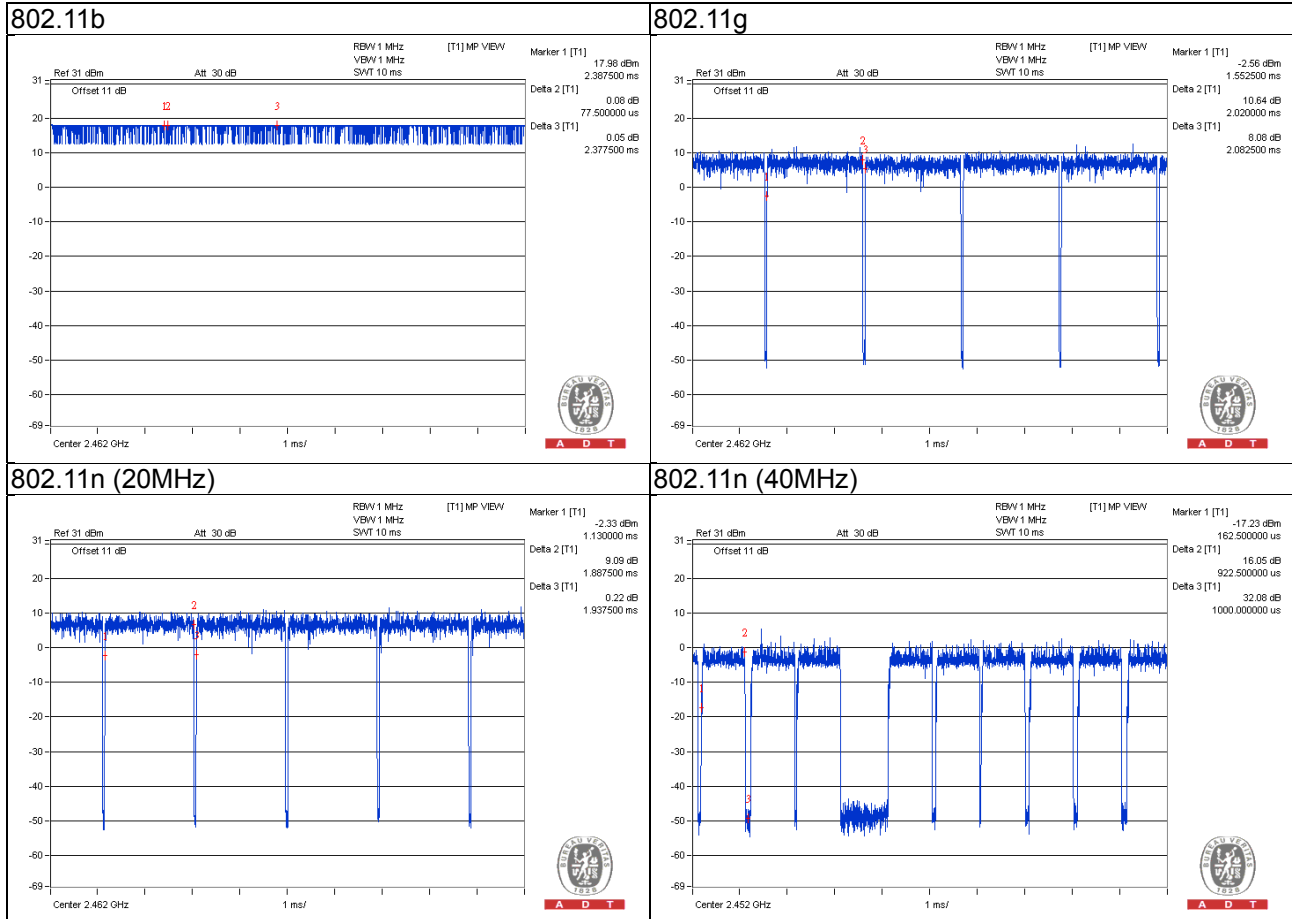

### 3.4 Description of Support Units

The EUT has been tested as an independent unit together with other necessary accessories or support units. The following support units or accessories were used to form a representative test configuration during the tests.

ID	Product	Brand	Model No.	Serial No.	FCC ID	Remarks
A.	Notebook	DELL	E5410	1HC2XM1	FCC DoC Approved	-
B.	POE	EnGenius	NPE-5818	NA	NA	For test mode B only
C.	Adapter	Powertron Electronics Corp.	PA1024-480DUB050	NA	NA	For test mode B only

Note:

1. All power cords of the above support units are non-shielded (1.8m).
2. Items A acted as communication partners to transfer data.

ID	Descriptions	Qty.	Length (m)	Shielding (Yes/No)	Cores (Qty.)	Remarks
1.	LAN cable	1	10	N	0	-
2.	LAN cable	1	1.8	N	0	For test mode B only
3.	DC power cable	1	1.55	N	0	Attached on the adapter For test mode B only

### 3.4.1 Configuration of System under Test

Test Mode A

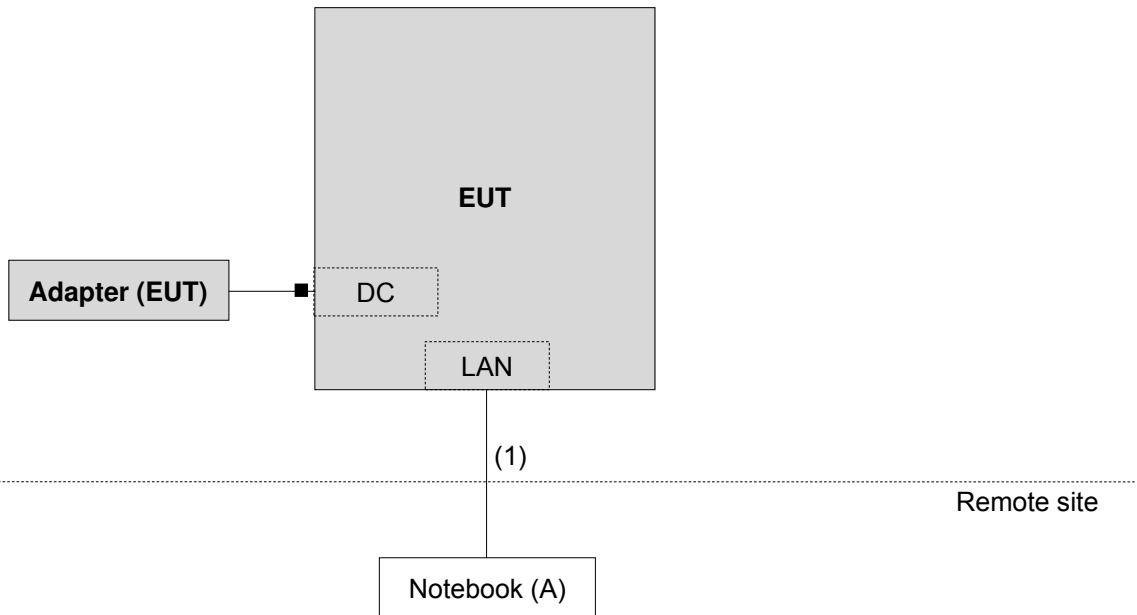

Test Mode B

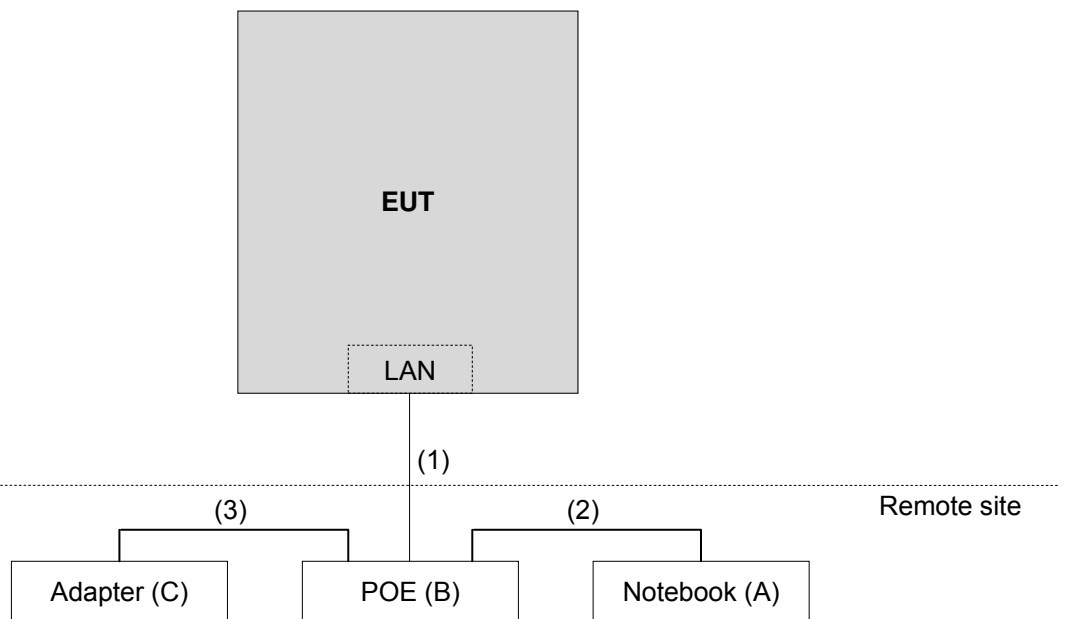

### 3.5 General Description of Applied Standards

The EUT is a RF Product. According to the specifications of the manufacturer, it must comply with the requirements of the following standards:

**FCC Part 15, Subpart C (15.247)**

**558074 D01 DTS Meas Guidance v03r05**

**662911 D01 Multiple Transmitter Output v02r01**

ANSI C63.10-2013

All test items have been performed and recorded as per the above standards.

Note: The EUT is also considered as a kind of computer peripheral, because the connection to computer is necessary for typical use. It has been verified to comply with the requirements of FCC Part 15, Subpart B, Class B (DoC). The test report has been issued separately.

## 4 Test Types and Results

### 4.1 Radiated Emission and Bandedge Measurement

#### 4.1.1 Limits of Radiated Emission and Bandedge Measurement

Radiated emissions which fall in the restricted bands must comply with the radiated emission limits specified as below table. Other emissions shall be at least 30dB below the highest level of the desired power:

Frequencies (MHz)	Field Strength (microvolts/meter)	Measurement Distance (meters)
0.009 ~ 0.490	2400/F(kHz)	300
0.490 ~ 1.705	24000/F(kHz)	30
1.705 ~ 30.0	30	30
30 ~ 88	100	3
88 ~ 216	150	3
216 ~ 960	200	3
Above 960	500	3

**Note:**

1. The lower limit shall apply at the transition frequencies.
2. Emission level (dBuV/m) = 20 log Emission level (uV/m).
3. For frequencies above 1000MHz, the field strength limits are based on average detector, however, the peak field strength of any emission shall not exceed the maximum permitted average limits, specified above by more than 30dB under any condition of modulation.



#### 4.1.2 Test Instruments

Description & Manufacturer	Model No.	Serial No.	Cal. Date	Cal. Due
Test Receiver ROHDE & SCHWARZ	ESIB7	100187	Apr. 10, 2015	Apr. 09, 2016
Spectrum Analyzer ROHDE & SCHWARZ	FSP40	100041	Sep. 02, 2015	Sep. 01, 2016
BILOG Antenna SCHWARZBECK	VULB9168	9168-151	Jan. 07, 2016	Jan. 06, 2017
HORN Antenna SCHWARZBECK	9120D	209	Jan. 20, 2016	Jan. 19, 2017
HORN Antenna SCHWARZBECK	BBHA 9170	BBHA9170241	Jan. 18, 2016	Jan. 17, 2017
Preamplifier Agilent	8447D	2944A10738	Oct. 18, 2015	Oct. 17, 2016
Preamplifier Agilent	8449B	3008A01964	Aug. 22, 2015	Aug. 21, 2016
RF signal cable HUBER+SUHNER	SUCOFLEX 104	Cable-CH3-03 (214378)	Aug. 22, 2015	Aug. 21, 2016
RF signal cable HUBER+SUHNER	SUCOFLEX 106	Cable-CH3-03 (309224+12738)	Aug. 22, 2015	Aug. 21, 2016
Software BV ADT	ADT_Radiated_ V7.6.15.9.4	NA	NA	NA
Antenna Tower inn-co GmbH	MA 4000	013303	NA	NA
Antenna Tower Controller BV ADT	AT100	AT93021702	NA	NA
Turn Table BV ADT	TT100	TT93021702	NA	NA
Turn Table Controller BV ADT	SC100	SC93021702	NA	NA
High Speed Peak Power Meter	ML2495A	0824011	Jul. 09, 2015	Jul. 08, 2016
Power Sensor	MA2411B	0738171	Jul. 09, 2015	Jul. 08, 2016

- Note: 1. The calibration interval of the above test instruments is 12 months and the calibrations are traceable to NML/ROC and NIST/USA.  
2. The test was performed in HwaYa Chamber 3.  
3. The horn antenna and preamplifier (model: 8449B) are used only for the measurement of emission frequency above 1GHz if tested.  
4. The FCC Site Registration No. is 988962.  
5. The IC Site Registration No. is IC 7450F-3.



#### 4.1.3 Test Procedures

- a. The EUT was placed on the top of a rotating table 0.8 meters (for below 1GHz) / 1.5 meters (for above 1GHz) above the ground at 3 meter chamber room for test. The table was rotated 360 degrees to determine the position of the highest radiation.
- b. The EUT was set 3 meters away from the interference-receiving antenna, which was mounted on the top of a variable-height antenna tower.
- c. The height of antenna is varied from one meter to four meters above the ground to determine the maximum value of the field strength. Both horizontal and vertical polarizations of the antenna are set to make the measurement.
- d. For each suspected emission, the EUT was arranged to its worst case and then the antenna was tuned to heights from 1 meter to 4 meters and the rotatable table was turned from 0 degrees to 360 degrees to find the maximum reading.
- e. The test-receiver system was set to quasi-peak detect function and specified bandwidth with maximum hold mode when the test frequency is below 1 GHz.
- f. The test-receiver system was set to peak and average detect function and specified bandwidth with maximum hold mode when the test frequency is above 1 GHz. If the peak reading value also meets average limit, measurement with the average detector is unnecessary.

**Note:**

1. The resolution bandwidth and video bandwidth of test receiver/spectrum analyzer is 120kHz for Quasi-peak detection (QP) at frequency below 1GHz.
2. The resolution bandwidth of test receiver/spectrum analyzer is 1 MHz and the video bandwidth is 3 MHz for Peak detection (PK) at frequency above 1GHz.
3. The resolution bandwidth of test receiver/spectrum analyzer is 1MHz and the video bandwidth is 3MHz for RMS Average (Duty cycle < 98%) for Average detection (AV) at frequency above 1GHz, then the measurement results was added to a correction factor ( $10 \log(1/\text{duty cycle})$ ).
4. The resolution bandwidth of test receiver/spectrum analyzer is 1MHz and the video bandwidth is 10Hz (Duty cycle  $\geq 98\%$ ) for Average detection (AV) at frequency above 1GHz.
5. All modes of operation were investigated and the worst-case emissions are reported.

#### 4.1.4 Deviation from Test Standard

No deviation.

#### 4.1.5 Test Set Up

##### <Frequency Range below 1GHz>

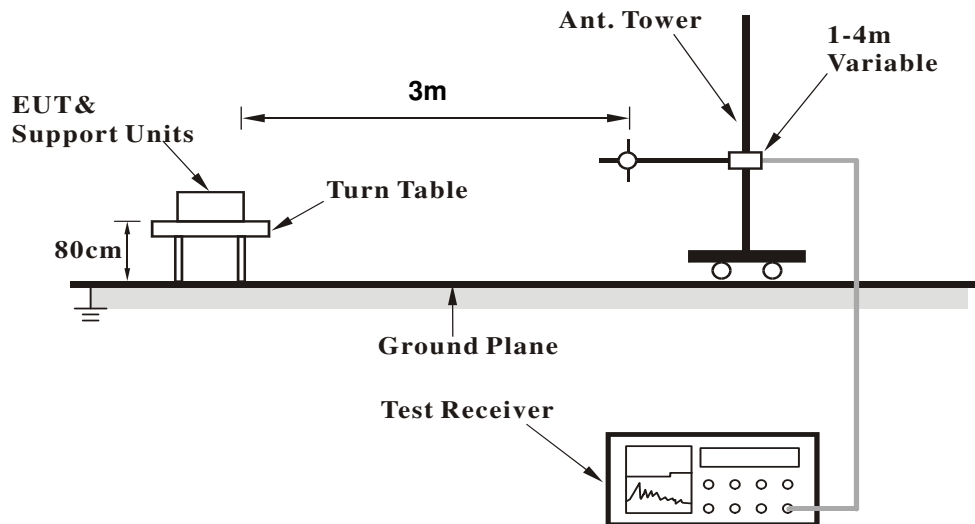

##### <Frequency Range above 1GHz>

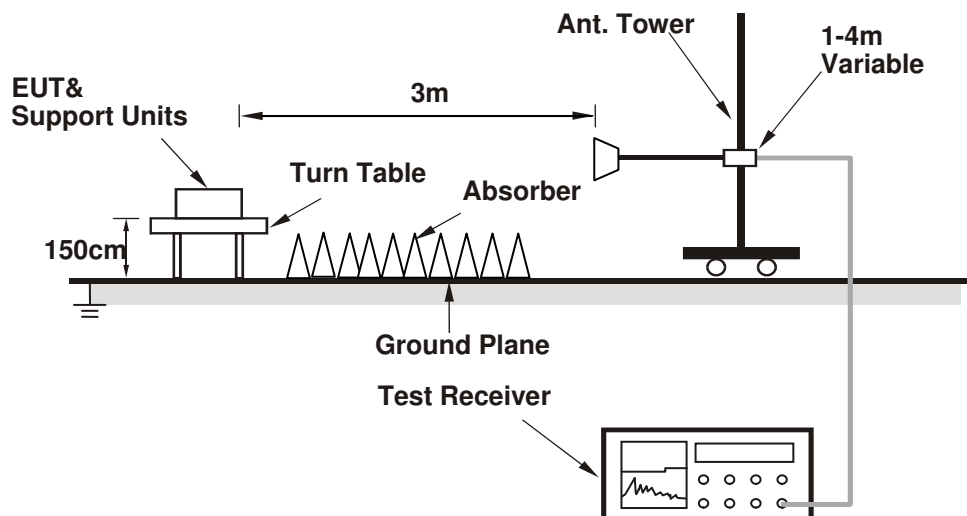

For the actual test configuration, please refer to the attached file (Test Setup Photo).

#### 4.1.6 EUT Operating Conditions

- Placed the EUT on the testing table.
- Prepared notebook to act as communication partner and placed it outside of testing area.
- The communication partner connected with EUT via a RJ45 cable and ran a test program (provided by manufacturer) to enable EUT under transmission condition continuously at specific channel frequency.
- The communication partner sent data to EUT by command "PING".

#### 4.1.7 Test Results

Above 1GHz worst-case data:

802.11b

CHANNEL	TX Channel 1	DETECTOR	Peak (PK)
FREQUENCY RANGE	1GHz ~ 25GHz	FUNCTION	Average (AV)

#### ANTENNA POLARITY & TEST DISTANCE: HORIZONTAL AT 3 M

NO.	FREQ. (MHz)	EMISSION LEVEL (dBuV/m)	LIMIT (dBuV/m)	MARGIN (dB)	ANTENNA HEIGHT (m)	TABLE ANGLE (Degree)	RAW VALUE (dBuV)	CORRECTION FACTOR (dB/m)
1	2370.00	62.0 PK	74.0	-12.0	1.60 H	338	29.30	32.70
2	2370.00	52.2 AV	54.0	-1.8	1.60 H	338	19.50	32.70
3	*2412.00	121.0 PK			1.13 H	321	88.10	32.90
4	*2412.00	117.4 AV			1.13 H	321	84.50	32.90
5	4824.00	52.4 PK	74.0	-21.6	1.15 H	185	46.50	5.90
6	4824.00	46.5 AV	54.0	-7.5	1.15 H	185	40.60	5.90

#### ANTENNA POLARITY & TEST DISTANCE: VERTICAL AT 3 M

NO.	FREQ. (MHz)	EMISSION LEVEL (dBuV/m)	LIMIT (dBuV/m)	MARGIN (dB)	ANTENNA HEIGHT (m)	TABLE ANGLE (Degree)	RAW VALUE (dBuV)	CORRECTION FACTOR (dB/m)
1	2370.00	68.2 PK	74.0	-5.8	1.80 V	346	35.50	32.70
2	2370.00	51.3 AV	54.0	-2.7	1.80 V	346	18.60	32.70
3	*2412.00	118.3 PK			2.84 V	336	85.40	32.90
4	*2412.00	114.5 AV			2.84 V	336	81.60	32.90
5	4824.00	52.3 PK	74.0	-21.7	1.61 V	137	46.40	5.90
6	4824.00	46.6 AV	54.0	-7.4	1.61 V	137	40.70	5.90

Remarks:

1. Emission Level(dBuV/m) = Raw Value(dBuV) + Correction Factor(dB/m)
2. Correction Factor(dB/m) = Antenna Factor(dB/m) + Cable Factor(dB)
3. The other emission levels were very low against the limit.
4. Margin value = Emission Level – Limit value
5. " \* ": Fundamental frequency.

CHANNEL	TX Channel 6	DETECTOR FUNCTION	Peak (PK)
FREQUENCY RANGE	1GHz ~ 25GHz		Average (AV)

**ANTENNA POLARITY & TEST DISTANCE: HORIZONTAL AT 3 M**

NO.	FREQ. (MHz)	EMISSION LEVEL (dBuV/m)	LIMIT (dBuV/m)	MARGIN (dB)	ANTENNA HEIGHT (m)	TABLE ANGLE (Degree)	RAW VALUE (dBuV)	CORRECTION FACTOR (dB/m)
1	*2437.00	119.8 PK			2.78 H	289	86.90	32.90
2	*2437.00	116.0 AV			2.78 H	289	83.10	32.90
3	4874.00	52.4 PK	74.0	-21.6	2.83 H	114	46.40	6.00
4	4874.00	46.2 AV	54.0	-7.8	2.83 H	114	40.20	6.00
5	7311.00	58.5 PK	74.0	-15.5	2.44 H	120	45.20	13.30
6	7311.00	51.4 AV	54.0	-2.6	2.44 H	120	38.10	13.30

**ANTENNA POLARITY & TEST DISTANCE: VERTICAL AT 3 M**

NO.	FREQ. (MHz)	EMISSION LEVEL (dBuV/m)	LIMIT (dBuV/m)	MARGIN (dB)	ANTENNA HEIGHT (m)	TABLE ANGLE (Degree)	RAW VALUE (dBuV)	CORRECTION FACTOR (dB/m)
1	*2437.00	118.9 PK			3.13 V	332	86.00	32.90
2	*2437.00	115.3 AV			3.13 V	332	82.40	32.90
3	4874.00	53.8 PK	74.0	-20.2	3.17 V	195	47.80	6.00
4	4874.00	49.5 AV	54.0	-4.5	3.17 V	195	43.50	6.00
5	7311.00	55.8 PK	74.0	-18.2	3.25 V	262	42.50	13.30
6	7311.00	46.7 AV	54.0	-7.3	3.25 V	262	33.40	13.30

**Remarks:**

1. Emission Level(dBuV/m) = Raw Value(dBuV) + Correction Factor(dB/m)
2. Correction Factor(dB/m) = Antenna Factor(dB/m) + Cable Factor(dB)
3. The other emission levels were very low against the limit.
4. Margin value = Emission Level – Limit value
5. " \* ": Fundamental frequency.

CHANNEL	TX Channel 11	DETECTOR FUNCTION	Peak (PK)
FREQUENCY RANGE	1GHz ~ 25GHz		Average (AV)

**ANTENNA POLARITY & TEST DISTANCE: HORIZONTAL AT 3 M**

NO.	FREQ. (MHz)	EMISSION LEVEL (dBuV/m)	LIMIT (dBuV/m)	MARGIN (dB)	ANTENNA HEIGHT (m)	TABLE ANGLE (Degree)	RAW VALUE (dBuV)	CORRECTION FACTOR (dB/m)
1	*2462.00	120.2 PK			2.25 H	304	87.30	32.90
2	*2462.00	116.4 AV			2.25 H	304	83.50	32.90
3	2483.50	61.8 PK	74.0	-12.2	2.12 H	273	28.80	33.00
4	2483.50	52.7 AV	54.0	-1.3	2.12 H	273	19.70	33.00
5	4924.00	52.4 PK	74.0	-21.6	1.67 H	143	46.40	6.00
6	4924.00	45.7 AV	54.0	-8.3	1.67 H	143	39.70	6.00
7	7386.00	57.9 PK	74.0	-16.1	1.43 H	360	44.70	13.20
8	7386.00	50.9 AV	54.0	-3.1	1.43 H	360	37.70	13.20

**ANTENNA POLARITY & TEST DISTANCE: VERTICAL AT 3 M**

NO.	FREQ. (MHz)	EMISSION LEVEL (dBuV/m)	LIMIT (dBuV/m)	MARGIN (dB)	ANTENNA HEIGHT (m)	TABLE ANGLE (Degree)	RAW VALUE (dBuV)	CORRECTION FACTOR (dB/m)
1	*2462.00	113.2 PK			1.16 V	326	80.30	32.90
2	*2462.00	109.5 AV			1.16 V	326	76.60	32.90
3	2483.50	59.6 PK	74.0	-14.4	1.08 V	8	26.60	33.00
4	2483.50	49.4 AV	54.0	-4.6	1.08 V	8	16.40	33.00
5	4924.00	53.2 PK	74.0	-20.8	2.16 V	139	47.20	6.00
6	4924.00	46.4 AV	54.0	-7.6	2.16 V	139	40.40	6.00
7	7386.00	57.5 PK	74.0	-16.5	2.30 V	197	44.30	13.20
8	7386.00	49.0 AV	54.0	-5.0	2.30 V	197	35.80	13.20

**Remarks:**

1. Emission Level(dBuV/m) = Raw Value(dBuV) + Correction Factor(dB/m)
2. Correction Factor(dB/m) = Antenna Factor(dB/m) + Cable Factor(dB)
3. The other emission levels were very low against the limit.
4. Margin value = Emission Level – Limit value
5. " \* ": Fundamental frequency.

**802.11g**

CHANNEL	TX Channel 1	DETECTOR FUNCTION	Peak (PK)
FREQUENCY RANGE	1GHz ~ 25GHz		Average (AV)

**ANTENNA POLARITY & TEST DISTANCE: HORIZONTAL AT 3 M**

NO.	FREQ. (MHz)	EMISSION LEVEL (dBuV/m)	LIMIT (dBuV/m)	MARGIN (dB)	ANTENNA HEIGHT (m)	TABLE ANGLE (Degree)	RAW VALUE (dBuV)	CORRECTION FACTOR (dB/m)
<b>1</b>	<b>2390.00</b>	<b>73.0 PK</b>	<b>74.0</b>	<b>-1.0</b>	<b>1.12 H</b>	<b>324</b>	<b>40.20</b>	<b>32.80</b>
2	2390.00	52.9 AV	54.0	-1.1	1.12 H	324	20.10	32.80
3	*2412.00	116.1 PK			1.37 H	331	83.20	32.90
4	*2412.00	106.4 AV			1.37 H	331	73.50	32.90
5	4824.00	46.4 PK	74.0	-27.6	1.20 H	141	40.50	5.90
6	4824.00	33.9 AV	54.0	-20.1	1.20 H	141	28.00	5.90

**ANTENNA POLARITY & TEST DISTANCE: VERTICAL AT 3 M**

NO.	FREQ. (MHz)	EMISSION LEVEL (dBuV/m)	LIMIT (dBuV/m)	MARGIN (dB)	ANTENNA HEIGHT (m)	TABLE ANGLE (Degree)	RAW VALUE (dBuV)	CORRECTION FACTOR (dB/m)
1	2390.00	71.9 PK	74.0	-2.1	1.58 V	6	39.10	32.80
2	2390.00	52.4 AV	54.0	-1.6	1.58 V	6	19.60	32.80
3	*2412.00	114.9 PK			1.89 V	346	82.00	32.90
4	*2412.00	105.4 AV			1.89 V	346	72.50	32.90
5	4824.00	43.9 PK	74.0	-30.1	1.64 V	194	38.00	5.90
6	4824.00	32.3 AV	54.0	-21.7	1.64 V	194	26.40	5.90

**Remarks:**

1. Emission Level(dBuV/m) = Raw Value(dBuV) + Correction Factor(dB/m)
2. Correction Factor(dB/m) = Antenna Factor(dB/m) + Cable Factor(dB)
3. The other emission levels were very low against the limit.
4. Margin value = Emission Level – Limit value
5. " \* ": Fundamental frequency.

CHANNEL	TX Channel 6	DETECTOR FUNCTION	Peak (PK)
FREQUENCY RANGE	1GHz ~ 25GHz		Average (AV)

**ANTENNA POLARITY & TEST DISTANCE: HORIZONTAL AT 3 M**

NO.	FREQ. (MHz)	EMISSION LEVEL (dBuV/m)	LIMIT (dBuV/m)	MARGIN (dB)	ANTENNA HEIGHT (m)	TABLE ANGLE (Degree)	RAW VALUE (dBuV)	CORRECTION FACTOR (dB/m)
1	*2437.00	119.1 PK			1.00 H	324	86.20	32.90
2	*2437.00	109.5 AV			1.00 H	324	76.60	32.90
3	2483.50	69.6 PK	74.0	-4.4	1.43 H	323	36.60	33.00
4	2483.50	52.7 AV	54.0	-1.3	1.43 H	323	19.70	33.00
5	4874.00	46.8 PK	74.0	-27.2	1.95 H	134	40.80	6.00
6	4874.00	34.0 AV	54.0	-20.0	1.95 H	134	28.00	6.00

**ANTENNA POLARITY & TEST DISTANCE: VERTICAL AT 3 M**

NO.	FREQ. (MHz)	EMISSION LEVEL (dBuV/m)	LIMIT (dBuV/m)	MARGIN (dB)	ANTENNA HEIGHT (m)	TABLE ANGLE (Degree)	RAW VALUE (dBuV)	CORRECTION FACTOR (dB/m)
1	*2437.00	118.8 PK			2.15 V	10	85.90	32.90
2	*2437.00	108.9 AV			2.15 V	10	76.00	32.90
3	2483.50	65.8 PK	74.0	-8.2	2.32 V	14	32.80	33.00
4	2483.50	51.5 AV	54.0	-2.5	2.32 V	14	18.50	33.00
5	4874.00	47.6 PK	74.0	-26.4	2.56 V	22	41.60	6.00
6	4874.00	35.2 AV	54.0	-18.8	2.56 V	22	29.20	6.00

**Remarks:**

1. Emission Level(dBuV/m) = Raw Value(dBuV) + Correction Factor(dB/m)
2. Correction Factor(dB/m) = Antenna Factor(dB/m) + Cable Factor(dB)
3. The other emission levels were very low against the limit.
4. Margin value = Emission Level – Limit value
5. " \* ": Fundamental frequency.

CHANNEL	TX Channel 11	DETECTOR FUNCTION	Peak (PK)
FREQUENCY RANGE	1GHz ~ 25GHz		Average (AV)

**ANTENNA POLARITY & TEST DISTANCE: HORIZONTAL AT 3 M**

NO.	FREQ. (MHz)	EMISSION LEVEL (dBuV/m)	LIMIT (dBuV/m)	MARGIN (dB)	ANTENNA HEIGHT (m)	TABLE ANGLE (Degree)	RAW VALUE (dBuV)	CORRECTION FACTOR (dB/m)
1	*2462.00	116.4 PK			1.02 H	306	83.50	32.90
2	*2462.00	105.8 AV			1.02 H	306	72.90	32.90
3	2483.50	72.1 PK	74.0	-1.9	1.00 H	311	39.10	33.00
4	2483.50	52.6 AV	54.0	-1.4	1.00 H	311	19.60	33.00
5	4924.00	45.7 PK	74.0	-28.3	1.38 H	215	39.70	6.00
6	4924.00	32.8 AV	54.0	-21.2	1.38 H	215	26.80	6.00

**ANTENNA POLARITY & TEST DISTANCE: VERTICAL AT 3 M**

NO.	FREQ. (MHz)	EMISSION LEVEL (dBuV/m)	LIMIT (dBuV/m)	MARGIN (dB)	ANTENNA HEIGHT (m)	TABLE ANGLE (Degree)	RAW VALUE (dBuV)	CORRECTION FACTOR (dB/m)
1	*2462.00	114.2 PK			1.98 V	11	81.30	32.90
2	*2462.00	104.6 AV			1.98 V	11	71.70	32.90
3	2483.50	66.8 PK	74.0	-7.2	2.88 V	18	33.80	33.00
4	2483.50	49.8 AV	54.0	-4.2	2.88 V	18	16.80	33.00
5	4924.00	47.2 PK	74.0	-26.8	2.17 V	88	41.20	6.00
6	4924.00	34.2 AV	54.0	-19.8	2.17 V	88	28.20	6.00

**Remarks:**

1. Emission Level(dBuV/m) = Raw Value(dBuV) + Correction Factor(dB/m)
2. Correction Factor(dB/m) = Antenna Factor(dB/m) + Cable Factor(dB)
3. The other emission levels were very low against the limit.
4. Margin value = Emission Level – Limit value
5. " \* ": Fundamental frequency.



**802.11n (20MHz)**

CHANNEL	TX Channel 1	DETECTOR FUNCTION	Peak (PK)
FREQUENCY RANGE	1GHz ~ 25GHz		Average (AV)

**ANTENNA POLARITY & TEST DISTANCE: HORIZONTAL AT 3 M**

NO.	FREQ. (MHz)	EMISSION LEVEL (dBuV/m)	LIMIT (dBuV/m)	MARGIN (dB)	ANTENNA HEIGHT (m)	TABLE ANGLE (Degree)	RAW VALUE (dBuV)	CORRECTION FACTOR (dB/m)
1	2390.00	70.2 PK	74.0	-3.8	1.00 H	327	37.40	32.80
2	2390.00	52.9 AV	54.0	-1.1	1.00 H	327	20.10	32.80
3	*2412.00	115.2 PK			1.97 H	316	82.30	32.90
4	*2412.00	105.2 AV			1.97 H	316	72.30	32.90
5	4824.00	45.3 PK	74.0	-28.7	1.69 H	211	39.40	5.90
6	4824.00	32.5 AV	54.0	-21.5	1.69 H	211	26.60	5.90

**ANTENNA POLARITY & TEST DISTANCE: VERTICAL AT 3 M**

NO.	FREQ. (MHz)	EMISSION LEVEL (dBuV/m)	LIMIT (dBuV/m)	MARGIN (dB)	ANTENNA HEIGHT (m)	TABLE ANGLE (Degree)	RAW VALUE (dBuV)	CORRECTION FACTOR (dB/m)
1	2390.00	70.8 PK	74.0	-3.2	1.08 V	326	38.00	32.80
2	2390.00	50.7 AV	54.0	-3.3	1.08 V	326	17.90	32.80
3	*2412.00	115.2 PK			2.29 V	18	82.30	32.90
4	*2412.00	105.0 AV			2.29 V	18	72.10	32.90
5	4824.00	45.8 PK	74.0	-28.2	1.37 V	215	39.90	5.90
6	4824.00	32.5 AV	54.0	-21.5	1.37 V	215	26.60	5.90

**Remarks:**

1. Emission Level(dBuV/m) = Raw Value(dBuV) + Correction Factor(dB/m)
2. Correction Factor(dB/m) = Antenna Factor(dB/m) + Cable Factor(dB)
3. The other emission levels were very low against the limit.
4. Margin value = Emission Level – Limit value
5. " \* ": Fundamental frequency.

CHANNEL	TX Channel 6	DETECTOR FUNCTION	Peak (PK)
FREQUENCY RANGE	1GHz ~ 25GHz		Average (AV)

**ANTENNA POLARITY & TEST DISTANCE: HORIZONTAL AT 3 M**

NO.	FREQ. (MHz)	EMISSION LEVEL (dBuV/m)	LIMIT (dBuV/m)	MARGIN (dB)	ANTENNA HEIGHT (m)	TABLE ANGLE (Degree)	RAW VALUE (dBuV)	CORRECTION FACTOR (dB/m)
1	*2437.00	118.6 PK			1.76 H	319	85.70	32.90
2	*2437.00	108.9 AV			1.76 H	319	76.00	32.90
3	2483.50	71.2 PK	74.0	-2.8	1.94 H	304	38.20	33.00
4	2483.50	52.9 AV	54.0	-1.1	1.94 H	304	19.90	33.00
5	4874.00	49.1 PK	74.0	-24.9	1.36 H	171	43.10	6.00
6	4874.00	35.5 AV	54.0	-18.5	1.36 H	171	29.50	6.00

**ANTENNA POLARITY & TEST DISTANCE: VERTICAL AT 3 M**

NO.	FREQ. (MHz)	EMISSION LEVEL (dBuV/m)	LIMIT (dBuV/m)	MARGIN (dB)	ANTENNA HEIGHT (m)	TABLE ANGLE (Degree)	RAW VALUE (dBuV)	CORRECTION FACTOR (dB/m)
1	*2437.00	118.8 PK			1.79 V	7	85.90	32.90
2	*2437.00	109.2 AV			1.79 V	7	76.30	32.90
3	2483.50	67.9 PK	74.0	-6.1	1.88 V	5	34.90	33.00
4	2483.50	51.5 AV	54.0	-2.5	1.88 V	5	18.50	33.00
5	4874.00	49.6 PK	74.0	-24.4	1.76 V	141	43.60	6.00
6	4874.00	35.2 AV	54.0	-18.8	1.76 V	141	29.20	6.00

**Remarks:**

1. Emission Level(dBuV/m) = Raw Value(dBuV) + Correction Factor(dB/m)
2. Correction Factor(dB/m) = Antenna Factor(dB/m) + Cable Factor(dB)
3. The other emission levels were very low against the limit.
4. Margin value = Emission Level – Limit value
5. " \* ": Fundamental frequency.

CHANNEL	TX Channel 11	DETECTOR FUNCTION	Peak (PK)
FREQUENCY RANGE	1GHz ~ 25GHz		Average (AV)

ANTENNA POLARITY & TEST DISTANCE: HORIZONTAL AT 3 M								
NO.	FREQ. (MHz)	EMISSION LEVEL (dBuV/m)	LIMIT (dBuV/m)	MARGIN (dB)	ANTENNA HEIGHT (m)	TABLE ANGLE (Degree)	RAW VALUE (dBuV)	CORRECTION FACTOR (dB/m)
1	*2462.00	115.0 PK			1.31 H	303	82.10	32.90
2	*2462.00	105.2 AV			1.31 H	303	72.30	32.90
3	2483.50	71.8 PK	74.0	-2.2	1.00 H	304	38.80	33.00
4	2483.50	52.9 AV	54.0	-1.1	1.00 H	304	19.90	33.00
5	4924.00	45.7 PK	74.0	-28.3	1.69 H	61	39.70	6.00
6	4924.00	33.3 AV	54.0	-20.7	1.69 H	61	27.30	6.00

ANTENNA POLARITY & TEST DISTANCE: VERTICAL AT 3 M								
NO.	FREQ. (MHz)	EMISSION LEVEL (dBuV/m)	LIMIT (dBuV/m)	MARGIN (dB)	ANTENNA HEIGHT (m)	TABLE ANGLE (Degree)	RAW VALUE (dBuV)	CORRECTION FACTOR (dB/m)
1	*2462.00	111.8 PK			1.26 V	347	78.90	32.90
2	*2462.00	102.3 AV			1.26 V	347	69.40	32.90
3	2483.50	69.9 PK	74.0	-4.1	1.83 V	11	36.90	33.00
4	2483.50	51.3 AV	54.0	-2.7	1.83 V	11	18.30	33.00
5	4924.00	45.5 PK	74.0	-28.5	1.62 V	109	39.50	6.00
6	4924.00	32.7 AV	54.0	-21.3	1.62 V	109	26.70	6.00

**Remarks:**

1. Emission Level(dBuV/m) = Raw Value(dBuV) + Correction Factor(dB/m)
2. Correction Factor(dB/m) = Antenna Factor(dB/m) + Cable Factor(dB)
3. The other emission levels were very low against the limit.
4. Margin value = Emission Level – Limit value
5. " \* ": Fundamental frequency.

**802.11n (40MHz)**

CHANNEL	TX Channel 3	DETECTOR FUNCTION	Peak (PK)
FREQUENCY RANGE	1GHz ~ 25GHz		Average (AV)

**ANTENNA POLARITY & TEST DISTANCE: HORIZONTAL AT 3 M**

NO.	FREQ. (MHz)	EMISSION LEVEL (dBuV/m)	LIMIT (dBuV/m)	MARGIN (dB)	ANTENNA HEIGHT (m)	TABLE ANGLE (Degree)	RAW VALUE (dBuV)	CORRECTION FACTOR (dB/m)
1	2390.00	67.7 PK	74.0	-6.3	1.00 H	306	34.90	32.80
2	2390.00	52.3 AV	54.0	-1.7	1.00 H	306	19.50	32.80
3	*2422.00	109.6 PK			1.00 H	315	76.70	32.90
4	*2422.00	100.8 AV			1.00 H	315	67.90	32.90
5	4844.00	44.7 PK	74.0	-29.3	1.32 H	202	38.90	5.80
6	4844.00	33.0 AV	54.0	-21.0	1.32 H	202	27.20	5.80

**ANTENNA POLARITY & TEST DISTANCE: VERTICAL AT 3 M**

NO.	FREQ. (MHz)	EMISSION LEVEL (dBuV/m)	LIMIT (dBuV/m)	MARGIN (dB)	ANTENNA HEIGHT (m)	TABLE ANGLE (Degree)	RAW VALUE (dBuV)	CORRECTION FACTOR (dB/m)
1	2390.00	68.4 PK	74.0	-5.6	2.02 V	7	35.60	32.80
2	2390.00	51.6 AV	54.0	-2.4	2.02 V	7	18.80	32.80
3	*2422.00	107.2 PK			1.58 V	347	74.30	32.90
4	*2422.00	97.9 AV			1.58 V	347	65.00	32.90
5	4844.00	44.6 PK	74.0	-29.4	1.41 V	288	38.80	5.80
6	4844.00	33.0 AV	54.0	-21.0	1.41 V	288	27.20	5.80

**Remarks:**

1. Emission Level(dBuV/m) = Raw Value(dBuV) + Correction Factor(dB/m)
2. Correction Factor(dB/m) = Antenna Factor(dB/m) + Cable Factor(dB)
3. The other emission levels were very low against the limit.
4. Margin value = Emission Level – Limit value
5. " \* ": Fundamental frequency.

CHANNEL	TX Channel 6	DETECTOR FUNCTION	Peak (PK)
FREQUENCY RANGE	1GHz ~ 25GHz		Average (AV)

**ANTENNA POLARITY & TEST DISTANCE: HORIZONTAL AT 3 M**

NO.	FREQ. (MHz)	EMISSION LEVEL (dBuV/m)	LIMIT (dBuV/m)	MARGIN (dB)	ANTENNA HEIGHT (m)	TABLE ANGLE (Degree)	RAW VALUE (dBuV)	CORRECTION FACTOR (dB/m)
1	*2437.00	110.4 PK			1.00 H	317	77.50	32.90
2	*2437.00	101.4 AV			1.00 H	317	68.50	32.90
3	2483.50	68.9 PK	74.0	-5.1	1.90 H	313	35.90	33.00
4	2483.50	52.5 AV	54.0	-1.5	1.90 H	313	19.50	33.00
5	4874.00	45.2 PK	74.0	-28.8	1.27 H	218	39.20	6.00
6	4874.00	33.6 AV	54.0	-20.4	1.27 H	218	27.60	6.00

**ANTENNA POLARITY & TEST DISTANCE: VERTICAL AT 3 M**

NO.	FREQ. (MHz)	EMISSION LEVEL (dBuV/m)	LIMIT (dBuV/m)	MARGIN (dB)	ANTENNA HEIGHT (m)	TABLE ANGLE (Degree)	RAW VALUE (dBuV)	CORRECTION FACTOR (dB/m)
1	*2437.00	109.8 PK			1.95 V	12	76.90	32.90
2	*2437.00	101.2 AV			1.95 V	12	68.30	32.90
3	2483.50	66.7 PK	74.0	-7.3	1.78 V	8	33.70	33.00
4	2483.50	50.3 AV	54.0	-3.7	1.78 V	8	17.30	33.00
5	4874.00	44.9 PK	74.0	-29.1	1.61 V	63	38.90	6.00
6	4874.00	32.9 AV	54.0	-21.1	1.61 V	63	26.90	6.00

**Remarks:**

1. Emission Level(dBuV/m) = Raw Value(dBuV) + Correction Factor(dB/m)
2. Correction Factor(dB/m) = Antenna Factor(dB/m) + Cable Factor(dB)
3. The other emission levels were very low against the limit.
4. Margin value = Emission Level – Limit value
5. " \* ": Fundamental frequency.

CHANNEL	TX Channel 9	DETECTOR FUNCTION	Peak (PK)
FREQUENCY RANGE	1GHz ~ 25GHz		Average (AV)

**ANTENNA POLARITY & TEST DISTANCE: HORIZONTAL AT 3 M**

NO.	FREQ. (MHz)	EMISSION LEVEL (dBuV/m)	LIMIT (dBuV/m)	MARGIN (dB)	ANTENNA HEIGHT (m)	TABLE ANGLE (Degree)	RAW VALUE (dBuV)	CORRECTION FACTOR (dB/m)
1	*2452.00	106.9 PK			1.75 H	312	73.90	33.00
2	*2452.00	97.4 AV			1.75 H	312	64.40	33.00
3	2483.50	69.2 PK	74.0	-4.8	1.14 H	311	36.20	33.00
4	2483.50	52.3 AV	54.0	-1.7	1.14 H	311	19.30	33.00
5	4904.00	45.6 PK	74.0	-28.4	1.54 H	252	39.70	5.90
6	4904.00	33.8 AV	54.0	-20.2	1.54 H	252	27.90	5.90

**ANTENNA POLARITY & TEST DISTANCE: VERTICAL AT 3 M**

NO.	FREQ. (MHz)	EMISSION LEVEL (dBuV/m)	LIMIT (dBuV/m)	MARGIN (dB)	ANTENNA HEIGHT (m)	TABLE ANGLE (Degree)	RAW VALUE (dBuV)	CORRECTION FACTOR (dB/m)
1	*2452.00	107.0 PK			1.72 V	16	74.00	33.00
2	*2452.00	98.1 AV			1.72 V	16	65.10	33.00
3	2483.50	67.5 PK	74.0	-6.5	1.78 V	8	34.50	33.00
4	2483.50	50.7 AV	54.0	-3.3	1.78 V	8	17.70	33.00
5	4904.00	46.0 PK	74.0	-28.0	1.66 V	238	40.10	5.90
6	4904.00	34.1 AV	54.0	-19.9	1.66 V	238	28.20	5.90

**Remarks:**

1. Emission Level(dBuV/m) = Raw Value(dBuV) + Correction Factor(dB/m)
2. Correction Factor(dB/m) = Antenna Factor(dB/m) + Cable Factor(dB)
3. The other emission levels were very low against the limit.
4. Margin value = Emission Level – Limit value
5. " \* ": Fundamental frequency.

Below 1GHz worst-case data: 802.11g

CHANNEL	TX Channel 6	DETECTOR FUNCTION	Quasi-Peak (QP)
FREQUENCY RANGE	30MHz ~ 1GHz		
TEST MODE	A		

**ANTENNA POLARITY & TEST DISTANCE: HORIZONTAL AT 3 M**

NO.	FREQ. (MHz)	EMISSION LEVEL (dBuV/m)	LIMIT (dBuV/m)	MARGIN (dB)	ANTENNA HEIGHT (m)	TABLE ANGLE (Degree)	RAW VALUE (dBuV)	CORRECTION FACTOR (dB/m)
1	97.95	32.9 QP	43.5	-10.6	1.25 H	149	51.90	-19.00
2	148.50	36.2 QP	43.5	-7.3	1.00 H	277	50.10	-13.90
3	391.54	38.6 QP	46.0	-7.4	1.50 H	277	49.10	-10.50
4	718.18	38.0 QP	46.0	-8.0	1.00 H	340	42.00	-4.00
5	762.90	38.1 QP	46.0	-7.9	1.50 H	163	40.80	-2.70
6	900.94	38.8 QP	46.0	-7.2	1.50 H	240	39.20	-0.40

**ANTENNA POLARITY & TEST DISTANCE: VERTICAL AT 3 M**

NO.	FREQ. (MHz)	EMISSION LEVEL (dBuV/m)	LIMIT (dBuV/m)	MARGIN (dB)	ANTENNA HEIGHT (m)	TABLE ANGLE (Degree)	RAW VALUE (dBuV)	CORRECTION FACTOR (dB/m)
1	146.56	33.9 QP	43.5	-9.6	1.00 V	349	47.90	-14.00
2	385.70	41.5 QP	46.0	-4.5	1.49 V	295	52.00	-10.50
3	572.36	34.3 QP	46.0	-11.7	1.25 V	312	41.40	-7.10
4	663.74	37.8 QP	46.0	-8.2	1.49 V	149	42.90	-5.10
5	708.46	43.1 QP	46.0	-2.9	1.25 V	159	47.40	-4.30
6	745.40	41.5 QP	46.0	-4.5	1.50 V	328	44.90	-3.40

Remarks:

1. Emission Level(dBuV/m) = Raw Value(dBuV) + Correction Factor(dB/m)
2. Correction Factor(dB/m) = Antenna Factor(dB/m) + Cable Factor(dB)
3. The other emission levels were very low against the limit.
4. Margin value = Emission Level – Limit value

CHANNEL	TX Channel 6	DETECTOR FUNCTION	Quasi-Peak (QP)
FREQUENCY RANGE	30MHz ~ 1GHz		
TEST MODE	B		

**ANTENNA POLARITY & TEST DISTANCE: HORIZONTAL AT 3 M**

NO.	FREQ. (MHz)	EMISSION LEVEL (dBuV/m)	LIMIT (dBuV/m)	MARGIN (dB)	ANTENNA HEIGHT (m)	TABLE ANGLE (Degree)	RAW VALUE (dBuV)	CORRECTION FACTOR (dB/m)
1	57.12	29.2 QP	40.0	-10.8	1.50 H	16	43.80	-14.60
2	249.60	28.9 QP	46.0	-17.1	1.00 H	239	43.10	-14.20
3	374.04	30.4 QP	46.0	-15.6	1.00 H	162	41.10	-10.70
4	624.85	31.7 QP	46.0	-14.3	1.50 H	210	37.20	-5.50
5	751.23	32.2 QP	46.0	-13.8	1.00 H	11	35.20	-3.00
6	902.89	41.0 QP	46.0	-5.0	2.00 H	182	41.40	-0.40

**ANTENNA POLARITY & TEST DISTANCE: VERTICAL AT 3 M**

NO.	FREQ. (MHz)	EMISSION LEVEL (dBuV/m)	LIMIT (dBuV/m)	MARGIN (dB)	ANTENNA HEIGHT (m)	TABLE ANGLE (Degree)	RAW VALUE (dBuV)	CORRECTION FACTOR (dB/m)
1	57.12	29.4 QP	40.0	-10.6	1.50 V	288	44.00	-14.60
2	150.45	27.8 QP	43.5	-15.7	1.00 V	267	41.60	-13.80
3	374.04	27.5 QP	46.0	-18.5	1.25 V	47	38.20	-10.70
4	500.42	27.0 QP	46.0	-19.0	1.25 V	5	35.30	-8.30
5	624.85	30.1 QP	46.0	-15.9	1.99 V	96	35.60	-5.50
6	760.95	29.1 QP	46.0	-16.9	1.25 V	109	31.80	-2.70

**Remarks:**

1. Emission Level(dBuV/m) = Raw Value(dBuV) + Correction Factor(dB/m)
2. Correction Factor(dB/m) = Antenna Factor(dB/m) + Cable Factor(dB)
3. The other emission levels were very low against the limit.
4. Margin value = Emission Level – Limit value



## 4.2 Conducted Emission Measurement

### 4.2.1 Limits of Conducted Emission Measurement

Frequency (MHz)	Conducted Limit (dBuV)	
	Quasi-peak	Average
0.15 - 0.5	66 - 56	56 - 46
0.50 - 5.0	56	46
5.0 - 30.0	60	50

- Note:** 1. The lower limit shall apply at the transition frequencies.  
 2. The limit decreases in line with the logarithm of the frequency in the range of 0.15 to 0.50MHz.

### 4.2.2 Test Instruments

Description & Manufacturer	Model No.	Serial No.	Cal. Date	Cal. Due
Test Receiver ROHDE & SCHWARZ	ESCS 30	100288	Apr. 27, 2015	Apr. 26, 2016
RF signal cable (with 10dB PAD) Woken	5D-FB	Cable-cond2-01	Dec. 26, 2015	Dec. 25, 2016
LISN ROHDE & SCHWARZ (EUT)	ESH2-Z5	100100	Jan. 11, 2016	Jan. 10, 2017
LISN ROHDE & SCHWARZ (Peripheral)	ESH3-Z5	100312	Jul. 21, 2015	Jul. 20, 2016
Software ADT	BV ADT_Cond_ V7.3.7.3	NA	NA	NA

- Note:** 1. The calibration interval of the above test instruments is 12 months and the calibrations are traceable to NML/ROC and NIST/USA.  
 2. The test was performed in HwaYa Shielded Room 2.  
 3. The VCCI Site Registration No. is C-2047.

### 4.2.3 Test Procedures

- The EUT was placed 0.4 meters from the conducting wall of the shielded room with EUT being connected to the power mains through a line impedance stabilization network (LISN). Other support units were connected to the power mains through another LISN. The two LISNs provide 50 ohm/ 50uH of coupling impedance for the measuring instrument.
- Both lines of the power mains connected to the EUT were checked for maximum conducted interference.
- The frequency range from 150kHz to 30MHz was searched. Emission levels under (Limit - 20dB) was not recorded.

Note: The resolution bandwidth and video bandwidth of test receiver is 9kHz for quasi-peak detection (QP) and average detection (AV) at frequency 0.15MHz-30MHz.

### 4.2.4 Deviation from Test Standard

No deviation.

### 4.2.5 Test Setup

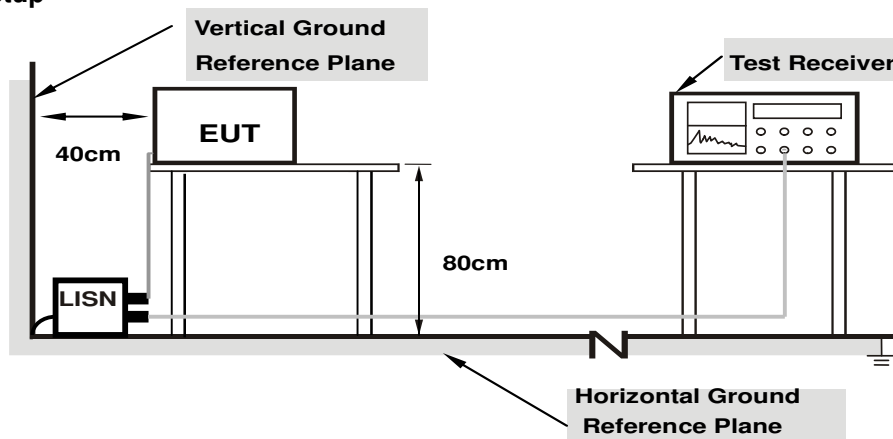

**Note: 1.Support units were connected to second LISN.**

For the actual test configuration, please refer to the attached file (Test Setup Photo).

### 4.2.6 EUT Operating Conditions

Same as 4.1.6.

### 4.2.7 Test Results

Worst-Case Data: 802.11g

Phase	Line (L)	Detector Function	Quasi-Peak (QP) / Average (AV)
Test Mode	A		

No	Freq. [MHz]	Corr. Factor (dB)	Reading Value		Emission Level		Limit		Margin	
			[dB (uV)]		[dB (uV)]		[dB (uV)]		(dB)	
			Q.P.	AV.	Q.P.	AV.	Q.P.	AV.	Q.P.	AV.
1	0.16562	0.22	51.27	33.63	51.49	33.85	65.18	55.18	-13.68	-21.32
2	0.52109	0.24	40.55	33.60	40.79	33.84	56.00	46.00	-15.21	-12.16
3	1.03906	0.30	33.05	26.87	33.35	27.17	56.00	46.00	-22.65	-18.83
4	1.88672	0.36	32.22	26.91	32.58	27.27	56.00	46.00	-23.42	-18.73
5	4.01172	0.44	31.38	25.24	31.82	25.68	56.00	46.00	-24.18	-20.32
6	10.25000	0.51	29.98	23.84	30.49	24.35	60.00	50.00	-29.51	-25.65

Remarks:

1. Q.P. and AV. are abbreviations of quasi-peak and average individually.
2. The emission levels of other frequencies were very low against the limit.
3. Margin value = Emission level - Limit value
4. Correction factor = Insertion loss + Cable loss
5. Emission Level = Correction Factor + Reading Value.

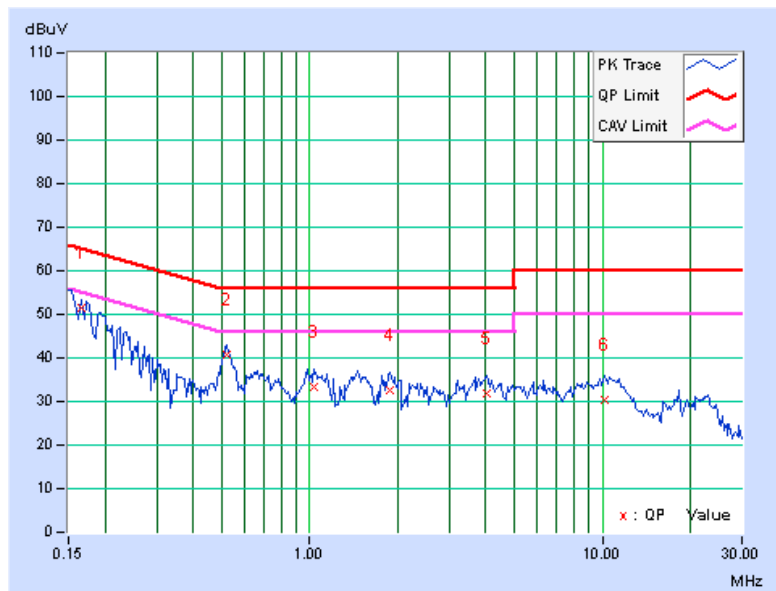

Phase	Neutral (N)	Detector Function	Quasi-Peak (QP) / Average (AV)
Test Mode	A		

No	Freq. [MHz]	Corr. Factor (dB)	Reading Value [dB (uV)]		Emission Level [dB (uV)]		Limit [dB (uV)]		Margin (dB)	
			Q.P.	AV.	Q.P.	AV.	Q.P.	AV.	Q.P.	AV.
			1	0.16562	0.23	51.21	34.02	51.44	34.25	65.18
2	0.52500	0.30	39.75	32.26	40.05	32.56	56.00	46.00	-15.95	-13.44
3	1.10547	0.30	32.33	26.22	32.63	26.52	56.00	46.00	-23.37	-19.48
4	1.95313	0.39	32.91	25.85	33.30	26.24	56.00	46.00	-22.70	-19.76
5	3.60156	0.47	33.64	27.55	34.11	28.02	56.00	46.00	-21.89	-17.98
6	10.52734	0.59	35.86	31.21	36.45	31.80	60.00	50.00	-23.55	-18.20

Remarks:

1. Q.P. and AV. are abbreviations of quasi-peak and average individually.
2. The emission levels of other frequencies were very low against the limit.
3. Margin value = Emission level - Limit value
4. Correction factor = Insertion loss + Cable loss
5. Emission Level = Correction Factor + Reading Value.

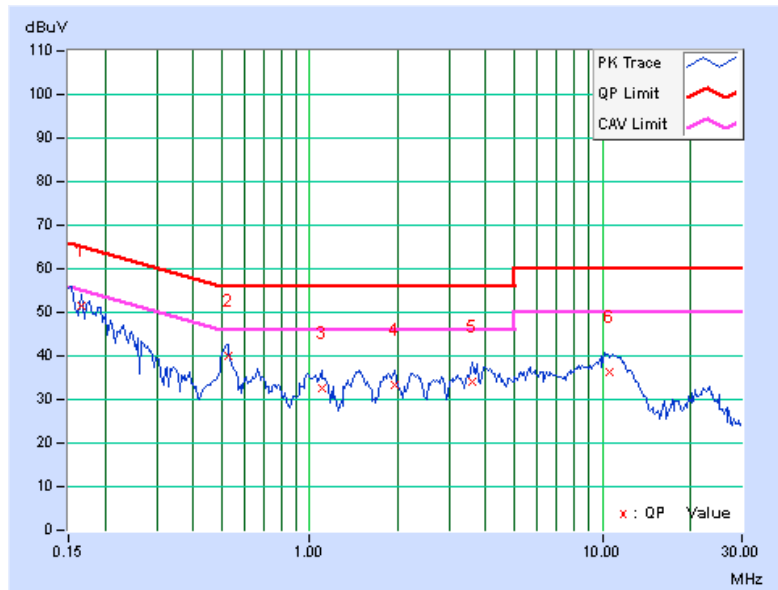

Phase	Line (L)	Detector Function	Quasi-Peak (QP) / Average (AV)
Test Mode	B		

No	Freq. [MHz]	Corr. Factor (dB)	Reading Value [dB (uV)]		Emission Level [dB (uV)]		Limit [dB (uV)]		Margin (dB)	
			Q.P.	AV.	Q.P.	AV.	Q.P.	AV.	Q.P.	AV.
			1	0.15781	0.22	56.97	48.84	57.19	49.06	65.58
<b>2</b>	<b>0.47422</b>	<b>0.23</b>	<b>50.63</b>	<b>44.20</b>	<b>50.86</b>	<b>44.43</b>	<b>56.44</b>	<b>46.44</b>	<b>-5.58</b>	<b>-2.01</b>
3	2.19531	0.38	41.94	37.59	42.32	37.97	56.00	46.00	-13.68	-8.03
4	4.24609	0.44	42.14	36.35	42.58	36.79	56.00	46.00	-13.42	-9.21
5	11.74609	0.54	40.43	36.00	40.97	36.54	60.00	50.00	-19.03	-13.46
6	22.13281	0.67	43.30	38.74	43.97	39.41	60.00	50.00	-16.03	-10.59

Remarks:

1. Q.P. and AV. are abbreviations of quasi-peak and average individually.
2. The emission levels of other frequencies were very low against the limit.
3. Margin value = Emission level - Limit value
4. Correction factor = Insertion loss + Cable loss
5. Emission Level = Correction Factor + Reading Value.

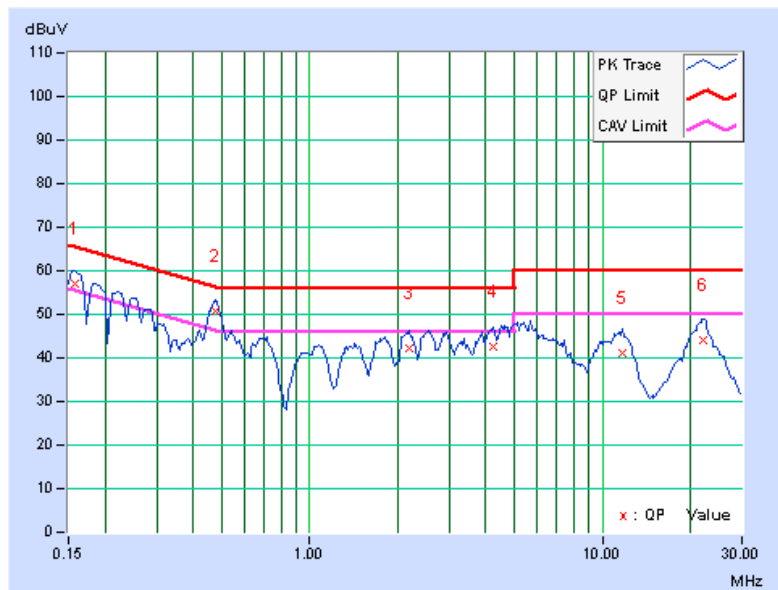

Phase	Neutral (N)	Detector Function	Quasi-Peak (QP) / Average (AV)
Test Mode	B		

No	Freq. [MHz]	Corr. Factor (dB)	Reading Value [dB (uV)]		Emission Level [dB (uV)]		Limit [dB (uV)]		Margin (dB)	
			Q.P.	AV.	Q.P.	AV.	Q.P.	AV.	Q.P.	AV.
			1	0.16172	0.23	56.27	47.87	56.50	48.10	65.38
2	0.46641	0.30	51.23	43.70	51.53	44.00	56.58	46.58	-5.05	-2.58
3	0.95469	0.29	42.72	37.85	43.01	38.14	56.00	46.00	-12.99	-7.86
4	2.95313	0.44	41.29	37.18	41.73	37.62	56.00	46.00	-14.27	-8.38
5	11.35156	0.60	36.23	31.11	36.83	31.71	60.00	50.00	-23.17	-18.29
6	22.03906	0.77	37.74	33.30	38.51	34.07	60.00	50.00	-21.49	-15.93

Remarks:

1. Q.P. and AV. are abbreviations of quasi-peak and average individually.
2. The emission levels of other frequencies were very low against the limit.
3. Margin value = Emission level - Limit value
4. Correction factor = Insertion loss + Cable loss
5. Emission Level = Correction Factor + Reading Value.

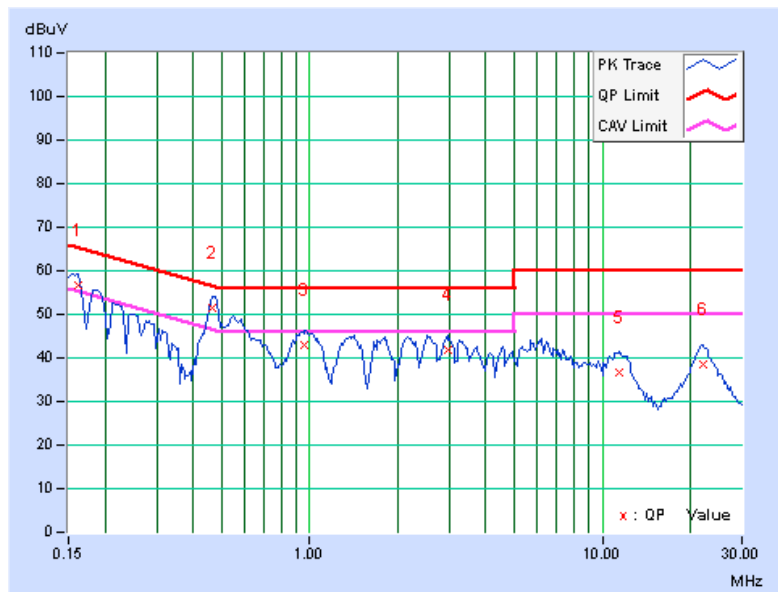

### 4.3 6dB Bandwidth Measurement

#### 4.3.1 Limits of 6dB Bandwidth Measurement

The minimum of 6dB Bandwidth Measurement is 0.5 MHz.

#### 4.3.2 Test Setup

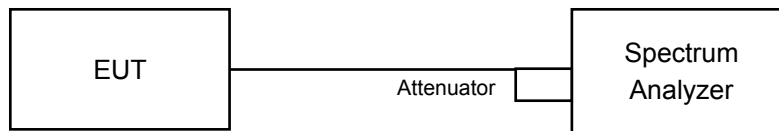

#### 4.3.3 Test Instruments

Refer to section 4.1.2 to get information of above instrument.

#### 4.3.4 Test Procedure

- Set resolution bandwidth (RBW) = 100kHz
- Set the video bandwidth (VBW)  $\geq 3 \times$  RBW, Detector = average.
- Trace mode = max hold.
- Sweep = auto couple.
- Measure the maximum width of the emission that is constrained by the frequencies associated with the two amplitude points (upper and lower) that are attenuated by 6 dB relative to the maximum level measured in the fundamental emission

#### 4.3.5 Deviation from Test Standard

No deviation.

#### 4.3.6 EUT Operating Conditions

The software provided by client to enable the EUT under transmission condition continuously at lowest, middle and highest channel frequencies individually.

### 4.3.7 Test Result

#### 802.11b

Channel	Frequency (MHz)	6dB Bandwidth (MHz)			Minimum Limit (MHz)	Pass / Fail
		Chain 0	Chain 1	Chain 2		
1	2412	7.59	7.12	7.09	0.5	Pass
6	2437	7.09	7.10	7.07	0.5	Pass
11	2462	7.11	7.09	7.01	0.5	Pass

#### 802.11g

Channel	Frequency (MHz)	6dB Bandwidth (MHz)			Minimum Limit (MHz)	Pass / Fail
		Chain 0	Chain 1	Chain 2		
1	2412	16.46	16.49	16.42	0.5	Pass
6	2437	16.39	16.37	16.41	0.5	Pass
11	2462	16.39	16.40	16.41	0.5	Pass

#### 802.11n (20MHz)

Channel	Frequency (MHz)	6dB Bandwidth (MHz)			Minimum Limit (MHz)	Pass / Fail
		Chain 0	Chain 1	Chain 2		
1	2412	17.66	17.73	17.68	0.5	Pass
6	2437	17.60	17.36	17.60	0.5	Pass
11	2462	17.61	17.63	17.61	0.5	Pass

#### 802.11n (40MHz)

Channel	Frequency (MHz)	6dB Bandwidth (MHz)			Minimum Limit (MHz)	Pass / Fail
		Chain 0	Chain 1	Chain 2		
3	2422	36.14	36.10	36.19	0.5	Pass
6	2437	36.13	36.44	36.41	0.5	Pass
9	2452	35.80	36.41	36.33	0.5	Pass



### Spectrum Plot of Worst Value

#### 802.11b

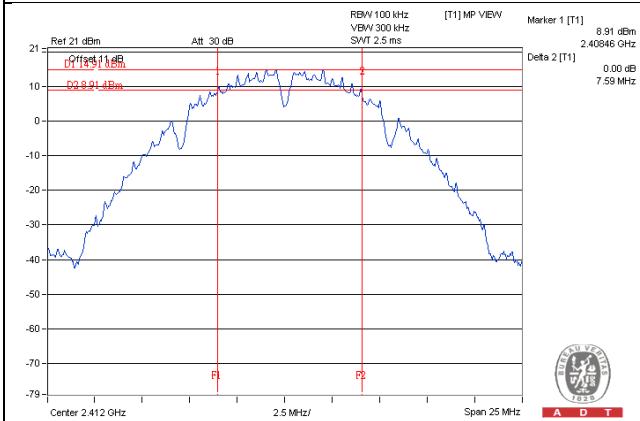

#### 802.11g

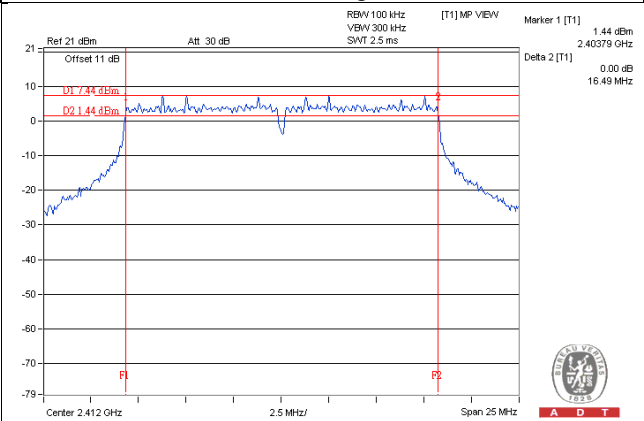

#### 802.11n (20MHz)

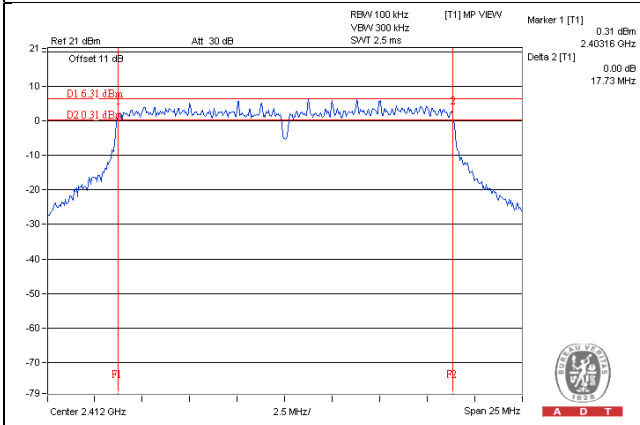

#### 802.11n (40MHz)

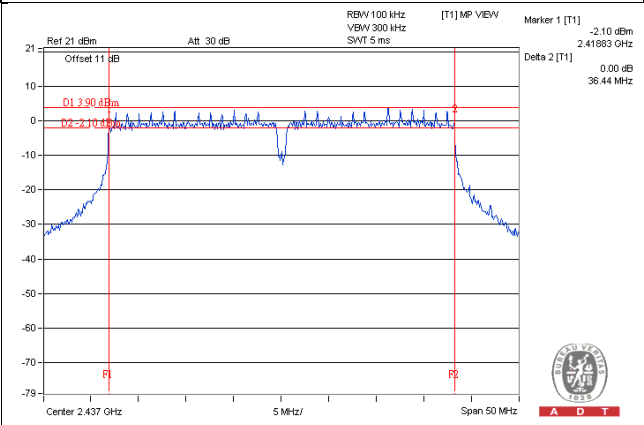

## 4.4 Conducted Output Power Measurement

### 4.4.1 Limits of Conducted Output Power Measurement

For systems using digital modulation in the 2400–2483.5 MHz bands: 1 Watt (30dBm)

Per KDB 662911 D01 Multiple Transmitter Output Method of conducted output power measurement on IEEE 802.11 devices,

Array Gain = 0 dB (i.e., no array gain) for  $NANT \leq 4$ ;

Array Gain = 0 dB (i.e., no array gain) for channel widths  $\geq 40$  MHz for any NANT;

Array Gain =  $5 \log(NANT/NSS)$  dB or 3 dB, whichever is less for 20-MHz channel widths with  $NANT \geq 5$ .

For power measurements on all other devices: Array Gain =  $10 \log(NANT/NSS)$  dB.

### 4.4.2 Test Setup

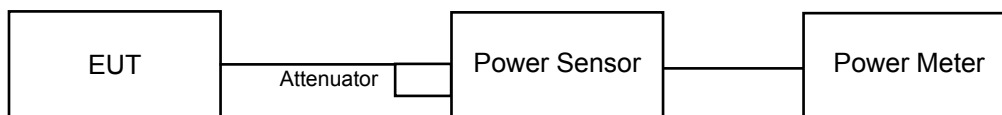

### 4.4.3 Test Instruments

Refer to section 4.1.2 to get information of above instrument.

### 4.4.4 Test Procedures

An average power sensor was used on the output port of the EUT. A power meter was used to read the response of the average power sensor. Record the power level.

### 4.4.5 Deviation from Test Standard

No deviation.

### 4.4.6 EUT Operating Conditions

Same as Item 4.3.6.

#### 4.4.7 Test Results

##### 802.11b

Channel	Frequency (MHz)	Average Power (dBm)			Total Power (mW)	Total Power (dBm)	Limit (dBm)	Pass / Fail
		Chain 0	Chain 1	Chain 2				
1	2412	23.57	22.93	23.44	644.646	28.09	30	Pass
6	2437	23.81	24.37	23.52	738.868	28.69	30	Pass
11	2462	23.04	24.76	23.79	<b>739.930</b>	28.69	30	Pass

##### 802.11g

Channel	Frequency (MHz)	Average Power (dBm)			Total Power (mW)	Total Power (dBm)	Limit (dBm)	Pass / Fail
		Chain 0	Chain 1	Chain 2				
1	2412	18.80	19.33	18.90	239.187	23.79	30	Pass
6	2437	23.29	23.60	23.17	649.882	28.13	30	Pass
11	2462	16.65	16.88	16.72	141.980	21.52	30	Pass

##### 802.11n (20MHz)

Channel	Frequency (MHz)	Average Power (dBm)			Total Power (mW)	Total Power (dBm)	Limit (dBm)	Pass / Fail
		Chain 0	Chain 1	Chain 2				
1	2412	17.64	18.18	17.94	186.072	22.70	30	Pass
6	2437	23.19	23.51	22.91	628.271	27.98	30	Pass
11	2462	16.71	17.12	16.70	145.178	21.62	30	Pass

##### 802.11n (40MHz)

Channel	Frequency (MHz)	Average Power (dBm)			Total Power (mW)	Total Power (dBm)	Limit (dBm)	Pass / Fail
		Chain 0	Chain 1	Chain 2				
3	2422	14.51	15.07	14.26	87.055	19.40	30	Pass
6	2437	17.06	17.08	16.90	150.844	21.79	30	Pass
9	2452	13.94	14.14	13.66	73.943	18.69	30	Pass

## 4.5 Power Spectral Density Measurement

### 4.5.1 Limits of Power Spectral Density Measurement

The Maximum of Power Spectral Density Measurement is 8dBm.

### 4.5.2 Test Setup

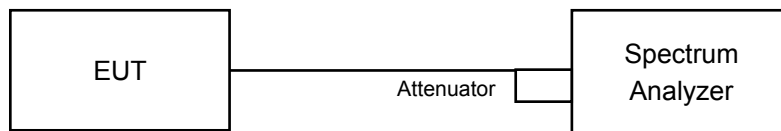

### 4.5.3 Test Instruments

Refer to section 4.1.2 to get information of above instrument.

### 4.5.4 Test Procedure

For duty cycle  $\geq 98\%$

- Set instrument center frequency to DTS channel center frequency.
- Set span to at least 1.5 times the OBW.
- Set RBW to:  $3 \text{ kHz} \leq \text{RBW} \leq 100 \text{ kHz}$ .
- Set VBW  $\geq 3 \times \text{RBW}$ .
- Detector = power averaging (RMS) or sample detector (when RMS not available).
- Ensure that the number of measurement points in the sweep  $\geq 2 \times \text{span}/\text{RBW}$ .
- Sweep time = auto couple.
- Employ trace averaging (RMS) mode over a minimum of 100 traces.
- Use the peak marker function to determine the maximum amplitude level.

For duty cycle  $< 98\%$

- Measure the duty cycle (x).
- Set instrument center frequency to DTS channel center frequency.
- Set span to at least 1.5 times the OBW.
- Set RBW to:  $3 \text{ kHz} \leq \text{RBW} \leq 100 \text{ kHz}$ .
- Set VBW  $\geq 3 \times \text{RBW}$ .
- Detector = power averaging (RMS) or sample detector (when RMS not available).
- Ensure that the number of measurement points in the sweep  $\geq 2 \times \text{span}/\text{RBW}$ .
- Sweep time = auto couple.
- Do not use sweep triggering. Allow sweep to "free run".
- Employ trace averaging (RMS) mode over a minimum of 100 traces.
- Use the peak marker function to determine the maximum amplitude level.
- Add  $10 \log (1/x)$ , where x is the duty cycle measured in step (a), to the measured PSD to compute the average PSD during the actual transmission time.

#### **4.5.5 Deviation from Test Standard**

No deviation.

#### **4.5.6 EUT Operating Condition**

Same as Item 4.3.6

#### 4.5.7 Test Results

##### 802.11b

TX chain	Channel	Frequency (MHz)	PSD (dBm)	10 log (N=3) dB	Total PSD (dBm)	Limit (dBm)	Pass / Fail
0	1	2412	-6.17	4.77	-1.40	5.23	Pass
	6	2437	-6.07	4.77	-1.30	5.23	Pass
	11	2462	-7.11	4.77	-2.34	5.23	Pass
1	1	2412	-6.87	4.77	-2.10	5.23	Pass
	6	2437	-5.60	4.77	-0.83	5.23	Pass
	11	2462	-5.21	4.77	-0.44	5.23	Pass
2	1	2412	-5.53	4.77	-0.76	5.23	Pass
	6	2437	-6.47	4.77	-1.70	5.23	Pass
	11	2462	-5.16	4.77	-0.39	5.23	Pass

Note:

- Method 1 of power density measurement of KDB 662911 is using for calculating total power density. Total power density is summing entire spectra across corresponding frequency bins on the various outputs by computer.
- Directional gain = 4dBi + 10log(3) = 8.77dBi > 6dBi , so the power density limit shall be reduced to 8-(8.77-6) = 5.23dBm.

##### 802.11g

TX chain	Channel	Frequency (MHz)	PSD (dBm)	10 log (N=3) dB	Duty Factor	Total PSD with Duty Factor (dBm)	Limit (dBm)	Pass / Fail
0	1	2412	-14.11	4.77	0.13	-9.21	5.23	Pass
	6	2437	-9.97	4.77	0.13	-5.07	5.23	Pass
	11	2462	-16.65	4.77	0.13	-11.75	5.23	Pass
1	1	2412	-13.51	4.77	0.13	-8.61	5.23	Pass
	6	2437	-9.22	4.77	0.13	-4.32	5.23	Pass
	11	2462	-15.25	4.77	0.13	-10.35	5.23	Pass
2	1	2412	-13.84	4.77	0.13	-8.94	5.23	Pass
	6	2437	-10.46	4.77	0.13	-5.56	5.23	Pass
	11	2462	-16.69	4.77	0.13	-11.79	5.23	Pass

Note:

- Method 1 of power density measurement of KDB 662911 is using for calculating total power density. Total power density is summing entire spectra across corresponding frequency bins on the various outputs by computer.
- Directional gain = 4dBi + 10log(3) = 8.77dBi > 6dBi , so the power density limit shall be reduced to 8-(8.77-6) = 5.23dBm.
- Refer to section 3.3 for duty cycle spectrum plot.

**802.11n (20MHz)**

TX chain	Channel	Frequency (MHz)	PSD (dBm)	10 log (N=3) dB	Duty Factor	Total PSD with Duty Factor (dBm)	Limit (dBm)	Pass / Fail
0	1	2412	-10.80	4.77	0.11	-5.92	5.23	Pass
	6	2437	-10.20	4.77	0.11	-5.32	5.23	Pass
	11	2462	-14.03	4.77	0.11	-9.15	5.23	Pass
1	1	2412	-14.63	4.77	0.11	-9.75	5.23	Pass
	6	2437	-8.91	4.77	0.11	-4.03	5.23	Pass
	11	2462	-16.04	4.77	0.11	-11.16	5.23	Pass
2	1	2412	-15.19	4.77	0.11	-10.31	5.23	Pass
	6	2437	-10.56	4.77	0.11	-5.68	5.23	Pass
	11	2462	-17.03	4.77	0.11	-12.15	5.23	Pass

**Note:**

- Method 1 of power density measurement of KDB 662911 is using for calculating total power density. Total power density is summing entire spectra across corresponding frequency bins on the various outputs by computer.
- Directional gain = 4dBi + 10log(3) = 8.77dBi > 6dBi , so the power density limit shall be reduced to 8-(8.77-6) = 5.23dBm.
- Refer to section 3.3 for duty cycle spectrum plot.

**802.11n (40MHz)**

TX chain	Channel	Frequency (MHz)	PSD (dBm)	10 log (N=3) dB	Duty Factor	Total PSD with Duty Factor (dBm)	Limit (dBm)	Pass / Fail
0	3	2422	-22.33	4.77	0.35	-17.21	5.23	Pass
	6	2437	-19.86	4.77	0.35	-14.74	5.23	Pass
	9	2452	-24.05	4.77	0.35	-18.93	5.23	Pass
1	3	2422	-21.32	4.77	0.35	-16.20	5.23	Pass
	6	2437	-18.84	4.77	0.35	-13.72	5.23	Pass
	9	2452	-22.45	4.77	0.35	-17.33	5.23	Pass
2	3	2422	-21.74	4.77	0.35	-16.62	5.23	Pass
	6	2437	-19.38	4.77	0.35	-14.26	5.23	Pass
	9	2452	-22.36	4.77	0.35	-17.24	5.23	Pass

**Note:**

- Method 1 of power density measurement of KDB 662911 is using for calculating total power density. Total power density is summing entire spectra across corresponding frequency bins on the various outputs by computer.
- Directional gain = 4dBi + 10log(3) = 8.77dBi > 6dBi , so the power density limit shall be reduced to 8-(8.77-6) = 5.23dBm.
- Refer to section 3.3 for duty cycle spectrum plot.

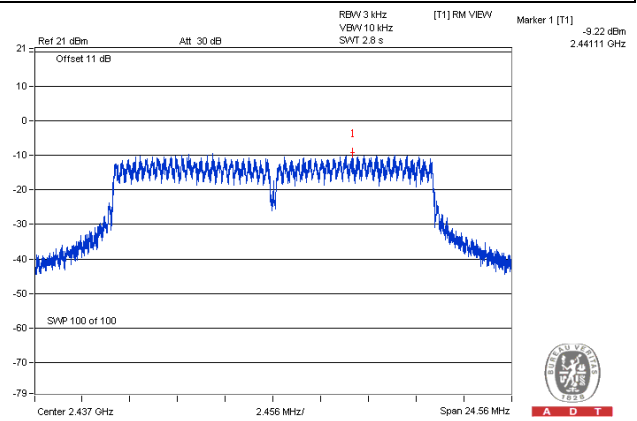
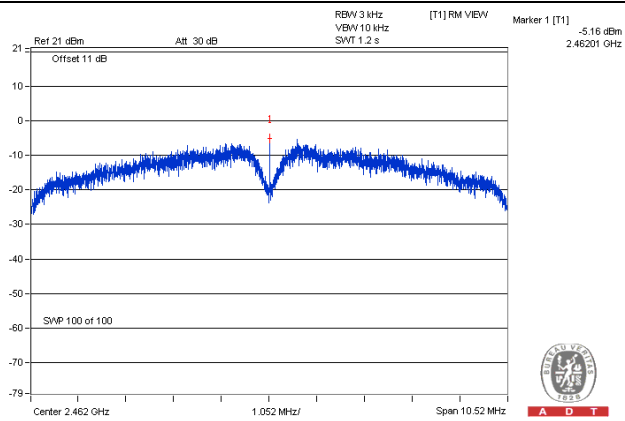
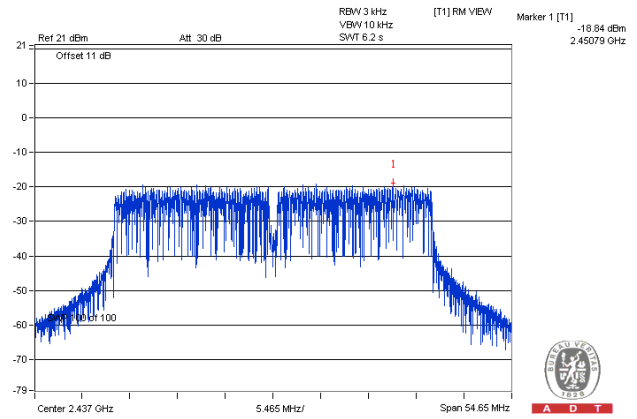
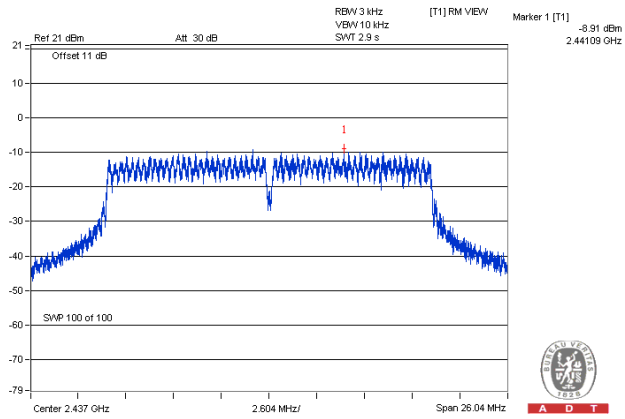
**Spectrum Plot of Worst Value****802.11b****802.11g****802.11n (20MHz)****802.11n (40MHz)**



## 4.6 Conducted Out of Band Emission Measurement

### 4.6.1 Limits of Conducted Out of Band Emission Measurement

Below 30dB of the highest emission level of operating band (in 100kHz Resolution Bandwidth).

### 4.6.2 Test Setup

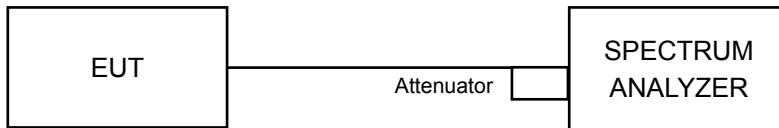

### 4.6.3 Test Instruments

Refer to section 4.1.2 to get information of above instrument.

### 4.6.4 Test Procedure

#### MEASUREMENT PROCEDURE REF

- Set the RBW = 100 kHz.
- Set the VBW  $\geq$  300 kHz.
- Detector = average.
- Sweep time = auto couple.
- Trace mode = max hold.
- Allow trace to fully stabilize.
- Use the peak marker function to determine the maximum power level in any 100 kHz band segment within the fundamental EBW.

#### MEASUREMENT PROCEDURE OOBE

- Set RBW = 100 kHz.
- Set VBW  $\geq$  300 kHz.
- Ensure that the number of measurement points  $\geq$  span/RBW
- According to measurement points to set differ measurement span.
- Detector = average.
- Trace Mode = max hold.
- Sweep = auto couple.

#### 4.6.5 Deviation from Test Standard

No deviation.

#### 4.6.6 EUT Operating Condition

Same as Item 4.3.6

#### 4.6.7 Test Results

The spectrum plots are attached on the following pages. D1 line indicates the highest level, and D2 line indicates the 30dB offset below D1. It shows compliance with the requirement.

802.11b\_Chain 0

CH 1

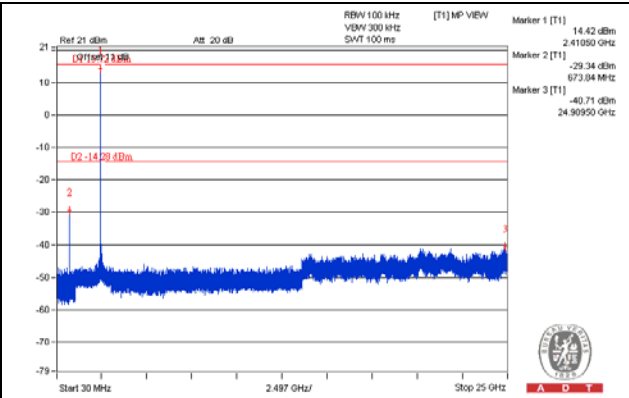
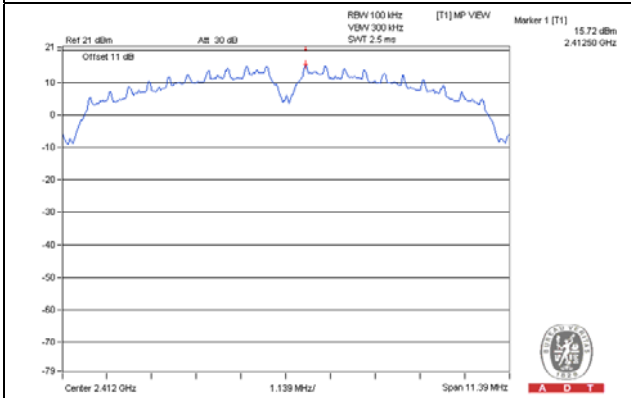

CH 6

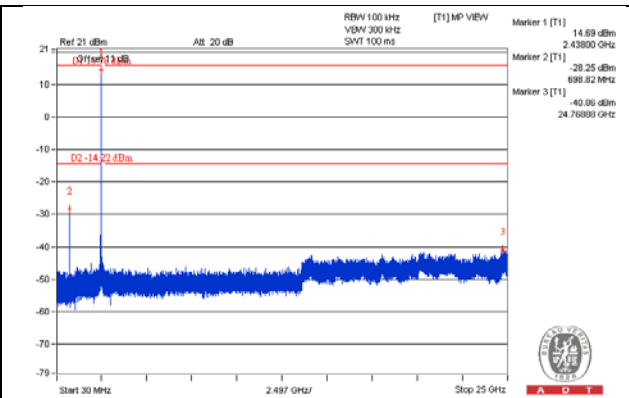
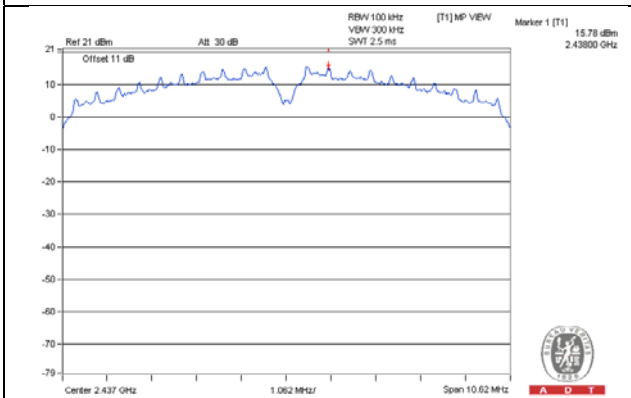

CH 11

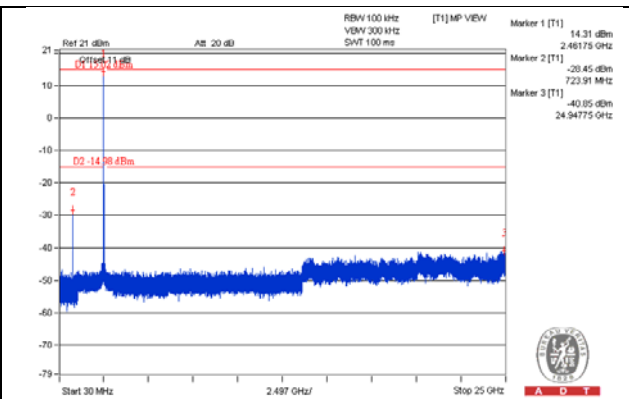
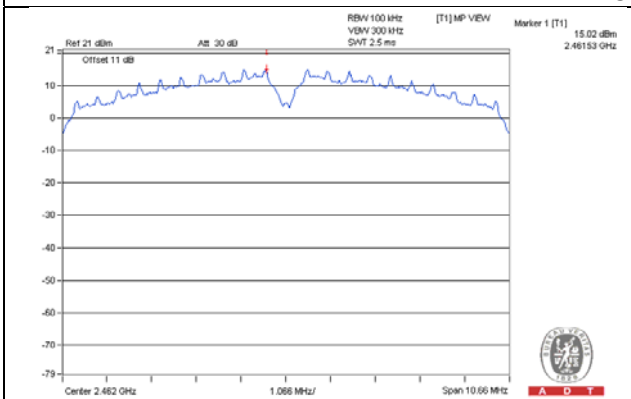

CH 1 Band edge

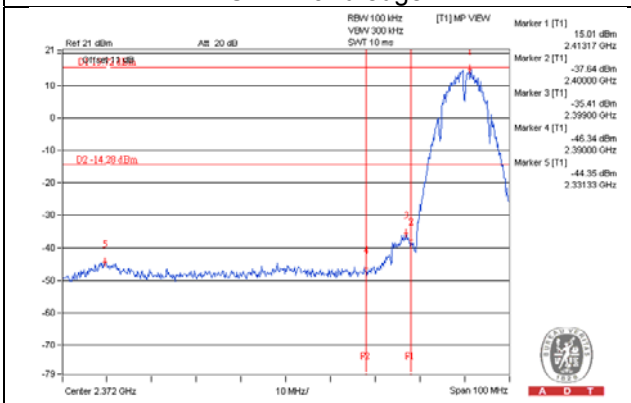

CH 11 Band edge

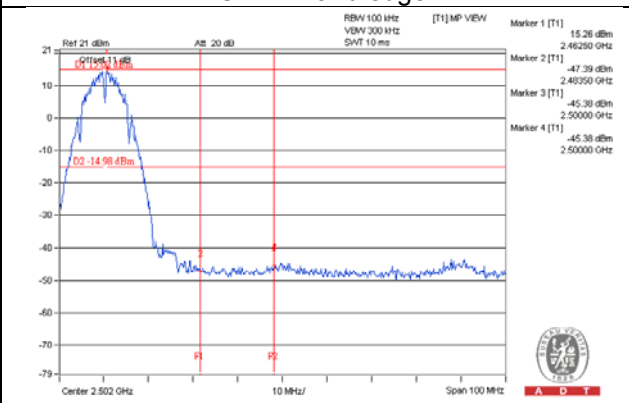

802.11b\_Chain 1

CH 1

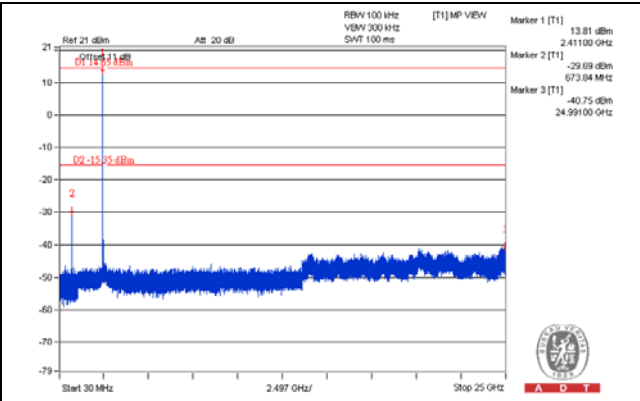
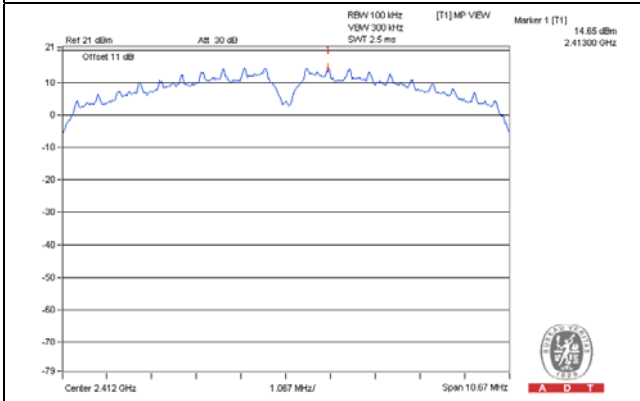

CH 6

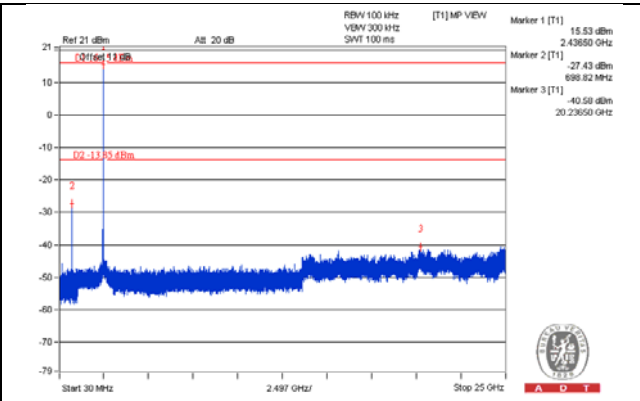
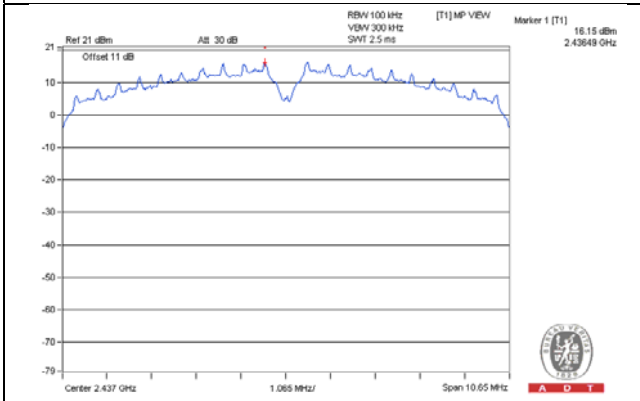

CH 11

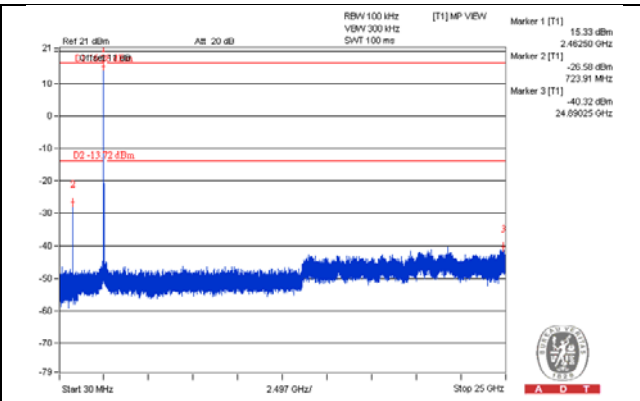
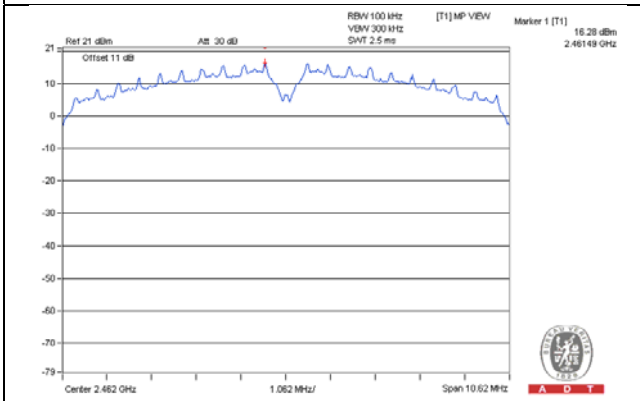

CH 1 Band edge

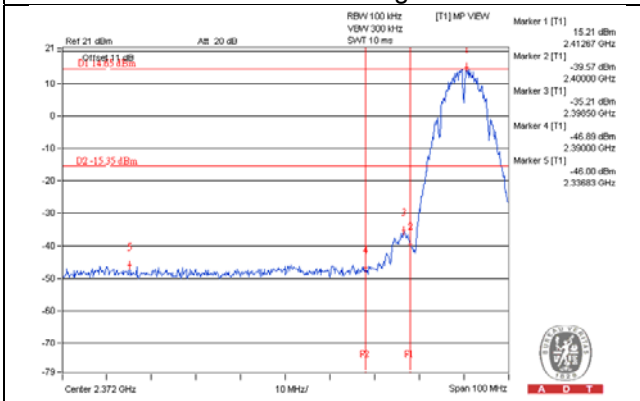

CH 11 Band edge

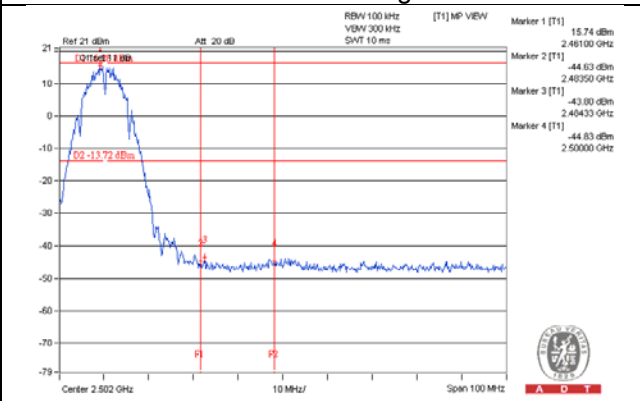

802.11b\_Chain 2

CH 1

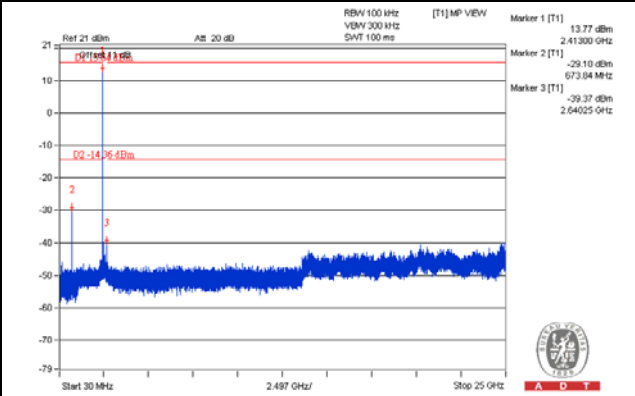
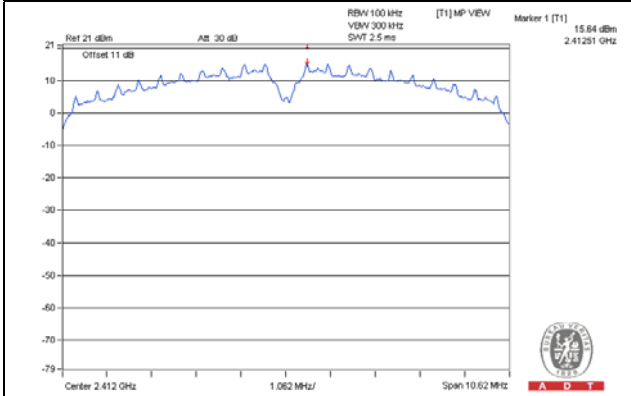

CH 6

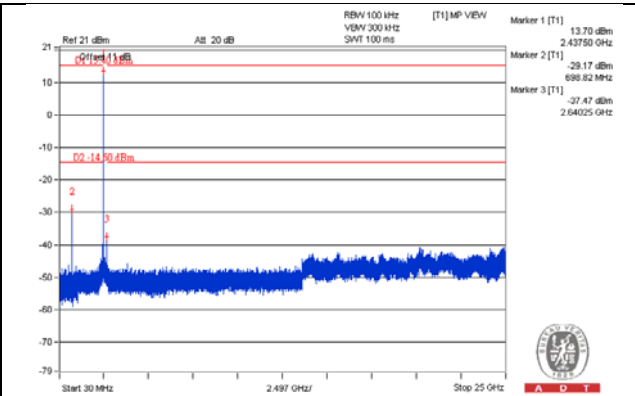
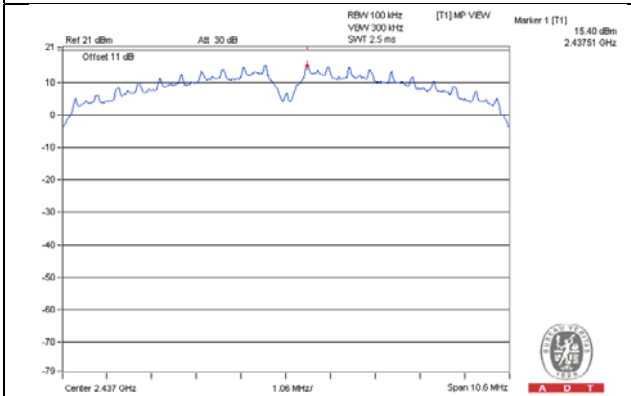

CH 11

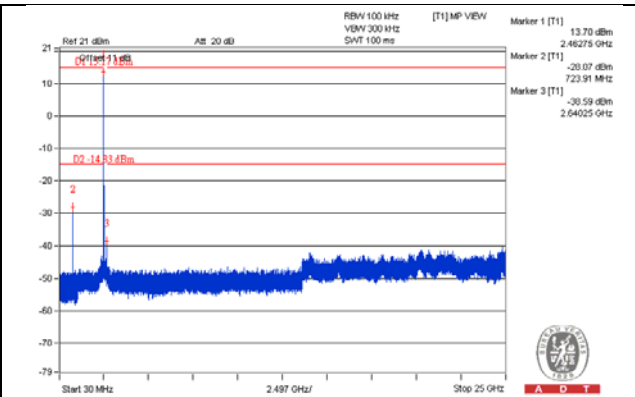
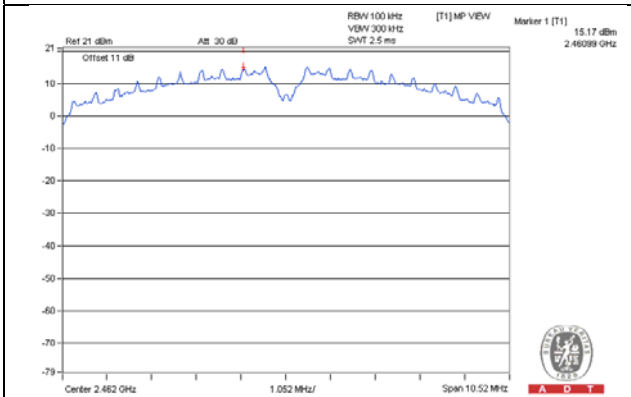

CH 1 Band edge

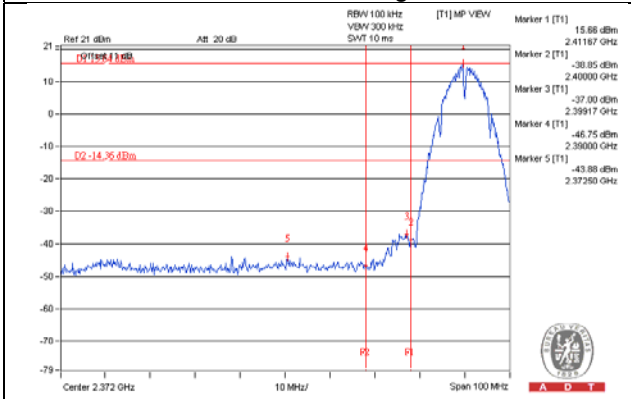

CH 11 Band edge

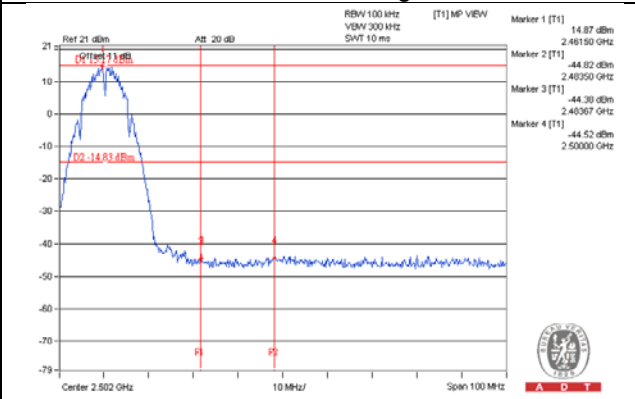

802.11g\_Chain 0

CH 1

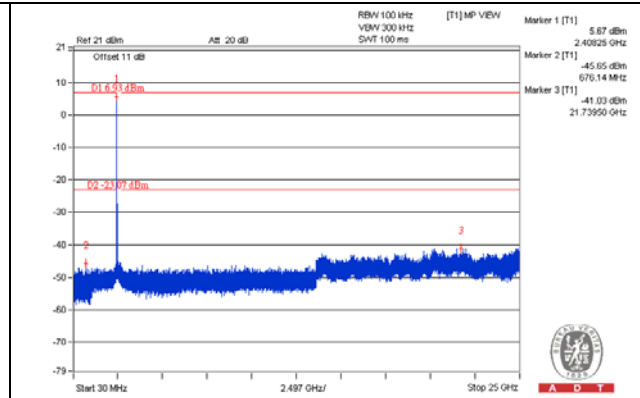
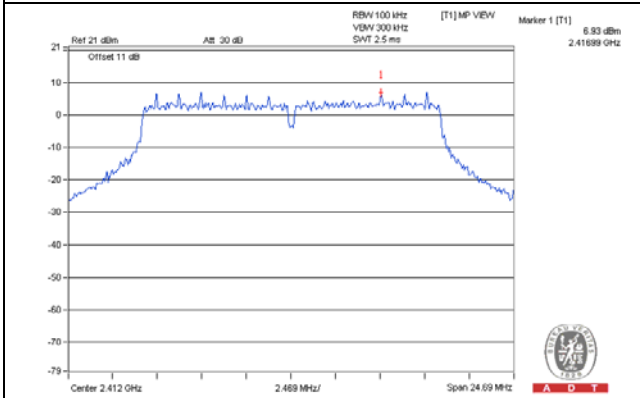

CH 6

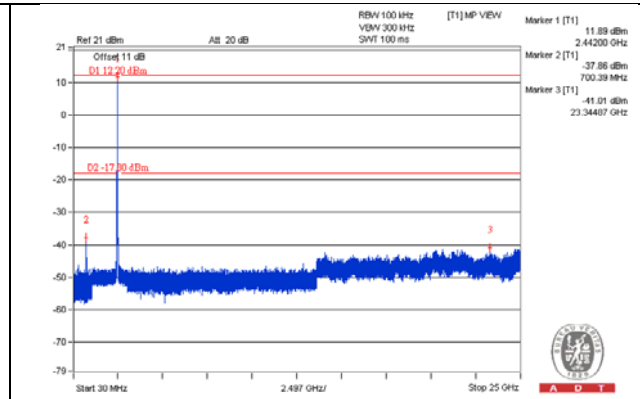
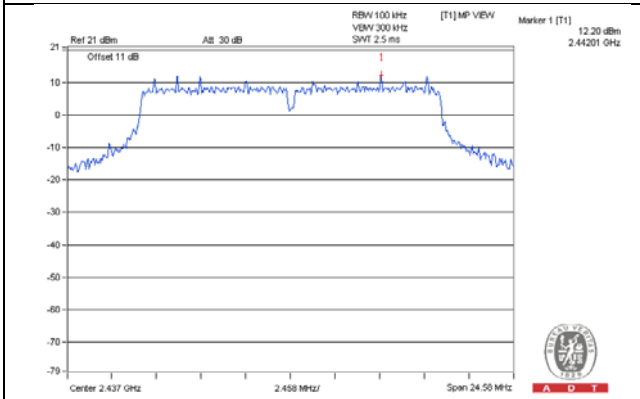

CH 11

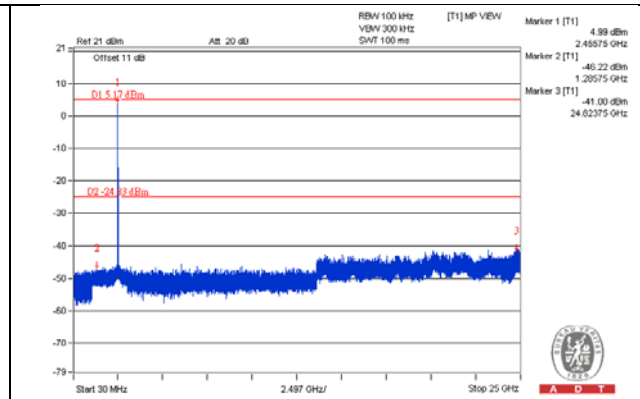
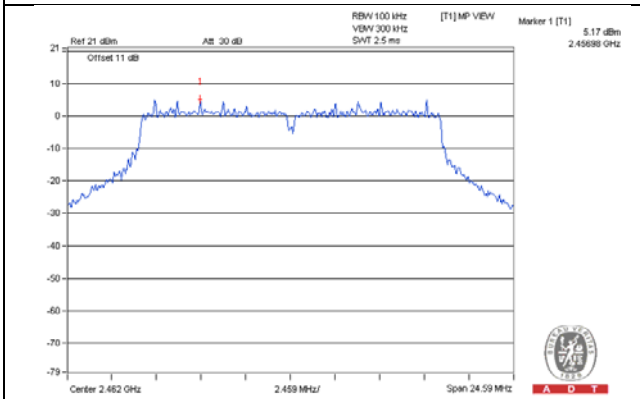

CH 1 Band edge

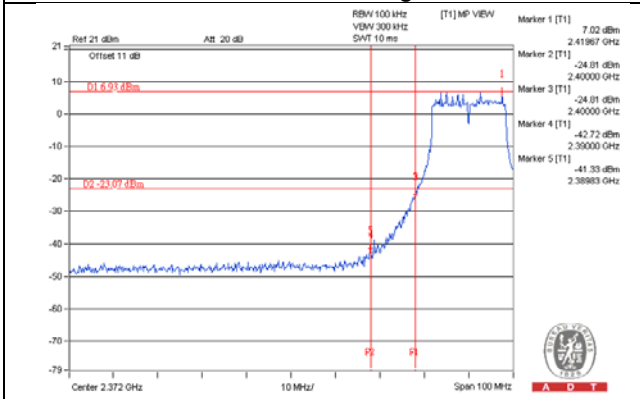

CH 11 Band edge

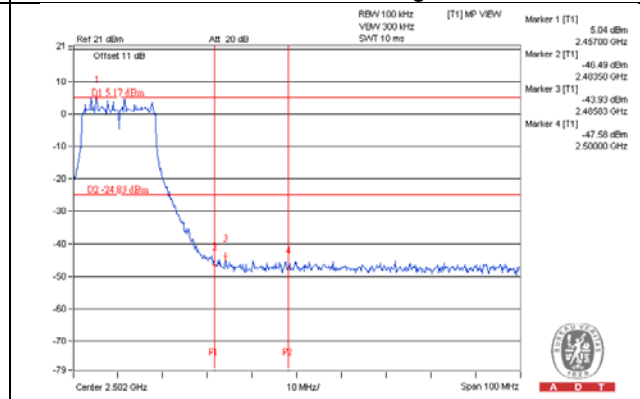

### 802.11g\_Chain 1

#### CH 1

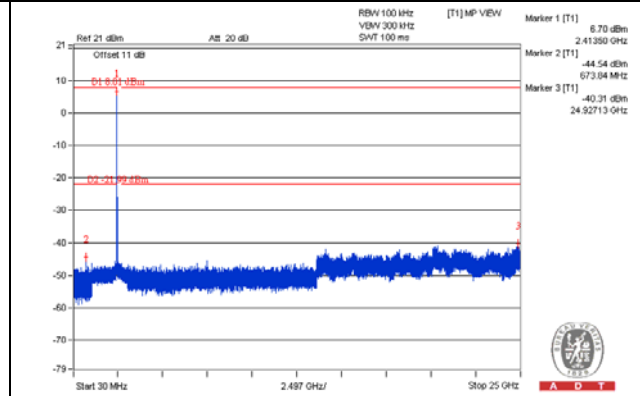
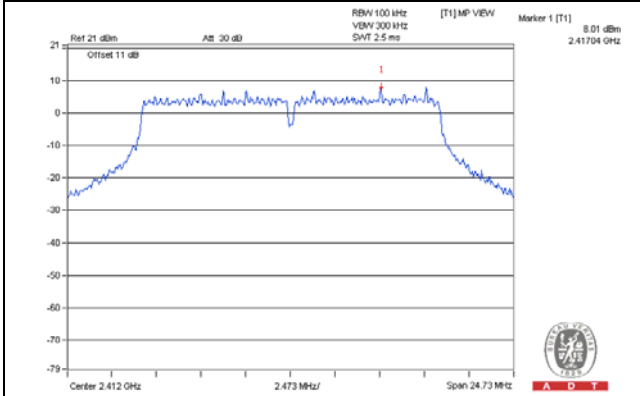

#### CH 6

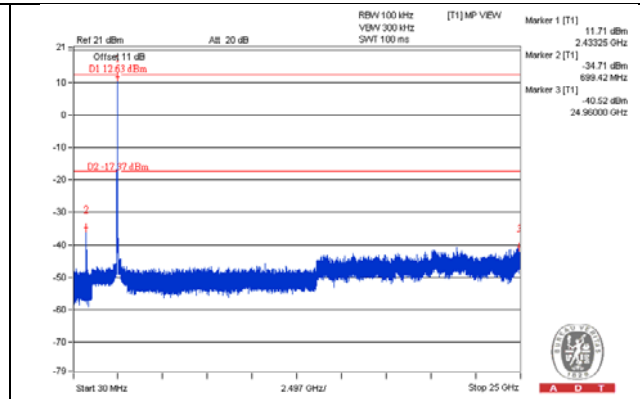
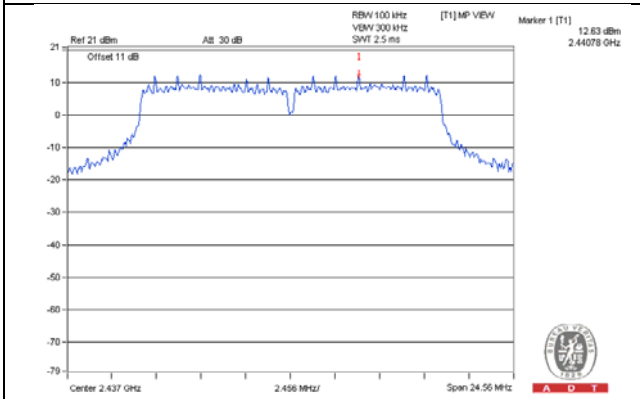

#### CH 11

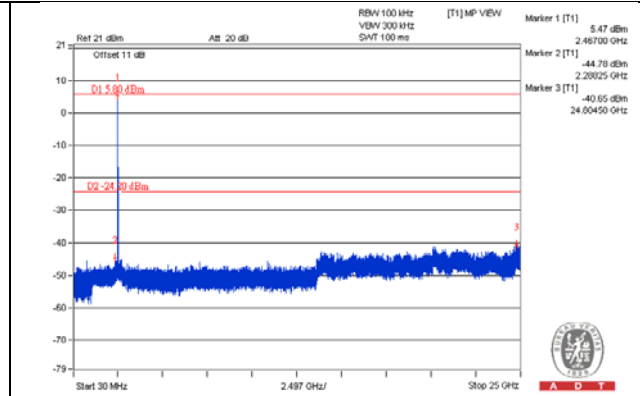
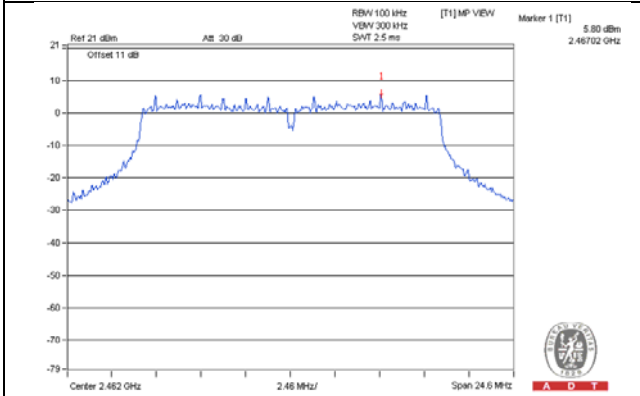

#### CH 1 Band edge

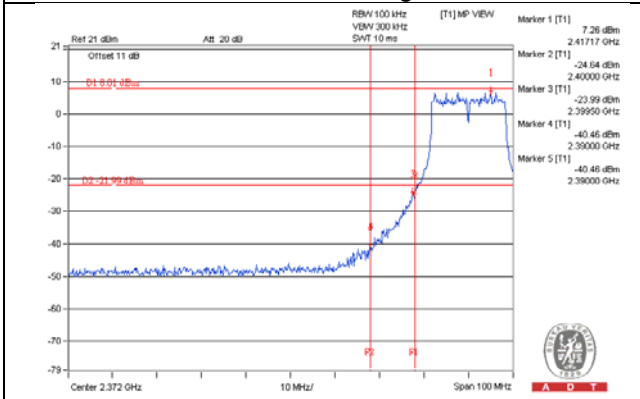

#### CH 11 Band edge

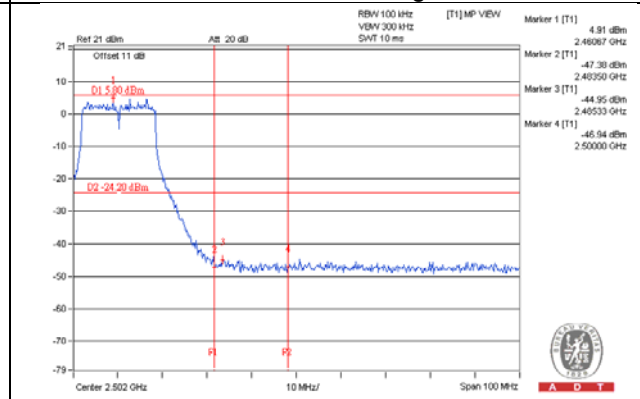

802.11g\_Chain 2

CH 1

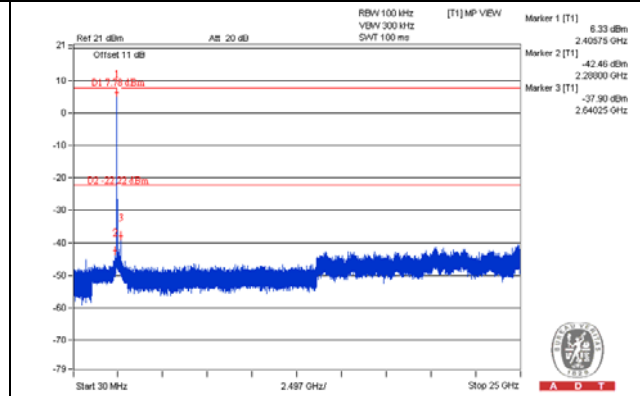
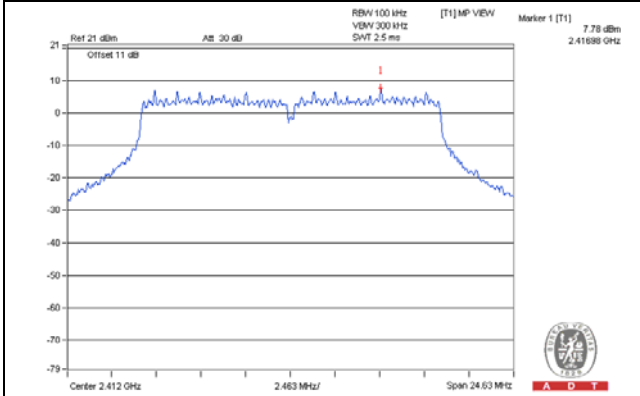

CH 6

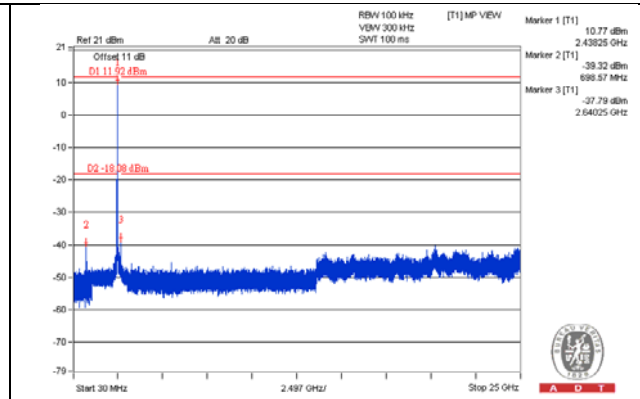
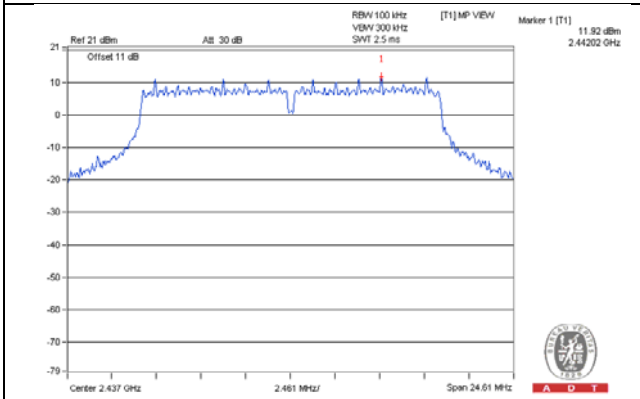

CH 11

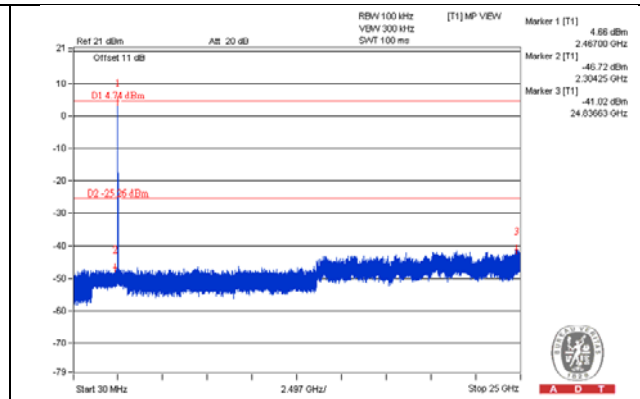
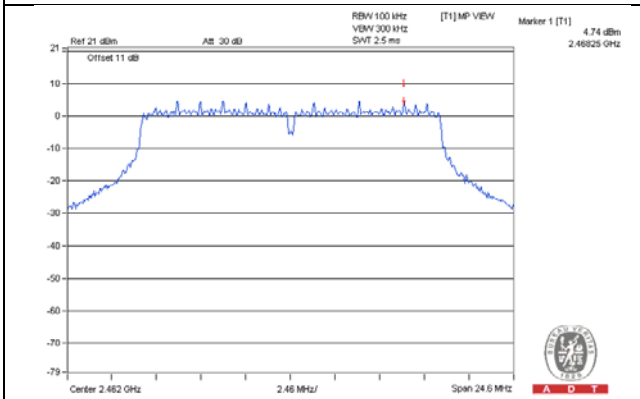

CH 1 Band edge

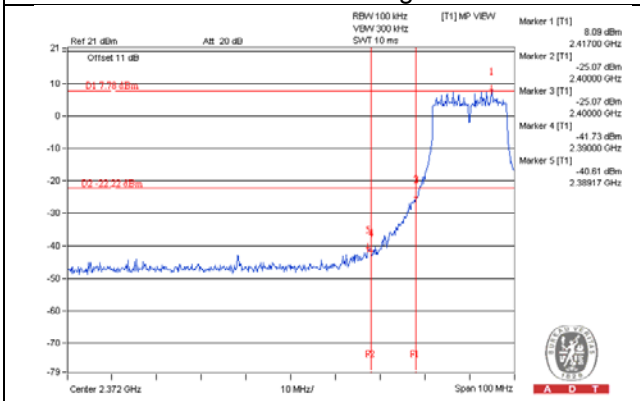

CH 11 Band edge

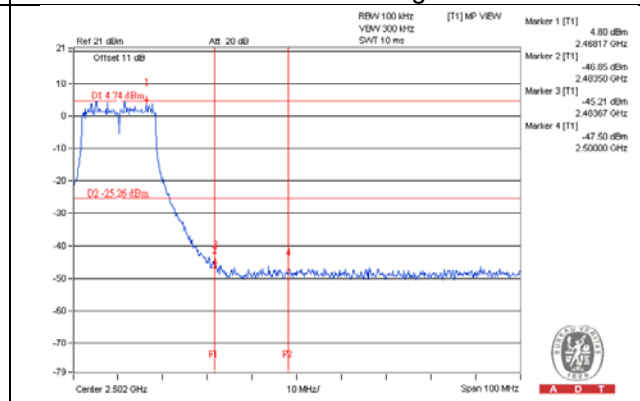



802.11n (20MHz)\_Chain 0

CH 1

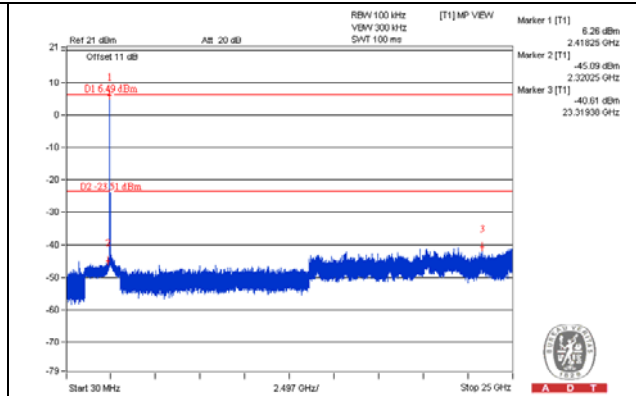
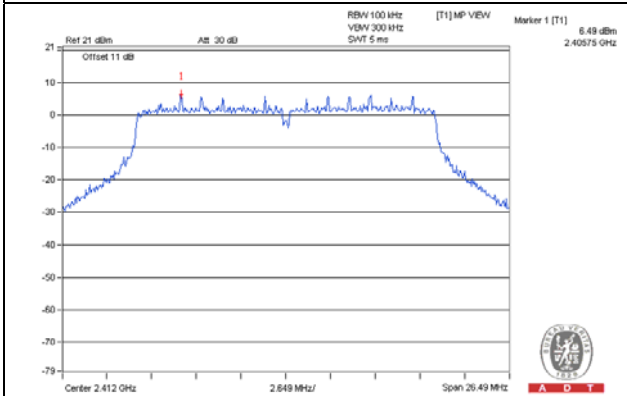

CH 6

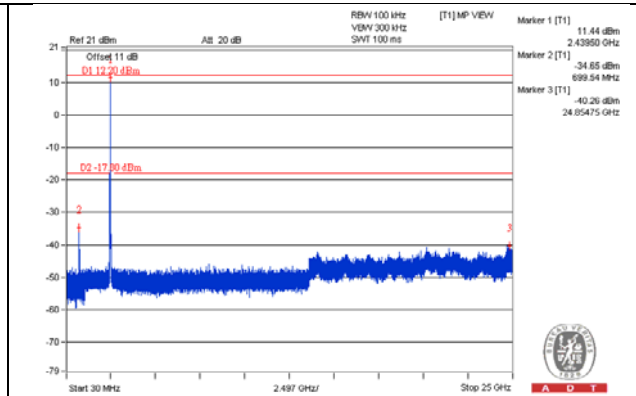
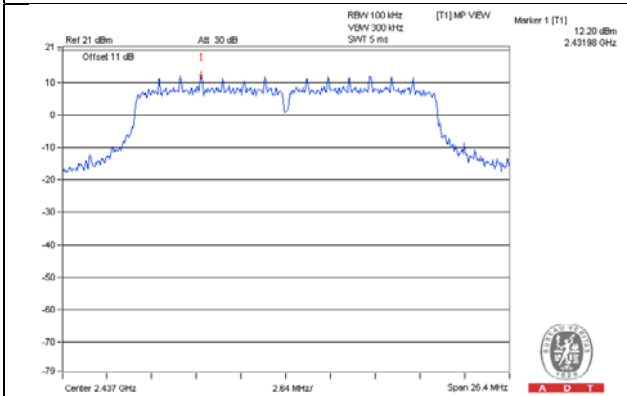

CH 11

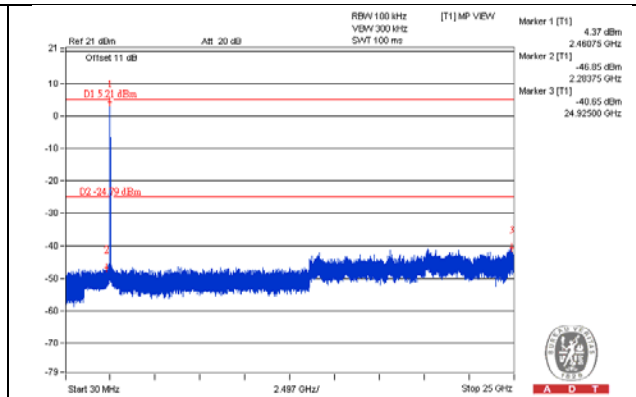
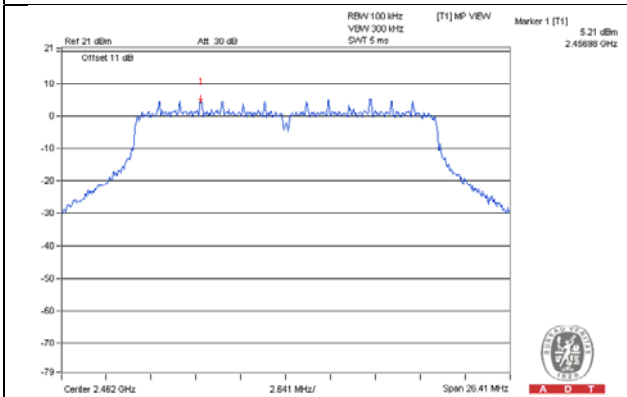

CH 1 Band edge

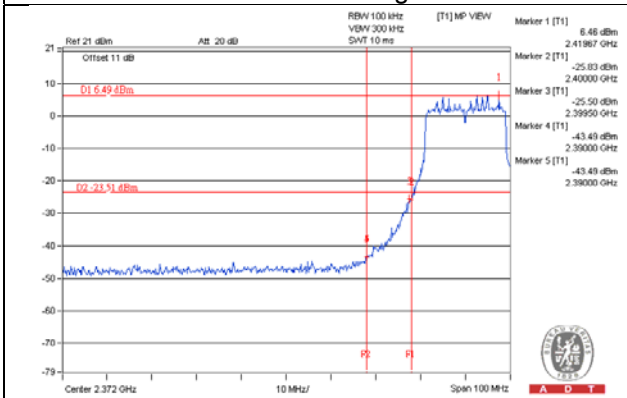

CH 11 Band edge

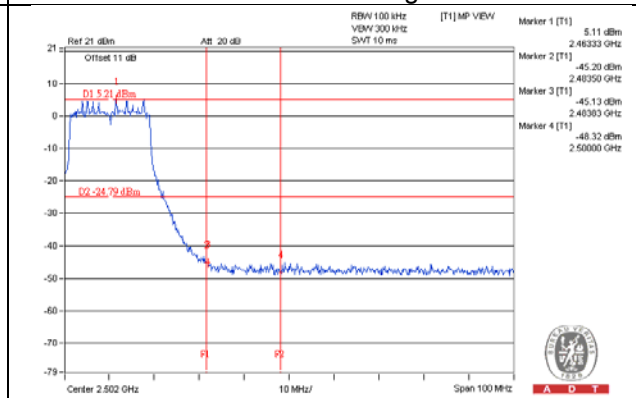

802.11n (20MHz)\_Chain 1

CH 1

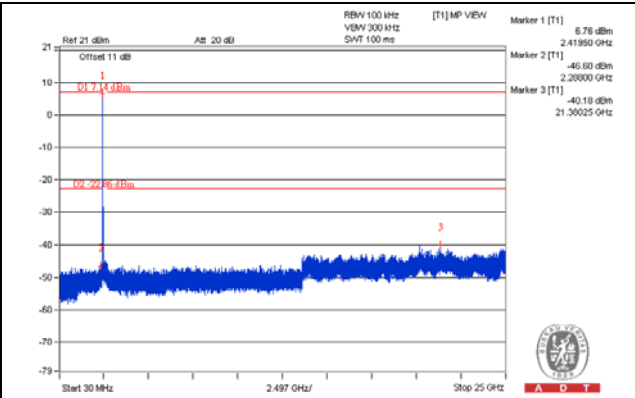
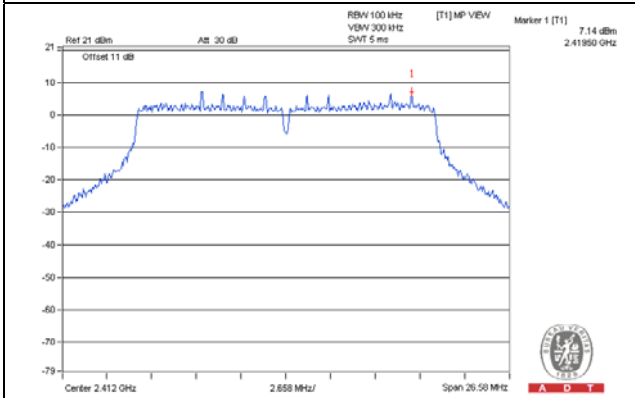

CH 6

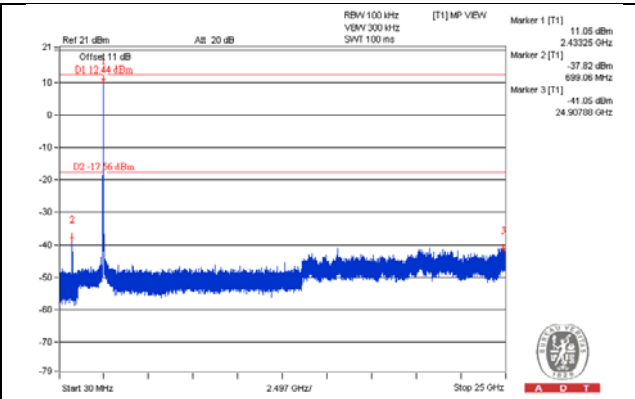
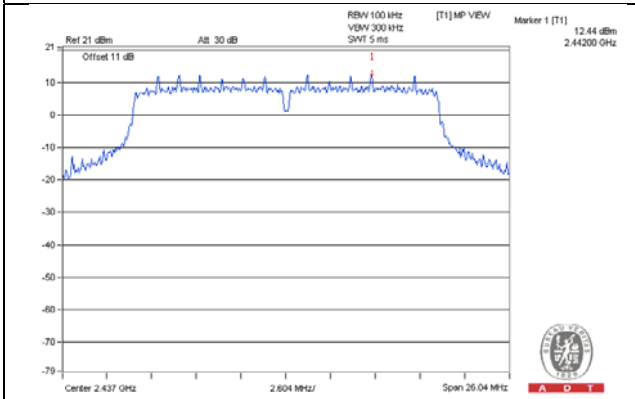

CH 11

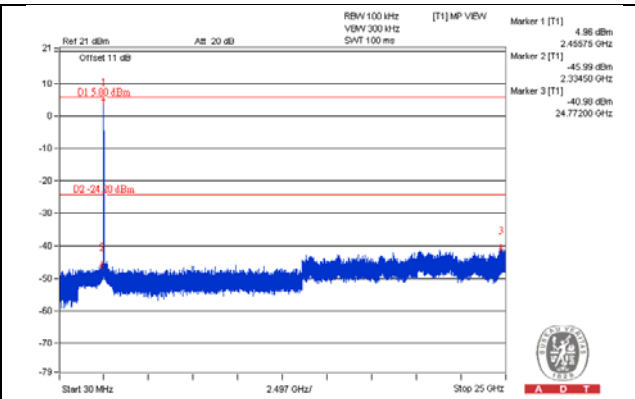
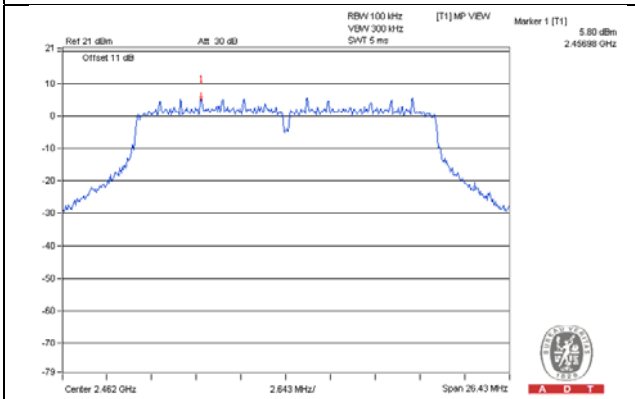

CH 1 Band edge

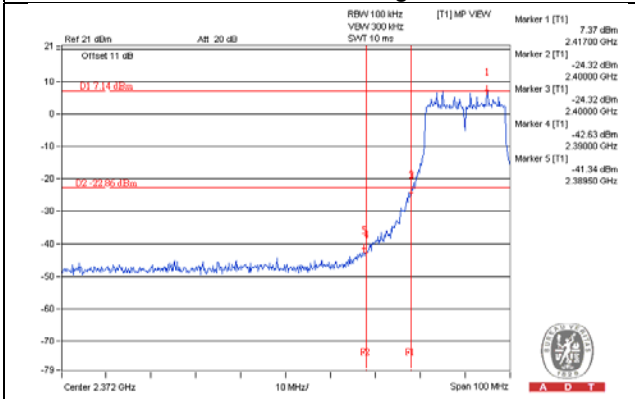

CH 11 Band edge

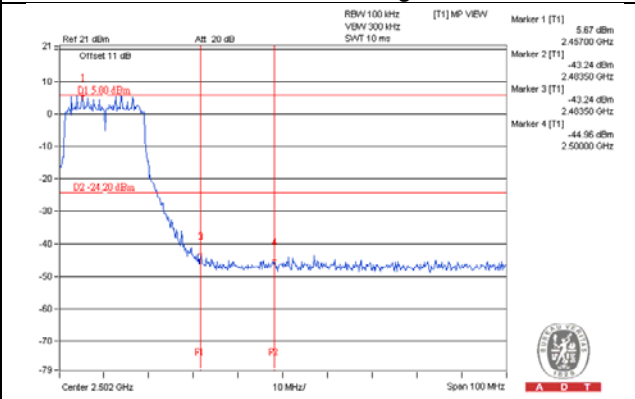

802.11n (20MHz)\_Chain 2

CH 1

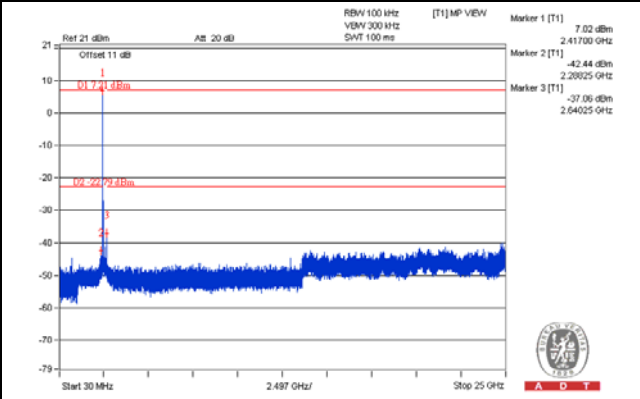
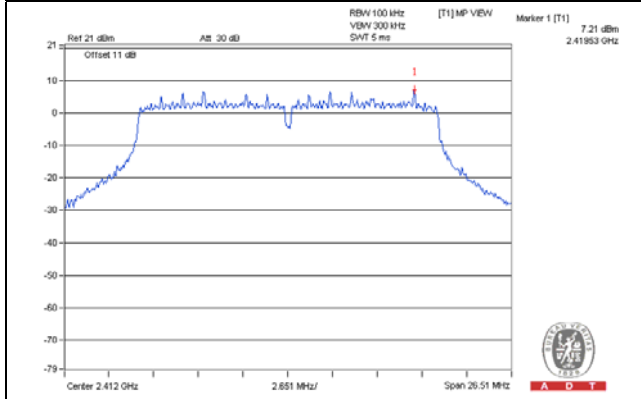

CH 6

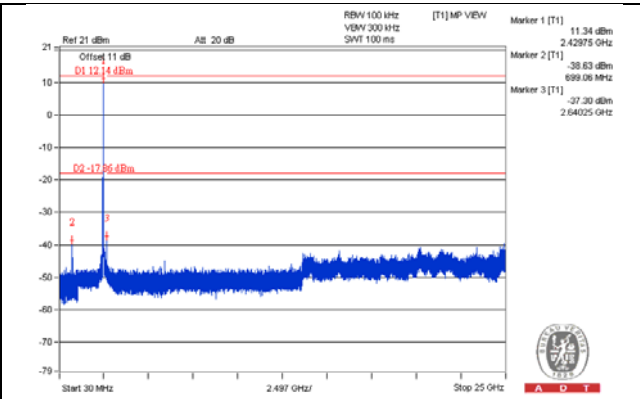
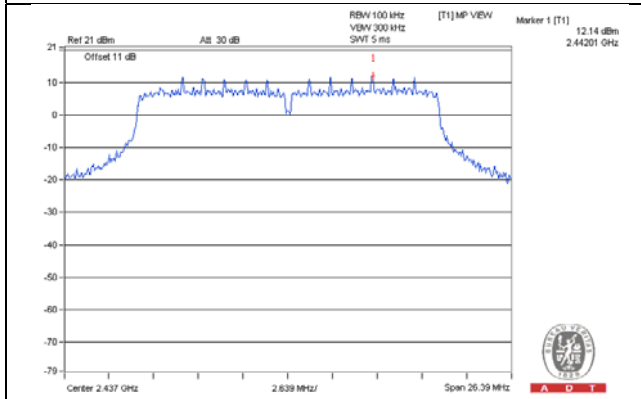

CH 11

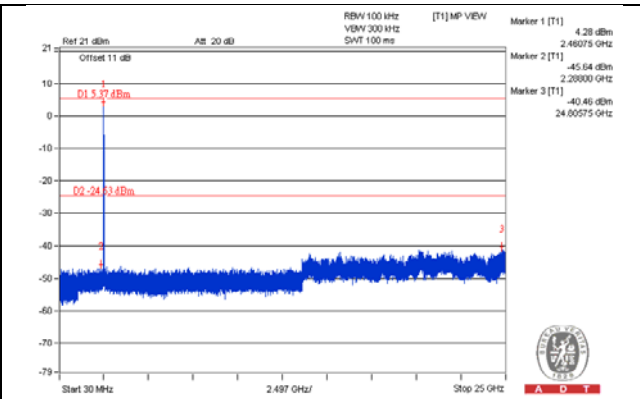
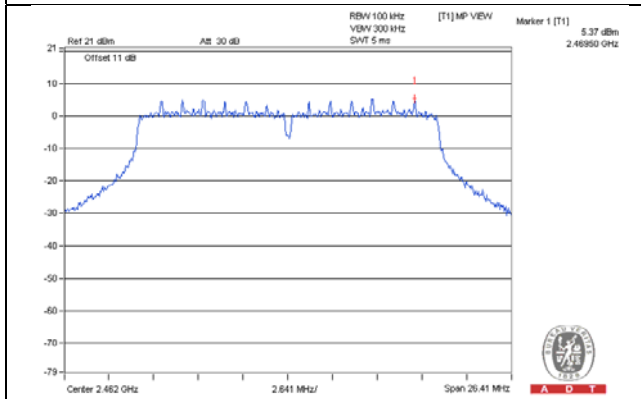

CH 1 Band edge

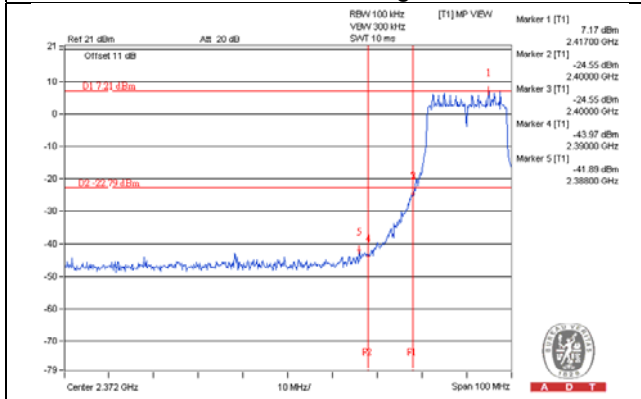

CH 11 Band edge

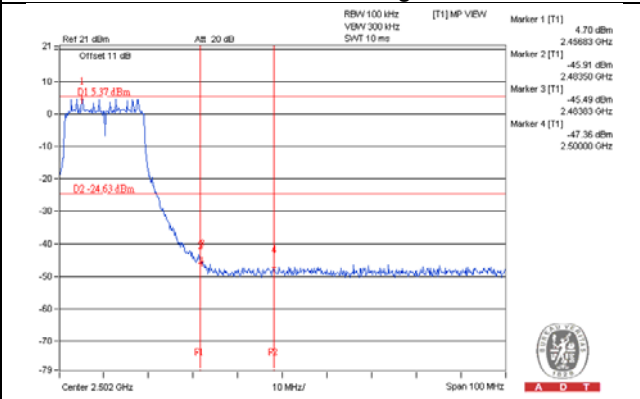

802.11n (40MHz)\_Chain 0

CH 3

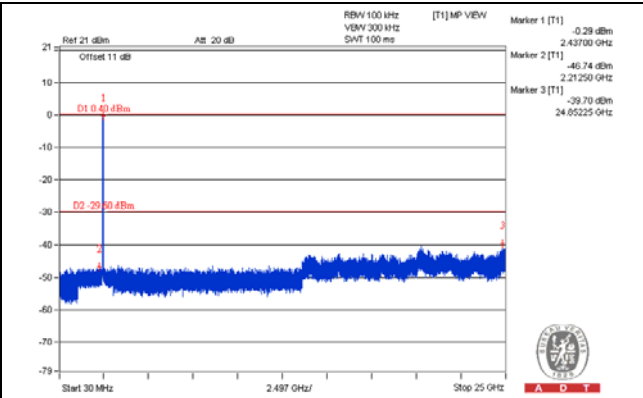
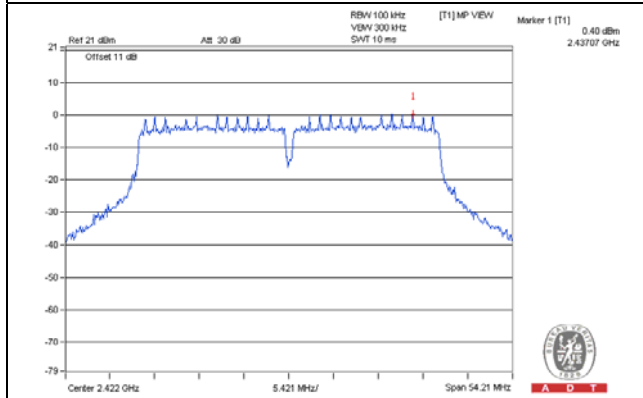

CH 6

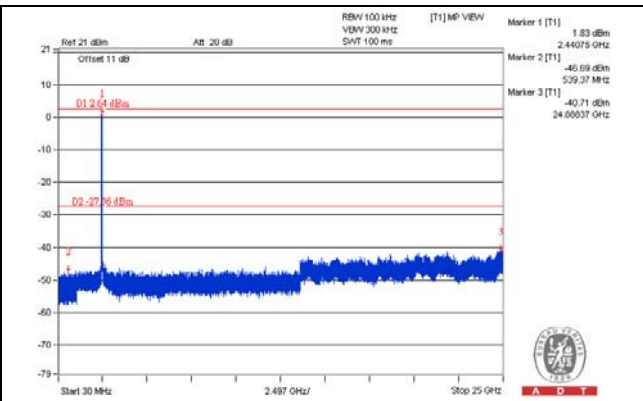
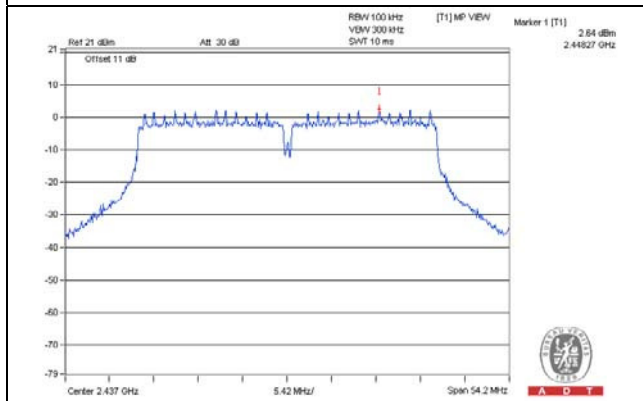

CH 9

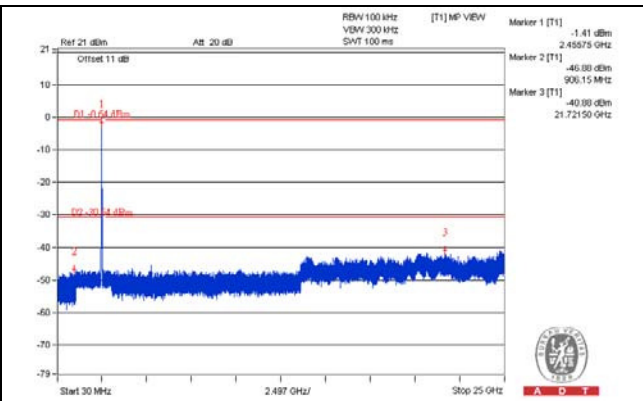
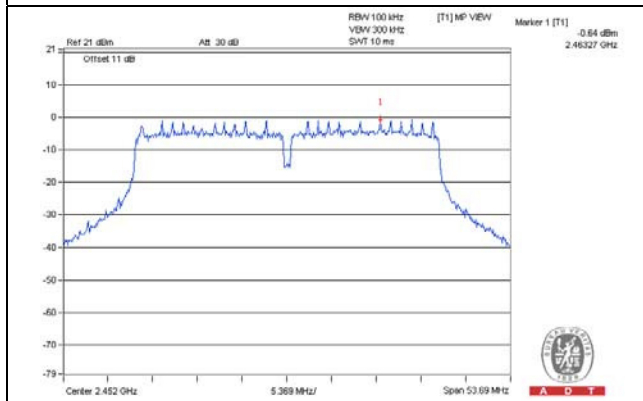

CH 3 Band edge

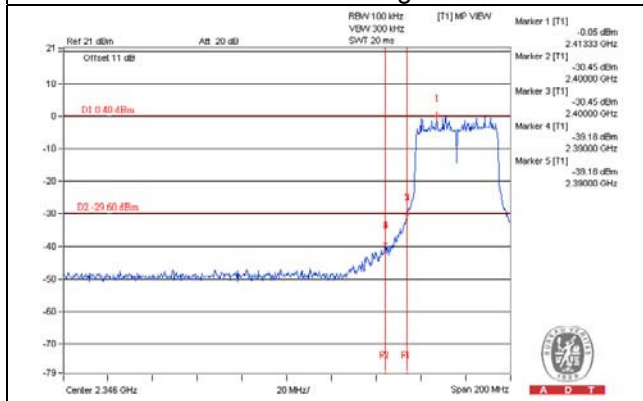

CH 9 Band edge

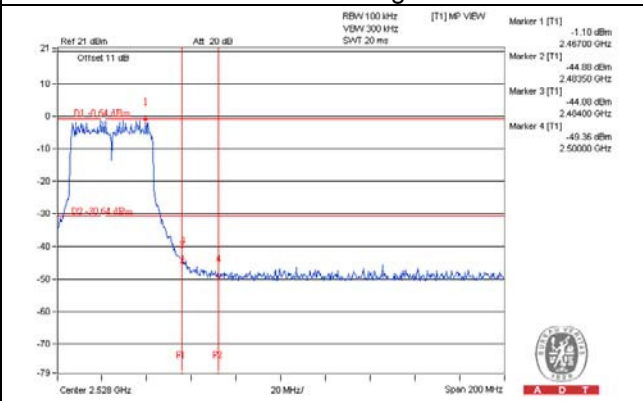

802.11n (40MHz)\_Chain 1

CH 3

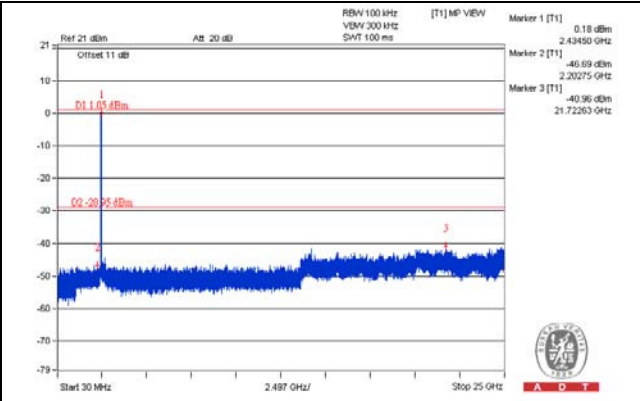
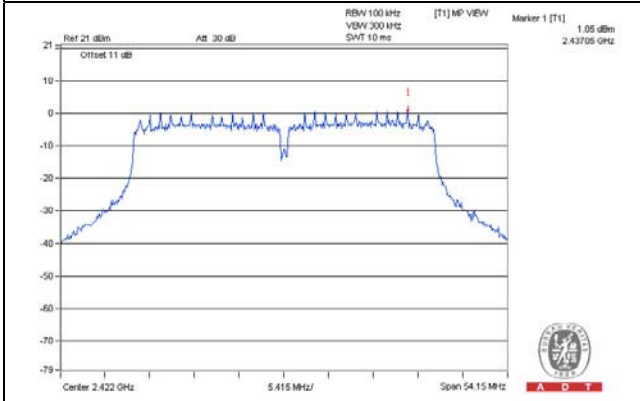

CH 6

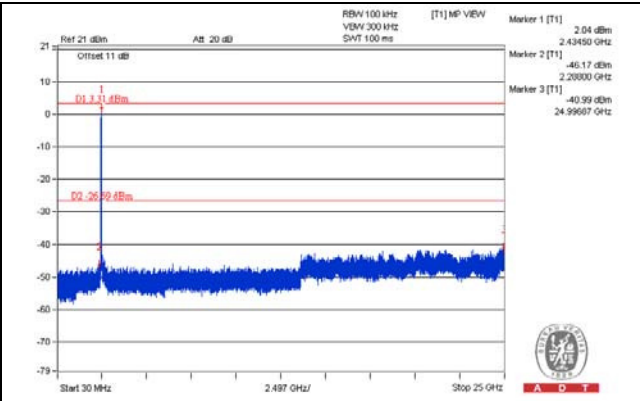
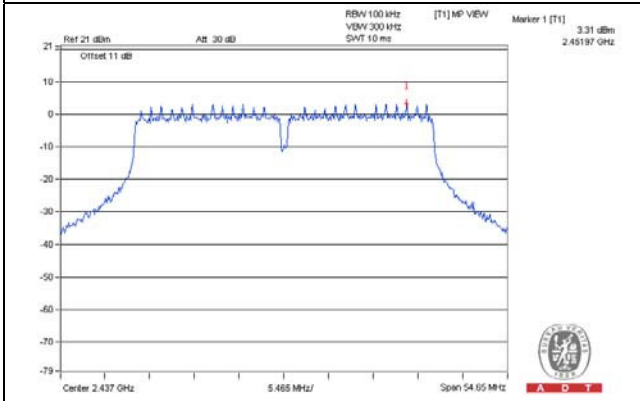

CH 9

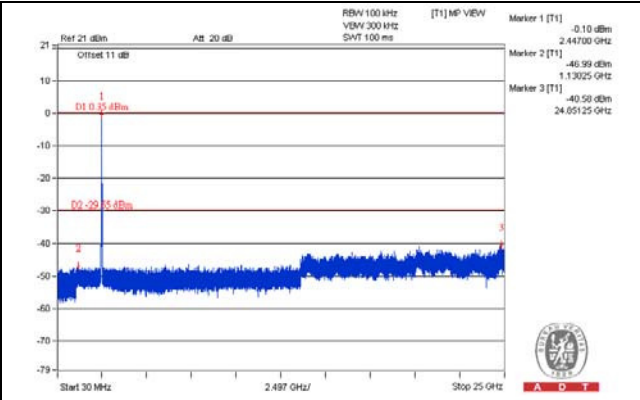
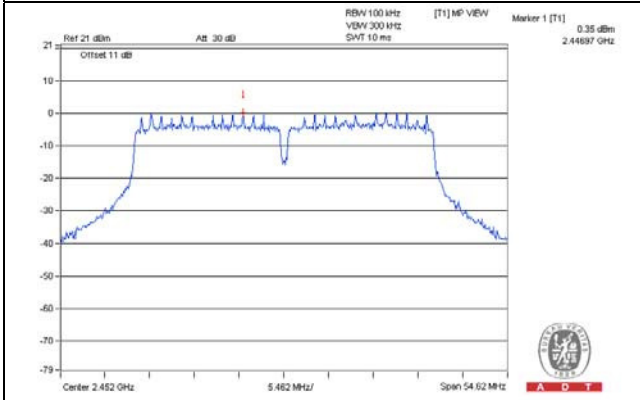

CH 3 Band edge

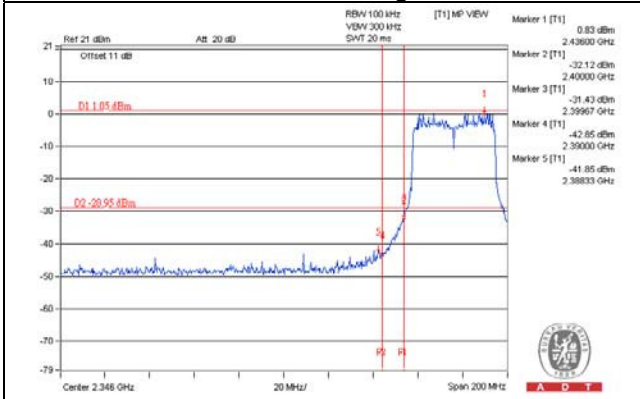

CH 9 Band edge

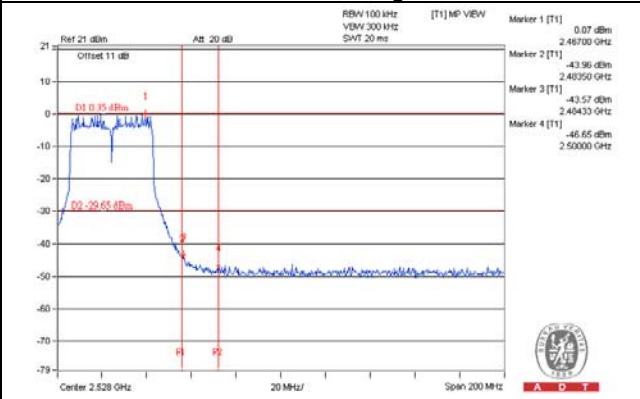

802.11n (40MHz)\_Chain 2

CH 3

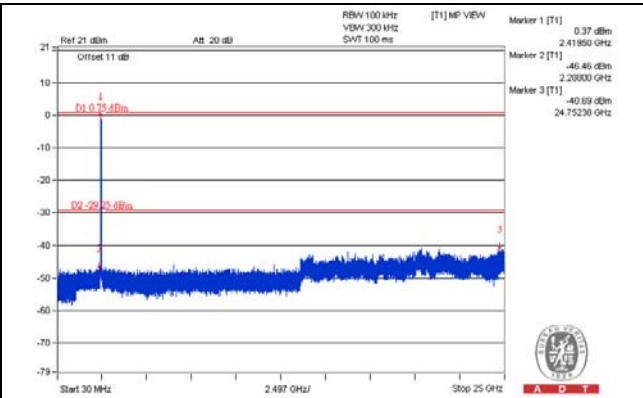
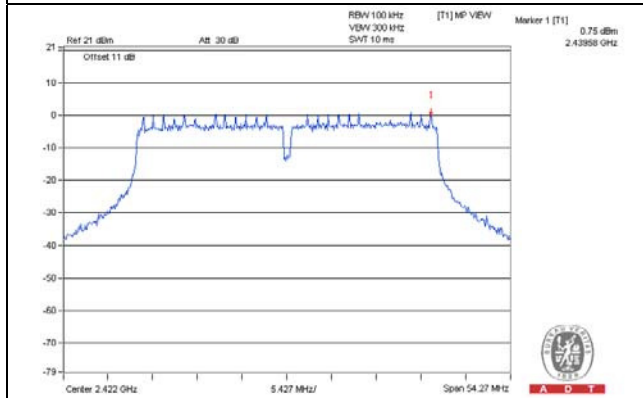

CH 6

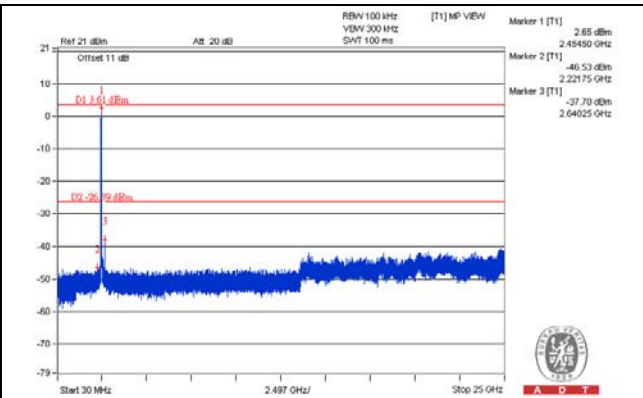
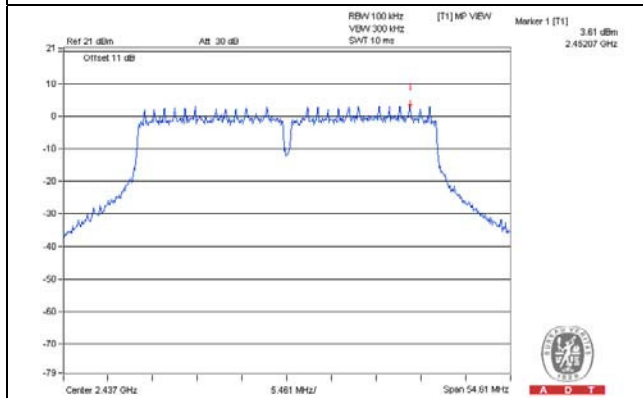

CH 9

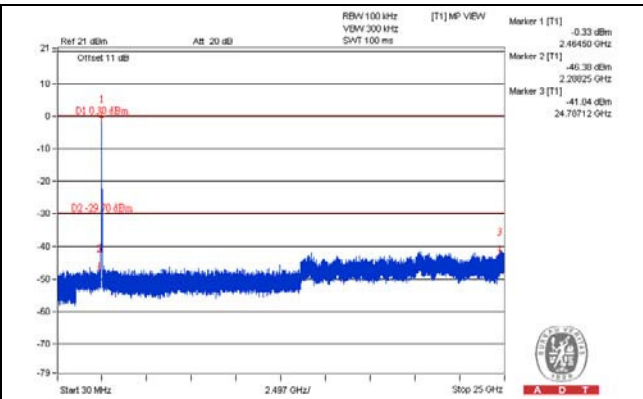
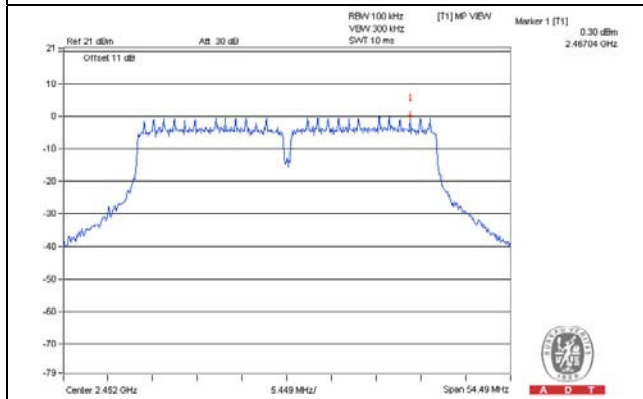

CH 3 Band edge

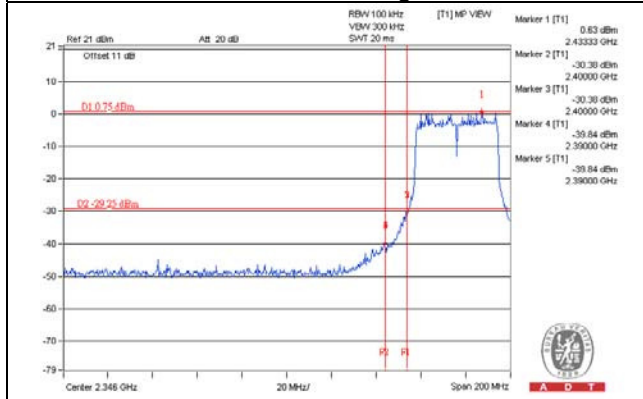

CH 9 Band edge

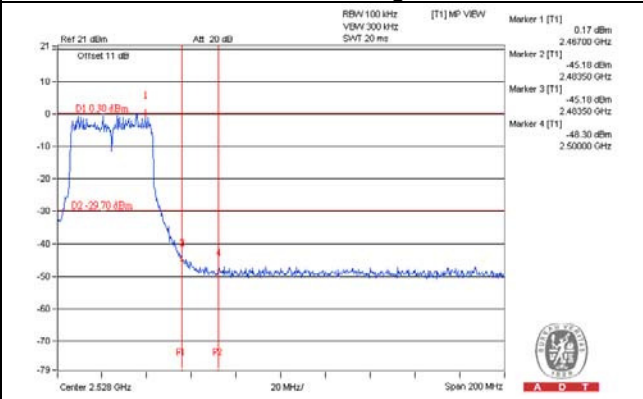

## 5 Pictures of Test Arrangements

Please refer to the attached file (Test Setup Photo).

## Appendix – Information on the Testing Laboratories

We, Bureau Veritas Consumer Products Services (H.K.) Ltd., Taoyuan Branch, were founded in 1988 to provide our best service in EMC, Radio, Telecom and Safety consultation. Our laboratories are accredited and approved according to ISO/IEC 17025.

If you have any comments, please feel free to contact us at the following:

**Linko EMC/RF Lab**

Tel: 886-2-26052180

Fax: 886-2-26051924

**Hsin Chu EMC/RF/Telecom Lab**

Tel: 886-3-6668565

Fax: 886-3-6668323

**Hwa Ya EMC/RF/Safety Lab**

Tel: 886-3-3183232

Fax: 886-3-3270892

**Email:** [service.adt@tw.bureauveritas.com](mailto:service.adt@tw.bureauveritas.com)

**Web Site:** [www.bureauveritas-adt.com](http://www.bureauveritas-adt.com)

The address and road map of all our labs can be found in our web site also.

--- END ---