



FCC RADIO TEST REPORT

Applicant : SteelSeries ApS.
Address : 656 W Randolph St., Suite 3E Chicago, IL 60661,
USA
Equipment : 2.0 Wireless Speaker System
Model No. : SP-00001
Trade Name : 
FCC ID : ZHK-SP00001

I HEREBY CERTIFY THAT :

The sample was received on May. 18, 2020 and the testing was completed on Feb. 19, 2021 at CerpPASS Technology Corp. The test result refers exclusively to the test presented test model / sample. Without written approval of CerpPASS Technology Corp., the test report shall not be reproduced except in full.

Approved by:

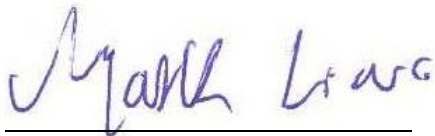

Mark Liao / Supervisor

Laboratory Accreditation:

CerpPASS Technology Corporation Test Laboratory





CONTENTS

- 1. **Summary of Test Procedure and Test Results**.....5
 - 1.1 Applicable Standards5
- 2. **Test Configuration of Equipment under Test**.....6
 - 2.1 Feature of Equipment under Test.....6
 - 2.2 Carrier Frequency of Channes.....7
 - 2.3 Test Mode & Test Software8
 - 2.4 Description of Test System.....9
 - 2.5 General Information of Test.....10
 - 2.6 Measurement Uncertainty10
- 3. **Test Equipment and Ancillaries Used for Tests**.....11
- 4. **Antenna Requirements**.....13
 - 4.1 Standard Applicable13
 - 4.2 Antenna Construction and Directional Gain.....13
- 5. **Test of AC Power Line Conducted Emission**14
 - 5.1 Test Limit14
 - 5.2 Test Procedures14
 - 5.3 Typical Test Setup15
 - 5.4 Test Result and Data16
 - 5.5 Test Photographs18
- 6. **Test of Radiated Spurious Emission**.....19
 - 6.1 Test Limit19
 - 6.2 Test Procedures.....19
 - 6.3 Typical Test Setup20
 - 6.4 Test Result and Data (9kHz ~ 30MHz).....21
 - 6.5 Test Result and Data (30MHz ~ 1GHz).....21
 - 6.6 Test Result and Data (1GHz ~ 25GHz).....23
 - 6.7 Restricted Bands of Operation35
 - 6.8 Test Photographs (30MHz ~ 1GHz).....36
 - 6.9 Test Photographs (1GHz ~ 25GHz)37
- 7. **Test of Conducted Spurious Emission**39
 - 7.1 Test Limit39
 - 7.2 Test Procedure39
 - 7.3 Test Setup Layout39
 - 7.4 Test Result and Data39
- 8. **20dB Bandwidth Measurement Data**.....47
 - 8.1 Test Limit47
 - 8.2 Test Procedures47
 - 8.3 Test Setup Layout47
 - 8.4 Test Result and Data48
- 9. **Frequencies Separation**51
 - 9.1 Test Limit51
 - 9.2 Test Procedures51



9.3 Test Setup Layout51

9.4 Test Result and Data51

10. Dwell Time on each channel54

10.1 Test Limit54

10.2 Test Procedures54

10.3 Test Setup Layout54

10.4 Test Result and Data55

11. Number of Hopping Channels58

11.1 Test Limit58

11.2 Test Procedures58

11.3 Test Setup Layout58

11.4 Test Result and Data58

12. Maximum Average Output Power60

12.1 Test Limit60

12.2 Test Procedures60

12.3 Test Setup Layout60

12.4 Test Result and Data61

13. Radio Frequency Exposure62

13.1 Applicable Standards62

13.2 EUT Specification62



History of this test report

Report No.	Issue Date	Description
TEFB2002038	Feb. 25, 2021	Original



1. Summary of Test Procedure and Test Results

1.1 Applicable Standards

ANSI C63.10:2013

FCC Rules and Regulations Part 15 Subpart C §15.247

FCC Rule	Description of Test	Result
15.203	. Antenna Requirement	PASS
15.207	. AC Power Line Conducted Emission	PASS
15.209 15.205	. Radiated Spurious Emission	PASS
15.247(d)	. Conducted Spurious Emission	PASS
15.247(a)(1)	. Channel Carrier Frequencies Separation	PASS
15.247(a)(1)	. 20dB Bandwidth	PASS
15.247(a)(1)	. Dwell Time	PASS
15.247(b)	. Number of Hopping Channels	PASS
15.247(b)	. Output Power	PASS

* The lab has reduced the uncertainty risk factor from test equipment, environment and staff technicians which according to the standard on contract. Therefore, the test result will only be determined by standard requirement.

*This EUT has been also tested and compiled with the requirement of FCC Part 15, Subpart B, recorded in a separate test report(TEFD2002038).



2. Test Configuration of Equipment under Test

2.1 Feature of Equipment under Test

Frequency Range	2402-2480MHz
Modulation Type	GFSK, $\pi/4$ -DQPSK, 8DPSK
Modulation Technology	FHSS
Data Rate	GFSK: 1Mbps, $\pi/4$ -DQPSK: 2Mbps, 8DPSK: 3Mbps
Antenna Type	PCB Antenna
Antenna Gain	2.74dBi
Adapter	Brand: Dongguan Dongsong Electronic Co.,Ltd. Model:DYS836-150200W-K
Audio Cable	Brand: Willcon Model: WH-19C0087
Speaker	Brand: steelseries Model: SP-00001
Firmware Number	2.2.7
Serial Number	61534PVT32472000019

Note: For more details, please refer to the User's manual of the EUT.



2.2 Carrier Frequency of Channes

Channel	Frequency (MHz)	Channel	Frequency (MHz)	Channel	Frequency (MHz)	Channel	Frequency (MHz)
*00	2402	20	2422	40	2442	60	2462
01	2403	21	2423	41	2443	61	2463
02	2404	22	2424	42	2444	62	2464
03	2405	23	2425	43	2445	63	2465
04	2406	24	2426	44	2446	64	2466
05	2407	25	2427	45	2447	65	2467
06	2408	26	2428	46	2448	66	2468
07	2409	27	2429	47	2449	67	2469
08	2410	28	2430	48	2450	68	2470
09	2411	29	2431	49	2451	69	2471
10	2412	30	2432	50	2452	70	2472
11	2413	31	2433	51	2453	71	2473
12	2414	32	2434	52	2454	72	2474
13	2415	33	2435	53	2455	73	2475
14	2416	34	2436	54	2456	74	2476
15	2417	35	2437	55	2457	75	2477
16	2418	36	2438	56	2458	76	2478
17	2419	37	2439	57	2459	77	2479
18	2420	38	2440	58	2460	*78	2480
19	2421	*39	2441	59	2461	---	---

Note: Channels remarked * are selected to perform test.



2.3 Test Mode & Test Software

- During testing, the interface cables and equipment positions were varied according to ANSI C63.10
- The complete test system included Notebook and EUT for RF test.
- An executive program, "Airoha AB152xS LAB Test Tool ver.2.1.0.13699" under Windows OS system was executed to transmit and receive data via Bluetooth.
- The following test modes were performed for the test:

Conducted Emissions from the AC mains power ports	
Test Mode	Operating Description
1	GFSK (1Mbps) AC 120V
2	$\pi/4$ -DQPSK (2Mbps) AC 120V,
3	8DPSK (3Mbps) AC 120V,
4	GFSK (1Mbps) AC 240V
5	$\pi/4$ -DQPSK (2Mbps) AC 240V,
6	8DPSK (3Mbps) AC 240V,
caused "Test Mode 3" generated the worst case, it was reported as the final data.	
Radiation Emissions (9KHz ~ 30MHz and 30MHz ~ 1GHz)	
Test Mode	Operating Description
1	GFSK (1Mbps) AC 120V
2	$\pi/4$ -DQPSK (2Mbps) AC 120V
3	8DPSK (3Mbps) AC 120V
4	GFSK (1Mbps) AC 240V
5	$\pi/4$ -DQPSK (2Mbps) AC 240V,
6	8DPSK (3Mbps) AC 240V,
caused "Test Mode 3" generated the worst case, it was reported as the final data.	
Radiation Emissions (1GHz ~ 25GHz)	
Test Mode	Operating Description
1	GFSK (1Mbps) AC 120V
2	$\pi/4$ -DQPSK (2Mbps) AC 120V
3	8DPSK (3Mbps) AC 120V
caused "Test Mode 1, 3" generated the worst case, they were reported as the final data.	

Modulation Type	TX CONFIGURATION
GFSK	1TX
$\pi/4$ -DQPSK	1TX
8DPSK	1TX



2.4 Description of Test System

RF Conducted				
Equipment	Brand	Model	Length/Type	Power cord/Length/Type
Notebook	DELL	Vostro 3560	N/A	Adapter / 1.8m / NS
USB Cable	BENEVO	BUSB3100AMF	1m / NS	
Test fixture	AIROHA	USB TO UART_0V0	N/A	N/A
Radiated Emissions				
Equipment	Brand	Model	Length/Type	Power cord/Length/Type
Notebook	ASUS	P2430U	N/A	Adapter / 1.8m / NS
USB Cable	BENEVO	BUSB3100AMF	1m / NS	
Earphone	Apple	Earpods	1.2m / NS	N/A
Mobile Phone	SAMSUNG	GT-I9500	NA	NA
Test fixture	AIROHA	USB TO UART_0V0	N/A	N/A
AC Power Line Conducted Emission				
Equipment	Brand	Model	Length/Type	Power cord/Length/Type
Notebook	ASUS	P2430U	N/A	Adapter / 1.8m / NS
USB Cable	BENEVO	BUSB3100AMF	1m / NS	
Earphone	Apple	Earpods	1.2m / NS	N/A
Mobile Phone	SAMSUNG	GT-I9500	NA	NA
Test fixture	AIROHA	USB TO UART_0V0	N/A	N/A



2.5 General Information of Test

Test Site	Cerpass Technology Corporation Test Laboratory Address: No.10, Ln. 2, Lianfu St., Luzhu Dist., Taoyuan City 33848, Taiwan (R.O.C.) Tel:+886-3-3226-888 Fax:+886-3-3226-881	
	FCC	TW1439, TW1079
	IC	4934E-1, 4934E-2
	VCCI	T-2205 for Telecommunication test C-4663 for Conducted emission test R-4218 for Radiated emission test G-10812, G-10813 for radiated disturbance above 1GHz
Frequency Range Investigated:	Conducted: from 150kHz to 30 MHz Radiation: from 30 MHz to 25,000MHz	
Test Distance:	The test distance of radiated emission from antenna to EUT is 3 M.	

Test Item	Test Site	Test period	Environmental Conditions	Tested By
RF Conducted	RFCON01-NK	2020/06/16	22°C / 61%	Vic Yeh
Radiated Emissions	3M02-NK	2021/02/17~2021/02/19	20~22°C / 48~49%	Leon Huang
AC Power Line Conducted Emission	CON01-NK	2021/02/18	22°C / 47%	Leon Huang

2.6 Measurement Uncertainty

Measurement Item	Uncertainty
AC Power Line Conduction(150K~30MHz)	±3.63dB
Radiated Spurious Emission(9KHz~30MHz)	±3.404dB
Radiated Spurious Emission(30MHz~1GHz)	±5.686dB
Radiated Spurious Emission(1GHz~25GHz)	±6.597dB
Conducted Spurious Emission	±2.022dB
6dB Bandwidth	±4.482%
20dB Bandwidth	±4.40%
Occupied Bandwidth	±4.40%
Peak Output Power(Conducted Power Meter)	±1.02dB
Dwell Time	±3.49%
Power Spectral Density	±1.963dB
Duty Cycle	±3.47%



3. Test Equipment and Ancillaries Used for Tests

Test Item	Radiated Emissions				
Test Site	Semi Anechoic Room(3M02-NK)				
Instrument	Manufacturer	Model No	Serial No	Calibration Date	Valid Date
Bilog Antenna	Schwarzbeck	VULB9168	369	2020/04/10	2021/04/09
Active Loop Antenna	EMCO	6507	40855	2020/05/21	2021/05/20
Horn Antenna	EMCO	3115	31601	2020/10/16	2021/10/15
Horn Antenna	EMCO	3116	31970	2020/03/26	2021/03/25
EMI Receiver	ROHDE & SCHWARZ	ESCI	101423	2020/06/23	2021/06/22
Spectrum Analyzer	ROHDE & SCHWARZ	FSV 40-N	102151	2020/08/03	2021/08/02
Preamplifier	EM Electronics corp.	EM330	60660	2020/03/16	2021/03/15
Preamplifier	Agilent	8449B	3008A01954	2020/03/16	2021/03/15
Preamplifier	EMC INSTRUMENTS	EMC184045	980065	2020/11/06	2021/11/05
Bluetooth Tester	ROHDE & SCHWARZ	CBT	101133	2020/04/07	2021/04/06
Cable-3in1(30M-1G)	HARBOUR INDUSTRIES	LL142	CCE1315	2020/04/09	2021/04/08
Cable-0.5m(1G-18G)	HUBER SUHNER	SUCOFLEX 100	805443/4	2020/05/27	2021/05/26
Cable-3m(1G-18G)	HUBER SUHNER	SUCOFLEX 100	805796/4	2020/05/27	2021/05/26
Cable-8m(1G-18G)	HUBER SUHNER	SUCOFLEX 100	805795/4	2020/05/27	2021/05/26
Cable-0.5m(30M-40G)	HUBER SUHNER	SUCOFLEX 102	28420/2	2020/04/01	2021/03/31
Cable-3m(30M-40G)	HUBER SUHNER	SUCOFLEX 102	MY2608/2	2020/04/01	2021/03/31
Cable-0.5m(1G-40G)	Rapidtek	40GHZ 50CM	38MS-38MS50314	2020/04/09	2021/04/08
Cable-6m(9k~300M)	NA	EMC5D-BM-BM-6	130605	2020/09/18	2021/09/17
E3	AUDIX	v8.2014-8-6	RK-000529	NA	NA

Test Item	RF Conducted				
Test Site	RFCON01-NK				
Instrument	Manufacturer	Model No	Serial No	Calibration Date	Valid Date
Spectrum Analyzer	ROHDE & SCHWARZ	FSP 40	100219	2019/07/22	2020/07/21
Spectrum Analyzer	ROHDE & SCHWARZ	FSV 40-N	102151	2019/08/02	2020/08/01
Bluetooth Tester	ROHDE & SCHWARZ	CBT	101133	2020/04/07	2021/04/06
CAX Signal Analyzer	KEYSIGHT	N9000B	MY57100339	2019/11/25	2020/11/24
Attenuator	KEYSIGHT	8491B	MY39250703	2020/04/17	2021/04/16
TEMP & HUMID CHAMBER	T-MACHINE	TMJ-9712	T-12-040111	2019/08/28	2020/08/27
Power Meter	Anritsu	ML2495A	1224005	2020/04/17	2021/04/16
Power Sensor	Anritsu	MA2411B	1207295	2020/04/17	2021/04/16



Test Item	AC Power Line Conducted Emission				
Test Site	CON01-NK				
Instrument	Manufacturer	Model No	Serial No	Calibration Date	Valid Date
EMI Receiver	ROHDE & SCHWARZ	ESCI	100443	2020/05/25	2021/05/24
Line Impedance Stabilization Network	Schwarzbeck	NSLK 8127	8127-568	2020/03/12	2021/03/11
Pulse Limiter	ROHDE & SCHWARZ	ESH3-Z2	101934	2020/03/11	2021/03/10
Cable-6m(9k~300M)	NA	CFD300-NL	NA	2020/03/11	2021/03/10
E3	AUDIX	v8.2014-8-6	RK-000531	NA	NA



4. Antenna Requirements

4.1 Standard Applicable

For intentional device, according to FCC 47 CFR Section 15.203, an intentional radiator shall be designed to ensure that no antenna other than that furnished by the responsible party shall be used with the device.

And according to FCC 47 CFR Section 15.247 (b), if transmitting antennas of directional gain greater than 6dBi are used, the power shall be reduced by the amount in dB that the directional gain of the antenna exceeds 6dBi.

4.2 Antenna Construction and Directional Gain

Antenna Type	PCB Antenna
Antenna Gain	2.74 dBi



5. Test of AC Power Line Conducted Emission

5.1 Test Limit

Conducted Emissions were measured from 150 kHz to 30 MHz with a bandwidth of 9 KHz, according to the methods defined in ANSI C63.4-2014. The EUT was placed on a nonmetallic stand in a shielded room 0.8 meters above the ground plane. The interface cables and equipment positioning were varied within limits of reasonable applications to determine the position produced maximum conducted emissions.

Frequency (MHz)	Quasi Peak (dB μ V)	Average (dB μ V)
0.15 – 0.5	66-56*	56-46*
0.5 – 5.0	56	46
5.0 – 30.0	60	50

*Decreases with the logarithm of the frequency.

5.2 Test Procedures

- The EUT was placed 0.4 meter from the conducting wall of the shielding room was kept at least 80 centimeters from any other grounded conducting surface.
- Connect EUT to the power mains through a line impedance stabilization network (LISN).
- All the support units are connecting to the other LISN.
- The LISN provides 50 ohm coupling impedance for the measuring instrument.
- The FCC states that a 50 ohm, 50 micro-Henry LISN should be used.
- Both sides of AC line were checked for maximum conducted interference.
- The frequency range from 150 kHz to 30 MHz was searched.
- Set the test-receiver system to Peak Detect Function and Specified Bandwidth with Maximum Hold Mode.



5.3 Typical Test Setup

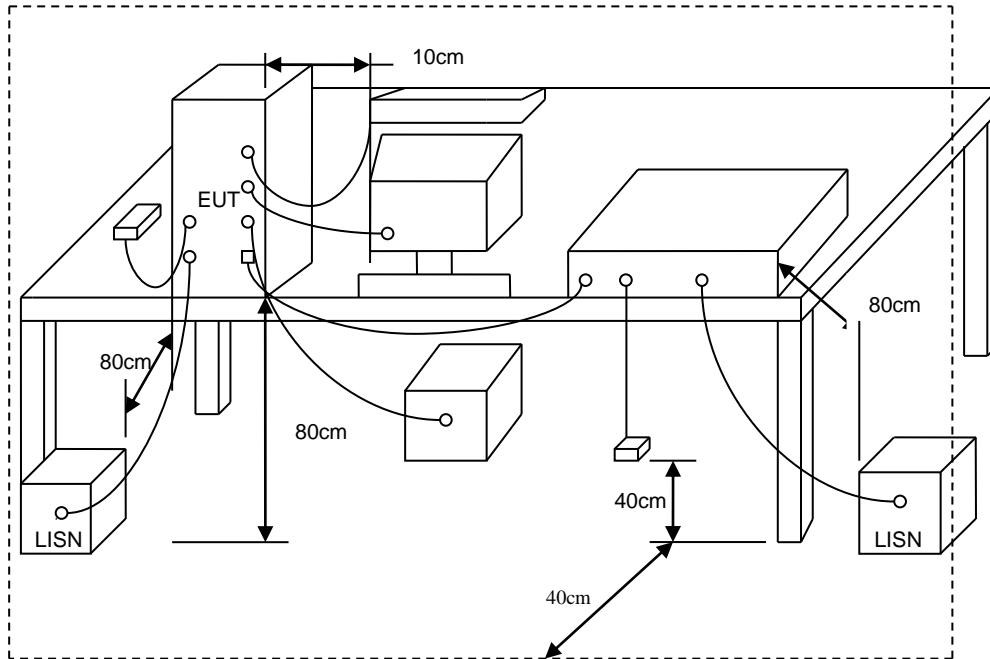



5.4 Test Result and Data

Power	: AC 120V / 60HZ	Pol/Phase	: LINE
Test Mode	: Mode 3		

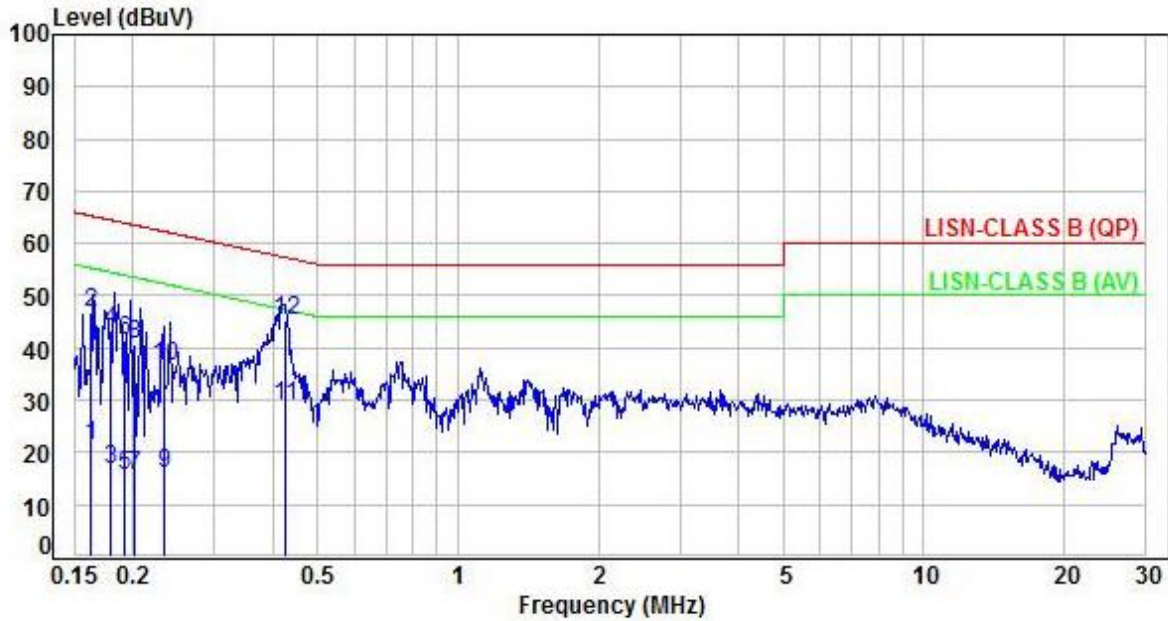

No.	Frequency (MHz)	Factor (dB)	Reading (dBuV)	Level (dBuV)	Limit (dBuV)	Margin (dB)	Detector	P/F
1	0.16	10.03	11.36	21.39	55.35	-33.96	Average	P
2	0.16	10.03	36.91	46.94	65.35	-18.41	QP	P
3	0.18	10.03	6.85	16.88	54.49	-37.61	Average	P
4	0.18	10.03	33.33	43.36	64.49	-21.13	QP	P
5	0.19	10.03	5.68	15.71	53.92	-38.21	Average	P
6	0.19	10.03	31.44	41.47	63.92	-22.45	QP	P
7	0.20	10.03	5.67	15.70	53.53	-37.83	Average	P
8	0.20	10.03	30.64	40.67	63.53	-22.86	QP	P
9	0.23	10.03	5.78	15.81	52.29	-36.48	Average	P
10	0.23	10.03	26.59	36.62	62.29	-25.67	QP	P
11	0.42	10.05	18.76	28.81	47.37	-18.56	Average	P
12	0.42	10.05	35.31	45.36	57.37	-12.01	QP	P

Note: Level=Reading+Factor
 Margin=Level-Limit
 Factor=(LISN or ISN or Current Probe)Factor + Cable Loss



Power	: AC 120V / 60HZ	Pol/Phase	: NEUTRAL
Test Mode	: Mode 3		:

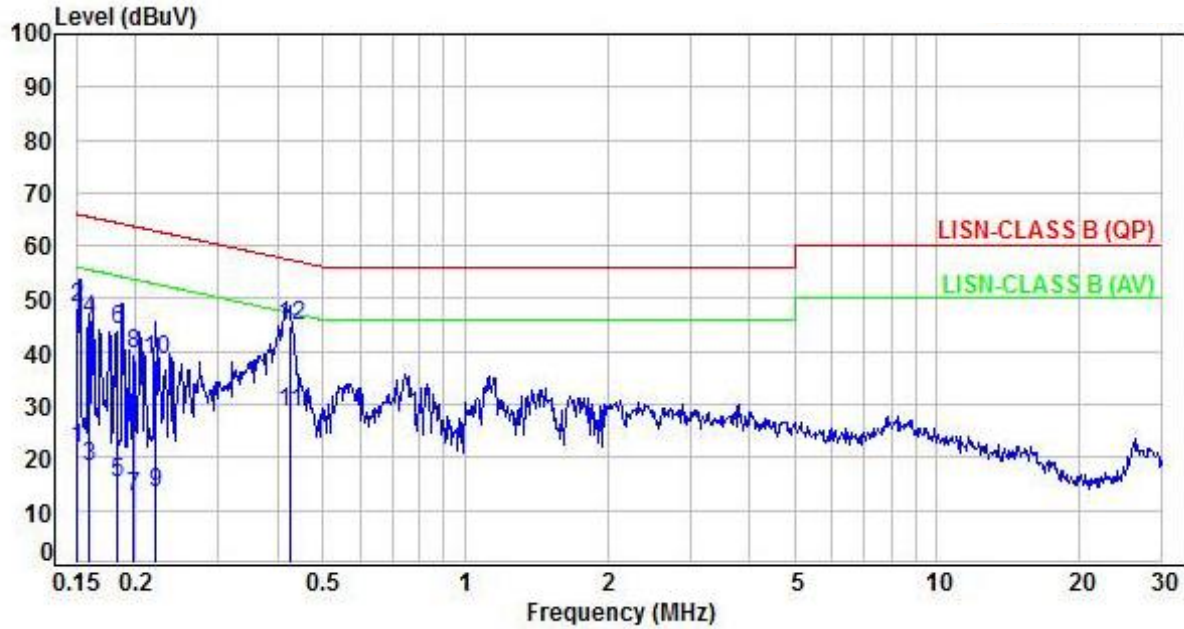

No.	Frequency (MHz)	Factor (dB)	Reading (dBuV)	Level (dBuV)	Limit (dBuV)	Margin (dB)	Detector	P/F
1	0.15	10.00	11.79	21.79	55.99	-34.20	Average	P
2	0.15	10.00	38.17	48.17	65.99	-17.82	QP	P
3	0.16	10.00	8.28	18.28	55.46	-37.18	Average	P
4	0.16	10.00	36.17	46.17	65.46	-19.29	QP	P
5	0.18	10.00	5.29	15.29	54.36	-39.07	Average	P
6	0.18	10.00	34.03	44.03	64.36	-20.33	QP	P
7	0.20	10.00	2.60	12.60	53.68	-41.08	Average	P
8	0.20	10.00	29.55	39.55	63.68	-24.13	QP	P
9	0.22	10.00	3.42	13.42	52.79	-39.37	Average	P
10	0.22	10.00	28.36	38.36	62.79	-24.43	QP	P
11	0.42	10.02	18.50	28.52	47.36	-18.84	Average	P
12	0.42	10.02	35.02	45.04	57.36	-12.32	QP	P

Note: Level=Reading+Factor
Margin=Level-Limit
Factor=(LISN or ISN or Current Probe)Factor + Cable Loss



6. Test of Radiated Spurious Emission

6.1 Test Limit

In any 100kHz bandwidth outside the frequency band in which the spread spectrum or digitally modulated intentional radiator is operating, the radio frequency power that is produced by the intentional radiator shall be at least 20dB below that in the 100kHz bandwidth within the band that contains the highest level of the desired power, based on either an RF conducted or a radiated measurement. If the transmitter measurement is based on the maximum conducted output power, the attenuation required under this paragraph shall be 30dB instead of 20dB. In addition, radiated emissions which fall in section 15.205(a) the restricted bands must also comply with the radiated emission limit specified in section 15.209(a).

Frequency (MHz)	Field Strength (microvolt/meter)	Measurement Distance (meters)
0.009 ~ 0.490	2400/F(kHz)	300
0.490 ~ 1.705	24000/F(kHz)	30
1.705 ~ 30.0	30	30
30 ~ 88	100	3
88 ~ 216	150	3
216 ~ 960	200	3
Above 960	500	3

6.2 Test Procedures

- The EUT was placed on a rotatable table top 0.8 meter above ground.
- The EUT was set 3 meters from the interference receiving antenna which was mounted on the top of a variable height antenna tower.
- The table was rotated 360 degrees to determine the position of the highest radiation.
- The antenna is a broadband antenna and its height is varied between one meter and four meters above ground to find the maximum value of the field strength both horizontal polarization and vertical polarization of the antenna are set to make the measurement.
- For each suspected emission the EUT was arranged to its worst case and then tune the antenna tower (from 1 M to 4 M) and turn table (from 0 degree to 360 degrees) to find the maximum reading.
- Set the test-receiver system to Peak or CISPR quasi-peak Detect Function and specified bandwidth with Maximum Hold Mode.
- If the emission level of the EUT in peak mode was 3 dB lower than the limit specified, then testing will be stopped and peak values of EUT will be reported, otherwise, the emissions which do not have 3 dB margin will be repeated one by one using the quasi-peak method and reported.
- For testing above 1GHz, the emission level of the EUT in peak mode was 20dB lower than average limit (that means the emission level in peak mode also complies with the limit in average mode), then testing will be stopped and peak values of EUT will be reported, otherwise, the emissions will be measured in average mode again and reported.
- “Cone of radiation” has been considered to be 3dB bandwidth of the measurement antenna.

Note: The supporting fixture shall permit orientation of the EUT in each of three orthogonal axis positions such that emissions from the EUT are maximized.



6.3 Typical Test Setup

Below 30MHz test setup

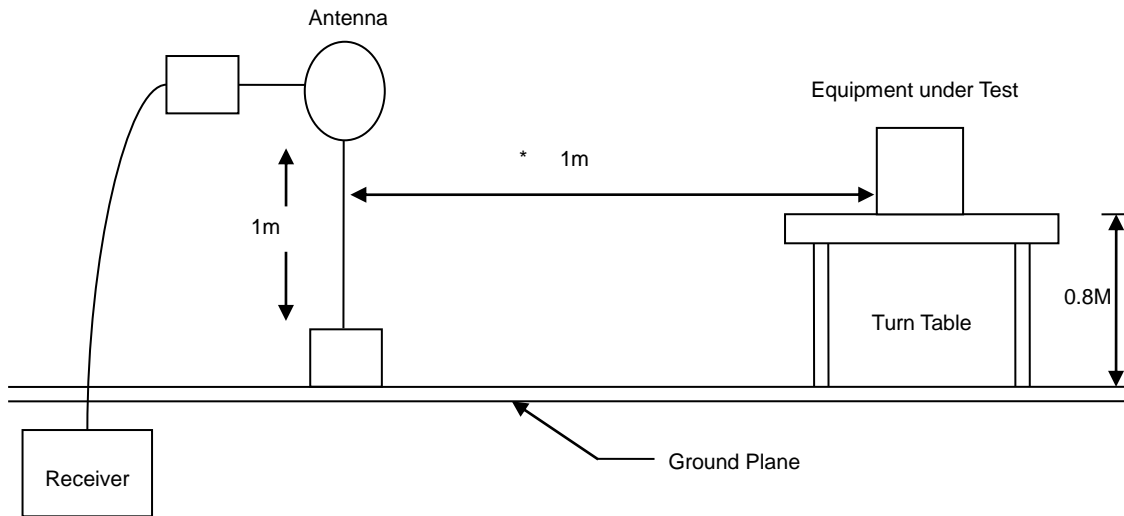

30MHz- 1GHz Test Setup

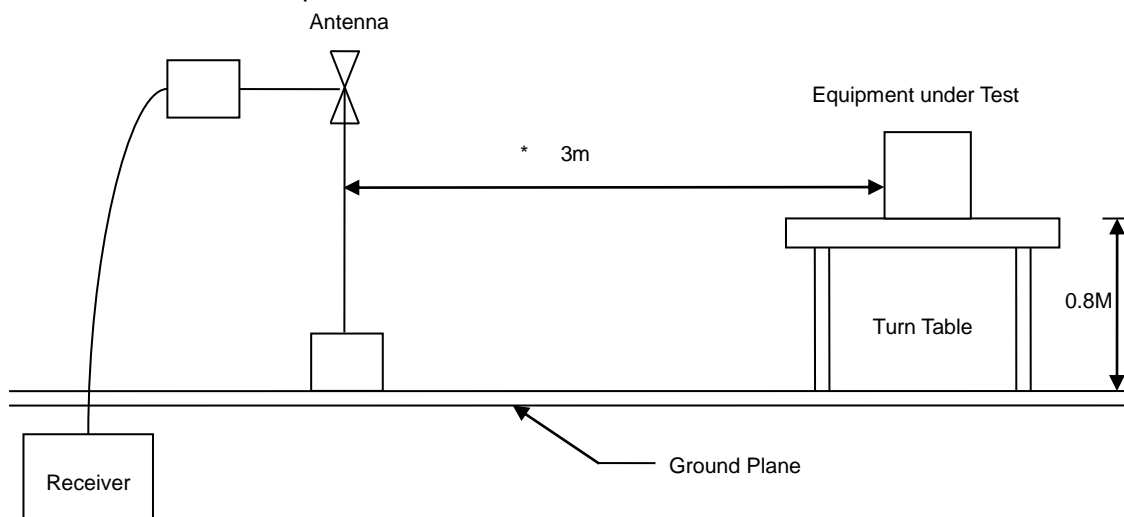

Above 1GHz Test Setup

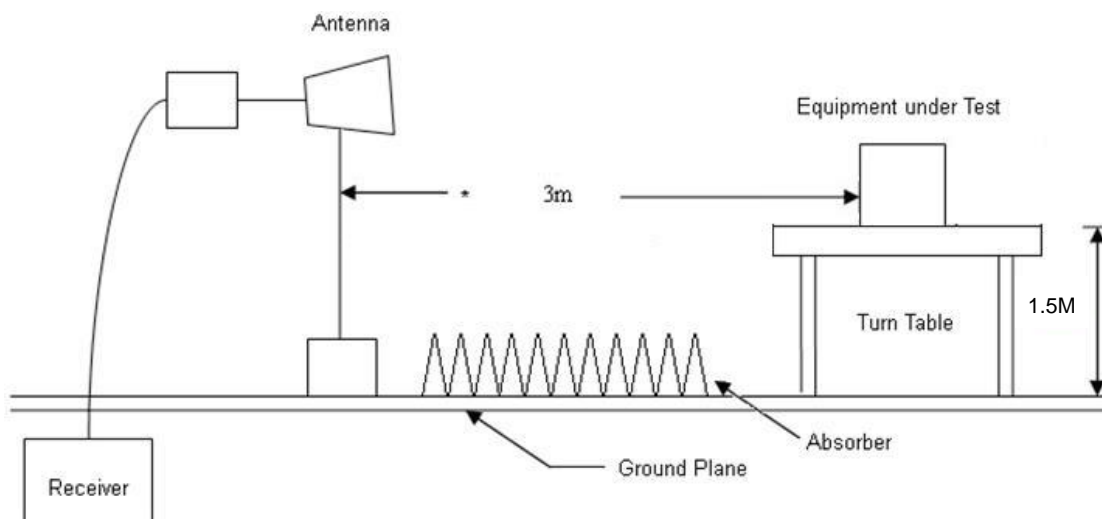



6.4 Test Result and Data (9kHz ~ 30MHz)

The 9kHz-30MHz spurious emission is under limit 20dB more.

6.5 Test Result and Data (30MHz ~ 1GHz)

Power	: AC 120V / 60HZ	Pol/Phase	: VERTICAL
Test Mode	: Mode 3		:

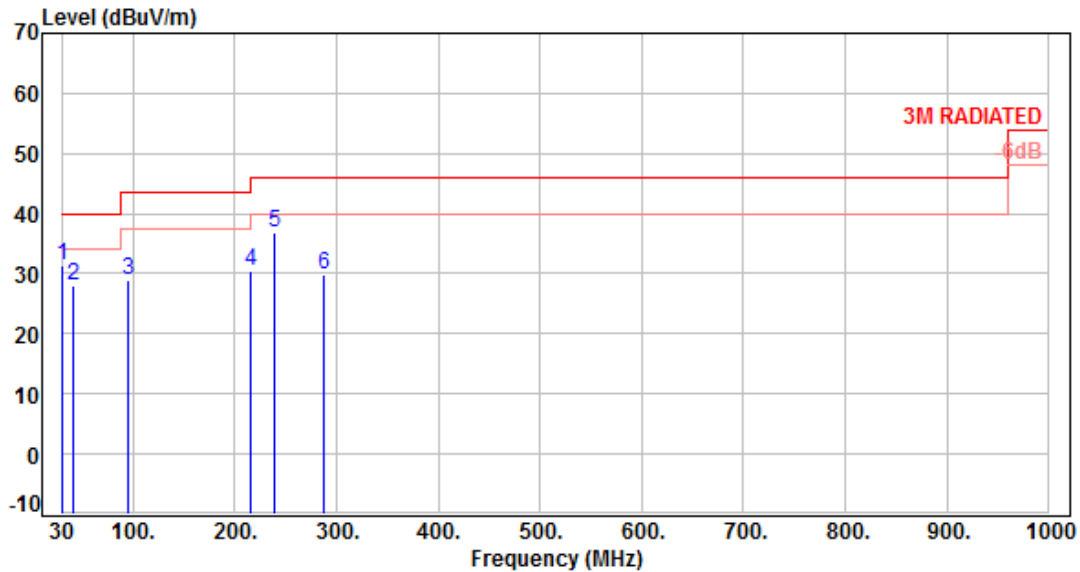

No.	Frequency (MHz)	Factor (dB)	Reading (dBuV)	Level (dBuV/m)	Limit (dBuV/m)	Margin (dB)	Detector	Height (cm)	Azimuth (deg)	P/F
1	30.00	-10.42	41.65	31.23	40.00	-8.77	Peak	400	0	P
2	40.67	-9.80	37.68	27.88	40.00	-12.12	Peak	400	0	P
3	95.96	-15.17	44.16	28.99	43.50	-14.51	Peak	400	0	P
4	216.24	-12.02	42.41	30.39	46.00	-15.61	Peak	400	0	P
5	239.52	-10.66	47.61	36.95	46.00	-9.05	Peak	400	0	P
6	288.02	-8.83	38.78	29.95	46.00	-16.05	Peak	400	0	P

Note: Level=Reading+Factor
Margin=Level-Limit
Factor=Antenna Factor + cable loss - Amplifier Factor



Power	: AC 120V / 60HZ	Pol/Phase	: HORIZONTAL
Test Mode	: Mode 3		:

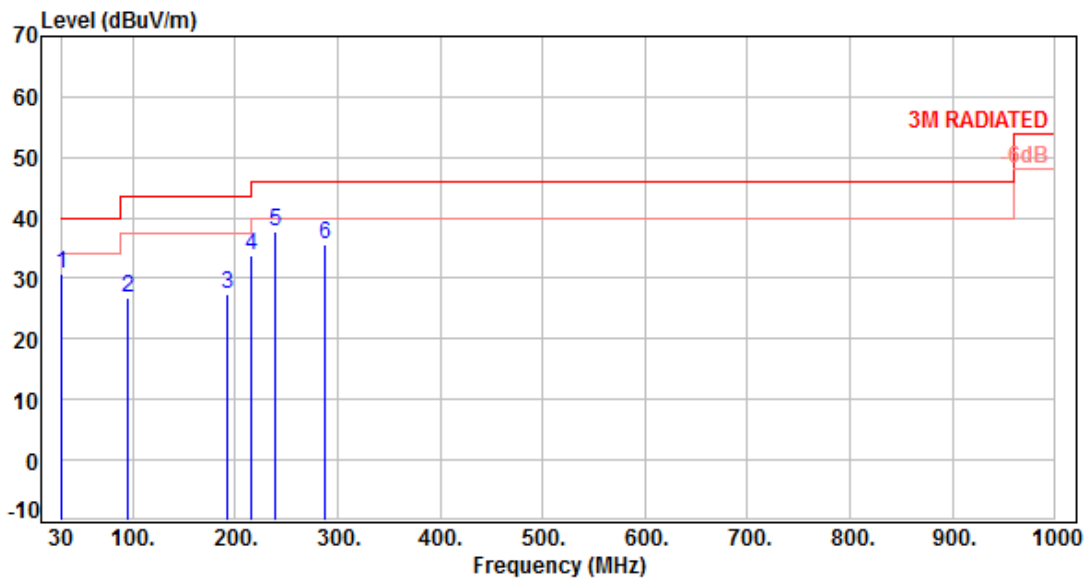

No.	Frequency (MHz)	Factor (dB)	Reading (dBuV)	Level (dBuV/m)	Limit (dBuV/m)	Margin (dB)	Detector	Height (cm)	Azimuth (deg)	P/F
1	30.00	-10.42	41.14	30.72	40.00	-9.28	Peak	100	0	P
2	95.96	-15.17	42.04	26.87	43.50	-16.63	Peak	100	0	P
3	191.99	-11.84	39.34	27.50	43.50	-16.00	Peak	100	0	P
4	216.24	-12.02	45.88	33.86	46.00	-12.14	Peak	100	0	P
5	239.52	-10.66	48.49	37.83	46.00	-8.17	Peak	100	0	P
6	288.02	-8.83	44.31	35.48	46.00	-10.52	Peak	100	0	P

Note: Level=Reading+Factor
Margin=Level-Limit
Factor=Antenna Factor + cable loss - Amplifier Factor



6.6 Test Result and Data (1GHz ~ 25GHz)

Power	: AC 120V / 60HZ	Pol/Phase	: VERTICAL
Test Mode	: Mode 1, CH00		

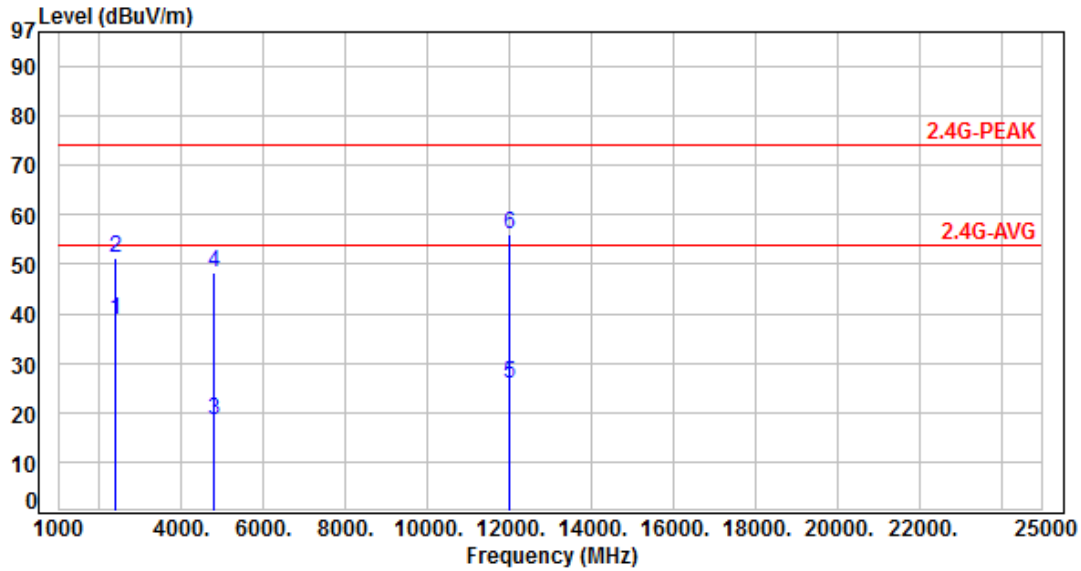

No.	Frequency (MHz)	Factor (dB)	Reading (dBuV)	Level (dBuV/m)	Limit (dBuV/m)	Margin (dB)	Detector	Height (cm)	Azimuth (deg)	P/F
1	2390.00	-2.89	41.63	38.74	54.00	-15.26	Average	100	172	P
2	2390.00	-2.89	54.20	51.31	74.00	-22.69	Peak	100	172	P
3	4804.00	4.67	13.64	18.31	54.00	-35.69	Average	100	240	P
4	4804.00	4.67	43.74	48.41	74.00	-25.59	Peak	100	240	P
5	12010.00	14.75	11.23	25.98	54.00	-28.02	Average	100	175	P
6	12010.00	14.75	41.33	56.08	74.00	-17.92	Peak	100	175	P

Note: Level=Reading+Factor
Margin=Level-Limit
Factor=Antenna Factor + cable loss - Amplifier Factor



Power	: AC 120V / 60HZ	Pol/Phase	: HORIZONTAL
Test Mode	: Mode 1, CH00		:

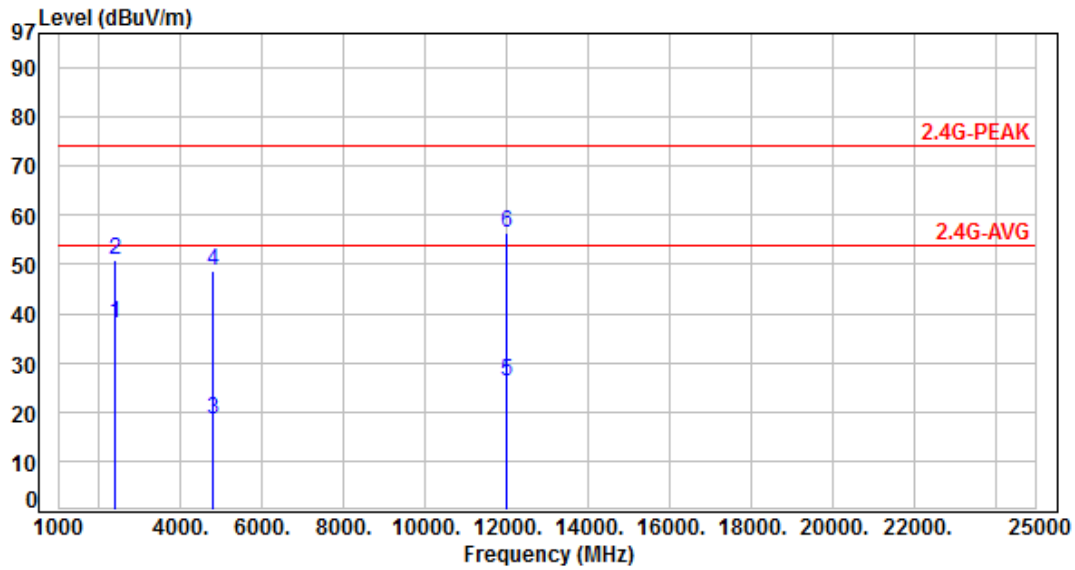

No.	Frequency (MHz)	Factor (dB)	Reading (dBuV)	Level (dBuV/m)	Limit (dBuV/m)	Margin (dB)	Detector	Height (cm)	Azimuth (deg)	P/F
1	2390.00	-2.89	40.74	37.85	54.00	-16.15	Average	100	135	P
2	2390.00	-2.89	53.91	51.02	74.00	-22.98	Peak	100	135	P
3	4804.00	4.67	13.93	18.60	54.00	-35.40	Average	270	200	P
4	4804.00	4.67	44.03	48.70	74.00	-25.30	Peak	270	200	P
5	12010.00	14.75	11.59	26.34	54.00	-27.66	Average	100	163	P
6	12010.00	14.75	41.69	56.44	74.00	-17.56	Peak	100	163	P

Note: Level=Reading+Factor
 Margin=Level-Limit
 Factor=Antenna Factor + cable loss - Amplifier Factor



Power	: AC 120V / 60HZ	Pol/Phase	: VERTICAL
Test Mode	: Mode 1, CH39		:

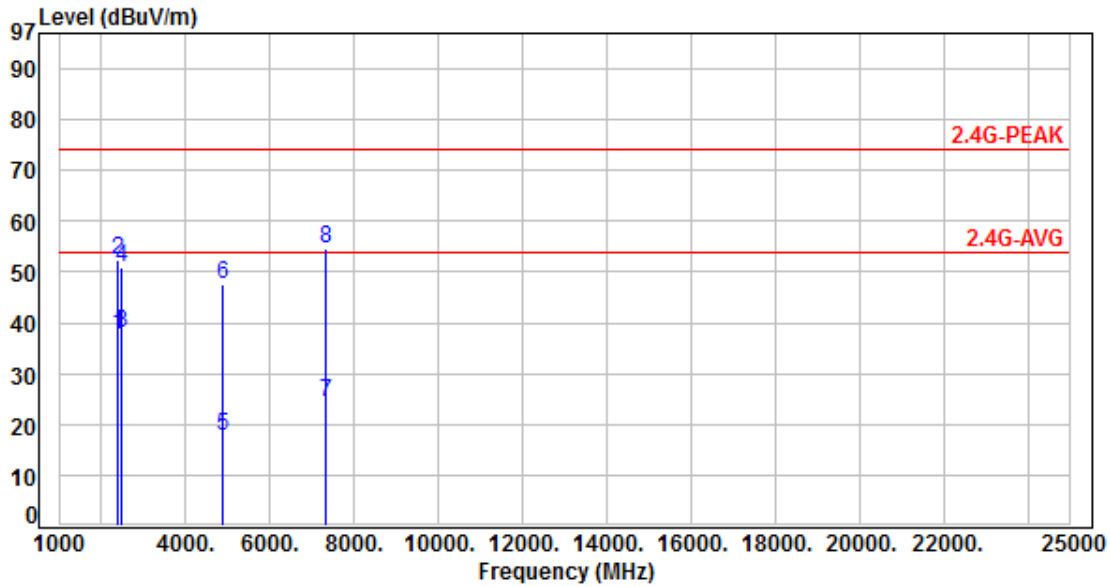

No.	Frequency (MHz)	Factor (dB)	Reading (dBuV)	Level (dBuV/m)	Limit (dBuV/m)	Margin (dB)	Detector	Height (cm)	Azimuth (deg)	P/F
1	2390.00	-2.89	40.44	37.55	54.00	-16.45	Average	100	168	P
2	2390.00	-2.89	55.12	52.23	74.00	-21.77	Peak	100	168	P
3	2483.50	-2.66	40.82	38.16	54.00	-15.84	Average	100	168	P
4	2483.50	-2.66	53.43	50.77	74.00	-23.23	Peak	100	168	P
5	4882.00	4.91	12.67	17.58	54.00	-36.42	Average	100	245	P
6	4882.00	4.91	42.77	47.68	74.00	-26.32	Peak	100	245	P
7	7323.00	9.85	14.65	24.50	54.00	-29.50	Average	100	177	P
8	7323.00	9.85	44.75	54.60	74.00	-19.40	Peak	100	177	P

Note: Level=Reading+Factor
 Margin=Level-Limit
 Factor=Antenna Factor + cable loss - Amplifier Factor



Power	: AC 120V / 60HZ	Pol/Phase	: HORIZONTAL
Test Mode	: Mode 1, CH39		

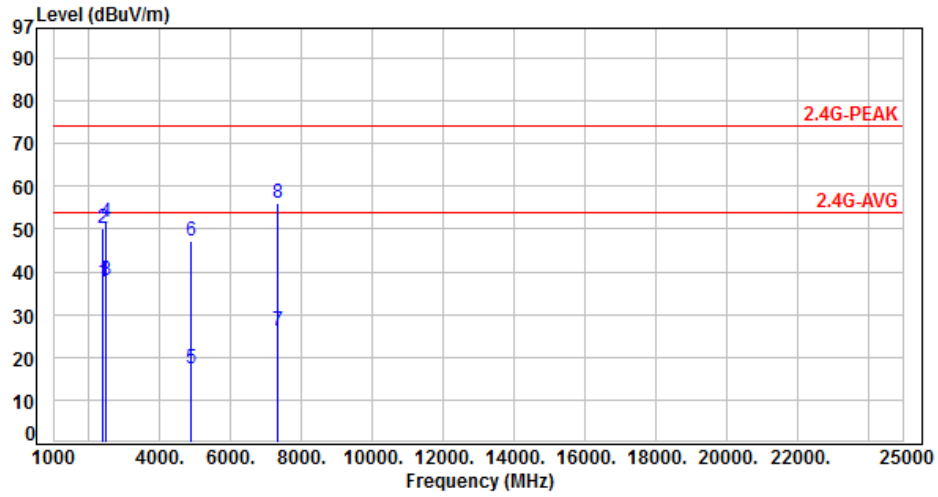

No.	Frequency (MHz)	Factor (dB)	Reading (dBuV)	Level (dBuV/m)	Limit (dBuV/m)	Margin (dB)	Detector	Height (cm)	Azimuth (deg)	P/F
1	2390.00	-2.89	40.64	37.75	54.00	-16.25	Average	100	141	P
2	2390.00	-2.89	53.09	50.20	74.00	-23.80	Peak	100	141	P
3	2483.50	-2.66	40.72	38.06	54.00	-15.94	Average	100	141	P
4	2483.50	-2.66	54.34	51.68	74.00	-22.32	Peak	100	141	P
5	4882.00	4.91	12.29	17.20	54.00	-36.80	Average	270	193	P
6	4882.00	4.91	42.39	47.30	74.00	-26.70	Peak	270	193	P
7	7323.00	9.85	16.21	26.06	54.00	-27.94	Average	150	120	P
8	7323.00	9.85	46.31	56.16	74.00	-17.84	Peak	150	120	P

Note: Level=Reading+Factor
Margin=Level-Limit
Factor=Antenna Factor + cable loss - Amplifier Factor



Power	: AC 120V / 60HZ	Pol/Phase	: VERTICAL
Test Mode	: Mode 1, CH78		:

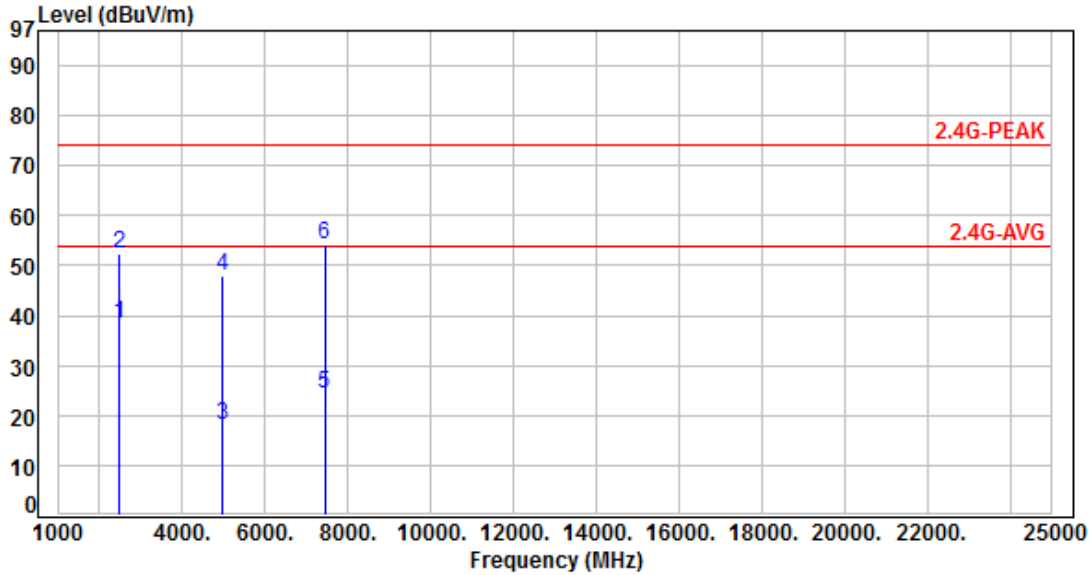

No.	Frequency (MHz)	Factor (dB)	Reading (dBuV)	Level (dBuV/m)	Limit (dBuV/m)	Margin (dB)	Detector	Height (cm)	Azimuth (deg)	P/F
1	2483.50	-2.66	41.20	38.54	54.00	-15.46	Average	100	165	P
2	2483.50	-2.66	54.94	52.28	74.00	-21.72	Peak	100	165	P
3	4960.00	5.26	12.73	17.99	54.00	-36.01	Average	100	241	P
4	4960.00	5.26	42.83	48.09	74.00	-25.91	Peak	100	241	P
5	7440.00	9.96	14.21	24.17	54.00	-29.83	Average	100	169	P
6	7440.00	9.96	44.31	54.27	74.00	-19.73	Peak	100	169	P

Note: Level=Reading+Factor
Margin=Level-Limit
Factor=Antenna Factor + cable loss - Amplifier Factor



Power	: AC 120V / 60HZ	Pol/Phase	: HORIZONTAL
Test Mode	: Mode 1, CH78		:

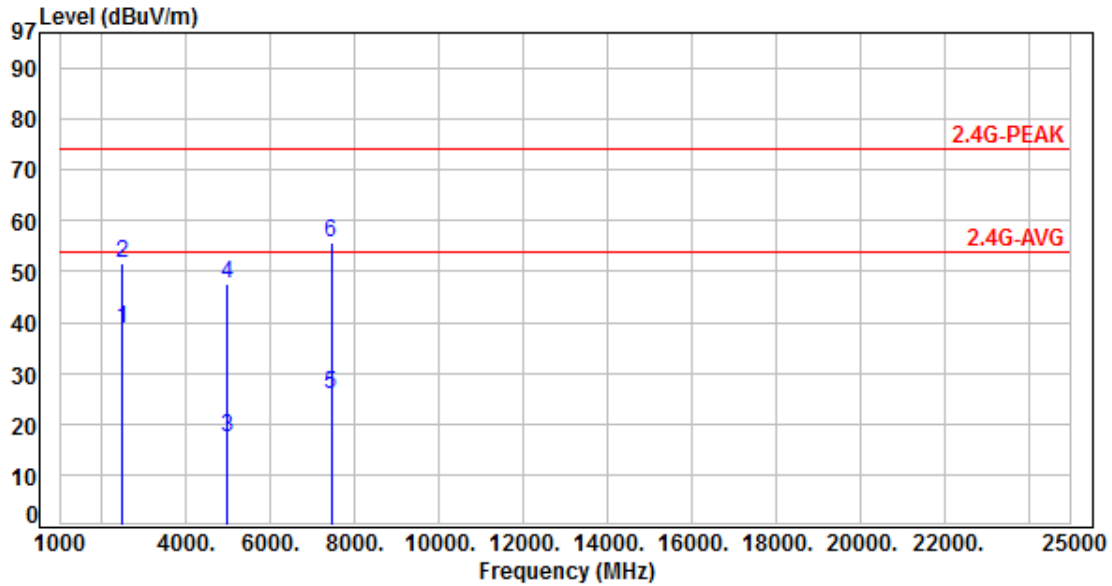

No.	Frequency (MHz)	Factor (dB)	Reading (dBuV)	Level (dBuV/m)	Limit (dBuV/m)	Margin (dB)	Detector	Height (cm)	Azimuth (deg)	P/F
1	2483.50	-2.66	41.24	38.58	54.00	-15.42	Average	100	145	P
2	2483.50	-2.66	54.29	51.63	74.00	-22.37	Peak	100	145	P
3	4960.00	5.26	12.25	17.51	54.00	-36.49	Average	270	191	P
4	4960.00	5.26	42.35	47.61	74.00	-26.39	Peak	270	191	P
5	7440.00	9.96	15.71	25.67	54.00	-28.33	Average	155	127	P
6	7440.00	9.96	45.81	55.77	74.00	-18.23	Peak	155	127	P

Note: Level=Reading+Factor
 Margin=Level-Limit
 Factor=Antenna Factor + cable loss - Amplifier Factor



Power	: AC 120V / 60HZ	Pol/Phase	: VERTICAL
Test Mode	: Mode 3, CH00		:

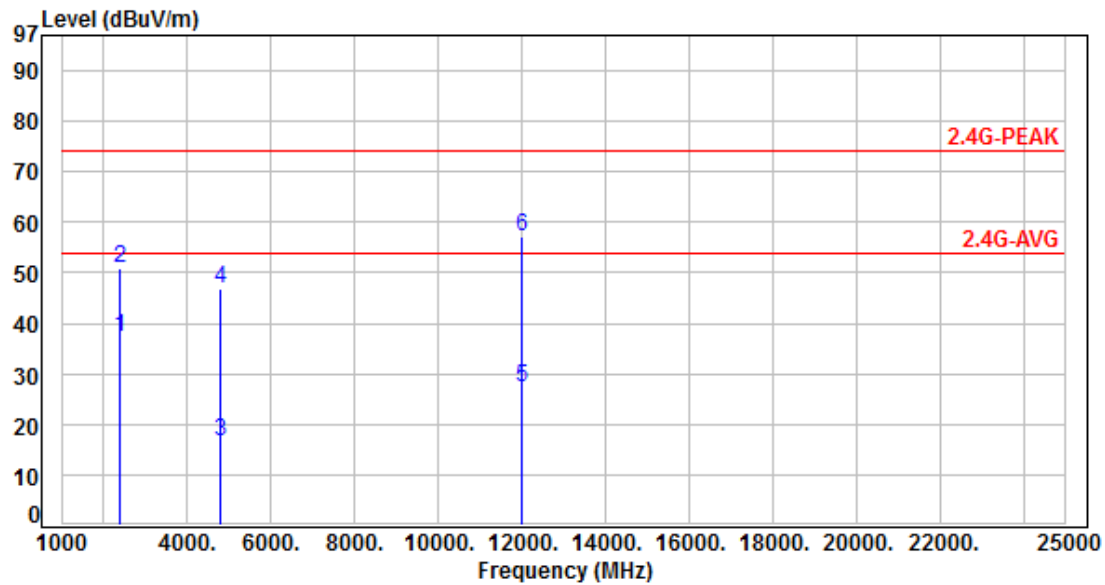

No.	Frequency (MHz)	Factor (dB)	Reading (dBuV)	Level (dBuV/m)	Limit (dBuV/m)	Margin (dB)	Detector	Height (cm)	Azimuth (deg)	P/F
1	2390.00	-2.89	40.24	37.35	54.00	-16.65	Average	100	163	P
2	2390.00	-2.89	53.77	50.88	74.00	-23.12	Peak	100	163	P
3	4804.00	4.67	12.05	16.72	54.00	-37.28	Average	100	243	P
4	4804.00	4.67	42.15	46.82	74.00	-27.18	Peak	100	243	P
5	12010.00	14.75	12.37	27.12	54.00	-26.88	Average	100	178	P
6	12010.00	14.75	42.47	57.22	74.00	-16.78	Peak	100	178	P

Note: Level=Reading+Factor
Margin=Level-Limit
Factor=Antenna Factor + cable loss - Amplifier Factor



Power	: AC 120V / 60HZ	Pol/Phase	: HORIZONTAL
Test Mode	: Mode 3, CH00		:

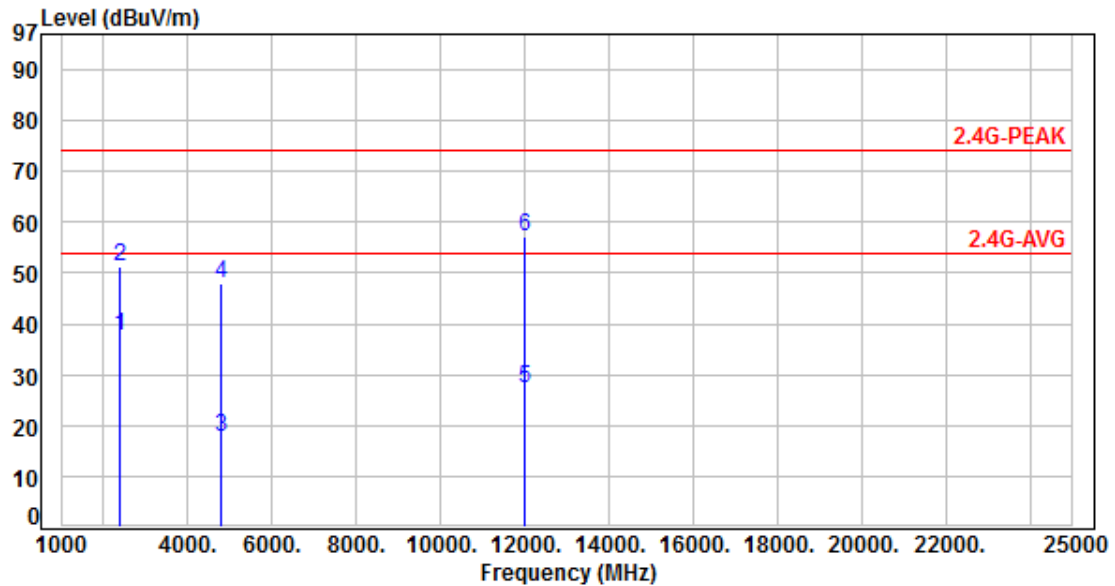

No.	Frequency (MHz)	Factor (dB)	Reading (dBuV)	Level (dBuV/m)	Limit (dBuV/m)	Margin (dB)	Detector	Height (cm)	Azimuth (deg)	P/F
1	2390.00	-2.89	40.66	37.77	54.00	-16.23	Average	100	143	P
2	2390.00	-2.89	54.07	51.18	74.00	-22.82	Peak	100	155	P
3	4804.00	4.67	13.07	17.74	54.00	-36.26	Average	270	195	P
4	4804.00	4.67	43.17	47.84	74.00	-26.16	Peak	270	195	P
5	12010.00	14.75	12.44	27.19	54.00	-26.81	Average	100	165	P
6	12010.00	14.75	42.54	57.29	74.00	-16.71	Peak	100	165	P

Note: Level=Reading+Factor
Margin=Level-Limit
Factor=Antenna Factor + cable loss - Amplifier Factor



Power	: AC 120V / 60HZ	Pol/Phase	: VERTICAL
Test Mode	: Mode 3, CH39		

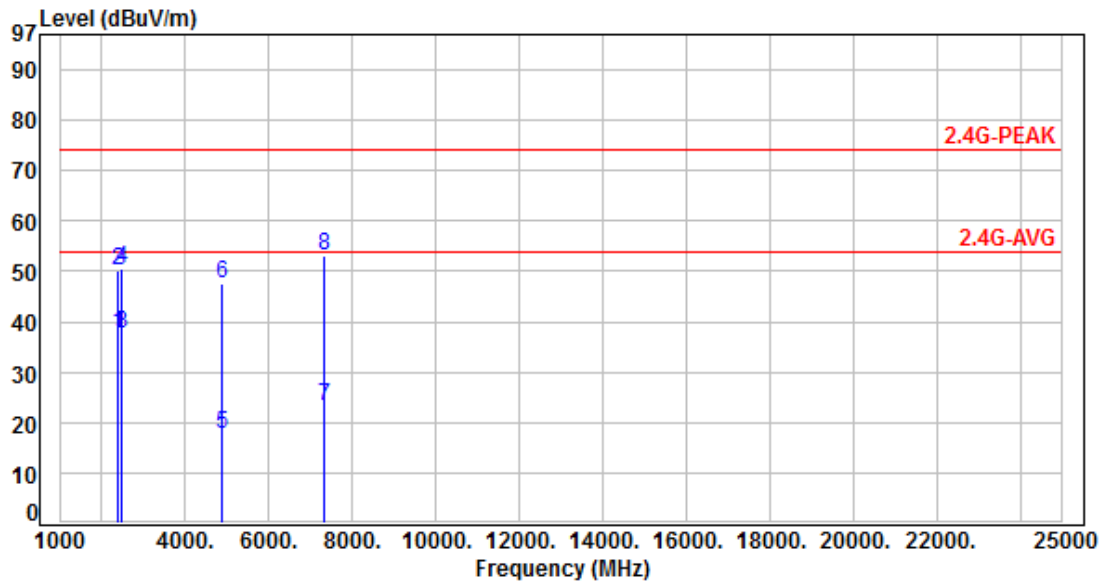

No.	Frequency (MHz)	Factor (dB)	Reading (dBuV)	Level (dBuV/m)	Limit (dBuV/m)	Margin (dB)	Detector	Height (cm)	Azimuth (deg)	P/F
1	2390.00	-2.89	40.50	37.61	54.00	-16.39	Average	100	166	P
2	2390.00	-2.89	52.93	50.04	74.00	-23.96	Peak	100	166	P
3	2483.50	-2.66	40.32	37.66	54.00	-16.34	Average	100	166	P
4	2483.50	-2.66	53.28	50.62	74.00	-23.38	Peak	100	166	P
5	4882.00	4.91	12.73	17.64	54.00	-36.36	Average	100	247	P
6	4882.00	4.91	42.83	47.74	74.00	-26.26	Peak	100	247	P
7	7323.00	9.85	13.34	23.19	54.00	-30.81	Average	100	167	P
8	7323.00	9.85	43.44	53.29	74.00	-20.71	Peak	100	167	P

Note: Level=Reading+Factor
 Margin=Level-Limit
 Factor=Antenna Factor + cable loss - Amplifier Factor



Power	: AC 120V / 60HZ	Pol/Phase	: HORIZONTAL
Test Mode	: Mode 3, CH39		:

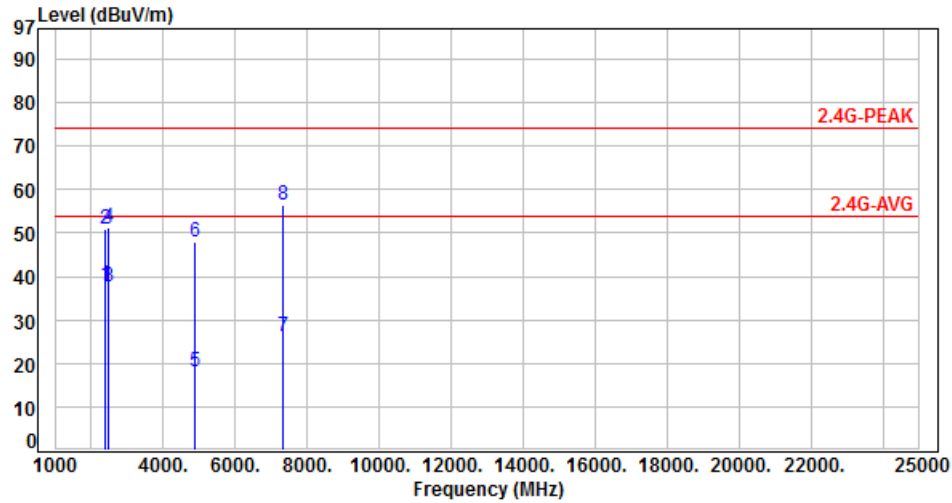

No.	Frequency (MHz)	Factor (dB)	Reading (dBuV)	Level (dBuV/m)	Limit (dBuV/m)	Margin (dB)	Detector	Height (cm)	Azimuth (deg)	P/F
1	2390.00	-2.89	40.83	37.94	54.00	-16.06	Average	100	146	P
2	2390.00	-2.89	53.80	50.91	74.00	-23.09	Peak	100	146	P
3	2483.50	-2.66	40.39	37.73	54.00	-16.27	Average	100	146	P
4	2483.50	-2.66	53.79	51.13	74.00	-22.87	Peak	100	146	P
5	4882.00	4.91	13.03	17.94	54.00	-36.06	Average	275	200	P
6	4882.00	4.91	43.13	48.04	74.00	-25.96	Peak	275	200	P
7	7323.00	9.85	16.45	26.30	54.00	-27.70	Average	145	118	P
8	7323.00	9.85	46.55	56.40	74.00	-17.60	Peak	145	118	P

Note: Level=Reading+Factor
Margin=Level-Limit
Factor=Antenna Factor + cable loss - Amplifier Factor



Power	: AC 120V / 60HZ	Pol/Phase	: VERTICAL
Test Mode	: Mode 3, CH78		:

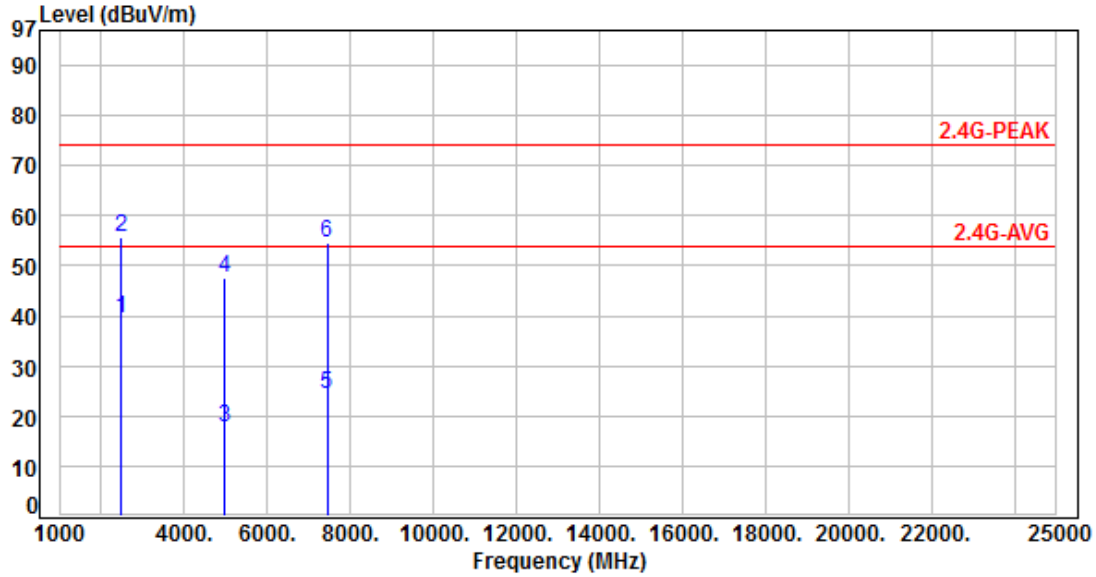

No.	Frequency (MHz)	Factor (dB)	Reading (dBuV)	Level (dBuV/m)	Limit (dBuV/m)	Margin (dB)	Detector	Height (cm)	Azimuth (deg)	P/F
1	2483.50	-2.66	42.10	39.44	54.00	-14.56	Average	100	165	P
2	2483.50	-2.66	58.42	55.76	74.00	-18.24	Peak	100	165	P
3	4960.00	5.26	12.29	17.55	54.00	-36.45	Average	100	245	P
4	4960.00	5.26	42.39	47.65	74.00	-26.35	Peak	100	245	P
5	7440.00	9.96	14.52	24.48	54.00	-29.52	Average	100	168	P
6	7440.00	9.96	44.62	54.58	74.00	-19.42	Peak	100	168	P

Note: Level=Reading+Factor
 Margin=Level-Limit
 Factor=Antenna Factor + cable loss - Amplifier Factor



Power	: AC 120V / 60HZ	Pol/Phase	: HORIZONTAL
Test Mode	: Mode 3, CH78		:

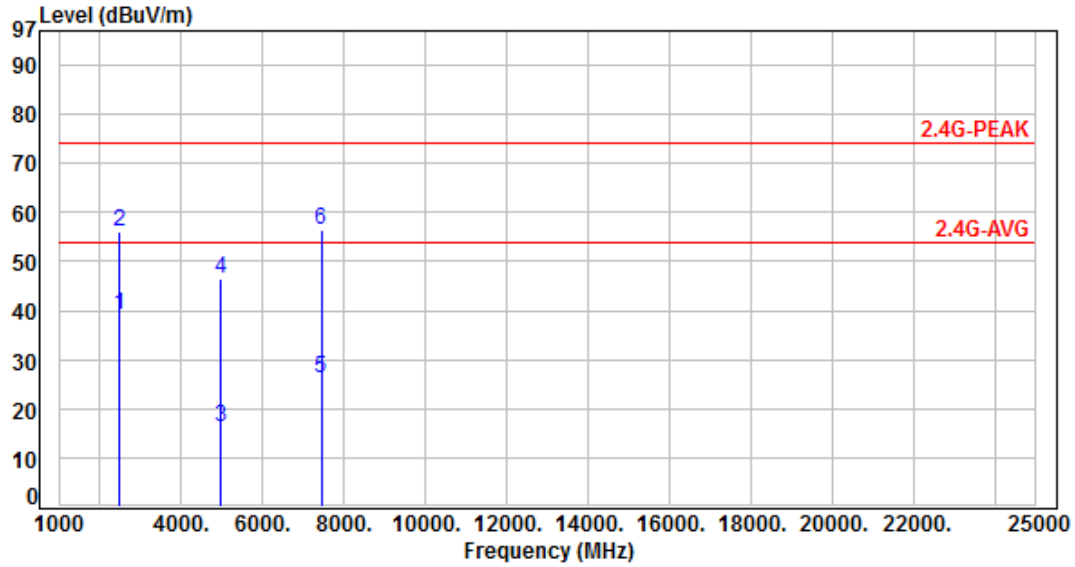

No.	Frequency (MHz)	Factor (dB)	Reading (dBuV)	Level (dBuV/m)	Limit (dBuV/m)	Margin (dB)	Detector	Height (cm)	Azimuth (deg)	P/F
1	2483.50	-2.66	41.77	39.11	54.00	-14.89	Average	100	143	P
2	2483.50	-2.66	58.71	56.05	74.00	-17.95	Peak	100	143	P
3	4960.00	5.26	10.97	16.23	54.00	-37.77	Average	270	199	P
4	4960.00	5.26	41.07	46.33	74.00	-27.67	Peak	270	199	P
5	7440.00	9.96	16.19	26.15	54.00	-27.85	Average	145	123	P
6	7440.00	9.96	46.29	56.25	74.00	-17.75	Peak	145	123	P

Note: Level=Reading+Factor
 Margin=Level-Limit
 Factor=Antenna Factor + cable loss - Amplifier Factor



6.7 Restricted Bands of Operation

Only spurious emissions are permitted in any of the frequency bands listed below:

MHz	MHz	MHz	GHz
0.09000 – 0.11000	16.42000 – 16.42300	399.9 – 410.0	4.500 – 5.250
0.49500 – 0.505**	16.69475 – 16.69525	608.0 – 614.0	5.350 – 5.460
2.17350 – 2.19050	16.80425 – 16.80475	960.0 – 1240.0	7.250 – 7.750
4.12500 – 4.12800	25.50000 – 25.67000	1300.0 – 1427.0	8.025 – 8.500
4.17725 – 4.17775	37.50000 – 38.25000	1435.0 – 1626.5	9.000 – 9.200
4.20725 – 4.20775	73.00000 – 74.60000	1645.5 – 1646.5	9.300 – 9.500
6.21500 – 6.21800	74.80000 – 75.20000	1660.0 – 1710.0	10.600 – 12.700
6.26775 – 6.26825	108.00000 – 121.94000	1718.8 – 1722.2	13.250 – 13.400
6.31175 – 6.31225	123.00000 – 138.00000	2200.0 – 2300.0	14.470 – 14.500
8.29100 – 8.29400	149.90000 – 150.05000	2310.0 – 2390.0	15.350 – 16.200
8.36200 – 8.36600	156.52475 – 156.52525	2483.5 – 2500.0	17.700 – 21.400
8.37625 – 8.38675	156.70000 – 156.90000	2655.0 – 2900.0	22.010 – 23.120
8.41425 – 8.41475	162.01250 – 167.17000	3260.0 – 3267.0	23.600 – 24.000
12.29000 – 12.29300	167.72000 – 173.20000	3332.0 – 3339.0	31.200 – 31.800
12.51975 – 12.52025	240.00000 – 285.00000	3345.8 – 3358.0	36.430 – 36.500
12.57675 – 12.57725	322.00000 – 335.40000	3600.0 – 4400.0	Above 38.6
13.36000 – 13.41000			

** : Until February 1, 1999, this restricted band shall be 0.490-0.510 MHz



7. Test of Conducted Spurious Emission

7.1 Test Limit

Below -30dB of the highest emission level of operating band (in 100kHz Resolution Bandwidth).

7.2 Test Procedure

- a. The transmitter output was connected to the spectrum analyzer via a low loss cable.
- b. Set RBW of spectrum analyzer to 100 KHz and VBW of spectrum analyzer to 300 KHz with convenient frequency span including 100 KHz bandwidth from band edge.
- c. The band edges was measured and recorded.

7.3 Test Setup Layout

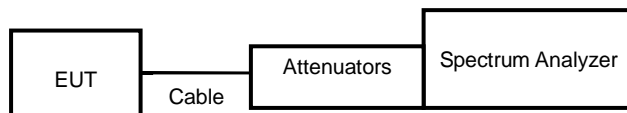

7.4 Test Result and Data

Note: Test plots refer to the following pages.



Modulation Type: GFSK (1Mbps)
Channel: 00

Modulation Type: GFSK (1Mbps)
Channel: 39

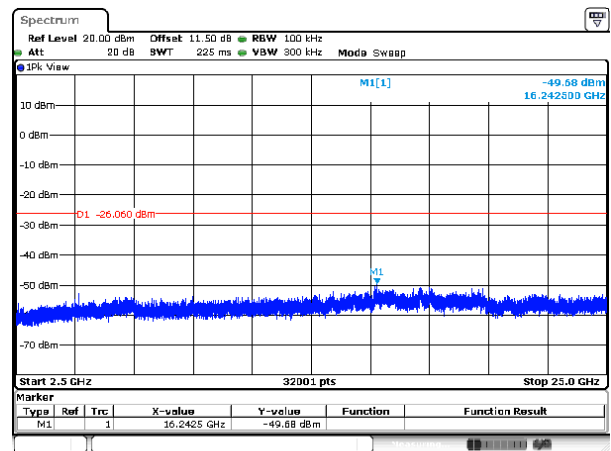
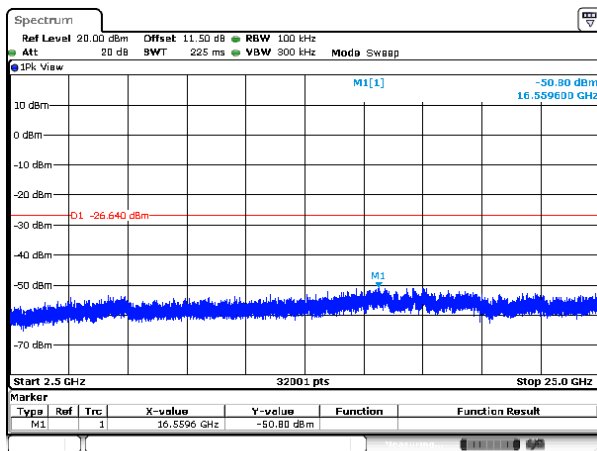
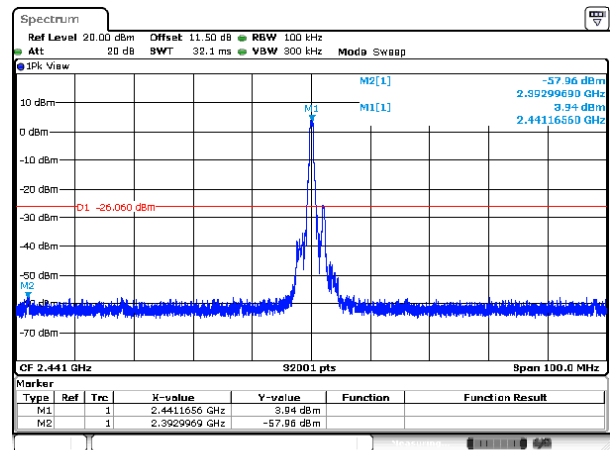
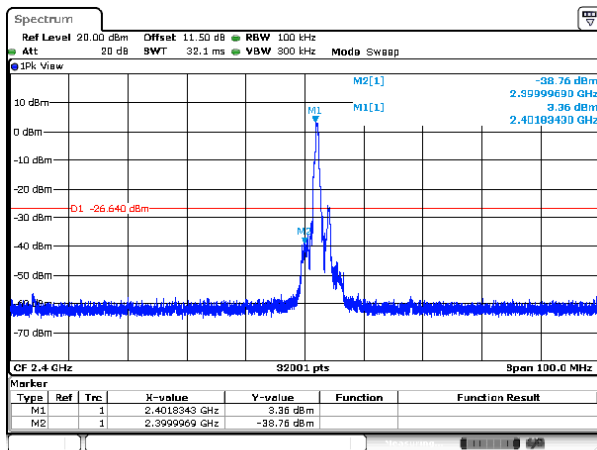
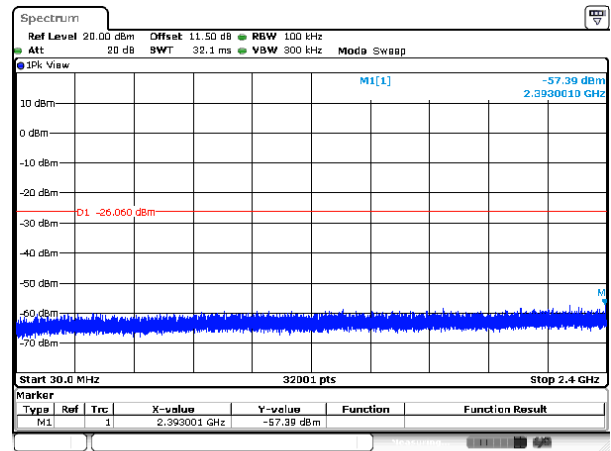
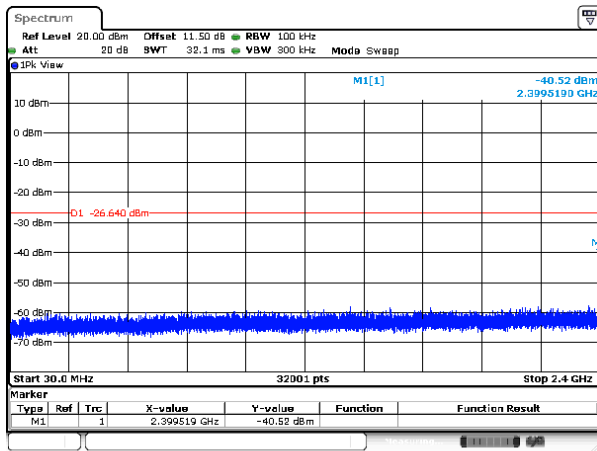



Modulation Type: GFSK (1Mbps)
Channel: 78

Modulation Type: $\pi/4$ -DQPSK (2Mbps)
Channel: 00

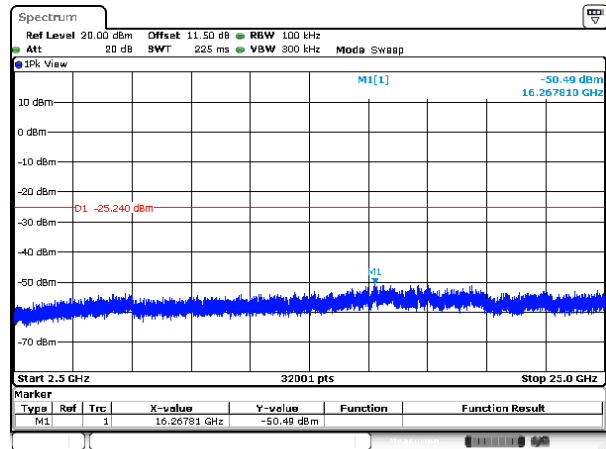
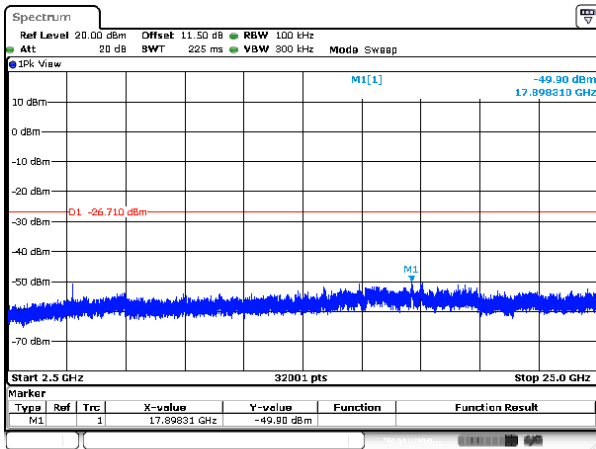
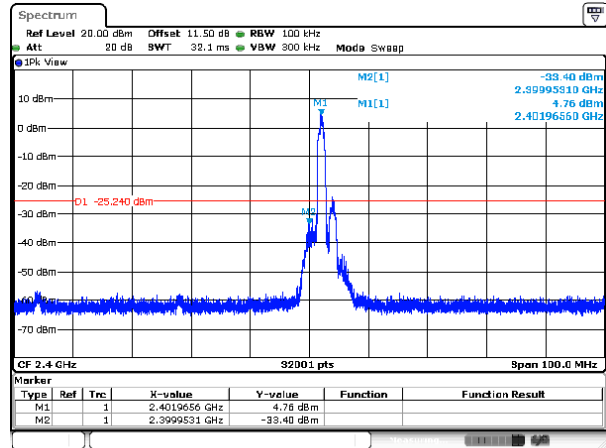
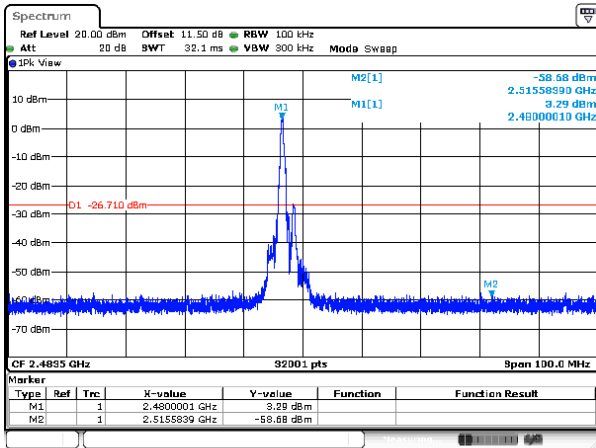
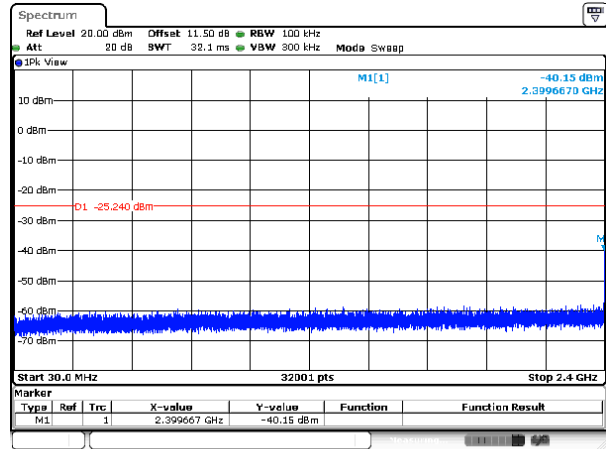
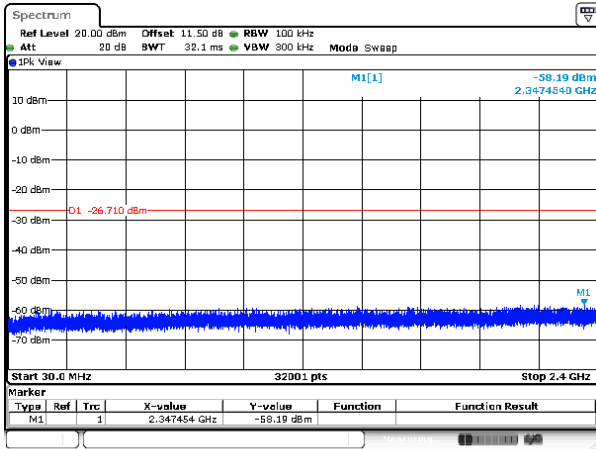



Modulation Type: $\pi/4$ -DQPSK (2Mbps)
Channel: 39

Modulation Type: $\pi/4$ -DQPSK (2Mbps)
Channel: 78

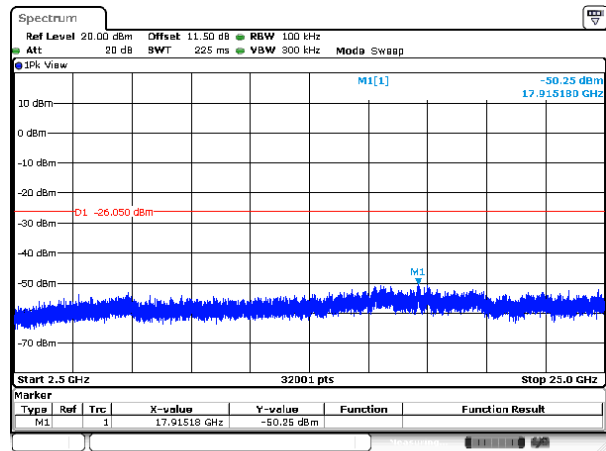
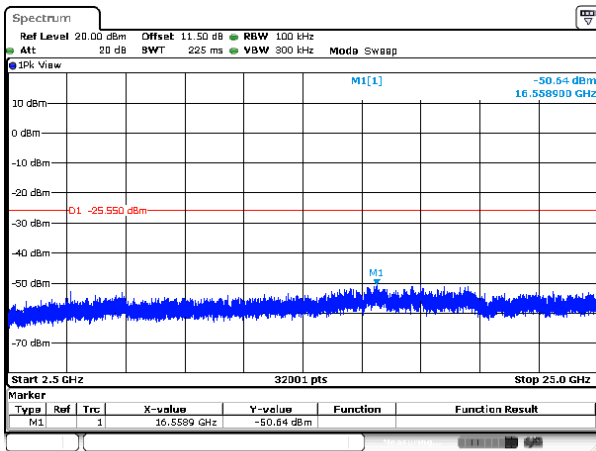
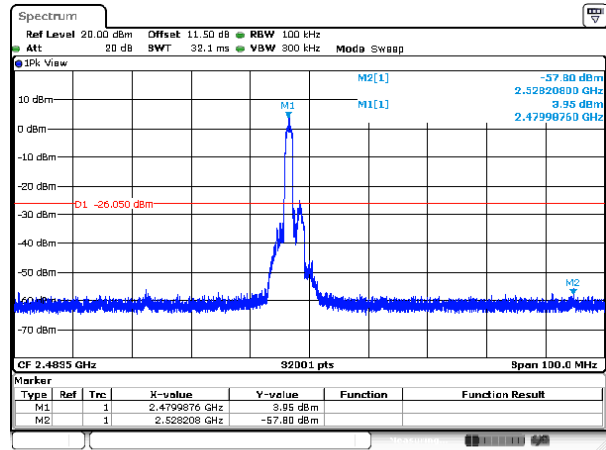
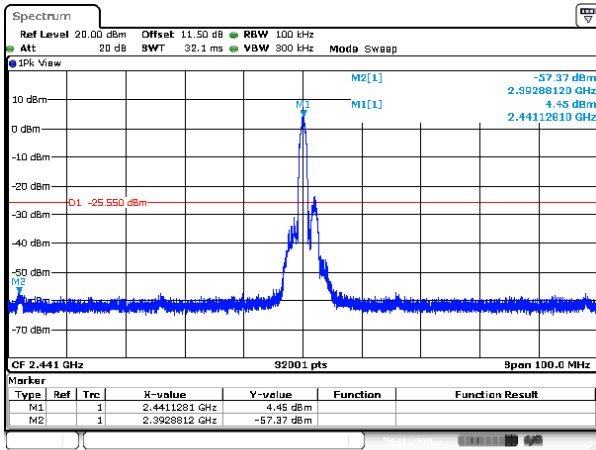
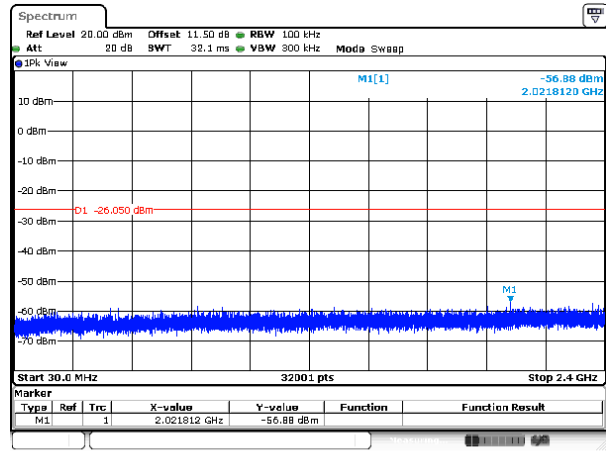
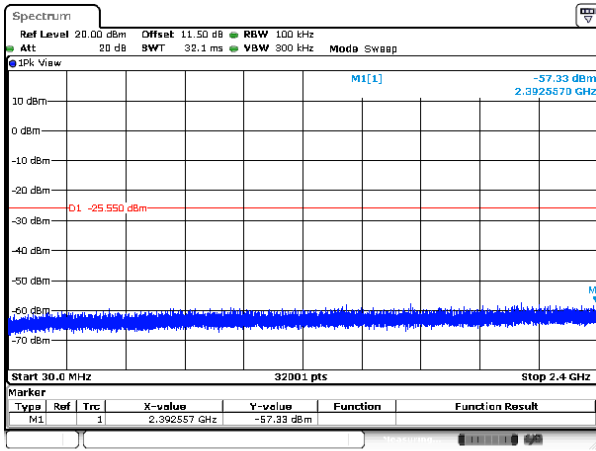



Modulation Type: 8DPSK (3Mbps)
Channel: 00

Modulation Type: 8DPSK (3Mbps)
Channel: 39

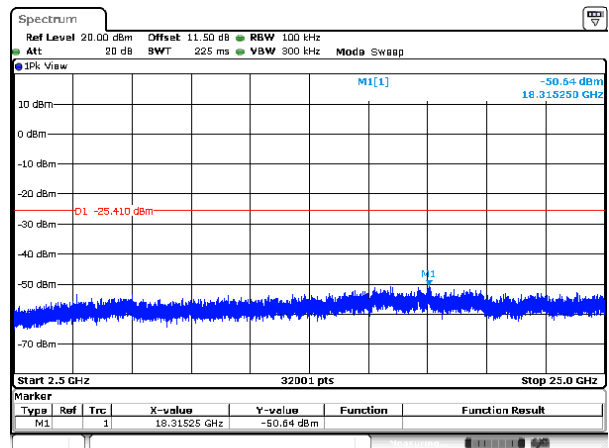
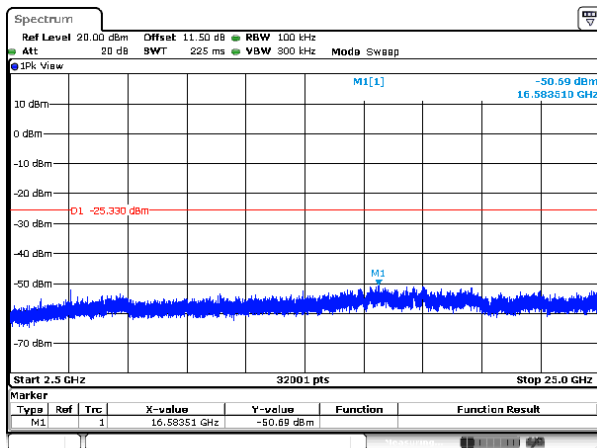
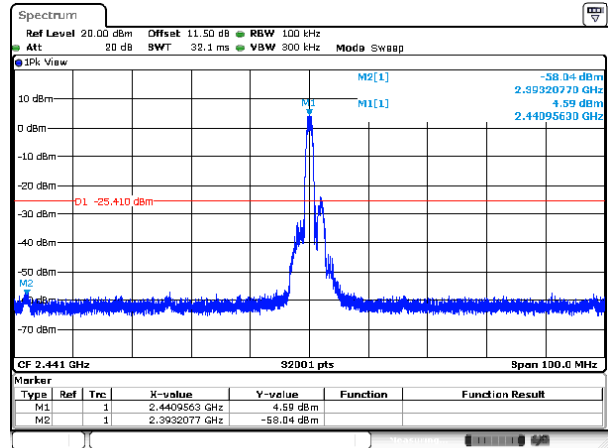
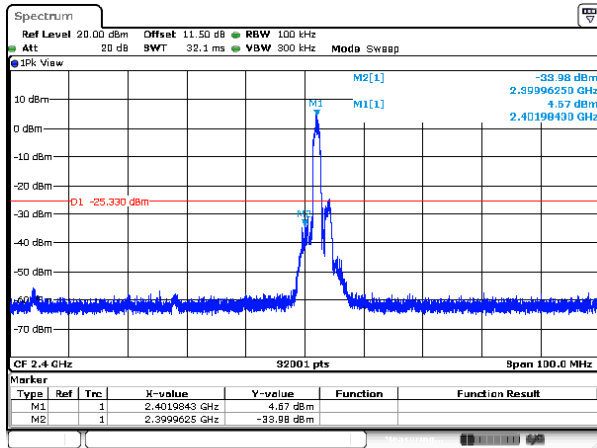
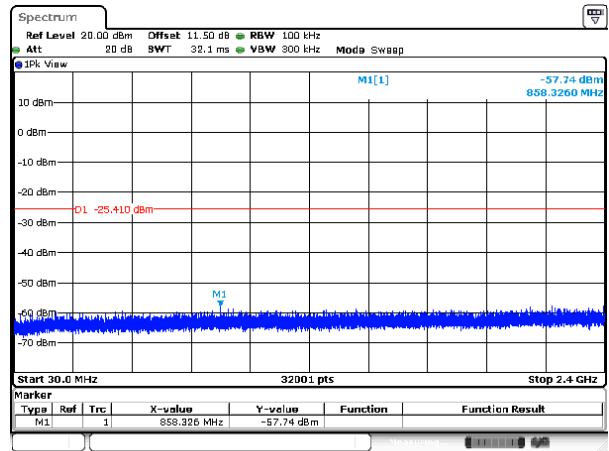
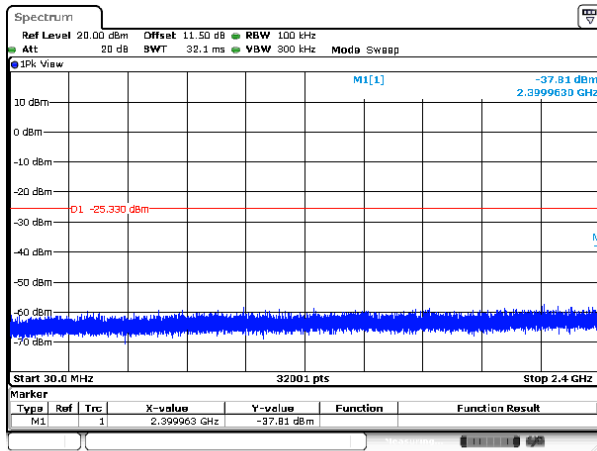



Modulation Type: 8DPSK (3Mbps)
Channel: 78

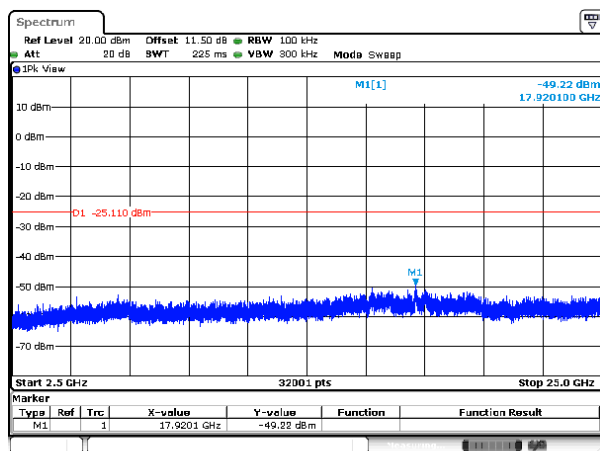
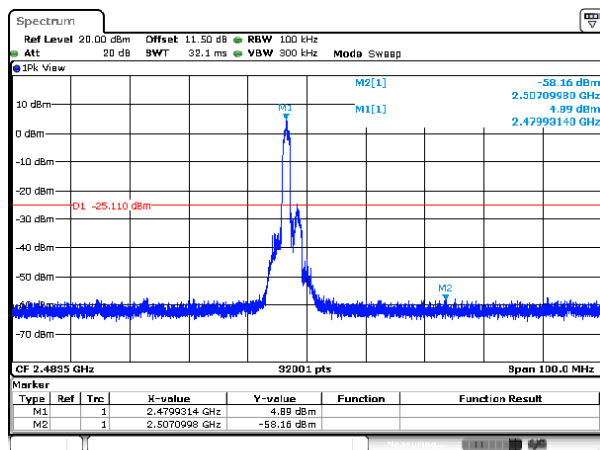
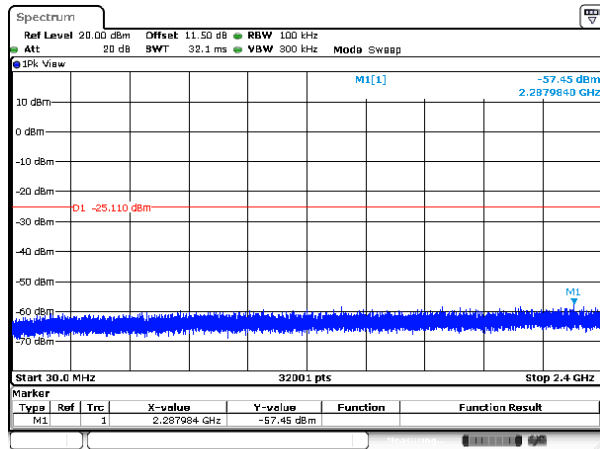



Hopping Mode: Modulation Type: GFSK

Modulation Type: $\pi/4$ -DQPSK

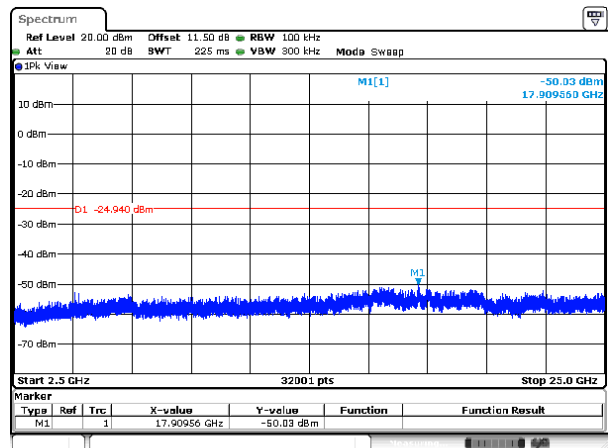
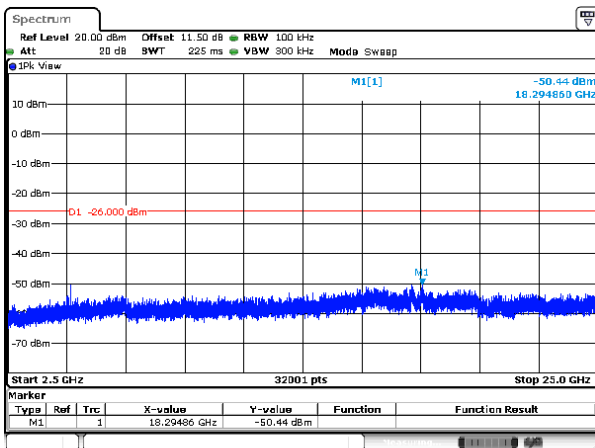
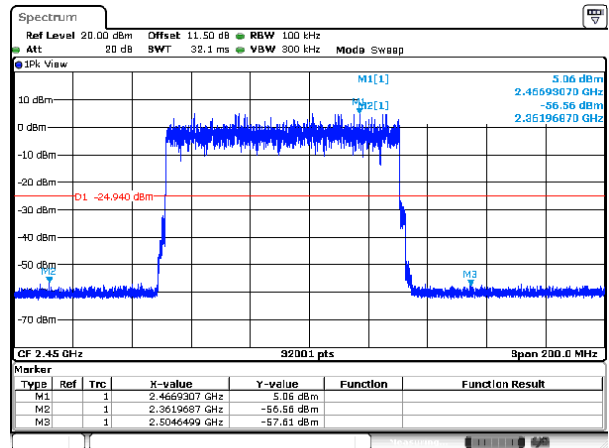
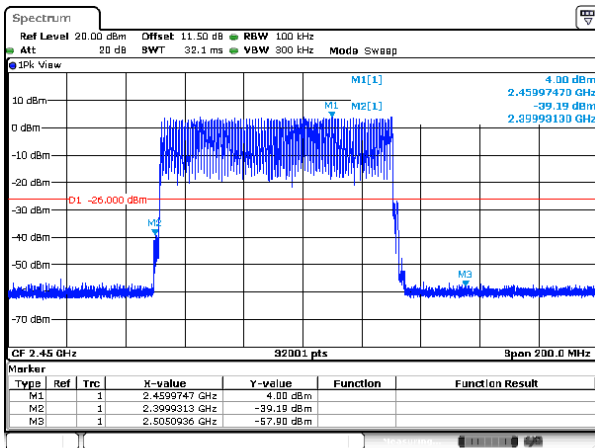
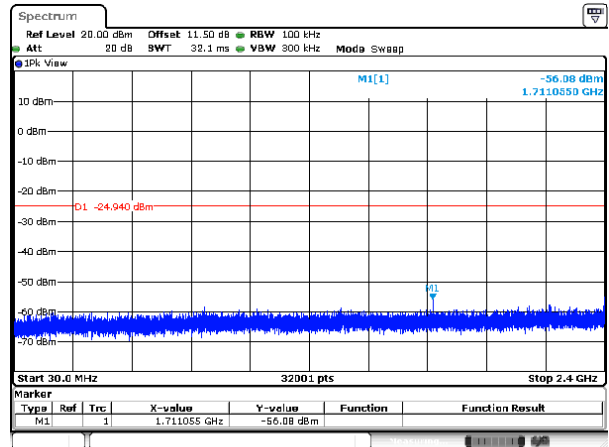
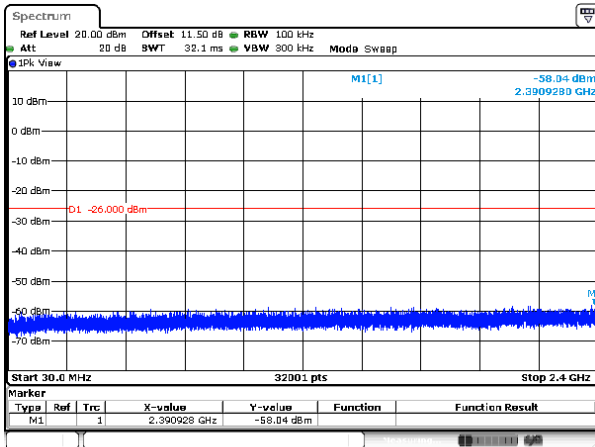



Modulation Type: 8DPSK

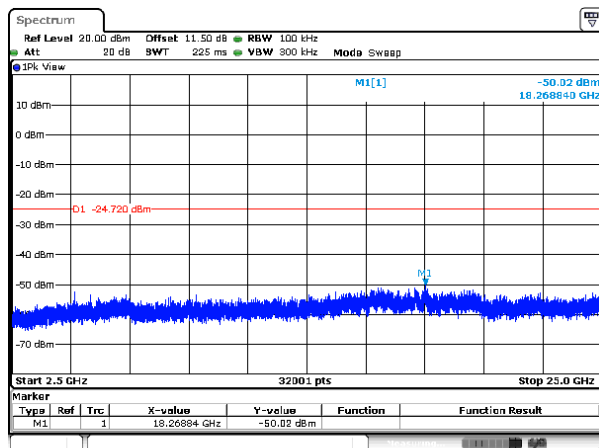
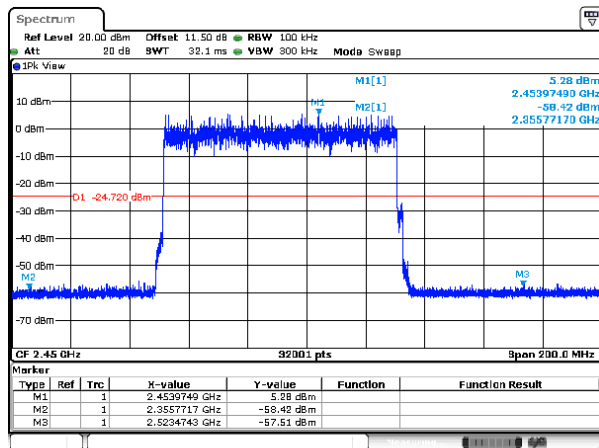
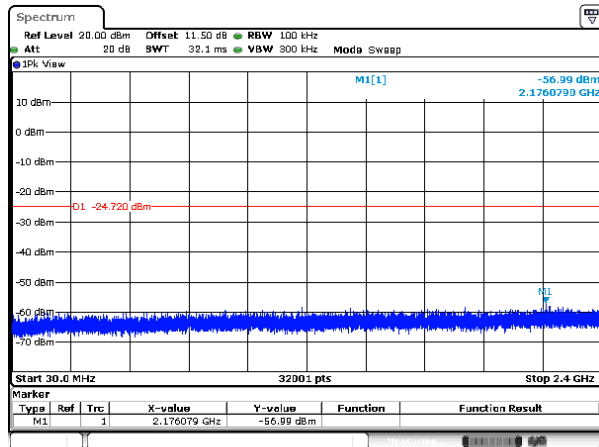



8. 20dB Bandwidth Measurement Data

8.1 Test Limit

Frequency hopping systems shall have hopping channel carrier frequencies separated by a minimum of 25 kHz or the 20 dB bandwidth of the hopping channel, whichever is greater. Alternatively, frequency hopping systems operating in the 2400–2483.5 MHz band may have hopping channel carrier frequencies that are separated by 25 kHz or two-thirds of the 20 dB bandwidth of the hopping channel, whichever is greater, provided the systems operate with an output power no greater than 125 mW.

8.2 Test Procedures

- a. The transmitter output was connected to the spectrum analyzer.
- b. Set RBW of spectrum analyzer to 1% to 5% of the 20dB Bandwidth and VBW to approximately three times RBW.
- c. The 20 dB bandwidth is defined as the total spectrum the power of which is higher than peak power minus 20 dB.

8.3 Test Setup Layout

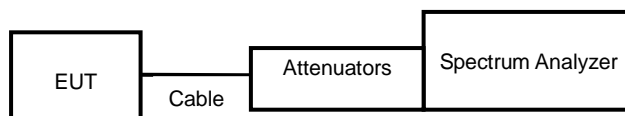



8.4 Test Result and Data

Modulation Type	Channel	Frequency (MHz)	20dB Bandwidth (MHz)	2/3 20dB Bandwidth (MHz)
GFSK	0	2402	0.842	0.562
	39	2441	0.842	0.562
	78	2480	0.842	0.562
$\pi/4$ -DQPSK	0	2402	1.281	0.854
	39	2441	1.303	0.868
	78	2480	1.274	0.849
8DPSK	0	2402	1.288	0.859
	39	2441	1.295	0.863
	78	2480	1.288	0.859



Modulation Type: GFSK (1Mbps)
Channel: 00

Modulation Type: $\pi/4$ -DQPSK (2Mbps)
Channel: 00

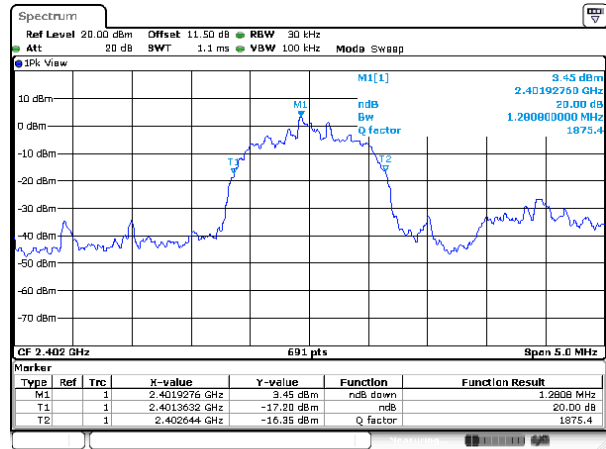
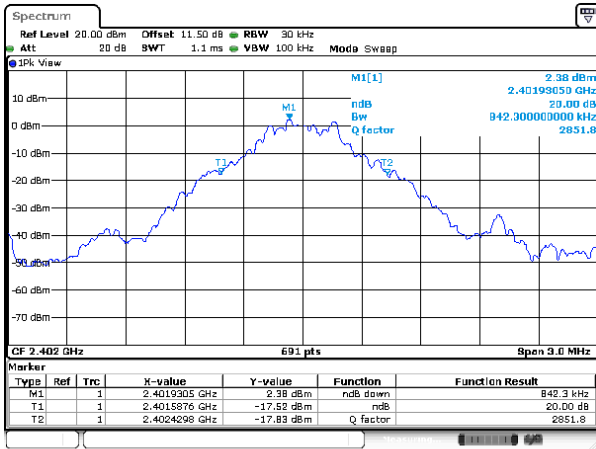

CH39

CH39

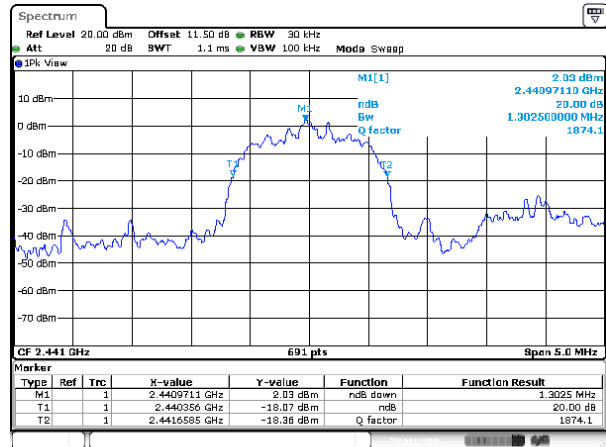
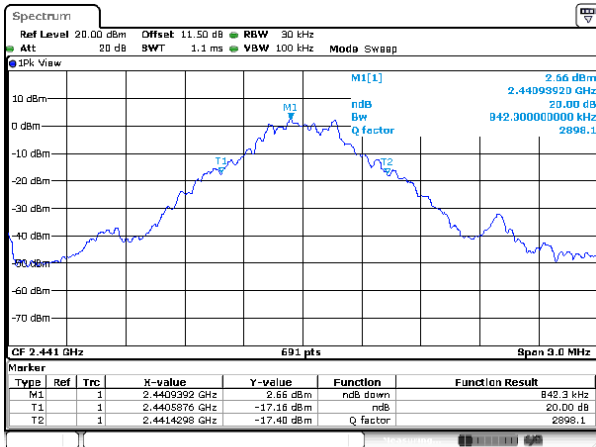

CH78

CH78

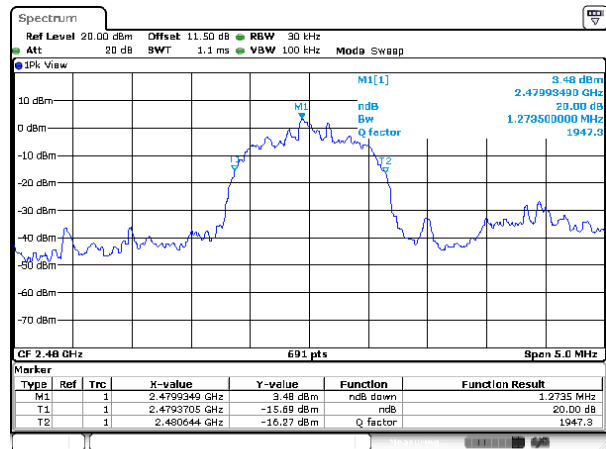
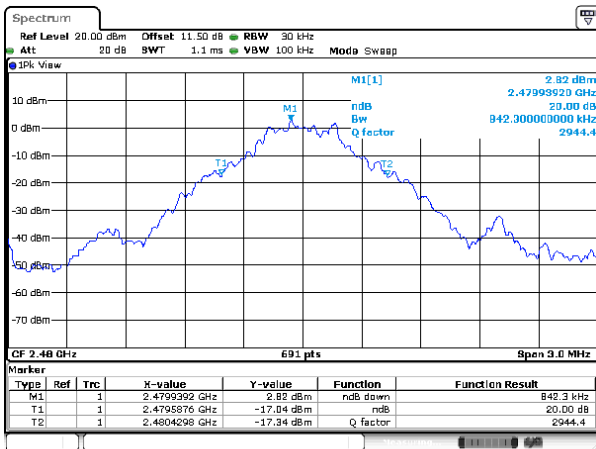



Modulation Type: 8DPSK (3Mbps)
Channel: 00

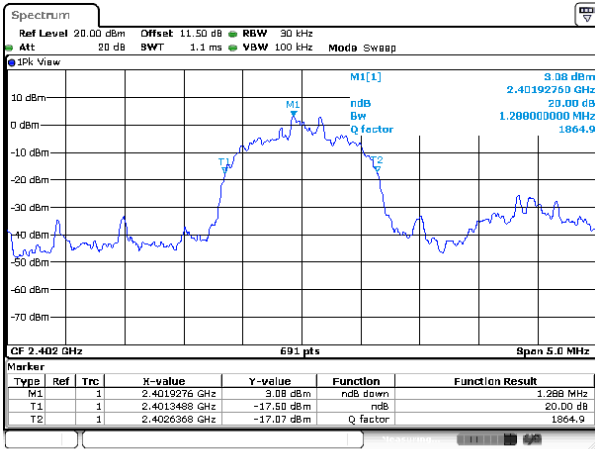

CH39

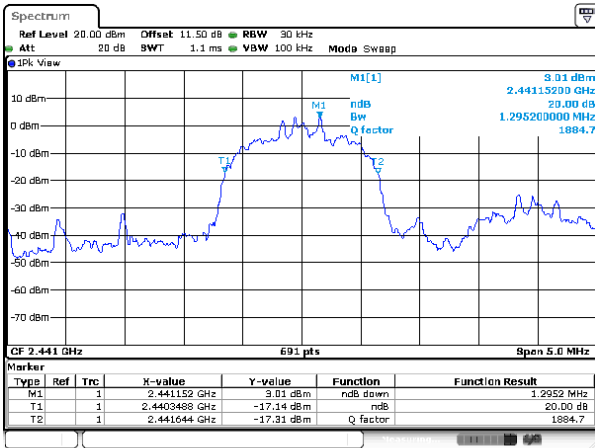

CH78

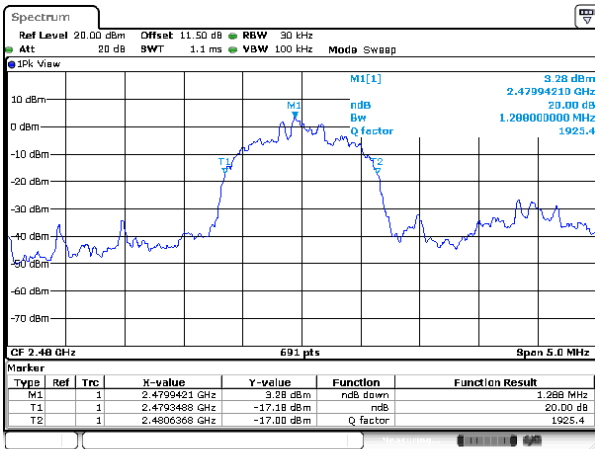



9. Frequencies Separation

9.1 Test Limit

Frequency hopping systems shall have hopping channel carrier frequencies separated by a minimum of 25 kHz or the 20 dB bandwidth of the hopping channel, whichever is greater.

9.2 Test Procedures

- a. The transmitter output was connected to the spectrum analyzer.
- b. Set RBW of spectrum analyzer to 100 KHz and VBW to 300 KHz.
- c. By using the MaxHold function record the separation of two adjacent channels.
- d. Measure the frequency difference of these two adjacent channels.

9.3 Test Setup Layout

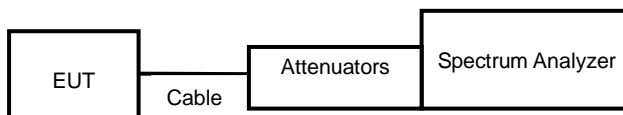

9.4 Test Result and Data

Modulation Type	Channel	Frequency (MHz)	Channel Separation (MHz)	Limit (MHz)
GFSK	0	2402	1.003	0.562
	39	2441	0.999	0.562
	78	2480	0.999	0.562
$\pi/4$ -DQPSK	0	2402	1.003	0.854
	39	2441	0.990	0.868
	78	2480	1.007	0.849
8DPSK	0	2402	0.999	0.859
	39	2441	0.999	0.863
	78	2480	0.999	0.859



Modulation Type: GFSK (1Mbps)
Channel: 00

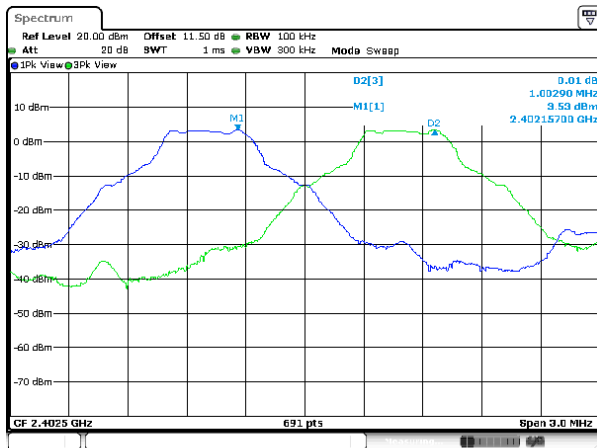

Modulation Type: $\pi/4$ -DQPSK (2Mbps)
Channel: 00

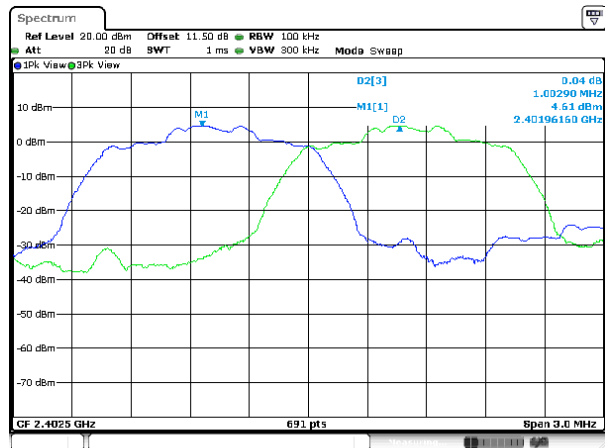

CH39

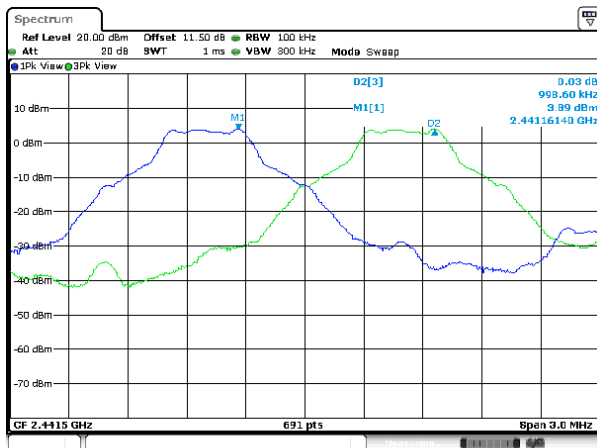

CH39

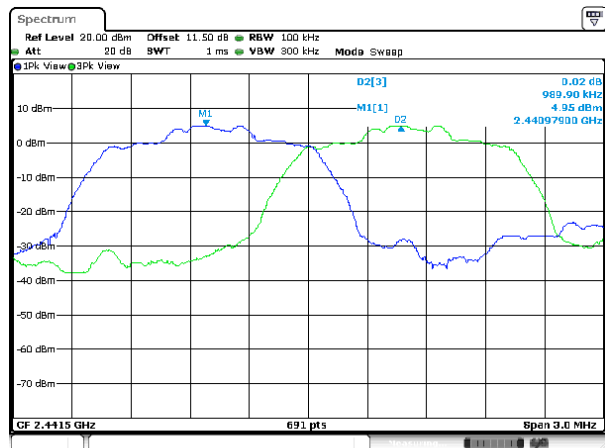

CH78

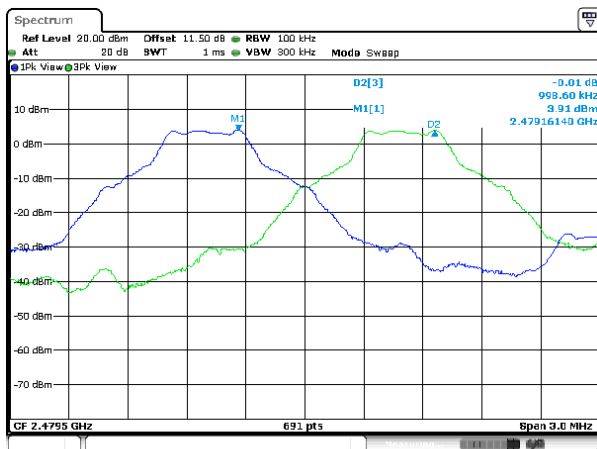

CH78

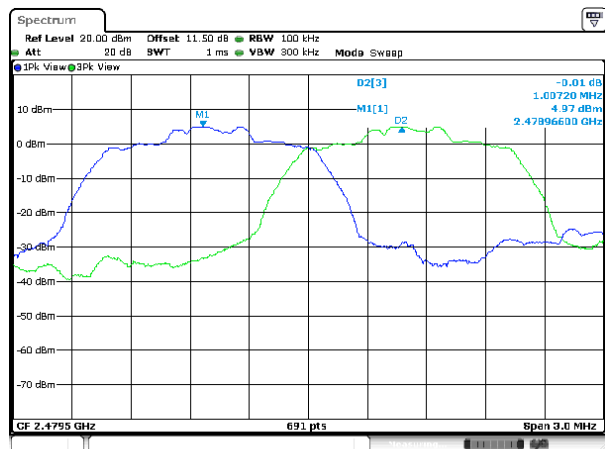



Modulation Type: 8DPSK (3Mbps)
Channel: 00

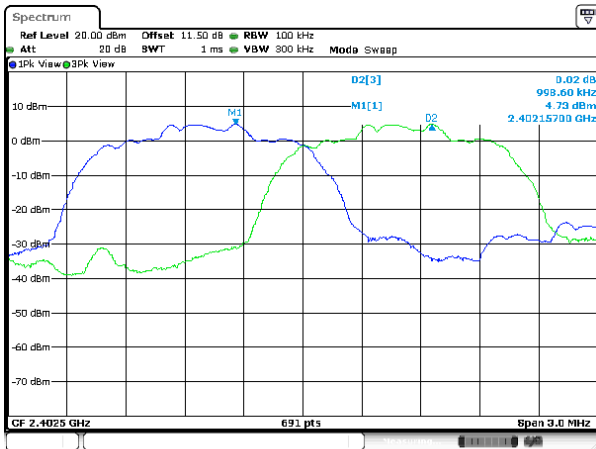

CH39

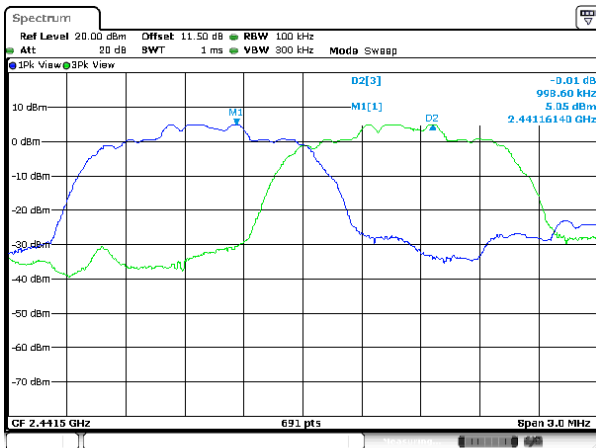

CH78

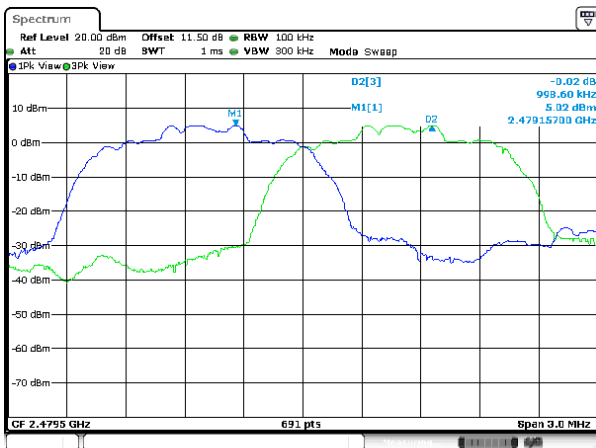



10. Dwell Time on each channel

10.1 Test Limit

The average time of occupancy on any channel shall not be greater than 0.4 seconds within a period of 0.4 seconds multiplied by the number of hopping channels employed.

10.2 Test Procedures

1. The transmitter output was connected to the spectrum analyzer.
2. Adjust the center frequency to measure frequency, then set zero span mode.
2. Set RBW of spectrum analyzer to 1 MHz and VBW to 1 MHz.
4. Measure the time duration of one transmission on the measured frequency.

10.3 Test Setup Layout

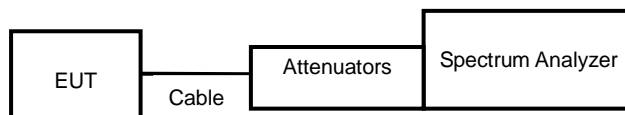

**10.4 Test Result and Data**

Channel	Frequency (MHz)	Length of transmission time (ms)	Number of transmission in a 31.6 (79 Hopping*0.4)	Dwell Time (ms)	Limit (ms)
GFSK-DH1	2402	0.443	320.10	141.93	400
GFSK-DH3	2402	1.748	159.90	279.47	400
GFSK-DH5	2402	2.965	106.81	316.71	400
$\pi/4$ -DQPSK-DH1	2402	0.451	320.10	144.27	400
$\pi/4$ -DQPSK-DH3	2402	1.712	159.90	273.67	400
$\pi/4$ -DQPSK-DH5	2402	3.001	106.81	320.58	400
8DPSK-DH1	2402	0.449	320.10	143.79	400
8DPSK-DH3	2402	1.717	159.90	274.60	400
8DPSK-DH5	2402	2.964	106.81	316.56	400

Channel	Frequency (MHz)	Length of transmission time (ms)	Number of transmission in a 8 (20 Hopping*0.4)	Dwell Time (ms)	Limit (ms)
AFH-DH1	2402-2421	0.443	160.00	70.94	400
AFH-DH3	2402-2421	1.748	80.00	139.82	400
AFH-DH5	2402-2421	2.965	53.33	158.13	400



Modulation Type: GFSK-DH1
Channel: 00

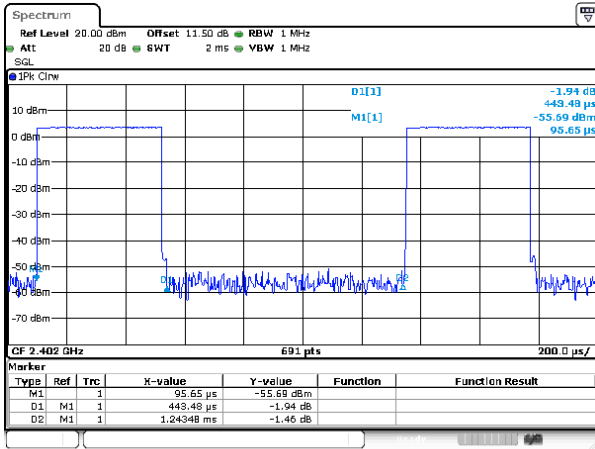

Modulation Type: π/4-DQPSK-DH1
Channel: 00

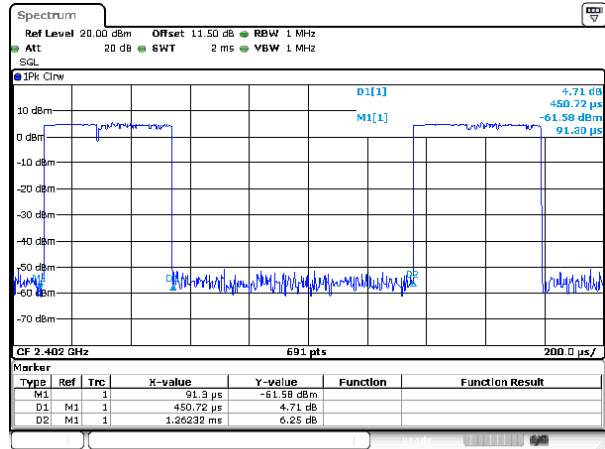

GFSK-DH3

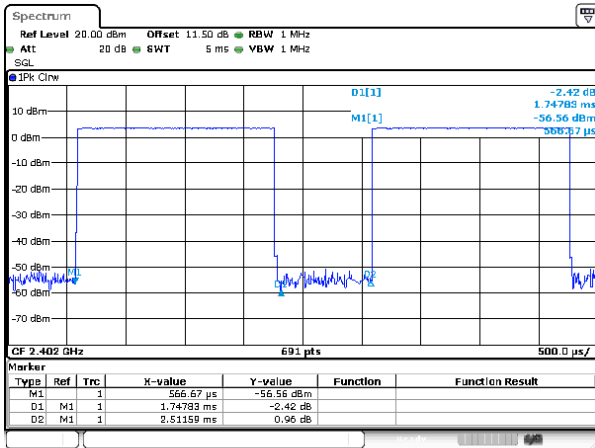

π/4-DQPSK-DH3

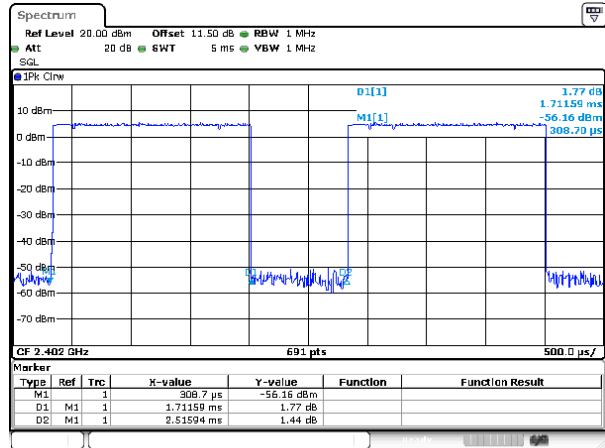

GFSK-DH5

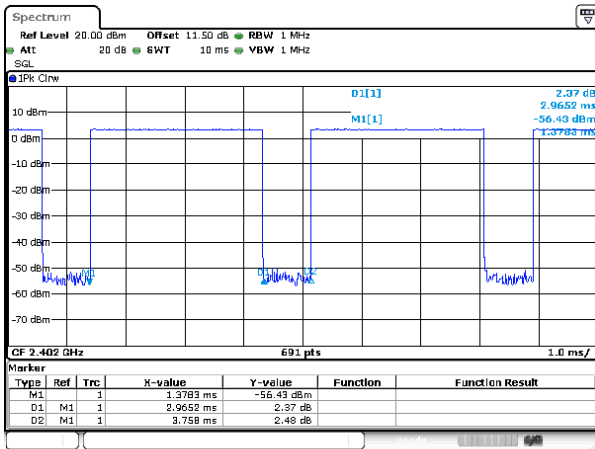

π/4-DQPSK-DH5

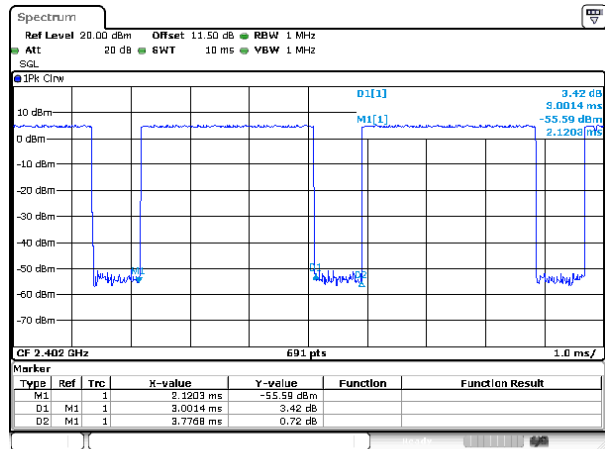



Modulation Type: 8DPSK-DH1
Channel: 00

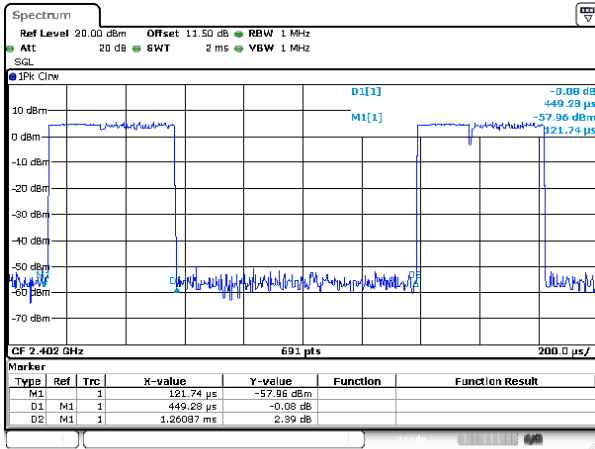

Modulation Type: AFH (DH1)

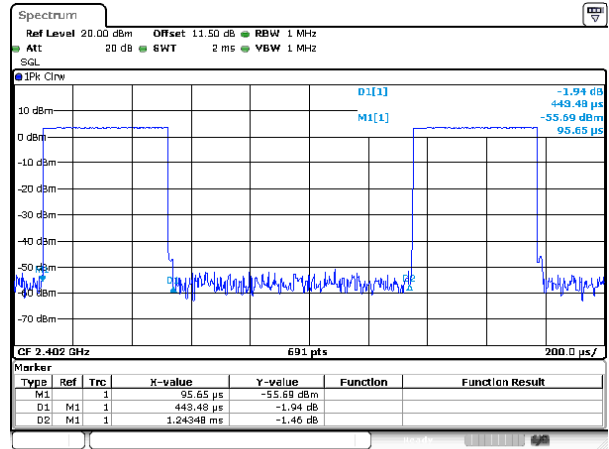

8DPSK-DH3

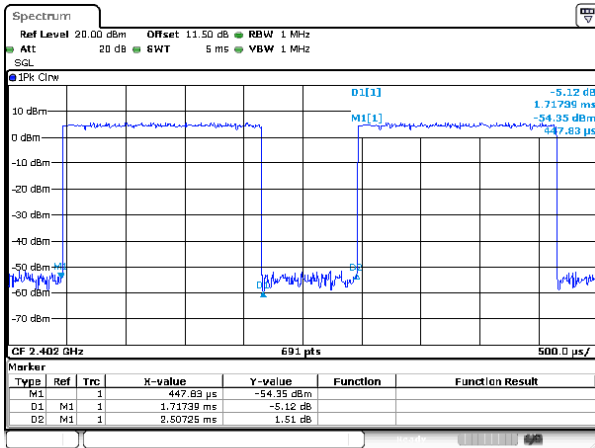

Modulation Type: AFH (DH3)

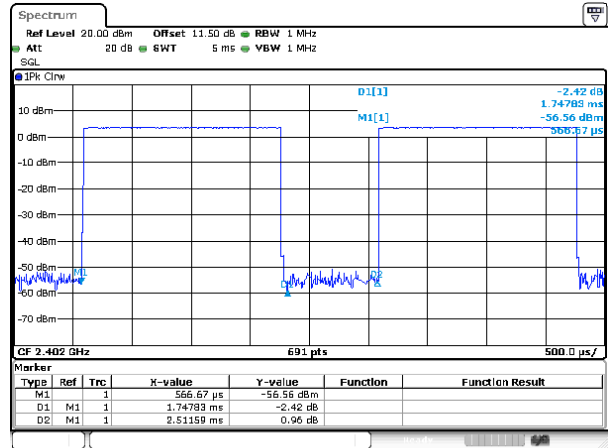

8DPSK-DH5

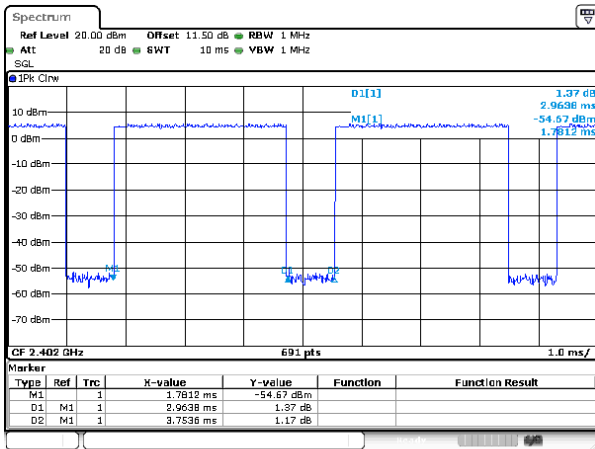

Modulation Type: AFH (DH5)

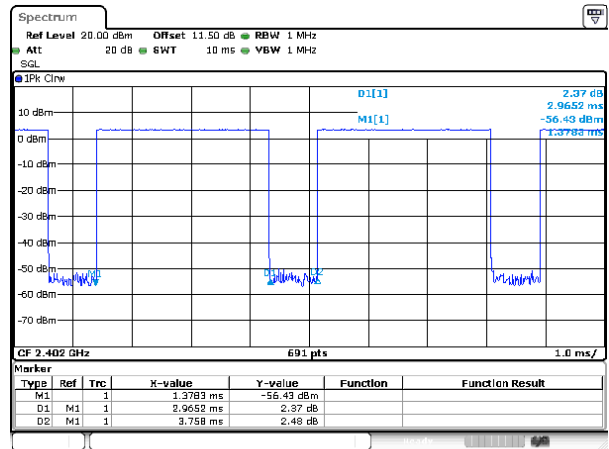



11. Number of Hopping Channels

11.1 Test Limit

Frequency hopping systems in the 2400 ~ 2483.5 MHz band shall use at least 15 channels.

11.2 Test Procedures

- a. The transmitter output was connected to the spectrum analyzer.
- b. 2. Set RBW of spectrum analyzer to 100 KHz and VBW to 300 KHz.
- c. 3. Set the MaxHold function, and then keep the EUT in hopping mode. Record all the signals from each channel until each one has been record.

11.3 Test Setup Layout

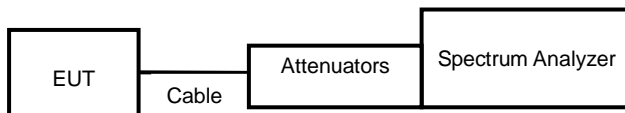

11.4 Test Result and Data

Modulation Type	Hopping Channels
GFSK	79
$\pi/4$ -DQPSK	79
8DPSK	79



Modulation Type: GFSK (1Mbps)

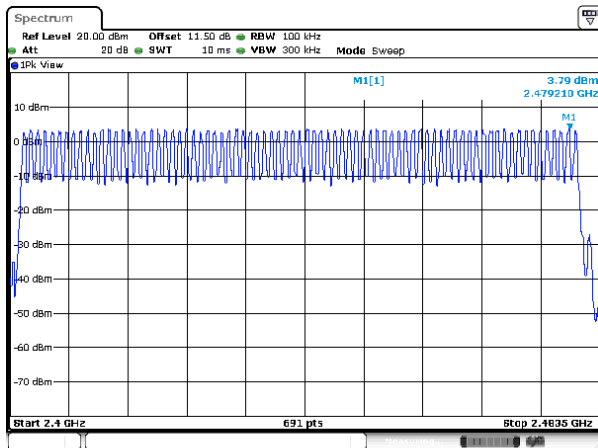

Modulation Type: $\pi/4$ -DQPSK (2Mbps)

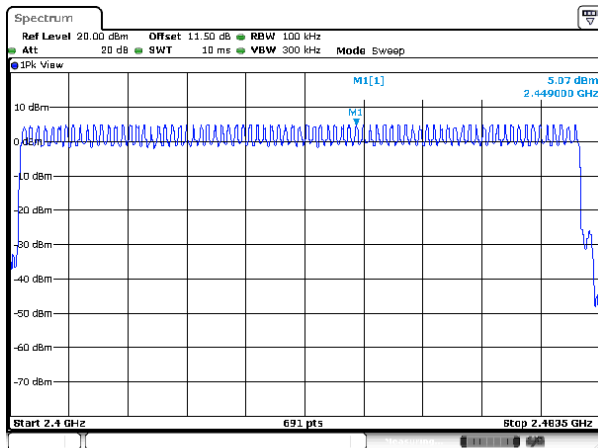

Modulation Type: 8DPSK (3Mbps)

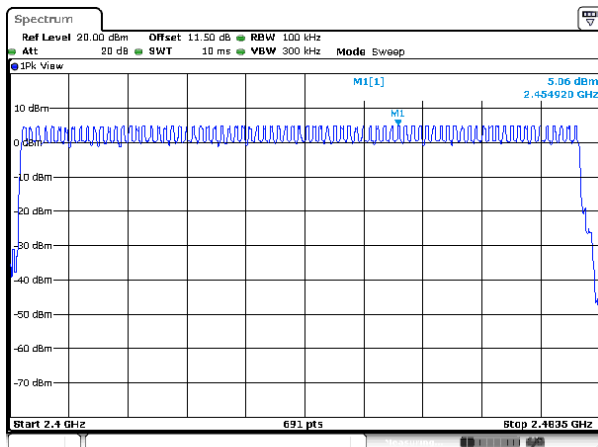



12. Maximum Average Output Power

12.1 Test Limit

The Maximum Average Output Power Measurement is 30dBm.

12.2 Test Procedures

The antenna port(RF output)of the EUT was connected to the input(RF input)of a power meter. Power was read directly from the meter and cable loss connection was added to the reading to obtain power at the EUT antenna terminal. The EUT Output Power was set to maximum to produce the worse case test result.

12.3 Test Setup Layout

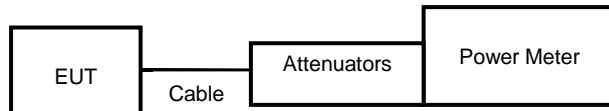



12.4 Test Result and Data

Modulation Type	Setting	Channel	Frequency (MHz)	AV Output Power (dBm)	AV Output Power (mW)
GFSK	39	0	2402	3.86	2.432
	39	39	2441	4.04	2.535
	39	78	2480	3.91	2.460
$\pi/4$ -DQPSK	39	0	2402	3.88	2.443
	39	39	2441	4.03	2.529
	39	78	2480	3.96	2.489
8DPSK	39	0	2402	3.91	2.460
	39	39	2441	4.07	2.553
	39	78	2480	3.92	2.466

AFH Mode

Modulation Type	Setting	Channel	Frequency (MHz)	AV Output Power (dBm)	AV Output Power (mW)
GFSK	39	0-19	2402-2421	3.94	2.477
$\pi/4$ -DQPSK	39	0-19	2402-2421	3.96	2.489
8DPSK	39	0-19	2402-2421	3.99	2.506