



# FCC RADIO TEST REPORT

Applicant : SteelSeries ApS.  
Address : 656 W Randolph St., Suite 3E Chicago, IL 60661,  
USA  
Equipment : Wireless Mouse  
Model No. : M-00027  
Trade Name :   
FCC ID. : ZHK-M00027

**I HEREBY CERTIFY THAT :**

The sample was received on Apr. 09, 2021 and the testing was completed on May. 06, 2021 at CerpPASS Technology Corp. The test result refers exclusively to the test presented test model / sample. Without written approval of CerpPASS Technology Corp., the test report shall not be reproduced except in full.

Approved by:

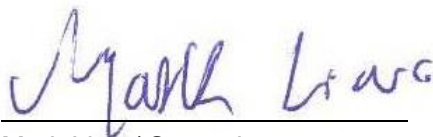

Mark Liao / Supervisor

Laboratory Accreditation:

CerpPASS Technology Corporation Test Laboratory





CONTENTS

- 1. **Summary of Test Procedure and Test Results**.....5
  - 1.1 Applicable Standards .....5
- 2. **Test Configuration of Equipment under Test**.....6
  - 2.1 Feature of Equipment under Test.....6
  - 2.2 Carrier Frequency of Channels .....6
  - 2.3 Test Mode and Test Software .....7
  - 2.4 Description of Test System.....7
  - 2.5 General Information of Test.....8
  - 2.6 Measurement Uncertainty .....9
- 3. **Test Equipment and Ancillaries Used for Tests** .....10
- 4. **Antenna Requirements**.....12
  - 4.1 Standard Applicable .....12
  - 4.2 Antenna Construction and Directional Gain.....12
- 5. **Test of AC Power Line Conducted Emission** .....13
  - 5.1 Test Limit .....13
  - 5.2 Test Procedures .....13
  - 5.3 Typical Test Setup .....14
  - 5.4 Test Result and Data .....15
  - 5.5 Test Photographs .....17
- 6. **Test of Spurious Emission (Radiated)** .....18
  - 6.1 Test Limit .....18
  - 6.2 Test Procedures .....19
  - 6.3 Typical Test Setup .....20
  - 6.4 Test Result and Data (9kHz ~ 30MHz).....22
  - 6.5 Test Result and Data (30MHz ~ 1GHz).....22
  - 6.6 Test Result and Data (1GHz ~ 25GHz).....24
  - 6.7 Restricted Bands of Operation .....30
  - 6.8 Test Photographs (30MHz ~ 1GHz).....31
  - 6.9 Test Photographs (1GHz ~ 25GHz) .....32
- 7. **Test of Spurious Emission (Conducted)**.....34
  - 7.1 Test Limit .....34
  - 7.2 Test Procedure .....34
  - 7.3 Test Setup Layout .....34
  - 7.4 Test Result and Data .....34
- 8. **On Time, Duty Cycle and Measurement methods** .....37
  - 8.1 Test Limit .....37
  - 8.2 Test Procedure .....37
  - 8.3 Test Setup Layout .....37
  - 8.4 Test Result and Data .....37
- 9. **6dB Bandwidth Measurement Data** .....39
  - 9.1 Test Limit .....39



9.2 Test Procedures ..... 39

9.3 Test Setup Layout ..... 39

9.4 Test Result and Data ..... 39

**10. Maximum Peak and Average Output Power ..... 41**

10.1 Test Limit ..... 41

10.2 Test Procedures ..... 41

10.3 Test Setup Layout ..... 41

10.4 Test Result and Data ..... 41

**11. Power Spectral Density ..... 42**

11.1 Test Limit ..... 42

11.2 Test Procedures ..... 42

11.3 Test Setup Layout ..... 42

11.4 Test Result and Data ..... 42

**12. Radio Frequency Exposure ..... 44**

12.1 Applicable Standards ..... 44

12.2 EUT Specification ..... 44

12.3 Test Results ..... 45



### History of this test report

Report No.	Issue Date	Description
21040002-TRFCC01	May. 10, 2021	Original



# 1. Summary of Test Procedure and Test Results

## 1.1 Applicable Standards

**ANSI C63.10:2013**

**FCC Rules and Regulations Part 15 Subpart C §15.247**

FCC Rule	Description of Test	Result
15.203	Antenna Requirement	PASS
15.207	AC Power Line Conducted Emission	PASS
15.209 15.205	Radiated Spurious Emission	PASS
15.247(d)	Conducted Spurious Emission	PASS
15.247(a)(2)	6dB Bandwidth	PASS
15.247(b)	Maximum Peak Output Power	PASS
15.247(e)	Power Spectral Density	PASS

\*The lab has reduced the uncertainty risk factor from test equipment, environment and staff technicians which according to the standard on contract. Therefore, the test result will only be determined by standard requirement.

\*This EUT has been also tested and compiled with the requirement of FCC Part 15, Subpart B, recorded in a separate test report(21040002-TEFV01).



## 2. Test Configuration of Equipment under Test

### 2.1 Feature of Equipment under Test

Frequency Range	2402-2480MHz
Modulation Type	$\pi/4$ -DQPSK
Data Rate	$\pi/4$ -DQPSK: 2Mbps
Antenna Type	PCB Antenna
Antenna Gain	3.03 dBi
USB TYPE-C Cable	Brand:YUE YANG Model:YY-032-99A
Battery	Brand:BPI Model:PL 542630
Firmware Number	v1.0.15
Serial Number	62426PVT23112100102

Note: For more details, please refer to the User's manual of the EUT.

### 2.2 Carrier Frequency of Channels

Channel	Frequency (MHz)	Channel	Frequency (MHz)	Channel	Frequency (MHz)
<b>*00</b>	<b>2402</b>	14	2430	28	2458
01	2404	15	2432	29	2460
02	2406	16	2434	30	2462
03	2408	17	2436	31	2464
04	2410	18	2438	32	2466
05	2412	<b>*19</b>	<b>2440</b>	33	2468
06	2414	20	2442	34	2470
07	2416	21	2444	35	2472
08	2418	22	2446	36	2474
09	2420	23	2448	37	2476
10	2422	24	2450	38	2478
11	2424	25	2452	<b>*39</b>	<b>2480</b>
12	2426	26	2454	--	--
13	2428	27	2456	--	--

Note: Channels remarked \* are selected to perform test.



### 2.3 Test Mode and Test Software

- a. During testing, the interface cables and equipment positions were varied according to ANSI C63.10.
- b. The complete test system included Notebook and EUT for RF test.
- c. An executive program, "Bus Hound ver.6.01" under Windows OS system was executed to transmit and receive data via 2.4GHz.
- d. The following test modes were performed for the test:

Test Mode	Operating Description
1	$\pi/4$ DQPSK (2Mbps)

Modulation Type	TX CONFIGURATION
$\pi/4$ DQPSK	1TX

### 2.4 Description of Test System

RF Conducted				
Equipment	Brand	Model	Length/Type	Power cord/Length/Type
Notebook	ASUS	P2430U	N/A	Adapter / 1.8m / NS
Radiated Emissions				
Equipment	Brand	Model	Length/Type	Power cord/Length/Type
Notebook	ASUS	P2430U	N/A	Adapter / 1.8m / NS
AC Power Line Conducted Emission				
Equipment	Brand	Model	Length/Type	Power cord/Length/Type
Notebook	ASUS	P2430U	N/A	Adapter / 1.8m / NS

**2.5 General Information of Test**

Test Site	<b>CerpPASS Technology Corporation Test Laboratory</b> Address: No.10, Ln. 2, Lianfu St., Luzhu Dist., Taoyuan City 33848, Taiwan (R.O.C.) Tel:+886-3-3226-888 Fax:+886-3-3226-881	
	FCC	TW1439, TW1079
	IC	4934E-1, 4934E-2
	VCCI	T-2205 for Telecommunication test C-4663 for Conducted emission test R-4218 for Radiated emission test G-10812, G-10813 for radiated disturbance above 1GHz
Frequency Range Investigated:	Conducted: from 150kHz to 30 MHz Radiation: from 30 MHz to 25,000MHz	
Test Distance:	The test distance of radiated emission from antenna to EUT is 3 M.	

Test Item	Test Site	Test period	Environmental Conditions	Tested By
RF Conducted	RFCON01-NK	2021/05/04	29.6°C / 38%	Nick Guan
Radiated Emissions	3M02-NK	2021/04/28~2021/05/04	21.5~23°C / 36~51%	Nick Guan
AC Power Line Conducted Emission	CON01-NK	2021/05/06	24°C / 48%	Nick Guan





## 2.6 Measurement Uncertainty

Measurement Item	Uncertainty
Radiated Spurious Emission(9KHz~30MHz)	±3.404dB
Radiated Spurious Emission(30MHz~1GHz)	±5.686dB
Radiated Spurious Emission(1GHz~25GHz)	±6.6dB
Conducted Spurious Emission	±1.8dB
6dB Bandwidth	±4.4%
20dB Bandwidth	±4.4%
Occupied Bandwidth	±4.4%
Peak Output Power(Conducted Power Meter)	±1.1dB
Dwell Time / Deactivation Time	±1.2%
Power Spectral Density	±1.8dB
Duty Cycle	±1.2%



### 3. Test Equipment and Ancillaries Used for Tests

Test Item	Radiated Emissions				
Test Site	Semi Anechoic Room(3M02-NK)				
Instrument	Manufacturer	Model No	Serial No	Calibration Date	Valid Date
Bilog Antenna	Schwarzbeck	VULB9168	275	2020/10/07	2021/10/06
Active Loop Antenna	EMCO	6507	40855	2020/05/21	2021/05/20
Horn Antenna	EMCO	3115	31601	2020/10/16	2021/10/15
Horn Antenna	EMCO	3116	31974	2020/09/24	2021/09/23
EMI Receiver	ROHDE & SCHWARZ	ESCI	101423	2020/06/23	2021/06/22
Spectrum Analyzer	ROHDE & SCHWARZ	FSV 40-N	102151	2020/08/03	2021/08/02
Preamplifier	EM Electronics corp.	EM330	60658	2020/10/20	2021/10/19
Preamplifier	EM Electronics corp.	EM330	60660	2021/03/18	2022/03/17
Preamplifier	Agilent	8449B	3008A01954	2021/03/22	2022/03/21
Preamplifier	EMC INSTRUMENTS	EMC184045	980065	2020/11/06	2021/11/05
Bluetooth Tester	ROHDE & SCHWARZ	CBT	101133	2021/04/19	2022/04/18
Cable-3in1(30M-1G)	HARBOUR INDUSTRIES	LL142	CCE1315	2021/04/08	2022/04/07
Cable-0.5m(1G-18G)	HUBER SUHNER	SUCOFLEX 104	805443/4	2020/05/27	2021/05/26
Cable-3m(1G-18G)	HUBER SUHNER	SUCOFLEX 104	805796/4	2020/05/27	2021/05/26
Cable-8m(1G-18G)	HUBER SUHNER	SUCOFLEX 104	805795/4	2020/05/27	2021/05/26
Cable-0.5m(30M-40G)	HUBER SUHNER	SUCOFLEX 102	28420/2	2021/04/03	2022/04/02
Cable-3m(30M-40G)	HUBER SUHNER	SUCOFLEX 102	MY2608/2	2021/04/09	2022/04/08
Cable-0.5m(1G-40G)	Rapidtek	40GHZ 50CM	38MS-38MS50 314	2021/04/08	2022/04/07
Cable-6m(9k~300M)	NA	EMC5D-BM-BM-6	130605	2020/09/18	2021/09/17
E3	AUDIX	v8.2014-8-6	RK-000529	NA	NA

Test Item	RF Conducted				
Test Site	RFCON01-NK				
Instrument	Manufacturer	Model No	Serial No	Calibration Date	Valid Date
Spectrum Analyzer	ROHDE & SCHWARZ	FSV 40-N	101329	2020/07/07	2021/07/06
Bluetooth Tester	ROHDE & SCHWARZ	CBT	101133	2021/04/19	2022/04/18
CAX Signal Analyzer	KEYSIGHT	N9000B	MY57100339	2020/12/25	2021/12/24
Attenuator	KEYSIGHT	8491B	MY39250705	2020/09/28	2021/09/27
TEMP & HUMIDITY CHAMBER	T-MACHINE	TMJ-9712	T-12-040111	2020/08/25	2021/08/24
Power Meter	Anritsu	ML2495A	2034001	2020/09/25	2021/09/24
Power Sensor	Anritsu	MA2411B	1911175	2020/09/25	2021/09/24



Test Item	AC Power Line Conducted Emission				
Test Site	CON01-NK				
<b>Instrument</b>	<b>Manufacturer</b>	<b>Model No</b>	<b>Serial No</b>	<b>Calibration Date</b>	<b>Valid Date</b>
EMI Receiver	ROHDE & SCHWARZ	ESCI	100443	2020/05/25	2021/05/24
Line Impedance Stabilization Network	Schwarzbeck	NSLK 8127	8127-516	2020/09/26	2021/09/25
Pulse Limiter	ROHDE & SCHWARZ	ESH3-Z2	101933	2020/09/17	2021/09/16
Cable-6m(9k~300M)	NA	EMC5D-BM-BM-6	130605	2020/09/18	2021/09/17
E3	AUDIX	v8.2014-8-6	RK-000531	NA	NA



## 4. Antenna Requirements

### 4.1 Standard Applicable

For intentional device, according to FCC 47 CFR Section 15.203, an intentional radiator shall be designed to ensure that no antenna other than that furnished by the responsible party shall be used with the device.

And according to FCC 47 CFR Section 15.247 (b), if transmitting antennas of directional gain greater than 6dBi are used, the power shall be reduced by the amount in dB that the directional gain of the antenna exceeds 6dBi.

### 4.2 Antenna Construction and Directional Gain

Antenna Type	PCB Antenna
Antenna Gain	3.03 dBi



## 5. Test of AC Power Line Conducted Emission

### 5.1 Test Limit

Conducted Emissions were measured from 150 kHz to 30 MHz with a bandwidth of 9 KHz, according to the methods defined in ANSI C63.4-2014. The EUT was placed on a nonmetallic stand in a shielded room 0.8 meters above the ground plane. The interface cables and equipment positioning were varied within limits of reasonable applications to determine the position produced maximum conducted emissions.

Frequency (MHz)	Quasi Peak (dB $\mu$ V)	Average (dB $\mu$ V)
0.15 – 0.5	66-56*	56-46*
0.5 – 5.0	56	46
5.0 – 30.0	60	50

\*Decreases with the logarithm of the frequency.

### 5.2 Test Procedures

- a. The EUT was placed 0.4 meter from the conducting wall of the shielding room was kept at least 80 centimeters from any other grounded conducting surface.
- b. Connect EUT to the power mains through a line impedance stabilization network (LISN).
- c. All the support units are connecting to the other LISN.
- d. The LISN provides 50 ohm coupling impedance for the measuring instrument.
- e. The FCC states that a 50 ohm, 50 micro-Henry LISN should be used.
- f. Both sides of AC line were checked for maximum conducted interference.
- g. The frequency range from 150 kHz to 30 MHz was searched.
- h. Set the test-receiver system to Peak Detect Function and Specified Bandwidth with Maximum Hold Mode.



### 5.3 Typical Test Setup

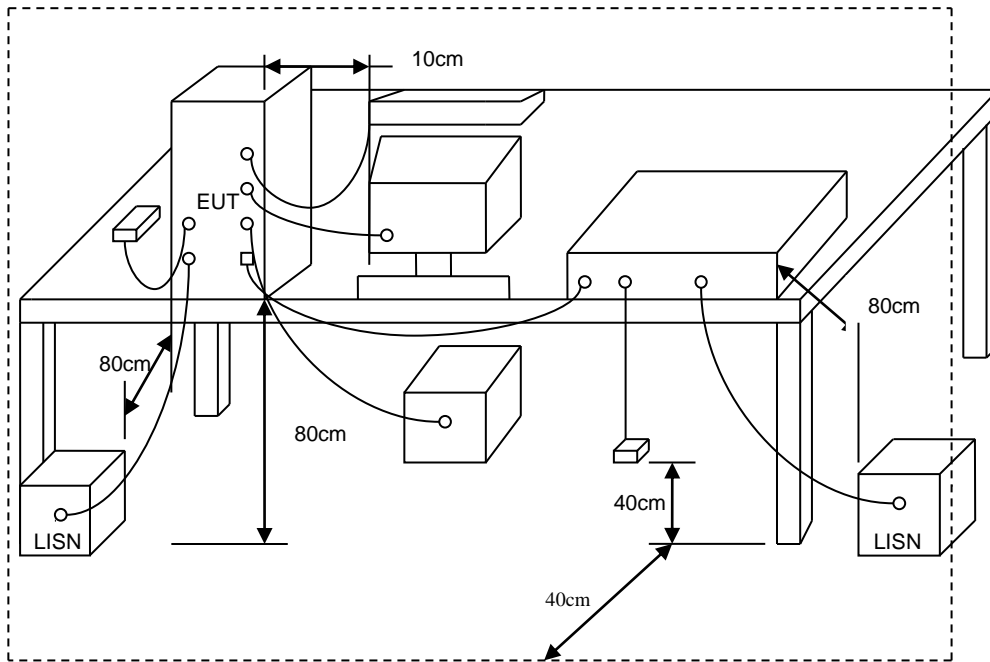



5.4 Test Result and Data

Power	: AC 120V / 60Hz	Pol/Phase	: LINE
Test Mode	: Mode 1		:

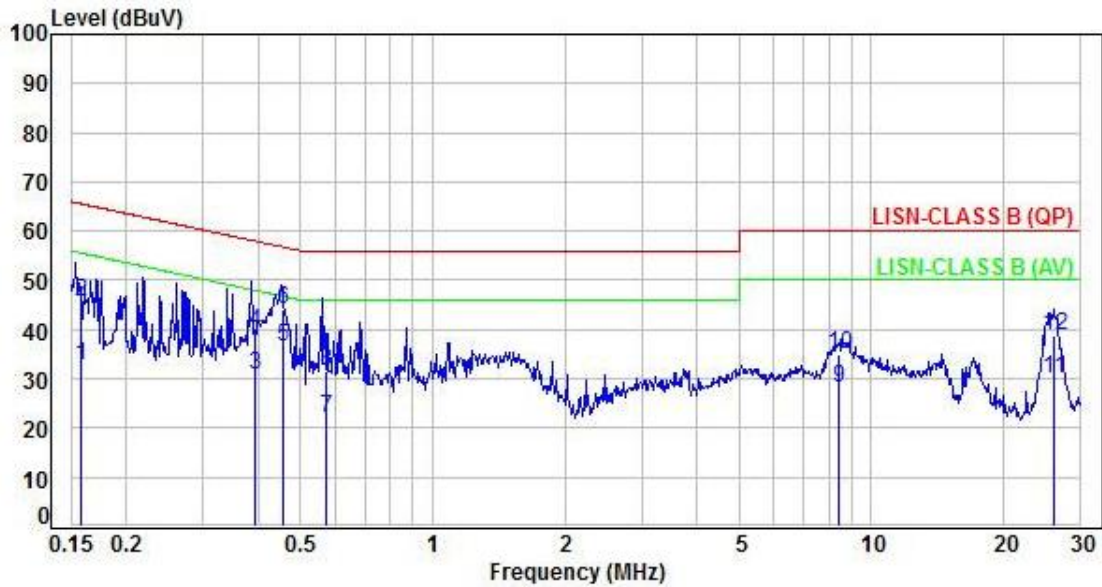

No.	Frequency (MHz)	Factor (dB)	Reading (dBUV)	Level (dBUV)	Limit (dBUV)	Margin (dB)	Detector	P/F
1	0.16	9.96	22.71	32.67	55.59	-22.92	Average	P
2	0.16	9.96	35.68	45.64	65.59	-19.95	QP	P
3	0.39	9.97	20.65	30.62	47.97	-17.35	Average	P
4	0.39	9.97	29.52	39.49	57.97	-18.48	QP	P
5	0.45	9.97	26.63	36.60	46.79	-10.19	Average	P
6	0.45	9.97	34.32	44.29	56.79	-12.50	QP	P
7	0.57	9.99	12.16	22.15	46.00	-23.85	Average	P
8	0.57	9.99	21.50	31.49	56.00	-24.51	QP	P
9	8.44	10.51	17.61	28.12	50.00	-21.88	Average	P
10	8.44	10.51	24.47	34.98	60.00	-25.02	QP	P
11	26.05	11.56	18.52	30.08	50.00	-19.92	Average	P
12	26.05	11.56	27.07	38.63	60.00	-21.37	QP	P

Note: Level=Reading+Factor  
 Margin=Level-Limit  
 Factor=(LISN or ISN or Current Probe)Factor + Cable Loss



Power	: AC 120V / 60Hz	Pol/Phase	: NEUTRAL
Test Mode	: Mode 1		

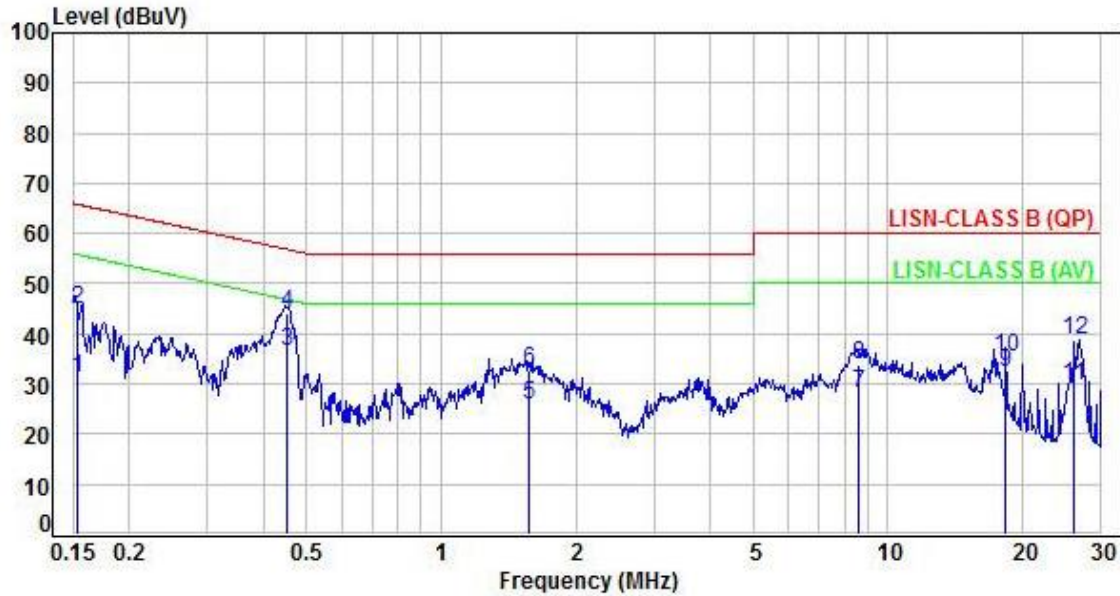

No.	Frequency (MHz)	Factor (dB)	Reading (dBuV)	Level (dBuV)	Limit (dBuV)	Margin (dB)	Detector	P/F
1	0.15	9.97	21.21	31.18	55.84	-24.66	Average	P
2	0.15	9.97	34.71	44.68	65.84	-21.16	QP	P
3	0.45	9.98	26.58	36.56	46.86	-10.30	Average	P
4	0.45	9.98	34.05	44.03	56.86	-12.83	QP	P
5	1.57	10.06	15.80	25.86	46.00	-20.14	Average	P
6	1.57	10.06	22.49	32.55	56.00	-23.45	QP	P
7	8.64	10.43	17.54	27.97	50.00	-22.03	Average	P
8	8.64	10.43	23.38	33.81	60.00	-26.19	QP	P
9	18.30	11.02	21.15	32.17	50.00	-17.83	Average	P
10	18.30	11.02	24.22	35.24	60.00	-24.76	QP	P
11	26.07	11.41	18.32	29.73	50.00	-20.27	Average	P
12	26.07	11.41	27.33	38.74	60.00	-21.26	QP	P

Note: Level=Reading+Factor  
 Margin=Level-Limit  
 Factor=(LISN or ISN or Current Probe)Factor + Cable Loss





## 6. Test of Spurious Emission (Radiated)

### 6.1 Test Limit

In any 100kHz bandwidth outside the frequency band in which the spread spectrum or digitally modulated intentional radiator is operating, the radio frequency power that is produced by the intentional radiator shall be at least 20dB below that in the 100kHz bandwidth within the band that contains the highest level of the desired power, based on either an RF conducted or a radiated measurement. If the transmitter measurement is based on the maximum conducted output power, the attenuation required under this paragraph shall be 30dB instead of 20dB. In addition, radiated emissions which fall in section 15.205(a) the restricted bands must also comply with the radiated emission limit specified in section 15.209(a).

Frequency (MHz)	Field Strength (microvolt/meter)	Measurement Distance (meters)
0.009 ~ 0.490	2400/F(kHz)	300
0.490 ~ 1.705	24000/F(kHz)	30
1.705 ~ 30.0	30	30
30 ~ 88	100	3
88 ~ 216	150	3
216 ~ 960	200	3
Above 960	500	3



## 6.2 Test Procedures

- a. The EUT was placed on a rotatable table top 0.8 meter above ground.
- b. The EUT was set 3 meters from the interference receiving antenna which was mounted on the top of a variable height antenna tower.
- c. The table was rotated 360 degrees to determine the position of the highest radiation.
- d. The antenna is a broadband antenna and its height is varied between one meter and four meters above ground to find the maximum value of the field strength both horizontal polarization and vertical polarization of the antenna are set to make the measurement.
- e. For each suspected emission the EUT was arranged to its worst case and then tune the antenna tower (from 1 M to 4 M) and turn table (from 0 degree to 360 degrees) to find the maximum reading.
- f. Set the test-receiver system to Peak or CISPR quasi-peak Detect Function and specified bandwidth with Maximum Hold Mode.
- g. If the emission level of the EUT in peak mode was 3 dB lower than the limit specified, then testing will be stopped and peak values of EUT will be reported, otherwise, the emissions which do not have 3 dB margin will be repeated one by one using the quasi-peak method and reported.
- h. For testing above 1GHz, the emission level of the EUT in peak mode was 20dB lower than average limit (that means the emission level in peak mode also complies with the limit in average mode), then testing will be stopped and peak values of EUT will be reported, otherwise, the emissions will be measured in average mode again and reported.
- i. "Cone of radiation" has been considered to be 3dB bandwidth of the measurement antenna.

Note: The supporting fixture shall permit orientation of the EUT in each of three orthogonal axis positions such that emissions from the EUT are maximized.  
(X-AXIS is the worst.)



### 6.3 Typical Test Setup

Below 30MHz test setup

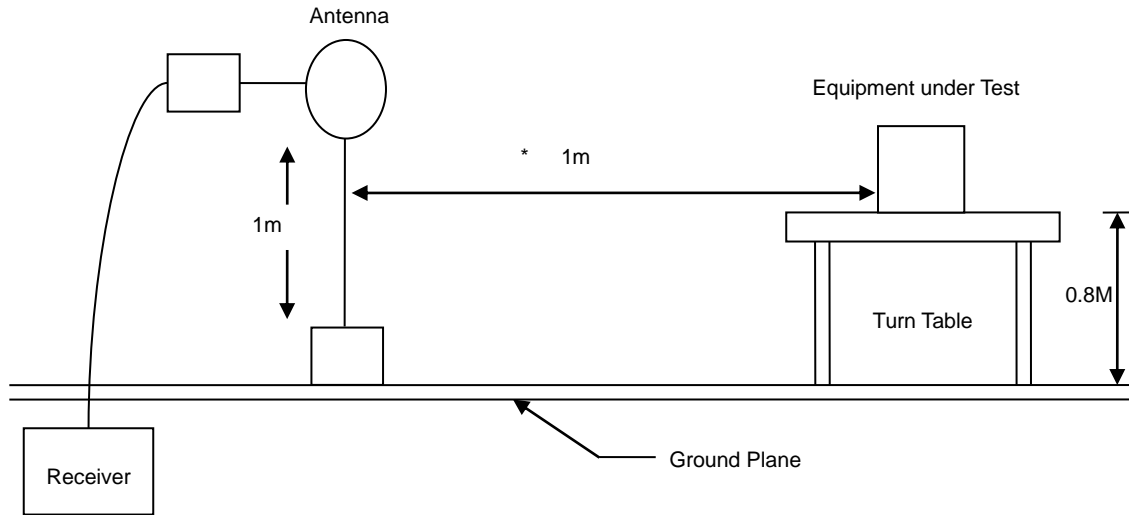

30MHz- 1GHz Test Setup

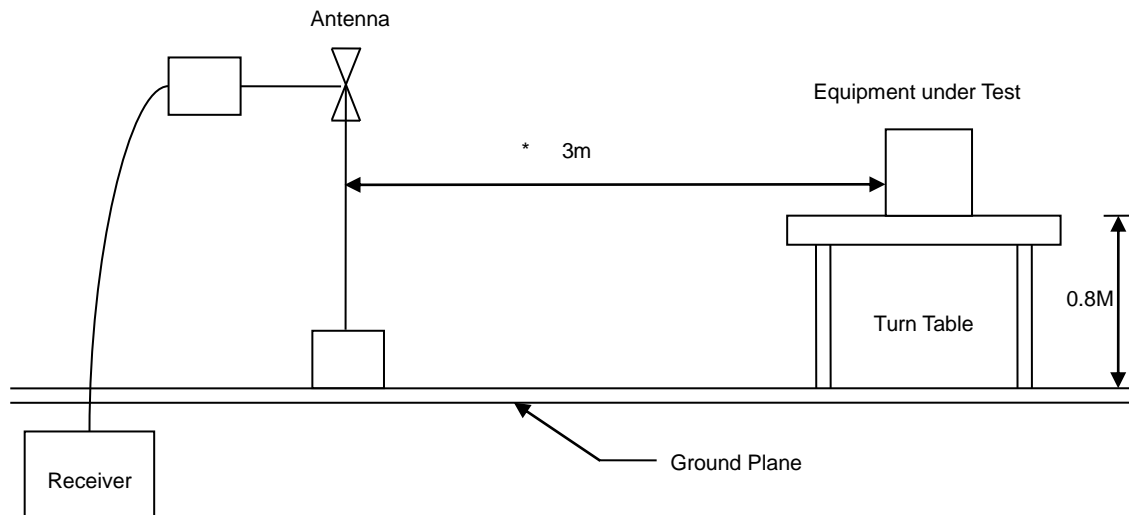



Above 1GHz Test Setup

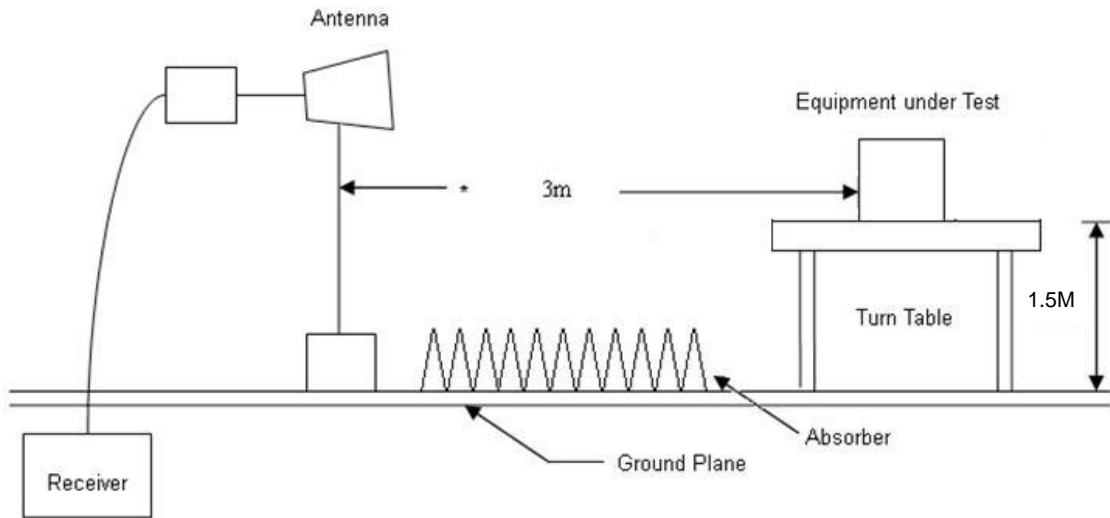



### 6.4 Test Result and Data (9kHz ~ 30MHz)

The 9kHz - 30MHz spurious emission is under limit 20dB more.

### 6.5 Test Result and Data (30MHz ~ 1GHz)

Power	: AC 120V / 60Hz	Pol/Phase	: VERTICAL
Test Mode	: Mode 1		:

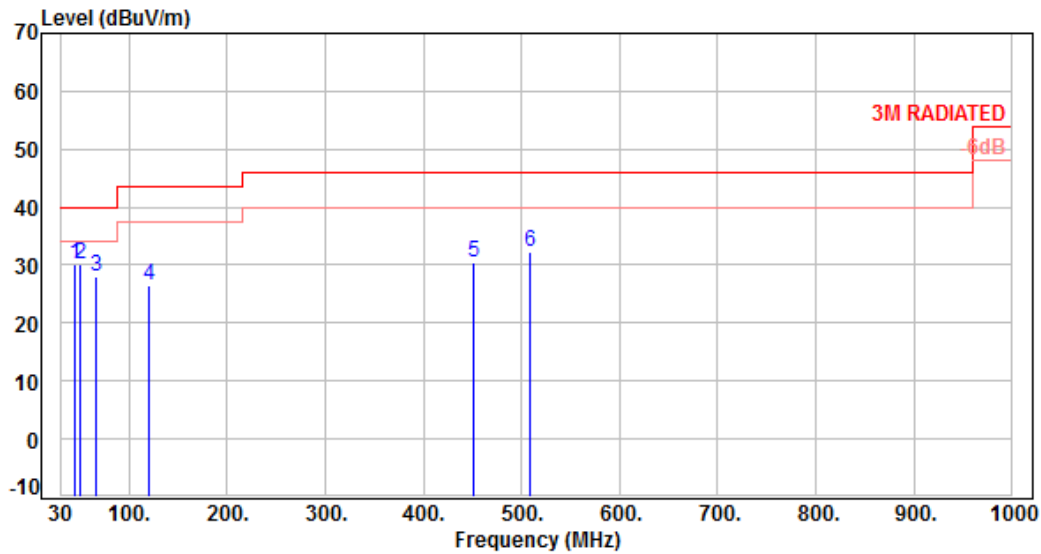

No.	Frequency (MHz)	Factor (dB)	Reading (dBuV)	Level (dBuV/m)	Limit (dBuV/m)	Margin (dB)	Detector	Height (cm)	Azimuth (deg)	P/F
1	45.52	-10.67	40.74	30.07	40.00	-9.93	Peak	400	360	P
2	49.40	-10.66	40.75	30.09	40.00	-9.91	Peak	400	360	P
3	66.86	-12.67	40.55	27.88	40.00	-12.12	Peak	400	360	P
4	121.18	-12.92	39.30	26.38	43.50	-17.12	Peak	400	360	P
5	450.98	-5.78	36.30	30.52	46.00	-15.48	Peak	400	360	P
6	509.18	-4.57	36.89	32.32	46.00	-13.68	Peak	400	360	P

Note: Level=Reading+Factor  
 Margin=Level-Limit  
 Factor=Antenna Factor + cable loss - Amplifier Factor



Power	: AC 120V / 60Hz	Pol/Phase	: HORIZONTAL
Test Mode	: Mode 1		:

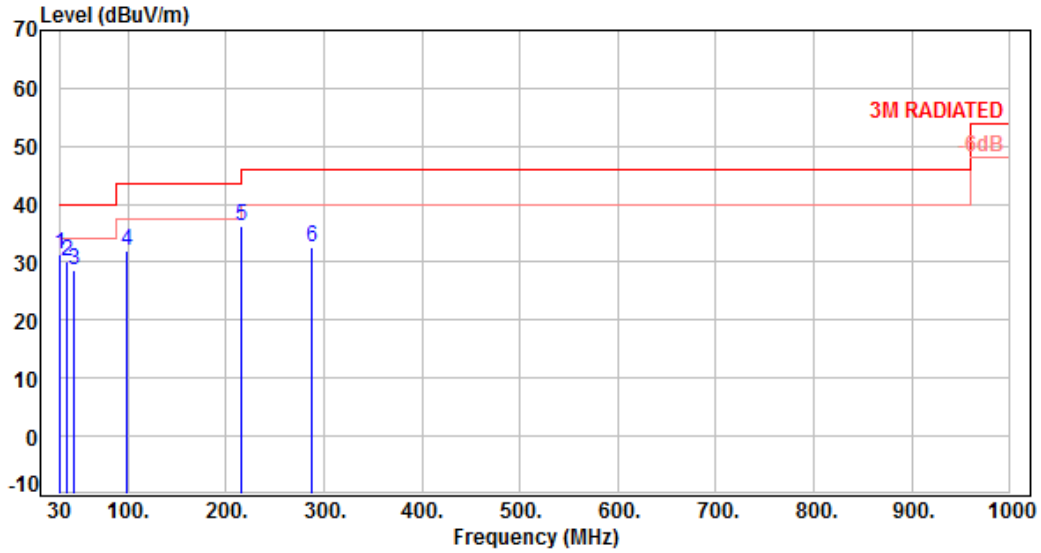

No.	Frequency (MHz)	Factor (dB)	Reading (dBuV)	Level (dBuV/m)	Limit (dBuV/m)	Margin (dB)	Detector	Height (cm)	Azimuth (deg)	P/F
1	30.00	-11.62	42.87	31.25	40.00	-8.75	Peak	400	360	P
2	37.76	-11.33	41.48	30.15	40.00	-9.85	Peak	400	360	P
3	45.52	-10.67	39.44	28.77	40.00	-11.23	Peak	400	360	P
4	97.90	-16.16	48.00	31.84	43.50	-11.66	Peak	400	360	P
5	216.24	-12.86	49.10	36.24	46.00	-9.76	Peak	400	360	P
6	288.02	-10.00	42.58	32.58	46.00	-13.42	Peak	400	360	P

Note: Level=Reading+Factor  
 Margin=Level-Limit  
 Factor=Antenna Factor + cable loss - Amplifier Factor



6.6 Test Result and Data (1GHz ~ 25GHz)

Power	: AC 120V / 60Hz	Pol/Phase	: VERTICAL
Test Mode	: Mode 1, CH00		

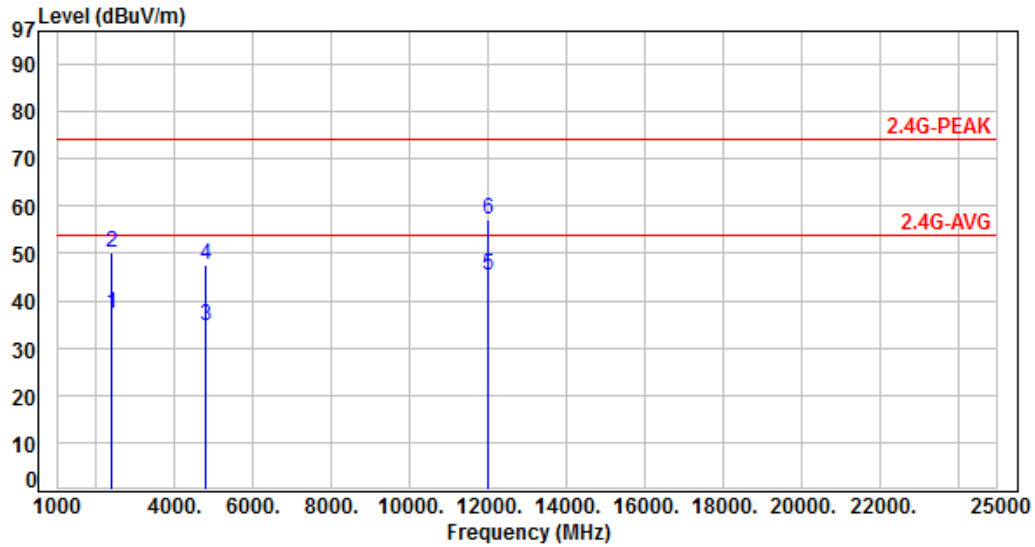

No.	Frequency (MHz)	Factor (dB)	Reading (dBuV)	Level (dBuV/m)	Limit (dBuV/m)	Margin (dB)	Detector	Height (cm)	Azimuth (deg)	P/F
1	2390.00	-2.98	40.07	37.09	54.00	-16.91	Average	100	164	P
2	2390.00	-2.98	53.13	50.15	74.00	-23.85	Peak	100	164	P
3	4804.00	4.56	30.24	34.80	54.00	-19.20	Average	100	124	P
4	4804.00	4.56	42.84	47.40	74.00	-26.60	Peak	100	124	P
5	12010.00	14.61	30.67	45.28	54.00	-8.72	Average	100	186	P
6	12010.00	14.61	42.73	57.34	74.00	-16.66	Peak	100	186	P

Note: Level=Reading+Factor  
Margin=Level-Limit  
Factor=Antenna Factor + cable loss - Amplifier Factor



Power	: AC 120V / 60Hz	Pol/Phase	: HORIZONTAL
Test Mode	: Mode 1, CH00		:

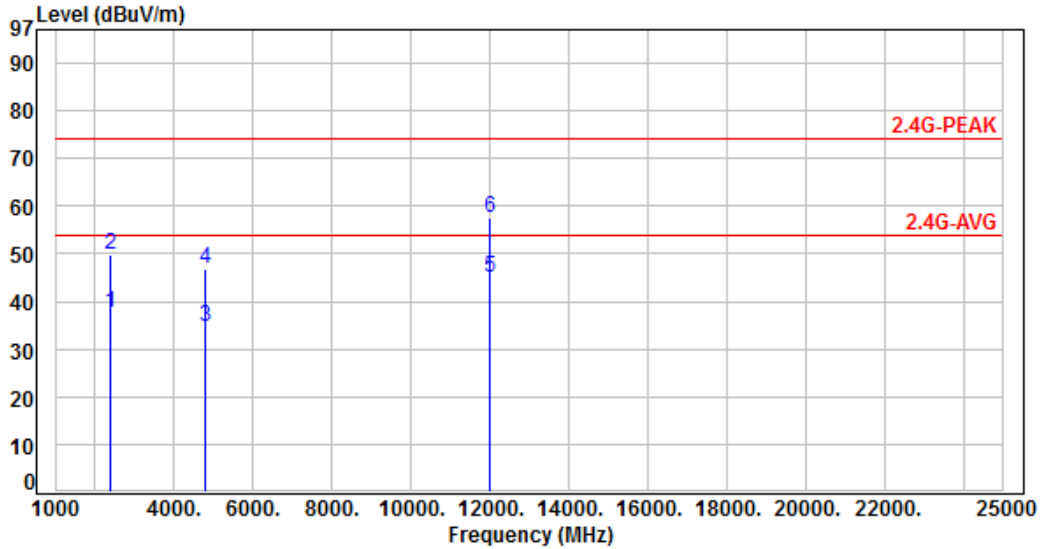

No.	Frequency (MHz)	Factor (dB)	Reading (dBuV)	Level (dBuV/m)	Limit (dBuV/m)	Margin (dB)	Detector	Height (cm)	Azimuth (deg)	P/F
1	2390.00	-2.98	40.68	37.70	54.00	-16.30	Average	147	358	P
2	2390.00	-2.98	52.81	49.83	74.00	-24.17	Peak	147	358	P
3	4804.00	4.56	29.98	34.54	54.00	-19.46	Average	132	346	P
4	4804.00	4.56	42.34	46.90	74.00	-27.10	Peak	132	346	P
5	12010.00	14.61	30.48	45.09	54.00	-8.91	Average	161	322	P
6	12010.00	14.61	42.80	57.41	74.00	-16.59	Peak	161	322	P

Note: Level=Reading+Factor  
 Margin=Level-Limit  
 Factor=Antenna Factor + cable loss - Amplifier Factor





Power	: AC 120V / 60Hz	Pol/Phase	: VERTICAL
Test Mode	: Mode 1, CH19		:

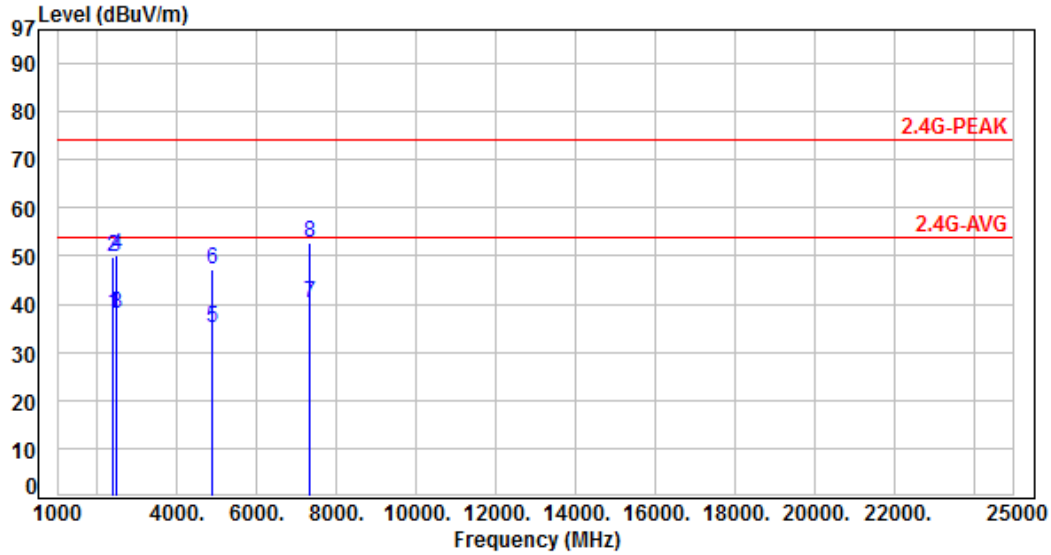

No.	Frequency (MHz)	Factor (dB)	Reading (dBuV)	Level (dBuV/m)	Limit (dBuV/m)	Margin (dB)	Detector	Height (cm)	Azimuth (deg)	P/F
1	2390.00	-2.98	40.82	37.84	54.00	-16.16	Average	100	166	P
2	2390.00	-2.98	52.67	49.69	74.00	-24.31	Peak	100	166	P
3	2483.50	-2.75	40.66	37.91	54.00	-16.09	Average	100	166	P
4	2483.50	-2.75	52.96	50.21	74.00	-23.79	Peak	100	166	P
5	4880.00	4.80	30.09	34.89	54.00	-19.11	Average	100	121	P
6	4880.00	4.80	42.44	47.24	74.00	-26.76	Peak	100	121	P
7	7320.00	9.71	30.67	40.38	54.00	-13.62	Average	100	198	P
8	7320.00	9.71	43.13	52.84	74.00	-21.16	Peak	100	198	P

Note: Level=Reading+Factor  
Margin=Level-Limit  
Factor=Antenna Factor + cable loss - Amplifier Factor



Power	: AC 120V / 60Hz	Pol/Phase	: HORIZONTAL
Test Mode	: Mode 1, CH19		:

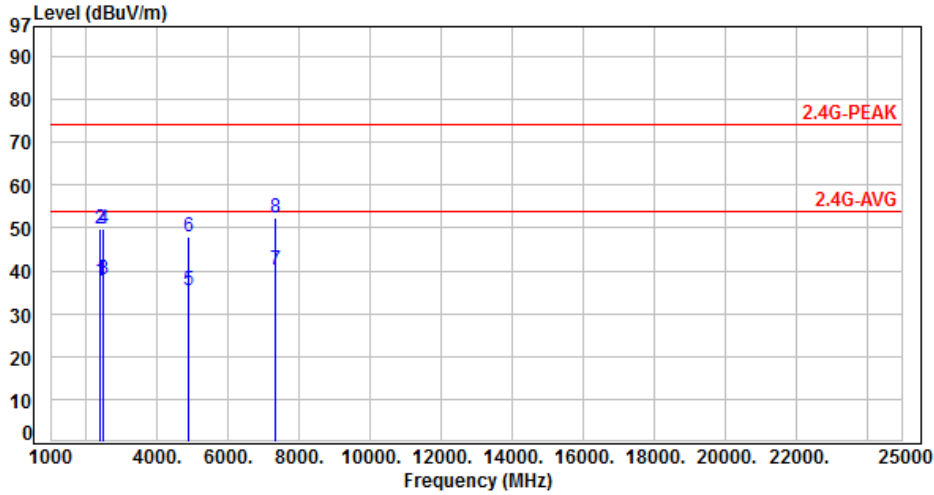

No.	Frequency (MHz)	Factor (dB)	Reading (dBuV)	Level (dBuV/m)	Limit (dBuV/m)	Margin (dB)	Detector	Height (cm)	Azimuth (deg)	P/F
1	2390.00	-2.98	40.61	37.63	54.00	-16.37	Average	144	360	P
2	2390.00	-2.98	52.72	49.74	74.00	-24.26	Peak	144	360	P
3	2483.50	-2.75	40.60	37.85	54.00	-16.15	Average	144	360	P
4	2483.50	-2.75	52.64	49.89	74.00	-24.11	Peak	144	360	P
5	4880.00	4.80	30.76	35.56	54.00	-18.44	Average	127	347	P
6	4880.00	4.80	42.97	47.77	74.00	-26.23	Peak	127	347	P
7	7320.00	9.71	30.66	40.37	54.00	-13.63	Average	164	319	P
8	7320.00	9.71	42.73	52.44	74.00	-21.56	Peak	164	319	P

Note: Level=Reading+Factor  
 Margin=Level-Limit  
 Factor=Antenna Factor + cable loss - Amplifier Factor



Power	: AC 120V / 60Hz	Pol/Phase	: VERTICAL
Test Mode	: Mode 1, CH39		:

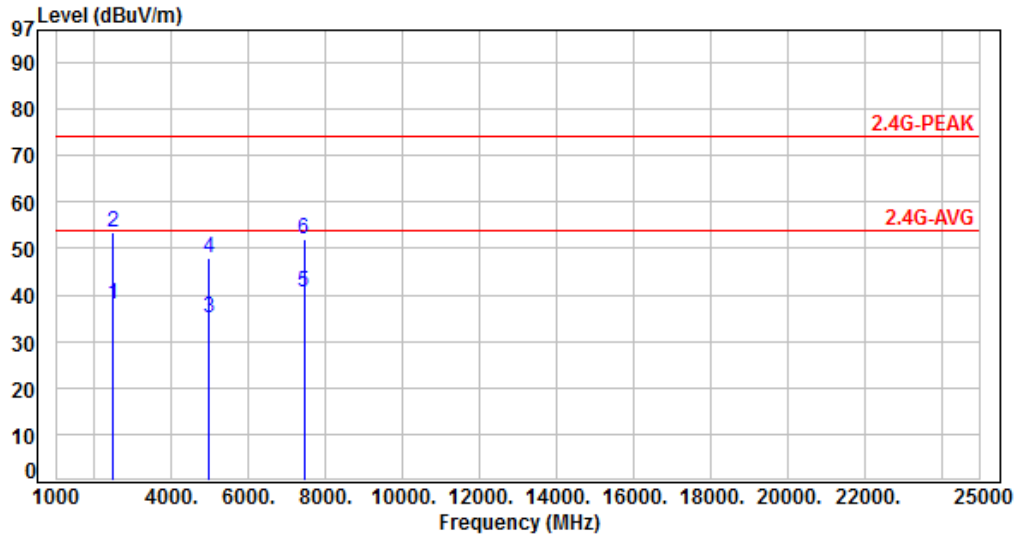

No.	Frequency (MHz)	Factor (dB)	Reading (dBuV)	Level (dBuV/m)	Limit (dBuV/m)	Margin (dB)	Detector	Height (cm)	Azimuth (deg)	P/F
1	2483.50	-2.75	40.66	37.91	54.00	-16.09	Average	100	169	P
2	2483.50	-2.75	56.39	53.64	74.00	-20.36	Peak	100	169	P
3	4960.00	5.16	29.80	34.96	54.00	-19.04	Average	100	141	P
4	4960.00	5.16	42.77	47.93	74.00	-26.07	Peak	100	141	P
5	7440.00	9.83	30.59	40.42	54.00	-13.58	Average	100	198	P
6	7440.00	9.83	42.34	52.17	74.00	-21.83	Peak	100	198	P

Note: Level=Reading+Factor  
 Margin=Level-Limit  
 Factor=Antenna Factor + cable loss - Amplifier Factor



Power	: AC 120V / 60Hz	Pol/Phase	: HORIZONTAL
Test Mode	: Mode 1, CH39		:

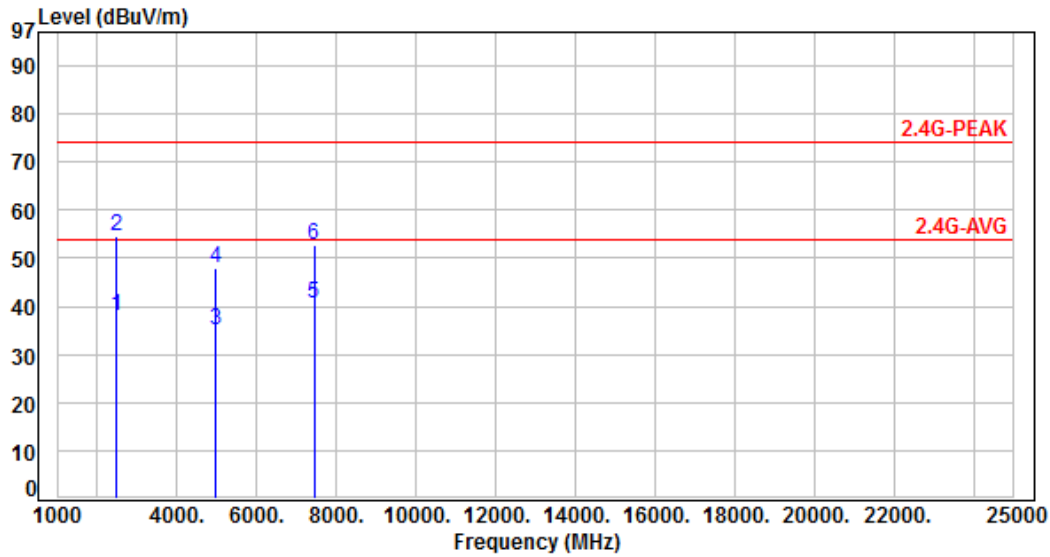

No.	Frequency (MHz)	Factor (dB)	Reading (dBuV)	Level (dBuV/m)	Limit (dBuV/m)	Margin (dB)	Detector	Height (cm)	Azimuth (deg)	P/F
1	2483.50	-2.75	40.85	38.10	54.00	-15.90	Average	142	360	P
2	2483.50	-2.75	57.26	54.51	74.00	-19.49	Peak	142	360	P
3	4960.00	5.16	29.92	35.08	54.00	-18.92	Average	159	334	P
4	4960.00	5.16	42.70	47.86	74.00	-26.14	Peak	159	334	P
5	7440.00	9.83	30.69	40.52	54.00	-13.48	Average	126	309	P
6	7440.00	9.83	42.90	52.73	74.00	-21.27	Peak	126	309	P

Note: Level=Reading+Factor  
 Margin=Level-Limit  
 Factor=Antenna Factor + cable loss - Amplifier Factor



### 6.7 Restricted Bands of Operation

Only spurious emissions are permitted in any of the frequency bands listed below:

MHz	MHz	MHz	GHz
0.09000 – 0.11000	16.42000 – 16.42300	399.9 – 410.0	4.500 – 5.250
0.49500 – 0.505**	16.69475 – 16.69525	608.0 – 614.0	5.350 – 5.460
2.17350 – 2.19050	16.80425 – 16.80475	960.0 – 1240.0	7.250 – 7.750
4.12500 – 4.12800	25.50000 – 25.67000	1300.0 – 1427.0	8.025 – 8.500
4.17725 – 4.17775	37.50000 – 38.25000	1435.0 – 1626.5	9.000 – 9.200
4.20725 – 4.20775	73.00000 – 74.60000	1645.5 – 1646.5	9.300 – 9.500
6.21500 – 6.21800	74.80000 – 75.20000	1660.0 – 1710.0	10.600 – 12.700
6.26775 – 6.26825	108.00000 – 121.94000	1718.8 – 1722.2	13.250 – 13.400
6.31175 – 6.31225	123.00000 – 138.00000	2200.0 – 2300.0	14.470 – 14.500
8.29100 – 8.29400	149.90000 – 150.05000	2310.0 – 2390.0	15.350 – 16.200
8.36200 – 8.36600	156.52475 – 156.52525	2483.5 – 2500.0	17.700 – 21.400
8.37625 – 8.38675	156.70000 – 156.90000	2655.0 – 2900.0	22.010 – 23.120
8.41425 – 8.41475	162.01250 – 167.17000	3260.0 – 3267.0	23.600 – 24.000
12.29000 – 12.29300	167.72000 – 173.20000	3332.0 – 3339.0	31.200 – 31.800
12.51975 – 12.52025	240.00000 – 285.00000	3345.8 – 3358.0	36.430 – 36.500
12.57675 – 12.57725	322.00000 – 335.40000	3600.0 – 4400.0	Above 38.6
13.36000 – 13.41000			

\*\* : Until February 1, 1999, this restricted band shall be 0.490-0.510 MHz



## 7. Test of Spurious Emission (Conducted)

### 7.1 Test Limit

Below -20dB of the highest emission level of operating band (In 100 kHz Resolution Bandwidth)

### 7.2 Test Procedure

- a. The transmitter output was connected to the spectrum analyzer via a low loss cable.
- b. Set RBW of spectrum analyzer to 100 KHz and VBW of spectrum analyzer to 300 KHz with convenient frequency span including 100 KHz bandwidth from band edge.
- c. Peak conducted output power measured within any 100 kHz outside the authorized frequency band shall be attenuated by at least 20dB relative to the maximum measured in-band peak PSD level.
- d. The band edges was measured and recorded.

### 7.3 Test Setup Layout

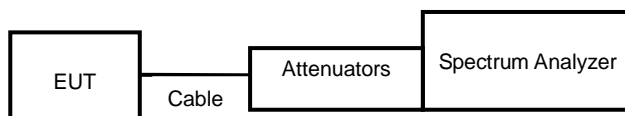

### 7.4 Test Result and Data

Note: Test plots refer to the following pages.



Modulation Type:  $\pi/4$  DQPSK  
CH00



Modulation Type:  $\pi/4$  DQPSK  
CH19

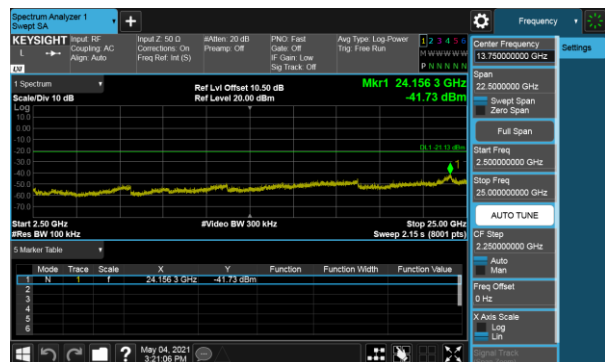
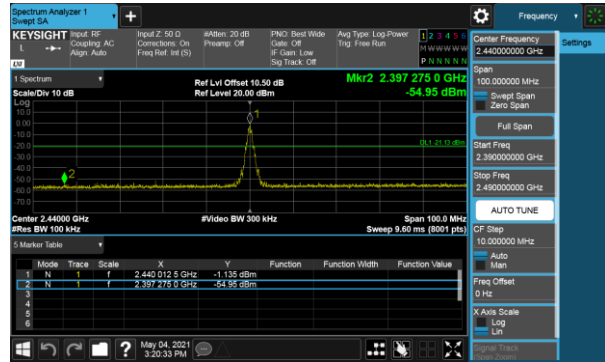
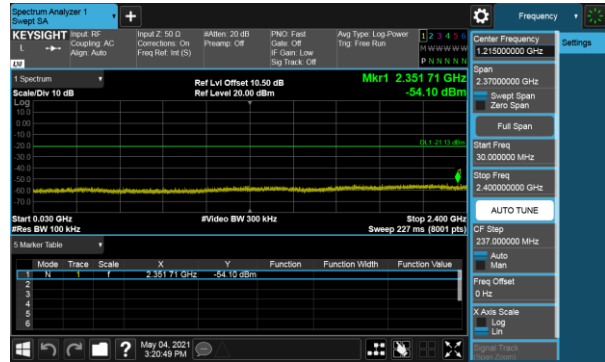



Modulation Type:  $\pi/4$  DQPSK  
CH39

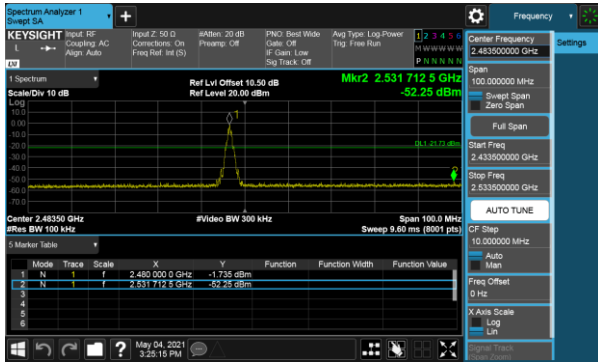





## 8. On Time, Duty Cycle and Measurement methods

### 8.1 Test Limit

None; for reporting purposes only.

### 8.2 Test Procedure

Zero-Span Spectrum Analyzer Method.

### 8.3 Test Setup Layout

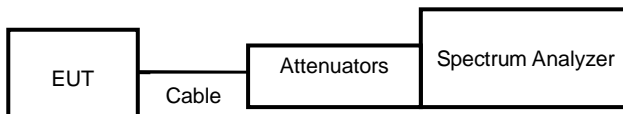

### 8.4 Test Result and Data

Modulation Type	On Time (ms)	Period Time (ms)	Duty Cycle (%)
$\pi/4$ DQPSK	0.05	1.22	4.10%



Modulation Type:  $\pi/4$  DQPSK

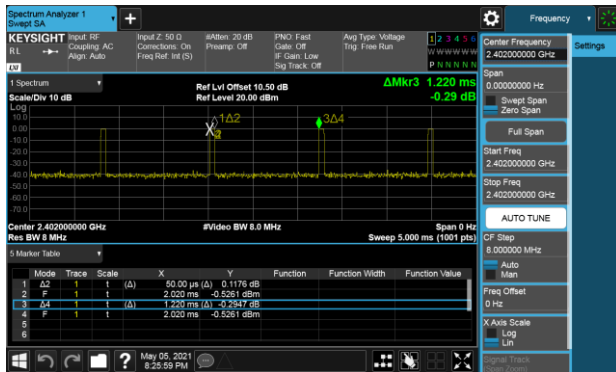



### 9. 6dB Bandwidth Measurement Data

#### 9.1 Test Limit

The minimum of 6dB Bandwidth Measurement is 0.5 MHz.

#### 9.2 Test Procedures

- a. The transmitter output was connected to the spectrum analyzer.
- b. Set RBW of spectrum analyzer to 100 KHz and VBW to 300 KHz.
- c. The 6 dB bandwidth is defined as the total spectrum the power of which is higher than peak power minus 6 dB.
- d. The 6dB Bandwidth was measured and recorded.

#### 9.3 Test Setup Layout

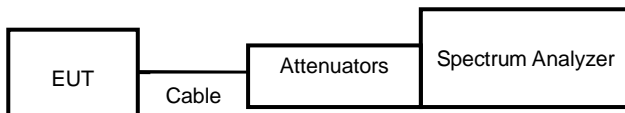

#### 9.4 Test Result and Data

Modulation Type	Channel	Frequency (MHz)	6dB Bandwidth (KHz)	Limit (KHz)
$\pi/4$ DQPSK(2Mbps)	0	2402	792.00	500
	19	2440	798.00	500
	39	2480	807.00	500



Modulation Type:  $\pi/4$  DQPSK  
CH00

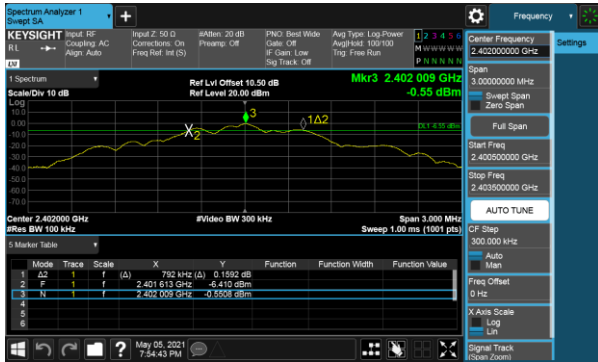

Modulation Type:  $\pi/4$  DQPSK  
CH19

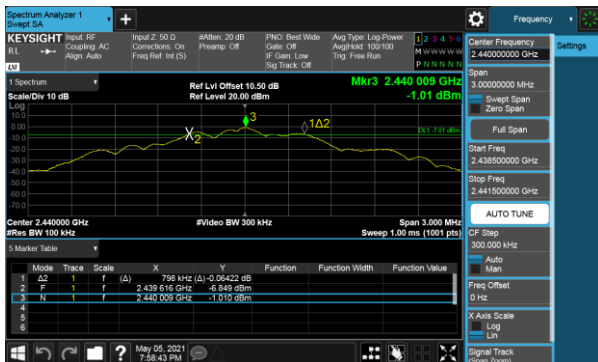

Modulation Type:  $\pi/4$  DQPSK  
CH39





## 10. Maximum Peak and Average Output Power

### 10.1 Test Limit

The Maximum Peak Output Power Measurement is 30dBm.

### 10.2 Test Procedures

The antenna port (RF output) of the EUT was connected to the input (RF input) of a power meter. Power was read directly from the meter and cable loss connection was added to the reading to obtain power at the EUT antenna terminal. The EUT Output Power was set to maximum to produce the worse case test result.

### 10.3 Test Setup Layout

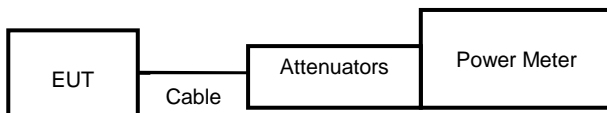

### 10.4 Test Result and Data

Power Set	Modulation Type	Channel	Frequency (MHz)	Power Output (dBm)		Power Output (mW)	
				Peak	Average	Peak	Average
00	$\pi/4$ DQPSK	0	2402	-0.67	-0.90	0.857	0.813
00		19	2440	-1.14	-1.44	0.769	0.718
00		39	2480	-1.76	-2.11	0.667	0.615

\*Average Power is for reference only



### 11. Power Spectral Density

#### 11.1 Test Limit

The Maximum of Power Spectral Density Measurement is 8dBm.

#### 11.2 Test Procedures

- a. The transmitter output was connected to spectrum analyzer.
- b. The spectrum analyzer’s resolution bandwidth were set at 3KHz RBW and 10KHz VBW as that of the fundamental frequency. Set the sweep time=auto couple.
- c. The power spectral density was measured and recorded.

#### 11.3 Test Setup Layout

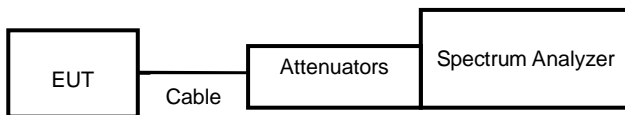

#### 11.4 Test Result and Data

Modulation Type	Channel	Frequency (MHz)	Maximum Power Density of 3KHz Bandwidth(dBm)	Limit
$\pi/4$ DQPSK(2Mbps)	0	2402	-14.76	8.00
	19	2440	-14.30	8.00
	39	2480	-15.30	8.00



Modulation Type:  $\pi/4$  DQPSK  
CH00

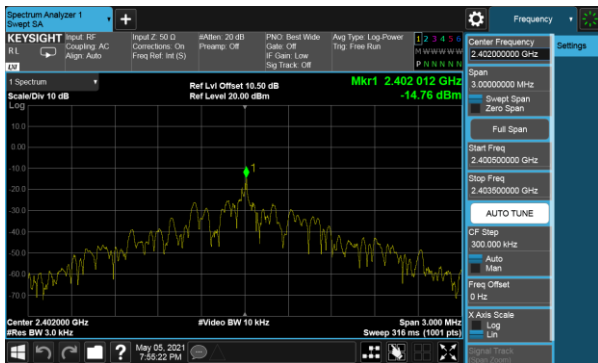

Modulation Type:  $\pi/4$  DQPSK  
CH19



Modulation Type:  $\pi/4$  DQPSK  
CH39

