



FCC RADIO TEST REPORT

Applicant : SteelSeries ApS

Address : 656 W Randolph St., Suite 3E Chicago, IL 60661,
USA

Equipment : Wireless Headset

Model No. : HS31

Trade Name : 

FCC ID : ZHK-HS31

I HEREBY CERTIFY THAT :

The sample was received on Oct. 21, 2021 and the testing was completed on Jan. 03, 2022 at CerpPASS Technology Corp. The test result refers exclusively to the test presented test model / sample. Without written approval of CerpPASS Technology Corp., the test report shall not be reproduced except in full.

Approved by:

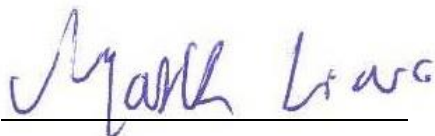

Mark Liao / Supervisor

Laboratory Accreditation:

CerpPASS Technology Corporation Test Laboratory





CONTENTS

- 1. Summary of Test Procedure and Test Results..... 5**
 - 1.1 Applicable Standards 5
- 2. Test Configuration of Equipment under Test 6**
 - 2.1 Feature of Equipment under Test..... 6
 - 2.2 Carrier Frequency of Channels 7
 - 2.3 Test Mode and Test Software 8
 - 2.4 Description of Test System..... 9
 - 2.5 General Information of Test..... 10
 - 2.6 Measurement Uncertainty 11
- 3. Test Equipment and Ancillaries Used for Tests 12**
- 4. Antenna Requirements 14**
 - 4.1 Standard Applicable 14
 - 4.2 Antenna Construction and Directional Gain..... 14
- 5. Test of AC Power Line Conducted Emission 15**
 - 5.1 Test Limit 15
 - 5.2 Test Procedures 15
 - 5.3 Typical Test Setup 16
 - 5.4 Test Result and Data 17
 - 5.5 Test Photographs 19
- 6. Test of Spurious Emission (Radiated) 20**
 - 6.1 Test Limit 20
 - 6.2 Test Procedures 21
 - 6.3 Typical Test Setup 22
 - 6.4 Test Result and Data (9kHz ~ 30MHz)..... 23
 - 6.5 Test Result and Data (30MHz ~ 1GHz)..... 23
 - 6.6 Test Result and Data (1GHz ~ 25GHz)..... 25
 - 6.7 Restricted Bands of Operation 37
 - 6.8 Test Photographs (30MHz ~ 1GHz)..... 38
 - 6.9 Test Photographs (1GHz ~ 25GHz) 39
- 7. Test of Spurious Emission (Conducted)..... 41**
 - 7.1 Test Limit 41
 - 7.2 Test Procedure 41
 - 7.3 Test Setup Layout 41
 - 7.4 Test Result and Data 41
- 8. On Time, Duty Cycle and Measurement methods 46**
 - 8.1 Test Limit 46
 - 8.2 Test Procedure 46
 - 8.3 Test Setup Layout 46
 - 8.4 Test Result and Data 46
- 9. 6dB Bandwidth Measurement Data 48**
 - 9.1 Test Limit 48



9.2 Test Procedures 48

9.3 Test Setup Layout 48

9.4 Test Result and Data 48

10. Maximum Average Output Power 50

10.1 Test Limit 50

10.2 Test Procedures 50

10.3 Test Setup Layout 50

10.4 Test Result and Data 51

11. Power Spectral Density 52

11.1 Test Limit 52

11.2 Test Procedures 52

11.3 Test Setup Layout 52

11.4 Test Result and Data 52

12. Radio Frequency Exposure 54

12.1 Applicable Standards 54

12.2 EUT Specification 54

12.3 Test Results 55



History of this test report

Report No.	Issued Date	Description
21090127-TRFCC02	Jan. 10, 2022	Original



1. Summary of Test Procedure and Test Results

1.1 Applicable Standards

ANSI C63.10:2013

FCC Rules and Regulations Part 15 Subpart C §15.247

FCC Rule	Description of Test	Result
15.203	Antenna Requirement	PASS
15.207	AC Power Line Conducted Emission	PASS
15.209 15.205	Radiated Spurious Emission	PASS
15.247(d)	Conducted Spurious Emission	PASS
15.247(a)(2)	6dB Bandwidth	PASS
15.247(b)	Maximum Output Power	PASS
15.247(e)	Power Spectral Density	PASS
2.1093	Radio Frequency Exposure	PASS

*The lab has reduced the uncertainty risk factor from test equipment, environment and staff technicians which according to the standard on contract. Therefore, the test result will only be determined by standard requirement.

*This EUT has been also tested and compiled with the requirement of FCC Part 15, Subpart B, recorded in a separate test report(21090127-TEFV01).



2. Test Configuration of Equipment under Test

2.1 Feature of Equipment under Test

Operation Frequency Range	2400MHz-2483.5MHz
Center Frequency Range	2402MHz-2480MHz
Modulation Type	BT: GFSK, $\pi/4$ -DQPSK, 8DPSK BLE / 2.4G: GFSK
Modulation Technology	FHSS, DTS
Data Rate	BT: GFSK: 1Mbps, $\pi/4$ -DQPSK: 2Mbps, 8DPSK: 3Mbps BLE / 2.4 G GFSK: 1Mbps GFSK: 2Mbps
Antenna Type	Monopole Antenna
Antenna Gain	For BT / BLE: 2400-2483.5MHz: 0.9dBi For 2.4 G 2400-2483.5MHz: 1.1dBi,
Charging cable	Brand: steelseries Model: usb_cable01
Audio cable	Brand: steelseries Model: audio_01
Battery	Brand: HUIZHOU EVERPOWER TECHNOLOGY CO.,LTD Model: PL603033

Note: For more details, please refer to the User's manual of the EUT



2.2 Carrier Frequency of Channels

Channel	Frequency (MHz)	Channel	Frequency (MHz)	Channel	Frequency (MHz)
*00	2402	14	2430	28	2458
01	2404	15	2432	29	2460
02	2406	16	2434	30	2462
03	2408	17	2436	31	2464
04	2410	18	2438	32	2466
05	2412	*19	2440	33	2468
06	2414	20	2442	34	2470
07	2416	21	2444	35	2472
08	2418	22	2446	36	2474
09	2420	23	2448	37	2476
10	2422	24	2450	38	2478
11	2424	25	2452	*39	2480
12	2426	26	2454	--	--
13	2428	27	2456	--	--

Note: Channels remarked * are selected to perform test.



2.3 Test Mode and Test Software

- a. During testing, the interface cables and equipment positions were varied according to ANSI C63.10.
- b. The complete test system included Notebook and EUT for RF test.
- c. An executive program, " Blue Test3.ver. 3.2.2.144" under Windows OS system was executed to transmit and receive data via BLE.
- d. The following test modes were performed for the test:

Conducted Emissions from the AC mains power ports	
Test Mode	Operating Description
1	GFSK (1Mbps), From System(120V/60Hz)
2	GFSK (2Mbps), From System(120V/60Hz)
3	GFSK (1Mbps), From System (240V/60Hz)
4	GFSK (2Mbps), From System (240V/60Hz)
caused "Test Mode 2" generated the worst case, it was reported as the final data.	
Radiation Emissions (30MHz ~ 1GHz)	
Test Mode	Operating Description
1	GFSK (1Mbps), From System(120V/60Hz)
2	GFSK (2Mbps), From System(120V/60Hz)
caused "Test Mode 2" generated the worst case, it was reported as the final data.	
Radiation Emissions (1GHz ~ 25GHz)	
Test Mode	Operating Description
1	GFSK (1Mbps), From System (120V/60Hz)
2	GFSK (2Mbps), From System (120V/60Hz)
caused "Test Mode 1, 2" generated the worst case, they were reported as the final data.	

Modulation Type	TX CONFIGURATION
GFSK (1Mbps)	1TX
GFSK (2Mbps)	1TX



2.4 Description of Test System

RF Conducted				
Equipment	Brand	Model	Length/Type	Power cord/Length/Type
Notebook	DELL	Latitude E5470	N/A	Adapter / 1.8m / NS
Test Fixture	Goertek Inc.	TEST_CABLE.	N/A	N/A
Radiated Emissions				
Equipment	Brand	Model	Length/Type	Power cord/Length/Type
Notebook	ASUS	P2430U	N/A	Adapter / 1.8m / NS
Test Fixture	Goertek Inc.	TEST_CABLE.	N/A	N/A
AC Power Line Conducted Emission				
Equipment	Brand	Model	Length/Type	Power cord/Length/Type
Notebook	ASUS	P2430U	N/A	Adapter / 1.8m / NS
Test Fixture	Goertek Inc.	TEST_CABLE.	N/A	N/A

**2.5 General Information of Test**

Test Site	CerpPASS Technology Corporation Test Laboratory Address: No.10, Ln. 2, Lianfu St., Luzhu Dist., Taoyuan City 33848, Taiwan (R.O.C.) Tel:+886-3-3226-888 Fax:+886-3-3226-881	
	FCC	TW1439, TW1079
	IC	4934E-1, 4934E-2
	VCCI	T-2205 for Telecommunication test C-4663 for Conducted emission test R-4218 for Radiated emission test G-10812, G-10813 for radiated disturbance above 1GHz
Frequency Range Investigated:	Conducted: from 150kHz to 30 MHz Radiation: from 30 MHz to 25,000MHz	
Test Distance:	The test distance of radiated emission from antenna to EUT is 3 M.	

Test Item	Test Site	Test Period	Environmental Conditions	Tested By
RF Conducted	RFCON01-NK	2021/12/25~2021/12/29	23~25°C / 50~51%	Dian Chen
Radiated Emissions	3M03-NK	2022/01/02~2022/01/03	22~24°C / 47~48%	Dian Chen
AC Power Line Conducted Emission	CON01-NK	2022/01/02	19°C / 45%	Dian Chen



2.6 Measurement Uncertainty

ISO/IEC 17025 requires that an estimate of the measurement uncertainties associated with the emissions test results be included in the report. The measurement uncertainties given below are based on a 95% confidence level (based on a coverage factor (k=2))

Measurement Item	Uncertainty
AC Power Line Conduction(150K~30MHz)	±3.12dB
Radiated Spurious Emission(9KHz~30MHz)	±3.4dB
Radiated Spurious Emission(30MHz~1GHz)	±5.6dB
Radiated Spurious Emission(1GHz~25GHz)	±6.6dB
Conducted Spurious Emission	±1.8dB
6dB Bandwidth	±4.4%
20dB Bandwidth	±4.4%
Occupied Bandwidth	±4.4%
Peak Output Power(Conducted Power Meter)	±1.1dB
Dwell Time / Deactivation Time	±1.2%
Power Spectral Density	±1.8dB
Duty Cycle	±1.2%



3. Test Equipment and Ancillaries Used for Tests

Test Item	Radiated Emissions				
Test Site	Semi Anechoic Room(3M03-NK)				
Instrument	Manufacturer	Model No	Serial No	Calibration Date	Valid Date
Bilog Antenna	Sunol	JB1	A080713	2021/11/05	2022/11/04
Active Loop Antenna	EMCO	6507	40855	2021/06/10	2022/06/09
Double Ridged Guide Horn Antenna	RF SPAN	DRH18-E	210309A18-ES	2021/11/09	2022/11/08
Horn Antenna	EMCO	3116	31970	2021/03/29	2022/03/28
Spectrum Analyzer	ROHDE & SCHWARZ	FSP 40	100219	2021/08/06	2022/08/05
Preamplifier	EM Electronics corp.	EM01G18G	60831	2021/06/25	2022/06/24
Amplifier	EM Electronics corp.	EM330	60820	2021/07/25	2022/07/24
Bluetooth Tester	ROHDE & SCHWARZ	CBT	101133	2021/04/19	2022/04/18
Cable-1m(30M-1G)	HUBER SUHNER	RG-214	00419M	2021/06/29	2022/06/28
Cable-1.5m(30M-1G)	HUBER SUHNER	RG-214	00420M	2021/06/29	2022/06/28
Cable-9m(30M-1G)	HUBER SUHNER	RG-214	00430M	2021/06/29	2022/06/28
Cable-6m(9k~300M)	NA	EMC5D-BM-BM-6	130605	2021/09/22	2022/09/21
Cable-1.5m(1G-26.5G)	EMEC	EM104-SMSM-1.5M	EM104-SMSM-1.5M	2021/06/29	2022/06/28
Cable-9m(1G-26.5G)	EMEC	EM104-SMSM-9M	EM104-SMSM-9M	2021/06/29	2022/06/28
Cable-0.5m(30M-40G)	HUBER SUHNER	SUCOFLEX 102	28420/2	2021/04/03	2022/04/02
Cable-3m(30M-40G)	HUBER SUHNER	SUCOFLEX 102	MY2608/2	2021/04/09	2022/04/08
E3	AUDIX	v8.2014-8-6	RK-000529	NA	NA

Test Item	RF Conducted				
Test Site	RFCON01-NK				
Instrument	Manufacturer	Model No	Serial No	Calibration Date	Valid Date
Bluetooth Tester	ROHDE & SCHWARZ	CBT	101133	2021/04/19	2022/04/18
EXA Signal Analyzer	KEYSIGHT	N9010A	MY54200207	2021/04/21	2022/04/20
Attenuator	KEYSIGHT	8491B	MY39250703	2021/04/09	2022/04/08
TEMP & HUMI CHAMBER	T-MACHINE	TMJ-9712	T-12-040111	2021/08/27	2022/08/26
Cable-0.5m(1G-26.5G)	HUBER SUHNER	SUCOFLEX 102	28422/2	2021/04/08	2022/04/07
Power Meter	Anritsu	ML2495A	1224005	2021/04/14	2022/04/13
Power Sensor	Anritsu	MA2411B	1207295	2021/04/14	2022/04/13
Switch Box	Theda	1-4	TW5451159	NA	NA
MXG-B RF Vector Signal Generator	KEYSIGHT	N5182B	MY53051383	2021/06/30	2022/06/29



Test Item	AC Power Line Conducted Emission				
Test Site	CON01-NK				
Instrument	Manufacturer	Model No	Serial No	Calibration Date	Valid Date
EMI Receiver	ROHDE & SCHWARZ	ESCI	101200	2021/08/30	2022/08/29
Line Impedance Stabilization Network	Schwarzbeck	NSLK 8127	8127-568	2021/06/02	2022/06/01
Pulse Limiter	ROHDE & SCHWARZ	ESH3-Z2	101934	2021/03/10	2022/03/09
Cable-6m(9k~300M)	NA	CFD300-NL	NA	2021/03/15	2022/03/14
E3	AUDIX	v8.2014-8-6	RK-000531	NA	NA



4. Antenna Requirements

4.1 Standard Applicable

For intentional device, according to FCC 47 CFR Section 15.203, an intentional radiator shall be designed to ensure that no antenna other than that furnished by the responsible party shall be used with the device.

And according to FCC 47 CFR Section 15.247 (b), if transmitting antennas of directional gain greater than 6dBi are used, the power shall be reduced by the amount in dB that the directional gain of the antenna exceeds 6dBi.

4.2 Antenna Construction and Directional Gain

Antenna Type	Monopole Antenna
Antenna Gain	0.9 dBi



5. Test of AC Power Line Conducted Emission

5.1 Test Limit

Conducted Emissions were measured from 150 kHz to 30 MHz with a bandwidth of 9 KHz, according to the methods defined in ANSI C63.10-2013. The EUT was placed on a nonmetallic stand in a shielded room 0.8 meters above the ground plane. The interface cables and equipment positioning were varied within limits of reasonable applications to determine the position produced maximum conducted emissions.

Frequency (MHz)	Quasi Peak (dB μ V)	Average (dB μ V)
0.15 – 0.5	66-56*	56-46*
0.5 – 5.0	56	46
5.0 – 30.0	60	50

*Decreases with the logarithm of the frequency.

5.2 Test Procedures

- a. The EUT was placed 0.4 meter from the conducting wall of the shielding room was kept at least 80 centimeters from any other grounded conducting surface.
- b. Connect EUT to the power mains through a line impedance stabilization network (LISN).
- c. All the support units are connecting to the other LISN.
- d. The LISN provides 50 ohm coupling impedance for the measuring instrument.
- e. The FCC states that a 50 ohm, 50 micro-Henry LISN should be used.
- f. Both sides of AC line were checked for maximum conducted interference.
- g. The frequency range from 150 kHz to 30 MHz was searched.
- h. Set the test-receiver system to Peak Detect Function and Specified Bandwidth with Maximum Hold Mode.



5.3 Typical Test Setup

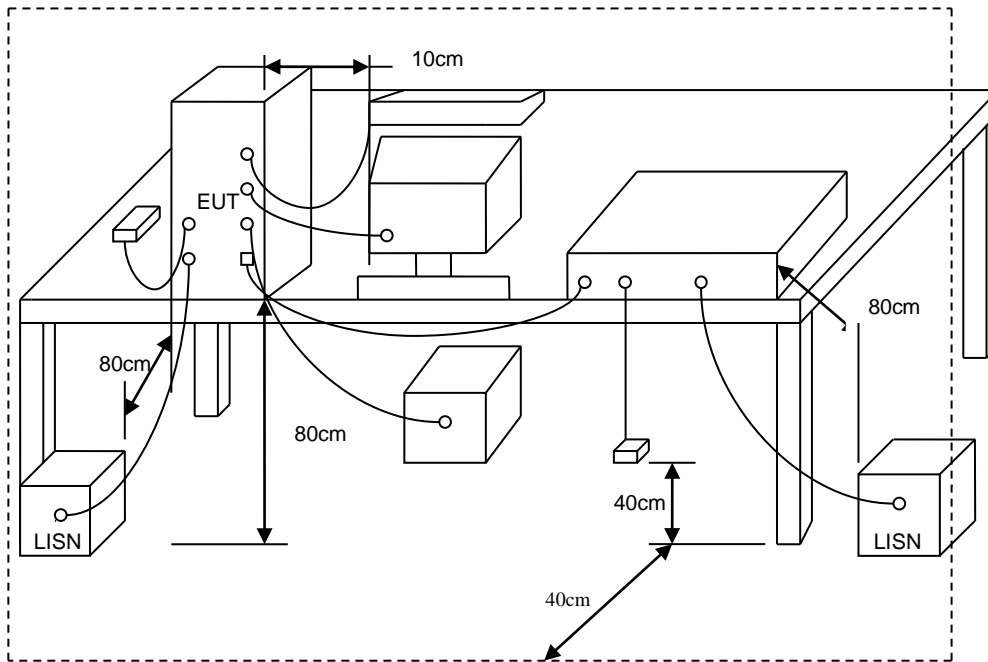



5.4 Test Result and Data

Power	: DC 5V From System (AC 120V / 60Hz)	Pol/Phase	: LINE
Test Mode	: Mode 2		:

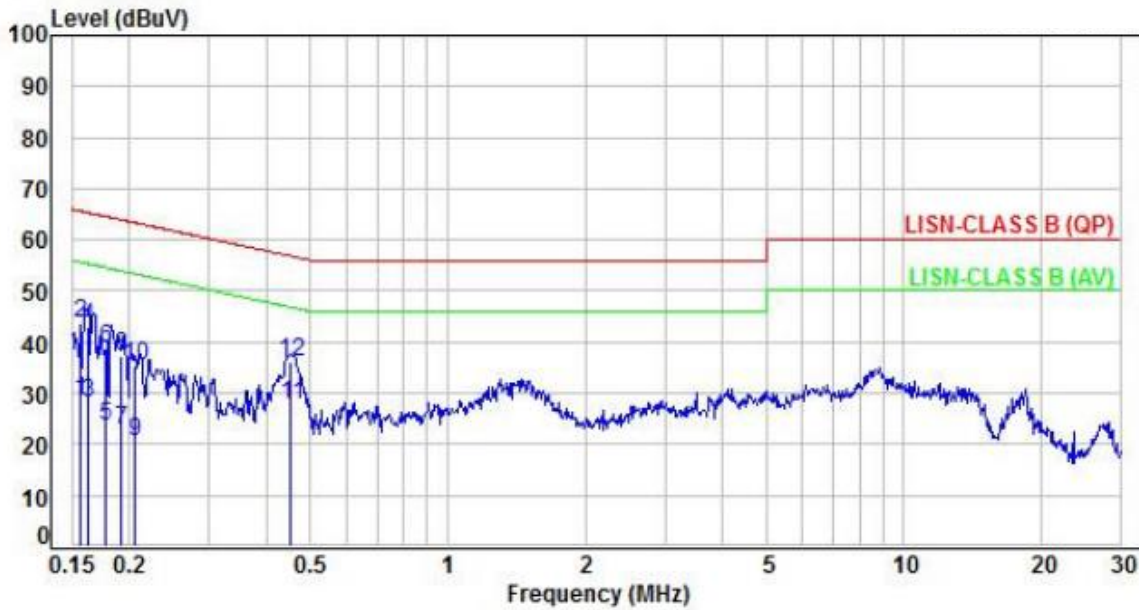

No.	Frequency (MHz)	Factor (dB)	Reading (dBuV)	Level (dBuV)	Limit (dBuV)	Margin (dB)	Detector	P/F
1	0.16	9.97	18.72	28.69	55.67	-26.98	Average	P
2	0.16	9.97	33.79	43.76	65.67	-21.91	QP	P
3	0.16	9.97	17.99	27.96	55.32	-27.36	Average	P
4	0.16	9.97	33.16	43.13	65.32	-22.19	QP	P
5	0.18	9.97	13.46	23.43	54.56	-31.13	Average	P
6	0.18	9.97	29.00	38.97	64.56	-25.59	QP	P
7	0.19	9.97	12.80	22.77	53.94	-31.17	Average	P
8	0.19	9.97	27.26	37.23	63.94	-26.71	QP	P
9	0.21	9.97	10.44	20.41	53.37	-32.96	Average	P
10	0.21	9.97	25.36	35.33	63.37	-28.04	QP	P
11	0.45	9.98	17.60	27.58	46.81	-19.23	Average	P
12	0.45	9.98	26.12	36.10	56.81	-20.71	QP	P

Note: Level=Reading+Factor
 Margin=Level-Limit
 Factor=(LISN or ISN or Current Probe)Factor + Cable Loss



Power	: DC 5V From System (AC 120V / 60Hz)	Pol/Phase	: NEUTRAL
Test Mode	: Mode 2		:

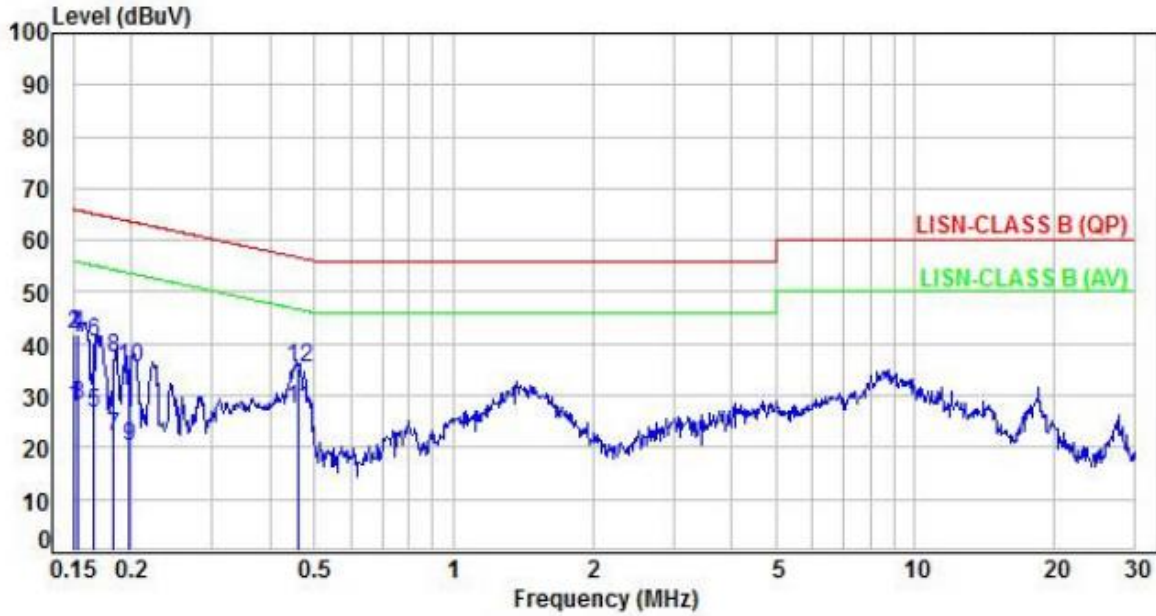

No.	Frequency (MHz)	Factor (dB)	Reading (dBuV)	Level (dBuV)	Limit (dBuV)	Margin (dB)	Detector	P/F
1	0.15	9.97	17.76	27.73	56.00	-28.27	Average	P
2	0.15	9.97	32.01	41.98	66.00	-24.02	QP	P
3	0.15	9.97	18.24	28.21	55.78	-27.57	Average	P
4	0.15	9.97	31.83	41.80	65.78	-23.98	QP	P
5	0.17	9.97	16.73	26.70	55.16	-28.46	Average	P
6	0.17	9.97	30.50	40.47	65.16	-24.69	QP	P
7	0.18	9.97	11.92	21.89	54.36	-32.47	Average	P
8	0.18	9.97	27.19	37.16	64.36	-27.20	QP	P
9	0.20	9.97	10.18	20.15	53.67	-33.52	Average	P
10	0.20	9.97	25.47	35.44	63.67	-28.23	QP	P
11	0.46	9.98	17.37	27.35	46.70	-19.35	Average	P
12	0.46	9.98	25.23	35.21	56.70	-21.49	QP	P

Note: Level=Reading+Factor
 Margin=Level-Limit
 Factor=(LISN or ISN or Current Probe)Factor + Cable Loss



6. Test of Spurious Emission (Radiated)

6.1 Test Limit

In any 100kHz bandwidth outside the frequency band in which the spread spectrum or digitally modulated intentional radiator is operating, the radio frequency power that is produced by the intentional radiator shall be at least 20dB below that in the 100kHz bandwidth within the band that contains the highest level of the desired power, based on either an RF conducted or a radiated measurement. If the transmitter measurement is based on the maximum conducted output power, the attenuation required under this paragraph shall be 30dB instead of 20dB. In addition, radiated emissions which fall in section 15.205(a) the restricted bands must also comply with the radiated emission limit specified in section 15.209(a).

Frequency (MHz)	Field Strength (microvolt/meter)	Measurement Distance (meters)
0.009 ~ 0.490	2400/F(kHz)	300
0.490 ~ 1.705	24000/F(kHz)	30
1.705 ~ 30.0	30	30
30 ~ 88	100	3
88 ~ 216	150	3
216 ~ 960	200	3
Above 960	500	3



6.2 Test Procedures

- a. The EUT was placed on a rotatable table top 0.8 meter above ground.
- b. The EUT was set 3 meters from the interference receiving antenna which was mounted on the top of a variable height antenna tower.
- c. The table was rotated 360 degrees to determine the position of the highest radiation.
- d. The antenna is a broadband antenna and its height is varied between one meter and four meters above ground to find the maximum value of the field strength both horizontal polarization and vertical polarization of the antenna are set to make the measurement.
- e. For each suspected emission the EUT was arranged to its worst case and then tune the antenna tower (from 1 M to 4 M) and turn table (from 0 degree to 360 degrees) to find the maximum reading.
- f. Set the test-receiver system to Peak or CISPR quasi-peak Detect Function and specified bandwidth with Maximum Hold Mode.
- g. If the emission level of the EUT in peak mode was 3 dB lower than the limit specified, then testing will be stopped and peak values of EUT will be reported, otherwise, the emissions which do not have 3 dB margin will be repeated one by one using the quasi-peak method and reported.
- h. For testing above 1GHz, the emission level of the EUT in peak mode was 20dB lower than average limit (that means the emission level in peak mode also complies with the limit in average mode), then testing will be stopped and peak values of EUT will be reported, otherwise, the emissions will be measured in average mode again and reported.
- i. "Cone of radiation" has been considered to be 3dB bandwidth of the measurement antenna.

Note:

- 1.The supporting fixture shall permit orientation of the EUT in each of three orthogonal axis positions such that emissions from the EUT are maximized.
(Y-AXIS is the worst.)
- 2.Due to the test software function limit the operation band setting(200dBuV/m).
There's no corresponding limitation in the actual test item.



6.3 Typical Test Setup

Below 30MHz test setup

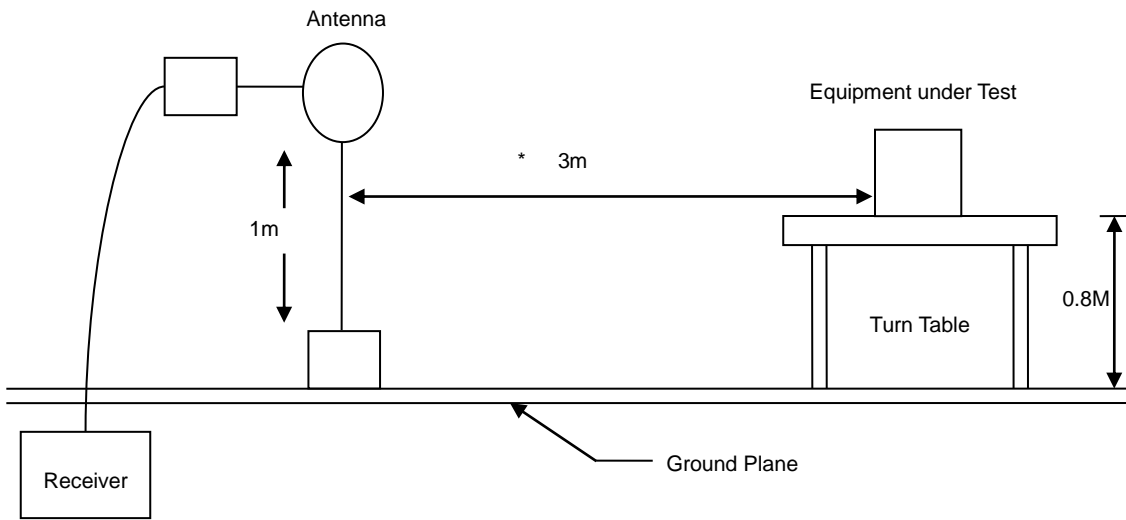

30MHz- 1GHz Test Setup

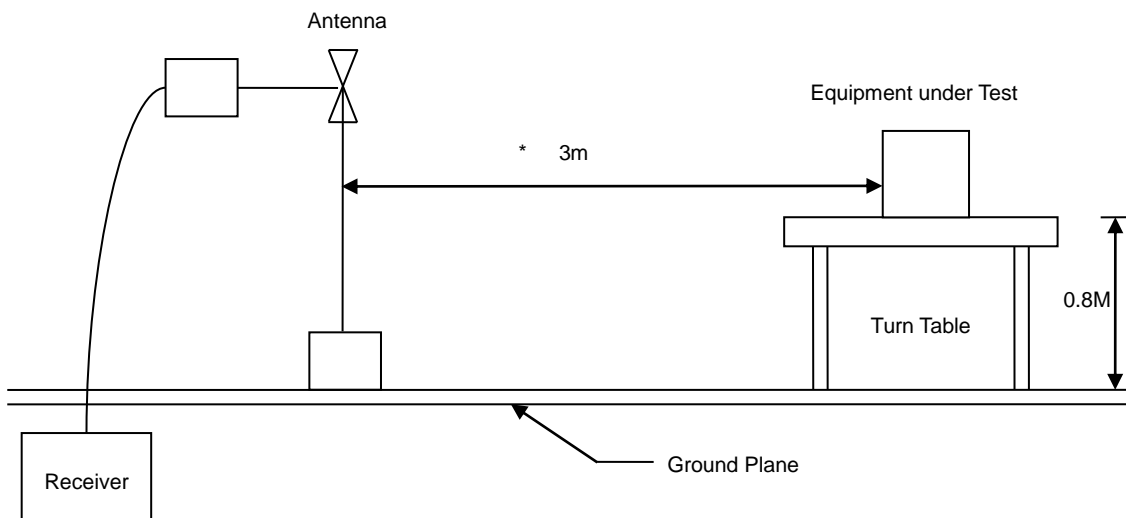

Above 1GHz Test Setup

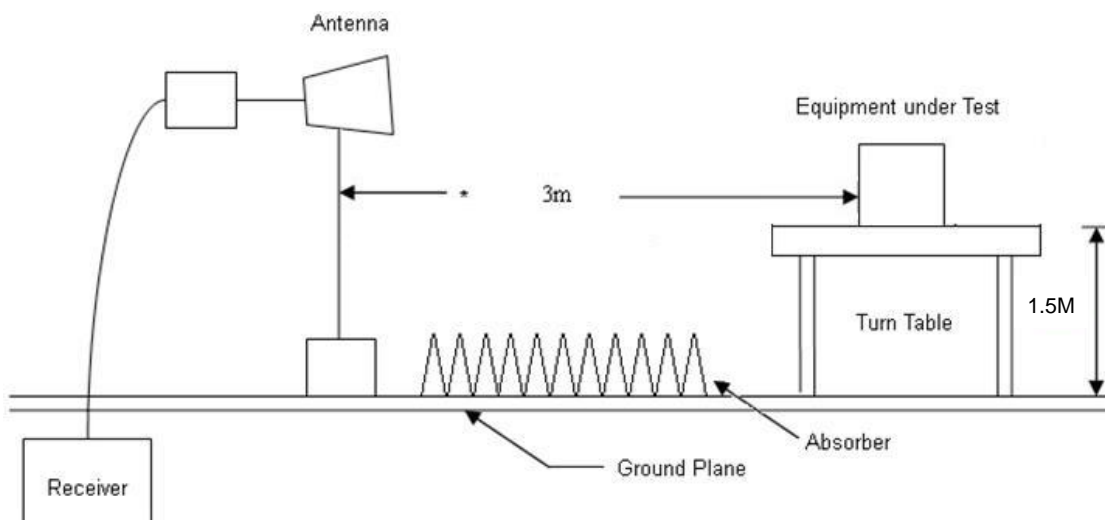



6.4 Test Result and Data (9kHz ~ 30MHz)

The 9kHz - 30MHz spurious emission is under limit 20dB more.

6.5 Test Result and Data (30MHz ~ 1GHz)

Power	:	DC 5V From System (AC 120V / 60Hz)	Pol/Phase	:	VERTICAL
Test Mode	:	Mode 2		:	

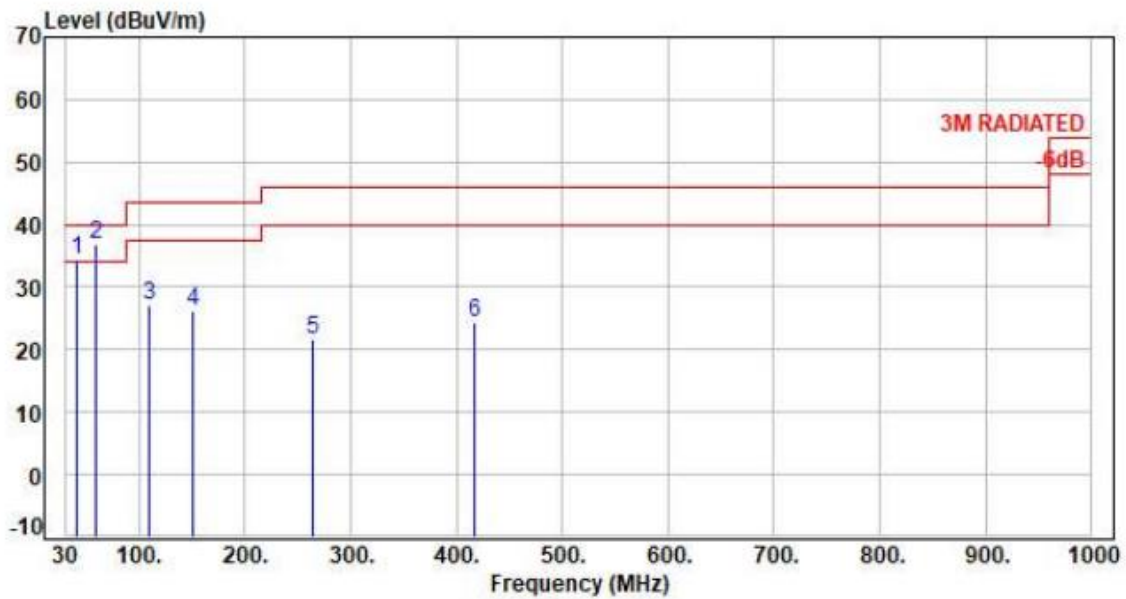

No.	Frequency (MHz)	Factor (dB)	Reading (dBuV)	Level (dBuV/m)	Limit (dBuV/m)	Margin (dB)	Detector	Height (cm)	Azimuth (deg)	P/F
1	41.25	-11.98	46.34	34.36	40.00	-5.64	Peak	400	0	P
2	59.27	-17.63	54.46	36.83	40.00	-3.17	Peak	400	0	P
3	109.51	-12.66	39.84	27.18	43.50	-16.32	Peak	400	0	P
4	150.24	-12.09	38.35	26.26	43.50	-17.24	Peak	400	0	P
5	264.57	-10.89	32.67	21.78	46.00	-24.22	Peak	400	0	P
6	416.34	-7.07	31.45	24.38	46.00	-21.62	Peak	400	0	P

Note: Level=Reading+Factor

Margin=Level-Limit

Factor=Antenna Factor + cable loss - Amplifier Factor



Power	: DC 5V From System (AC 120V / 60Hz)	Pol/Phase	: HORIZONTAL
Test Mode	: Mode 2		:

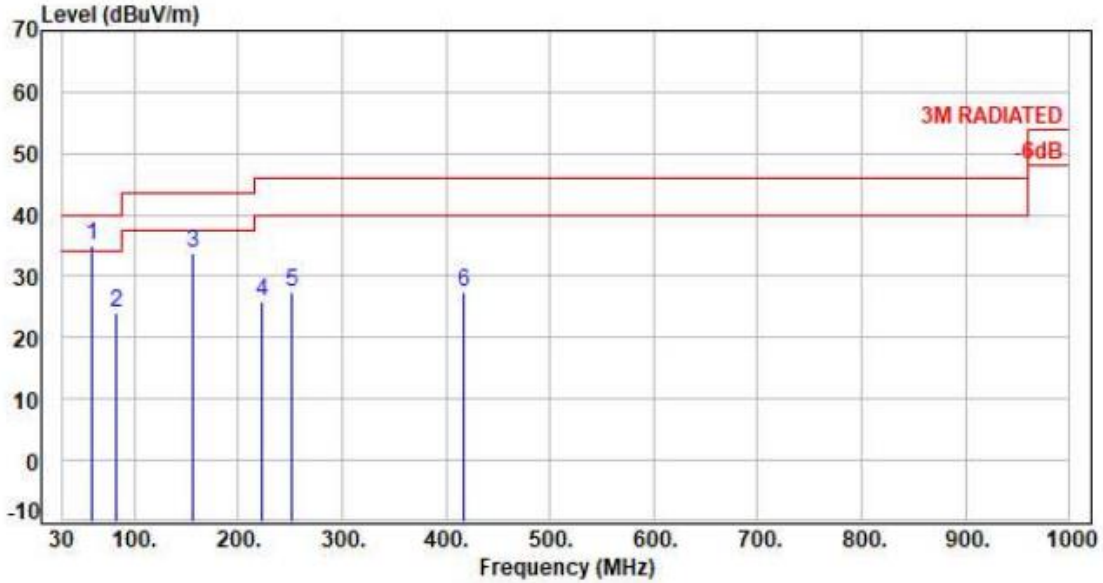

No.	Frequency (MHz)	Factor (dB)	Reading (dBuV)	Level (dBuV/m)	Limit (dBuV/m)	Margin (dB)	Detector	Height (cm)	Azimuth (deg)	P/F
1	59.27	-17.63	52.79	35.16	40.00	-4.84	QP	250	151	P
2	82.34	-17.87	41.89	24.02	40.00	-15.98	Peak	400	360	P
3	156.16	-12.18	46.13	33.95	43.50	-9.55	Peak	400	360	P
4	222.75	-13.32	39.34	26.02	46.00	-19.98	Peak	400	360	P
5	251.67	-12.36	39.68	27.32	46.00	-18.68	Peak	400	360	P
6	416.26	-7.07	34.45	27.38	46.00	-18.62	Peak	400	360	P

Note: Level=Reading+Factor
 Margin=Level-Limit
 Factor=Antenna Factor + cable loss - Amplifier Factor



6.6 Test Result and Data (1GHz ~ 25GHz)

Power	: DC 5V From System (AC 120V / 60Hz)	Pol/Phase	: VERTICAL
Test Mode	: Mode 1, CH00		:

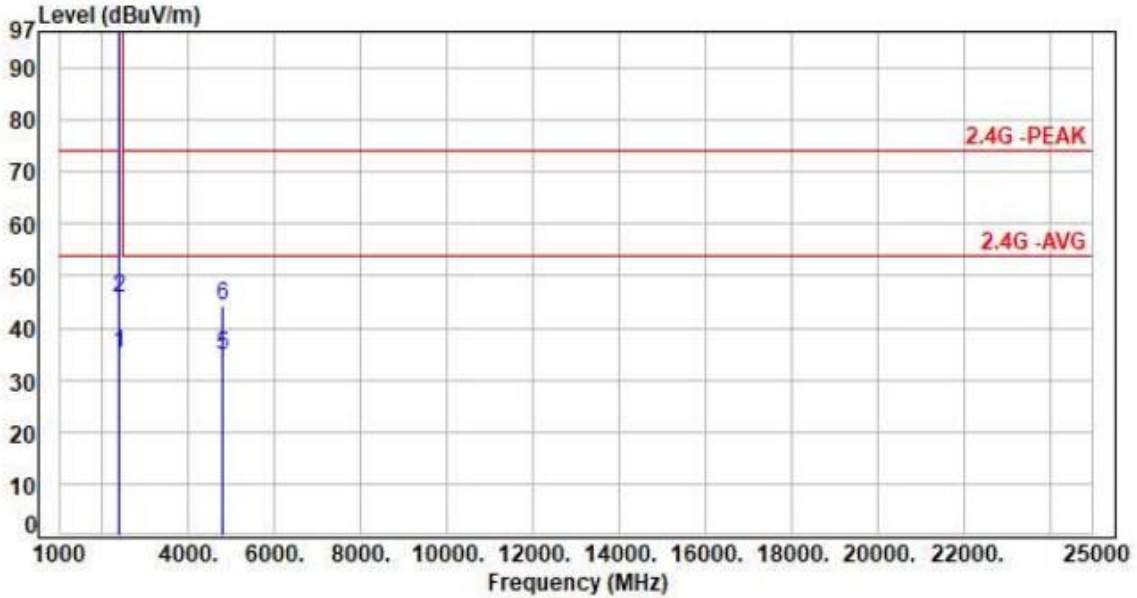

No.	Frequency (MHz)	Factor (dB)	Reading (dBuV)	Level (dBuV/m)	Limit (dBuV/m)	Margin (dB)	Detector	Height (cm)	Azimuth (deg)	P/F
1	2390.00	-15.29	50.16	34.87	54.00	-19.13	Average	100	29	P
2	2390.00	-15.29	60.88	45.59	74.00	-28.41	Peak	100	29	P
3	2402.00	-15.33	116.79	101.46	200.00	-98.54	Average	100	29	P
4	2402.00	-15.33	118.08	102.75	200.00	-97.25	Peak	100	29	P
5	4804.00	-7.22	41.94	34.72	54.00	-19.28	Average	100	213	P
6	4804.00	-7.22	51.52	44.30	74.00	-29.70	Peak	100	213	P

Note: Level=Reading+Factor
Margin=Level-Limit
Factor=Antenna Factor + cable loss - Amplifier Factor



Power	: DC 5V From System (AC 120V / 60Hz)	Pol/Phase	: HORIZONTAL
Test Mode	: Mode 1, CH00		:

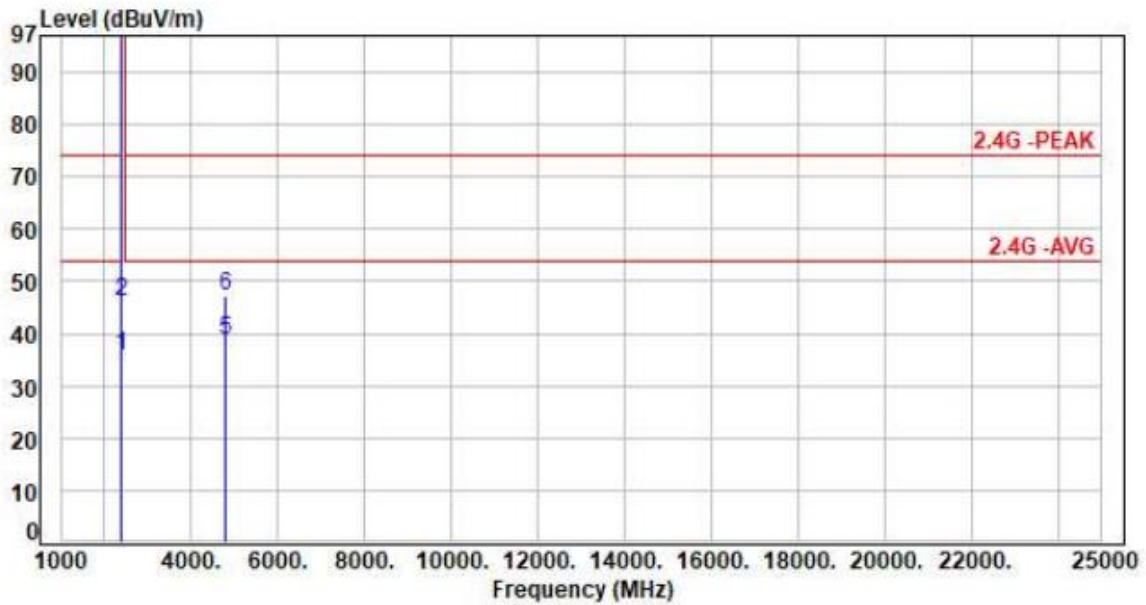

No.	Frequency (MHz)	Factor (dB)	Reading (dBuV)	Level (dBuV/m)	Limit (dBuV/m)	Margin (dB)	Detector	Height (cm)	Azimuth (deg)	P/F
1	2390.00	-15.29	51.03	35.74	54.00	-18.26	Average	134	267	P
2	2390.00	-15.29	61.46	46.17	74.00	-27.83	Peak	134	267	P
3	2402.00	-15.33	117.08	101.75	200.00	-98.25	Average	134	267	P
4	2402.00	-15.33	118.34	103.01	200.00	-96.99	Peak	134	267	P
5	4804.00	-7.22	45.95	38.73	54.00	-15.27	Average	290	215	P
6	4804.00	-7.22	54.31	47.09	74.00	-26.91	Peak	290	215	P

Note: Level=Reading+Factor
 Margin=Level-Limit
 Factor=Antenna Factor + cable loss - Amplifier Factor



Power	: DC 5V From System (AC 120V / 60Hz)	Pol/Phase	: VERTICAL
Test Mode	: Mode 1, CH19		:

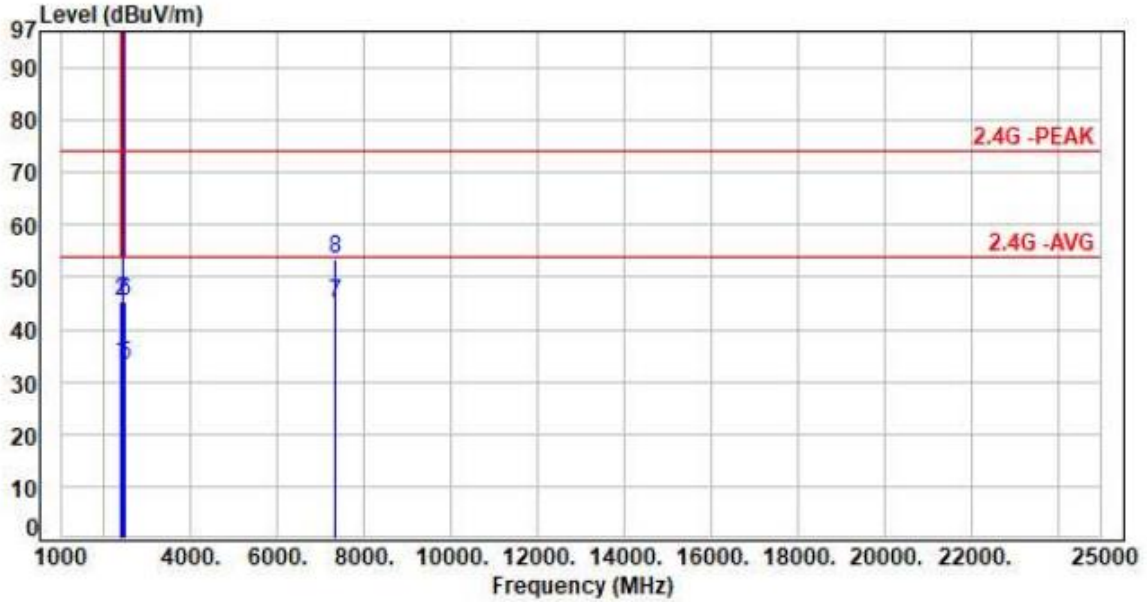

No.	Frequency (MHz)	Factor (dB)	Reading (dBuV)	Level (dBuV/m)	Limit (dBuV/m)	Margin (dB)	Detector	Height (cm)	Azimuth (deg)	P/F
1	2390.00	-15.29	48.68	33.39	54.00	-20.61	Average	100	33	P
2	2390.00	-15.29	60.62	45.33	74.00	-28.67	Peak	100	33	P
3	2440.00	-15.43	117.00	101.57	200.00	-98.43	Average	100	33	P
4	2440.00	-15.43	118.38	102.95	200.00	-97.05	Peak	100	33	P
5	2483.50	-15.35	48.69	33.34	54.00	-20.66	Average	100	33	P
6	2483.50	-15.35	60.66	45.31	74.00	-28.69	Peak	100	33	P
7	7320.00	-0.34	45.30	44.96	54.00	-9.04	Average	100	320	P
8	7320.00	-0.34	53.70	53.36	74.00	-20.64	Peak	100	320	P

Note: Level=Reading+Factor
Margin=Level-Limit
Factor=Antenna Factor + cable loss - Amplifier Factor



Power	: DC 5V From System (AC 120V / 60Hz)	Pol/Phase	: HORIZONTAL
Test Mode	: Mode 1, CH19		:

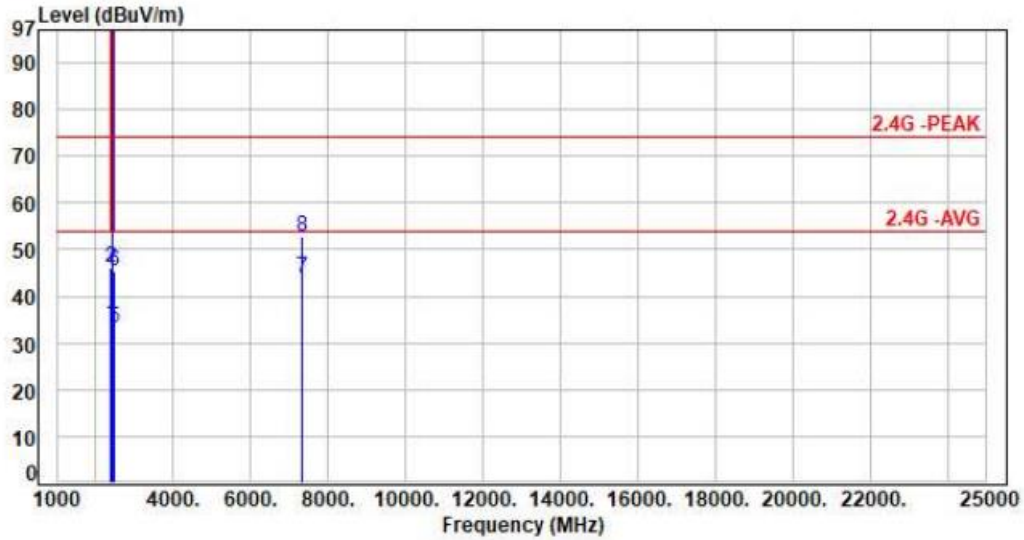

No.	Frequency (MHz)	Factor (dB)	Reading (dBuV)	Level (dBuV/m)	Limit (dBuV/m)	Margin (dB)	Detector	Height (cm)	Azimuth (deg)	P/F
1	2390.00	-15.29	49.19	33.90	54.00	-20.10	Average	100	270	P
2	2390.00	-15.29	61.29	46.00	74.00	-28.00	Peak	100	270	P
3	2440.00	-15.43	116.45	101.02	200.00	-98.98	Average	100	270	P
4	2440.00	-15.43	117.70	102.27	200.00	-97.73	Peak	100	270	P
5	2483.50	-15.35	48.58	33.23	54.00	-20.77	Average	100	270	P
6	2483.50	-15.35	60.58	45.23	74.00	-28.77	Peak	100	270	P
7	7320.00	-0.34	44.30	43.96	54.00	-10.04	Average	100	231	P
8	7320.00	-0.34	53.08	52.74	74.00	-21.26	Peak	100	231	P

Note: Level=Reading+Factor
 Margin=Level-Limit
 Factor=Antenna Factor + cable loss - Amplifier Factor



Power	: DC 5V From System (AC 120V / 60Hz)	Pol/Phase	: VERTICAL
Test Mode	: Mode 1, CH39		:

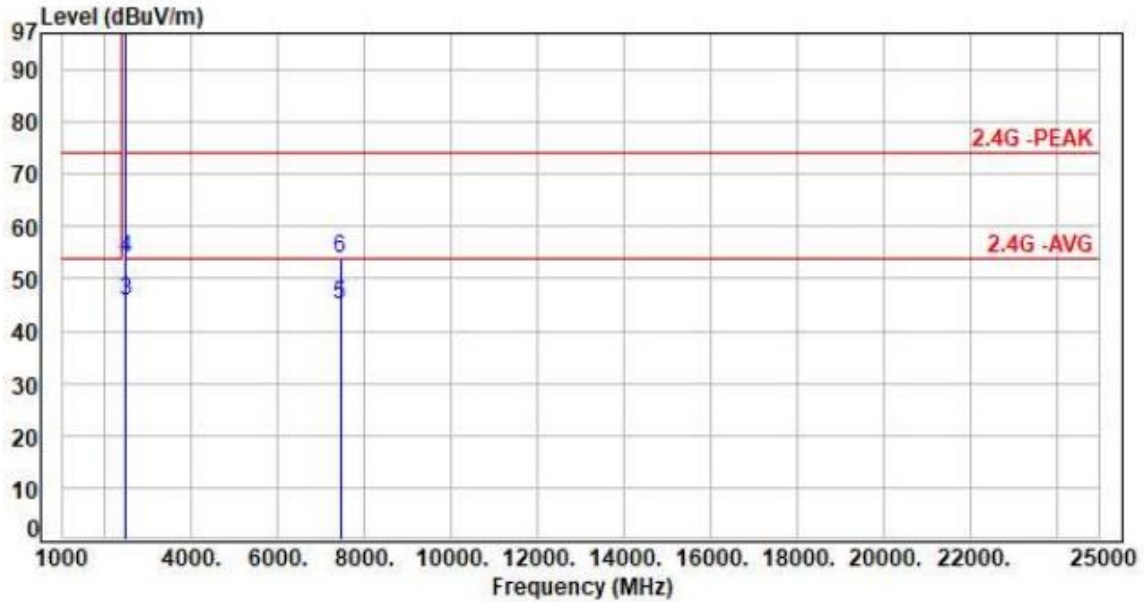

No.	Frequency (MHz)	Factor (dB)	Reading (dBuV)	Level (dBuV/m)	Limit (dBuV/m)	Margin (dB)	Detector	Height (cm)	Azimuth (deg)	P/F
1	2480.00	-15.37	118.18	102.81	200.00	-97.19	Average	100	31	P
2	2480.00	-15.37	119.31	103.94	200.00	-96.06	Peak	100	31	P
3	2483.50	-15.35	61.26	45.91	54.00	-8.09	Average	100	31	P
4	2483.50	-15.35	69.12	53.77	74.00	-20.23	Peak	100	31	P
5	7440.00	-0.25	45.38	45.13	54.00	-8.87	Average	100	319	P
6	7440.00	-0.25	54.23	53.98	74.00	-20.02	Peak	100	319	P

Note: Level=Reading+Factor
Margin=Level-Limit
Factor=Antenna Factor + cable loss - Amplifier Factor



Power	: DC 5V From System (AC 120V / 60Hz)	Pol/Phase	: HORIZONTAL
Test Mode	: Mode 1, CH39		:

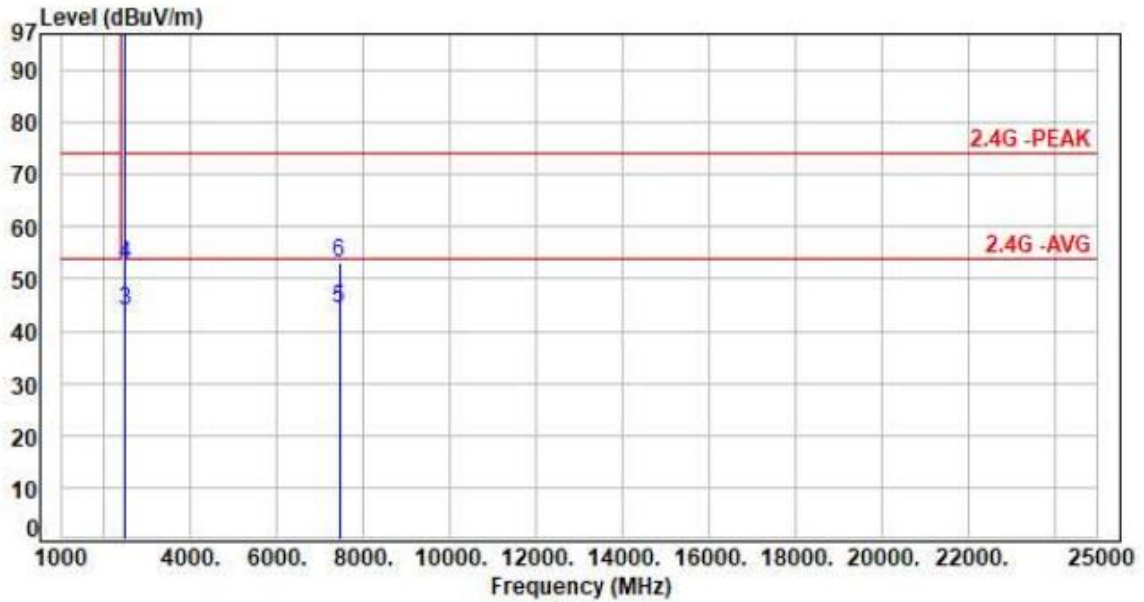

No.	Frequency (MHz)	Factor (dB)	Reading (dBuV)	Level (dBuV/m)	Limit (dBuV/m)	Margin (dB)	Detector	Height (cm)	Azimuth (deg)	P/F
1	2480.00	-15.37	116.30	100.93	200.00	-99.07	Average	100	234	P
2	2480.00	-15.37	117.09	101.72	200.00	-98.28	Peak	100	234	P
3	2483.50	-15.35	59.21	43.86	54.00	-10.14	Average	100	234	P
4	2483.50	-15.35	68.23	52.88	74.00	-21.12	Peak	100	234	P
5	7440.00	-0.25	44.46	44.21	54.00	-9.79	Average	100	266	P
6	7440.00	-0.25	53.54	53.29	74.00	-20.71	Peak	100	266	P

Note: Level=Reading+Factor
 Margin=Level-Limit
 Factor=Antenna Factor + cable loss - Amplifier Factor



Power	:	DC 5V From System (AC 120V / 60Hz)	Pol/Phase	:	VERTICAL
Test Mode	:	Mode 2, CH00		:	

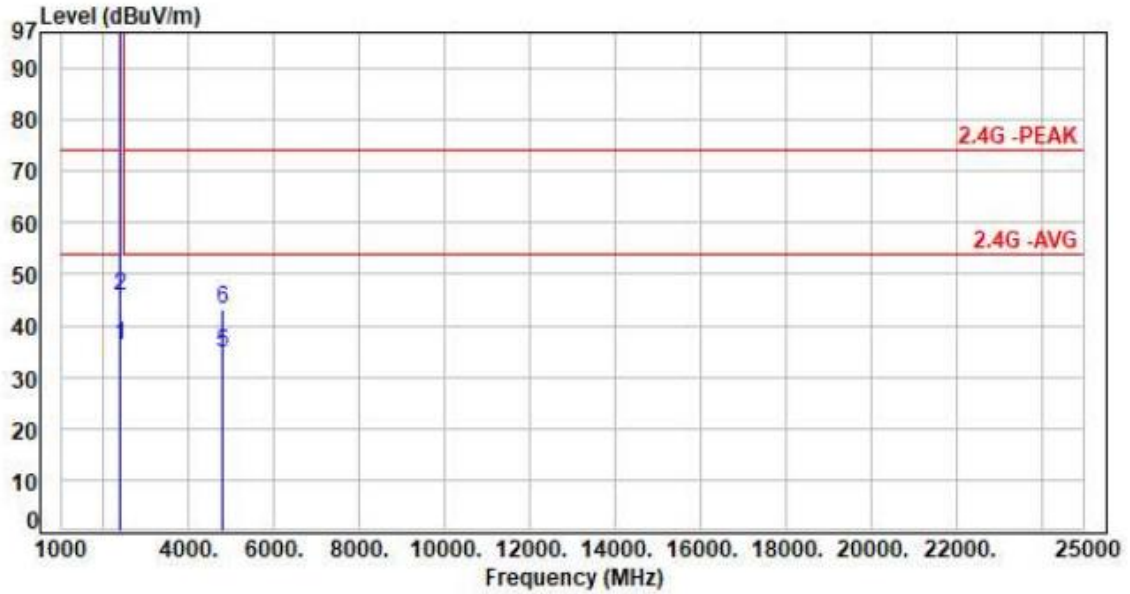

No.	Frequency (MHz)	Factor (dB)	Reading (dBuV)	Level (dBuV/m)	Limit (dBuV/m)	Margin (dB)	Detector	Height (cm)	Azimuth (deg)	P/F
1	2390.00	-15.29	51.48	36.19	54.00	-17.81	Average	100	28	P
2	2390.00	-15.29	61.15	45.86	74.00	-28.14	Peak	100	28	P
3	2402.00	-15.33	115.18	99.85	200.00	-100.15	Average	100	28	P
4	2402.00	-15.33	118.20	102.87	200.00	-97.13	Peak	100	28	P
5	4804.00	-7.22	41.98	34.76	54.00	-19.24	Average	100	224	P
6	4804.00	-7.22	50.21	42.99	74.00	-31.01	Peak	100	224	P

Note: Level=Reading+Factor
 Margin=Level-Limit
 Factor=Antenna Factor + cable loss - Amplifier Factor



Power	: DC 5V From System (AC 120V / 60Hz)	Pol/Phase	: HORIZONTAL
Test Mode	: Mode 2, CH00		:

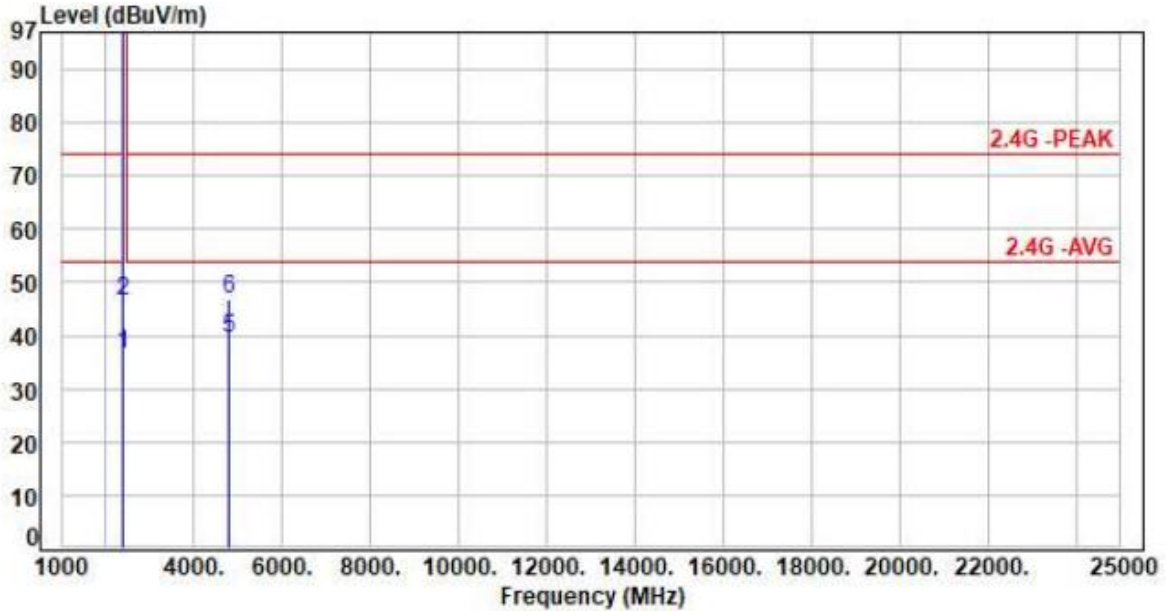

No.	Frequency (MHz)	Factor (dB)	Reading (dBuV)	Level (dBuV/m)	Limit (dBuV/m)	Margin (dB)	Detector	Height (cm)	Azimuth (deg)	P/F
1	2390.00	-15.29	51.82	36.53	54.00	-17.47	Average	100	270	P
2	2390.00	-15.29	61.69	46.40	74.00	-27.60	Peak	100	270	P
3	2402.00	-15.33	115.47	100.14	200.00	-99.86	Average	100	270	P
4	2402.00	-15.33	118.43	103.10	200.00	-96.90	Peak	100	270	P
5	4804.00	-7.22	46.64	39.42	54.00	-14.58	Average	232	215	P
6	4804.00	-7.22	54.12	46.90	74.00	-27.10	Peak	232	215	P

Note: Level=Reading+Factor
 Margin=Level-Limit
 Factor=Antenna Factor + cable loss - Amplifier Factor



Power	:	DC 5V From System (AC 120V / 60Hz)	Pol/Phase	:	VERTICAL
Test Mode	:	Mode 2, CH19		:	

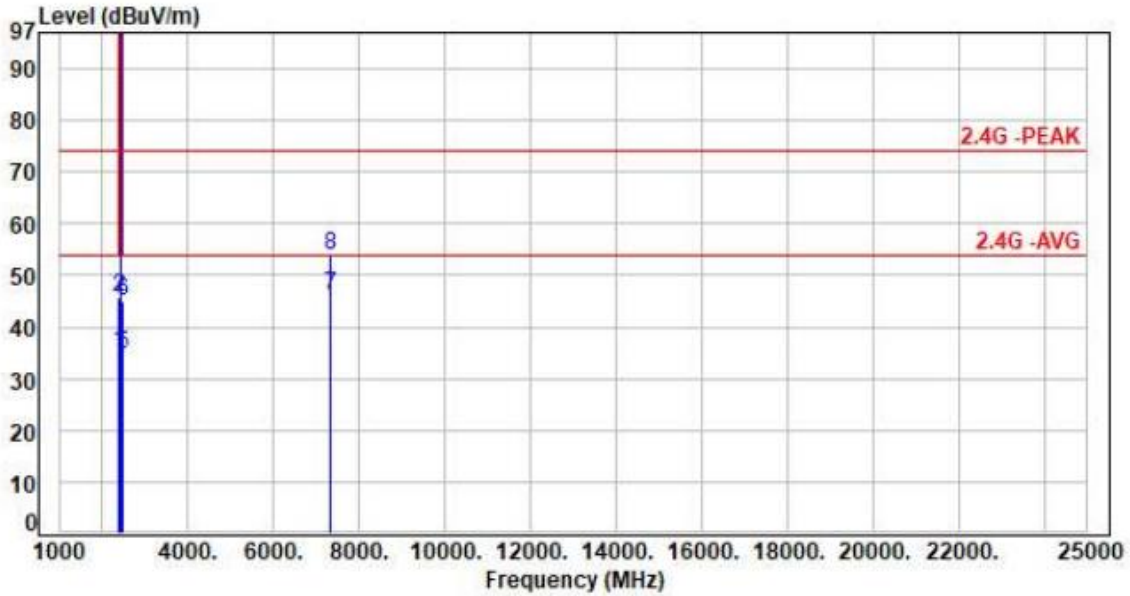

No.	Frequency (MHz)	Factor (dB)	Reading (dBuV)	Level (dBuV/m)	Limit (dBuV/m)	Margin (dB)	Detector	Height (cm)	Azimuth (deg)	P/F
1	2390.00	-15.29	50.24	34.95	54.00	-19.05	Average	100	29	P
2	2390.00	-15.29	60.96	45.67	74.00	-28.33	Peak	100	29	P
3	2440.00	-15.43	115.37	99.94	200.00	-100.06	Average	100	29	P
4	2440.00	-15.43	118.22	102.79	200.00	-97.21	Peak	100	29	P
5	2483.50	-15.35	50.07	34.72	54.00	-19.28	Average	100	29	P
6	2483.50	-15.35	60.53	45.18	74.00	-28.82	Peak	100	29	P
7	7320.00	-0.34	46.44	46.10	54.00	-7.90	Average	100	224	P
8	7320.00	-0.34	54.28	53.94	74.00	-20.06	Peak	100	224	P

Note: Level=Reading+Factor
Margin=Level-Limit
Factor=Antenna Factor + cable loss - Amplifier Factor



Power	: DC 5V From System (AC 120V / 60Hz)	Pol/Phase	: HORIZONTAL
Test Mode	: Mode 2, CH19		:

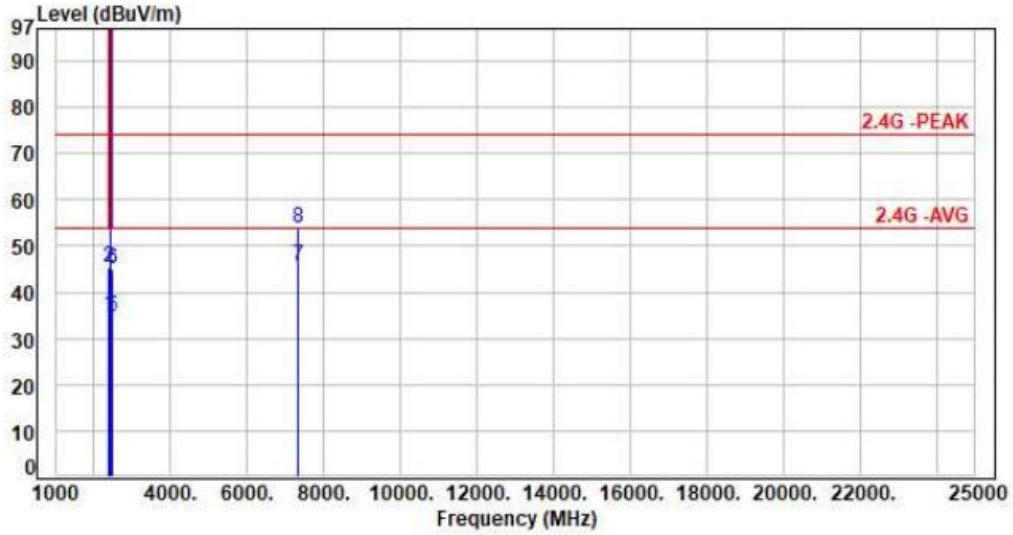

No.	Frequency (MHz)	Factor (dB)	Reading (dBuV)	Level (dBuV/m)	Limit (dBuV/m)	Margin (dB)	Detector	Height (cm)	Azimuth (deg)	P/F
1	2390.00	-15.29	50.50	35.21	54.00	-18.79	Average	100	234	P
2	2390.00	-15.29	60.52	45.23	74.00	-28.77	Peak	100	234	P
3	2440.00	-15.43	114.68	99.25	200.00	-100.75	Average	100	234	P
4	2440.00	-15.43	117.53	102.10	200.00	-97.90	Peak	100	234	P
5	2483.50	-15.35	50.08	34.73	54.00	-19.27	Average	100	234	P
6	2483.50	-15.35	60.37	45.02	74.00	-28.98	Peak	100	234	P
7	7320.00	-0.34	45.97	45.63	54.00	-8.37	Average	191	267	P
8	7320.00	-0.34	54.01	53.67	74.00	-20.33	Peak	191	267	P

Note: Level=Reading+Factor
 Margin=Level-Limit
 Factor=Antenna Factor + cable loss - Amplifier Factor



Power	:	DC 5V From System (AC 120V / 60Hz)	Pol/Phase	:	VERTICAL
Test Mode	:	Mode 2, CH39		:	

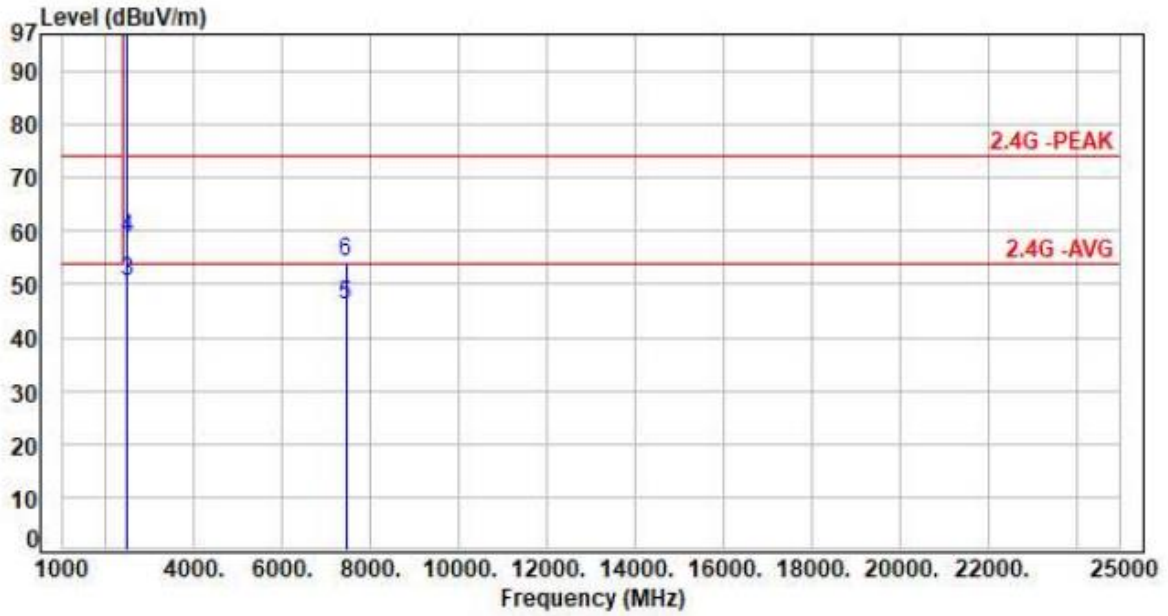

No.	Frequency (MHz)	Factor (dB)	Reading (dBuV)	Level (dBuV/m)	Limit (dBuV/m)	Margin (dB)	Detector	Height (cm)	Azimuth (deg)	P/F
1	2480.00	-15.37	116.35	100.98	200.00	-99.02	Average	100	32	P
2	2480.00	-15.37	119.26	103.89	200.00	-96.11	Peak	100	32	P
3	2483.50	-15.35	66.05	50.70	54.00	-3.30	Average	100	32	P
4	2483.50	-15.35	73.90	58.55	74.00	-15.45	Peak	100	32	P
5	7440.00	-0.25	46.21	45.96	54.00	-8.04	Average	100	319	P
6	7440.00	-0.25	54.36	54.11	74.00	-19.89	Peak	100	319	P

Note: Level=Reading+Factor
Margin=Level-Limit
Factor=Antenna Factor + cable loss - Amplifier Factor



Power	:	DC 5V From System (AC 120V / 60Hz)	Pol/Phase	:	HORIZONTAL
Test Mode	:	Mode 2, CH39		:	

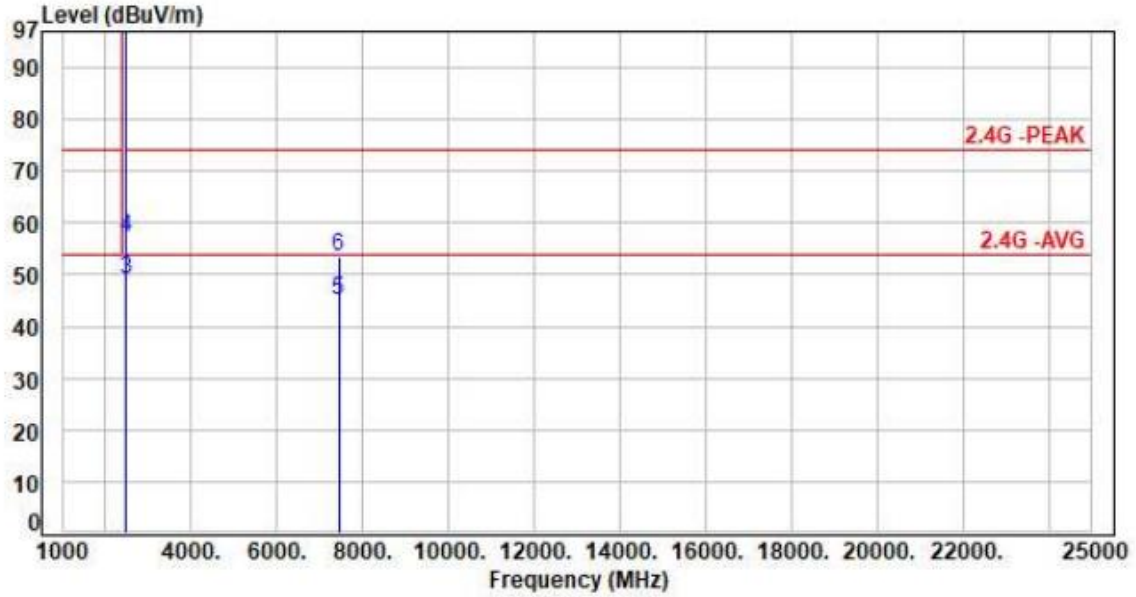

No.	Frequency (MHz)	Factor (dB)	Reading (dBuV)	Level (dBuV/m)	Limit (dBuV/m)	Margin (dB)	Detector	Height (cm)	Azimuth (deg)	P/F
1	2480.00	-15.37	114.81	99.44	200.00	-100.56	Average	100	269	P
2	2480.00	-15.37	117.76	102.39	200.00	-97.61	Peak	100	269	P
3	2483.50	-15.35	64.36	49.01	54.00	-4.99	Average	100	269	P
4	2483.50	-15.35	72.67	57.32	74.00	-16.68	Peak	100	269	P
5	7440.00	-0.25	45.32	45.07	54.00	-8.93	Average	100	266	P
6	7440.00	-0.25	53.69	53.44	74.00	-20.56	Peak	100	266	P

Note: Level=Reading+Factor
 Margin=Level-Limit
 Factor=Antenna Factor + cable loss - Amplifier Factor



6.7 Restricted Bands of Operation

Only spurious emissions are permitted in any of the frequency bands listed below:

MHz	MHz	MHz	GHz
0.09000 – 0.11000	16.42000 – 16.42300	399.9 – 410.0	4.500 – 5.250
0.49500 – 0.505**	16.69475 – 16.69525	608.0 – 614.0	5.350 – 5.460
2.17350 – 2.19050	16.80425 – 16.80475	960.0 – 1240.0	7.250 – 7.750
4.12500 – 4.12800	25.50000 – 25.67000	1300.0 – 1427.0	8.025 – 8.500
4.17725 – 4.17775	37.50000 – 38.25000	1435.0 – 1626.5	9.000 – 9.200
4.20725 – 4.20775	73.00000 – 74.60000	1645.5 – 1646.5	9.300 – 9.500
6.21500 – 6.21800	74.80000 – 75.20000	1660.0 – 1710.0	10.600 – 12.700
6.26775 – 6.26825	108.00000 – 121.94000	1718.8 – 1722.2	13.250 – 13.400
6.31175 – 6.31225	123.00000 – 138.00000	2200.0 – 2300.0	14.470 – 14.500
8.29100 – 8.29400	149.90000 – 150.05000	2310.0 – 2390.0	15.350 – 16.200
8.36200 – 8.36600	156.52475 – 156.52525	2483.5 – 2500.0	17.700 – 21.400
8.37625 – 8.38675	156.70000 – 156.90000	2655.0 – 2900.0	22.010 – 23.120
8.41425 – 8.41475	162.01250 – 167.17000	3260.0 – 3267.0	23.600 – 24.000
12.29000 – 12.29300	167.72000 – 173.20000	3332.0 – 3339.0	31.200 – 31.800
12.51975 – 12.52025	240.00000 – 285.00000	3345.8 – 3358.0	36.430 – 36.500
12.57675 – 12.57725	322.00000 – 335.40000	3600.0 – 4400.0	Above 38.6
13.36000 – 13.41000			

** : Until February 1, 1999, this restricted band shall be 0.490-0.510 MHz



7. Test of Spurious Emission (Conducted)

7.1 Test Limit

According to the methods defined in ANSI C63.10-2013 Section 11.11.1

Below -30dB of the highest emission level of operating band (In 100 kHz Resolution Bandwidth)

7.2 Test Procedure

According to the methods defined in ANSI C63.10-2013 Section 11.11.2 & 11.11.3

- a. The transmitter output was connected to the spectrum analyzer via a low loss cable.
- b. Set RBW of spectrum analyzer to 100 KHz and VBW of spectrum analyzer to 300 KHz with convenient frequency span including 100 KHz bandwidth from band edge.
- c. Peak conducted output power measured within any 100 kHz outside the authorized frequency band shall be attenuated by at least 30dB relative to the maximum measured in-band peak PSD level.
- d. The band edges was measured and recorded.

7.3 Test Setup Layout

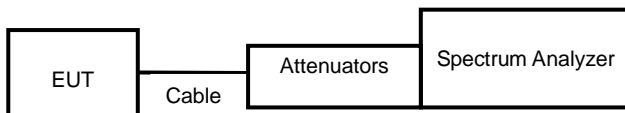

7.4 Test Result and Data

Note: Test plots refer to the following pages.



Modulation Type: GFSK(1Mbps)
CH00

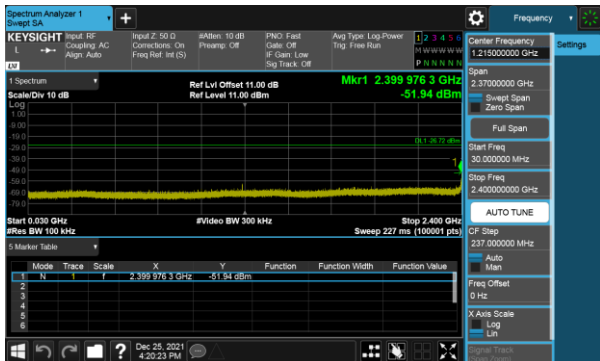

Modulation Type: GFSK(1Mbps)
CH19

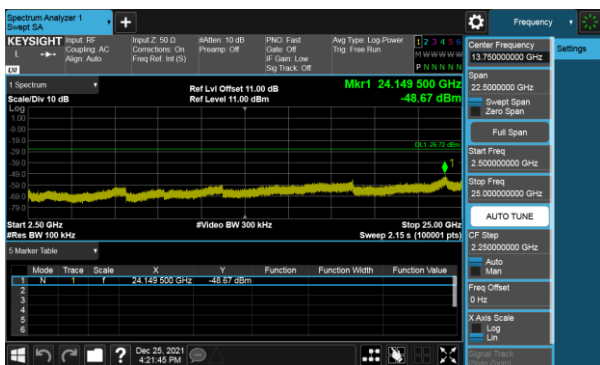
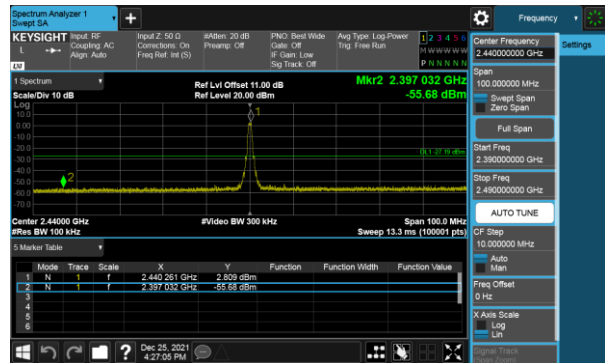
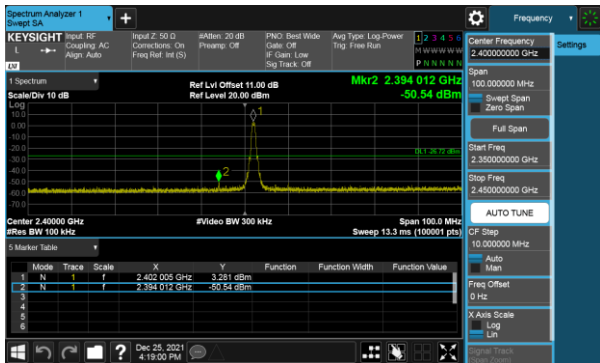
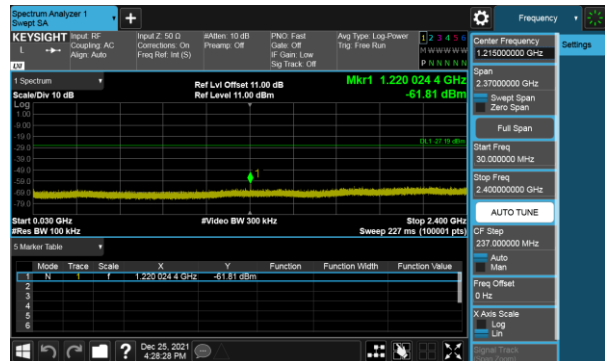



Modulation Type: GFSK(1Mbps)
CH39

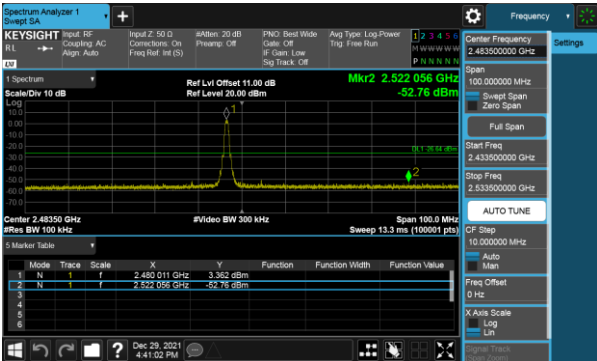
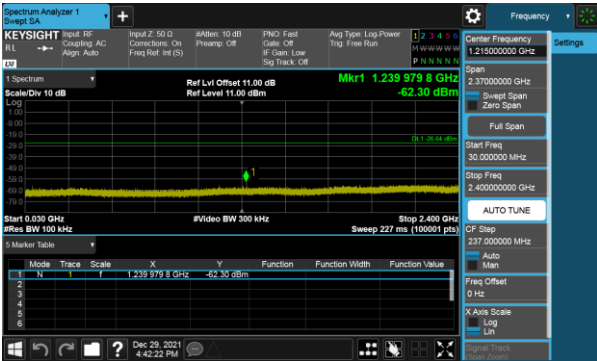



Modulation Type: GFSK(2Mbps)
CH00

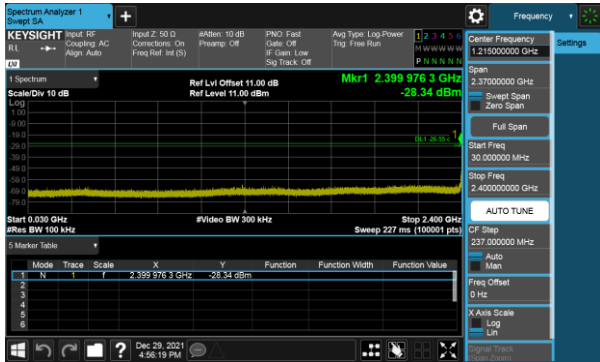

Modulation Type: GFSK(2Mbps)
CH19

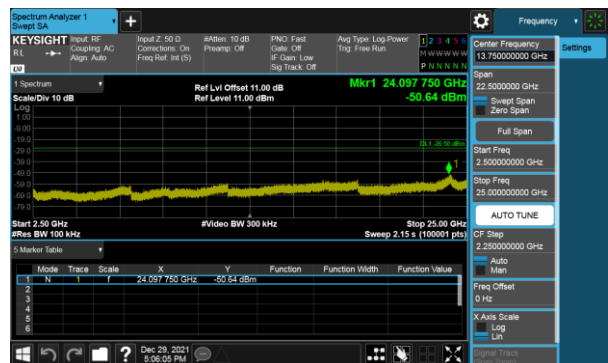
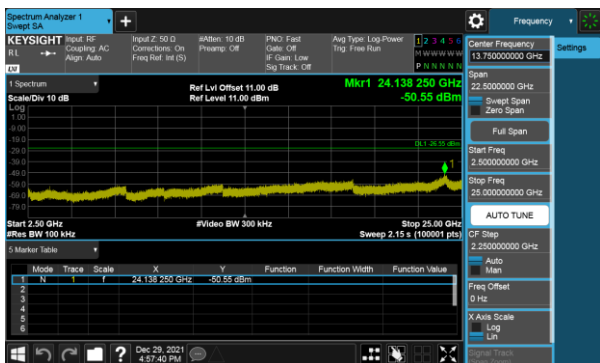
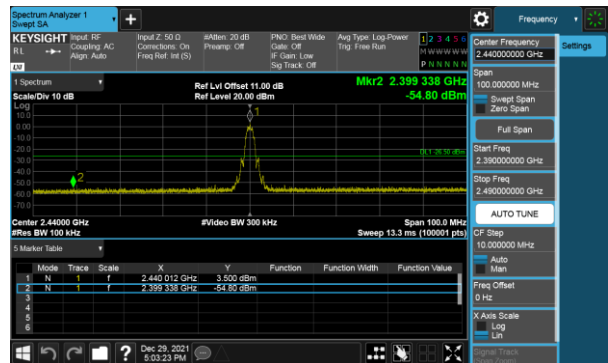
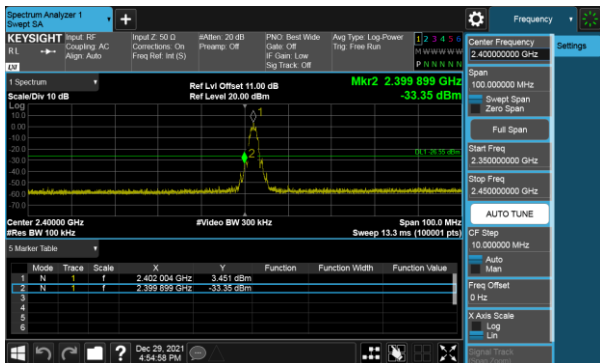
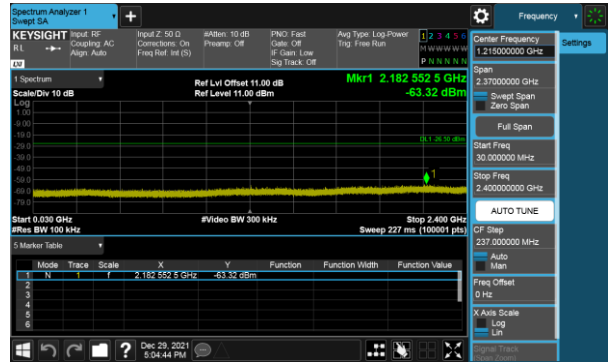



Modulation Type: GFSK(2Mbps)
CH39

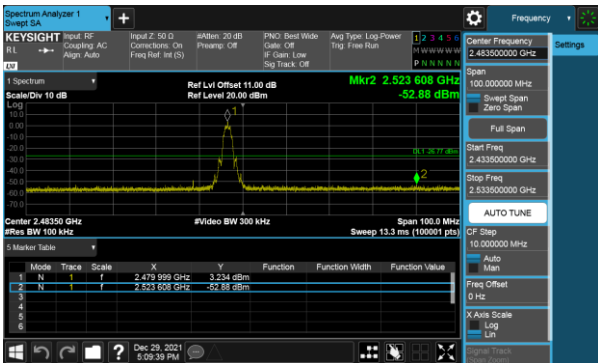
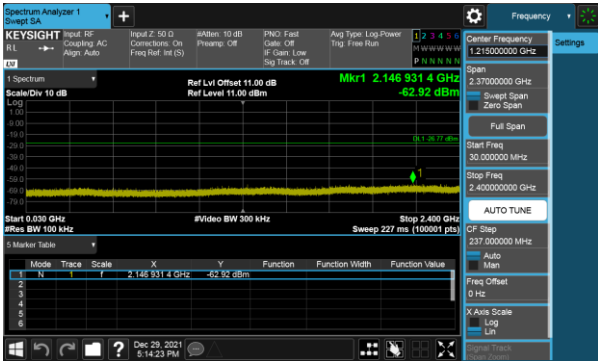



8. On Time, Duty Cycle and Measurement methods

8.1 Test Limit

None; for reporting purposes only.

8.2 Test Procedure

According to the methods defined in ANSI C63.10-2013 Section 11.6
Zero-Span Spectrum Analyzer Method.

8.3 Test Setup Layout

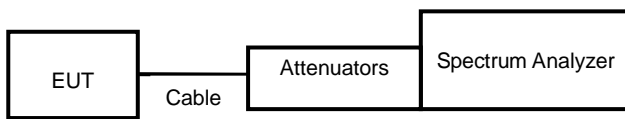

8.4 Test Result and Data

Modulation Type	On Time (ms)	Period Time (ms)	Duty Cycle (%)
GFSK(1Mbps)	0.39	0.62	63.16%
GFSK(2Mbps)	0.21	0.62	33.45%



Modulation Type: GFSK(1Mbps)



Modulation Type: GFSK(2Mbps)





9. 6dB Bandwidth Measurement Data

9.1 Test Limit

The minimum of 6dB Bandwidth Measurement is 0.5 MHz.

9.2 Test Procedures

According to the methods defined in ANSI C63.10-2013 Section 11.8

- a. The transmitter output was connected to the spectrum analyzer.
- b. Set RBW of spectrum analyzer to 100 KHz and VBW to 300 KHz.
- c. The 6 dB bandwidth is defined as the total spectrum the power of which is higher than peak power minus 6 dB.
- d. The 6dB Bandwidth was measured and recorded.

9.3 Test Setup Layout

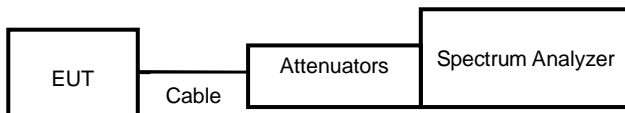

9.4 Test Result and Data

Modulation Type	Channel	Frequency (MHz)	6dB Bandwidth (KHz)	Limit (KHz)
GFSK(1Mbps)	0	2402	711.00	500
	19	2440	711.00	500
	39	2480	708.00	500

Modulation Type	Channel	Frequency (MHz)	6dB Bandwidth (KHz)	Limit (KHz)
GFSK(2Mbps)	0	2402	1191.00	500
	19	2440	1257.00	500
	39	2480	1254.00	500



6dB Bandwidth
Modulation Type: GFSK(1Mbps)
CH00



Modulation Type: GFSK(2Mbps)
CH00

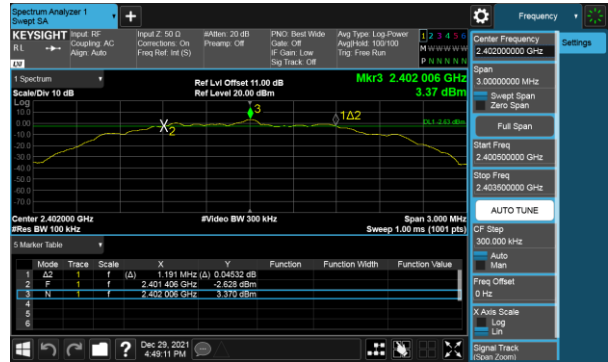

Modulation Type: GFSK(1Mbps)
CH19



Modulation Type: GFSK(2Mbps)
CH19

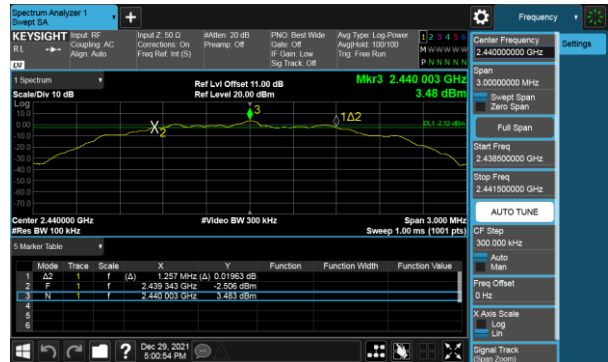

Modulation Type: GFSK(1Mbps)
CH39

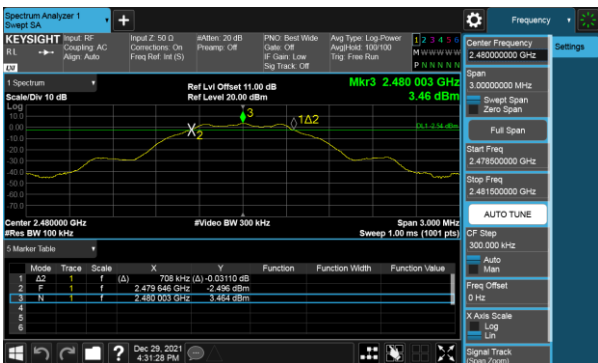

Modulation Type: GFSK(2Mbps)
CH39

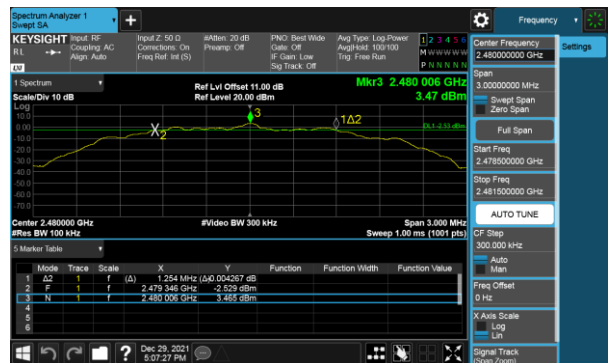



10. Maximum Average Output Power

10.1 Test Limit

The Maximum Output Power Measurement is 30dBm.

10.2 Test Procedures

According to the methods defined in ANSI C63.10-2013 Section 11.9.2.3.2

The antenna port (RF output) of the EUT was connected to the input (RF input) of a power meter. Power was read directly from the meter and cable loss connection was added to the reading to obtain power at the EUT antenna terminal. The EUT Output Power was set to maximum to produce the worse case test result.

10.3 Test Setup Layout

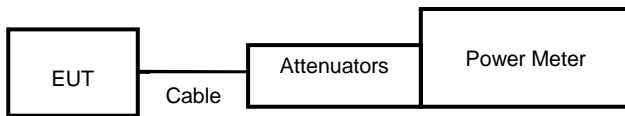



10.4 Test Result and Data

GFSK(1M bps)

Power Set	Modulation Type	Channel	Frequency (MHz)	Power Output (dBm)	Power Output (mW)
				Average	Average
4	GFSK	0	2402	2.96	1.977
4		19	2440	3.16	2.070
4		39	2480	3.15	2.065

GFSK(2M bps)

Power Set	Modulation Type	Channel	Frequency (MHz)	Power Output (dBm)	Power Output (mW)
				Average	Average
4	GFSK	0	2402	2.98	1.986
4		19	2440	3.17	2.075
4		38	2480	3.13	2.056



11. Power Spectral Density

11.1 Test Limit

The Maximum of Power Spectral Density Measurement is 8dBm.

If transmitting antennas of directional gain greater than 6 dBi are used, the power spectral density shall be reduced by the amount in dB that the directional gain of the antenna exceeds 6 dBi

11.2 Test Procedures

According to the methods defined in ANSI C63.10-2013 Section 11.10.1

11.3 Test Setup Layout

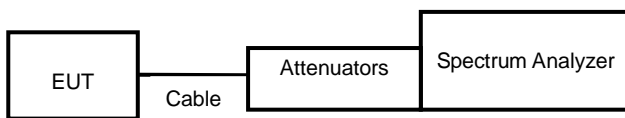

11.4 Test Result and Data

Modulation Type	Channel	Frequency (MHz)	Maximum Power Density of 10KHz Bandwidth(dBm)	Limit
GFSK(1Mbps)	0	2402	-13.589	8.00
	19	2440	-13.547	8.00
	39	2480	-13.416	8.00

Modulation Type	Channel	Frequency (MHz)	Maximum Power Density of 10KHz Bandwidth(dBm)	Limit
GFSK(2Mbps)	0	2402	-16.408	8.00
	19	2440	-16.328	8.00
	39	2480	-16.232	8.00



Modulation Type: GFSK(1Mbps)
CH00



Modulation Type: GFSK(2Mbps)
CH00

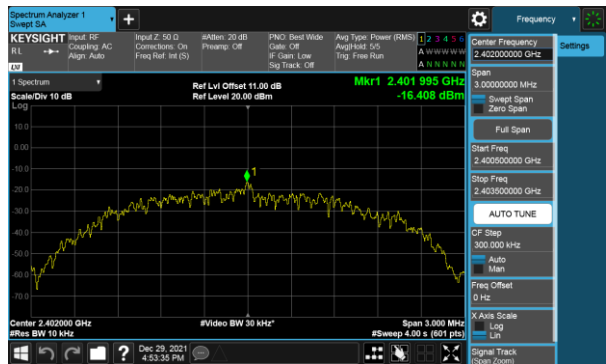

Modulation Type: GFSK(1Mbps)
CH19



Modulation Type: GFSK(2Mbps)
CH19

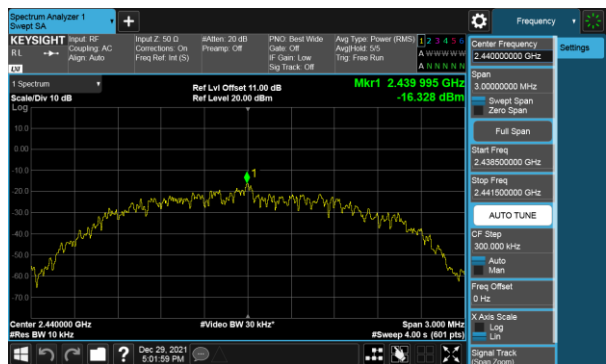

Modulation Type: GFSK(1Mbps)
CH39



Modulation Type: GFSK(2Mbps)
CH39

