



FCC RADIO TEST REPORT

Applicant : SteelSeries ApS.
Address : 656 W Randolph St., Suite 3E Chicago, IL 60661,
USA
Equipment : Transceiver
Model No. : HS25TXX
Trade Name : 
FCC ID : ZHK-HS25TXX

I HEREBY CERTIFY THAT :

The sample was received on Oct. 27, 2021 and the testing was completed on Feb. 07, 2022 at CerpPASS Technology Corp. The test result refers exclusively to the test presented test model / sample. Without written approval of CerpPASS Technology Corp., the test report shall not be reproduced except in full.

Approved by:

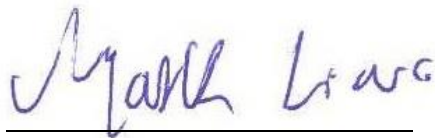

Mark Liao / Supervisor

Laboratory Accreditation:

CerpPASS Technology Corporation Test Laboratory





Contents

1. Summary of Test Procedure and Test Results.....	5
1.1 Applicable Standards	5
2. Test Configuration of Equipment under Test.....	6
2.1 Feature of Equipment under Test.....	6
2.2 Carrier Frequency of Channels.....	7
2.3 Test Mode and Test Software.....	8
2.4 Description of Test System.....	9
2.5 General Information of Test.....	10
2.6 Measurement Uncertainty	11
3. Test Equipment and Ancillaries Used for Tests	12
4. Antenna Requirements.....	14
4.1 Standard Applicable	14
4.2 Antenna Construction and Directional Gain.....	14
5. Test of AC Power Line Conducted Emission	15
5.1 Test Limit	15
5.2 Test Procedures	15
5.3 Typical Test Setup	16
5.4 Test Result and Data.....	17
5.5 Test Photographs	19
6. Test of Radiated Spurious Emission.....	20
6.1 Test Limit	20
6.2 Test Procedures	21
6.3 Typical Test Setup	22
6.4 Test Result and Data (9KHz ~ 30MHz).....	23
6.5 Test Result and Data (30MHz ~ 1GHz).....	23
6.6 Test Result and Data (1GHz ~ 25GHz).....	25
6.7 Restricted Bands of Operation	37
6.8 Test Photographs (30MHz ~ 1GHz).....	38
6.9 Test Photographs (1GHz ~ 25GHz).....	39
7. Test of Conducted Spurious Emission	41
7.1 Test Limit	41
7.2 Test Procedure	41
7.3 Test Setup Layout	41
7.4 Test Result and Data.....	41
8. On Time, Duty Cycle and Measurement methods	46
8.1 Test Limit	46
8.2 Test Procedure	46
8.3 Test Setup Layout	46
8.4 Test Result and Data.....	46
9. 6dB Bandwidth Measurement Data	48
9.1 Test Limit	48
9.2 Test Procedures	48



9.3 Test Setup Layout 48

9.4 Test Result and Data 48

10. Maximum Average Output Power 50

10.1 Test Limit 50

10.2 Test Procedures 50

10.3 Test Setup Layout 50

10.4 Test Result and Data 50

11. Power Spectral Density 51

11.1 Test Limit 51

11.2 Test Procedures 51

11.3 Test Setup Layout 51

11.4 Test Result and Data 51

12. Radio Frequency Exposure 53

12.1 Applicable Standards 53

12.2 EUT Specification 53

12.3 TEST RESULTS 54



1. Summary of Test Procedure and Test Results

1.1 Applicable Standards

ANSI C63.10:2013

FCC Rules and Regulations Part 15 Subpart C §15.247

FCC Rule	Description of Test	Result
15.203	. Antenna Requirement	PASS
15.207	. AC Power Line Conducted Emission	PASS
15.209 15.205	. Radiated Spurious Emission	PASS
15.247(d)	. Conducted Spurious Emission	PASS
15.247(a)(2)	. 6dB Bandwidth	PASS
15.247(b)	. Output Power	PASS
15.247(e)	. Power Spectral Density	PASS
2.1093	. Radio Frequency Exposure	PASS

*The lab has reduced the uncertainty risk factor from test equipment, environment and staff technicians which according to the standard on contract. Therefore, the test result will only be determined by standard requirement.

*This EUT has been also tested and compiled with the requirement of FCC Part 15, Subpart B, recorded in a separate test report(21090186-TEFV01).



2. Test Configuration of Equipment under Test

2.1 Feature of Equipment under Test

Operation Frequency Range	2400MHz-2483.5MHz
Center Frequency Range	2402MHz-2480MHz
Modulation Type	GFSK
Modulation Technology	DTS
Data Rate	GFSK: 1Mbps GFSK: 2Mbps
Antenna Type	Metal Antenna
Antenna Gain	1.2dBi,
USB-C to USB-A Cable	Brand: steelseries Model: 11043000113F
3.5 mm Audio Cable	Brand: steelseries Model: 11043000113Q

Note: For more details, please refer to the User’s manual of the EUT



2.2 Carrier Frequency of Channels

Channel	Frequency (MHz)	Channel	Frequency (MHz)	Channel	Frequency (MHz)
*00	2402	14	2430	28	2458
01	2404	15	2432	29	2460
02	2406	16	2434	30	2462
03	2408	17	2436	31	2464
04	2410	18	2438	32	2466
05	2412	*19	2440	33	2468
06	2414	20	2442	34	2470
07	2416	21	2444	35	2472
08	2418	22	2446	36	2474
09	2420	23	2448	37	2476
10	2422	24	2450	38	2478
11	2424	25	2452	*39	2480
12	2426	26	2454	--	--
13	2428	27	2456	--	--

Note: Channels remarked * are selected to perform test.



2.3 Test Mode and Test Software

- a. During testing, the interface cables and equipment positions were varied according to ANSI C63.10.
- b. The complete test system included remote workstation and EUT for RF test. The remote workstation included Notebook.
- c. An executive program, " NxH TestSuite ver. 525915dd8b4fd98102acbbdfbd9eb336f35838f7" under Windows OS system was executed to transmit and receive data via 2.4G .
- d. The following test modes were performed for the test:

Conducted Emissions from the AC mains power ports	
Test Mode	Operating Description
1	GFSK (1Mbps), Form System(120V/60Hz)
2	GFSK (2Mbps), Form System(120V/60Hz)
3	GFSK (1Mbps), Form System (240V/60Hz)
4	GFSK (2Mbps), Form System (240V/60Hz)
5	GFSK (1Mbps), Form Adapter(120V/60Hz)
6	GFSK (2Mbps), Form Adapter (120V/60Hz)
7	GFSK (1Mbps), Form Adapter (240V/60Hz)
8	GFSK (2Mbps), Form Adapter (240V/60Hz)
caused "Test Mode 3" generated the worst case, it was reported as the final data.	
Radiation Emissions (30MHz ~ 1GHz)	
Test Mode	Operating Description
1	GFSK (1Mbps), Form System (120V/60Hz)
2	GFSK (2Mbps), Form System (120V/60Hz)
3	GFSK (1Mbps), Form Adapter (120V/60Hz)
4	GFSK (2Mbps), Form Adapter (120V/60Hz)
caused "Test Mode 3" generated the worst case, it was reported as the final data.	
Radiation Emissions (1GHz ~ 25GHz)	
Test Mode	Operating Description
1	GFSK (1Mbps), Form Adapter (120V/60Hz)
2	GFSK (2Mbps), Form Adapter (120V/60Hz)
caused "Test Mode 1, 2" generated the worst case, they were reported as the final data.	

Modulation Type	TX CONFIGURATION
GFSK (1Mbps)	1TX
GFSK (2Mbps)	1TX



2.4 Description of Test System

RF Conducted				
Equipment	Brand	Model	Length/Type	Power cord/Length/Type
Notebook	DELL	Latitude E5450	N/A	Adapter / 1.8m / NS
Radiated Emissions				
Equipment	Brand	Model	Length/Type	Power cord/Length/Type
Notebook	ASUS	P2430U	N/A	Adapter / 1.8m / NS
Adapter	HODA	TC03	N/A	N/A
Earphone	Apple	Earpods	1.2m / NS	N/A
AC Power Line Conducted Emission				
Equipment	Brand	Model	Length/Type	Power cord/Length/Type
Notebook	ASUS	P2430U	N/A	Adapter / 1.8m / NS
Adapter	HODA	TC03	N/A	N/A
Earphone	Apple	Earpods	1.2m / NS	N/A

**2.5 General Information of Test**

Test Site	CerpPASS Technology Corporation Test Laboratory Address: No.10, Ln. 2, Lianfu St., Luzhu Dist., Taoyuan City 33848, Taiwan (R.O.C.) Tel:+886-3-3226-888 Fax:+886-3-3226-881	
	FCC	TW1439, TW1079
	IC	4934E-1, 4934E-2
	VCCI	T-2205 for Telecommunication test C-4663 for Conducted emission test R-4218 for Radiated emission test G-10812, G-10813 for radiated disturbance above 1GHz
Frequency Range Investigated:	Conducted: from 150kHz to 30 MHz Radiation: from 30 MHz to 25,000MHz	
Test Distance:	The test distance of radiated emission from antenna to EUT is 3 M.	

Test Item	Test Site	Test period	Environmental Conditions	Tested By
RF Conducted	RFCON01-NK	2022/1/21~2022/02/07	24~26°C / 50~53%	Dian Chen
Radiated Emissions	3M03-NK	2022/01/18~2022/01/20	24~26°C / 44~48%	Dian Chen
AC Power Line Conducted Emission	CON01-NK	2022/01/22	22°C / 50%	Dian Chen



2.6 Measurement Uncertainty

ISO/IEC 17025 requires that an estimate of the measurement uncertainties associated with the emissions test results be included in the report. The measurement uncertainties given below are based on a 95% confidence level (based on a coverage factor (k=2))

Measurement Item	Uncertainty
AC Power Line Conduction(150K~30MHz)	±3.12dB
Radiated Spurious Emission(9KHz~30MHz)	±3.4dB
Radiated Spurious Emission(30MHz~1GHz)	±5.6dB
Radiated Spurious Emission(1GHz~25GHz)	±6.6dB
Conducted Spurious Emission	±1.8dB
6dB Bandwidth	±4.4%
20dB Bandwidth	±4.4%
Occupied Bandwidth	±4.4%
Peak Output Power(Conducted Power Meter)	±1.1dB
Dwell Time / Deactivation Time	±1.2%
Power Spectral Density	±1.8dB
Duty Cycle	±1.2%



3. Test Equipment and Ancillaries Used for Tests

Test Item	Radiated Emissions				
Test Site	Semi Anechoic Room(3M03-NK)				
Instrument	Manufacturer	Model No	Serial No	Calibration Date	Valid Date
Bilog Antenna	Sunol	JB1	A080713	2021/11/05	2022/11/04
Active Loop Antenna	EMCO	6507	40855	2021/06/10	2022/06/09
Double Ridged Guide Horn Antenna	RF SPAN	DRH18-E	210309A18-ES	2021/11/09	2022/11/08
Horn Antenna	EMCO	3116	31970	2021/03/29	2022/03/28
Spectrum Analyzer	ROHDE & SCHWARZ	FSP 40	100219	2021/08/06	2022/08/05
Preamplifier	EM Electronics corp.	EM01G18G	60831	2021/06/25	2022/06/24
Preamplifier	EMC INSTRUMENTS	EMC184045	980065	2021/11/16	2022/11/15
Amplifier	EM Electronics corp.	EM330	60820	2021/07/25	2022/07/24
Bluetooth Tester	ROHDE & SCHWARZ	CBT	101133	2021/04/19	2022/04/18
Cable-1m(30M-1G)	HUBER SUHNER	RG-214	00419M	2021/06/29	2022/06/28
Cable-1.5m(30M-1G)	HUBER SUHNER	RG-214	00420M	2021/06/29	2022/06/28
Cable-9m(30M-1G)	HUBER SUHNER	RG-214	00430M	2021/06/29	2022/06/28
Cable-6m(9k~300M)	NA	EMC5D-BM-BM-6	130605	2021/09/22	2022/09/21
Cable-1.5m(1G-26.5G)	EMEC	EM104-SMSM-1.5M	EM104-SMSM-1.5M	2021/06/29	2022/06/28
Cable-9m(1G-26.5G)	EMEC	EM104-SMSM-9M	EM104-SMSM-9M	2021/06/29	2022/06/28
Cable-0.5m(30M-40G)	HUBER SUHNER	SUCOFLEX 102	28420/2	2021/04/03	2022/04/02
Cable-3m(30M-40G)	HUBER SUHNER	SUCOFLEX 102	MY2608/2	2021/04/09	2022/04/08
E3	AUDIX	v8.2014-8-6	RK-000529	NA	NA

Test Item	RF Conducted				
Test Site	RFCON01-NK				
Instrument	Manufacturer	Model No	Serial No	Calibration Date	Valid Date
Bluetooth Tester	ROHDE & SCHWARZ	CBT	101133	2021/04/19	2022/04/18
CAX Signal Analyzer	KEYSIGHT	N9000B	MY57100339	2022/01/10	2023/01/09
Attenuator	KEYSIGHT	8491B	MY39250703	2021/04/09	2022/04/08
TEMP & HUMID CHAMBER	T-MACHINE	TMJ-9712	T-12-040111	2021/08/27	2022/08/26
Cable-0.5m(1G-26.5G)	HUBER SUHNER	SUCOFLEX 102	28422/2	2021/04/08	2022/04/07
Power Meter	Anritsu	ML2495A	1224005	2021/04/14	2022/04/13
Power Sensor	Anritsu	MA2411B	1207295	2021/04/14	2022/04/13
Switch Box	Theda	1-4	TW5451159	NA	NA
MXG-B RF Vector Signal Generator	KEYSIGHT	N5182B	MY53051383	2021/06/30	2022/06/29



Test Item	AC Power Line Conducted Emission				
Test Site	CON01-NK				
Instrument	Manufacturer	Model No	Serial No	Calibration Date	Valid Date
EMI Receiver	ROHDE & SCHWARZ	ESCI	101200	2021/08/30	2022/08/29
Line Impedance Stabilization Network	Schwarzbeck	NSLK 8127	8127-568	2021/06/02	2022/06/01
Pulse Limiter	ROHDE & SCHWARZ	ESH3-Z2	101934	2021/03/10	2022/03/09
Cable-6m(9k~300M)	NA	EMC5D-BM-BM-6	130606	2021/03/15	2022/03/14
E3	AUDIX	v8.2014-8-6	RK-000531	NA	NA



4. Antenna Requirements

4.1 Standard Applicable

For intentional device, according to FCC 47 CFR Section 15.203, an intentional radiator shall be designed to ensure that no antenna other than that furnished by the responsible party shall be used with the device.

And according to FCC 47 CFR Section 15.247 (b), if transmitting antennas of directional gain greater than 6dBi are used, the power shall be reduced by the amount in dB that the directional gain of the antenna exceeds 6dBi.

4.2 Antenna Construction and Directional Gain

Antenna Type	Metal Antenna
Antenna Gain	1.2 dBi



5. Test of AC Power Line Conducted Emission

5.1 Test Limit

Conducted Emissions were measured from 150 kHz to 30 MHz with a bandwidth of 9 KHz, according to the methods defined in ANSI C63.10-2013. The EUT was placed on a nonmetallic stand in a shielded room 0.8 meters above the ground plane. The interface cables and equipment positioning were varied within limits of reasonable applications to determine the position produced maximum conducted emissions.

Frequency (MHz)	Quasi Peak (dB μ V)	Average (dB μ V)
0.15 – 0.5	66-56*	56-46*
0.5 – 5.0	56	46
5.0 – 30.0	60	50

*Decreases with the logarithm of the frequency.

5.2 Test Procedures

- a. The EUT was placed 0.4 meter from the conducting wall of the shielding room was kept at least 80 centimeters from any other grounded conducting surface.
- b. Connect EUT to the power mains through a line impedance stabilization network (LISN).
- c. All the support units are connecting to the other LISN.
- d. The LISN provides 50 ohm coupling impedance for the measuring instrument.
- e. The FCC states that a 50 ohm, 50 micro-Henry LISN should be used.
- f. Both sides of AC line were checked for maximum conducted interference.
- g. The frequency range from 150 kHz to 30 MHz was searched.
- h. Set the test-receiver system to Peak Detect Function and Specified Bandwidth with Maximum Hold Mode.



5.3 Typical Test Setup

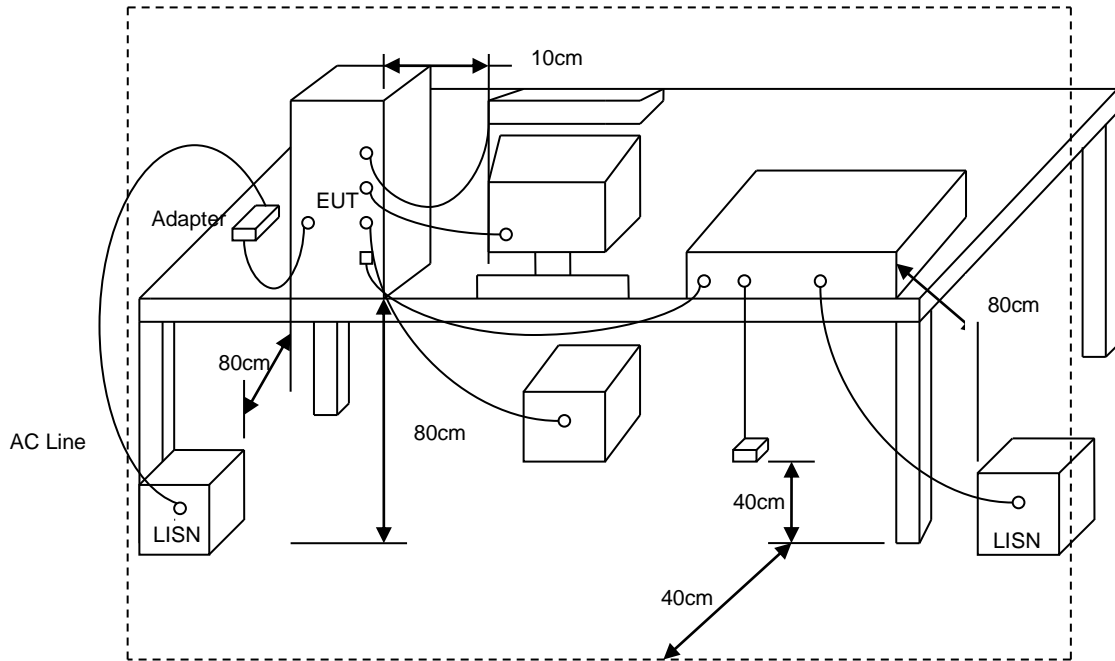



5.4 Test Result and Data

Power	: DC 5V From System (AC 240V / 60Hz)	Pol/Phase	: LINE
Test Mode	: Mode 3		:

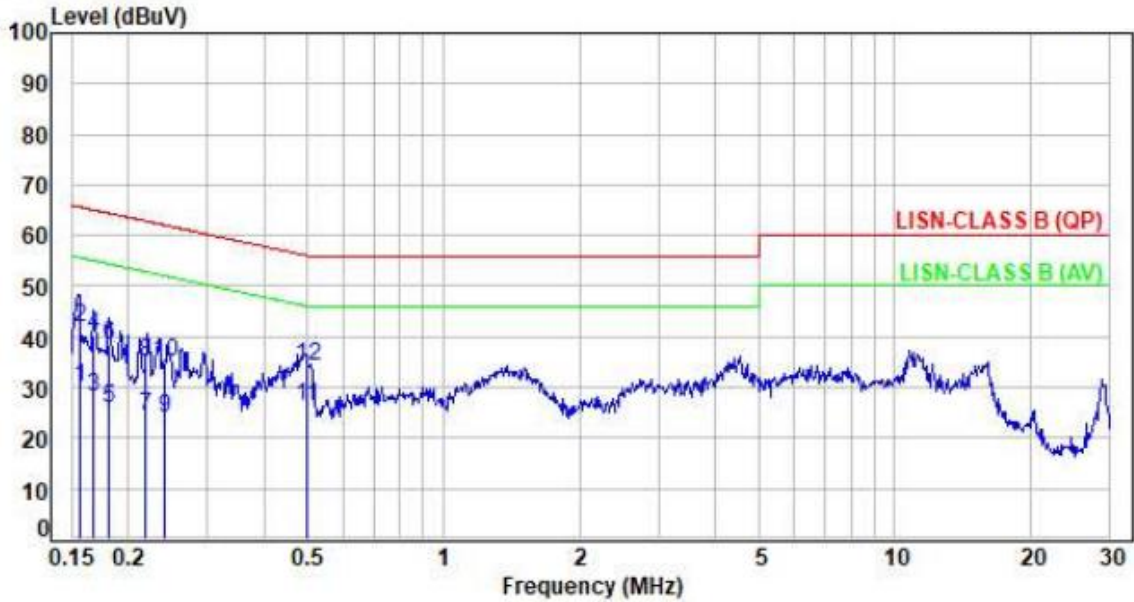

No.	Frequency (MHz)	Factor (dB)	Reading (dBuV)	Level (dBuV)	Limit (dBuV)	Margin (dB)	Detector	P/F
1	0.16	9.97	19.91	29.88	55.68	-25.80	Average	P
2	0.16	9.97	31.71	41.68	65.68	-24.00	QP	P
3	0.17	9.97	18.20	28.17	55.05	-26.88	Average	P
4	0.17	9.97	30.41	40.38	65.05	-24.67	QP	P
5	0.18	9.97	15.75	25.72	54.40	-28.68	Average	P
6	0.18	9.97	28.45	38.42	64.40	-25.98	QP	P
7	0.22	9.97	14.38	24.35	52.88	-28.53	Average	P
8	0.22	9.97	25.06	35.03	62.88	-27.85	QP	P
9	0.24	9.97	13.99	23.96	52.05	-28.09	Average	P
10	0.24	9.97	24.99	34.96	62.05	-27.09	QP	P
11	0.50	9.99	16.22	26.21	46.05	-19.84	Average	P
12	0.50	9.99	24.09	34.08	56.05	-21.97	QP	P

Note: Level=Reading+Factor
 Margin=Level-Limit
 Factor=(LISN or ISN or Current Probe)Factor + Cable Loss



Power	: DC 5V From System (AC 240V / 60Hz)	Pol/Phase	: NEUTRAL
Test Mode	: Mode 3		:

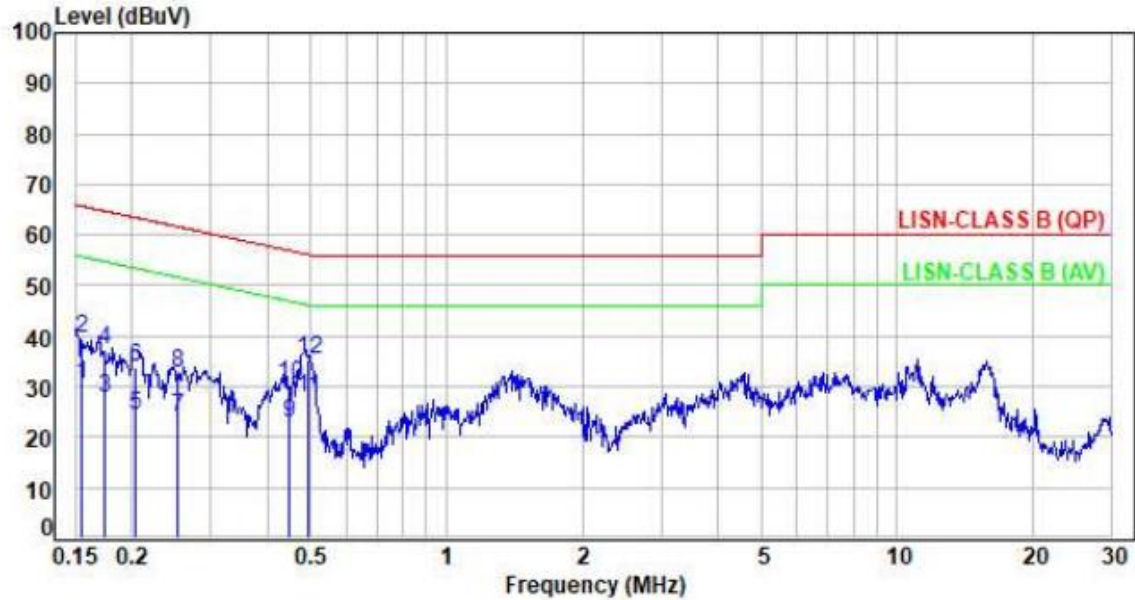

No.	Frequency (MHz)	Factor (dB)	Reading (dBuV)	Level (dBuV)	Limit (dBuV)	Margin (dB)	Detector	P/F
1	0.15	9.97	20.60	30.57	55.77	-25.20	Average	P
2	0.15	9.97	29.43	39.40	65.77	-26.37	QP	P
3	0.17	9.97	17.78	27.75	54.79	-27.04	Average	P
4	0.17	9.97	27.25	37.22	64.79	-27.57	QP	P
5	0.20	9.97	14.31	24.28	53.48	-29.20	Average	P
6	0.20	9.97	23.72	33.69	63.48	-29.79	QP	P
7	0.25	9.97	14.15	24.12	51.67	-27.55	Average	P
8	0.25	9.97	22.70	32.67	61.67	-29.00	QP	P
9	0.45	9.98	12.88	22.86	46.93	-24.07	Average	P
10	0.45	9.98	20.38	30.36	56.93	-26.57	QP	P
11	0.49	9.98	17.85	27.83	46.11	-18.28	Average	P
12	0.49	9.98	25.33	35.31	56.11	-20.80	QP	P

Note: Level=Reading+Factor
 Margin=Level-Limit
 Factor=(LISN or ISN or Current Probe)Factor + Cable Loss



6. Test of Radiated Spurious Emission

6.1 Test Limit

In any 100kHz bandwidth outside the frequency band in which the spread spectrum or digitally modulated intentional radiator is operating, the radio frequency power that is produced by the intentional radiator shall be at least 20dB below that in the 100kHz bandwidth within the band that contains the highest level of the desired power, based on either an RF conducted or a radiated measurement. If the transmitter measurement is based on the maximum conducted output power, the attenuation required under this paragraph shall be 30dB instead of 20dB. In addition, radiated emissions which fall in section 15.205(a) the restricted bands must also comply with the radiated emission limit specified in section 15.209(a).

Frequency (MHz)	Field Strength (microvolt/meter)	Measurement Distance (meters)
0.009 ~ 0.490	2400/F(kHz)	300
0.490 ~ 1.705	24000/F(kHz)	30
1.705 ~ 30.0	30	30
30 ~ 88	100	3
88 ~ 216	150	3
216 ~ 960	200	3
Above 960	500	3



6.2 Test Procedures

- a. The EUT was placed on a rotatable table top 0.8 meter above ground.
- b. The EUT was set 3 meters from the interference receiving antenna which was mounted on the top of a variable height antenna tower.
- c. The table was rotated 360 degrees to determine the position of the highest radiation.
- d. The antenna is a broadband antenna and its height is varied between one meter and four meters above ground to find the maximum value of the field strength both horizontal polarization and vertical polarization of the antenna are set to make the measurement.
- e. For each suspected emission the EUT was arranged to its worst case and then tune the antenna tower (from 1 M to 4 M) and turn table (from 0 degree to 360 degrees) to find the maximum reading.
- f. Set the test-receiver system to Peak or CISPR quasi-peak Detect Function and specified bandwidth with Maximum Hold Mode.
- g. If the emission level of the EUT in peak mode was 3 dB lower than the limit specified, then testing will be stopped and peak values of EUT will be reported, otherwise, the emissions which do not have 3 dB margin will be repeated one by one using the quasi-peak method and reported.
- h. For testing above 1GHz, the emission level of the EUT in peak mode was 20dB lower than average limit (that means the emission level in peak mode also complies with the limit in average mode), then testing will be stopped and peak values of EUT will be reported, otherwise, the emissions will be measured in average mode again and reported.
- i. "Cone of radiation" has been considered to be 3dB bandwidth of the measurement antenna.

Note:

- 1.The supporting fixture shall permit orientation of the EUT in each of three orthogonal axis positions such that emissions from the EUT are maximized.
(Z-AXIS is the worst.)
- 2.Due to the test software function limit the operation band setting(200dBuV/m).
There's no corresponding limitation in the actual test item.



6.3 Typical Test Setup

Below 30MHz test setup

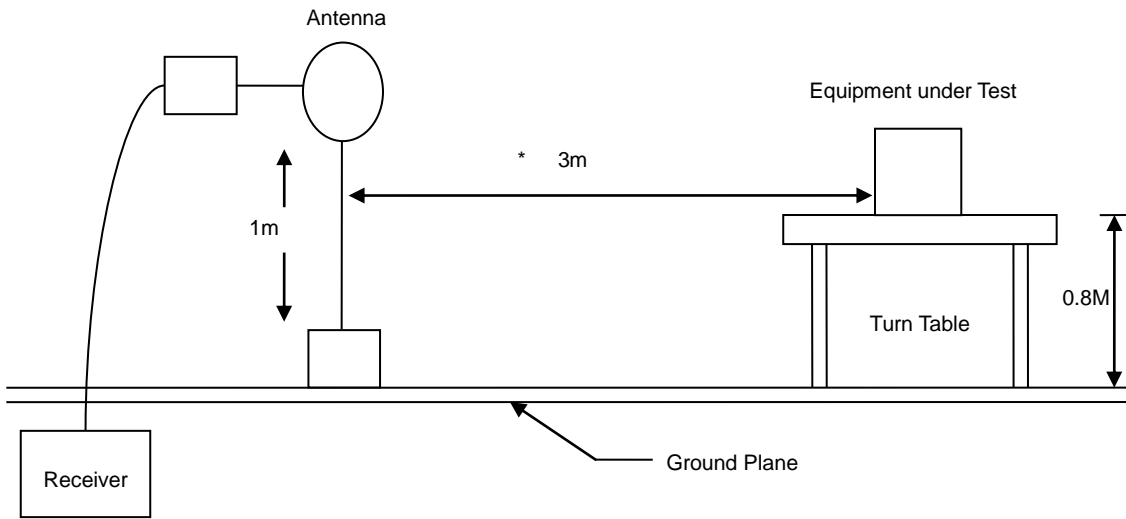

30MHz- 1GHz Test Setup

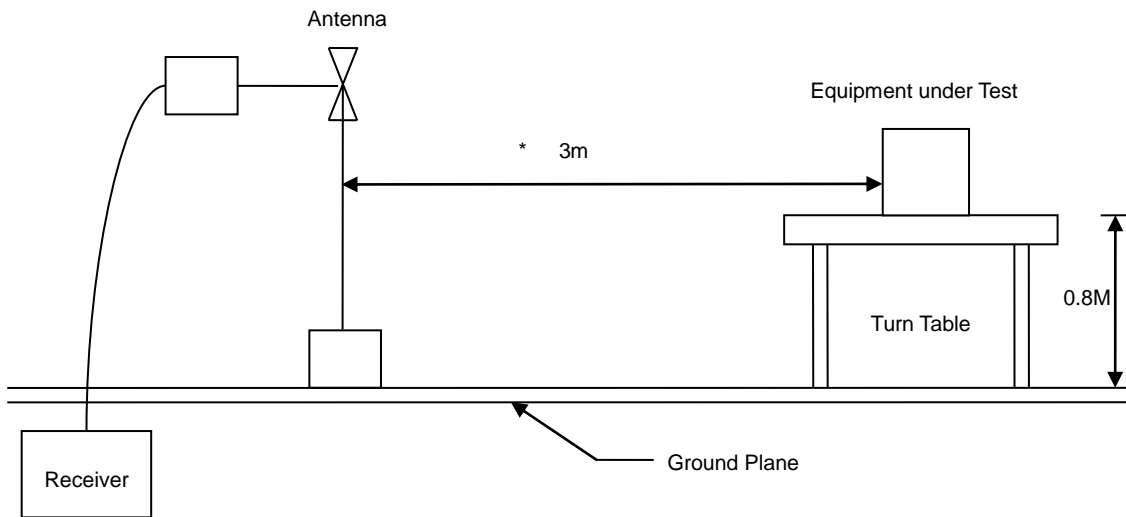

Above 1GHz Test Setup

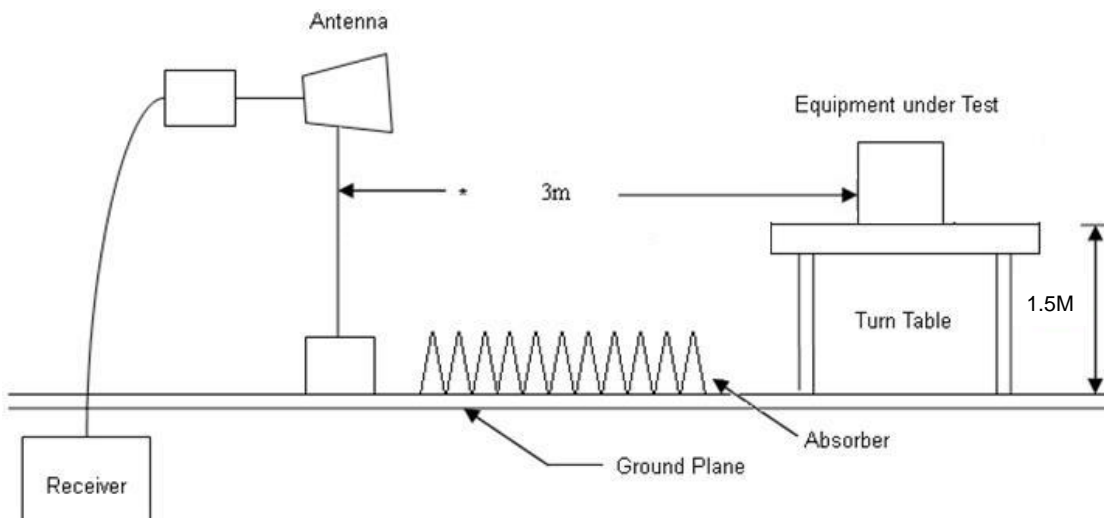



6.4 Test Result and Data (9KHz ~ 30MHz)

The 9kHz - 30MHz spurious emission is under limit 20dB more.

6.5 Test Result and Data (30MHz ~ 1GHz)

Power	: DC 5V From Adapter (AC 120V / 60Hz)	Pol/Phase	: VERTICAL
Test Mode	: Mode 3		:

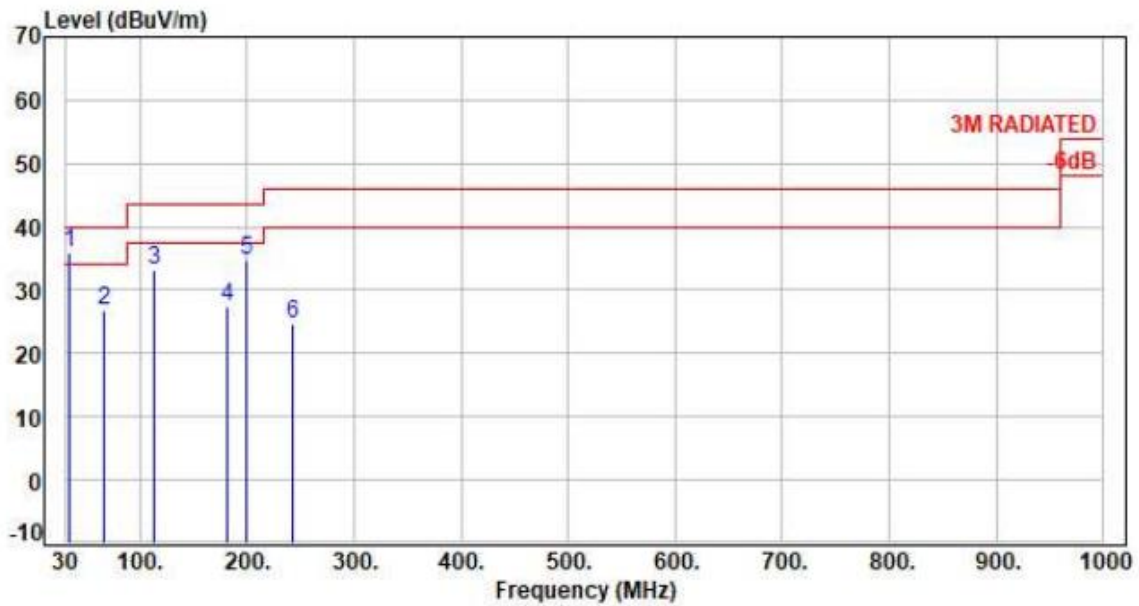

No.	Frequency (MHz)	Factor (dB)	Reading (dBuV)	Level (dBuV/m)	Limit (dBuV/m)	Margin (dB)	Detector	Height (cm)	Azimuth (deg)	P/F
1	33.88	-6.51	42.56	36.05	40.00	-3.95	Peak	400	0	P
2	66.86	-17.25	43.92	26.67	40.00	-13.33	Peak	400	0	P
3	113.42	-12.05	45.16	33.11	43.50	-10.39	Peak	400	0	P
4	181.32	-13.61	41.10	27.49	43.50	-16.01	Peak	400	0	P
5	198.78	-10.89	45.52	34.63	43.50	-8.87	Peak	400	0	P
6	243.40	-12.45	37.05	24.60	46.00	-21.40	Peak	400	0	P

Note: Level=Reading+Factor
 Margin=Level-Limit
 Factor=Antenna Factor + cable loss - Amplifier Factor



Power	: DC 5V From Adapter (AC 120V / 60Hz)	Pol/Phase	: HORIZONTAL
Test Mode	: Mode 3		:

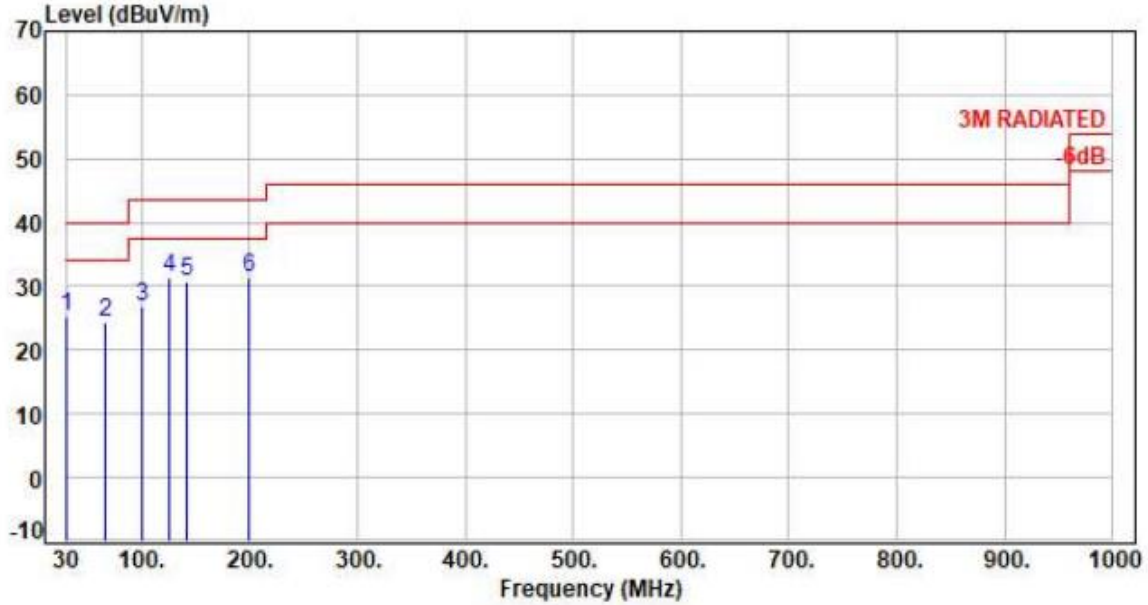

No.	Frequency (MHz)	Factor (dB)	Reading (dBuV)	Level (dBuV/m)	Limit (dBuV/m)	Margin (dB)	Detector	Height (cm)	Azimuth (deg)	P/F
1	30.00	-3.62	28.87	25.25	40.00	-14.75	Peak	400	360	P
2	66.86	-17.25	41.72	24.47	40.00	-15.53	Peak	400	360	P
3	99.84	-15.09	42.02	26.93	43.50	-16.57	Peak	400	360	P
4	125.06	-10.90	42.15	31.25	43.50	-12.25	Peak	400	360	P
5	142.52	-11.73	42.63	30.90	43.50	-12.60	Peak	400	360	P
6	198.78	-10.89	42.22	31.33	43.50	-12.17	Peak	400	360	P

Note: Level=Reading+Factor
 Margin=Level-Limit
 Factor=Antenna Factor + cable loss - Amplifier Factor



6.6 Test Result and Data (1GHz ~ 25GHz)

Power	: DC 5V From Adapter (AC 120V / 60Hz)	Pol/Phase	: VERTICAL
Test Mode	: Mode 1, CH00		

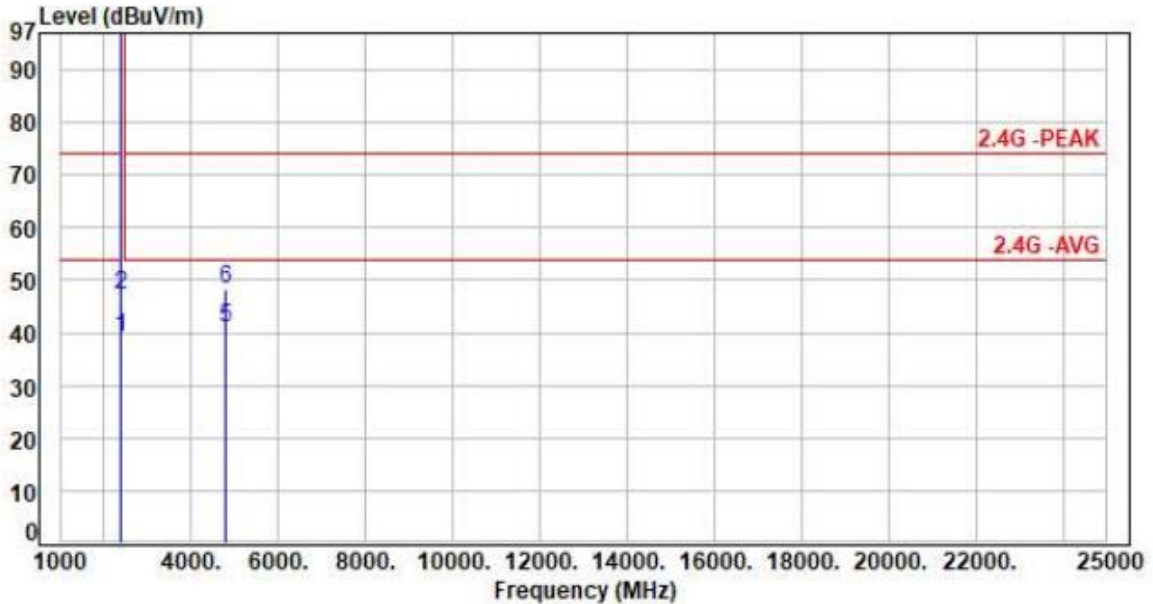

No.	Frequency (MHz)	Factor (dB)	Reading (dBuV)	Level (dBuV/m)	Limit (dBuV/m)	Margin (dB)	Detector	Height (cm)	Azimuth (deg)	P/F
1	2390.00	-15.29	54.32	39.03	54.00	-14.97	Average	100	204	P
2	2390.00	-15.29	62.44	47.15	74.00	-26.85	Peak	100	204	P
3	2402.00	-15.33	116.29	100.96	200.00	-99.04	Average	100	204	P
4	2402.00	-15.33	118.75	103.42	200.00	-96.58	Peak	100	204	P
5	4804.00	-7.22	48.34	41.12	54.00	-12.88	Average	100	117	P
6	4804.00	-7.22	55.42	48.20	74.00	-25.80	Peak	100	117	P

Note: Level=Reading+Factor
 Margin=Level-Limit
 Factor=Antenna Factor + cable loss - Amplifier Factor



Power	: DC 5V From Adapter (AC 120V / 60Hz)	Pol/Phase	: HORIZONTAL
Test Mode	: Mode 1, CH00		:

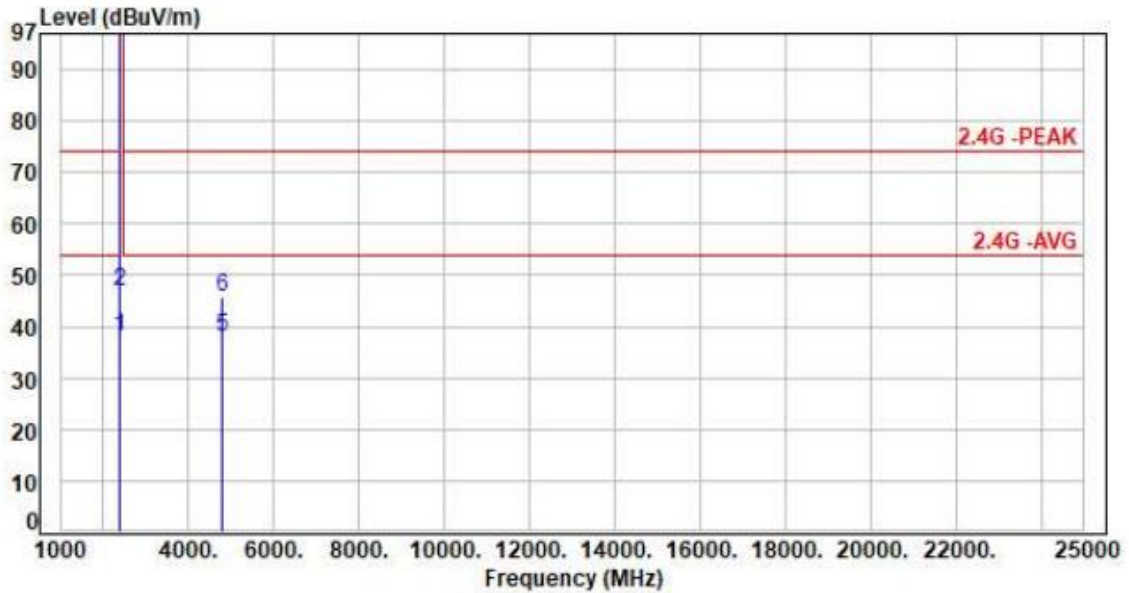

No.	Frequency (MHz)	Factor (dB)	Reading (dBUV)	Level (dBUV/m)	Limit (dBUV/m)	Margin (dB)	Detector	Height (cm)	Azimuth (deg)	P/F
1	2390.00	-15.29	53.26	37.97	54.00	-16.03	Average	100	186	P
2	2390.00	-15.29	62.12	46.83	74.00	-27.17	Peak	100	186	P
3	2402.00	-15.33	114.24	98.91	200.00	-101.09	Average	100	186	P
4	2402.00	-15.33	116.47	101.14	200.00	-98.86	Peak	100	186	P
5	4804.00	-7.22	45.23	38.01	54.00	-15.99	Average	196	247	P
6	4804.00	-7.22	52.92	45.70	74.00	-28.30	Peak	196	247	P

Note: Level=Reading+Factor
 Margin=Level-Limit
 Factor=Antenna Factor + cable loss - Amplifier Factor



Power	: DC 5V From Adapter (AC 120V / 60Hz)	Pol/Phase	: VERTICAL
Test Mode	: Mode 1, CH19		:

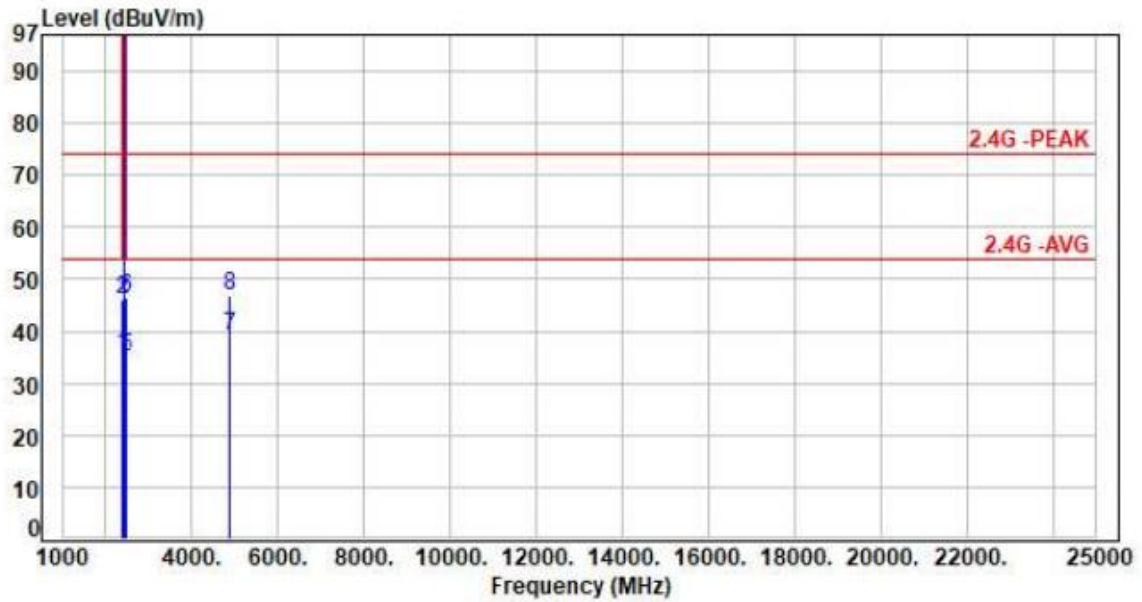

No.	Frequency (MHz)	Factor (dB)	Reading (dBuV)	Level (dBuV/m)	Limit (dBuV/m)	Margin (dB)	Detector	Height (cm)	Azimuth (deg)	P/F
1	2390.00	-15.29	50.71	35.42	54.00	-18.58	Average	100	243	P
2	2390.00	-15.29	61.43	46.14	74.00	-27.86	Peak	100	243	P
3	2440.00	-15.43	116.31	100.88	200.00	-99.12	Average	100	243	P
4	2440.00	-15.43	118.66	103.23	200.00	-96.77	Peak	100	243	P
5	2483.50	-15.35	50.56	35.21	54.00	-18.79	Average	100	243	P
6	2483.50	-15.35	61.69	46.34	74.00	-27.66	Peak	100	243	P
7	4880.00	-7.01	46.24	39.23	54.00	-14.77	Average	100	197	P
8	4880.00	-7.01	53.85	46.84	74.00	-27.16	Peak	100	197	P

Note: Level=Reading+Factor
 Margin=Level-Limit
 Factor=Antenna Factor + cable loss - Amplifier Factor



Power	: DC 5V From Adapter (AC 120V / 60Hz)	Pol/Phase	: HORIZONTAL
Test Mode	: Mode 1, CH19		:

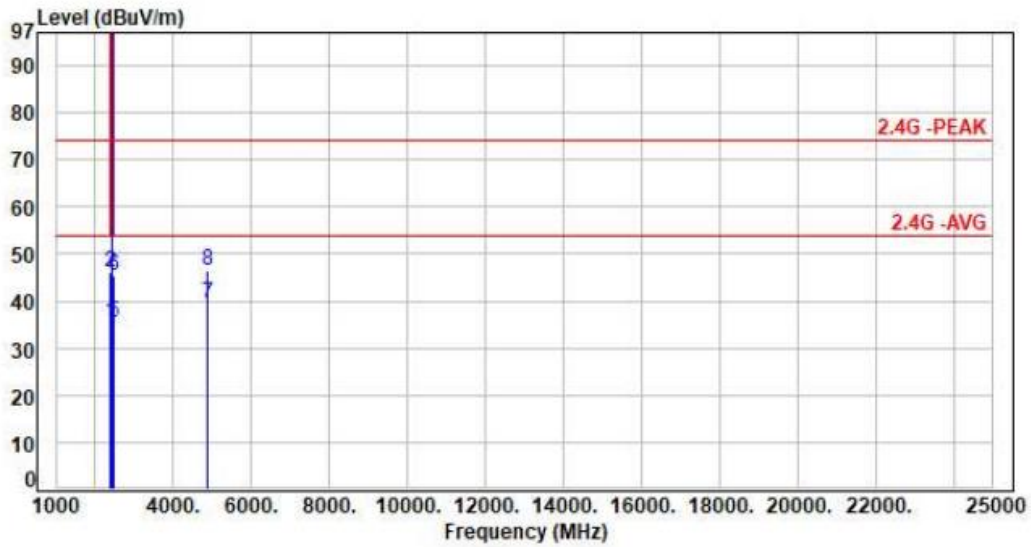

No.	Frequency (MHz)	Factor (dB)	Reading (dBuV)	Level (dBuV/m)	Limit (dBuV/m)	Margin (dB)	Detector	Height (cm)	Azimuth (deg)	P/F
1	2390.00	-15.29	50.77	35.48	54.00	-18.52	Average	158	177	P
2	2390.00	-15.29	61.24	45.95	74.00	-28.05	Peak	158	177	P
3	2440.00	-15.43	115.52	100.09	200.00	-99.91	Average	158	177	P
4	2440.00	-15.43	117.53	102.10	200.00	-97.90	Peak	158	177	P
5	2483.50	-15.35	50.77	35.42	54.00	-18.58	Average	158	177	P
6	2483.50	-15.35	60.84	45.49	74.00	-28.51	Peak	158	177	P
7	4880.00	-7.01	46.53	39.52	54.00	-14.48	Average	191	240	P
8	4880.00	-7.01	53.44	46.43	74.00	-27.57	Peak	191	240	P

Note: Level=Reading+Factor
 Margin=Level-Limit
 Factor=Antenna Factor + cable loss - Amplifier Factor



Power	: DC 5V From Adapter (AC 120V / 60Hz)	Pol/Phase	: VERTICAL
Test Mode	: Mode 1, CH39		:

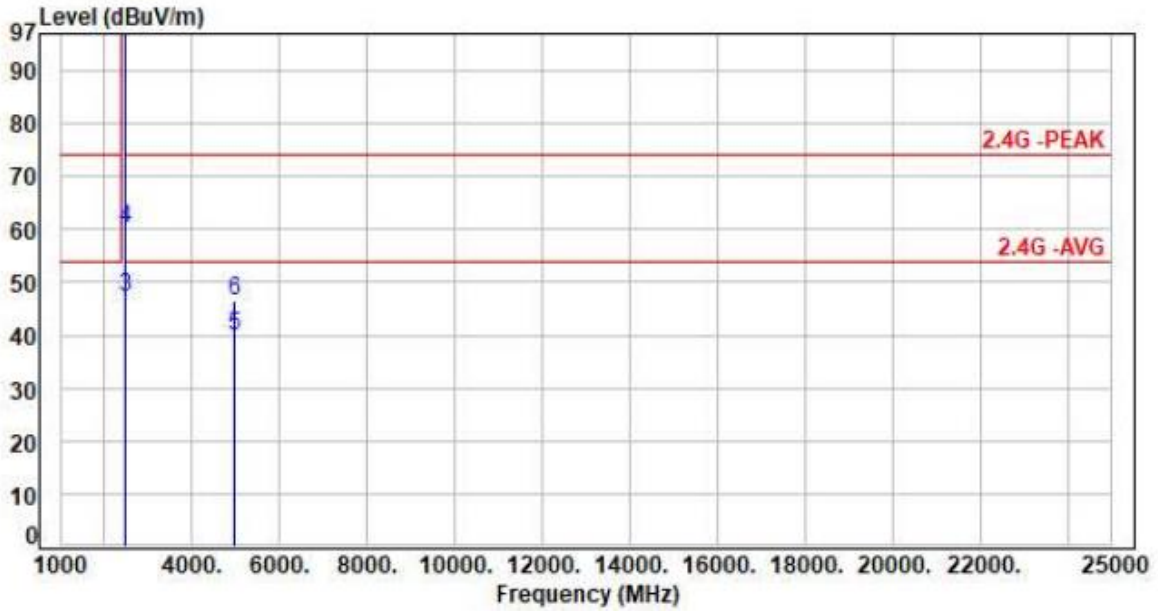

No.	Frequency (MHz)	Factor (dB)	Reading (dBuV)	Level (dBuV/m)	Limit (dBuV/m)	Margin (dB)	Detector	Height (cm)	Azimuth (deg)	P/F
1	2480.00	-15.37	115.82	100.45	200.00	-99.55	Average	256	222	P
2	2480.00	-15.37	118.44	103.07	200.00	-96.93	Peak	256	222	P
3	2483.50	-15.35	62.55	47.20	54.00	-6.80	Average	256	222	P
4	2483.50	-15.35	75.34	59.99	74.00	-14.01	Peak	256	222	P
5	4960.00	-6.53	46.20	39.67	54.00	-14.33	Average	100	211	P
6	4960.00	-6.53	52.88	46.35	74.00	-27.65	Peak	100	211	P

Note: Level=Reading+Factor
Margin=Level-Limit
Factor=Antenna Factor + cable loss - Amplifier Factor



Power	: DC 5V From Adapter (AC 120V / 60Hz)	Pol/Phase	: HORIZONTAL
Test Mode	: Mode 1, CH39		:

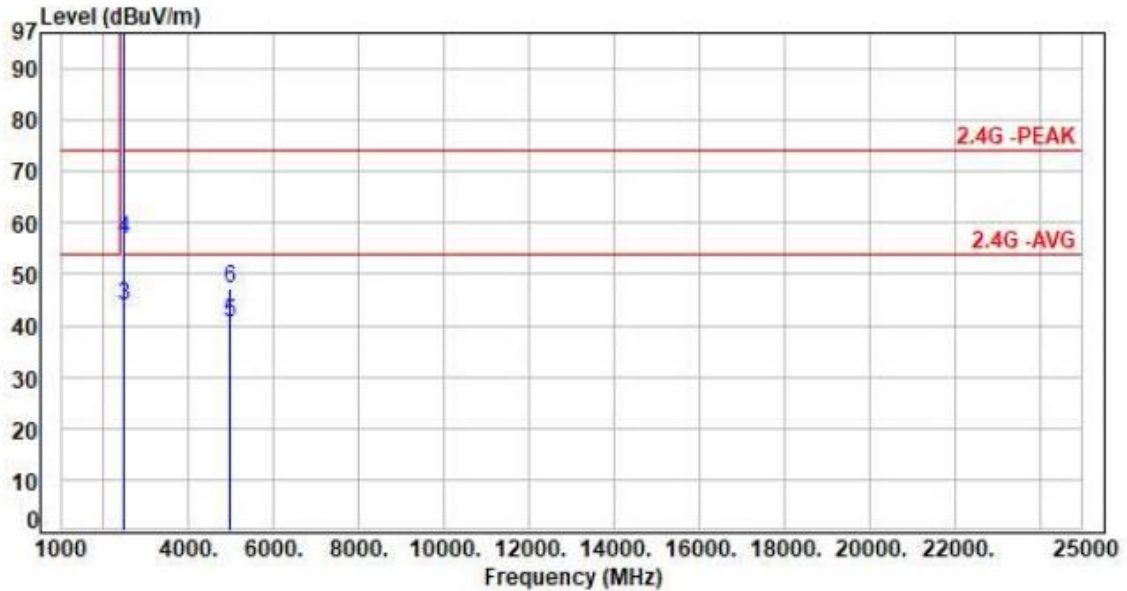

No.	Frequency (MHz)	Factor (dB)	Reading (dBuV)	Level (dBuV/m)	Limit (dBuV/m)	Margin (dB)	Detector	Height (cm)	Azimuth (deg)	P/F
1	2480.00	-15.37	112.59	97.22	200.00	-102.78	Average	155	193	P
2	2480.00	-15.37	114.67	99.30	200.00	-100.70	Peak	155	193	P
3	2483.50	-15.35	59.11	43.76	54.00	-10.24	Average	155	193	P
4	2483.50	-15.35	72.11	56.76	74.00	-17.24	Peak	155	193	P
5	4960.00	-6.53	47.24	40.71	54.00	-13.29	Average	234	219	P
6	4960.00	-6.53	53.85	47.32	74.00	-26.68	Peak	234	219	P

Note: Level=Reading+Factor
 Margin=Level-Limit
 Factor=Antenna Factor + cable loss - Amplifier Factor



Power	: DC 5V From Adapter (AC 120V / 60Hz)	Pol/Phase	: VERTICAL
Test Mode	: Mode 2, CH00		:

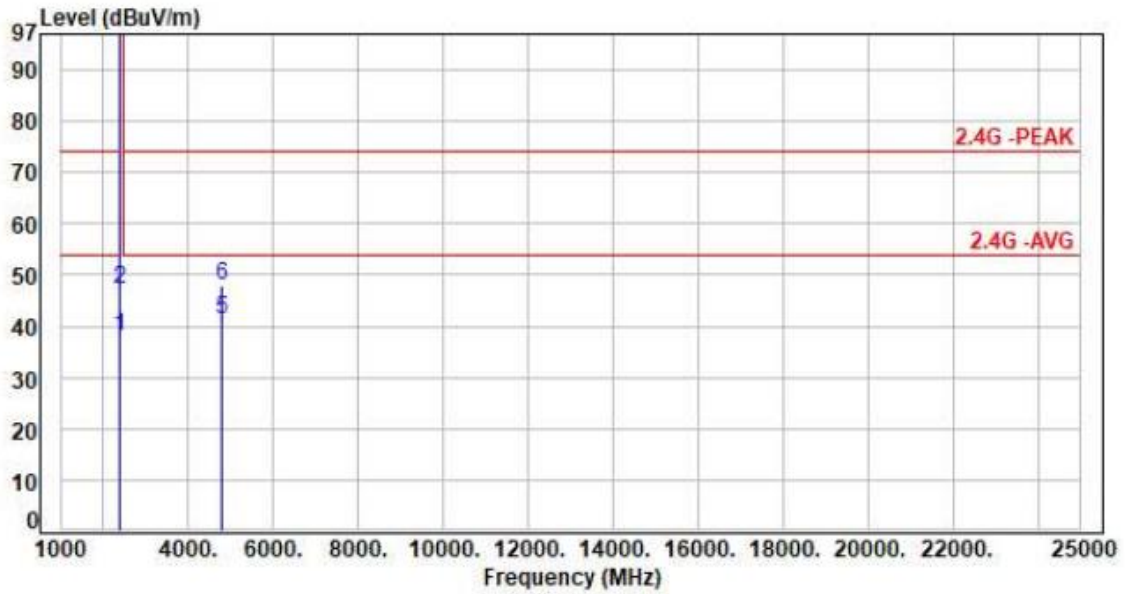

No.	Frequency (MHz)	Factor (dB)	Reading (dBuV)	Level (dBuV/m)	Limit (dBuV/m)	Margin (dB)	Detector	Height (cm)	Azimuth (deg)	P/F
1	2390.00	-15.29	53.33	38.04	54.00	-15.96	Average	123	221	P
2	2390.00	-15.29	62.45	47.16	74.00	-26.84	Peak	123	221	P
3	2402.00	-15.33	114.12	98.79	200.00	-101.21	Average	123	221	P
4	2402.00	-15.33	118.91	103.58	200.00	-96.42	Peak	123	221	P
5	4804.00	-7.22	48.64	41.42	54.00	-12.58	Average	111	257	P
6	4804.00	-7.22	55.23	48.01	74.00	-25.99	Peak	111	257	P

Note: Level=Reading+Factor
 Margin=Level-Limit
 Factor=Antenna Factor + cable loss - Amplifier Factor



Power	: DC 5V From Adapter (AC 120V / 60Hz)	Pol/Phase	: HORIZONTAL
Test Mode	: Mode 2, CH00		:

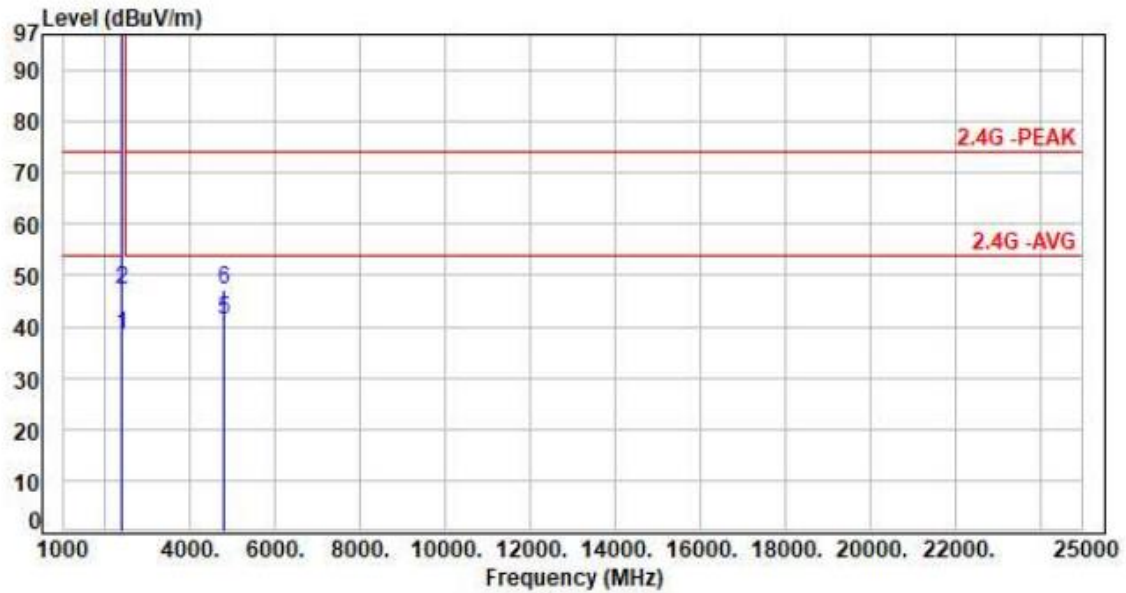

No.	Frequency (MHz)	Factor (dB)	Reading (dBuV)	Level (dBuV/m)	Limit (dBuV/m)	Margin (dB)	Detector	Height (cm)	Azimuth (deg)	P/F
1	2390.00	-15.29	53.49	38.20	54.00	-15.80	Average	281	164	P
2	2390.00	-15.29	62.52	47.23	74.00	-26.77	Peak	281	164	P
3	2402.00	-15.33	114.55	99.22	200.00	-100.78	Average	281	164	P
4	2402.00	-15.33	118.66	103.33	200.00	-96.67	Peak	281	164	P
5	4804.00	-7.22	48.41	41.19	54.00	-12.81	Average	100	229	P
6	4804.00	-7.22	54.58	47.36	74.00	-26.64	Peak	100	229	P

Note: Level=Reading+Factor
 Margin=Level-Limit
 Factor=Antenna Factor + cable loss - Amplifier Factor



Power	: DC 5V From Adapter (AC 120V / 60Hz)	Pol/Phase	: VERTICAL
Test Mode	: Mode 2, CH19		:

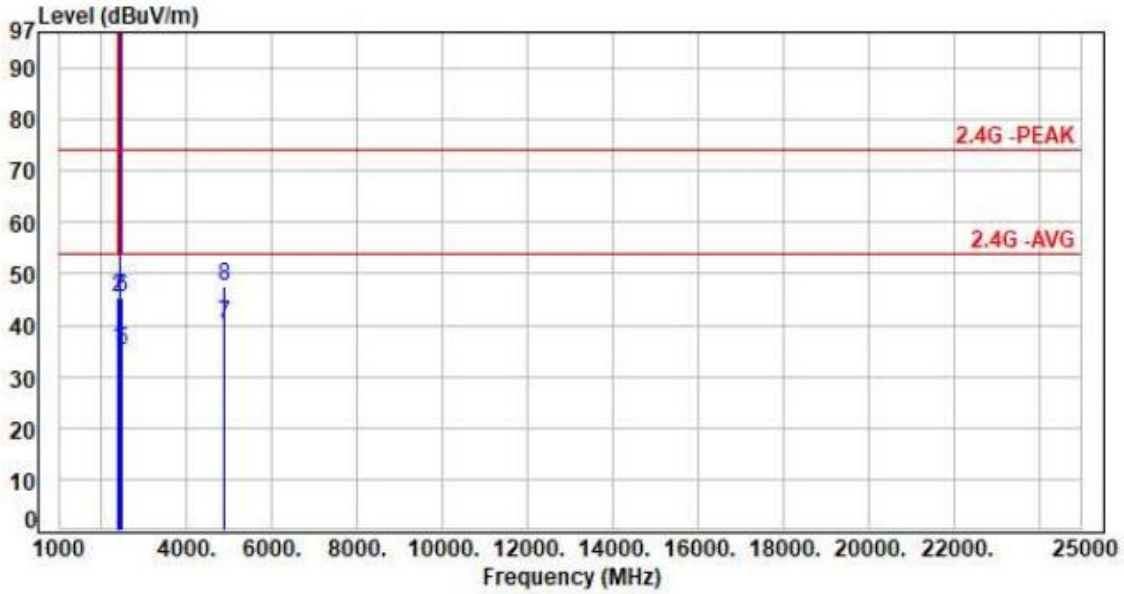

No.	Frequency (MHz)	Factor (dB)	Reading (dBuV)	Level (dBuV/m)	Limit (dBuV/m)	Margin (dB)	Detector	Height (cm)	Azimuth (deg)	P/F
1	2390.00	-15.29	50.77	35.48	54.00	-18.52	Average	241	200	P
2	2390.00	-15.29	60.81	45.52	74.00	-28.48	Peak	241	200	P
3	2440.00	-15.43	115.41	99.98	200.00	-100.02	Average	241	200	P
4	2440.00	-15.43	118.74	103.31	200.00	-96.69	Peak	241	200	P
5	2483.50	-15.35	50.45	35.10	54.00	-18.90	Average	241	200	P
6	2483.50	-15.35	60.77	45.42	74.00	-28.58	Peak	241	200	P
7	4880.00	-7.01	47.11	40.10	54.00	-13.90	Average	141	219	P
8	4880.00	-7.01	54.42	47.41	74.00	-26.59	Peak	141	219	P

Note: Level=Reading+Factor
 Margin=Level-Limit
 Factor=Antenna Factor + cable loss - Amplifier Factor



Power	: DC 5V From Adapter (AC 120V / 60Hz)	Pol/Phase	: HORIZONTAL
Test Mode	: Mode 2, CH19		:

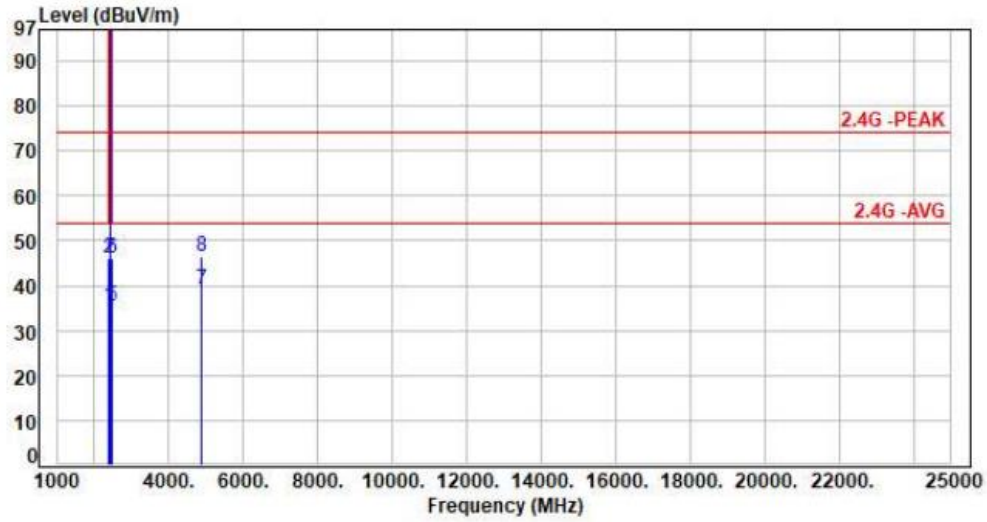

No.	Frequency (MHz)	Factor (dB)	Reading (dBuV)	Level (dBuV/m)	Limit (dBuV/m)	Margin (dB)	Detector	Height (cm)	Azimuth (deg)	P/F
1	2390.00	-15.29	50.55	35.26	54.00	-18.74	Average	132	154	P
2	2390.00	-15.29	61.45	46.16	74.00	-27.84	Peak	132	154	P
3	2440.00	-15.43	113.74	98.31	200.00	-101.69	Average	132	154	P
4	2440.00	-15.43	117.10	101.67	200.00	-98.33	Peak	132	154	P
5	2483.50	-15.35	50.68	35.33	54.00	-18.67	Average	132	154	P
6	2483.50	-15.35	61.43	46.08	74.00	-27.92	Peak	132	154	P
7	4880.00	-7.01	46.25	39.24	54.00	-14.76	Average	219	46	P
8	4880.00	-7.01	53.34	46.33	74.00	-27.67	Peak	219	46	P

Note: Level=Reading+Factor
 Margin=Level-Limit
 Factor=Antenna Factor + cable loss - Amplifier Factor



Power	: DC 5V From Adapter (AC 120V / 60Hz)	Pol/Phase	: VERTICAL
Test Mode	: Mode 2, CH39		:

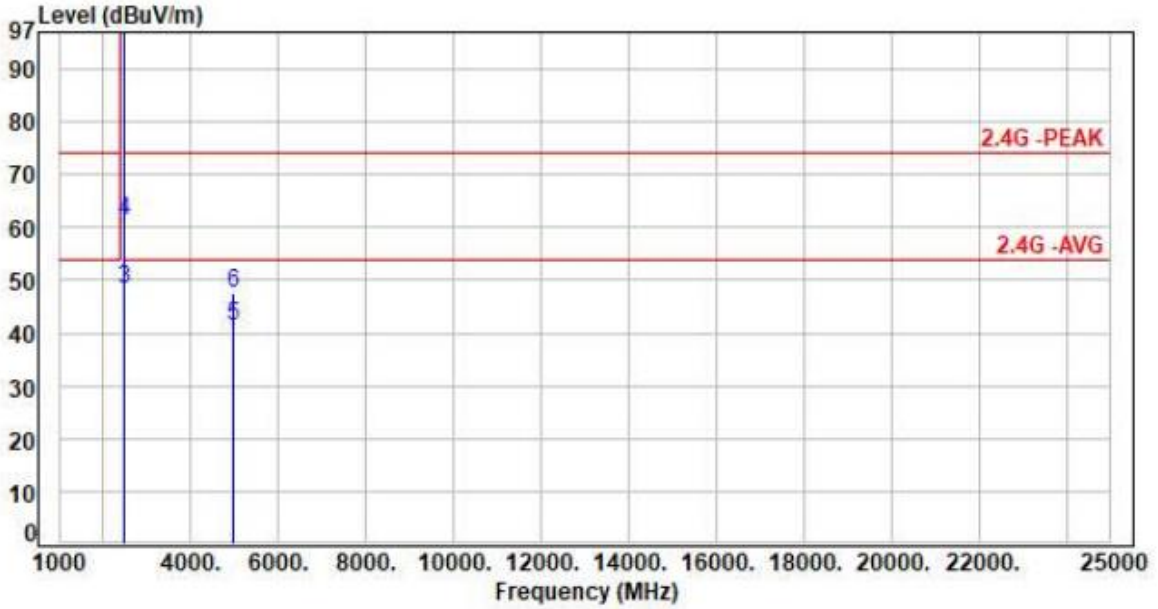

No.	Frequency (MHz)	Factor (dB)	Reading (dBuV)	Level (dBuV/m)	Limit (dBuV/m)	Margin (dB)	Detector	Height (cm)	Azimuth (deg)	P/F
1	2480.00	-15.37	114.46	99.09	200.00	-100.91	Average	253	224	P
2	2480.00	-15.37	118.65	103.28	200.00	-96.72	Peak	253	224	P
3	2483.50	-15.35	63.51	48.16	54.00	-5.84	Average	253	224	P
4	2483.50	-15.35	76.51	61.16	74.00	-12.84	Peak	253	224	P
5	4960.00	-6.53	47.77	41.24	54.00	-12.76	Average	343	233	P
6	4960.00	-6.53	54.23	47.70	74.00	-26.30	Peak	343	223	P

Note: Level=Reading+Factor
 Margin=Level-Limit
 Factor=Antenna Factor + cable loss - Amplifier Factor



Power	: DC 5V From Adapter (AC 120V / 60Hz)	Pol/Phase	: HORIZONTAL
Test Mode	: Mode 2, CH39		:

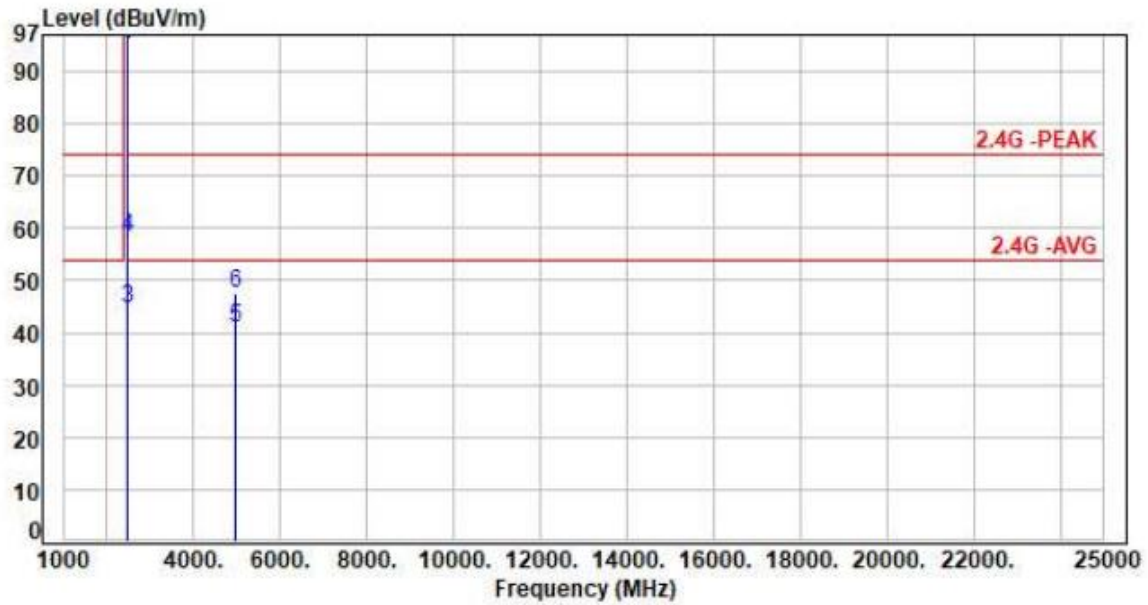

No.	Frequency (MHz)	Factor (dB)	Reading (dBuV)	Level (dBuV/m)	Limit (dBuV/m)	Margin (dB)	Detector	Height (cm)	Azimuth (deg)	P/F
1	2480.00	-15.37	110.58	95.21	200.00	-104.79	Average	151	205	P
2	2480.00	-15.37	114.46	99.09	200.00	-100.91	Peak	151	205	P
3	2483.50	-15.35	60.11	44.76	54.00	-9.24	Average	151	205	P
4	2483.50	-15.35	73.51	58.16	74.00	-15.84	Peak	151	205	P
5	4960.00	-6.53	47.42	40.89	54.00	-13.11	Average	277	242	P
6	4960.00	-6.53	53.95	47.42	74.00	-26.58	Peak	277	242	P

Note: Level=Reading+Factor
 Margin=Level-Limit
 Factor=Antenna Factor + cable loss - Amplifier Factor



6.7 Restricted Bands of Operation

Only spurious emissions are permitted in any of the frequency bands listed below:

MHz	MHz	MHz	GHz
0.09000 – 0.11000	16.42000 – 16.42300	399.9 – 410.0	4.500 – 5.250
0.49500 – 0.505**	16.69475 – 16.69525	608.0 – 614.0	5.350 – 5.460
2.17350 – 2.19050	16.80425 – 16.80475	960.0 – 1240.0	7.250 – 7.750
4.12500 – 4.12800	25.50000 – 25.67000	1300.0 – 1427.0	8.025 – 8.500
4.17725 – 4.17775	37.50000 – 38.25000	1435.0 – 1626.5	9.000 – 9.200
4.20725 – 4.20775	73.00000 – 74.60000	1645.5 – 1646.5	9.300 – 9.500
6.21500 – 6.21800	74.80000 – 75.20000	1660.0 – 1710.0	10.600 – 12.700
6.26775 – 6.26825	108.00000 – 121.94000	1718.8 – 1722.2	13.250 – 13.400
6.31175 – 6.31225	123.00000 – 138.00000	2200.0 – 2300.0	14.470 – 14.500
8.29100 – 8.29400	149.90000 – 150.05000	2310.0 – 2390.0	15.350 – 16.200
8.36200 – 8.36600	156.52475 – 156.52525	2483.5 – 2500.0	17.700 – 21.400
8.37625 – 8.38675	156.70000 – 156.90000	2655.0 – 2900.0	22.010 – 23.120
8.41425 – 8.41475	162.01250 – 167.17000	3260.0 – 3267.0	23.600 – 24.000
12.29000 – 12.29300	167.72000 – 173.20000	3332.0 – 3339.0	31.200 – 31.800
12.51975 – 12.52025	240.00000 – 285.00000	3345.8 – 3358.0	36.430 – 36.500
12.57675 – 12.57725	322.00000 – 335.40000	3600.0 – 4400.0	Above 38.6
13.36000 – 13.41000			

** : Until February 1, 1999, this restricted band shall be 0.490-0.510 MHz



7. Test of Conducted Spurious Emission

7.1 Test Limit

According to the methods defined in ANSI C63.10-2013 Section 11.11.1

Below -30dB of the highest emission level of operating band (In 100 kHz Resolution Bandwidth)

7.2 Test Procedure

According to the methods defined in ANSI C63.10-2013 Section 11.11.2 & 11.11.3

- a. The transmitter output was connected to the spectrum analyzer via a low loss cable.
- b. Set RBW of spectrum analyzer to 100 KHz and VBW of spectrum analyzer to 300 KHz with convenient frequency span including 100 KHz bandwidth from band edge.
- c. Peak conducted output power measured within any 100 kHz outside the authorized frequency band shall be attenuated by at least 30dB relative to the maximum measured in-band peak PSD level.
- d. The band edges was measured and recorded.

7.3 Test Setup Layout

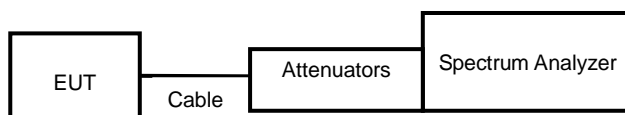

7.4 Test Result and Data

Note: Test plots refers to the following pages.



Modulation Type: GFSK(1Mbps)
CH00

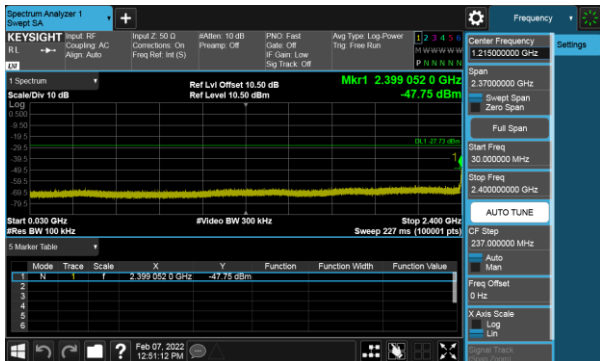

Modulation Type: GFSK(1Mbps)
CH19

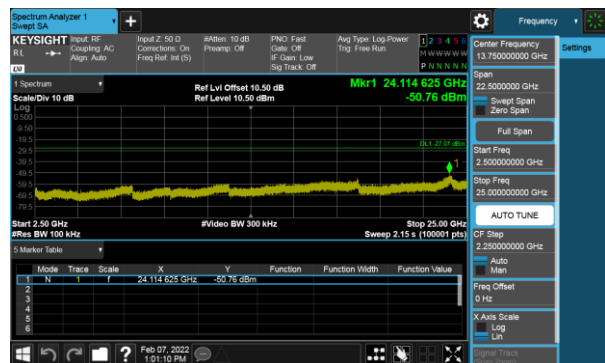
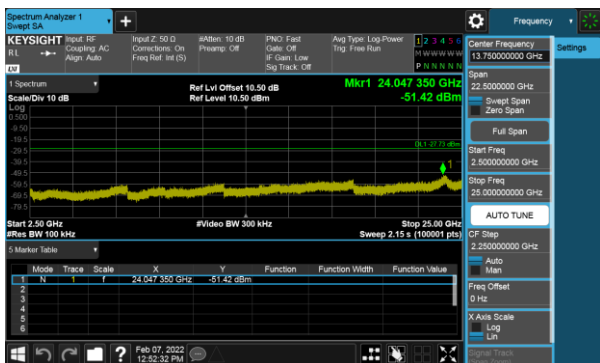
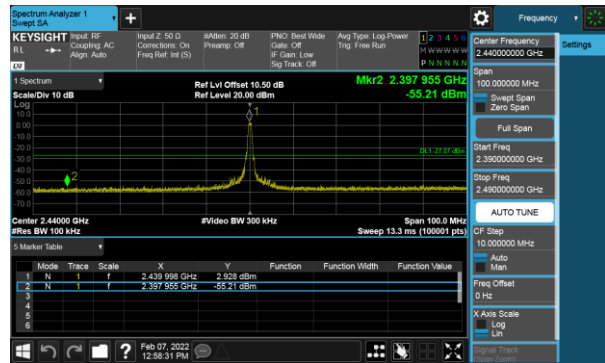
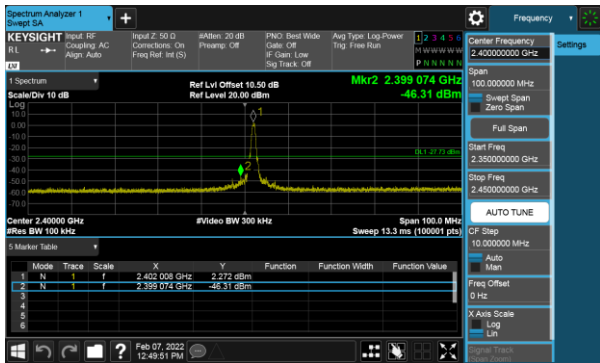
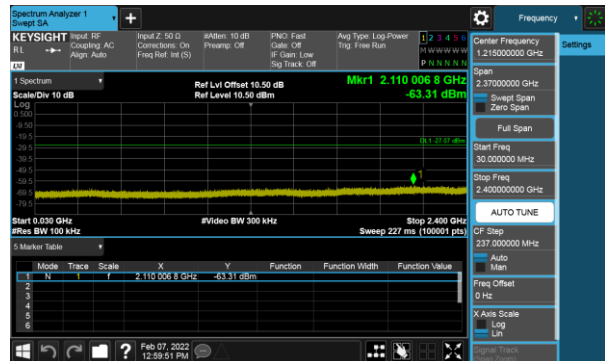



Modulation Type: GFSK(1Mbps)
CH39

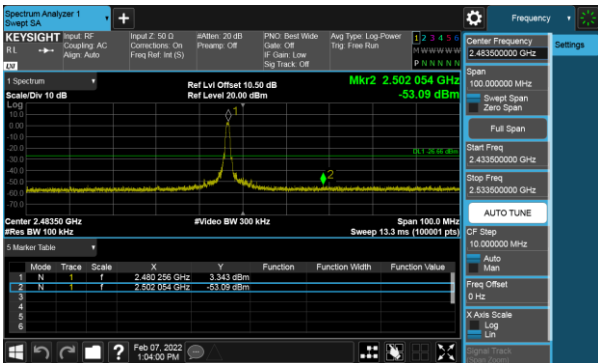



Modulation Type: GFSK(2Mbps)
CH00

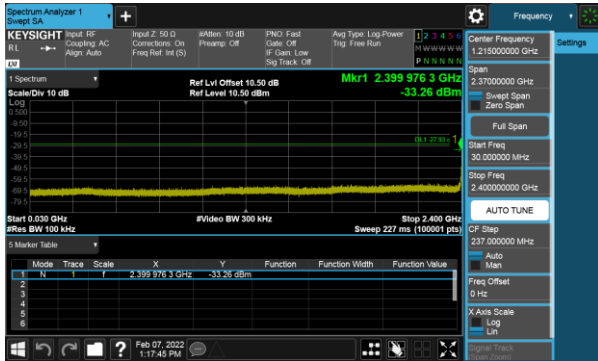

Modulation Type: GFSK(2Mbps)
CH19

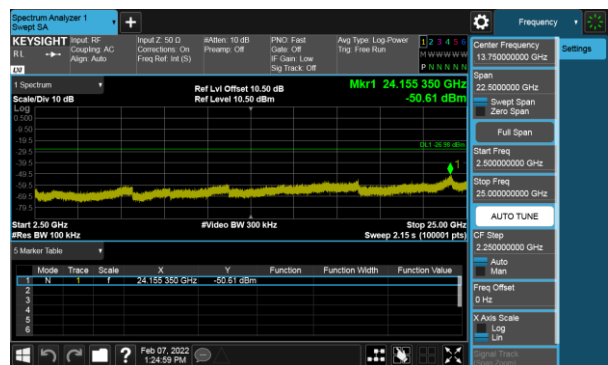
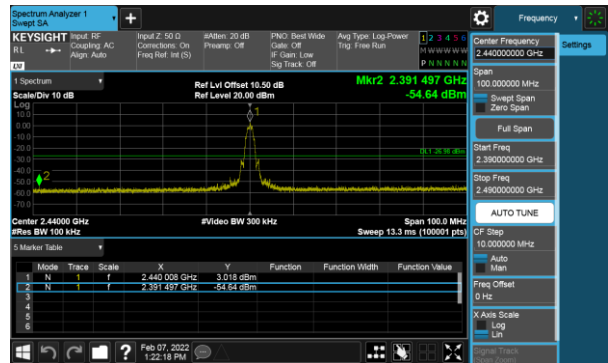
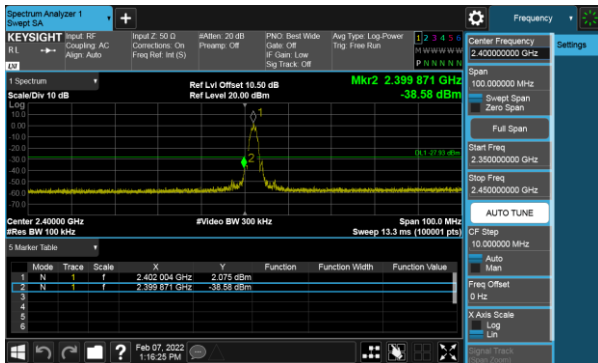
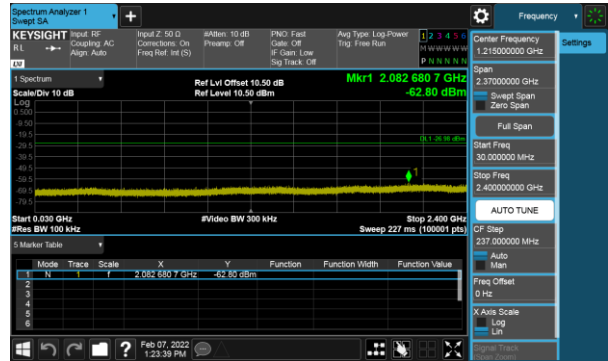



Modulation Type: GFSK(2Mbps)
CH39

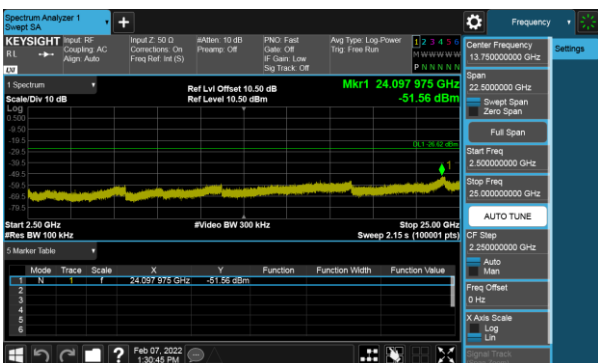
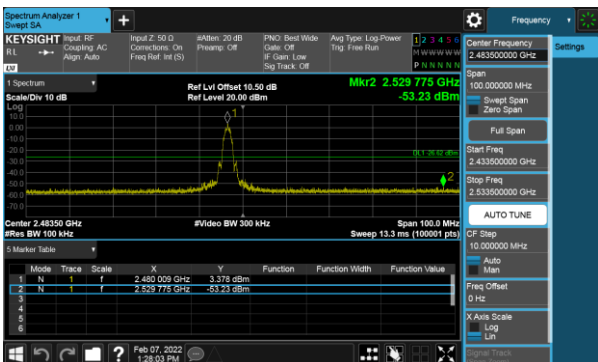
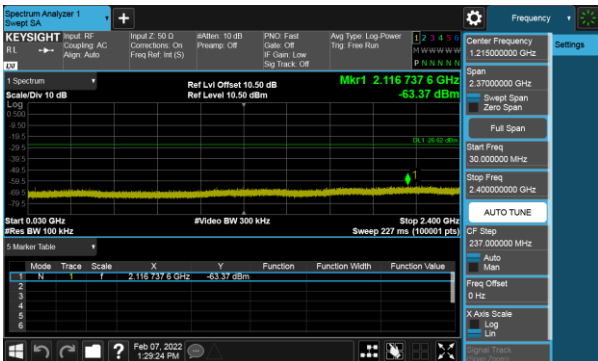



8. On Time, Duty Cycle and Measurement methods

8.1 Test Limit

None; for reporting purposes only.

8.2 Test Procedure

According to the methods defined in ANSI C63.10-2013 Section 11.6
Zero-Span Spectrum Analyzer Method.

8.3 Test Setup Layout

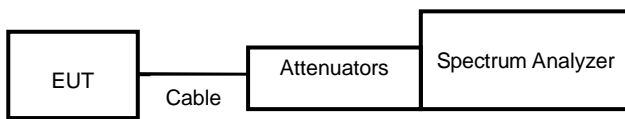

8.4 Test Result and Data

Modulation Type	On Time (ms)	Period Time (ms)	Duty Cycle (%)
GFSK(1Mbps)	0.40	0.63	64.63%
GFSK(2Mbps)	0.22	0.62	34.51%



Modulation Type: GFSK(1Mbps)

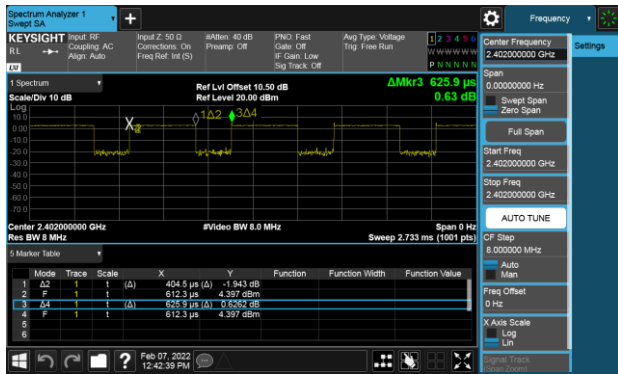

Modulation Type: GFSK(2Mbps)

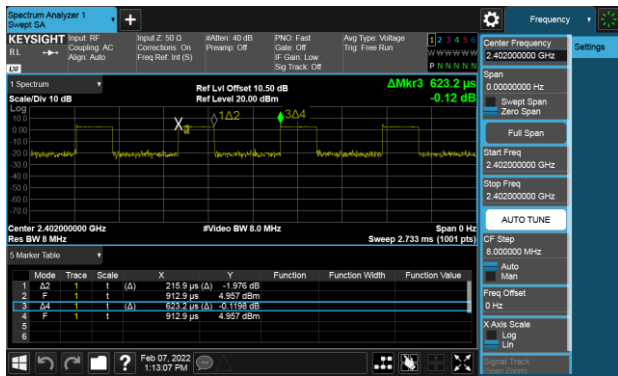



9. 6dB Bandwidth Measurement Data

9.1 Test Limit

The minimum of 6dB Bandwidth Measurement is 0.5 MHz.

9.2 Test Procedures

According to the methods defined in ANSI C63.10-2013 Section 11.8

- a. The transmitter output was connected to the spectrum analyzer.
- b. Set RBW of spectrum analyzer to 100 KHz and VBW to 300 KHz.
- c. The 6 dB bandwidth is defined as the total spectrum the power of which is higher than peak power minus 6 dB.
- d. The 6dB Bandwidth was measured and recorded.

9.3 Test Setup Layout

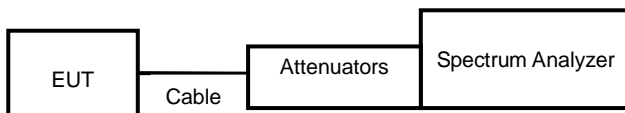

9.4 Test Result and Data

Modulation Type	Channel	Frequency (MHz)	6dB Bandwidth (KHz)	Limit (KHz)
GFSK(1Mbps)	0	2402	702.00	500
	19	2440	699.00	500
	39	2480	696.00	500

Modulation Type	Channel	Frequency (MHz)	6dB Bandwidth (KHz)	Limit (KHz)
GFSK(2Mbps)	0	2402	1170.00	500
	19	2440	1164.00	500
	39	2480	1167.00	500



6dB Bandwidth
Modulation Type: GFSK(1Mbps)
CH00

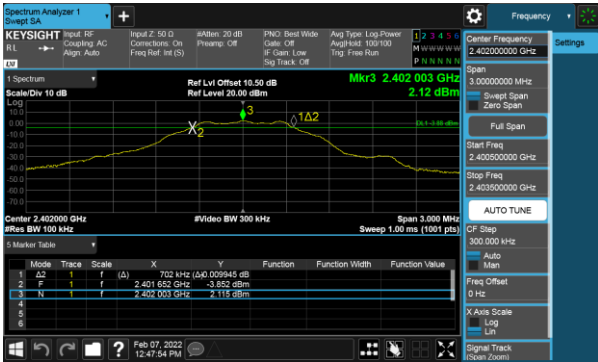

Modulation Type: GFSK(2Mbps)
CH00

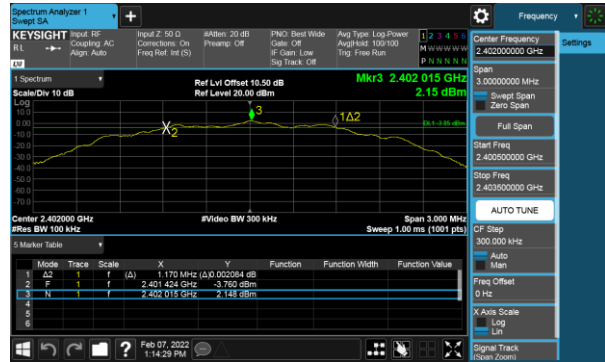

Modulation Type: GFSK(1Mbps)
CH19

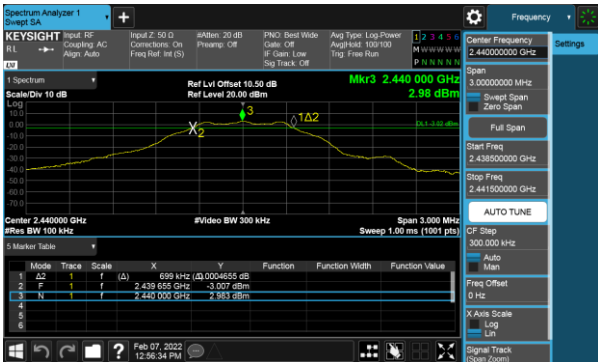

Modulation Type: GFSK(2Mbps)
CH19



Modulation Type: GFSK(1Mbps)
CH39

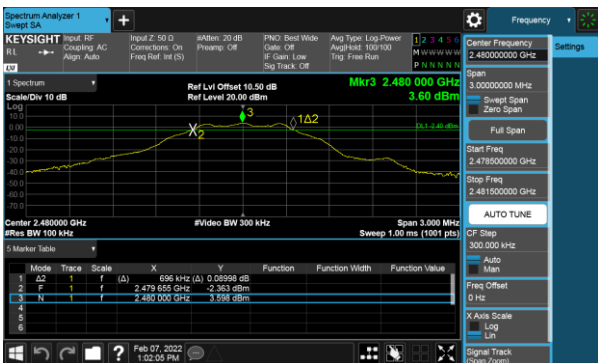

Modulation Type: GFSK(2Mbps)
CH39

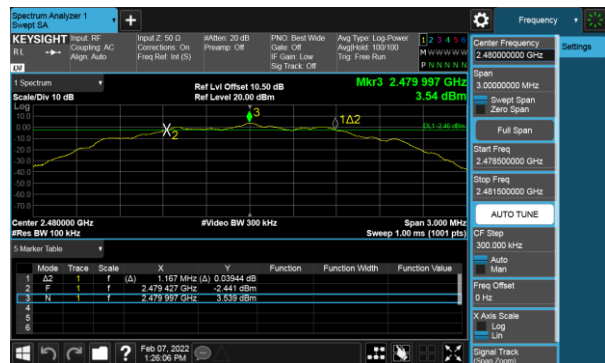



10. Maximum Average Output Power

10.1 Test Limit

The Maximum Average Output Power Measurement is 30dBm.

If transmitting antennas of directional gain greater than 6 dBi are used, the average output power shall be reduced by the amount in dB that the directional gain of the antenna exceeds 6 dBi

10.2 Test Procedures

According to the methods defined in ANSI C63.10-2013 Section 11.9.2.3.2

The antenna port (RF output) of the EUT was connected to the input (RF input) of a power meter. Power was read directly from the meter and cable loss connection was added to the reading to obtain power at the EUT antenna terminal. The EUT Output Power was set to maximum to produce the worse case test result.

10.3 Test Setup Layout

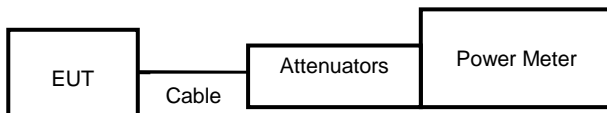

10.4 Test Result and Data

(1M bps)

Power Set	Modulation Type	Channel	Frequency (MHz)	Power Output (dBm)	Power Output (mW)
				Average	Average
-8	GFSK	0	2402	1.76	1.500
-8		19	2440	2.65	1.841
-8		39	2480	3.27	2.123

(2M bps)

Power Set	Modulation Type	Channel	Frequency (MHz)	Power Output (dBm)	Power Output (mW)
				Average	Average
-8	GFSK	0	2402	1.82	1.521
-8		19	2440	2.73	1.875
-8		39	2480	3.32	2.148



11. Power Spectral Density

11.1 Test Limit

The Maximum of Power Spectral Density Measurement is 8dBm.

If transmitting antennas of directional gain greater than 6 dBi are used, the power spectral density shall be reduced by the amount in dB that the directional gain of the antenna exceeds 6 dBi

11.2 Test Procedures

According to the methods defined in ANSI C63.10-2013 Section 11.10

11.3 Test Setup Layout

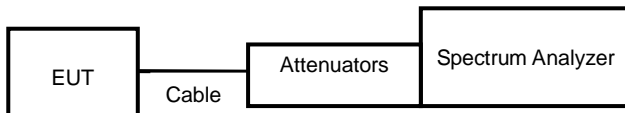

11.4 Test Result and Data

Modulation Type	Channel	Frequency (MHz)	Maximum Power Density of 10KHz Bandwidth(dBm)	Limit
GFSK(1Mbps)	0	2402	-13.097	8.00
	19	2440	-12.18	8.00
	39	2480	-11.469	8.00

Modulation Type	Channel	Frequency (MHz)	Maximum Power Density of 10KHz Bandwidth(dBm)	Limit
GFSK(2Mbps)	0	2402	-15.58	8.00
	19	2440	-14.457	8.00
	39	2480	-13.88	8.00



Modulation Type: GFSK(1Mbps)
CH00



Modulation Type: GFSK(2Mbps)
CH00



Modulation Type: GFSK(1Mbps)
CH19



Modulation Type: GFSK(2Mbps)
CH19



Modulation Type: GFSK(1Mbps)
CH39



Modulation Type: GFSK(2Mbps)
CH39

