



FCC RADIO TEST REPORT

Applicant : SteelSeries ApS.
Address : Dirch Passers Allé 27, 5. Sal 2000 Frederiksberg
Denmark.
Equipment : HEADSET
Model No. : HS-00019
Trade Name : 
FCC ID. : ZHK-HS00019

I HEREBY CERTIFY THAT :

The sample was received on Aug. 30, 2018 and the testing was carried out on Jan. 10, 2019 at CerpPASS Technology Corp. The test result refers exclusively to the test presented test model / sample. Without written approval of CerpPASS Technology Corp., the test report shall not be reproduced except in full.

Approved by:

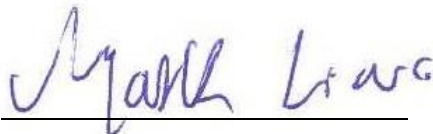

Mark Liao / Supervisor

Tested by:



Spree Yeh / Engineer

Laboratory Accreditation:

CerpPASS Technology Corporation Test Laboratory





Contents

- 1. **Summary of Test Procedure and Test Results**..... 5
 - 1.1 Applicable Standards 5
- 2. **Test Configuration of Equipment under Test** 6
 - 2.1 Feature of Equipment..... 6
 - 2.2 Carrier Frequency of Channels 6
 - 2.3 Test Mode and Test Software 7
 - 2.4 Description of Test System..... 7
 - 2.5 General Information of Test..... 8
 - 2.6 Measurement Uncertainty 8
- 3. **Test Equipment and Ancillaries Used for Tests** 9
- 4. **Antenna Requirements** 10
 - 4.1 Antenna Construction and Directional Gain 10
- 5. **Test of AC Power Line Conducted Emission** 11
 - 5.1 Test Limit 11
 - 5.2 Test Procedures 11
 - 5.3 Typical Test Setup 12
 - 5.4 Test Result and Data 13
 - 5.5 Test Photographs 15
- 6. **Test of Radiated Spurious Emission**..... 16
 - 6.1 Test Limit 16
 - 6.2 Test Procedures 16
 - 6.3 Typical Test Setup 17
 - 6.4 Test Result and Data (9KHz ~ 30MHz) 18
 - 6.5 Test Result and Data (30MHz ~ 1GHz)..... 18
 - 6.6 Test Result and Data (1GHz ~ 25GHz) 20
 - 6.7 Restricted Bands of Operation 30
 - 6.8 Test Photographs (30MHz ~ 1GHz) 31
 - 6.9 Test Photographs (1GHz ~ 25GHz) 32
- 7. **Test of Conducted Spurious Emission** 33
 - 7.1 Test Limit 33
 - 7.2 Test Procedure 33
 - 7.3 Test Setup Layout 33
 - 7.4 Test Result and Data 33
- 8. **On Time, Duty Cycle and Measurement methods** 38
 - 8.1 Test Limit 38
 - 8.2 Test Procedure 38
 - 8.3 Test Setup Layout 38
 - 8.4 Test Result and Data 38
- 9. **6dB Bandwidth Measurement Data** 40
 - 9.1 Test Limit 40
 - 9.2 Test Procedures 40
 - 9.3 Test Setup Layout 40



9.4 Test Result and Data 40

10. Maximum Average Output Power 42

10.1 Test Limit 42

10.2 Test Procedures 42

10.3 Test Setup Layout 42

10.4 Test Result and Data 42

11. Power Spectral Density 43

11.1 Test Limit 43

11.2 Test Procedures 43

11.3 Test Setup Layout 43

11.4 Test Result and Data 43

12. Radio Frequency Exposure 45

12.1 Applicable Standards 45

12.2 EUT Specification 45

12.3 Test Results 46



1. Summary of Test Procedure and Test Results

1.1 Applicable Standards

ANSI C63.4:2014

ANSI C63.10:2013

FCC Rules and Regulations Part 15 Subpart C §15.247

KDB558074

KDB662911

KDB447498

FCC Rule	Description of Test	Result
15.203	. Antenna Requirement	PASS
15.207	. AC Power Line Conducted Emission	PASS
15.209 15.205	. Radiated Spurious Emission	PASS
15.247(d)	. Conducted Spurious Emission	PASS
15.247(a)(2)	. 6dB Bandwidth	PASS
15.247(b)	. Maximum Peak and Average Output Power	PASS
15.247(e)	. Power Spectral Density	PASS
2.1091	. Radio Frequency Exposure	PASS



2. Test Configuration of Equipment under Test

2.1 Feature of Equipment

Frequency Range	BT / BLE: 2400-2483.5MHz 802.11g/n: 2400-2483.5MHz 802.11a/n: 5150-5250MHz, 5250-5350MHz, 5470-5725MHz, 5725-5850MHz
Modulation Type	BT: GFSK, $\pi/4$ -DQPSK, 8DPSK BLE: GFSK 802.11g/n/a: BPSK, QPSK, 16QAM, 64QAM
Modulation Technology	FHSS, DTS, DSSS, OFDM
Data Rate	BT: GFSK: 1Mbps, $\pi/4$ -DQPSK: 2Mbps, 8DPSK: 3Mbps BLE: GFSK: 1Mbps WLAN: 802.11g: 6, 9, 12, 18, 24, 36, 48, 54Mbps 802.11n: MCS0 – MCS7, HT20 802.11a: 6, 9, 12, 18, 24, 36, 48, 54Mbps
Antenna Type	PCB Antenna
Antenna Gain	BT/BLE: 2400-2483.5MHz: 3.92dBi 2.4G: 2400-2483.5MHz: 1.85dBi 5150-5250MHz: 3.60dBi 5250-5350MHz: 3.79dBi 5470-5725MHz: 3.62dBi 5725-5850MHz: -0.23dBi

Note:

1. For a more detailed features description, please refer to the manufacturer's specifications or the User's Manual.

2.2 Carrier Frequency of Channels

802.11g, 802.11n HT20 (2412MHz~2462MHz)

Channel	Frequency(MHz)	Channel	Frequency(MHz)
*01	2412	07	2442
02	2417	08	2447
03	2422	09	2452
04	2427	10	2457
05	2432	*11	2462
*06	2437	---	---

Note: Channels remarked * are selected to perform test.



2.3 Test Mode and Test Software

- a. During testing, the interface cables and equipment positions were varied according to ANSI C63.10.
- b. The complete test system included Notebook, AP and EUT for RF test.
- c. An executive program, "ART2: Kingfisher.2889.20130529" was executed to transmit and receive data via WLAN.
- d. The following test modes were performed for the test:

Conducted Emissions from the AC mains power ports	
Test Mode	Operating Description
1	802.11g (6Mbps)
2	802.11n HT20 (6.5Mbps)
caused "Test Mode 2" generated the worst case, it was reported as the final data.	
Radiation Emissions (30MHz ~ 1GHz)	
Test Mode	Operating Description
1	802.11g (6Mbps)
2	802.11n HT20 (6.5Mbps)
caused "Test Mode 2" generated the worst case, it was reported as the final data.	
Radiation Emissions (1GHz ~ 25GHz)	
Test Mode	Operating Description
1	802.11g (6Mbps)
2	802.11n HT20 (6.5Mbps)
caused "Test Mode 1 & 2" generated the worst case, they were reported as the final data.	

2.4 Description of Test System

Device	Manufacturer	Model No.	Description
NB	DELL	LatitudeE5450/5450, TX	Power Cable, Unshielding, 1.8m
AP	NETGEAR	R7800	Power Cable, Unshielding, 1.5m
Network cable	N/A	N/A	N/A



2.5 General Information of Test

Test Site	CerpPASS Technology Corporation Test Laboratory Address: No.10, Ln. 2, Lianfu St., Luzhu Dist., Taoyuan City 33848, Taiwan (R.O.C.) Tel:+886-3-3226-888 Fax:+886-3-3226-881 Address: No.68-1, Shihbachongsi, Shihding Township, New Taipei City 223, Taiwan, R.O.C. Tel: +886-2-2663-8582	
	FCC	TW1079, TW1061, TW1439
	IC	4934E-1, 4934E-2
	VCCI	T-2205 for Telecommunication test C-4663 for Conducted emission test R-4399, R-4218 for Radiated emission test G-10812, G-10813 for radiated disturbance above 1GHz
Frequency Range Investigated:	Conducted: from 150kHz to 30 MHz Radiation: from 30 MHz to 25,000MHz	
Test Distance:	The test distance of radiated emission from antenna to EUT is 3 M.	

2.6 Measurement Uncertainty

Measurement Item	Uncertainty
Radiated Spurious Emission(9KHz~30MHz)	±5.007dB
Radiated Spurious Emission(30MHz~1GHz)	±5.157dB
Radiated Spurious Emission(1GHz~18GHz)	±6.383dB
Radiated Spurious Emission(18GHz~40GHz)	±6.648dB
Conducted Spurious Emission	±1.253dB
6dB Bandwidth	±6.89%
Power Spectral Density	±0.630dB
26 dB Occupied Bandwidth	±6.10%
Frequency Stability	±375KHz
Channel Frequencies Separation	±6.10%
20dB Bandwidth	±6.12%
Dwell Time	±1.34%
Peak Output Power(Conducted Power Meter)	±0.86dB
Temperature	±1.2°C
Humidity	±2.7%
Channel Move Time	±4.53%
Channel Closing Transmission Time	±6.61%
Threshold	±0.631dB
Non occupancy period	±1.17%



3. Test Equipment and Ancillaries Used for Tests

Instrument	Manufacturer	Model No.	Serial No.	Calibration Date	Valid Date
Bilog Antenna	Schwarzbeck	VULB9168	275	2018/09/17	2019/09/16
Active Loop Antenna	EMCO	6507	40855	2018/05/22	2019/05/21
Horn Antenna	EMCO	3115	31589	2018/04/02	2019/04/01
Horn Antenna	EMCO	3116	31974	2018/09/07	2019/09/06
EMI Receiver	ROHDE & SCHWARZ	ESCI 3	101402	2018/02/23	2019/02/22
Spectrum Analyzer	ROHDE & SCHWARZ	FSP40	100047	2018/03/20	2019/03/19
Preamplifier	EM Electronics corp.	EM330	60660	2018/03/08	2019/03/07
Preamplifier	EMC INSTRUMENTS	EMC051845SE	980333	2018/09/18	2019/09/17
BLUETOOTH TESTER	ROHDE & SCHWARZ	CBT	101133	2018/04/02	2019/04/01
Cable-3in1-(30M-1G)	HARBOUR INDUSTRIES	LL142	CCE1315	2018/04/20	2019/04/19
Cable-0.5m-(1G-40G)	Rapidtek	40GHZ 50CM	38MS-38MS50314	2018/03/27	2019/03/26
Cable-1m-(1G-40G)	Rapidtek	40GHZ 300CM	38MS-38MS300314	2018/03/27	2019/03/26
Cable-6m-(1G-40G)	Rapidtek	40GHZ 800CM	38MS-38MS800314	2018/03/27	2019/03/26
E3	AUDIX	v8.2014-8-6	RK-000529	NA	NA
Spectrum Analyzer	ROHDE & SCHWARZ	FSP40	100219	2018/07/03	2019/07/02
BLUETOOTH TESTER	ROHDE & SCHWARZ	CBT	101133	2018/04/02	2019/04/01
Attenuator	KEYSIGHT	8491B	MY39250705	2018/09/04	2019/09/03
TEMP & HUMIDITY CHAMBER	T-MACHINE	TMJ-9712	T-12-040111	2018/08/30	2019/08/29
Power Sensor	Anritsu	MA2411B	1207295	2018/03/23	2019/03/22
EMI Receiver	ROHDE & SCHWARZ	ESCI 3	100443	2018/3/15	2019/3/14
Line Impedance Stabilization Network	Schwarzbeck	NSLK 8127	8127-740	2018/6/13	2019/6/12
Pulse Limiter	ROHDE & SCHWARZ	ESH3-Z2	101933	2018/9/4	2019/9/3
E3	AUDIX	v8.2014-8-6	RK-000531	NA	NA



4. Antenna Requirements

4.1 Antenna Construction and Directional Gain

Antenna Type	PCB Antenna
Antenna Gain	2400-2483.5MHz: 1.85dBi 5150-5250MHz: 3.60dBi 5250-5350MHz: 3.79dBi 5470-5725MHz: 3.62dBi 5725-5850MHz: -0.23dBi

2412-2462MHz

For Power directional gain= G_{ant} = 1.85 dBi

For PSD directional gain = G_{ant} = 1.85 dBi

5150MHz-5250MHz

For Power directional gain= G_{ant} = 3.6 dBi

For PSD directional gain = G_{ant} = 3.6 dBi

5250MHz-5350MHz

For Power directional gain= G_{ant} = 3.79 dBi

For PSD directional gain = G_{ant} = 3.79 dBi

5470MHz-5725MHz

For Power directional gain= G_{ant} = 3.62 dBi

For PSD directional gain = G_{ant} = 3.62 dBi

5725MHz -5850MHz

For Power directional gain= G_{ant} = -0.23 dBi

For PSD directional gain = G_{ant} = -0.23 dBi



5. Test of AC Power Line Conducted Emission

5.1 Test Limit

Conducted Emissions were measured from 150 kHz to 30 MHz with a bandwidth of 9 KHz, according to the methods defined in ANSI C63.4-2014. The EUT was placed on a nonmetallic stand in a shielded room 0.8 meters above the ground plane. The interface cables and equipment positioning were varied within limits of reasonable applications to determine the position produced maximum conducted emissions.

Frequency (MHz)	Quasi Peak (dB μ V)	Average (dB μ V)
0.15 – 0.5	66-56*	56-46*
0.5 – 5.0	56	46
5.0 – 30.0	60	50

*Decreases with the logarithm of the frequency.

5.2 Test Procedures

- a. The EUT was placed 0.4 meter from the conducting wall of the shielding room was kept at least 80 centimeters from any other grounded conducting surface.
- b. Connect EUT to the power mains through a line impedance stabilization network (LISN).
- c. All the support units are connecting to the other LISN.
- d. The LISN provides 50 ohm coupling impedance for the measuring instrument.
- e. The FCC states that a 50 ohm, 50 micro-Henry LISN should be used.
- f. Both sides of AC line were checked for maximum conducted interference.
- g. The frequency range from 150 kHz to 30 MHz was searched.
- h. Set the test-receiver system to Peak Detect Function and Specified Bandwidth with Maximum Hold Mode.



5.3 Typical Test Setup

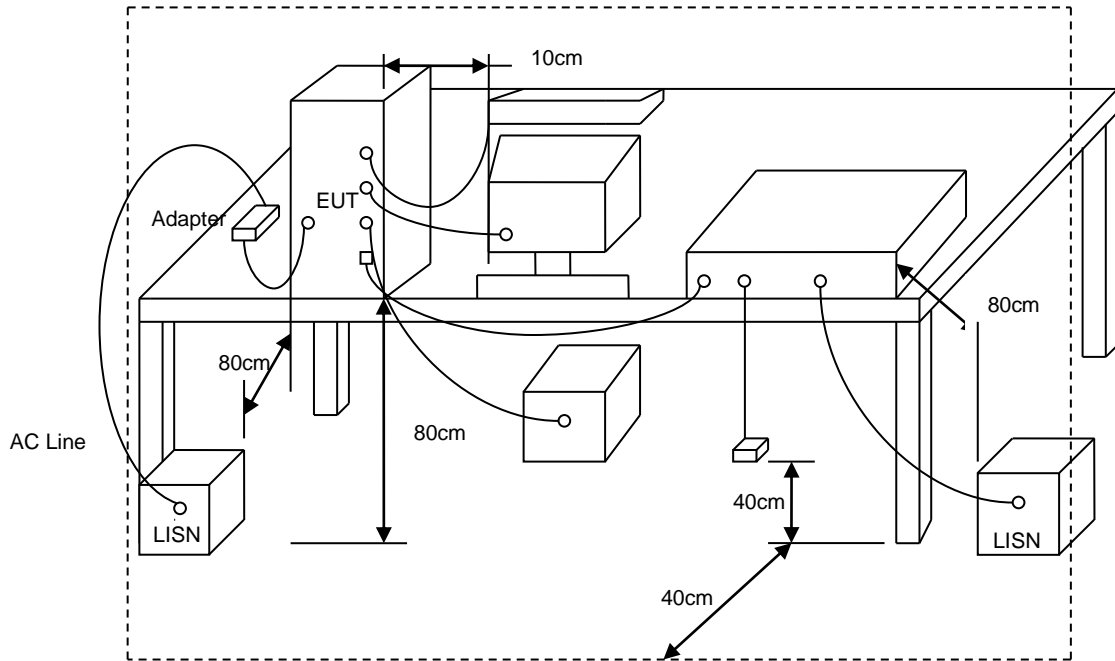



5.4 Test Result and Data

Power	: AC 120V	Pol/Phase	: LINE
Test Mode	: Mode 2	Temperature	: 23 °C
Test date	: Jan. 10, 2019	Humidity	: 45 %

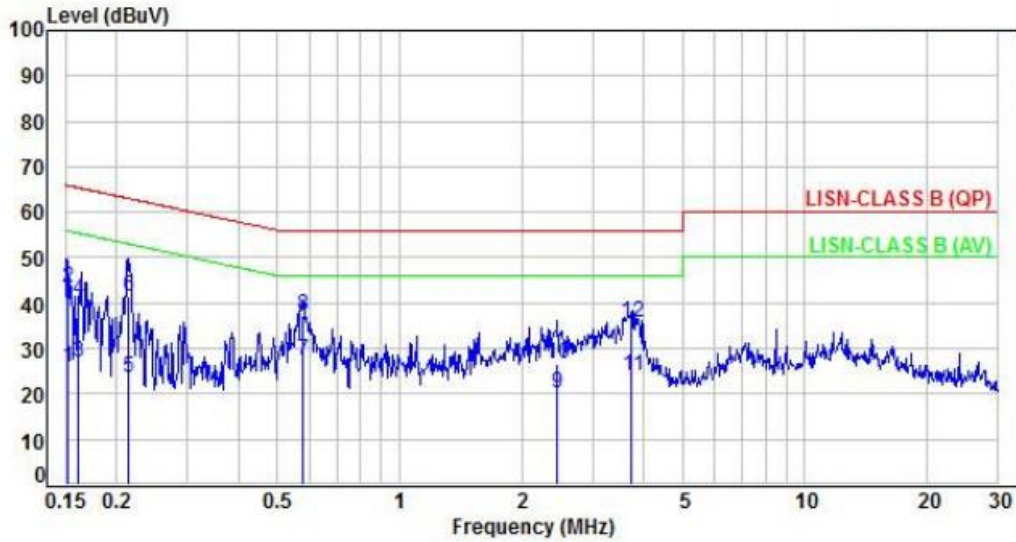

No.	Frequency (MHz)	Factor (dB)	Reading (dBuV)	Level (dBuV)	Limit (dBuV)	Margin (dB)	Detector	P/F
1	0.15	9.94	16.06	26.00	55.92	-29.92	Average	P
2	0.15	9.94	33.43	43.37	65.92	-22.55	QP	P
3	0.16	9.94	17.10	27.04	55.42	-28.38	Average	P
4	0.16	9.94	30.90	40.84	65.42	-24.58	QP	P
5	0.21	9.94	13.75	23.69	53.06	-29.37	Average	P
6	0.21	9.94	31.69	41.63	63.06	-21.43	QP	P
7	0.57	9.95	17.44	27.39	46.00	-18.61	Average	P
8	0.57	9.95	27.16	37.11	56.00	-18.89	QP	P
9	2.45	10.06	10.22	20.28	46.00	-25.72	Average	P
10	2.45	10.06	16.47	26.53	56.00	-29.47	QP	P
11	3.74	10.12	13.75	23.87	46.00	-22.13	Average	P
12	3.74	10.12	25.71	35.83	56.00	-20.17	QP	P

Note: Level=Reading+Factor
 Margin=Level-Limit
 Factor=(LISN or ISN or Current Probe)Factor + Cable Loss



Power	: AC 120V	Pol/Phase	: NEUTRAL
Test Mode	: Mode 2	Temperature	: 23 °C
Test date	: Jan. 10, 2019	Humidity	: 45 %

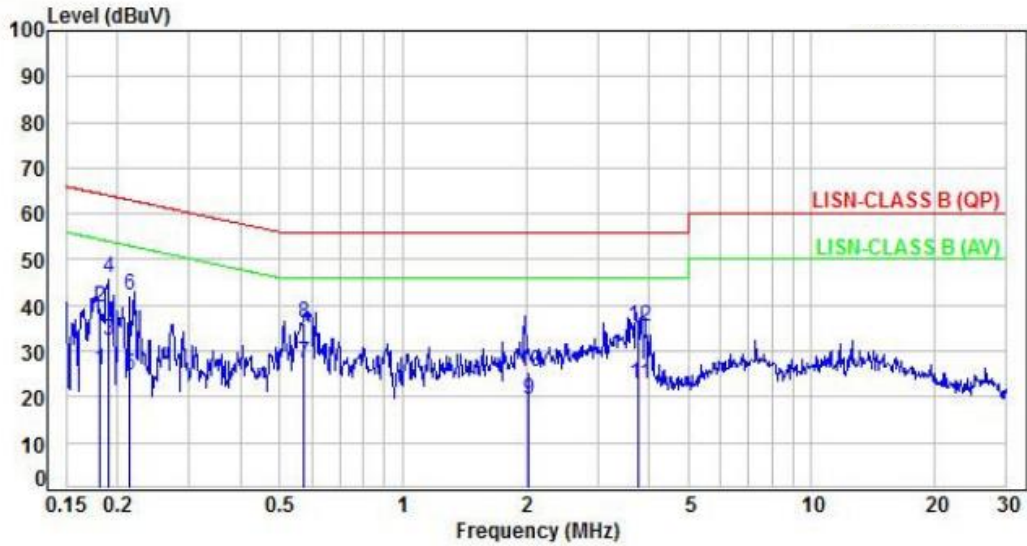

No.	Frequency (MHz)	Factor (dB)	Reading (dBuV)	Level (dBuV)	Limit (dBuV)	Margin (dB)	Detector	P/F
1	0.18	9.94	15.74	25.68	54.42	-28.74	Average	P
2	0.18	9.94	29.42	39.36	64.42	-25.06	QP	P
3	0.19	9.94	22.21	32.15	54.01	-21.86	Average	P
4	0.19	9.94	36.19	46.13	64.01	-17.88	QP	P
5	0.21	9.94	14.74	24.68	53.05	-28.37	Average	P
6	0.21	9.94	32.31	42.25	63.05	-20.80	QP	P
7	0.57	9.95	17.36	27.31	46.00	-18.69	Average	P
8	0.57	9.95	26.19	36.14	56.00	-19.86	QP	P
9	2.02	10.03	9.26	19.29	46.00	-26.71	Average	P
10	2.02	10.03	15.61	25.64	56.00	-30.36	QP	P
11	3.79	10.12	12.78	22.90	46.00	-23.10	Average	P
12	3.79	10.12	25.07	35.19	56.00	-20.81	QP	P

Note: Level=Reading+Factor
 Margin=Level-Limit
 Factor=(LISN or ISN or Current Probe)Factor + Cable Loss



6. Test of Radiated Spurious Emission

6.1 Test Limit

In any 100kHz bandwidth outside the frequency band in which the spread spectrum or digitally modulated intentional radiator is operating, the radio frequency power that is produced by the intentional radiator shall be at least 20dB below that in the 100kHz bandwidth within the band that contains the highest level of the desired power, based on either an RF conducted or a radiated measurement. If the transmitter measurement is based on the maximum conducted output power, the attenuation required under this paragraph shall be 30dB instead of 20dB. In addition, radiated emissions which fall in section 15.205(a) the restricted bands must also comply with the radiated emission limit specified in section 15.209(a).

Frequency (MHz)	Field Strength (microvolt/meter)	Measurement Distance (meters)
0.009 ~ 0.490	2400/F(kHz)	300
0.490 ~ 1.705	24000/F(kHz)	30
1.705 ~ 30.0	30	30
30 ~ 88	100	3
88 ~ 216	150	3
216 ~ 960	200	3
Above 960	500	3

6.2 Test Procedures

- a. The EUT was placed on a rotatable table top 0.8 meter above ground.
- b. The EUT was set 3 meters from the interference receiving antenna which was mounted on the top of a variable height antenna tower.
- c. The table was rotated 360 degrees to determine the position of the highest radiation.
- d. The antenna is a broadband antenna and its height is varied between one meter and four meters above ground to find the maximum value of the field strength both horizontal polarization and vertical polarization of the antenna are set to make the measurement.
- e. For each suspected emission the EUT was arranged to its worst case and then tune the antenna tower (from 1 M to 4 M) and turn table (from 0 degree to 360 degrees) to find the maximum reading.
- f. Set the test-receiver system to Peak or CISPR quasi-peak Detect Function and specified bandwidth with Maximum Hold Mode.
- g. If the emission level of the EUT in peak mode was 3 dB lower than the limit specified, then testing will be stopped and peak values of EUT will be reported, otherwise, the emissions which do not have 3 dB margin will be repeated one by one using the quasi-peak method and reported.
- h. For testing above 1GHz, the emission level of the EUT in peak mode was 20dB lower than average limit (that means the emission level in peak mode also complies with the limit in average mode), then testing will be stopped and peak values of EUT will be reported, otherwise, the emissions will be measured in average mode again and reported.
- i. "Cone of radiation" has been considered to be 3dB bandwidth of the measurement antenna.



6.3 Typical Test Setup

Below 30MHz test setup

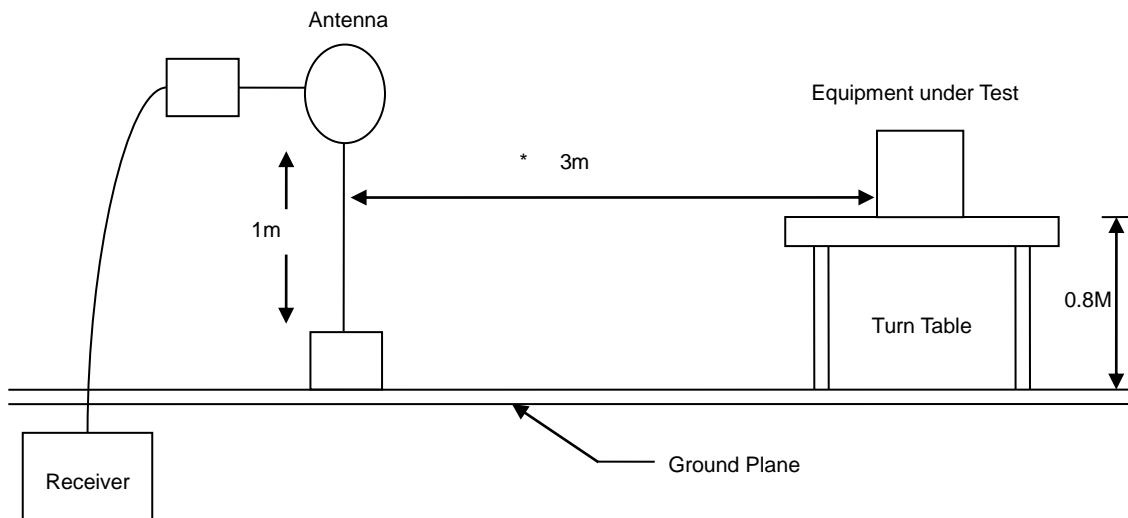

30MHz- 1GHz Test Setup

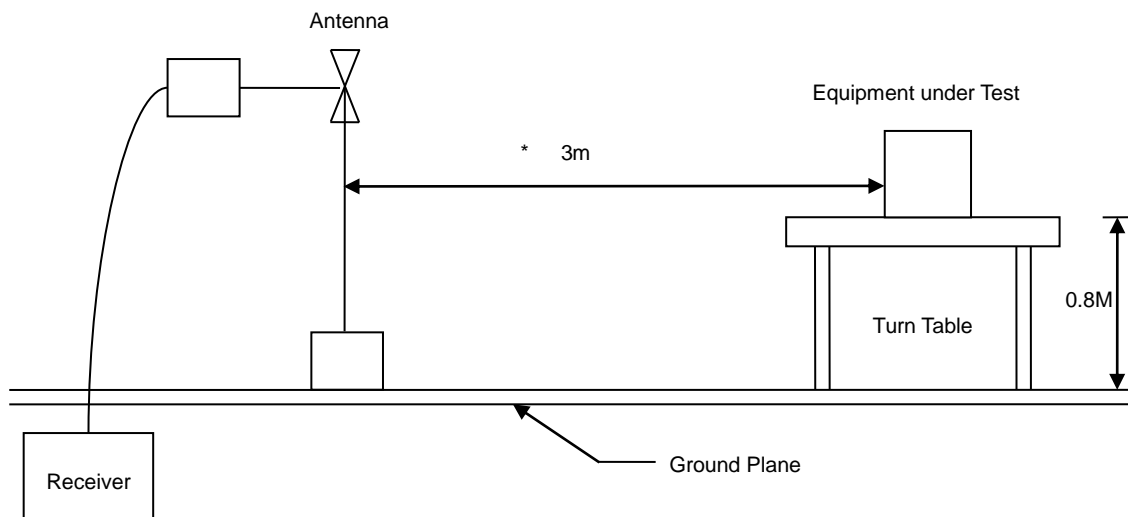

Above 1GHz Test Setup

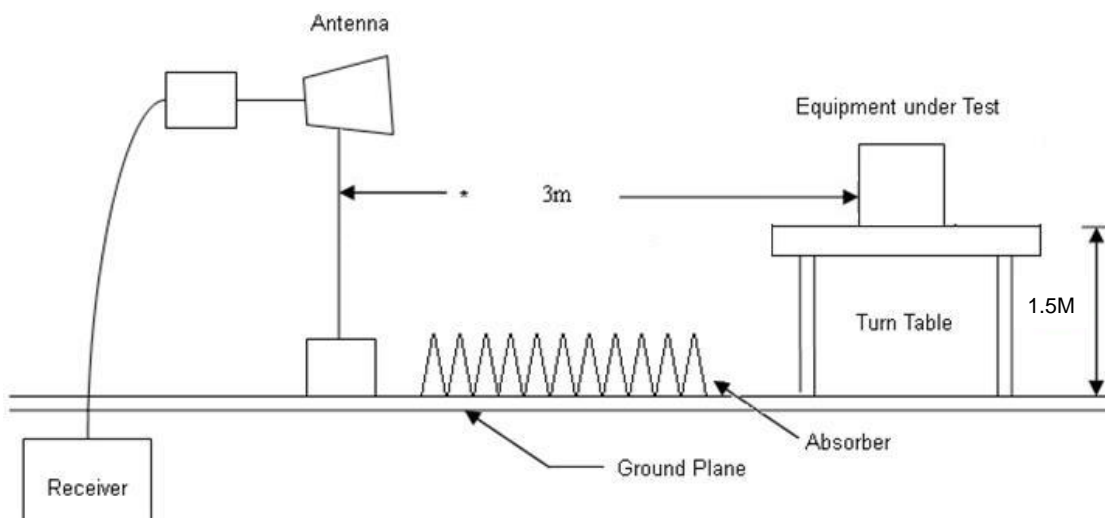



6.4 Test Result and Data (9KHz ~ 30MHz)

The 9kHz - 30MHz spurious emission is under limit 20dB more.

6.5 Test Result and Data (30MHz ~ 1GHz)

Power	: DC 5V From system	Pol/Phase	: VERTICAL
Test Mode	: Mode 2	Temperature	: 22 °C
Test Date	: Jan. 04, 2019	Humidity	: 59 %

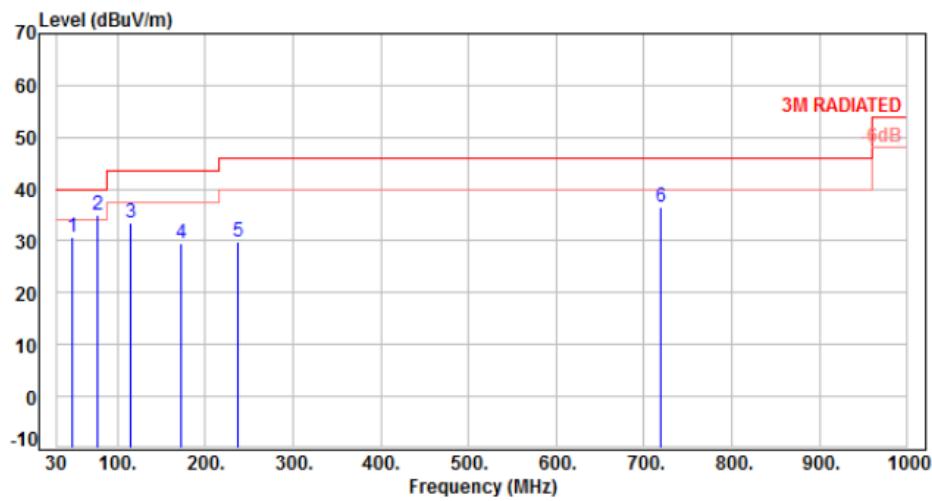

No.	Frequency (MHz)	Factor (dB)	Reading (dBuV)	Level (dBuV/m)	Limit (dBuV/m)	Margin (dB)	Detector	Height (cm)	Azimuth (deg)	P/F
1	48.43	-9.42	40.08	30.66	40.00	-9.34	Peak	400	0	P
2	76.56	-12.71	47.86	35.15	40.00	-4.85	Peak	400	0	P
3	115.36	-12.22	45.82	33.60	43.50	-9.90	Peak	400	0	P
4	172.59	-9.84	39.25	29.41	43.50	-14.09	Peak	400	0	P
5	237.58	-10.75	40.63	29.88	46.00	-16.12	Peak	400	0	P
6	718.70	0.32	36.13	36.45	46.00	-9.55	Peak	400	0	P

Note: Level=Reading+Factor
Margin=Level-Limit
Factor=Antenna Factor + cable loss - Amplifier Factor



Power	: DC 5V From system	Pol/Phase	: HORIZONTAL
Test Mode	: Mode 2	Temperature	: 22 °C
Test Date	: Jan. 04, 2019	Humidity	: 59 %

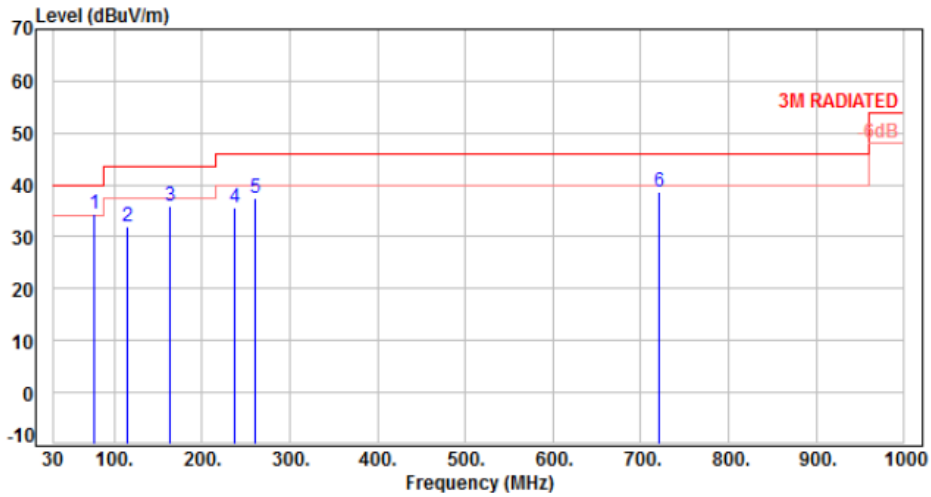

No.	Frequency (MHz)	Factor (dB)	Reading (dBuV)	Level (dBuV/m)	Limit (dBuV/m)	Margin (dB)	Detector	Height (cm)	Azimuth (deg)	P/F
1	76.56	-12.71	47.15	34.44	40.00	-5.56	Peak	100	0	P
2	114.39	-12.28	44.17	31.89	43.50	-11.61	Peak	100	0	P
3	163.86	-9.30	45.20	35.90	43.50	-7.60	Peak	100	0	P
4	236.61	-10.83	46.37	35.54	46.00	-10.46	Peak	100	0	P
5	260.86	-9.88	47.28	37.40	46.00	-8.60	Peak	100	0	P
6	720.64	0.30	38.45	38.75	46.00	-7.25	Peak	100	0	P

Note: Level=Reading+Factor
 Margin=Level-Limit
 Factor=Antenna Factor + cable loss - Amplifier Factor



6.6 Test Result and Data (1GHz ~ 25GHz)

Power	: DC 5V From system	Pol/Phase	: VERTICAL
Test Mode	: Mode 1, CH01	Temperature	: 22 °C
Test Date	: Jan. 04, 2019	Humidity	: 59 %

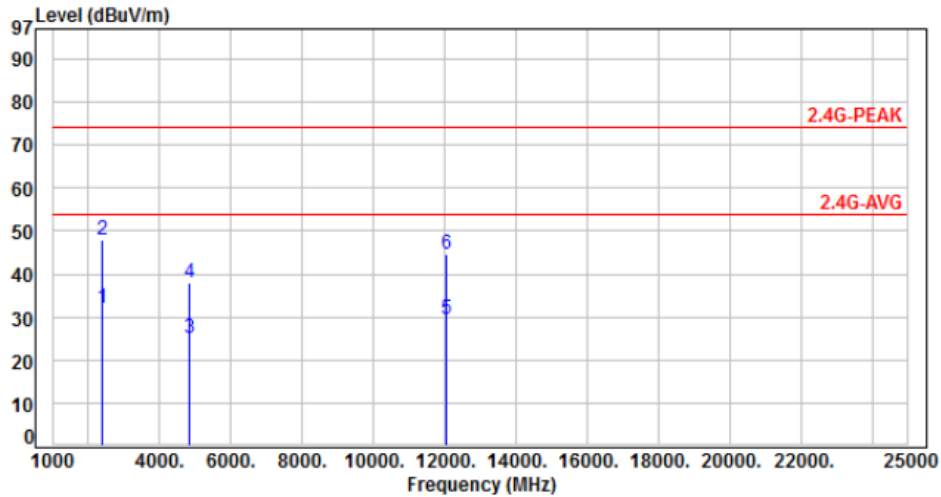

No.	Frequency (MHz)	Factor (dB)	Reading (dBuV)	Level (dBuV/m)	Limit (dBuV/m)	Margin (dB)	Detector	Height (cm)	Azimuth (deg)	P/F
1	2390.00	-15.68	47.60	31.92	54.00	-22.08	Average	100	315	P
2	2390.00	-15.68	63.80	48.12	74.00	-25.88	Peak	100	315	P
3	4824.00	-8.47	33.57	25.10	54.00	-28.90	Average	100	78	P
4	4824.00	-8.47	46.55	38.08	74.00	-35.92	Peak	100	78	P
5	12060.00	1.79	27.65	29.44	54.00	-24.56	Average	100	102	P
6	12060.00	1.79	42.81	44.60	74.00	-29.40	Peak	100	102	P

Note: Level=Reading+Factor
 Margin=Level-Limit
 Factor=Antenna Factor + cable loss - Amplifier Factor



Power	: DC 5V From system	Pol/Phase	: HORIZONTAL
Test Mode	: Mode 1, CH01	Temperature	: 22 °C
Test Date	: Jan. 04, 2019	Humidity	: 59 %

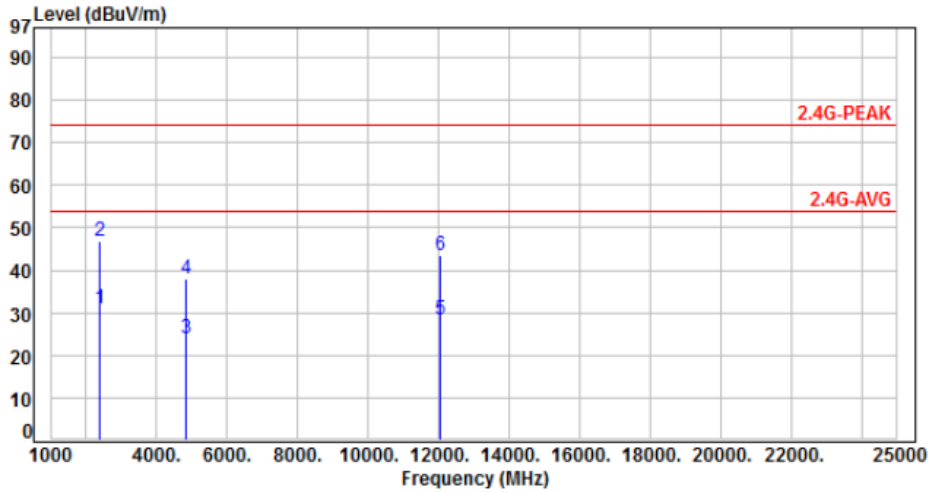

No.	Frequency (MHz)	Factor (dB)	Reading (dBuV)	Level (dBuV/m)	Limit (dBuV/m)	Margin (dB)	Detector	Height (cm)	Azimuth (deg)	P/F
1	2390.00	-15.68	46.80	31.12	54.00	-22.88	Average	200	285	P
2	2390.00	-15.68	62.60	46.92	74.00	-27.08	Peak	200	285	P
3	4824.00	-8.47	32.44	23.97	54.00	-30.03	Average	100	351	P
4	4824.00	-8.47	46.52	38.05	74.00	-35.95	Peak	100	351	P
5	12060.00	1.79	26.75	28.54	54.00	-25.46	Average	100	296	P
6	12060.00	1.79	41.55	43.34	74.00	-30.66	Peak	100	296	P

Note: Level=Reading+Factor
 Margin=Level-Limit
 Factor=Antenna Factor + cable loss - Amplifier Factor



Power	: DC 5V From system	Pol/Phase	: VERTICAL
Test Mode	: Mode 1, CH06	Temperature	: 22 °C
Test Date	: Jan. 04, 2019	Humidity	: 59 %

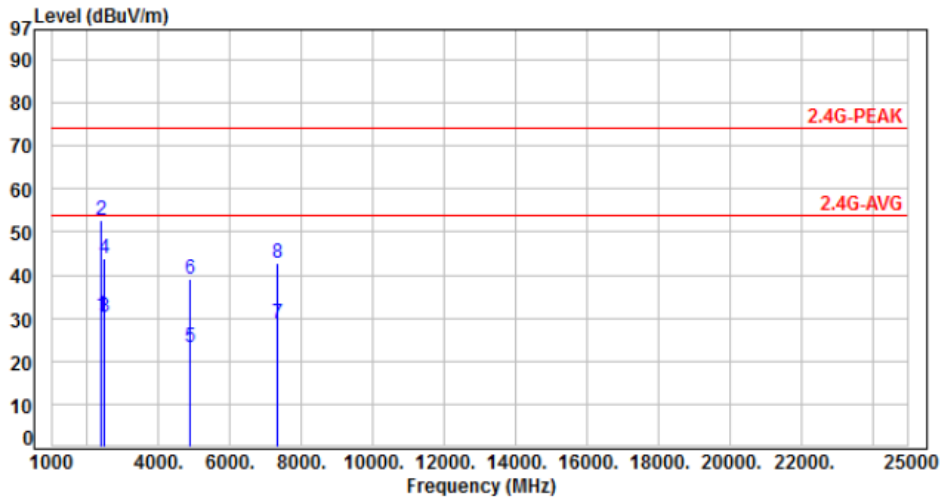

No.	Frequency (MHz)	Factor (dB)	Reading (dBuV)	Level (dBuV/m)	Limit (dBuV/m)	Margin (dB)	Detector	Height (cm)	Azimuth (deg)	P/F
1	2390.00	-15.68	46.20	30.52	54.00	-23.48	Average	120	330	P
2	2390.00	-15.68	68.60	52.92	74.00	-21.08	Peak	120	330	P
3	2483.50	-15.36	45.60	30.24	54.00	-23.76	Average	120	330	P
4	2483.50	-15.36	59.35	43.99	74.00	-30.01	Peak	120	330	P
5	4874.00	-8.33	31.42	23.09	54.00	-30.91	Average	100	63	P
6	4874.00	-8.33	47.53	39.20	74.00	-34.80	Peak	100	63	P
7	7311.00	-3.86	32.52	28.66	54.00	-25.34	Average	100	108	P
8	7311.00	-3.86	46.81	42.95	74.00	-31.05	Peak	100	108	P

Note: Level=Reading+Factor
 Margin=Level-Limit
 Factor=Antenna Factor + cable loss - Amplifier Factor



Power	: DC 5V From system	Pol/Phase	: HORIZONTAL
Test Mode	: Mode 1, CH06	Temperature	: 22 °C
Test Date	: Jan. 04, 2019	Humidity	: 59 %

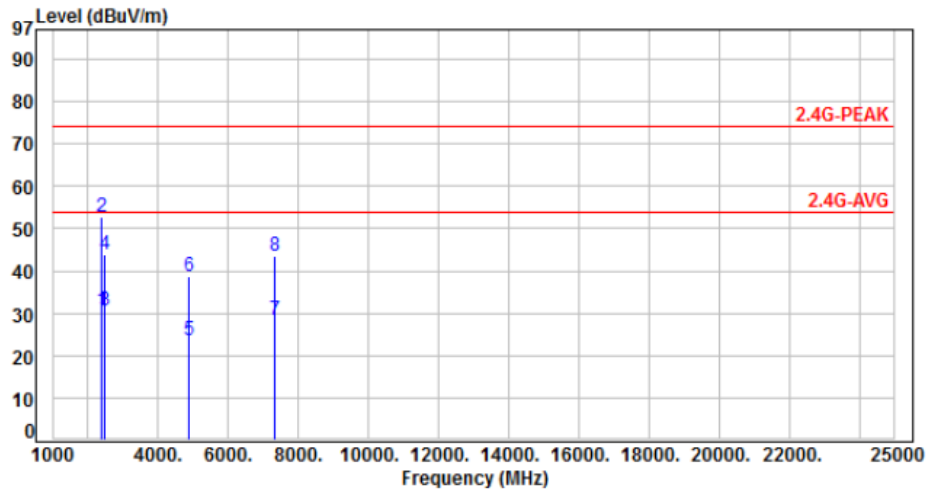

No.	Frequency (MHz)	Factor (dB)	Reading (dBuV)	Level (dBuV/m)	Limit (dBuV/m)	Margin (dB)	Detector	Height (cm)	Azimuth (deg)	P/F
1	2390.00	-15.68	46.45	30.77	54.00	-23.23	Average	211	260	P
2	2390.00	-15.68	68.40	52.72	74.00	-21.28	Peak	211	260	P
3	2483.50	-15.36	45.90	30.54	54.00	-23.46	Average	211	260	P
4	2483.50	-15.36	59.12	43.76	74.00	-30.24	Peak	211	260	P
5	4874.00	-8.33	31.88	23.55	54.00	-30.45	Average	100	302	P
6	4874.00	-8.33	47.02	38.69	74.00	-35.31	Peak	100	302	P
7	7311.00	-3.86	32.42	28.56	54.00	-25.44	Average	100	324	P
8	7311.00	-3.86	47.23	43.37	74.00	-30.63	Peak	100	324	P

Note: Level=Reading+Factor
 Margin=Level-Limit
 Factor=Antenna Factor + cable loss - Amplifier Factor



Power	: DC 5V From system	Pol/Phase	: VERTICAL
Test Mode	: Mode 1, CH11	Temperature	: 22 °C
Test Date	: Jan. 04, 2019	Humidity	: 59 %

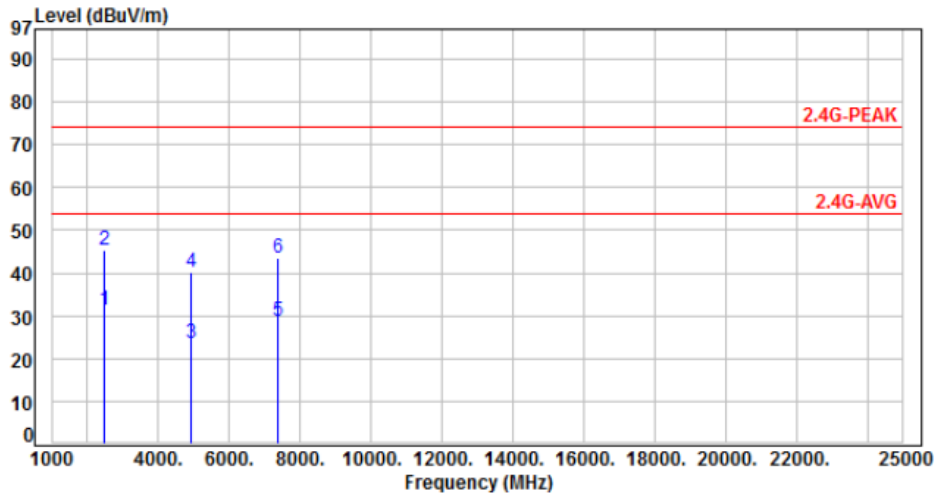

No.	Frequency (MHz)	Factor (dB)	Reading (dBuV)	Level (dBuV/m)	Limit (dBuV/m)	Margin (dB)	Detector	Height (cm)	Azimuth (deg)	P/F
1	2483.50	-15.36	46.56	31.20	54.00	-22.80	Average	100	308	P
2	2483.50	-15.36	60.70	45.34	74.00	-28.66	Peak	100	308	P
3	4924.00	-8.18	31.88	23.70	54.00	-30.30	Average	100	116	P
4	4924.00	-8.18	48.25	40.07	74.00	-33.93	Peak	100	116	P
5	7386.00	-3.67	32.42	28.75	54.00	-25.25	Average	100	97	P
6	7386.00	-3.67	47.26	43.59	74.00	-30.41	Peak	100	97	P

Note: Level=Reading+Factor
 Margin=Level-Limit
 Factor=Antenna Factor + cable loss - Amplifier Factor



Power	: DC 5V From system	Pol/Phase	: HORIZONTAL
Test Mode	: Mode 1, CH11	Temperature	: 22 °C
Test Date	: Jan. 04, 2019	Humidity	: 59 %

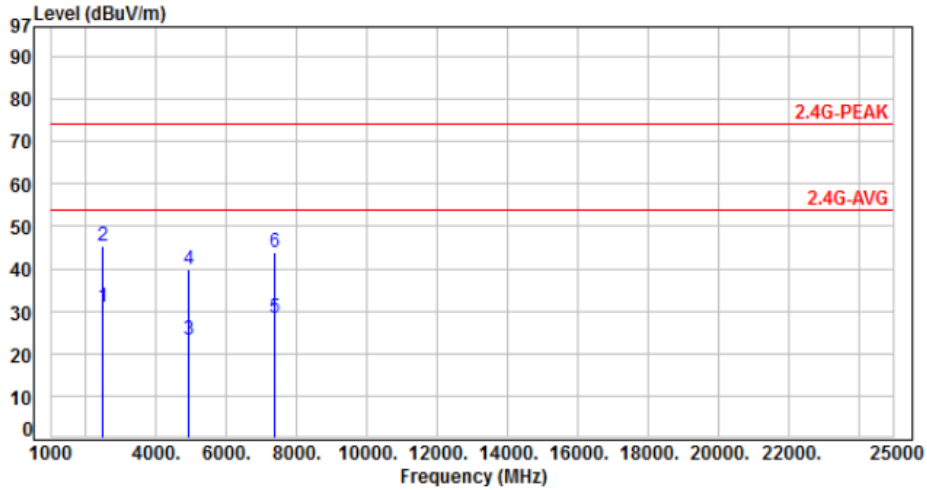

No.	Frequency (MHz)	Factor (dB)	Reading (dBuV)	Level (dBuV/m)	Limit (dBuV/m)	Margin (dB)	Detector	Height (cm)	Azimuth (deg)	P/F
1	2483.50	-15.36	46.50	31.14	54.00	-22.86	Average	400	260	P
2	2483.50	-15.36	60.80	45.44	74.00	-28.56	Peak	400	260	P
3	4924.00	-8.18	31.58	23.40	54.00	-30.60	Average	100	286	P
4	4924.00	-8.18	48.16	39.98	74.00	-34.02	Peak	100	286	P
5	7386.00	-3.67	32.06	28.39	54.00	-25.61	Average	100	297	P
6	7386.00	-3.67	47.62	43.95	74.00	-30.05	Peak	100	297	P

Note: Level=Reading+Factor
Margin=Level-Limit
Factor=Antenna Factor + cable loss - Amplifier Factor



Power	: DC 5V From system	Pol/Phase	: VERTICAL
Test Mode	: Mode 2, CH06	Temperature	: 22 °C
Test Date	: Jan. 04, 2019	Humidity	: 59 %

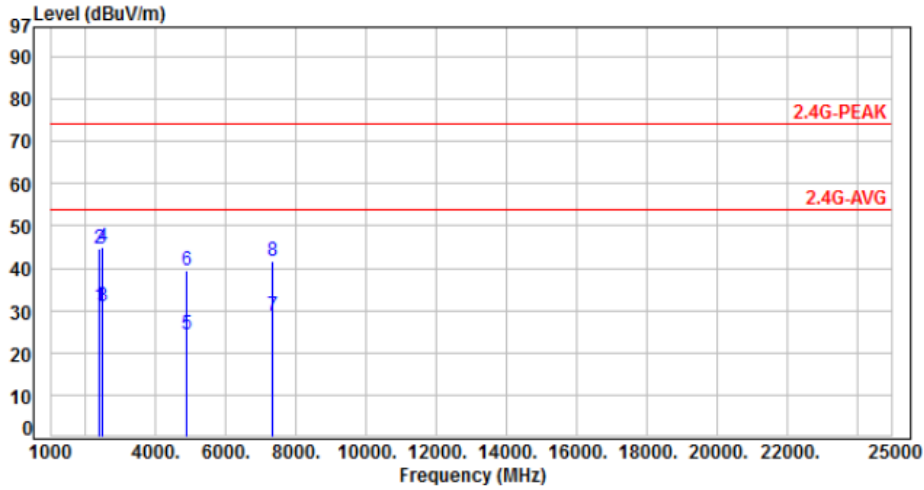

No.	Frequency (MHz)	Factor (dB)	Reading (dBUV)	Level (dBUV/m)	Limit (dBUV/m)	Margin (dB)	Detector	Height (cm)	Azimuth (deg)	P/F
1	2390.00	-15.68	46.50	30.82	54.00	-23.18	Average	100	342	P
2	2390.00	-15.68	60.20	44.52	74.00	-29.48	Peak	100	342	P
3	2483.50	-15.36	46.30	30.94	54.00	-23.06	Average	100	342	P
4	2483.50	-15.36	60.51	45.15	74.00	-28.85	Peak	100	342	P
5	4874.00	-8.33	32.52	24.19	54.00	-29.81	Average	100	82	P
6	4874.00	-8.33	47.88	39.55	74.00	-34.45	Peak	100	82	P
7	7311.00	-3.86	32.68	28.82	54.00	-25.18	Average	100	65	P
8	7311.00	-3.86	45.63	41.77	74.00	-32.23	Peak	100	65	P

Note: Level=Reading+Factor
 Margin=Level-Limit
 Factor=Antenna Factor + cable loss - Amplifier Factor



Power	: DC 5V From system	Pol/Phase	: HORIZONTAL
Test Mode	: Mode 2, CH06	Temperature	: 22 °C
Test Date	: Jan. 04, 2019	Humidity	: 59 %

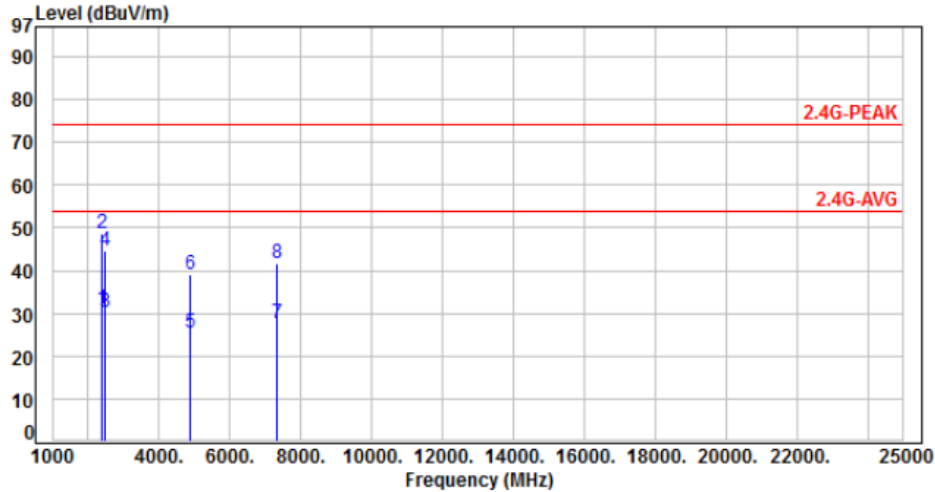

No.	Frequency (MHz)	Factor (dB)	Reading (dBuV)	Level (dBuV/m)	Limit (dBuV/m)	Margin (dB)	Detector	Height (cm)	Azimuth (deg)	P/F
1	2390.00	-15.68	46.50	30.82	54.00	-23.18	Average	100	265	P
2	2390.00	-15.68	64.40	48.72	74.00	-25.28	Peak	100	265	P
3	2483.50	-15.36	45.70	30.34	54.00	-23.66	Average	100	265	P
4	2483.50	-15.36	60.10	44.74	74.00	-29.26	Peak	100	265	P
5	4874.00	-8.33	33.61	25.28	54.00	-28.72	Average	100	359	P
6	4874.00	-8.33	47.42	39.09	74.00	-34.91	Peak	100	359	P
7	7311.00	-3.86	31.68	27.82	54.00	-26.18	Average	100	324	P
8	7311.00	-3.86	45.36	41.50	74.00	-32.50	Peak	100	324	P

Note: Level=Reading+Factor
 Margin=Level-Limit
 Factor=Antenna Factor + cable loss - Amplifier Factor



Power	: DC 5V From system	Pol/Phase	: VERTICAL
Test Mode	: Mode 2, CH11	Temperature	: 22 °C
Test Date	: Jan. 04, 2019	Humidity	: 59 %

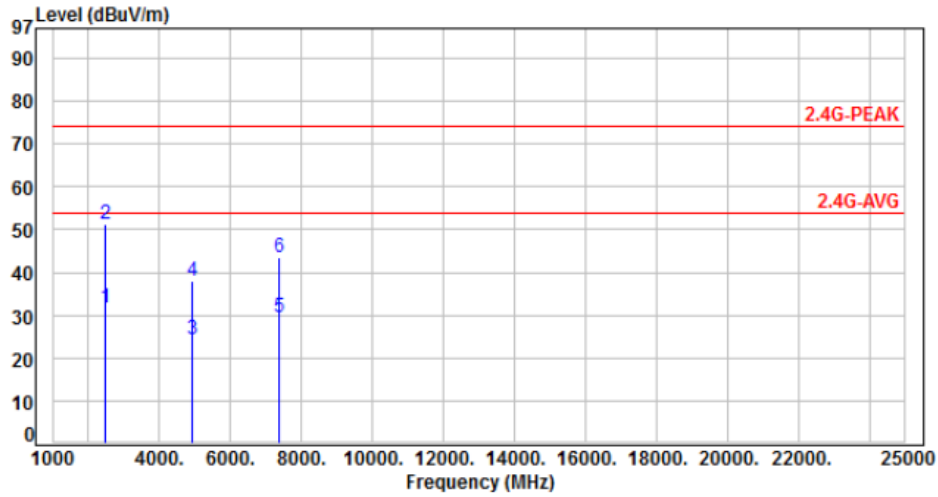

No.	Frequency (MHz)	Factor (dB)	Reading (dBuV)	Level (dBuV/m)	Limit (dBuV/m)	Margin (dB)	Detector	Height (cm)	Azimuth (deg)	P/F
1	2483.50	-15.36	47.22	31.86	54.00	-22.14	Average	100	310	P
2	2483.50	-15.36	66.50	51.14	74.00	-22.86	Peak	100	310	P
3	4924.00	-8.18	32.65	24.47	54.00	-29.53	Average	100	104	P
4	4924.00	-8.18	46.35	38.17	74.00	-35.83	Peak	100	104	P
5	7386.00	-3.67	33.27	29.60	54.00	-24.40	Average	100	81	P
6	7386.00	-3.67	47.23	43.56	74.00	-30.44	Peak	100	81	P

Note: Level=Reading+Factor
 Margin=Level-Limit
 Factor=Antenna Factor + cable loss - Amplifier Factor



Power	: DC 5V From system	Pol/Phase	: HORIZONTAL
Test Mode	: Mode 2, CH11	Temperature	: 22 °C
Test Date	: Jan. 04, 2019	Humidity	: 59 %

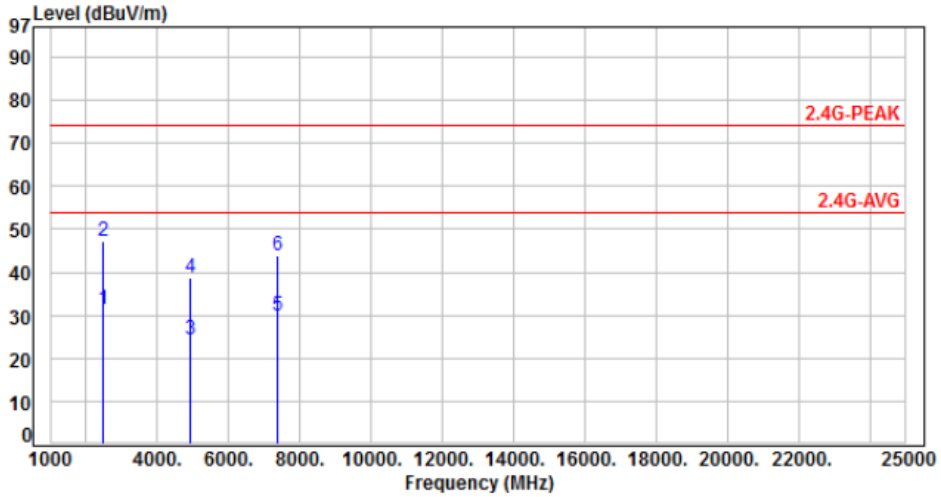

No.	Frequency (MHz)	Factor (dB)	Reading (dBuV)	Level (dBuV/m)	Limit (dBuV/m)	Margin (dB)	Detector	Height (cm)	Azimuth (deg)	P/F
1	2483.50	-15.36	46.60	31.24	54.00	-22.76	Average	383	260	P
2	2483.50	-15.36	62.54	47.18	74.00	-26.82	Peak	383	260	P
3	4924.00	-8.18	32.35	24.17	54.00	-29.83	Average	100	277	P
4	4924.00	-8.18	46.81	38.63	74.00	-35.37	Peak	100	277	P
5	7386.00	-3.67	33.42	29.75	54.00	-24.25	Average	100	318	P
6	7386.00	-3.67	47.59	43.92	74.00	-30.08	Peak	100	318	P

Note: Level=Reading+Factor
 Margin=Level-Limit
 Factor=Antenna Factor + cable loss - Amplifier Factor



6.7 Restricted Bands of Operation

Only spurious emissions are permitted in any of the frequency bands listed below:

MHz	MHz	MHz	GHz
0.09000 – 0.11000	16.42000 – 16.42300	399.9 – 410.0	4.500 – 5.250
0.49500 – 0.505**	16.69475 – 16.69525	608.0 – 614.0	5.350 – 5.460
2.17350 – 2.19050	16.80425 – 16.80475	960.0 – 1240.0	7.250 – 7.750
4.12500 – 4.12800	25.50000 – 25.67000	1300.0 – 1427.0	8.025 – 8.500
4.17725 – 4.17775	37.50000 – 38.25000	1435.0 – 1626.5	9.000 – 9.200
4.20725 – 4.20775	73.00000 – 74.60000	1645.5 – 1646.5	9.300 – 9.500
6.21500 – 6.21800	74.80000 – 75.20000	1660.0 – 1710.0	10.600 – 12.700
6.26775 – 6.26825	108.00000 – 121.94000	1718.8 – 1722.2	13.250 – 13.400
6.31175 – 6.31225	123.00000 – 138.00000	2200.0 – 2300.0	14.470 – 14.500
8.29100 – 8.29400	149.90000 – 150.05000	2310.0 – 2390.0	15.350 – 16.200
8.36200 – 8.36600	156.52475 – 156.52525	2483.5 – 2500.0	17.700 – 21.400
8.37625 – 8.38675	156.70000 – 156.90000	2655.0 – 2900.0	22.010 – 23.120
8.41425 – 8.41475	162.01250 – 167.17000	3260.0 – 3267.0	23.600 – 24.000
12.29000 – 12.29300	167.72000 – 173.20000	3332.0 – 3339.0	31.200 – 31.800
12.51975 – 12.52025	240.00000 – 285.00000	3345.8 – 3358.0	36.430 – 36.500
12.57675 – 12.57725	322.00000 – 335.40000	3600.0 – 4400.0	Above 38.6
13.36000 – 13.41000			

** : Until February 1, 1999, this restricted band shall be 0.490-0.510 MHz



7. Test of Conducted Spurious Emission

7.1 Test Limit

Below -30dB of the highest emission level of operating band (In 100 kHz Resolution Bandwidth)

7.2 Test Procedure

- a. The transmitter output was connected to the spectrum analyzer via a low loss cable.
- b. Set RBW of spectrum analyzer to 100 KHz and VBW of spectrum analyzer to 300 KHz with convenient frequency span including 100 KHz bandwidth from band edge.
- c. Average conducted output power measured within any 100 kHz outside the authorized frequency band shall be attenuated by at least 30dB relative to the maximum measured in-band peak PSD level.
- d. The band edges was measured and recorded.

7.3 Test Setup Layout

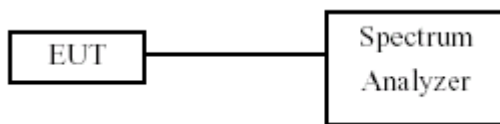

7.4 Test Result and Data

Test Result	: PASS	Temperature	: 22°C
Test Date	: Jan. 04, 2019	Humidity	: 62%

Note: Test plots refers to the following pages.



Modulation Type: 802.11g, CH 01

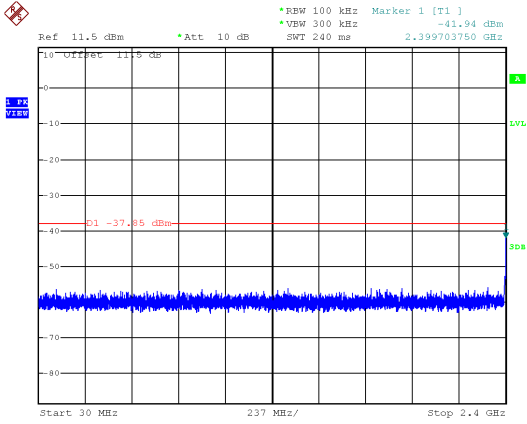

Modulation Type: 802.11g, CH 06

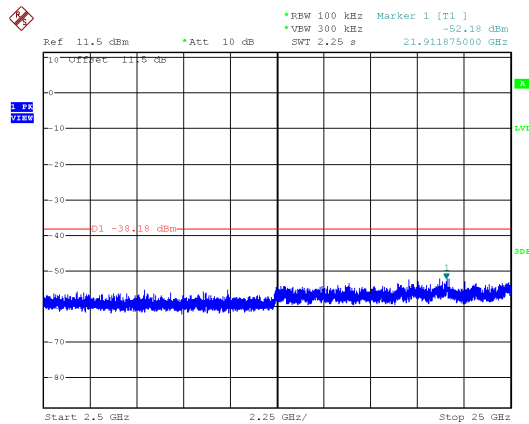
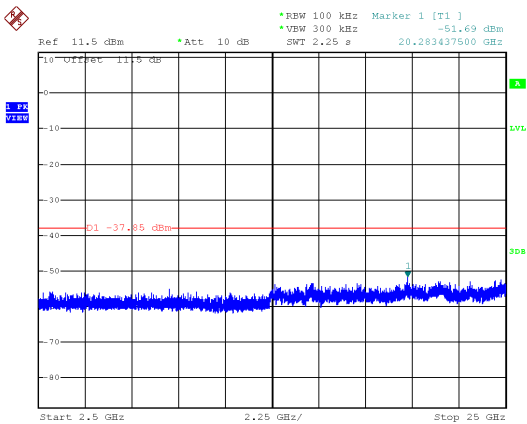
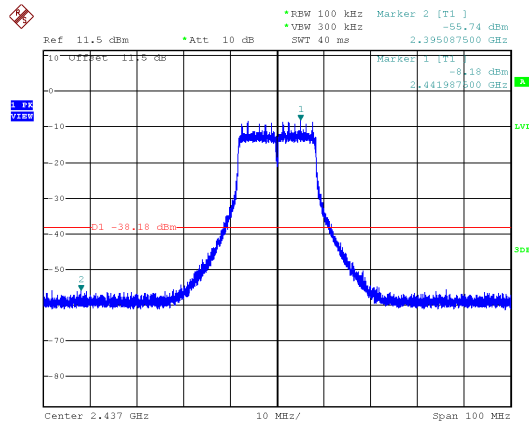
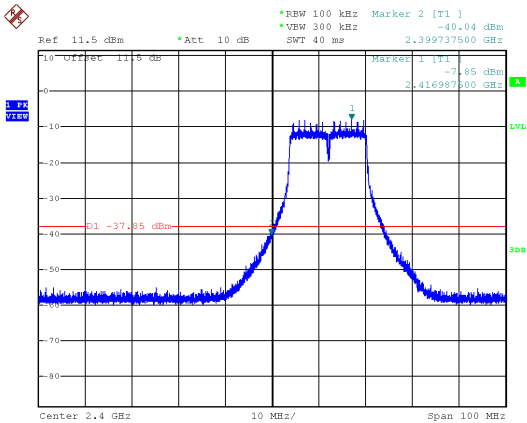
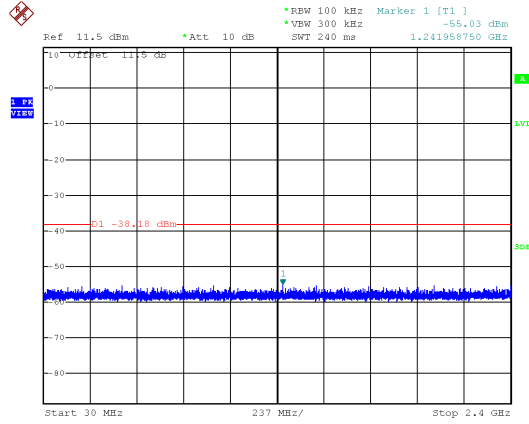



Modulation Type: 802.11g, CH 11

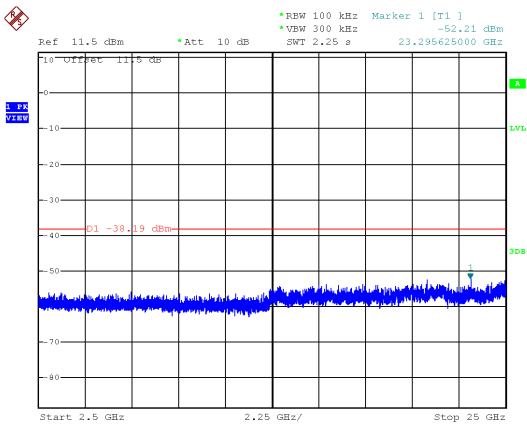
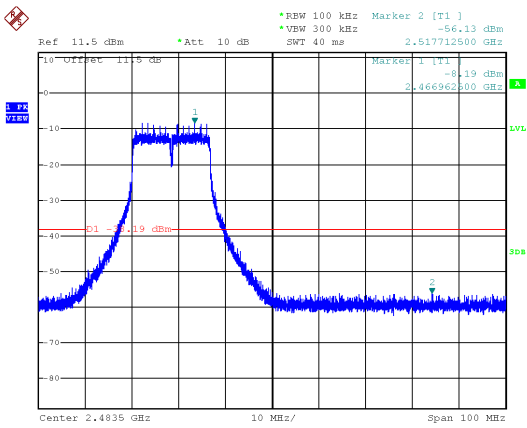
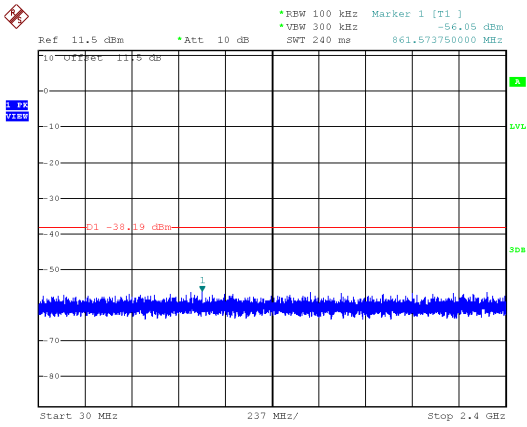



Modulation Type: 802.11n HT20, CH01

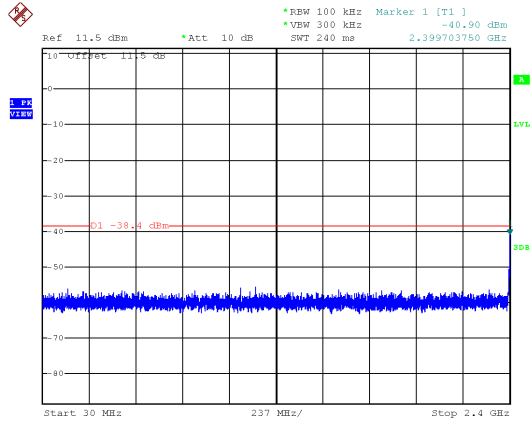

Modulation Type: 802.11n HT20, CH06

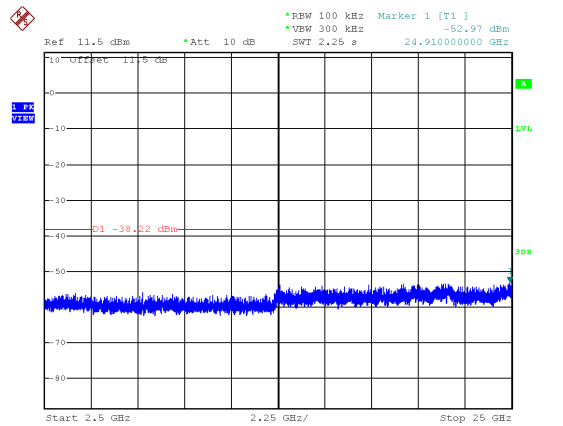
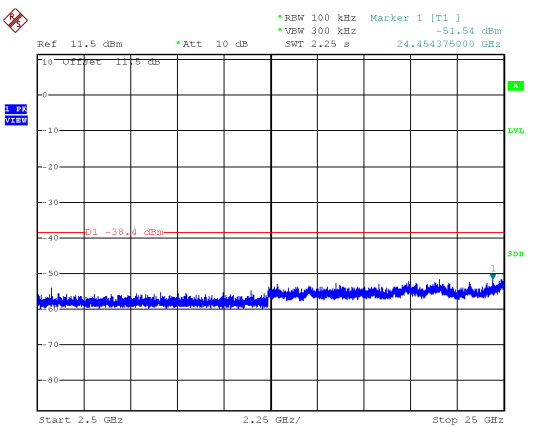
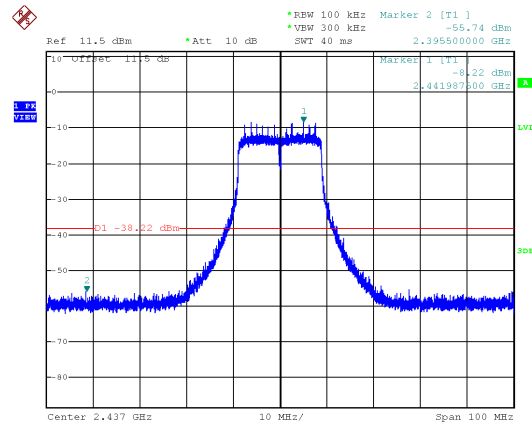
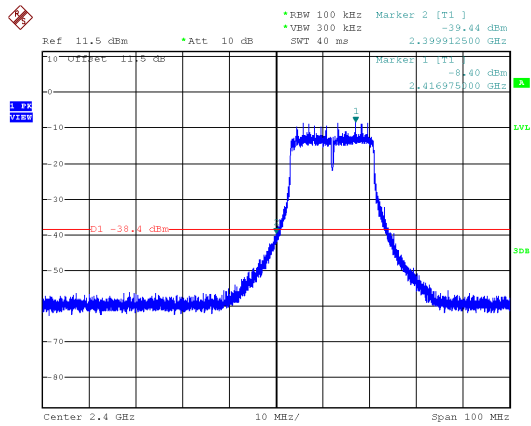
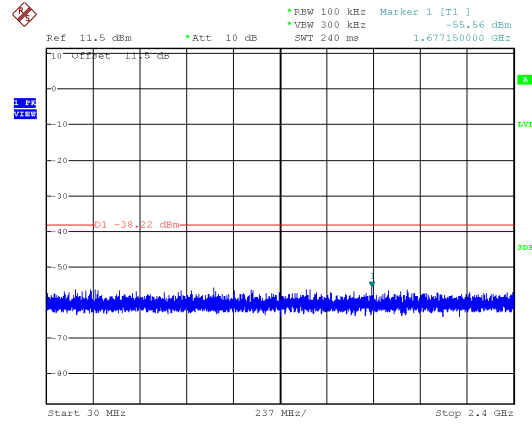



Modulation Type: 802.11n HT20, CH11

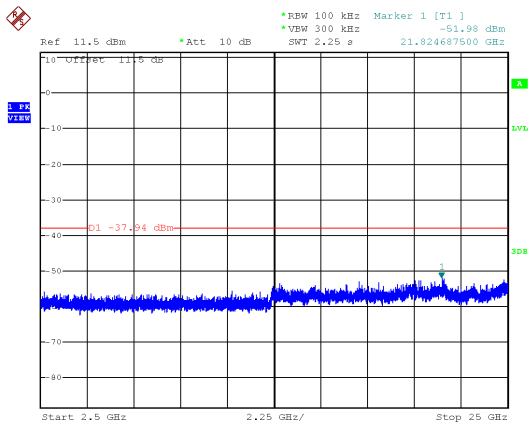
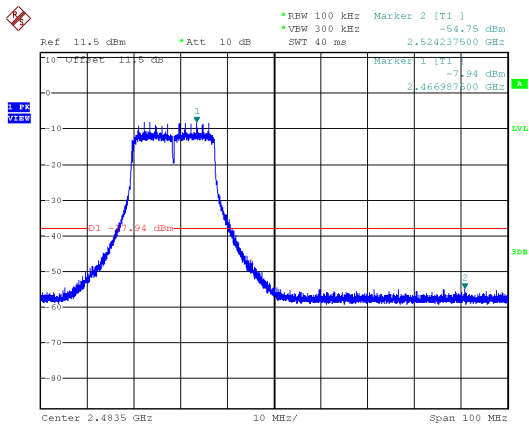
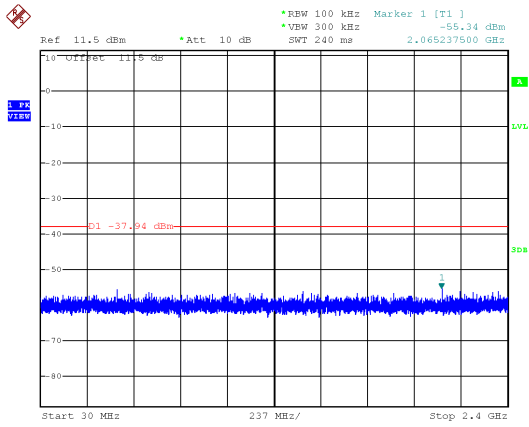



8. On Time, Duty Cycle and Measurement methods

8.1 Test Limit

None; for reporting purposes only.

8.2 Test Procedure

KDB 558074 Zero-Span Spectrum Analyzer Method.

8.3 Test Setup Layout

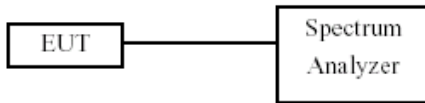

8.4 Test Result and Data

Temperature : 22°C

Humidity : 62%

Test Date : Jan. 04, 2019

Modulation Type	On Time (msec)	Period Time (msec)	Duty Cycle (%)
802.11g,6M	2.05	2.09	98.09%
802.11n HT20,M0	1.93	1.96	98.47%



Modulation Standard: 802.11g (6Mbps)

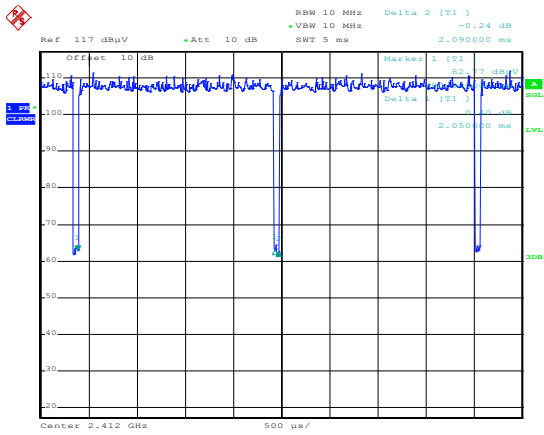

Modulation Standard: 802.11n HT20 (6.5Mbps)

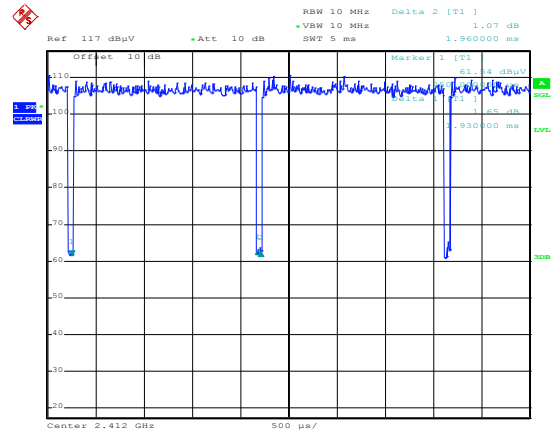



9. 6dB Bandwidth Measurement Data

9.1 Test Limit

The minimum of 6dB Bandwidth Measurement is 0.5 MHz.

9.2 Test Procedures

- a. The transmitter output was connected to the spectrum analyzer.
- b. Set RBW of spectrum analyzer to 1~5% of the emission bandwidth and VBW ≥ 3x RBW.
- c. The 6 dB bandwidth is defined as the total spectrum the power of which is higher than peak power minus 6 dB.
- d. The 6dB Bandwidth was measured and recorded.

9.3 Test Setup Layout

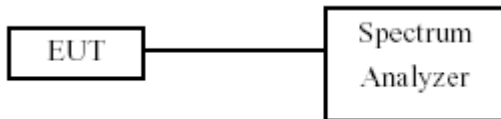

9.4 Test Result and Data

Temperature : 22°C

Humidity : 62%

Test Date : Jan. 04, 2019

Modulation Type	Channel	Frequency (MHz)	6dB Bandwidth (MHz)	Limit (MHz)
			ANT A	
802.11g	01	2412	16.40	0.5
	06	2437	16.40	0.5
	11	2462	16.40	0.5
802.11n HT20	01	2412	17.60	0.5
	06	2437	17.60	0.5
	11	2462	17.60	0.5



Modulation Type: 802.11g
CH01

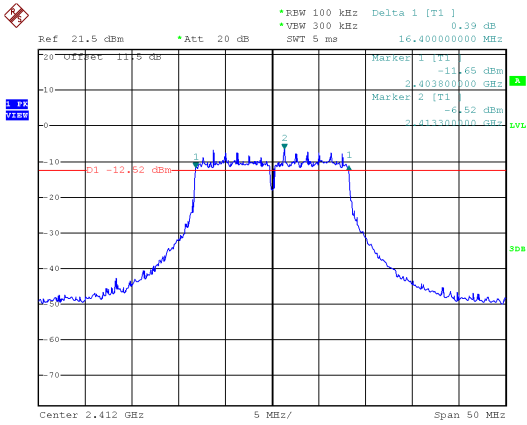

Modulation Type: 802.11n HT20
CH01

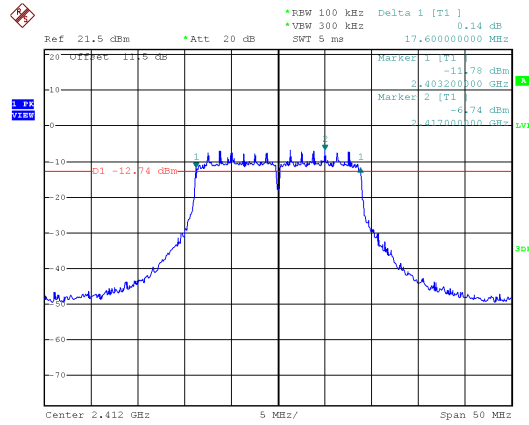

CH06

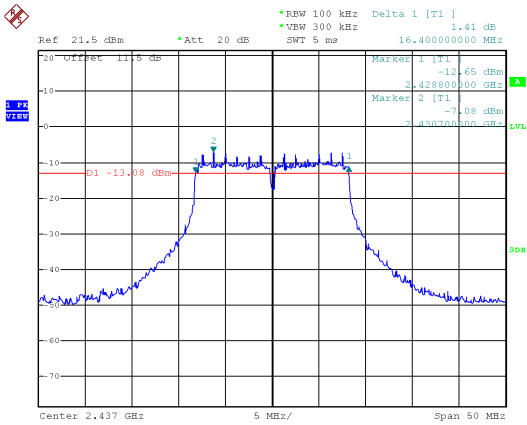

CH06

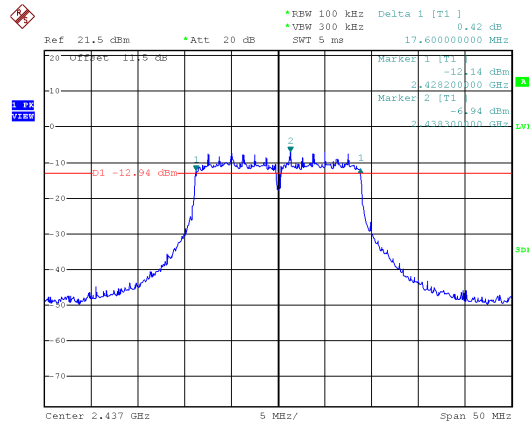

CH11

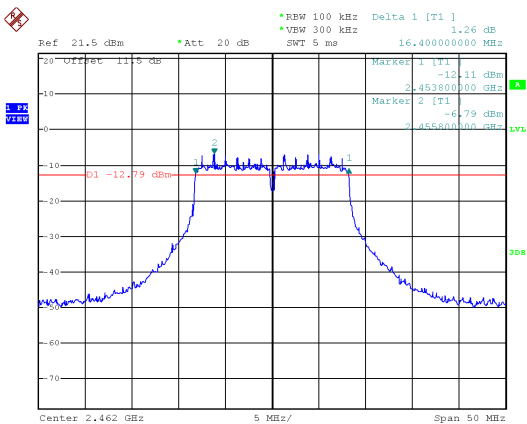

CH11

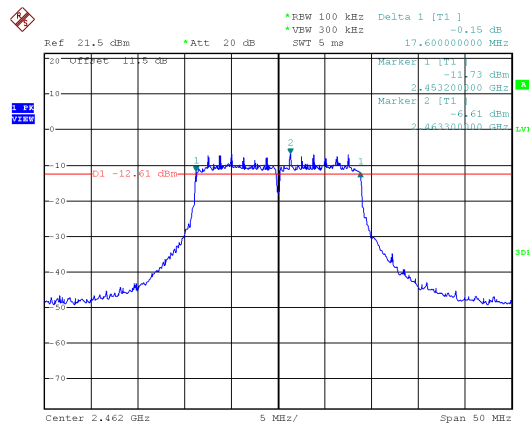



10. Maximum Average Output Power

10.1 Test Limit

The Maximum Average Output Power Measurement is 30dBm. If transmitting antennas of directional gain greater than 6 dBi are used, the Average output power shall be reduced by the amount in dB that the directional gain of the antenna exceeds 6 dBi

10.2 Test Procedures

The antenna port (RF output) of the EUT was connected to the input (RF input) of a power meter. Power was read directly from the meter and cable loss connection was added to the reading to obtain power at the EUT antenna terminal. The EUT Output Power was set to maximum to produce the worse case test result.

10.3 Test Setup Layout

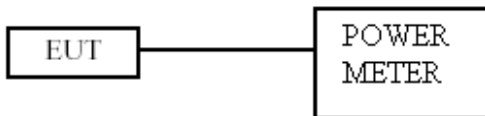

10.4 Test Result and Data

Temperature : 22°C Humidity : 62%
Test Date : Jan. 04, 2019

Modulation Mode	CH	Frequency (MHz)	Conducted(AV) output power (dBm)	Total AV power (dBm)	Total AV power (mW)	Powe Limit (dBm)
			ANT A			
802.11g	01	2412	4.03	4.03	2.529	30.00
	06	2437	3.95	3.95	2.483	30.00
	11	2462	4.01	4.01	2.518	30.00
802.11n HT20	01	2412	4.06	4.06	2.547	30.00
	06	2437	3.96	3.96	2.489	30.00
	11	2462	4.03	4.03	2.529	30.00



11. Power Spectral Density

11.1 Test Limit

The Maximum of Power Spectral Density Measurement is 8dBm.

If transmitting antennas of directional gain greater than 6 dBi are used, the power spectral density shall be reduced by the amount in dB that the directional gain of the antenna exceeds 6 dBi

11.2 Test Procedures

- a. The transmitter output was connected to spectrum analyzer.
- b. The spectrum analyzer’s resolution bandwidth were set at 3kHz RBW and 30KHz VBW as that of the fundamental frequency. Set the sweep time=auto couple.
- c. The power spectral density was measured and recorded.

11.3 Test Setup Layout

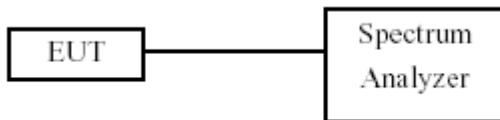

11.4 Test Result and Data

Temperature : 22°C

Humidity : 62%

Test Date : Jan. 04, 2019

Modulation Type	Channel	Frequency (MHz)	Maximum Power Density of 10KHz Bandwidth(dBm)	Sum chain (dBm)	Duty Cycle CF(dB)	Total PSD (dBm)	Limit (dBm)
			ANT A				
802.11g	01	2412	-27.81	-27.81	0.00	-27.81	8.00
	06	2437	-27.43	-27.43	0.00	-27.43	8.00
	11	2462	-27.11	-27.11	0.00	-27.11	8.00
802.11n HT20	01	2412	-28.24	-28.24	0.00	-28.24	8.00
	06	2437	-28.09	-28.09	0.00	-28.09	8.00
	11	2462	-27.81	-27.81	0.00	-27.81	8.00



Modulation Type: 802.11g
CH01

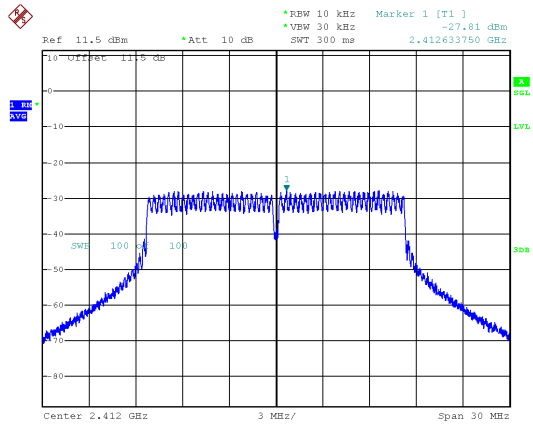

Modulation Type: 802.11n HT20
CH01

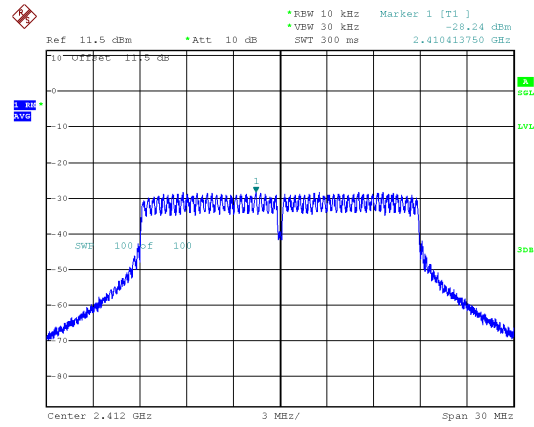

CH06

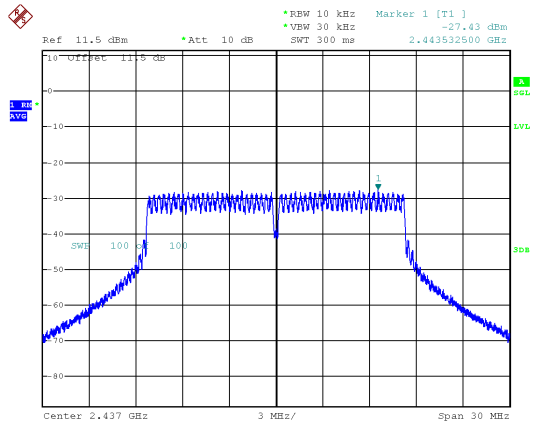

CH06

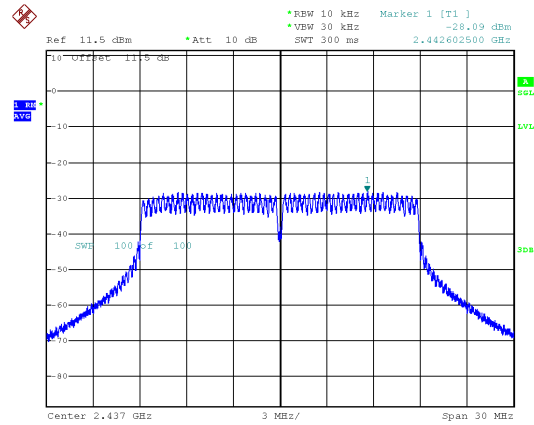

CH11

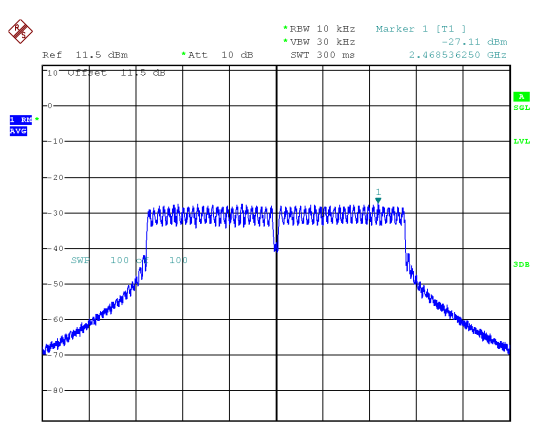

CH11

