

# ARCTIS 3

BLUETOOTH®

PRODUCT INFORMATION GUIDE



## CONTENTS

Welcome	2
SteelSeries Engine	3
Product overview	5–6
Setup	7–8
Microphone	9
Bluetooth	10
Ski goggle headband	11
Translations	
Español	12
简体中文	14
繁體中文	16
日本語	18
한국어	20
Deutsch	23
Русский	25
Français	27
Italiano	30
Português	32
Regulatory	35

## WELCOME TO ARCTIS

Your new headset is the result of more than 15 years of gaming expertise and our unyielding pursuit of perfection. We poured our hearts into making your new Arctis, giving it the best gaming mic available, 7.1 surround sound and comfort and style unlike anything you've experienced before.



## STEELSERIES ENGINE

find help at [support.steelseries.com](https://support.steelseries.com)

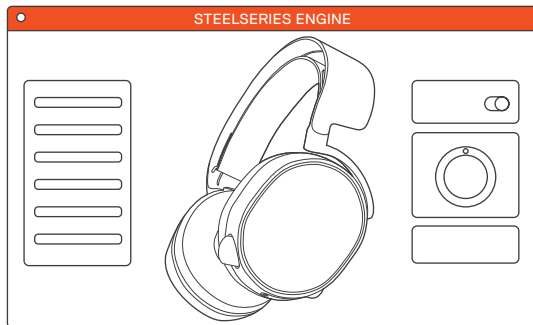

Download SteelSeries Engine to enjoy **7.1 surround sound** and to customize your EQ and mic settings.

[steelseries.com/engine](https://steelseries.com/engine)

### PACKAGE CONTENTS

Headset

Main cable (1.2 m)

Dual 3.5 mm extension (1.8 m)

4-pole 3.5 mm adapter

Micro USB charging cable

Product information guide

### SYSTEM REQUIREMENTS // COMPATIBILITY

PC / Mac

PS4 / Switch / Xbox One

Mobile

### STEELSERIES ENGINE SOFTWARE REQUIREMENTS

Platforms \*

Windows 7 – Windows 10

Mac OS X 10.8 – 10.11

120 MB of free hard drive space for installation

\* SteelSeries 7.1 Surround available on Windows only

## PRODUCT OVERVIEW

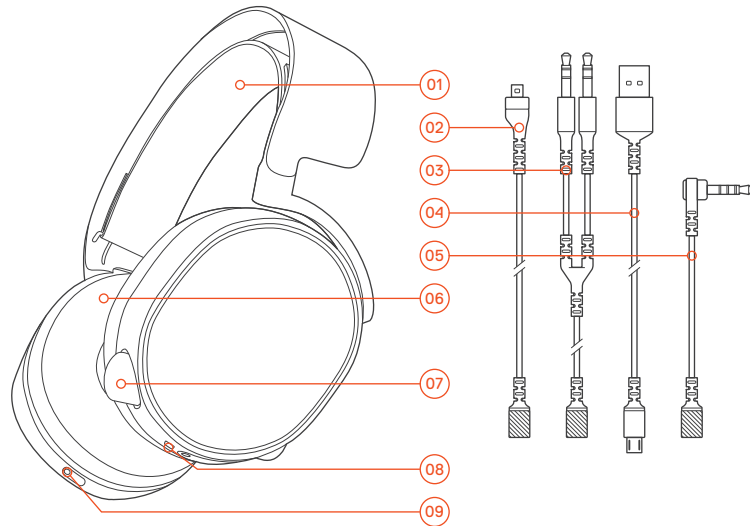

\* Find accessories and replacement parts at [steelseries.com](https://steelseries.com)

- 01 Ski goggle headband \*
- 02 Main headset cable \*
- 03 Dual 3.5 mm 'Y' extension cable \*
- 04 4-pole 3.5 mm adapter \*
- 05 Micro USB charging cable \*
- 06 Breathable moisture-wicking ear cushions \*
- 07 Retractable microphone
- 08 USB charging port
- 09 Power button
- 10 Microphone mute button
- 11 Volume control
- 12 Main cable jack
- 13 Headphone share jack

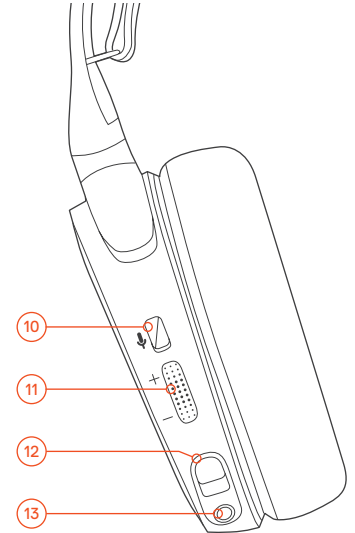

## SETUP

find help at [support.steelseries.com](https://support.steelseries.com)

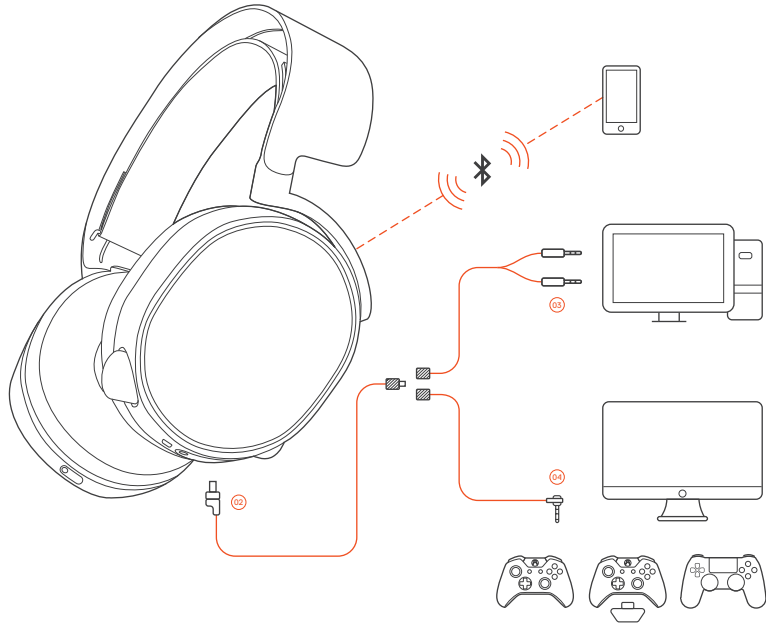

## NINTENDO SWITCH

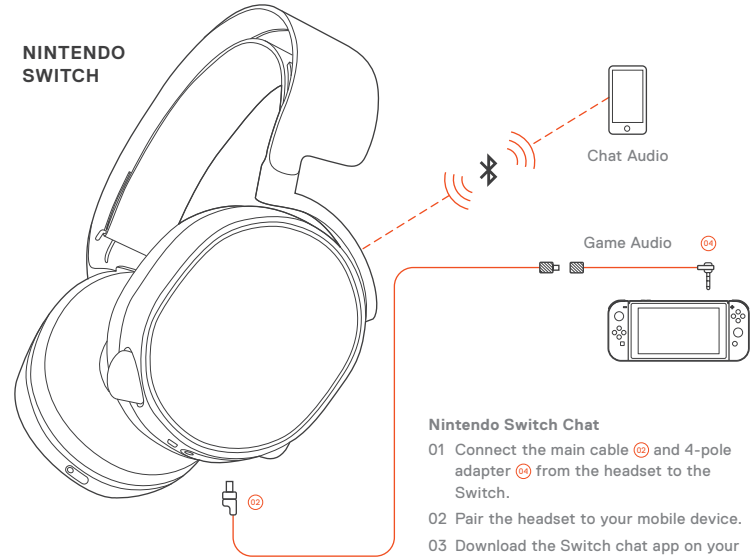

### Nintendo Switch Chat

- 01 Connect the main cable (02) and 4-pole adapter (04) from the headset to the Switch.
- 02 Pair the headset to your mobile device.
- 03 Download the Switch chat app on your mobile device.
- 04 Game and chat audio will be mixed together in the headset.

## MICROPHONE

Retractable microphone

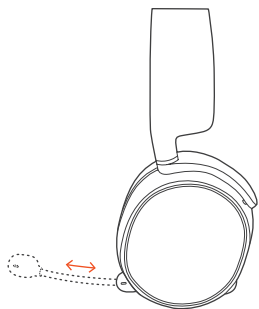



top view

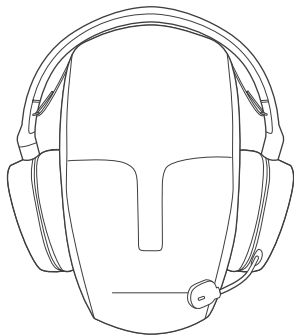

front view

Positioning



Position the microphone  close to the corner of your mouth with the flat surface facing you.



## BLUETOOTH



### PAIRING

With headset off, press and hold the power button  for 6 seconds (power LED will blink rapidly).

On your mobile device scan for Bluetooth headsets and select Arctis 3 Bluetooth.

### CONTROL

 ANSWER/END VOICE CALL  
single • press the power button 

 PLAY/PAUSE MUSIC  
single • press the power button 

 SKIP TRACK  
double • • press power button 

### CHARGING

The power button  color indicates your battery level:

Green	100 – 50 %
Yellow	49 – 20 %
Red	19 – 10 %
Red (fast blink)	9 – 1 %

To charge the headset connect the micro USB charging cable  from the headset to a PC or any USB power source.

## SKI GOGGLE HEADBAND

accessory headbands available at [steelseries.com](https://steelseries.com)

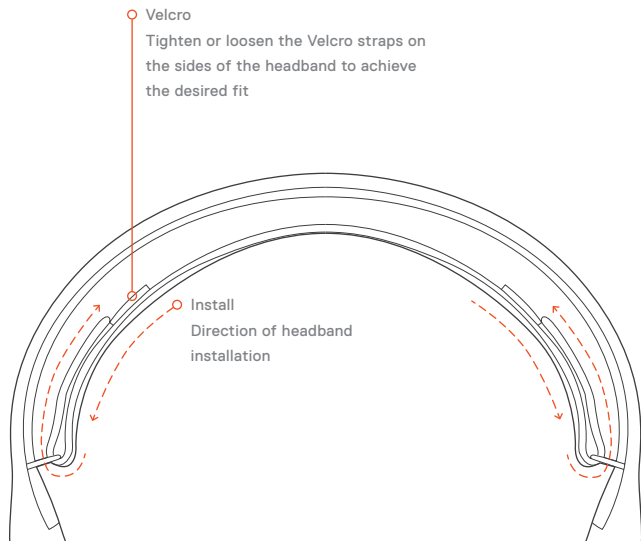

## ESPAÑOL

### Contenido del paquete

Auriculares

Cable principal (1,2m)

Cable de doble extensión de 3,5mm (1,8m)

Adaptador de 3,5mm y 4 polos

Cable cargador micro USB

Guía de información del producto

### Requisitos del sistema // Compatibilidad

PC / Mac

PS4 / Switch / Xbox One

Teléfono móvil

### Requisitos del software SteelSeries Engine

Plataformas: \*

Windows 7 – Windows 10

Mac OS X 10.8 – 10.11

120MB de espacio libre en el disco duro para la instalación

\* SteelSeries 7.1 Surround disponible solo en Windows



solicite ayuda en [support.steelseries.com](https://support.steelseries.com)

### DESCRIPCIÓN GENERAL DEL PRODUCTO

- 01 Cinta para el cabello con gafas de esquí \*
  - 02 Cable principal de los auriculares \*
  - 03 Cable de doble extensión en "Y" de 3,5mm \*
  - 04 Adaptador de 3,5 mm y 4 polos \*
  - 05 Cable cargador micro USB \*
  - 06 Almohadillas respirables que exteriorizan la humedad \*
  - 07 Micrófono retráctil
  - 08 Puerto de carga USB
  - 09 Botón de encendido
  - 10 Botón de silenciar el micrófono
  - 11 Control del volumen
  - 12 Conector del cable principal
  - 13 Conector para compartir auriculares
- \* Encuentre accesorios y repuestos en [steelseries.com](https://steelseries.com)

## CONFIGURACIÓN

### Chat de Nintendo Switch

- 01 Conecte el cable principal  y el adaptador de 4 polos  de los auriculares al Switch.
- 02 Empareje los auriculares con su dispositivo móvil.
- 03 Descargue la aplicación de chat de Switch en su dispositivo móvil.
- 04 El audio del juego y del chat se combinarán en los auriculares.

Audio de chat

Audio de juego

solicite ayuda en [support.steelseries.com](https://support.steelseries.com)

## MICRÓFONO

Micrófono retráctil

Posicionamiento

vista superior

vista frontal

Coloque el micrófono  cerca de la esquina de su boca con la superficie plana hacia su rostro.

## BLUETOOTH

### Cómo aparear

Con los auriculares apagados, presione sin soltar el botón de encendido  durante 6 segundos (la luz LED de encendido destellará rápidamente).

En su dispositivo móvil, active la búsqueda de auriculares Bluetooth y seleccione Arctis 3 Bluetooth.

### Control

 Responder/Terminar llamada de voz  
presione una vez el botón de encendido 

 Reproducir/Pausar música  
presione una vez el botón de encendido 

 Saltar pista  
presione dos veces el botón de encendido 

### Carga

El color del botón de encendido  indica el nivel de batería:

Verde	100 – 50 %
Amarillo	49 – 20 %
Rojo	19 – 10 %
Rojo (destello rápido)	9 – 1 %

Para cargar los auriculares, conecte el cable cargador micro USB  de los auriculares a una PC o a cualquier fuente de energía USB.

## CINTA PARA EL CABELLO CON GAFAS DE ESQUÍ

Velcro

Apriete o afloje las tiras de velcro de los laterales de la cinta para lograr el ajuste deseado

## 简体中文

### 包装内容

头戴式耳机

主线缆 (1.2m)

双 3.5mm 延长线 (1.8m)

4-针 3.5mm 适配器

Micro USB 充电线

产品信息指南

### 系统要求/兼容性

PC / Mac /

PS4 / Switch / Xbox One

移动设备

Instalar

Instrucción para instalar la cinta para cabello

Cintas para cabello complementarias disponibles en [steelseries.com](https://steelseries.com)

### SteelSeries Engine 软件配置要求

平台: \*

Windows 7 – Windows 10

Mac OS X 10.8 – 10.11

120 MB 可用硬盘空间用于安装

\* SteelSeries 7.1 Surround 仅在 Windows 上可用

请在 [support.steelseries.com](https://support.steelseries.com) 上寻求帮助

### 产品概述

01 滑雪护目镜头带 \*

02 主耳机线缆 \*

03 双 3.5 mm ‘Y’ 形延长线 \*

04 4-针 3.5 mm 适配器 \*

05 Micro USB 充电线 \*

06 透气吸湿耳垫 \*



07 可伸缩麦克风

08 USB充电端口

09 电源按钮

10 麦克风静音按钮

11 音量控制

12 主线缆插孔

13 耳机共享插孔

\* 请在[steelseries.com](https://steelseries.com)上寻找配件和更换零件

## 设置

### Nintendo Switch聊天

01 将耳机的主线缆<sup>Ⓜ</sup>和4-适配器<sup>Ⓜ</sup>连接到Switch。

02 将耳机与您的移动设备配对。

03 在移动设备上下载Switch聊天应用程序。

04 游戏和聊天音频即在耳机中混音。

聊天音频

游戏音频

请到[support.steelseries.com](https://support.steelseries.com)上寻求帮助

## 麦克风

伸缩麦克风

定位

顶视图

正面视图

将麦克风<sup>Ⓜ</sup>定位于接近您的嘴角处，平面朝内。

## BLUETOOTH

### 配对

关闭耳机，按住电源按钮<sup>Ⓜ</sup> 6秒（电源指示灯即速闪烁）。

在您的移动设备上扫描Bluetooth耳机，然后选择Arctis 3 Bluetooth。

### 控制

📞 应答/结束语音通话  
单按电源按钮<sup>Ⓜ</sup>

||▶ 播放/暂停音乐  
单按电源按钮<sup>Ⓜ</sup>

▶▶ 跳过音轨  
双按电源按钮<sup>Ⓜ</sup>

## 充电

电源按钮<sup>Ⓜ</sup>颜色表示您的电池电量：

绿色 100 – 50 %

黄色 49 – 20 %

红色 19 – 10 %

红色（快速闪烁） 9 – 1 %

要为耳机充电，请将micro USB充电线<sup>Ⓜ</sup>从耳机连接到PC或任何USB电源。

## 繁體中文

### 内容物

头戴式耳機

主要連接線 (1.2公尺)

雙3.5mm延長線 (1.8公尺)

4節3.5mm轉接頭

Micro USB 充電線

產品資訊指南

### 系統需求 // 相容性

PC / Mac /

PS4 / Switch / Xbox One

行動裝置

## 滑雪护目镜头带

魔术贴

拉紧或放松头带两侧的魔术贴，以获得理想的松紧度

安装

头带安装方向

头带附件可在[steelseries.com](https://steelseries.com)购买

### SteelSeries Engine 軟體需求

平台: \*

Windows 7 – Windows 10

Mac OS X 10.8 – 10.11

120 MB 的硬碟空間

\* SteelSeries 7.1聲道環繞音效僅能於Windows平台使用

您可在[support.steelseries.com](https://support.steelseries.com)獲得更多協助

### 產品概覽

01 雪鏡頭帶\*

02 主要耳機線\*

03 雙3.5mm Y型延長線\*

04 4節 3.5mm 轉接頭\*

05 Micro USB 充電線\*

06 透氣吸汗的耳罩設計\*

07 伸縮麥克風

08 USB 充電接口

09 電源開關

10 麥克風靜音按鈕

11 音量控制

12 主連接線接頭

13 耳機分享接頭

\*可在 [steelseries.com](https://steelseries.com) 購買配件與替換品

## 設定

### Nintendo Switch 語音

01 將主要連接線(🔌)以及4節 3.5mm 轉接頭(🔌)從耳機連接到Switch。

02 將耳機跟行動裝置配對。

03 在行動裝置上下載Switch的語音聊天程式。

03 遊戲與聊天音效會在耳機中混合。

聊天音效

遊戲音效

您可在[support.steelseries.com](https://support.steelseries.com)獲得更多協助

## 麥克風

伸縮麥克風

調整位置

俯視圖

正視圖

將麥克風(🎤)的位置調整至嘴的中央，並將平面一側面對自己。

## 藍芽

### 配對

關閉耳機的電源，將電源開關(🔌)按住6秒（電源LED燈會快速閃爍）

在您的行動裝置上，掃描藍芽耳機，並選擇Arctis 3 Bluetooth。

### 操作

📞 接/掛電話  
按一下電源鈕(🔌)

⏮ 播放/暫停音樂  
按一下電源鈕(🔌)

⏭ 播放下一首歌曲  
按兩下電源鈕(🔌)

## 充電

電源鈕(🔌)會顯示電池的電量：

綠色 100 – 50%

黃色 49 – 20%

紅色 19 – 10%

紅色（快速閃爍） 9 – 1%

充電時，請將用 USB 充電線將耳機連接至電腦或

其他USB電源。

## 日本語

### パッケージの内容

ヘッドセット

メインケーブル (1.2m)

デュアル 3.5mm 延長ケーブル (1.8m)

4極 3.5mm アダプタ

Micro USB 充電ケーブル

製品情報ガイド

### システム要件 // 互換性

PC / Mac /

PS4 / Switch / Xbox One

モバイル

## 雪鏡頭帶

魔鬼沾

請將頭帶兩邊魔鬼沾的鬆緊度調整至適合您的鬆緊度。

安裝

頭帶安裝方向

其他款式頭帶可於 [steelseries.com](https://steelseries.com) 購買

## SteelSeries Engine ソフトウェア要件

プラットフォーム: \*

Windows 7 – Windows 10

Mac OS X 10.8 – 10.11

インストールに120 MBの空き容量が必要

\*SteelSeries 7.1 Surround は Windows でのみご利用いただけます

ご不明な点は [support.steelseries.com](https://support.steelseries.com) のヘルプをご覧ください

## 製品概要

01 スキーゴーグル ヘッドバンド \*

02 メインケーブル \*

03 デュアル 3.5mm Y字型延長ケーブル

04 4極 3.5mm アダプタ\*

05 Micro USB 充電ケーブル\*

06 通気性モイスチャーウィッキング イヤークッション\*

07 リトラクタブルマイク

08 USB 充電ポート

09 電源ボタン

10 マイク消音ボタン

11 音量コントロール

12 メインケーブルジャック

13 ヘッドフォン共有ジャック

\* [steelseries.com](http://steelseries.com) でアクセサリおよび交換用の部品をお求めいただけます

## 設定

### Nintendo Switch チャット

01 ヘッドセットのメインケーブル (M) と4極アダプタ (A) を Switch に接続します。

02 ヘッドセットとモバイルデバイスをペアリングします。

03 ご利用のモバイルデバイスで、Switch チャットのアプリをダウンロードします。

04 ゲームオーディオとチャットオーディオは、ヘッドセットと一緒に聞こえます。

チャットオーディオ

ゲームオーディオ

ご不明な点は [support.steelseries.com](http://support.steelseries.com) のヘルプをご覧ください

## マイク

リトラクタブルマイク

ポジションング

上から見た図

正面から見た図

マイク (M) の位置は、平らな面が口の端に来るように調節してください。

## BLUETOOTH

ペアリング

ヘッドセットの電源を切った状態で、電源ボタン (M) を6秒間長押しします (電源のLEDが点滅します)。

ご利用のモバイルデバイスで Bluetooth ヘッドセットを探します。見つかったら Arctis 3 Bluetooth を選択します。

## コントロール

📞 音声コールに入る / 終了する  
電源ボタン (M) を1度だけ押す

▶▶ 音楽を再生する / 停止する  
電源ボタン (M) を1度だけ押す

▶▶▶ トラックをスキップする  
電源ボタン (M) を2度続けて押す

## 充電

充電残量は電源ボタン (M) の色で判断できます。

緑色 100-50%

黄色 49-20%

赤 19-10%

赤 (点滅) 9-1%

## 한국어

### 패키지 구성

헤드셋

데인 케이블(1.2m)

듀얼 3.5mm 확장 케이블(1.8m)

4극 3.5mm 어댑터

Micro USB 충전 케이블

제품 정보 가이드

ヘッドセットを充電するには、ヘッドセットの Micro USB 充電ケーブル (M) をPCなどのUSB電源ソースに差し込みます。

## 스키어-구어글 헤드밴드

면파아스너

ヘッドバンド 両側のストラップの面ファスナーを調整し、きつすぎず緩すぎない、丁度いい装着感になるようにしてください。

인스톨

ヘッドバンドの取り付け方法の説明です

アクセサリヘッドバンドをお求めの場合は [steelseries.com](http://steelseries.com) をご覧ください

### 필요 시스템 사양 // 호환 시스템

PC / Mac /

PS4 / Switch / Xbox One

모바일

### SteelSeries Engine 소프트웨어 필요 사용

플랫폼: \*

Windows 7 - Windows 10

Mac OS X 10.8 - 10.11

설치를 위해 120MB의 하드 드라이브 공간 필요

\* SteelSeries 7.1 Surround는 Windows만 지원

고객 지원은 [support.steelseries.com](http://support.steelseries.com)을 방문하세요

### 제품 개요

- 01 스키 고글 헤드밴드 \*
- 02 메인 헤드셋 케이블 \*
- 03 듀얼 3.5mm Y형 확장 케이블 \*
- 04 4극 3.5mm 어댑터 \*
- 05 Micro USB 충전 케이블 \*
- 06 통기성 좋고 습기를 빨아들이는 이어 쿠션 \*
- 07 접이식 마이크
- 08 USB 충전 포트
- 09 전원 버튼
- 10 마이크 음소거 버튼
- 11 볼륨 조절
- 12 메인 케이블 잭
- 13 헤드폰 공유 잭

\* 보조장치와 교체용 부품은 [steelseries.com](http://steelseries.com)에서 구할 수 있습니다

### 설치

#### Nintendo Switch 채팅

- 01 헤드셋의 메인 케이블(㉔)과 4극 어댑터(㉕)를 Switch에 연결하세요.
- 02 헤드셋을 모바일 기기와 페어링하세요.
- 03 모바일 기기에서 Switch 채팅 앱을 다운로드하세요.
- 04 게임과 채팅 오디오가 헤드셋에서 같이 믹스됩니다.

채팅 오디오

게임 오디오

고객 지원은 [support.steelseries.com](http://support.steelseries.com)을 방문하세요.

#### 마이크

접이식 마이크

위치 조절

상면도

정면도

마이크(㉔)의 납작한 표면이 얼굴을 향하도록 입가 근처로 위치 조절하십시오.

### BLUETOOTH

#### 페어링

헤드셋 전원이 꺼진 채로, 6초 동안 전원 버튼(㉔)을 누르십시오(전원 LED 빛이 빠르게 깜박입니다).

모바일 기기에서 Bluetooth 헤드셋 찾기를 실행하고 Arctis 3 Bluetooth를 선택하십시오.

#### 제어

☎ 음성 통화에 응답하기/끊기  
전원 버튼(㉔) 한 번 누르기

▶▶ 음악 재생/중지  
전원 버튼(㉔) 한 번 누르기

▶▶ 트랙 건너뛰기  
전원 버튼(㉔) 두 번 누르기

### 충전

전원 버튼(㉔)의 색깔이 배터리 충전도를 나타냅니다:

초록색	100 - 50%
노란색	49 - 20%
빨간색	19 - 10%
(빠르게 깜박이는) 빨간색	9 - 1%

헤드셋을 충전하려면 Micro USB 충전 케이블(㉔)로 헤드셋을 PC나 아무 USB 전원과 연결시키면 됩니다.

#### 스키 고글 헤드밴드

벨크로 헤드셋 측면의 벨크로 띠의 부착을 조절하여 적절히 착용

장착 헤드밴드 장착 방향

보조 헤드밴드는 [steelseries.com](http://steelseries.com)에서 구하실 수 있습니다

## DEUTSCH

### Paketinhalt

Headset  
Netz kabel (1,2 m)  
Doppelverlängerungskabel (3,5 mm/1,8 m)  
4-poliger Adapter (3,5 mm)  
Micro-USB-Ladekabel  
Produktinformationen

### Systemanforderungen // Kompatibilität

PC / Mac  
PS4 / Switch / Xbox One  
Mobilgeräte

### Softwareanforderungen für die SteelSeries Engine

Plattformen: \*  
Windows 7 – Windows 10  
Mac OS X 10.8 – 10.11

120 MB freier Speicherplatz für die Installation

\* SteelSeries 7.1 Surround ist nur für Windows erhältlich

Hilfe unter [support.steelseries.com](http://support.steelseries.com)



### PRODUKTÜBERSICHT

- 01 Skibrillen-Kopfbügel \*
- 02 Netz kabel für das Headset \*
- 03 Y-Doppelverlängerungskabel (3,5 mm) \*
- 04 4-poliger Adapter (3,5 mm) \*
- 05 Micro-USB-Ladekabel \*
- 06 Atmungsaktive und feuchtigkeitsabführende Ohrpolster \*
- 07 Versenkbares Mikrofon
- 08 USB-Ladeanschluss
- 09 An-/Ausschalter
- 10 Mikrofonstummschalter
- 11 Lautstärkeregelung
- 12 Netz kabel-Buchse
- 13 Headphone-Buchse zum Teilen

\* Accessoires und Ersatzteile findest du unter [steelseries.com](http://steelseries.com)

## AUFBAU

### Nintendo Switch Chat

- 01 Verbinde das Netz kabel  und den 4-poligen Adapter  vom Headset mit Switch.
- 02 Verbinde das Headset mit deinem Mobilgerät.
- 03 Lade die Chat-App Switch auf dein Mobilgerät herunter.
- 04 Spiel- und Chat-Audio werden im Headset nun gemischt.

Chat-Audio

Spiel-Audio

Hilfe unter [support.steelseries.com](http://support.steelseries.com)

### MIKROFON

Vsenkbares Mikrofon

Positionierung

Draufsicht

Frontalansicht

Positioniere das Mikrofon  nahe an deinem Mundwinkel so, dass die flache Seite zu dir zeigt.







## BLUETOOTH

### Koppelung

Drücke und halte den An-/Ausschalter  bei ausgeschaltetem Headset 6 Sekunden lang (die Power-LED blinkt schnell).

Suche auf deinem Mobilgerät nach Bluetooth-Headsets und wähle Arctis 3 Bluetooth.

### Steuerung

-  Anruf annehmen/beenden  
Drücke einmal auf den An-/Ausschalter .
-  Musik abspielen/Pause  
Drücke einmal auf den An-/Ausschalter .
-  Track überspringen  
Drücke zweimal auf den An-/Ausschalter .

### Laden

Die Farbe des An-/Ausschalters  zeigt dir den Akkustand an:

Grün	100 – 50 %
Gelb	49 – 20 %
Rot	19 – 10 %
Rot (schnelles Blinken)	9 – 1 %

Verbinde zum Aufladen des Headsets das Micro-USB-Ladekabel  des Headsets mit einem PC oder einer anderen USB-Stromversorgung.

## SKIBRILLEN-KOPFBÜGEL

Klettverschluss

Ziеhе dіа Klettбänder an dеn Sеіtеn dеs Kоpfbügelѕ fеѕt оdеr lосkеrе ѕіе, um еіnе оptіmаlе Pаѕѕfоrm zu еrreісhеn.

## РУССКИЙ

### Содержимое упаковки

Наушники

Основной кабель (1,2 м)

Двойной удлинитель на 3,5 мм (1,8 м)

4-контактный переходник на 3,5 мм

Зарядный кабель микро-USB

Руководство по эксплуатации

### Системные требования // Совместимость

ПК / Mac

PS4 / Switch / Xbox One

Мобильные устройства

Montage

Montage-Richtung der Klettбänder

Zusatzklettбänder erhältlich unter [steelseries.com](https://steelseries.com)

### Системные требования ПО SteelSeries Engine

Платформы: \*

Windows 7 – Windows 10

Mac OS X 10.8 – 10.11

120 МБ свободного места на жёстком диске для установки

\* Функция SteelSeries 7.1 Surround работает только на ОС Windows

За помощью обращайтесь по адресу [support.steelseries.com](https://support.steelseries.com)

### ОБ ИЗДЕЛИИ

01 Оголовье, как у лыжных очков \*

02 Основной кабель \*

03 Двойной Y-удлинитель на 3,5 мм \*

04 4-контактный переходник на 3,5 мм \*

05 Зарядный кабель микро-USB \*

06 Дышащие амбушюры из впитывающей ткани \*

07 Выдвижной микрофон

08 USB-порт для зарядки

09 Кнопка включения

10 Кнопка отключения микрофона

11 Регулятор громкости



12 Гнездо для основного кабеля

13 Гнездо для вторых наушников

\* Аксессуары и запчасти можно купить на сайте [steelseries.com](https://steelseries.com)

### УСТАНОВКА

#### Чат Nintendo Switch

01 Подключите основной кабель  и 4-контактный адаптер  от наушников к игровой системе Switch.

02 Подключите наушники к мобильному устройству.

03 Установите на мобильное устройство приложение для чата Switch.

04 В наушниках будет одновременно слышен звук игры и звук чата.

Звук чата

Звук игры

За помощью обращайтесь по адресу [support.steelseries.com](https://support.steelseries.com)

### МИКРОФОН

Выдвижной микрофон

Позиционирование

вид сверху

вид спереди

Расположите микрофон  возле угла рта, плоской стороной к себе.



### BLUETOOTH



#### Подключение

Отключите наушники и нажмите кнопку включения  на 6 секунд (светодиод начнёт быстро мигать).

Найдите наушники Bluetooth мобильным устройством и выберите Arctis 3 Bluetooth.

#### Управление

 Принять/закончить звонок  
нажмите на кнопку включения  один раз

 Играть/остановить музыку  
нажмите на кнопку включения  один раз

▶ Пропустить композицию  
нажмите на кнопку включения  дважды

### Зарядка

Цвет кнопки включения  означает уровень заряда батареи:

зелёный	100 – 50 %
жёлтый	49 – 20 %
красный	19 – 10 %
красный (быстро мигает)	9 – 1 %

Чтобы зарядить наушники, подключите

## FRANÇAIS

### Contenu de l'emballage

Casque

Câble principal (1,2 m)

Double rallonge 3,5 mm (1,8 m)

Adaptateur 4 pôles 3,5 mm

Câble de chargement micro-USB

Guide d'informations produit

зарядный кабель микро-USB  от наушников к ПК или иному источнику энергии с портом USB.

### ЛЫЖНОЕ ОГОЛОВЬЕ НАУШНИКОВ

Липучка

С помощью липучек по бокам можно изменить размер оголовья

Присоединение

Направление присоединения наушников

Дополнительные оголовья можно купить на сайте [steelseries.com](https://steelseries.com)

### Configuration requise // Compatibilité

PC / Mac

PS4 / Switch / Xbox One

Mobile

### Configuration requise pour le logiciel SteelSeries Engine

Plateformes : \*

Windows 7 – Windows 10

Mac OS X 10.8 – 10.11

120 Mo d'espace libre sur le disque dur pour l'installation

\* SteelSeries 7.1 Surround disponible uniquement pour Windows

aide disponible à l'adresse [support.steelseries.com](https://support.steelseries.com)

### VUE D'ENSEMBLE DU PRODUIT

01 serre-tête de masque de ski \*

02 Câble principal du casque \*

03 Double rallonge 3,5 mm en Y \*

04 Adaptateur 4 pôles 3,5 mm \*

05 Câble de chargement micro-USB \*

06 Coussinets d'oreille en tissu respirant évacuant l'humidité \*

07 Micro rétractable

08 Port de chargement USB

09 Bouton marche/arrêt

10 Bouton de mise en sourdine du micro

11 Contrôle du volume

12 Prise du câble principal

13 Prise partage casque audio

\* Accessoires et pièces de rechange disponibles à l'adresse [steelseries.com](https://steelseries.com)

### INSTALLATION

#### ChatNintendo Switch

01 Relevez le câble principal  et l'adaptateur 4 pôles  du casque à la Switch.

02 Apparez le casque avec votre appareil mobile.

03 Téléchargez l'appli de chat Switch sur votre appareil mobile.

04 L'audio de jeu et du chat seront mixés dans le casque.

Audio de chat

Audio de jeu

aide disponible à l'adresse [support.steelseries.com](https://support.steelseries.com)

#### MICROPHONE

Micro rétractable

Positionnement

vue de dessus

vue de devant

Placez le micro  près du coin de votre bouche avec la surface plate vous faisant face.

## BLUETOOTH

### Appairage

Avec le casque éteint, maintenez le bouton marche/arrêt (09) appuyé pendant 6 secondes (le LED d'alimentation se mettra à clignoter rapidement).

Recherchez les casques Bluetooth sur votre appareil mobile et sélectionnez Arctis 3 Bluetooth.

### Commandes

☎ Répondre/Mettre fin à un appel vocal  
appuyer une fois sur le bouton marche/arrêt (09)

▶ Lecture/Pause de musique  
appuyer une fois sur le bouton marche/arrêt (09)

▶▶ Passer au morceau suivant  
appuyer deux fois sur le bouton marche/arrêt (09)

## Chargement

La couleur du bouton marche/arrêt (09) indique le niveau de la batterie :

Vert	100 – 50 %
Jaune	49 – 20 %
Rouge	19 – 10 %
Rouge (clignotement rapide)	9 – 1 %

Pour charger le casque, reliez le câble de chargement micro-USB (06) du casque à un PC ou à n'importe quelle source d'alimentation USB.

## SERRE-TÊTE DE MASQUE DE SKI

Velcro  
Serrez ou desserrez les lanières en Velcro sur les côtés du serre-tête pour un ajustement optimal

Installation  
Sens de l'installation du serre-tête

Serre-tête accessoires disponibles à l'adresse  
[steelseries.com](https://steelseries.com)

## ITALIANO

### Contenuto del pacchetto

Cuffie  
Cavo principale (1,2 m)  
Cavo di prolunga doppio da 3,5 mm (1,8 m)  
Adattatore da 3,5 mm 4 poli  
Cavo micro USB per ricarica  
Guida informazioni sul prodotto

### Requisiti di sistema // Compatibilità

PC / Mac  
PS4 / Switch / Xbox One  
Dispositivo mobile

### Requisiti del software SteelSeries Engine

Piattaforme: \*  
Windows 7 – Windows 10  
Mac OS X 10.8 – 10.11

120 MB di spazio libero sul disco fisso per l'installazione

\* SteelSeries 7.1 Surround disponibile solo su Windows

per ricevere assistenza, visita [support.steelseries.com](https://support.steelseries.com)

### PANORAMICA DEL PRODOTTO



- 01 Archetto stile occhiali da sci \*
- 02 Cavo principale delle cuffie \*
- 03 Cavo di prolunga a "Y" da 3,5 mm \*
- 04 Adattatore da 3,5 mm 4 poli \*
- 05 Cavo micro USB per ricarica \*
- 06 Cuscinetti auricolari in materiale traspirante \*
- 07 Microfono retrattile
- 08 Presa USB di ricarica
- 09 Tasto Power
- 10 Pulsante microfono muto
- 11 Regolazione del volume
- 12 Ingresso cavo principale
- 13 Splitter per cuffie

\* Puoi trovare accessori e parti di ricambio su [steelseries.com](https://steelseries.com)



## CONFIGURAZIONE

### Chat Nintendo Switch

- 01 Collega il cavo principale  e l'adattatore 4 poli  delle cuffie a Switch.
- 02 Accoppia le cuffie al tuo dispositivo mobile.
- 03 Scarica l'app della chat di Switch sul tuo dispositivo mobile.
- 04 L'audio di gioco e quello della chat verranno elaborati nelle cuffie.

Audio chat

Audio gioco

per ricevere assistenza, visita [support.steelseries.com](https://support.steelseries.com)

## MICROFONO

Microfono retrattile

Posizionamento

vista dall'alto

vista laterale

Il microfono  va posizionato vicino all'angolo della bocca con la superficie piatta rivolta verso di te.

## BLUETOOTH

### Pairing (accoppiamento)

A cuffie spente, premi e mantieni premuto il tasto Power  per 6 secondi (il LED dell'accensione lampeggerà rapidamente).

Sul tuo dispositivo mobile individua le cuffie Bluetooth e seleziona Arctis 3 Bluetooth.

### Comandi

 Rispondi/Chiudi chiamata vocale premi una volta il tasto Power 

 Riproduci/Interrompi musica premi una volta il tasto Power 

 Salta brano premi due volte il tasto Power 

### Caricamento

Il colore del tasto Power  indica il livello della batteria:

Verde	100 – 50 %
Giallo	49 – 20 %
Rosso	19 – 10 %
Rosso (lampeggiamento veloce)	9 – 1 %

Per ricaricare le cuffie collega il cavo micro USB per la ricarica  dalle cuffie a un PC o a una qualunque altra fonte di alimentazione USB.

## ARCHETTO STILE OCCHIALI DA SCI

Velcro

Stringi o allenta le cinghie di velcro sull'archetto per ottenere la misura desiderata.

## PORTUGUÊS

### Conteúdo da embalagem

Headset

Cabo principal (1,2 m)

Cabo extensor duplo 3,5 mm (1,8 m)

Adaptador de 3,5 mm de 4 hastes

Cabo de energia micro USB

Guia de Informações do produto

### Requisitos do sistema // Compatibilidade

PC / Mac

PS4 / Switch / Xbox One

Dispositivo móvel

### Requisitos do software SteelSeries Engine

Plataformas: \*

Windows 7 – Windows 10

Mac OS X 10.8 – 10.11

Montaggio

Direzione di montaggio dell'archetto

Accessori disponibili su [steelseries.com](https://steelseries.com)

120 MB de espaço livre no disco rígido para a instalação

\* SteelSeries 7.1 Surround disponível somente no Windows

obtenha ajuda em [support.steelseries.com](https://support.steelseries.com)

## VISÃO GERAL DO PRODUTO

01 Faixa de óculos de esqui \*

02 Cabo principal do headset \*

03 Cabo extensor duplo em "Y" de 3,5 mm \*

04 Adaptador de 3,5 mm de 4 hastes \*

05 Cabo de energia micro USB \*

06 Almofadas de orelha respiráveis antiumidade \*

07 Microfone retrátil

08 Entrada de energia USB

09 Botão de ligar

10 Botão de silenciar microfone

11 Controle de volume

12 Entrada do cabo principal

13 Entrada de compartilhar fone

\* Encontre acessórios e peças de reposição em [steelseries.com](https://steelseries.com)

## CONFIGURAÇÃO

### Chat do Nintendo Switch

01 Conecte o cabo principal  e o adaptador de 4 hastes  do headset ao Switch.

02 Pareie o headset com seu dispositivo móvel.

03 Baixe o app de chat do Switch no dispositivo móvel.

04 O áudio do jogo e o áudio do chat serão combinados no headset.

Áudio do chat

Áudio do jogo

obtenha ajuda em [support.steelseries.com](https://support.steelseries.com)

## MICROFONE

Microfone retrátil

Posicionamento

visão superior

visão frontal

Posicione o microfone  perto do canto da boca, com a superfície plana voltada para o rosto.



## BLUETOOTH

### Pareamento

Com o headset desligado, pressione e segure o botão de ligar  por 6 segundos (o LED de energia piscará rapidamente).

No seu dispositivo móvel, procure por headsets Bluetooth e selecione Arctis 3 Bluetooth.

### Controle

 Atender/Encerrar chamada de voz  
pressione uma vez o botão de ligar 

 Reproduzir/Pausar música  
pressione uma vez o botão de ligar 

 Pular faixa  
pressione duas vezes o botão de ligar 

### Carregamento

A cor do botão de ligar  indica o nível da bateria:

Verde 100 – 50 %

Amarelo 49 – 20 %

Vermelho 19 – 10 %

Vermelho (piscando rápido) 9 – 1 %

Para carregar o headset, conecte o cabo de energia micro USB  do headset ao PC ou a qualquer fonte de energia USB.

## FAIXA DE ÓCULOS DE ESQUI

Velcro

Aperte ou solte as faixas de velcro nos lados da faixa para chegar no ponto desejado

Instalação

Direção de instalação da faixa

Faixas disponíveis em [steelseries.com](https://steelseries.com)

## REGULATORY



### Federal Communication Commission Interference Statement

This device complies with Part 15 of the FCC Rules. Operation is subject to the following two conditions: (1) This device may not cause harmful interference, and (2) this device must accept any interference received, including interference that may cause undesired operation.

This equipment has been tested and found to comply with the limits for a Class B digital device, pursuant to Part 15 of the FCC Rules. These limits are designed to provide reasonable protection against harmful interference in a residential installation. This equipment generates, uses and can radiate radio frequency energy and, if not installed and used in accordance with the instructions, may cause harmful interference to radio communications. However, there is no guarantee that interference will not occur in a particular installation. If this equipment does cause harmful interference to radio or television reception, which can be determined by turning the equipment off and on, the user is encouraged to try to correct the interference by one of the following measures:

- Reorient or relocate the receiving antenna.
- Increase the separation between the equipment and receiver.
- Connect the equipment into an outlet on a circuit different from that to which thereceiver is connected.
- Consult the dealer or an experienced radio/TV technician for help.

FCC Caution: Any changes or modifications not expressly approved by the party responsible for compliance could void the user's authority to operate this equipment.

This transmitter must not be co-located or operating in conjunction with any other antenna or transmitter.

Operations in the 5GHz products are restricted to indoor usage only.

### Radiation Exposure Statement:

The device has been evaluated to meet general RF exposure requirement. The device can be used in portable exposure condition without restriction.

### Industry Canada Statement:

This device complies with RSS-210 of the Industry Canada Rules. Operation is subject to the following two

conditions: (1) This device may not cause harmful interference, and (2) this device must accept any interference received, including interference that may cause undesired operation.

Ce dispositif est conforme à la norme CNR-210 d'Industrie Canada applicable aux appareils radio exempts de licence. Son fonctionnement est sujet aux deux conditions suivantes: (1) le dispositif ne doit pas produire de brouillage préjudiciable, et (2) ce dispositif doit accepter tout brouillage reçu, y compris un brouillage susceptible de provoquer un fonctionnement indésirable.

### Radiation Exposure Statement:

The device has been evaluated to meet general RF exposure requirement. The device can be used in portable exposure condition without restriction.

### Déclaration d'exposition aux radiations:

L'appareil a été évalué pour répondre aux exigences générales d'exposition aux radiofréquences. L'appareil peut être utilisé en condition d'exposition portable sans restriction.

This Class B digital apparatus complies with Canadian ICES-003.

Cet appareil numérique de la classe B est conforme à la norme NMB-003 du Canada.

This Class B digital apparatus complies with Canadian ICES-003.

Cet appareil numérique de la classe B est conforme à la norme NMB-003 du Canada.

### Cofetel notice is: (Mexico COFETEL aviso):

"La operación de este equipo está sujeta a las siguientes dos condiciones: (1) es posible que este equipo o dispositivo no cause interferencia perjudicial y (2) este equipo o dispositivo debe aceptar cualquier interferencia, incluyendo la que pueda causar su operación no deseada."

해당 무선설비는 운용 중 전파혼신 가능성이 있음

해당 무선설비는 전파혼신 가능성이 있으므로 인명안전과 관련된 서비스는 할 수 없음

이 기기는 가정용(B급) 전자파적합기로서 주로 가정에서 사용하는 것을 목적으로 하며, 모든 지역에서 사용할 수 있습니다



1. 상호명: SteelSeries ApS.
2. 기기명칭: Headset
3. 모델명: HS-00015
4. 인증번호:MSIP-CMM-SS4-HS-00015
5. 제조사/제조국: SteelSeries ApS./China



この装置は、情報処理装置等電波障害自主規制協議会(VCCI)の基準に基づくクラスB 情報技術装置です。この装置、家庭環境で使用することを目的としていますが、この装置がラジオやテレビジョン受信機に近接して使用されると、受信障害を引き起こすことがあります。取扱説明書に従って正しい取り扱いをしてください。

この機器の使用周波数帯では、電子レンジ等の産業、科学、医療用機器のほか工場の製造ライン等で使用されている移動体識別用の構内無線局（免許を要する無線局）及び特定小電力無線局（免許を要しない無線局）並びにアマチュア無線局（免許を要する無線局）が運用されています。

- 1 この機器を使用する前に、近くで移動体識別用の構内無線局及び特定小電力無線局並びにアマチュア無線局が運用されていないことを確認して下さい。
- 2 万一、この機器から移動体識別用の構内無線局に対して有害な電波干渉の事例が発生した場合には、速やかに使用周波数を変更するか又は電波の発射を停止した上、下記連絡先にご連絡頂き、混信回避のための処置等（例えば、パーティションの設置など）についてご相談して下さい。
- 3 その他、この機器から移動体識別用の特定小電力無線局あるいはアマチュア無線局に対して有害な電波干渉の事例が発生した場合など何かお困りのことが起きたときは、次の連絡先へお問い合わせ下さい。

#### 低功率電波輻射性電機管理辦法

第十二條 經型式認證合格之低功率射頻電機，非經許可，公司、商號或使用者均不得擅自變更頻率、加大功率或變更原設計之特性及功能。

第十四條 低功率射頻電機之使用不得影響飛航安全及干擾合法通信；經發現有干擾現象時，應立即停用，並改善至無干擾時方得繼續使用。前項合法通信，指依電信法規定作業之無線電通信。低功率射頻電機須忍受合法通信或工業、科學及醫療用電波輻射性電機設備之干擾。



#### Safety Guideline for Lithium Battery

Please keep follow all listed important warnings and cautions below while using this battery pack to avoid any damage or hazard.

This battery must not be disposed of with your other household waste or treat them in compliance with the local regulations or contact your local city office, your household waste disposal service or the shop where you purchased the product.

"CAUTION!" Risk of explosion if battery pack is not replace by same type as specified by the manufacturer.

1. The battery polarity (+) and (-) shall not be connected and charged reversely. Risk of explosion if the battery polarity (+) and (-) is reversed.

2. Please keep this battery pack away from fire and high heat sources due to explosion might happen. Do not place your battery pack close to any heater or hot location.

3. This battery pack shall not be hit or impacted. This battery pack shall not be dealt with any sharp or keen objects either.

4. This battery pack shall not be exposed to moisture, dripping or splashing.

5. If any electrolyte flow out of this battery pack when touch the user's eyes and skin, please seek medical advice immediately.



#### Europe – EU Declaration of Conformity

Hereby, SteelSeries ApS. declares that the equipment which is compliance with directive RoHS 2.0 (2015/863/EU), R.E.D (2014/53/EU), EMC Directive (2014/30/EU), and LVD (2014/35/EU) which are issued by the Commission of the European Community.

The full text of the EU declaration of conformity is available at the following internet address: <https://steelseries.com/>

SteelSeries ApS. hereby confirms, to date, based on the feedback from our suppliers indicates that our products shipping to the EU territory comply with REACH (Registration, Evaluation, Authorization, and Restriction of Chemicals - (EC) 1907/2006) compliance program. We are fully committed to offering REACH compliance on the products and posting accurate REACH compliance status for the all of products.



#### WEEE

This product must not be disposed of with your other household waste or treat them in compliance with the local regulations or contact your local city office, your household waste disposal service or the shop where you purchased the product.

Türkiye Cumhuriyeti: EEE Yönetmeliğine Uygundur.

This product is compliant with requirements of Circular No. 30/2011/TT-BCT Regulations "STIPULATING TEMPORARILY THE PERMISSIBLE CONTENT LIMITATION OF SOME TOXIC CHEMICALS IN THE ELECTRONIC, ELECTRICAL PRODUCTS"

**《废弃电器电子产品回收处理管理条例》提示性说明**

为了更好地关爱及保护地球，当用户不再需要此产品或产品寿命终止时，请遵守国家废弃电器电子产品回收处理相关法律法规，将其交给当地具有国家认可的回收处理资质的厂商进行回收处理。



该电子电气产品含有某些有害物质，在环保使用期限内可以放心使用，超过环保使用期限之后则应该进入回收循环系统。



ACMA Compliance (Australia/ New-Zealand)



Direct Current



\*報廢電池請按照廢棄物管理辦法回收處理

廢電池回收

根据中国大陆《电子电气产品有害物质限制使用标识要求》，以下部分列出了产品中可能包含的有害物质的名称和含量：

零部件名称	有害物质					
	铅 (Pb)	汞 (Hg)	镉 (Cd)	六价铬 (Cr(VI))	多溴联苯 (PBB)	多溴二苯醚 (PBDE)
电路板组件	X	○	○	○	○	○
其他线材	X	○	○	○	○	○

\*：电路板组件包括印刷电路板及其构成的零部件，如电阻、电容、集成电路、连接器等。

本表格依据SJ/T 11364的规定编制。

O：表示该有害物质在该部件所有均质材料中的含量均在 GB/T 26572规定的限量要求以下。

X：表示该有害物质至少在该部件的某一均质材料中的含量超出GB/T 26572规定的限量要求；

上表中打“X”的部件，应功能需要，部分有害物质含量超出GB/T 26572规定的限量要求，

但是符合欧盟RoHS法规要求(属于豁免部分)。

Regions	Contact Information	
亞洲	丹麥商賽睿有限公司台灣分公司 23511 新北市中和區建一路150號16樓	+886 2 8226 3858
Asia	SteelSeries ApS. Taiwan Branch 16F, No.150, Jian-Yi Rd., Chung Ho Dist. New Taipei City, Taiwan	+886 2 8226 3858
USA	656 W Randolph St, Suite 3E Chicago, IL 60661, USA	+1 312 258 9467
Europe	Dirch Passers Allé 27, 5.Sal 2000 Frederiksberg, Denmark	+45 702 500 75

Product(產品/产品): Headset (耳機/耳机)

Model No. (型號/型号): HS-00015

Rated (額定值/额定值): 5V , 500mA

Made in China 中國製造/中国制造

Operating Temperature: 0 to +40 °C



learn more at [steelseries.com](https://steelseries.com)