



FCC RADIO TEST REPORT

Applicant : SteelSeries ApS.
Address : 656 W Randolph St., Suite 3E Chicago,
IL 60661, USA
Equipment : Transceiver
Model No. : GC-00005TX
Trade Name : 
FCC ID. : ZHK-GC00005TX

I HEREBY CERTIFY THAT :

The sample was received on Aug. 30, 2018 and the testing was carried out on Nov. 29, 2018 at CerpPASS Technology Corp. The test result refers exclusively to the test presented test model / sample. Without written approval of CerpPASS Technology Corp., the test report shall not be reproduced except in full.

Approved by:

Tested by:

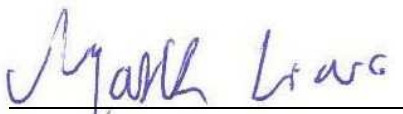
Mark Liao / Assistant Manager

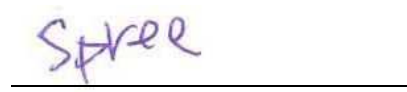
Spree Yei / Engineer

Laboratory Accreditation:

CerpPASS Technology Corporation Test Laboratory





Contents

1. Summary of Test Procedure and Test Results.....	4
1.1. Applicable Standards	4
2. Test Configuration of Equipment under Test.....	5
2.1. Feature of Equipment under Test.....	5
2.2. Carrier Frequency of Channels.....	5
2.3. Test Mode and Test Software.....	6
2.4. Description of Test System.....	6
2.5. General Information of Test.....	7
2.6. Measurement Uncertainty	7
3. Test Equipment and Ancillaries Used for Tests	8
4. Test of Conducted Emission.....	9
4.1. Test Limit	9
4.2. Test Procedures	9
4.3. Typical Test Setup	10
4.4. Test Result and Data	11
4.5. Test Photographs	13
5. Test of Radiated Spurious Emission.....	14
5.1. Test Limit	14
5.2. Test Procedures	15
5.3. Typical Test Setup Layout of Radiated Emission	16
5.4. Test Result and Data	17
5.5. Test Photographs (30MHz ~ 1GHz).....	34
5.6. Test Photographs (1GHz ~ 25GHz).....	35



History of this test report

Report No.	Issue Date	Description
TEFC1807183	Dec. 04, 2018	Original.



1. Summary of Test Procedure and Test Results

1.1. Applicable Standards

ANSI C63.4:2014

ANSI C63.10:2013

FCC Rules and Regulations Part 15 Subpart C §15.249

FCC Rule	Description of Test	Result
15.207	Conducted Emission	PASS
15.209 15.249	Radiated Emission	PASS



2. Test Configuration of Equipment under Test

2.1. Feature of Equipment under Test

Item	Spec.
Frequency Range	2405MHz ~ 2476MHz
Number of Channels	16
Modulation Type	GFSK
Modulation Technology	FHSS
Antenna Type	PCB
Antenna Gain	-1.12 dBi

2.2. Carrier Frequency of Channels

Channel	Frequency (MHz)	Channel	Frequency (MHz)
*01	2405	11	2450
02	2409	12	2455
03	2413	13	2460
04	2417	14	2465
05	2422	15	2470
06	2426	*16	2476
07	2430		
*08	2435		
09	2440		
10	2445		

Note: Channels remarked “*” are selected to perform test.



2.3. Test Mode and Test Software

- a. During testing, the interface cables and equipment positions were varied according to ANSI C63.10.
- b. The complete test system included Notebook and EUT for RF test.
- c. An executive program, "BusHound_v6.0.1" was executed to transmit and receive data.
- c. The test modes of RF test as follow:

Conducted Emissions from the AC mains power ports	
Test Mode	Operating Description
1	TX, CH01
Radiation Fundamental	
Test Mode	Operating Description
1	TX, CH01
2	TX, CH08
3	TX, CH16
Radiation (30MHz ~ 1GHz)	
Test Mode	Operating Description
1	TX, CH01
Radiation (1GHz ~ 25GHz)	
Test Mode	Operating Description
1	TX, CH01
2	TX, CH08
3	TX, CH16

2.4. Description of Test System

Device	Manufacturer	Model No.	Description
Notebook	ASUS	P2430U	Power Cable, Unshielding, 1.8m



2.5. General Information of Test

Test Site	Cerpass Technology Corporation Test Laboratory Address: No.10, Ln. 2, Lianfu St., Luzhu Dist., Taoyuan City 33848, Taiwan (R.O.C.) Tel:+886-3-3226-888 Fax:+886-3-3226-881 Address: No.68-1, Shihbachongsi, Shihding Township, New Taipei City 223, Taiwan, R.O.C. Tel: +886-2-2663-8582	
	FCC	TW1079, TW1061, TW1439
	IC	4934E-1, 4934E-2
	VCCI	T-2205 for Telecommunication Test C-4663 for Conducted emission test R-3428, R-4218 for Radiated emission test G-10812, G-10813 for radiated disturbance above 1GHz
Frequency Range Investigated:	Conducted: from 150kHz to 30 MHz Radiation: from 30 MHz to 25,000MHz	
Test Distance:	The test distance of radiated emission from antenna to EUT is 3 M.	

2.6. Measurement Uncertainty

Measurement Item	Uncertainty
Radiated Spurious Emission(9KHz~30MHz)	±5.007dB
Radiated Spurious Emission(30MHz~1GHz)	±5.157dB
Radiated Spurious Emission(1GHz~18GHz)	±6.383dB
Radiated Spurious Emission(18GHz~40GHz)	±6.648dB
Conducted Spurious Emission	±1.253dB
6dB Bandwidth	±6.89%
Power Spectral Density	±0.630dB
26 dB Occupied Bandwidth	±6.10%
Frequency Stability	±375KHz
Channel Frequencies Separation	±6.10%
20dB Bandwidth	±6.12%
Dwell Time	±1.34%
Peak Output Power(Conducted Power Meter)	±0.86dB
Temperature	±1.2°C
Humidity	±2.7%
Channel Move Time	±4.53%
Channel Closing Transmission Time	±6.61%
Threshold	±0.631dB
Non occupancy period	±1.17%



3. Test Equipment and Ancillaries Used for Tests

<For Conducted Emission Test>

Instrument	Manufacturer	Model No.	Serial No.	Calibration Date	Valid Date
EMI Receiver	R&S	ESCI3	100821	2017/09/08	2018/09/07
LISN	Schwarzbeck	NSLK 8127	8127-568	2018/02/26	2019/02/25
Pulse Limiter	R&S	ESH3-Z2	101934	2018/02/22	2019/02/21
Software	AUDIX	E3	V8.2014-8-6	N/A	N/A

<For Others Test>

Instrument	Manufacturer	Model No.	Serial No.	Calibration Date	Valid Date
EMI Receiver	R&S	ESCI3	100443	2018/03/15	2019/03/14
LISN	Schwarzbeck	NSLK 8127	8127-568	2018/02/26	2019/02/25
Pulse Limiter	R&S	ESH3-Z2	101934	2018/02/22	2019/02/21
Bilog Antenna	Schwarzbeck	VULB9168	275	2018/09/17	2019/09/16
Active Loop Antenna	EMCO	6507	40855	2018/05/22	2019/05/21
Horn Antenna	EMCO	3115	31601	2018/09/26	2019/09/25
Horn Antenna	EMCO	3116	31970	2018/03/23	2019/03/22
Preamplifier	EM	EM330	60660	2018/03/08	2019/03/07
Preamplifier	EMC INSTRUMENTS	EMC051845SE	980333	2018/09/18	2019/09/17
Preamplifier	EMC INSTRUMENTS	EMC184045	980065	2018/10/31	2019/10/30
MXG MW Analog Signal Generator	KEYSIGHT	N5183A	MY50142931	2018/04/10	2019/04/09
Spectrum Analyzer	R&S	FSP40	100219	2018/07/03	2019/07/02
BLUETOOTH TESTER	R&S	CBT	101133	2018/04/02	2019/04/01
Attenuator	KEYSIGHT	8491B	MY39250705	2018/09/04	2019/09/03
Rotary Attenuator	Agilent	8495B	MY42146680	2018/03/29	2019/03/28
Temp & Humi chamber	T-MACHINE	TMJ-9712	T-12-040111	2018/08/30	2019/08/29
Series Power Meter	Anritsu	ML2495A	1224005	2018/03/23	2019/03/22
Power Sensor	Anritsu	MA2411B	1207295	2018/03/23	2019/03/22
Software	Farad	Ez-EMC	ver.ct3a1	N/A	N/A
Software	AUDIX	E3	V8.2014-8-6	N/A	N/A
Software	Keysight	N7607B Signal Studio	V3.0.0.0	N/A	N/A
Software	Keysight	Inservice MonitorUtility	N/A	N/A	N/A



4. Test of Conducted Emission

4.1. Test Limit

Conducted Emissions were measured from 150 kHz to 30 MHz with a bandwidth of 9 KHz, according to the methods defined in ANSI C63.4-2014. The EUT was placed on a nonmetallic stand in a shielded room 0.8 meters above the ground plane. The interface cables and equipment positioning were varied within limits of reasonable applications to determine the position produced maximum conducted emissions.

Frequency (MHz)	Quasi Peak (dB μ V)	Average (dB μ V)
0.15 – 0.5	66-56*	56-46*
0.5 – 5.0	56	46
5.0 – 30.0	60	50

*Decreases with the logarithm of the frequency.

4.2. Test Procedures

- a. The EUT was placed 0.4 meter from the conducting wall of the shielding room was kept at least 80 centimeters from any other grounded conducting surface.
- b. Connect EUT to the power mains through a line impedance stabilization network (LISN).
- c. All the support units are connecting to the other LISN.
- d. The LISN provides 50 ohm coupling impedance for the measuring instrument.
- e. The FCC states that a 50 ohm, 50 micro-Henry LISN should be used.
- f. Both sides of AC line were checked for maximum conducted interference.
- g. The frequency range from 150 kHz to 30 MHz was searched.
- h. Set the test-receiver system to Peak Detect Function and Specified Bandwidth with Maximum Hold Mode.



4.3. Typical Test Setup

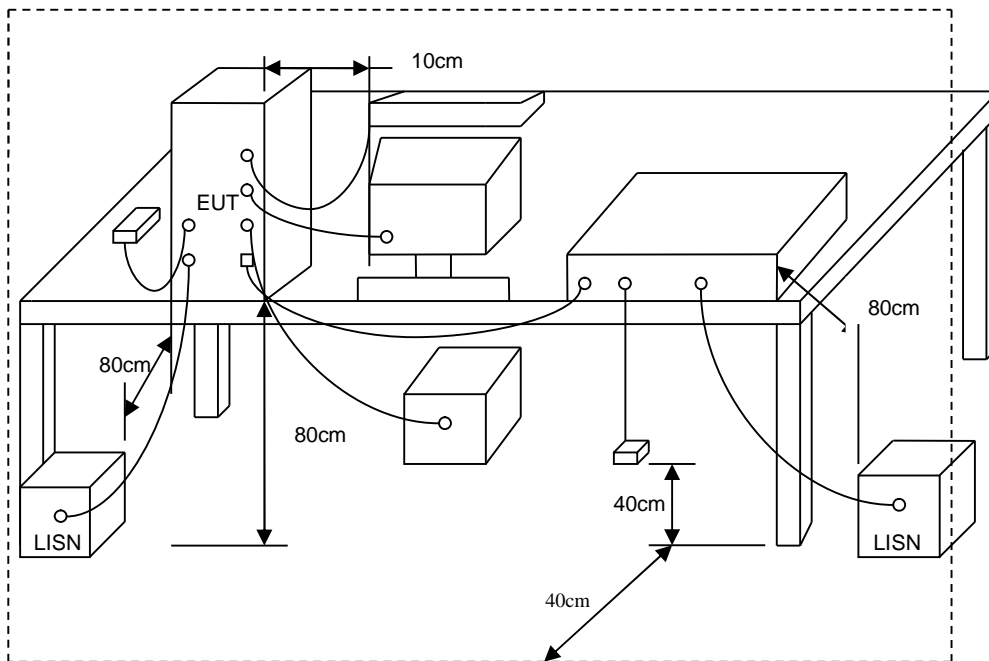



4.4. Test Result and Data

Power	: DC 5V From System	Pol/Phase	: LINE
Test Mode	: Mode 1	Temperature	: 22 °C
Test Date	: Aug. 30, 2018	Humidity	: 49 %

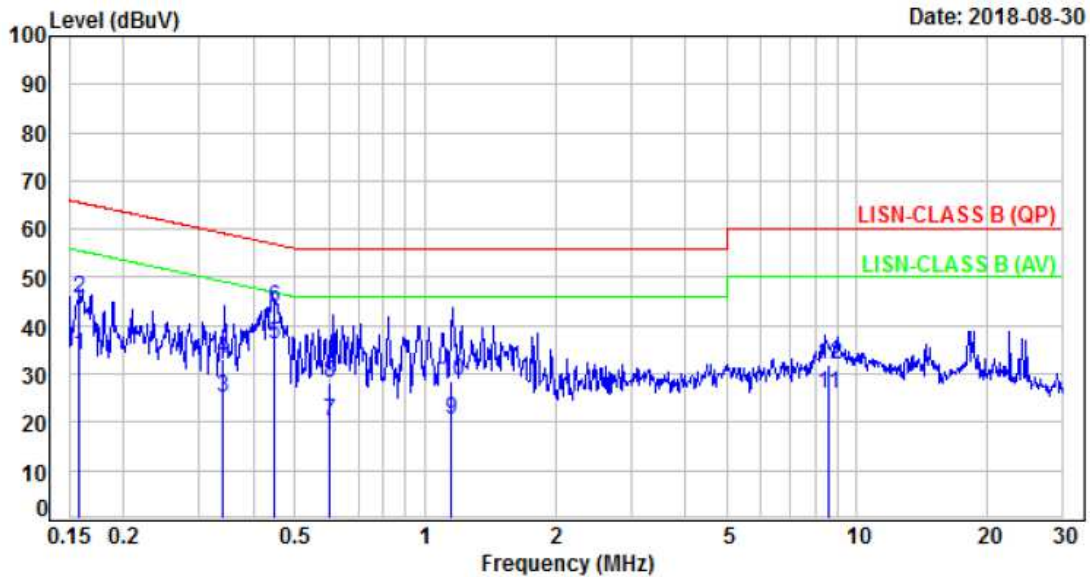

No.	Frequency (MHz)	Factor (dB)	Reading (dBuV)	Level (dBuV)	Limit (dBuV)	Margin (dB)	Detector	P/F
1	0.16	9.70	24.04	33.74	55.58	-21.84	Average	P
2	0.16	9.70	35.85	45.55	65.58	-20.03	QP	P
3	0.34	9.70	15.26	24.96	49.18	-24.22	Average	P
4	0.34	9.70	23.45	33.15	59.18	-26.03	QP	P
5	0.45	9.70	26.38	36.08	46.95	-10.87	Average	P
6	0.45	9.70	34.14	43.84	56.95	-13.11	QP	P
7	0.60	9.71	10.57	20.28	46.00	-25.72	Average	P
8	0.60	9.71	18.56	28.27	56.00	-27.73	QP	P
9	1.15	9.74	10.77	20.51	46.00	-25.49	Average	P
10	1.15	9.74	18.94	28.68	56.00	-27.32	QP	P
11	8.60	9.92	16.04	25.96	50.00	-24.04	Average	P
12	8.60	9.92	22.18	32.10	60.00	-27.90	QP	P

Note: Level = Reading + Factor
Margin = Level – Limit
Factor = (LISN, ISN, PLC or current probe) Factor + Cable Loss



Power	: DC 5V From System	Pol/Phase	: NEUTRAL
Test Mode	: Mode 1	Temperature	: 22 °C
Test Date	: Aug. 30, 2018	Humidity	: 49 %

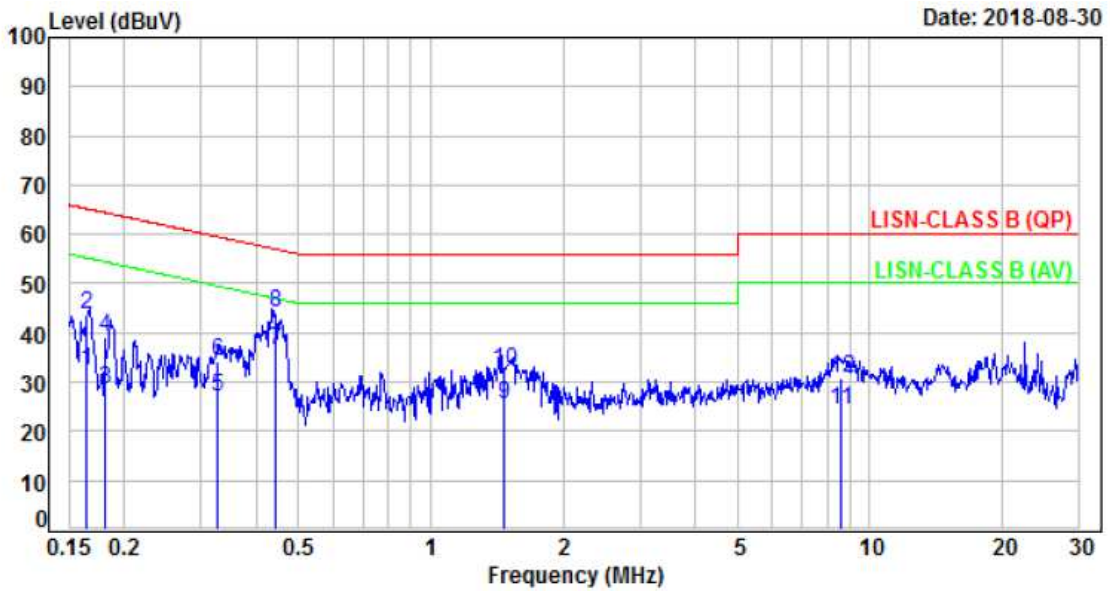

No.	Frequency (MHz)	Factor (dB)	Reading (dBuV)	Level (dBuV)	Limit (dBuV)	Margin (dB)	Detector	P/F
1	0.16	9.70	22.57	32.27	55.25	-22.98	Average	P
2	0.16	9.70	34.21	43.91	65.25	-21.34	QP	P
3	0.18	9.70	18.77	28.47	54.44	-25.97	Average	P
4	0.18	9.70	29.61	39.31	64.44	-25.13	QP	P
5	0.33	9.70	17.12	26.82	49.52	-22.70	Average	P
6	0.33	9.70	24.42	34.12	59.52	-25.40	QP	P
7	0.44	9.70	26.91	36.61	46.99	-10.38	Average	P
8	0.44	9.70	34.33	44.03	56.99	-12.96	QP	P
9	1.47	9.78	15.56	25.34	46.00	-20.66	Average	P
10	1.47	9.78	22.64	32.42	56.00	-23.58	QP	P
11	8.60	9.94	14.57	24.51	50.00	-25.49	Average	P
12	8.60	9.94	20.83	30.77	60.00	-29.23	QP	P

Note: Level = Reading + Factor
 Margin = Level – Limit
 Factor = (LISN, ISN, PLC or current probe) Factor + Cable Loss



5. Test of Radiated Spurious Emission

5.1. Test Limit

Emissions radiated outside of the specified frequency bands, except for harmonics, shall be attenuated by at least 50 dB below the level of the fundamental or to the general radiated emission limits in § 15.209, whichever is the lesser attenuation.

Frequency (MHz)	Distance	Limit ($\mu\text{V}/\text{m}$)
0.09 ~ 0.490	300m	2400/F(kHz)
0.490 ~ 1.705	30m	24000/ F(kHz)
1.705 ~ 30	30m	30
30 ~ 88	3m	100
88 ~ 216	3m	150
216 ~ 960	3m	200
Above 960	3m	500

Fundamental Frequency:

Fundamental Frequency (MHz)	Field strength of fundamental (millivolts/meter)	Field strength of harmonics (microvolts/meter)
902-928	50	500
2400-2483.5	50	500
5725-5875	50	500
24000-24250	250	2500

15.215 Additional provisions to the general radiated emission limitations.:

(c) Intentional radiators operating under the alternative provisions to the general emission limits, as contained in §§15.217 through 15.257 and in subpart E of this part, must be designed to ensure that the 20 dB bandwidth of the emission, or whatever bandwidth may otherwise be specified in the specific rule section under which the equipment operates, is contained within the frequency band designated in the rule section under which the equipment is operated.



5.2. Test Procedures

- a. The EUT was placed on a rotatable table top 0.8 meter above ground.
- b. The EUT was set 3 meters from the interference receiving antenna which was mounted on the top of a variable height antenna tower.
- c. The table was rotated 360 degrees to determine the position of the highest radiation.
- d. The antenna is a broadband antenna and its height is varied between one meter and four meters above ground to find the maximum value of the field strength both horizontal polarization and vertical polarization of the antenna are set to make the measurement.
- e. For each suspected emission the EUT was arranged to its worst case and then tune the antenna tower (from 1 M to 4 M) and turn table (from 0 degree to 360 degrees) to find the maximum reading.
- f. Set the test-receiver system to Peak or CISPR quasi-peak Detect Function and specified bandwidth with Maximum Hold Mode.
- g. If the emission level of the EUT in peak mode was 3 dB lower than the limit specified, then testing will be stopped and peak values of EUT will be reported, otherwise, the emissions which do not have 3 dB margin will be repeated one by one using the quasi-peak method and reported.
- h. For testing above 1GHz, the emission level of the EUT in peak mode was 20dB lower than average limit (that means the emission level in peak mode also complies with the limit in average mode), then testing will be stopped and peak values of EUT will be reported, otherwise, the emissions will be measured in average mode again and reported.
- i. "Cone of radiation" has been considered to be 3dB beamwidth of the measurement antenna.

NOTE:

1. The resolution bandwidth and video bandwidth of test receiver/spectrum analyzer is 120kHz for Peak detection (PK) and Quasi-peak detection (QP) at frequency below 1GHz.
2. The resolution bandwidth and video bandwidth of test receiver/spectrum analyzer is 1 MHz for Peak detection at frequency above 1GHz.
3. The resolution bandwidth of test receiver/spectrum analyzer is 1 MHz and the video bandwidth is 10 Hz for Average detection (AV) at frequency above 1GHz.



5.3. Typical Test Setup Layout of Radiated Emission

Below 30MHz test setup

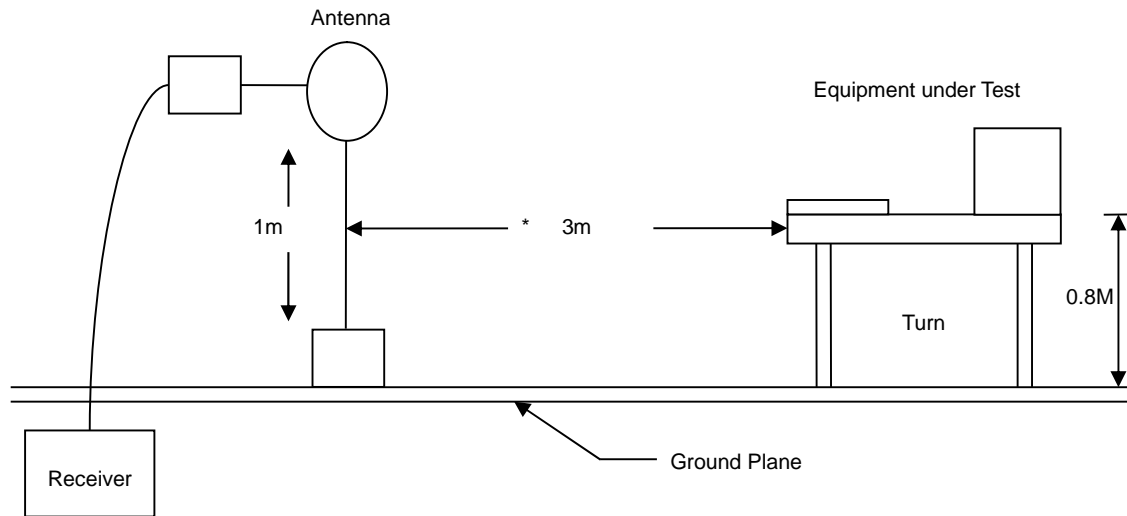

30MHz- 1GHz Test Setup

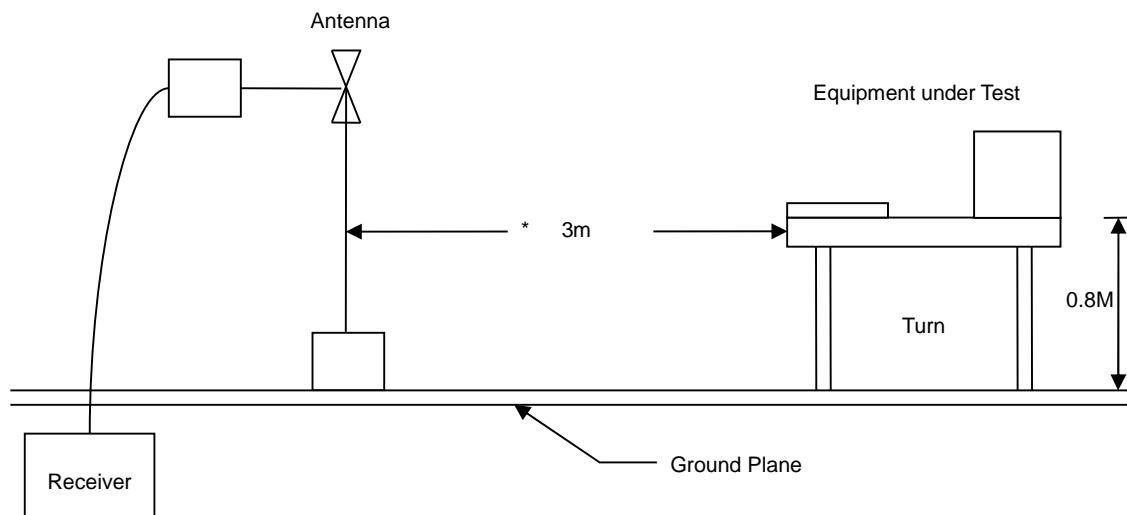

Above 1GHz Test Setup

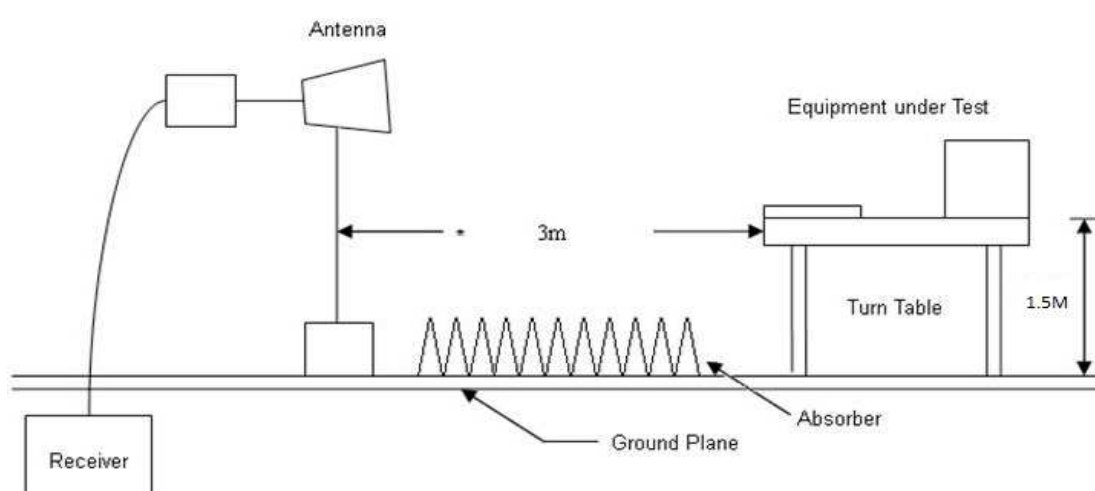



5.4. Test Result and Data

5.4.1. Test Result of Fundamental Emission

Power	: DC 5V From System	Pol/Phase	: VERTICAL
Test Mode	: Mode 1, CH01	Temperature	: 23°C
Test Date	: Nov. 29, 2018	Humidity	: 61 %

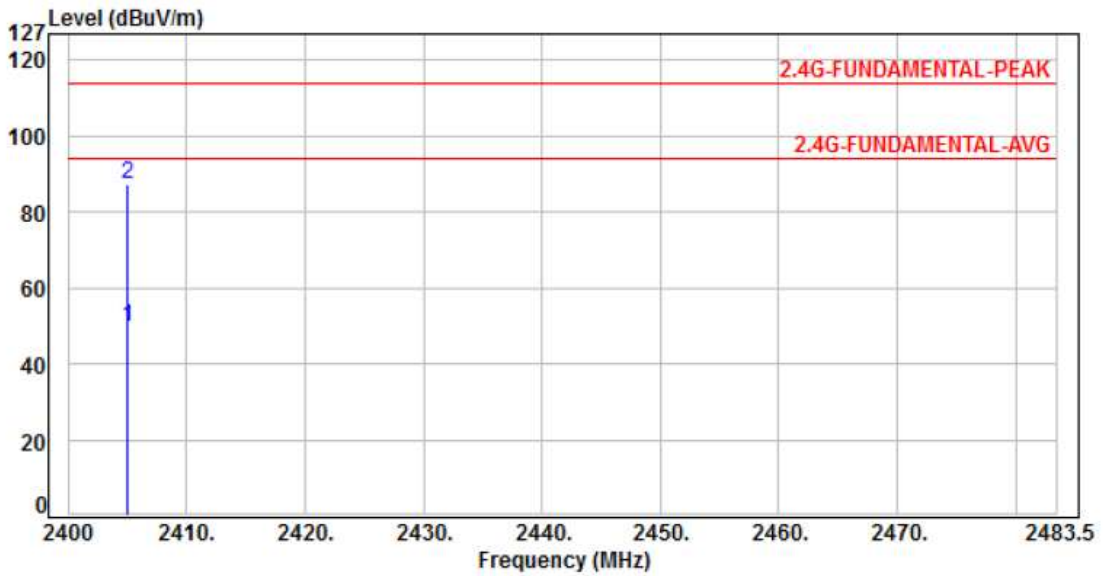

No.	Frequency (MHz)	Factor (dB)	Reading (dBuV)	Level (dBuV/m)	Limit (dBuV/m)	Margin (dB)	Detector	Height (cm)	Azimuth (deg)	P/F
1	2405.00	-15.90	65.70	49.80	94.00	-44.20	Average	270	240	P
2	2405.00	-15.90	103.29	87.39	114.00	-26.61	Peak	270	240	P

Note: Level=Reading+Factor
Margin=Level-Limit
Factor=Antenna Factor + cable loss - Amplifier Factor



Power	: DC 5V From System	Pol/Phase	: HORIZONTAL
Test Mode	: Mode 1, CH01	Temperature	: 23°C
Test Date	: Nov. 29, 2018	Humidity	: 61 %

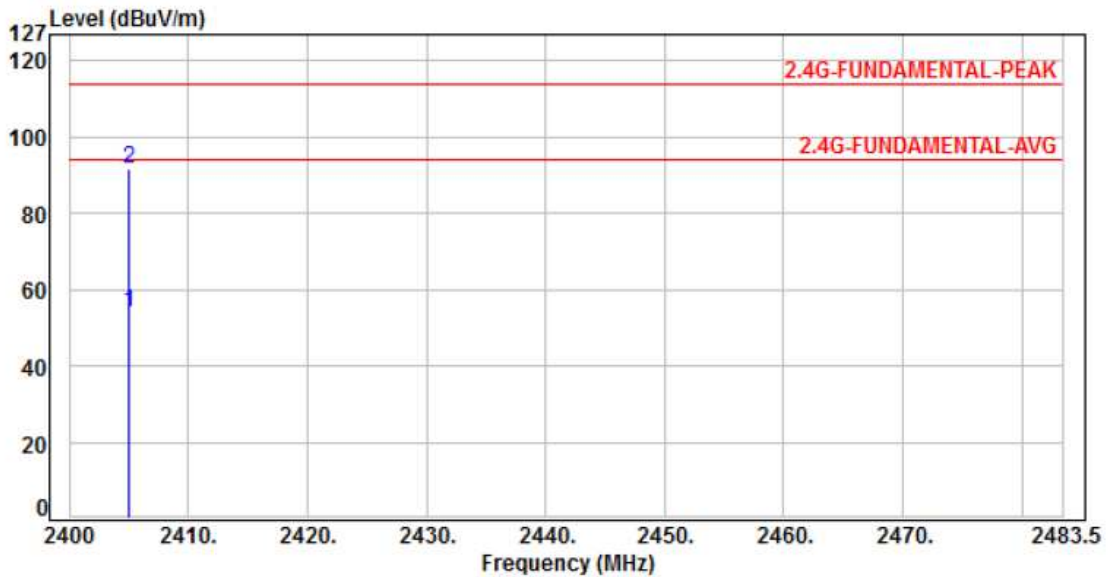

No.	Frequency (MHz)	Factor (dB)	Reading (dBuV)	Level (dBuV/m)	Limit (dBuV/m)	Margin (dB)	Detector	Height (cm)	Azimuth (deg)	P/F
1	2405.00	-15.90	70.10	54.20	94.00	-39.80	Average	158	180	P
2	2405.00	-15.90	107.69	91.79	114.00	-22.21	Peak	158	180	P

Note: Level=Reading+Factor
Margin=Level-Limit
Factor=Antenna Factor + cable loss - Amplifier Factor



Power	: DC 5V From System	Pol/Phase	: VERTICAL
Test Mode	: Mode 2, CH08	Temperature	: 23°C
Test Date	: Nov. 29, 2018	Humidity	: 61 %

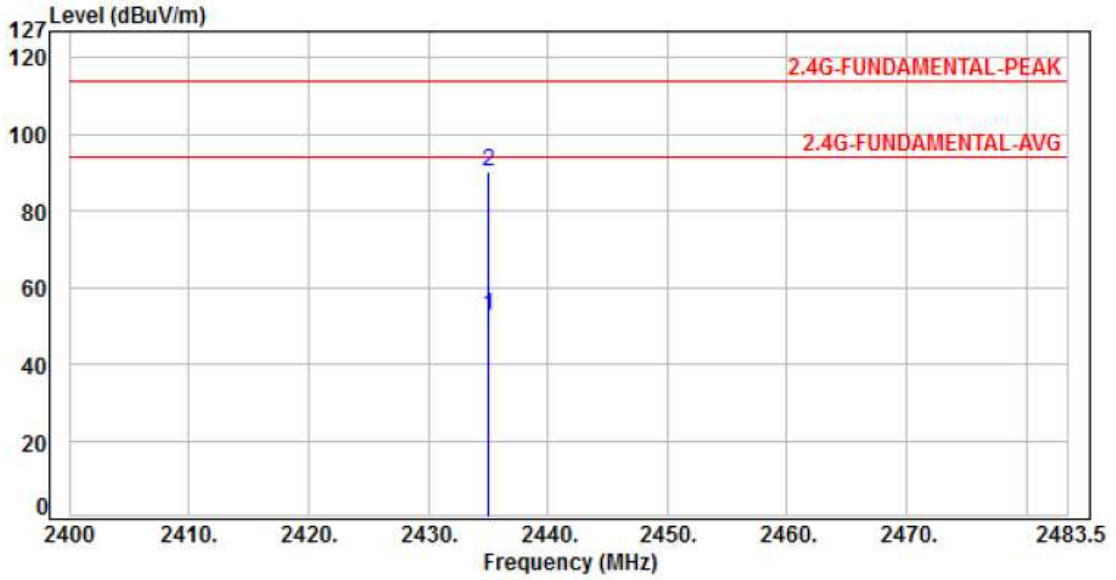

No.	Frequency (MHz)	Factor (dB)	Reading (dBuV)	Level (dBuV/m)	Limit (dBuV/m)	Margin (dB)	Detector	Height (cm)	Azimuth (deg)	P/F
1	2435.00	-15.81	68.31	52.50	94.00	-41.50	Average	222	75	P
2	2435.00	-15.81	105.90	90.09	114.00	-23.91	Peak	222	75	P

Note: Level=Reading+Factor
Margin=Level-Limit
Factor=Antenna Factor + cable loss - Amplifier Factor



Power	: DC 5V From System	Pol/Phase	: HORIZONTAL
Test Mode	: Mode 2, CH08	Temperature	: 23°C
Test Date	: Nov. 29, 2018	Humidity	: 61 %

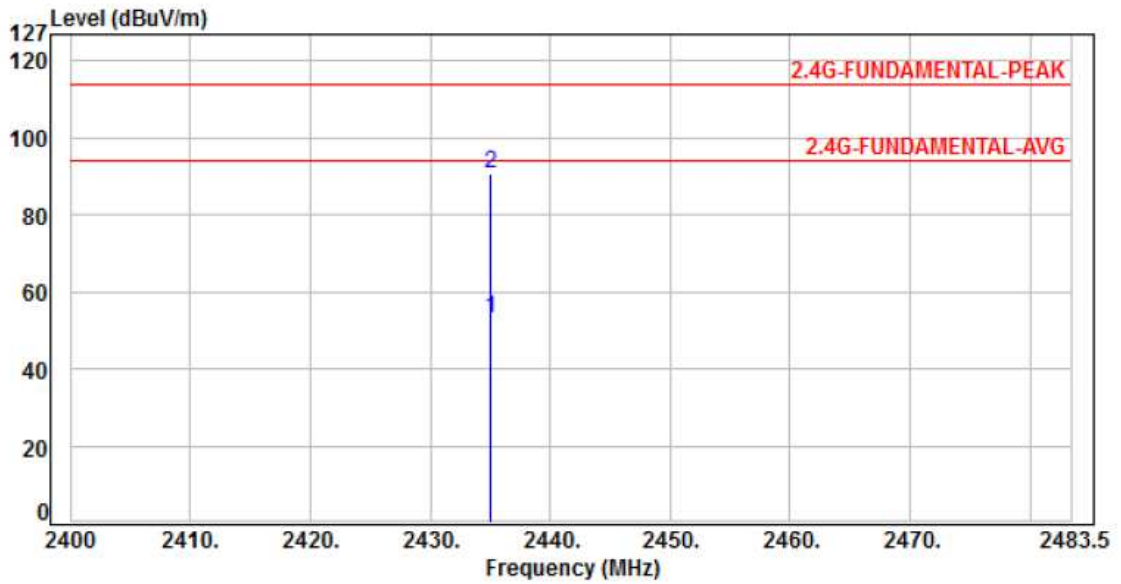

No.	Frequency (MHz)	Factor (dB)	Reading (dBuV)	Level (dBuV/m)	Limit (dBuV/m)	Margin (dB)	Detector	Height (cm)	Azimuth (deg)	P/F
1	2435.00	-15.81	68.91	53.10	94.00	-40.90	Average	128	170	P
2	2435.00	-15.81	106.50	90.69	114.00	-23.31	Peak	128	170	P

Note: Level=Reading+Factor
Margin=Level-Limit
Factor=Antenna Factor + cable loss - Amplifier Factor



Power	: DC 5V From System	Pol/Phase	: VERTICAL
Test Mode	: Mode 3, CH16	Temperature	: 23°C
Test Date	: Nov. 29, 2018	Humidity	: 61 %

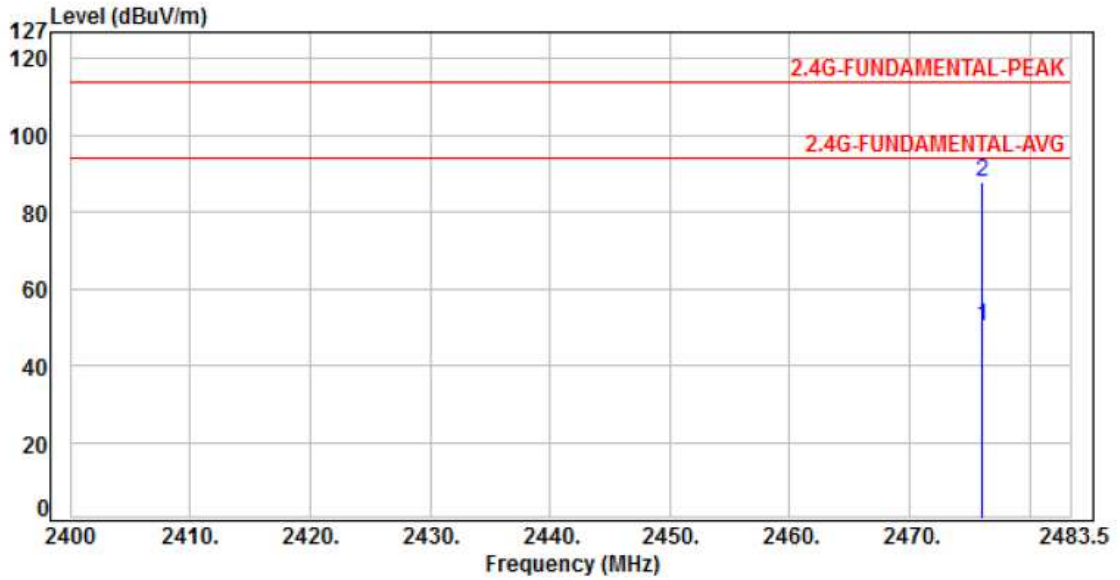

No.	Frequency (MHz)	Factor (dB)	Reading (dBuV)	Level (dBuV/m)	Limit (dBuV/m)	Margin (dB)	Detector	Height (cm)	Azimuth (deg)	P/F
1	2476.00	-15.68	65.91	50.23	94.00	-43.77	Average	100	203	P
2	2476.00	-15.68	103.50	87.82	114.00	-26.18	Peak	100	203	P

Note: Level=Reading+Factor
Margin=Level-Limit
Factor=Antenna Factor + cable loss - Amplifier Factor



Power	: DC 5V From System	Pol/Phase	: HORIZONTAL
Test Mode	: Mode 3, CH16	Temperature	: 23°C
Test Date	: Nov. 29, 2018	Humidity	: 61 %

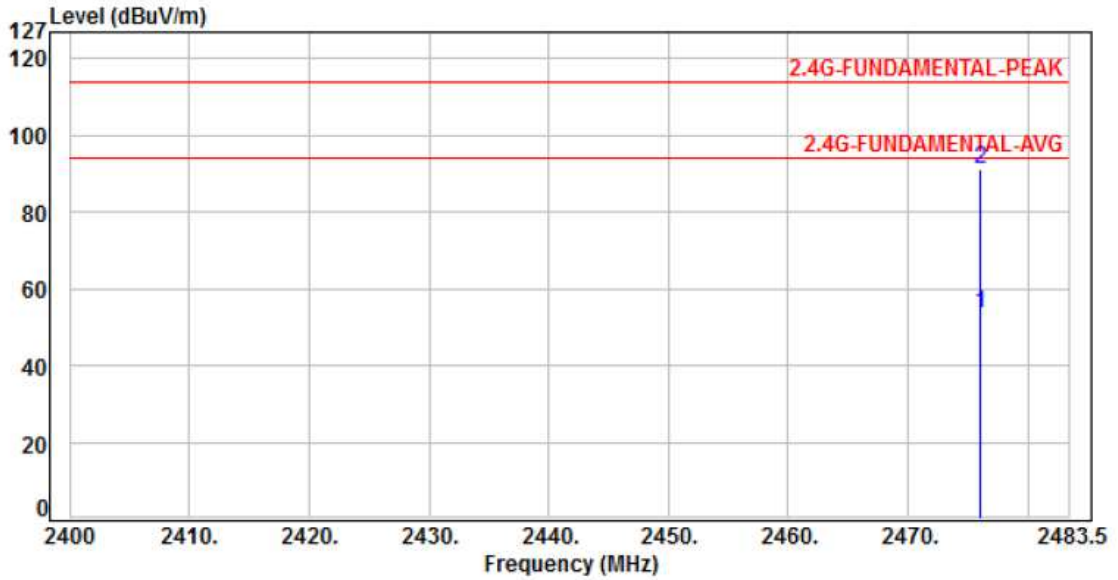

No.	Frequency (MHz)	Factor (dB)	Reading (dBuV)	Level (dBuV/m)	Limit (dBuV/m)	Margin (dB)	Detector	Height (cm)	Azimuth (deg)	P/F
1	2476.00	-15.68	69.41	53.73	94.00	-40.27	Average	100	180	P
2	2476.00	-15.68	107.00	91.32	114.00	-22.68	Peak	100	180	P

Note: Level=Reading+Factor
Margin=Level-Limit
Factor=Antenna Factor + cable loss - Amplifier Factor

5.4.2. Test Result of 9KHz ~ 30MHz

The 9kHz - 30MHz spurious emission is under limit 20dB more.



5.4.3. Test Result of Unwanted Spurious emission (30MHz ~ 1GHz)

Power	: DC 5V From System	Pol/Phase	: VERTICAL
Test Mode	: Mode 1	Temperature	: 23°C
Test Date	: Nov. 29, 2018	Humidity	: 61 %

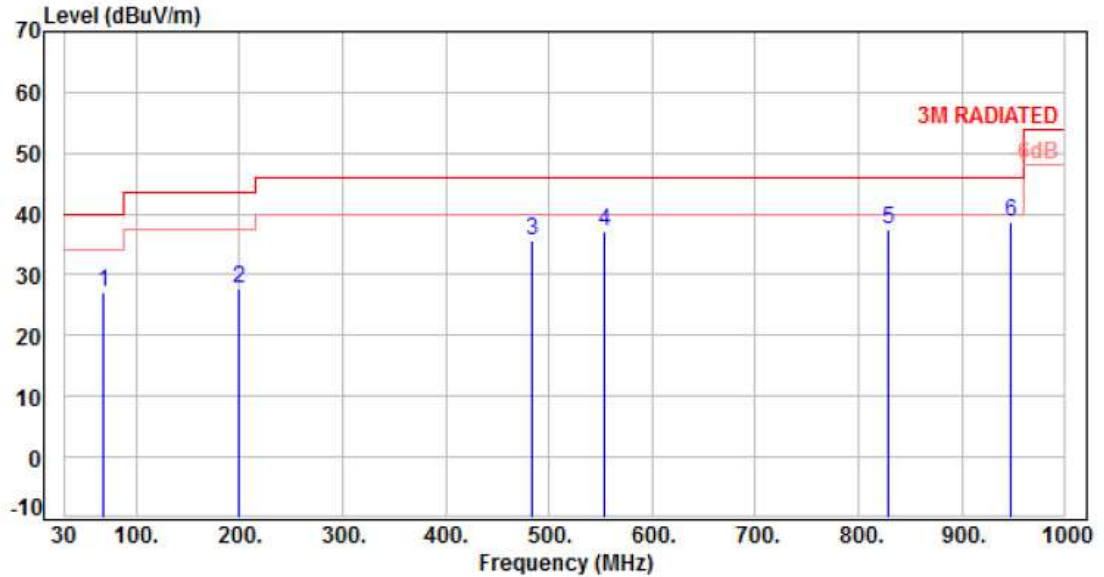

No.	Frequency (MHz)	Factor (dB)	Reading (dBuV)	Level (dBuV/m)	Limit (dBuV/m)	Margin (dB)	Detector	Height (cm)	Azimuth (deg)	P/F
1	68.80	-12.70	39.75	27.05	40.00	-12.95	Peak	400	0	P
2	198.78	-13.02	40.73	27.71	43.50	-15.79	Peak	400	0	P
3	482.99	-5.24	40.85	35.61	46.00	-10.39	Peak	400	0	P
4	553.80	-3.98	41.28	37.30	46.00	-8.70	Peak	400	0	P
5	828.31	0.72	36.70	37.42	46.00	-8.58	Peak	400	0	P
6	947.62	2.54	36.19	38.73	46.00	-7.27	Peak	400	0	P

Note: Level=Reading+Factor
Margin=Level-Limit
Factor=Antenna Factor + cable loss - Amplifier Factor



Power	: DC 5V From System	Pol/Phase	: HORIZONTAL
Test Mode	: Mode 1	Temperature	: 23°C
Test Date	: Nov. 29, 2018	Humidity	: 61 %

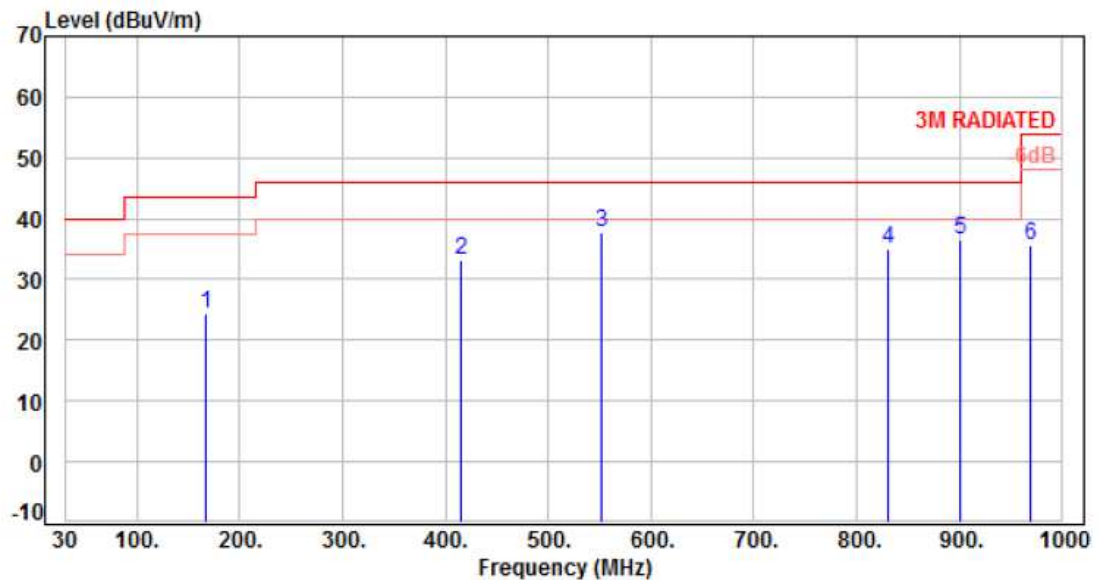

No.	Frequency (MHz)	Factor (dB)	Reading (dBUV)	Level (dBUV/m)	Limit (dBUV/m)	Margin (dB)	Detector	Height (cm)	Azimuth (deg)	P/F
1	167.74	-11.01	35.35	24.34	43.50	-19.16	Peak	100	0	P
2	416.06	-6.69	40.03	33.34	46.00	-12.66	Peak	100	0	P
3	551.86	-4.04	41.91	37.87	46.00	-8.13	Peak	100	0	P
4	831.22	0.76	34.39	35.15	46.00	-10.85	Peak	100	0	P
5	901.06	1.72	34.86	36.58	46.00	-9.42	Peak	100	0	P
6	969.93	2.74	32.84	35.58	54.00	-18.42	Peak	100	0	P

Note: Level=Reading+Factor
Margin=Level-Limit
Factor=Antenna Factor + cable loss - Amplifier Factor



5.4.4. Test Result of Unwanted Spurious emission (1GHz ~ 25GHz)

Power	: DC 5V From System	Pol/Phase	: VERTICAL
Test Mode	: Mode 1, CH01	Temperature	: 23°C
Test Date	: Nov. 29, 2018	Humidity	: 61 %

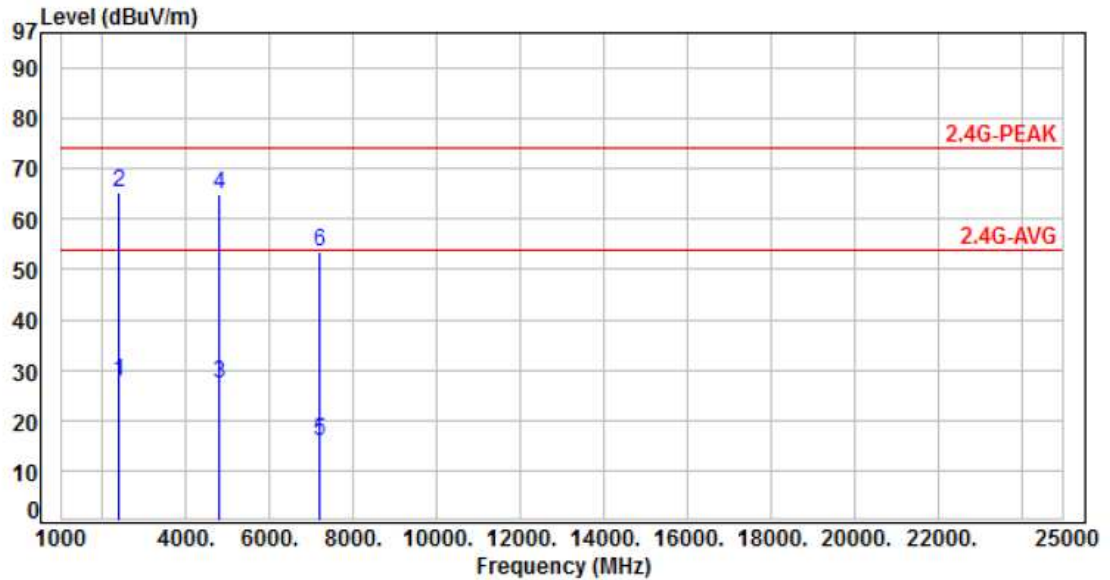

No.	Frequency (MHz)	Factor (dB)	Reading (dBuV)	Level (dBuV/m)	Limit (dBuV/m)	Margin (dB)	Detector	Height (cm)	Azimuth (deg)	P/F
1	2400.00	-15.92	43.61	27.69	54.00	-26.31	Average	270	240	P
2	2400.00	-15.92	81.20	65.28	74.00	-8.72	Peak	270	240	P
3	4810.00	-8.85	36.11	27.26	54.00	-26.74	Average	270	30	P
4	4810.00	-8.85	73.70	64.85	74.00	-9.15	Peak	270	30	P
5	7215.00	-4.97	20.91	15.94	54.00	-38.06	Average	393	310	P
6	7215.00	-4.97	58.50	53.53	74.00	-20.47	Peak	393	310	P

Note: Level=Reading+Factor
Margin=Level-Limit
Factor=Antenna Factor + cable loss - Amplifier Factor



Power	: DC 5V From System	Pol/Phase	: HORIZONTAL
Test Mode	: Mode 1, CH01	Temperature	: 22°C
Test Date	: Nov. 28, 2018	Humidity	: 59 %

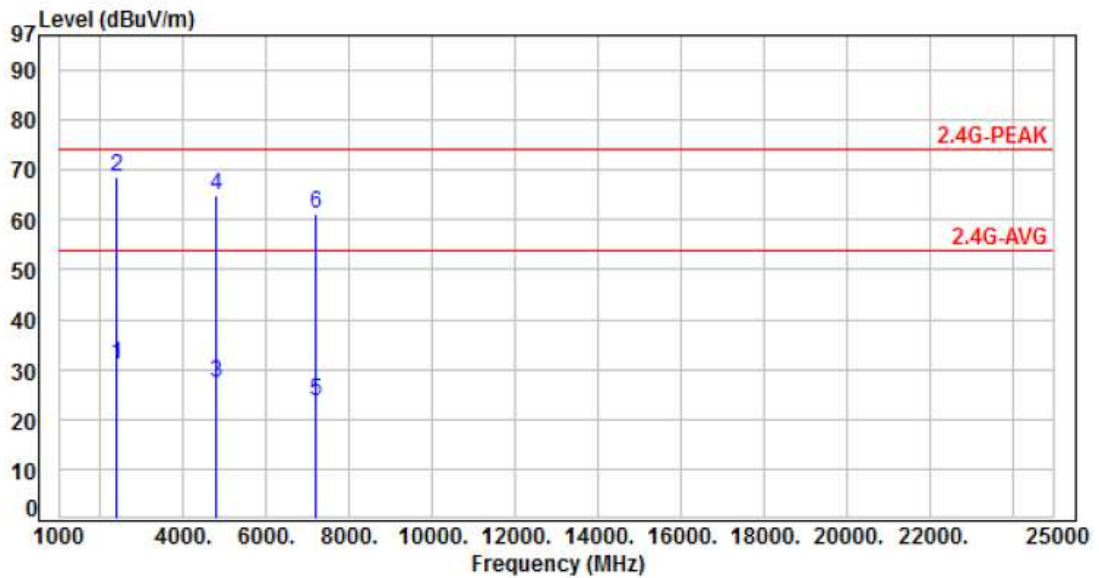

No.	Frequency (MHz)	Factor (dB)	Reading (dBuV)	Level (dBuV/m)	Limit (dBuV/m)	Margin (dB)	Detector	Height (cm)	Azimuth (deg)	P/F
1	2400.00	-15.92	46.98	31.06	54.00	-22.94	Average	158	180	P
2	2400.00	-15.92	84.57	68.65	74.00	-5.35	Peak	158	180	P
3	4810.00	-8.85	36.11	27.26	54.00	-26.74	Average	294	292	P
4	4810.00	-8.85	73.70	64.85	74.00	-9.15	Peak	294	292	P
5	7215.00	-4.97	28.61	23.64	54.00	-30.36	Average	100	269	P
6	7215.00	-4.97	66.20	61.23	74.00	-12.77	Peak	100	269	P

Note: Level=Reading+Factor
Margin=Level-Limit
Factor=Antenna Factor + cable loss - Amplifier Factor



Power	: DC 5V From System	Pol/Phase	: VERTICAL
Test Mode	: Mode 2, CH08	Temperature	: 23°C
Test Date	: Nov. 29, 2018	Humidity	: 61 %

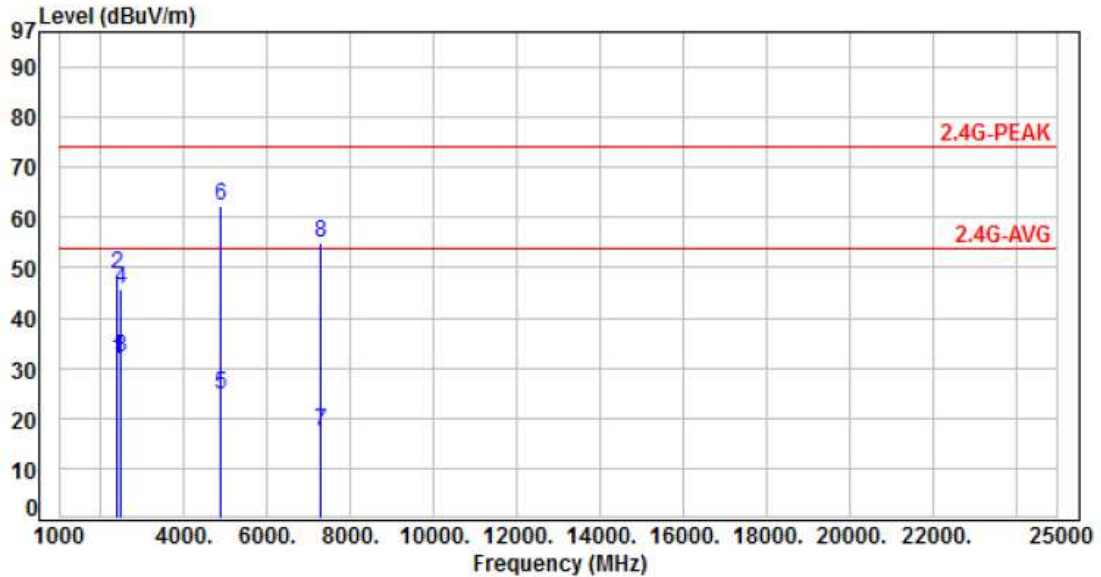

No.	Frequency (MHz)	Factor (dB)	Reading (dBUV)	Level (dBUV/m)	Limit (dBUV/m)	Margin (dB)	Detector	Height (cm)	Azimuth (deg)	P/F
1	2400.00	-15.92	47.50	31.58	54.00	-22.42	Average	222	75	P
2	2400.00	-15.92	64.60	48.68	74.00	-25.32	Peak	222	75	P
3	2483.50	-15.65	47.90	32.25	54.00	-21.75	Average	222	75	P
4	2483.50	-15.65	61.50	45.85	74.00	-28.15	Peak	222	75	P
5	4870.00	-8.66	33.31	24.65	54.00	-29.35	Average	362	31	P
6	4870.00	-8.66	70.90	62.24	74.00	-11.76	Peak	362	31	P
7	7305.00	-4.71	21.91	17.20	54.00	-36.80	Average	100	59	P
8	7305.00	-4.71	59.50	54.79	74.00	-19.21	Peak	100	59	P

Note: Level=Reading+Factor
 Margin=Level-Limit
 Factor=Antenna Factor + cable loss - Amplifier Factor



Power	: DC 5V From System	Pol/Phase	: HORIZONTAL
Test Mode	: Mode 2, CH08	Temperature	: 23°C
Test Date	: Nov. 29, 2018	Humidity	: 61 %

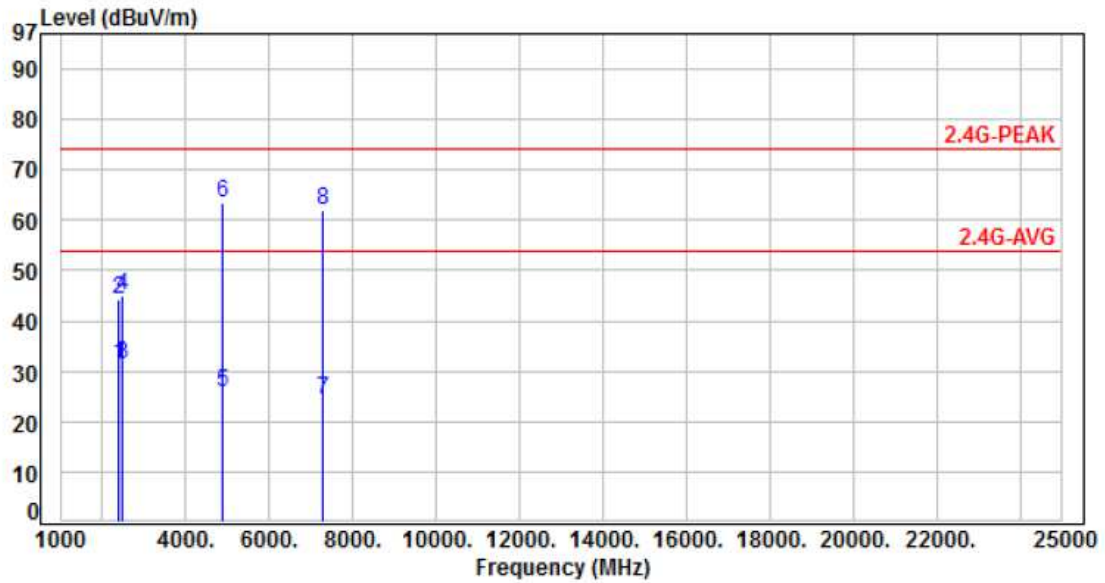

No.	Frequency (MHz)	Factor (dB)	Reading (dBuV)	Level (dBuV/m)	Limit (dBuV/m)	Margin (dB)	Detector	Height (cm)	Azimuth (deg)	P/F
1	2400.00	-15.92	47.30	31.38	54.00	-22.62	Average	128	170	P
2	2400.00	-15.92	60.20	44.28	74.00	-29.72	Peak	128	170	P
3	2483.50	-15.65	46.95	31.30	54.00	-22.70	Average	128	170	P
4	2483.50	-15.65	60.51	44.86	74.00	-29.14	Peak	128	170	P
5	4870.00	-8.66	34.61	25.95	54.00	-28.05	Average	100	294	P
6	4870.00	-8.66	72.20	63.54	74.00	-10.46	Peak	100	294	P
7	7305.00	-4.71	29.21	24.50	54.00	-29.50	Average	100	280	P
8	7305.00	-4.71	66.80	62.09	74.00	-11.91	Peak	100	280	P

Note: Level=Reading+Factor
 Margin=Level-Limit
 Factor=Antenna Factor + cable loss - Amplifier Factor



Power	: DC 5V From System	Pol/Phase	: VERTICAL
Test Mode	: Mode 3, CH16	Temperature	: 23°C
Test Date	: Nov. 29, 2018	Humidity	: 61 %

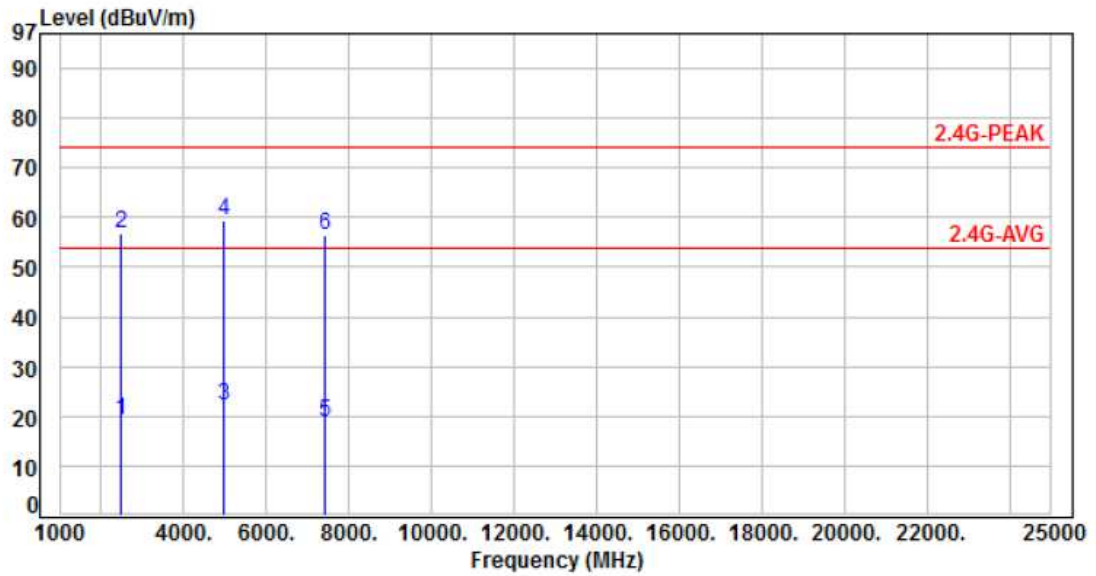

No.	Frequency (MHz)	Factor (dB)	Reading (dBuV)	Level (dBuV/m)	Limit (dBuV/m)	Margin (dB)	Detector	Height (cm)	Azimuth (deg)	P/F
1	2483.50	-15.65	34.91	19.26	54.00	-34.74	Average	100	203	P
2	2483.50	-15.65	72.50	56.85	74.00	-17.15	Peak	100	203	P
3	4952.00	-8.41	30.36	21.95	54.00	-32.05	Average	100	130	P
4	4952.00	-8.41	67.95	59.54	74.00	-14.46	Peak	100	130	P
5	7428.00	-4.36	23.31	18.95	54.00	-35.05	Average	220	63	P
6	7428.00	-4.36	60.90	56.54	74.00	-17.46	Peak	220	63	P

Note: Level=Reading+Factor
Margin=Level-Limit
Factor=Antenna Factor + cable loss - Amplifier Factor



Power	: DC 5V From System	Pol/Phase	: HORIZONTAL
Test Mode	: Mode 3, CH16	Temperature	: 23°C
Test Date	: Nov. 29, 2018	Humidity	: 61 %

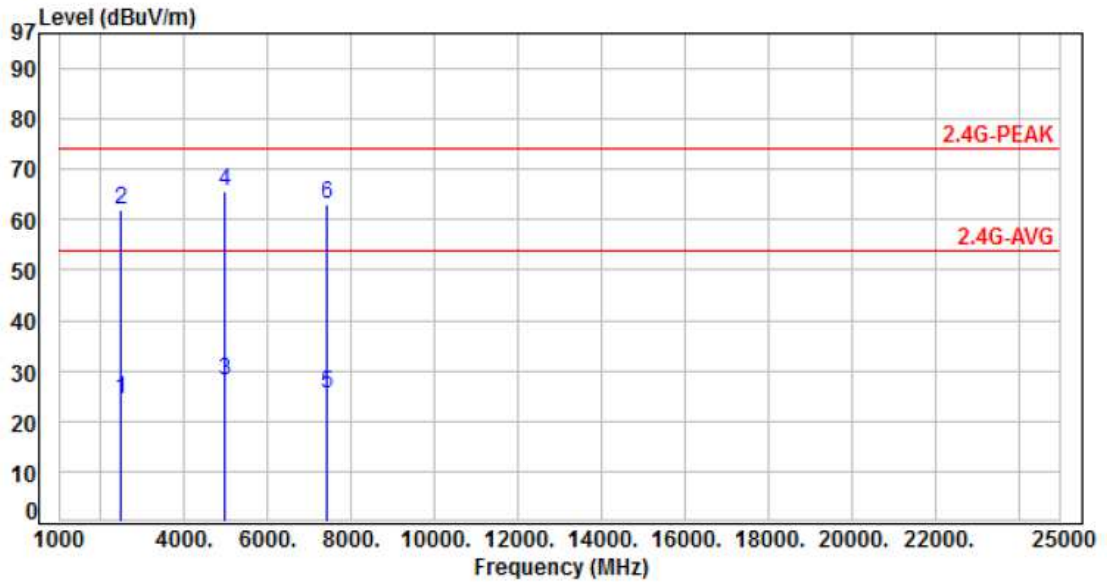

No.	Frequency (MHz)	Factor (dB)	Reading (dBuV)	Level (dBuV/m)	Limit (dBuV/m)	Margin (dB)	Detector	Height (cm)	Azimuth (deg)	P/F
1	2483.50	-15.65	39.91	24.26	54.00	-29.74	Average	100	180	P
2	2483.50	-15.65	77.50	61.85	74.00	-12.15	Peak	100	180	P
3	4952.00	-8.41	36.51	28.10	54.00	-25.90	Average	100	300	P
4	4952.00	-8.41	74.10	65.69	74.00	-8.31	Peak	100	300	P
5	7428.00	-4.36	29.91	25.55	54.00	-28.45	Average	120	310	P
6	7428.00	-4.36	67.50	63.14	74.00	-10.86	Peak	120	310	P

Note: Level=Reading+Factor
 Margin=Level-Limit
 Factor=Antenna Factor + cable loss - Amplifier Factor



5.4.5. 20dB Bandwidth & 99% Occupied BW

Frequency (MHz)	20dB Bandwidth (MHz)	99% Occupied BW (MHz)	Frequency range MHz (20dB Down) fL > 2400 MHz	Frequency range MHz (20dB Down) fH < 2483.5 MHz
2405	8.70	8.40	2401.1600	-
2435	8.34	7.98	-	-
2476	7.02	7.26	-	2480.0800

20dB Bandwidth CH01, 2405MHz

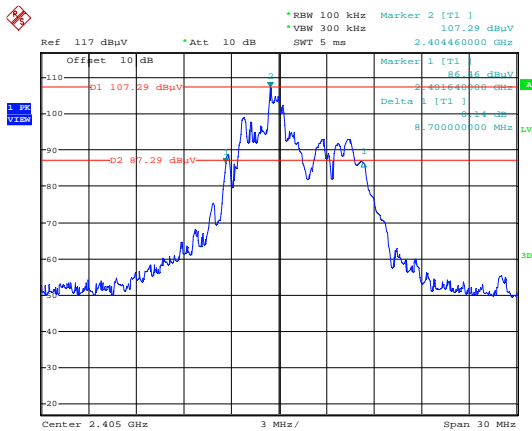

CH16, 2476MHz

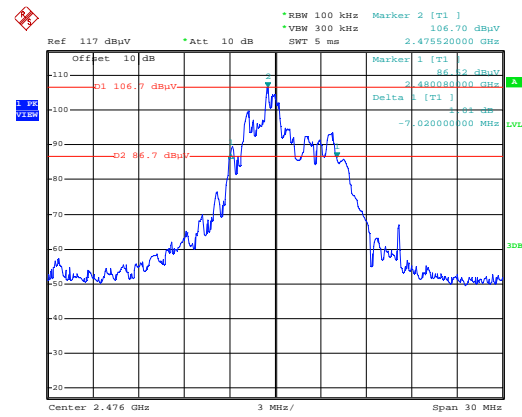

CH08, 2435MHz

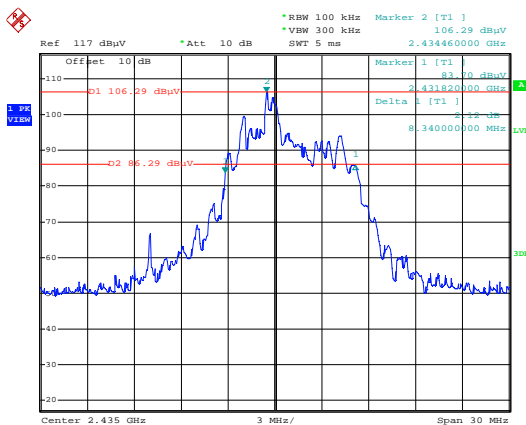



99% Occupied BW
CH01, 2405MHz

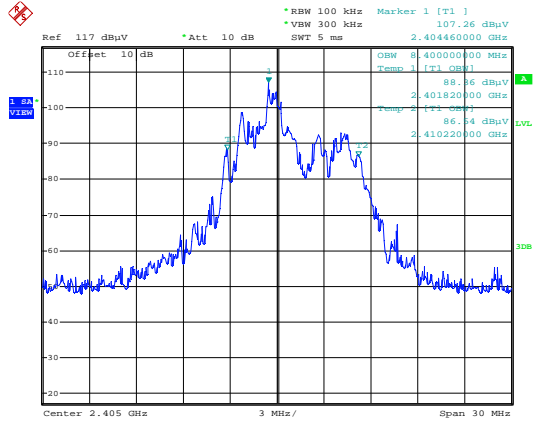

CH16, 2476MHz

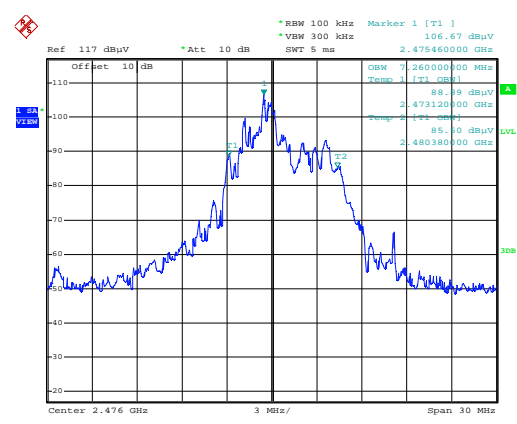

CH08, 2435MHz

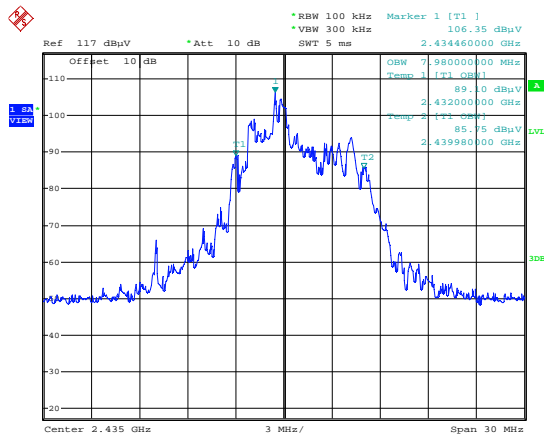



5.4.6. Maximum Peak and Average Output Power

Modulation Type	Channel	Frequency (MHz)	Power Output (dBm)		Power Output (mW)	
			Peak	Average	Peak	Average
GFSK	1	2405	4.86	4.77	3.062	2.999
	8	2435	4.75	4.64	2.985	2.911
	16	2476	4.84	4.75	3.048	2.985

*For reference only