



FCC 47 CFR PART 15 SUBPART C 15.247

TEST REPORT

FOR

Product Name: SteelSeries Stratus Wireless Gaming Controller

Model : 69017, 69018, 69019

Trade Name: SteelSeries Stratus Wireless Gaming Controller

Issued to

SteelSeries ApS
656 West Randolph Street, Suite 2E, Chicago, IL. 60661

Issued by

Global Certification Corp.

EMC Test Site	Xizhi office and Lab	No.146, Sec. 2, Xiangzhang Rd., Xizhi Dist., New Taipei City 221, Taiwan (R.O.C.)
--------------------------	---------------------------------	--



Note: This test refers exclusively to the test presented test model and sample. This report shall not be reproduced except in full, without the written approval of Global Certification Corporation. This document may be altered or revised by Global Certification Corporation. Personnel only, and shall be noted in the revision section of the document.



TABLE OF CONTENTS	2
1. GENERAL INFORMATION	4
1.1 DESCRIPTION OF THE TESTED SAMPLES	5
1.2 LIST OF MEASUREMENTS AND EXAMINATIONS	7
2. TEST METHODOLOGY	8
2.1 GENERAL TEST PROCEDURES	8
2.2 FCC PART 15.205 RESTRICTED BANDS OF OPERATIONS	8
2.3 DESCRIPTION OF TEST MODES	9
2.4 DESCRIPTION OF THE SUPPORT EQUIPMENTS	9
3. TEST AND MEASUREMENT EQUIPMENT	10
3.1 CALIBRATION	10
3.2 EQUIPMENT	10
4. ANTENNA REQUIREMENTS	11
4.1 STANDARD APPLICABLE	11
4.2 ANTENNA CONSTRUCTION AND DIRECTIONAL GAIN	11
5. PEAK OUTPUT POWER	12
5.1 TEST SETUP	12
5.2 LIMIT	12
5.3 TEST PROCEDURE	12
5.4 TEST RESULT	12
5.5 TEST DATA	12
6. AVERAGE POWER	13
6.1 TEST SETUP	13
6.2 LIMIT	13
6.3 TEST PROCEDURE	13
6.4 TEST RESULT	13
6.5 TEST DATA	13
7. BAND EDGE	14
7.1 TEST SETUP	14
7.2 LIMIT	15
7.3 RESULT	15
7.4 TEST DATA	16
8. 20DB BANDWIDTH	21
8.1 TEST LIMIT	21
8.2 TEST LIMIT	21
8.3 TEST SETUP LAYOUT	21
8.4 TEST RESULT AND DATA	21
8.5 TEST DATA	22
9. RADIATED EMISSION	23
9.1 TEST SETUP	23
9.2 LIMIT	24
9.3 TEST PROCEDURE	24
9.4 RESULT	24
9.5 TEST DATA	25
10. CONDUCTED EMISSIONS	29
10.1 TEST SETUP	29



10.2	LIMIT -----	29
10.3	TEST PROCEDURE-----	29
10.4	TEST SPECIFICATION -----	29
10.5	RESULT -----	29
10.6	TEST DATA -----	29
11.	SPURIOUS EMISSIONS (CHANNEL CARRIER FREQUENCIES SEPARATION) -----	30
11.1	CONDUCTED MEASUREMENT-----	30
11.2	TEST SETUP -----	30
11.3	LIMIT -----	30
11.4	TEST PROCEDURE-----	30
11.5	TEST RESULTS-----	30
11.6	TEST DATA -----	31
12.	DWELL TIME ON EACH CHANNEL -----	33
12.1	TEST SETUP -----	33
12.2	TEST LIMIT -----	33
12.3	TEST PROCEDURES -----	33
12.4	TEST RESULTS-----	33
12.5	TEST DATA -----	33
13.	NUMBER OF HOPPING CHANNELS -----	35
13.1	TEST LIMIT -----	35
13.2	TEST PROCEDURES -----	35
13.3	TEST SETUP LAYOUT-----	35
13.4	TEST RESULT AND DATA -----	35

APPENDIX 1

RADIO FREQUENCY EXPOSURE

APPENDIX 2

PHOTOS OF TEST CONFIGURATION

PHOTOS OF EUT



1. GENERAL INFORMATION

Applicant : SteelSeries ApS
Address : 656 West Randolph Street, Suite 2E, Chicago, IL. 60661

Manufacturer : DEXIN Electronic
Address : ShiTan Pu Industrial, Tangxia Town, Dongguan, Guangdong, China

EUT : SteelSeries Stratus Wireless Gaming Controller

Model No. : 69017, 69018, 69019

Model Differences : The major electrical and mechanical constructions of series models are identical to the basic model, except different color of case. The model, 69017 is the testing sample, and the final test data are shown on this test report.

Is here with confirmed to comply with the requirements set out in the FCC Rules and Regulations Part 15 Subpart C and the measurement procedures were according to ANSI C63.4-2009. The said equipment in the configuration described in this report shows the maximum emission levels emanating from equipment are within the compliance requirements.

FCC part 15 subpart C

Receipt Date : Dec. 18, 2013

Issue Date : Dec. 24, 2013

New Taipei City, Taiwan

(Place)

Dec. 24, 2013

(Date)

Adam Chou, Manager

(Signature)

Designation Number: TW1069



1.1 DESCRIPTION OF THE TESTED SAMPLES

EUT Name : SteelSeries Stratus Wireless Gaming Controller

Model Number : 69017, 69018, 69019

FCC ID : ZHK-69017

Input Voltage : 5 VDC

Power From Inside Outside

Adaptor

BATTERY

Power Supply

DC Power Source

Support Unit PC

Operate Frequency : Refer to the channel list as described below

Number of Channels : 79

Channel spacing : 1 MHz

Modulation Type : GFSK

Antenna Type : Print antenna

Antenna gain : 0.37 dBi



Channels	Frequencies (MHz)	Channels	Frequencies (MHz)
0	2402	40	2442
1	2403	41	2443
2	2404	42	2444
3	2405	43	2445
4	2406	44	2446
5	2407	45	2447
6	2408	46	2448
7	2409	47	2449
8	2410	48	2450
9	2411	49	2451
10	2412	50	2452
11	2413	51	2453
12	2414	52	2454
13	2415	53	2455
14	2416	54	2456
15	2417	55	2457
16	2418	56	2458
17	2419	57	2459
18	2420	58	2460
19	2421	59	2461
20	2422	60	2462
21	2423	61	2463
22	2424	62	2464
23	2425	63	2465
24	2426	64	2466
25	2427	65	2467
26	2428	66	2468
27	2429	67	2469
28	2430	68	2470
29	2431	69	2471
30	2432	70	2472
31	2433	71	2473
32	2434	72	2474
33	2435	73	2475
34	2436	74	2476
35	2437	75	2477
36	2438	76	2478
37	2439	77	2479
38	2440	78	2480
39	2441		



1.2 LIST OF MEASUREMENTS AND EXAMINATIONS

FCC Rule	Description of Test	Result
15.203	Antenna Requirement	Pass
15.207	Conducted Emission	N/A
15.209	Radiated Emission	Pass
15.247(a)(1)	Channel Carrier Frequencies Separation	Pass
15.247(a)(1)	20dB Bandwidth Measurement	Pass
15.247(a)(1)	Dwell Time	Pass
15.247(b)	Number of Hopping Channels	Pass
15.247(b)	Peak Output Power Measurement Data	Pass
15.247(b)	Band Edges Measurement Data	Pass



2. TEST METHODOLOGY

All testing as described bellowed were performed in accordance with ANSI C63.4:2009and FCC CFR 47 Part 15 Subpart C.

2.1 GENERAL TEST PROCEDURES

Conducted Emissions

The EUT is placed on a wood table, which is at 0.8 m above ground plane acceding to clause 15.207 and requirements of ANSI C63.4:2009. Conducted emissions from the EUT measured in the frequency range between 0.15 MHz and 30MHz are using CISPR Quasi-Peak / Average detectors.

Radiated Emissions

The EUT is a placed on a turn table, which is 0.8 m above ground plane. The turntable was rotated through 360 degrees to determine the position of maximum emission level. The EUT is placed at 3m away from the receiving antenna, which varied from 1m to 4m to find out the highest emission. Each emission was to be maximized by changing the polarization of receiving antenna both horizontal and vertical.

2.2 FCC PART 15.205 RESTRICTED BANDS OF OPERATIONS

(a) Except as shown in paragraph (d) of this section, only spurious emissions are permitted in any of the frequency bands listed below:

MHz	MHz	MHz	GHz
0.090 - 0.110	16.42 - 16.423	399.9 - 410	4.5 - 5.15
10.495 - 0.505	16.69475 - 16.69525	608 - 614	5.35 - 5.46
2.1735 - 2.1905	16.80425 - 16.80475	960 - 1240	7.25 - 7.75
4.125 - 4.128	25.5 - 25.67	1300 - 1427	8.025 - 8.5
4.17725 - 4.17775	37.5 - 38.25	1435 - 1626.5	9.0 - 9.2
4.20725 - 4.20775	73 - 74.6	1645.5 - 1646.5	9.3 - 9.5
6.215 - 6.218	74.8 - 75.2	1660 - 1710	10.6 - 12.7
6.26775 - 6.26825	108 - 121.94	1718.8 - 1722.2	13.25 - 13.4
6.31175 - 6.31225	123 - 138	2200 - 2300	14.47 - 14.5
8.291 - 8.294	149.9 - 150.05	2310 - 2390	15.35 - 16.2
8.362 - 8.366	156.52475 - 156.52525	2483.5 - 2500	17.7 - 21.4
8.37625 - 8.38675	156.7 - 156.9	2655 - 2900	22.01 - 23.12
8.41425 - 8.41475	162.0125 - 167.17	3260 - 3267	23.6 - 24.0
12.29 - 12.293	167.72 - 173.2	3332 - 3339	31.2 - 31.8
12.51975 - 12.52025	240 - 285	3345.8 - 3358	36.43 - 36.5
12.57675 - 12.57725	322 - 335.4	3600 - 4400	(²)
13.36 - 13.41			

1 Until February 1, 1999, this restricted band shall be 0.490-0.510 MHz.

2 Above 38.6

(b) Except as provided in paragraphs (d) and (e), the field strength of emissions appearing within these frequency bands shall not exceed the limits shown in Section 15.209. At frequencies equal to or less than 1000 MHz, compliance with the limits in Section 15.209



shall be demonstrated using measurement instrumentation employing a CISPR quasi-peak detector. Above 1000 MHz, compliance with the emission limits in Section 15.209 shall be demonstrated based on the average value of the measured emissions. The provisions in Section 15.35 apply to these measurements.

2.3 DESCRIPTION OF TEST MODES

The EUT was tested under following modes:

Modes:

- 1. **Continuous transmitting**

Channels:

- 1. **2.402GHz** (Lowest Channel)
- 2. **2.441GHz** (Middle Channel)
- 3. **2.480GHz** (Highest Channel)

2.4 DESCRIPTION OF THE SUPPORT EQUIPMENTS

Setup Diagram

See test photographs attached in *appendix 1* for the actual connections between EUT and support equipment.

Support Equipment

Peripherals Devices:

OUTSIDE SUPPORT EQUIPMENT							
No.	Equipment	Model	Serial No.	FCC ID/ BSMI ID	Trade name	Data Cable	Power Cord
1.	NB	MS-10342	N/A	N/A	MSI	N/A	N/A
EUT							
No.	Equipment	Model	Serial No.	FCC ID/ BSMI ID	Trade name	Data Cable	Power Cord
1.	PCB 1	N/A	N/A	N/A	N/A	N/A	N/A
2.	PCB 2	GB08-6C	27-050-A9Z	N/A	N/A	N/A	N/A
3.	CABLE	N/A	N/A	N/A	N/A	Unshielded 1.8m	N/A

Note: All the above equipment /cable were placed in worse case position to maximize emission signals during emission test

Grounding: Grounding was in accordance with the manufacturer’s requirement and conditions for the intended use.



3. TEST AND MEASUREMENT EQUIPMENT

3.1 CALIBRATION

The measuring equipment utilized to perform the tests documented in the report has been calibrated once a year or in accordance with the manufacturer's recommendations, and is traceable to recognized national standards.

3.2 EQUIPMENT

The following list contains measurement equipment used for testing. The equipment conforms to the requirement of CISPR 16-1, ANSI C63.2 and. Other required standards.

Calibration of all test and measurement, including any accessories that may effect such calibration, is checked frequently to ensure the accuracy. Adjustments are made and correction factors are applied in accordance with the instructions contained in the respective.

TABLE 1 LIST OF TEST AND MEASUREMENT EQUIPMENT

Instrument	Manufacturer	Model No.	Serial No.	Calibration Due Date	Note
EMC Test Receiver	R&S	ESCI	100438	Aug. 28, 2014	
Bilog Antenna	SUNOL	JB1	A052204	Nov. 21, 2014	
Turn table	EMCO	2080	9508-1805	N/A	
Controller	EMCO	2090	9804-1328	N/A	
RF Cable	JYE BAO	RG214/U	Cable-002	Nov. 22, 2014	
Thermo-Hygro meter	WISEWIND	4-IN-1	050100378	Apr. 08, 2014	
Wideband Peak Power Meter	Anritsu	ML2495A	0841006	Oct. 03, 2014	
Pre-Amplifier	WIRELESS	FPA-6592G	60028	Sep. 06, 2014	
Microwave Preamplifier	EMC INSTRUMENT	EMC051845	980059	Dec. 05, 2014	
EMC Test Receiver	LIG	ER-265	L0907B006	Nov. 22, 2014	
RF Cable_NSA_Rx	HUBER + UHNER	RG213/U	Cable-004	May 21, 2014	
Double Ridged Guide HORN ANTENNA	EST.LINDGREN	3117	00119028	May. 21, 2014	
Microwave Cable	HUBER SUHNER	SUCOFLEX 104	Cable-003-4M	Dec. 05, 2014	
Microwave Cable	HUBER SUHNER	SUCOFLEX 104	Cable-003-3M	Dec. 03, 2014	

※ Calibration interval of instruments listed above is one year



4. ANTENNA REQUIREMENTS

4.1 STANDARD APPLICABLE

For intentional device, according to FCC 47 CFR Section 15.203, an intentional radiator shall be designed to ensure that no antenna other than that furnished by the responsible party shall be used with the device.

And according to FCC 47 CFR Section 15.247(b), if transmitting antennas of direction gain greater than 6dBi are used, the power shall be reduced by the amount in dB that the directional gain of the antenna exceeds 6dBi.

4.2 ANTENNA CONSTRUCTION AND DIRECTIONAL GAIN

Antenna type: Printed antenna

Antenna Gain: 0.37 dBi



5. PEAK OUTPUT POWER

5.1 TEST SETUP



5.2 LIMIT

The maximum peak output power of the intentional radiator shall not exceed the following:

1. According to § 15.247(b)(3) , for systems using digital modulation in the bands of 902 – 928 MHz , 2400 – 2483.5 MHz: 1 Watt.
2. According to § 15.247(b)(4) , the conducted output power limit specified in paragraph (b) of this section is based on the use of antennas with directional gains that do not exceed 6 dBi. Except as shown in paragraph (c) of this section , if transmitting antennas of directional gain greater than 6 dBi are used , the conducted output power from the intentional radiator shall be reduced below the stated values in paragraphs (b)(1) , (b)(2) , and (b)(3) of this section , as appropriate , by the amount in dB that directional gain of the antenna exceeds 6 dBi.

5.3 TEST PROCEDURE

1. Peak power is measured using the wideband power meter.
2. Power is integrated over a bandwidth greater than or equal to the 99% bandwidth.

5.4 TEST RESULT: PASS

5.5 TEST DATA:

Channel No.	Frequency (MHz)	Measurement Level (dbm)	Required Limit (dbm)	Result
0	2402	-1.85	< 30 dbm	PASS
39	2441	-1.27	< 30 dbm	PASS
78	2480	-0.07	< 30 dbm	PASS



6. AVERAGE POWER

6.1 TEST SETUP

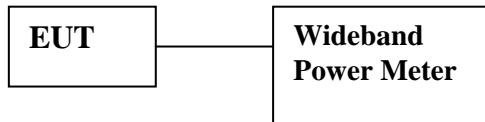

6.2 LIMIT

None ; for reporting purposes only.

6.3 TEST PROCEDURE

The transmitter output is connected to the Power Meter. The Power Meter is set to the average power detection.

6.4 TEST RESULT: PASS

6.5 TEST DATA:

Channel No.	Frequency (MHz)	Measurement Level (dbm)	Required Limit (dbm)	Result
0	2402	-6.62	< 30 dbm	PASS
39	2441	-5.98	< 30 dbm	PASS
78	2480	-4.76	< 30 dbm	PASS

7. BAND EDGE

7.1 TEST SETUP

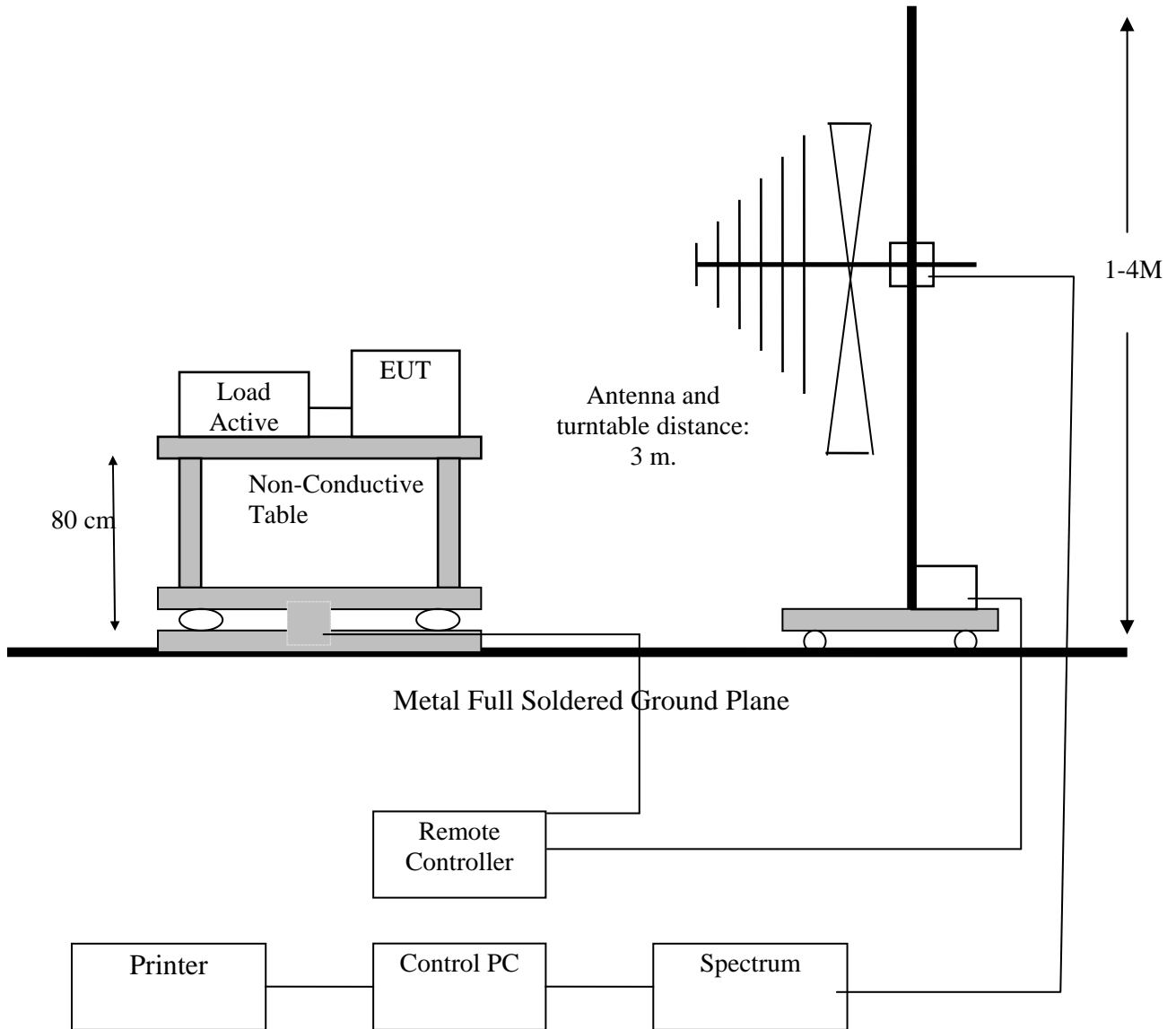



7.2 LIMIT

Restricted Bands:

MHz	MHz	MHz	GHz
0.090 - 0.110	16.42 - 16.423	399.9 - 410	4.5 - 5.15
¹ 0.495 - 0.505	16.69475 - 16.69525	608 - 614	5.35 - 5.46
2.1735 - 2.1905	16.80425 - 16.80475	960 - 1240	7.25 - 7.75
4.125 - 4.128	25.5 - 25.67	1300 - 1427	8.025 - 8.5
4.17725 - 4.17775	37.5 - 38.25	1435 - 1626.5	9.0 - 9.2
4.20725 - 4.20775	73 - 74.6	1645.5 - 1646.5	9.3 - 9.5
6.215 - 6.218	74.8 - 75.2	1660 - 1710	10.6 - 12.7
6.26775 - 6.26825	108 - 121.94	1718.8 - 1722.2	13.25 - 13.4
6.31175 - 6.31225	123 - 138	2200 - 2300	14.47 - 14.5
8.291 - 8.294	149.9 - 150.05	2310 - 2390	15.35 - 16.2
8.362 - 8.366	156.52475 - 156.52525	2483.5 - 2500	17.7 - 21.4
8.37625 - 8.38675	156.7 - 156.9	2690 - 2900	22.01 - 23.12
8.41425 - 8.41475	162.0125 - 167.17	3260 - 3267	23.6 - 24.0
12.29 - 12.293	167.72 - 173.2	3332 - 3339	31.2 - 31.8
12.51975 - 12.52025	240 - 285	3345.8 - 3358	36.43 - 36.5
12.57675 - 12.57725	322 - 335.4	3600 - 4400	(²)
13.36 - 13.41			

Operation within the bands:

902 - 928 MHz, 2400 - 2483.5 MHz, 5725 - 5875 MHz, and 24.0 - 24.25 GHz.

Frequency (Hz)	Field Strength (μ V/m at 3-meter)	Field Strength (dB μ V/m at 3-meter)
1.705-30	30 (at 30-meter)	69.54
30-88	100	40
88-216	150	43
216-960	200	46
Above 960	500	54

7.3 RESULT: PASS



7.4 TEST DATA:

Lowest Channel- Horizontal



環球認證有限公司
Global Certification Corp

Global Certification Corp.
No.146, Sec. 2, Xiangzhang Rd.,
Xizhi Dist., New Taipei City 221, Taiwan (R.O.C.)
TEL:886-2-26426992 FAX:886-2-26487450
WebSite: http://www.gcc.tw

Data: 85

File: C:\Users\GCC\Desktop\e3 DATA\pretest\寶德 藍芽手桿 1021216.EM6

Time: 09:25:26

Date: 2014-1-2

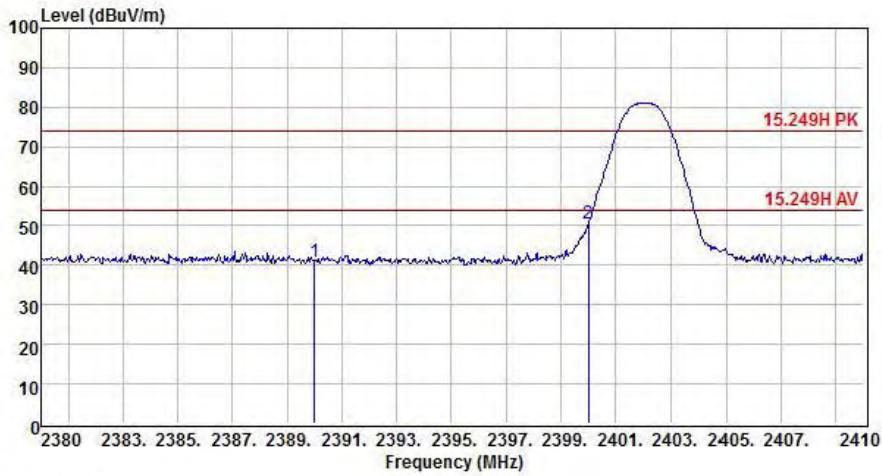

Site : GCC_RE-02
 Condition : 15.249H PK HORIZONTAL
 : RBW:1000 KHz VBW:1000 KHz
 EUT : See Page 1 of EMC Report
 MODEL : See Page 1 for Details
 Test Mode : 20 °C 40%
 TX CHL

Freq	Meter Level	System Factor	Cable Loss	Antenna Factor	Preamp Gain	Real Level	Limit Line	Over Limit	Remark
MHz	dBuV	dB/m	dB	dB/m	dB	dBuV/m	dBuV/m	dB	
1 2389.99	59.82	-18.86	5.09	31.65	55.60	40.96	74.00	-33.04	Peak
2 2400.01	69.42	-18.84	5.10	31.66	55.60	50.58	74.00	-23.42	Peak

System Factor = Cable Loss + Antenna Factor - Preamp Gain
 Real Level = Meter Level + System Factor
 Over Limit = Real Level - Limit Line



Lowest Channel-Vertical



環球認證有限公司
Global Certification Corp.
Global Certification Corp.
No.146, Sec. 2, Xiangzhang Rd.,
Xizhi Dist., New Taipei City 221, Taiwan (R.O.C.)
TEL:886-2-26426992 FAX:886-2-26487450
WebSite: http://www.gcc.tw

Data:88

File:C:\Users\GCC\Desktop\e3 DATA\pretest\寶德 藍芽手棒 1021216.EM6

Time:09:33:18 Date:2014-1-2

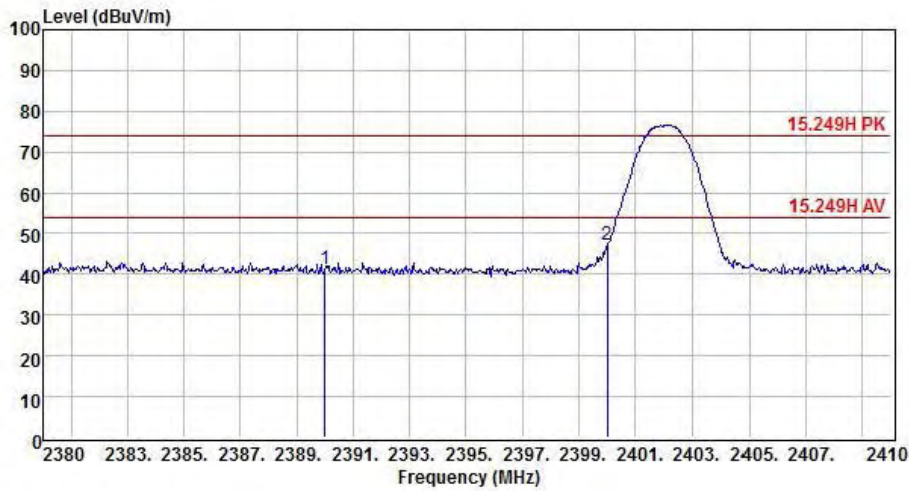

Site : GCC_RE-02
 Condition : 15.249H PK VERTICAL
 : RBW:1000 KHz VEW:1000 KHz
 EUT : See Page 1 of EMC Report
 MODEL : See Page 1 for Details
 Test Mode : 20 °C 40%
 TX CHL

Freq	Meter Level	System Factor	Cable Loss	Antenna Factor	Preamp Gain	Real Level	Limit Line	Over Limit	Remark
MHz	dBuV	dB/m	dB	dB/m	dB	dBuV/m	dBuV/m	dB	
1 2389.99	59.98	-18.86	5.09	31.65	55.60	41.12	74.00	-32.88	Peak
2 2400.01	66.02	-18.84	5.10	31.66	55.60	47.18	74.00	-26.82	Peak

System Factor = Cable Loss + Antenna Factor - Preamp Gain
 Real Level = Meter Level + System Factor
 Over Limit = Real Level - Limit Line



Highest Channel- Horizontal



Global Certification Corp.
環球認證有限公司
No.146, Sec. 2, Xiangzhang Rd.,
Xizhi Dist., New Taipei City 221, Taiwan (R.O.C.)
TEL:886-2-26426992 FAX:886-2-26487450
Global Certification Corp.
WebSite: http://www.gcc.tw

Data: 95 File: C:\Users\GCC\Desktop\e3 DATA\pretest\寶德 藍芽手桿 1021216.EM6
Time: 09:53:32 Date: 2014-1-2

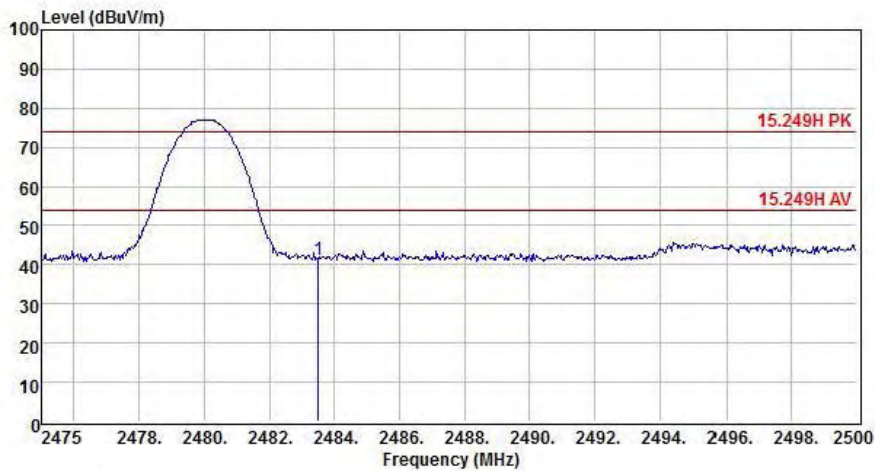

Site : GCC_RE-02
Condition : 15.249H PK VERTICAL
: RBW:1000 KHz VBW:1000 KHz
EUT : See Page 1 of EMC Report
MODEL : See Page 1 for Details
Test Mode : 20 °C 40%
TX CHH

	Meter	System	Cable	Antenna	Preamp	Real	Limit	Over	
Freq	Level	Factor	Loss	Factor	Gain	Level	Line	Limit	Remark
MHz	dBuV	dB/m	dB	dB/m	dB	dBuV/m	dBuV/m	dB	
1 2483.50	59.88	-18.59	5.19	31.78	55.56	41.29	74.00	-32.71	Peak

System Factor = Cable Loss + Antenna Factor - Preamp Gain
Real Level = Meter Level + System Factor
Over Limit = Real Level - Limit Line



Highest Channel- Vertical



Global Certification Corp.
環球認證有限公司
No.146, Sec. 2, Xiangzhang Rd.,
Xizhi Dist., New Taipei City 221, Taiwan (R.O.C.)
Global Certification Corp. TEL:886-2-26426992 FAX:886-2-26487450
WebSite: http://www.gcc.tw

Data:98 File:C:\Users\GCC\Desktop\e3 DATA\pretest\寶德 藍芽手桿 1021216.EM6

Time:09:59:08 Date:2014-1-2

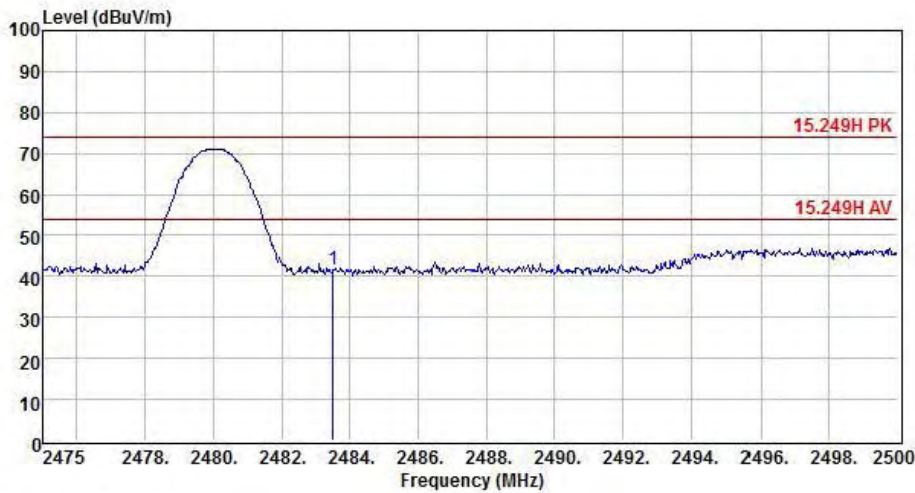

Site : GCC_RE-02
 Condition : 15.249H PK VERTICAL
 : RBW:1000 KHz VBW:1000 KHz
 EUT : See Page 1 of EMC Report
 MODEL : See Page 1 for Details
 Test Mode : 20 °C 40%
 TX CHH

	Meter	System	Cable	Antenna	Preamp	Real	Limit	Over	
Freq	Level	Factor	Loss	Factor	Gain	Level	Line	Limit	Remark
MHz	dBuV	dB/m	dB	dB/m	dB	dBuV/m	dBuV/m	dB	
1 2483.50	60.06	-18.59	5.19	31.78	55.56	41.47	74.00	-32.53	Peak

System Factor = Cable Loss + Antenna Factor - Preamp Gain

Real Level = Meter Level + System Factor

Over Limit = Real Level - Limit Line



Note:

1. Emission level = Reading level + Correction factor
2. Correction factor = Antenna factor + Cable loss – Preamp factor.
3. All emissions as described above were determining by rotating the EUT through three orthogonal axes to maximizing the emissions if the EUT belongs to hand-held or body-worn devices.
4. Measurements above 1000 MHz, Peak detector setting: use a 1 MHz RBW, a 3 MHz VBW.
5. Measurements above 1000 MHz, Average detector setting: 1 MHz RBW with 10 Hz VBW.
6. Peak detector measurement data will represent the worst case results.



8. 20DB BANDWIDTH

8.1 TEST LIMIT

Frequency hopping systems shall have hopping channel carrier frequencies separated by a minimum of 25 kHz or the 20 dB bandwidth of the hopping channel, whichever is greater. Alternatively, frequency hopping systems operating in the 2400-2483.5 MHz band may have hopping channel carrier frequencies that are separated by 25 kHz or two-thirds of the 20 dB bandwidth of the hopping channel, whichever is greater, provided the systems operate with an output power no greater than 125 Mw.

8.2 TEST LIMIT

- a. The transmitter output was connected to the spectrum analyzer.
- b. Set RBW of spectrum analyzer to 30 KHz and VBW to 100KHz.
- c. The 20 dB bandwidth is defined as the total spectrum the power of which is higher than peak power minus 20 dB.

8.3 TEST SETUP LAYOUT

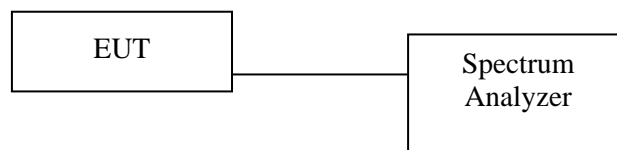

8.4 TEST RESULT AND DATA

Channel	Frequency (MHz)	20dB Bandwidth (KHz)
00	2402	1136KHz
39	2441	1118KHz
78	2480	1127KHz



8.5 TEST DATA:

LOW FREQUENCY

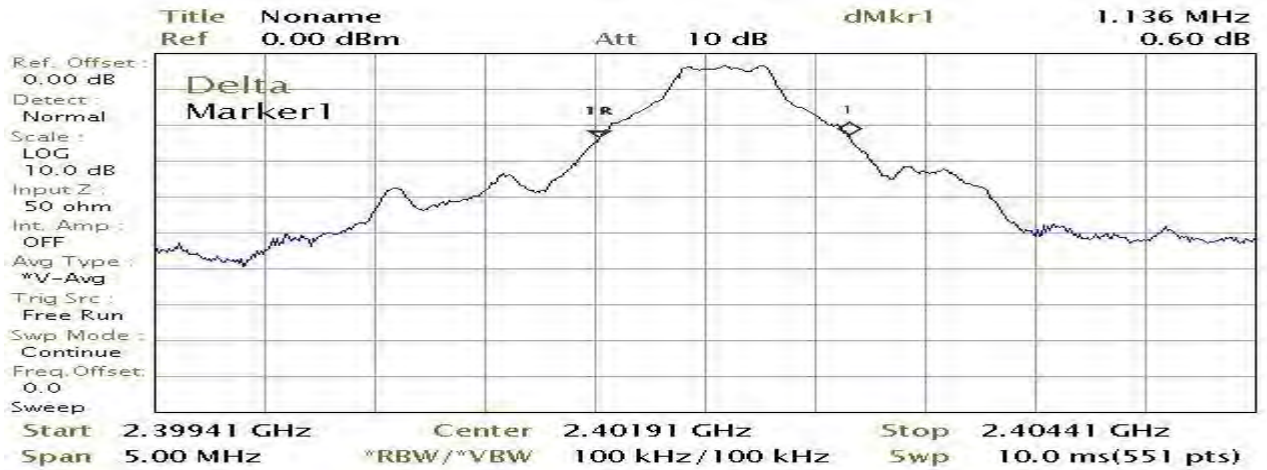

MIDDLE FREQUENCY

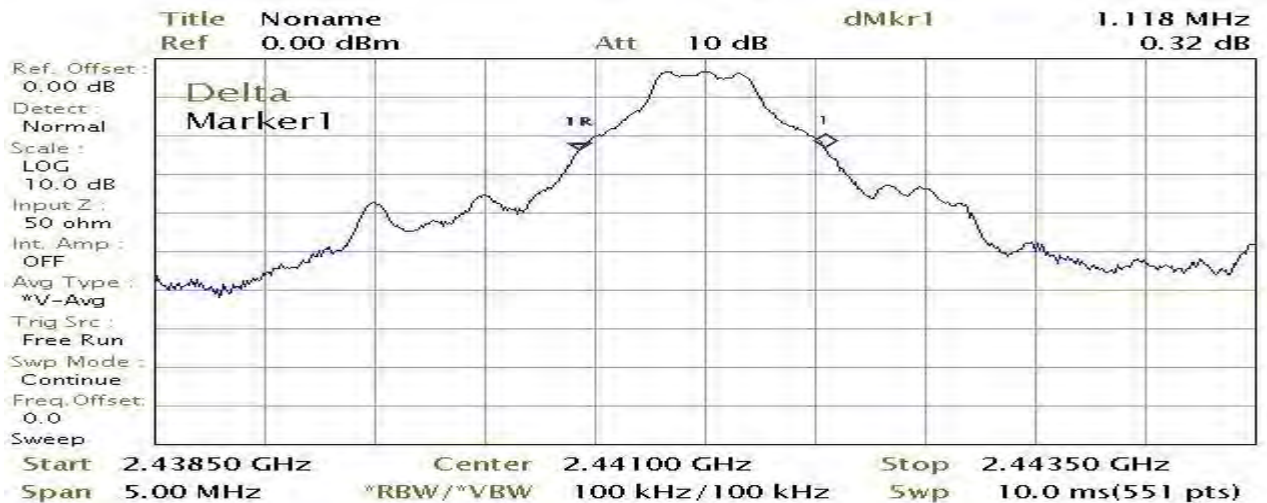

HIGH FREQUENCY

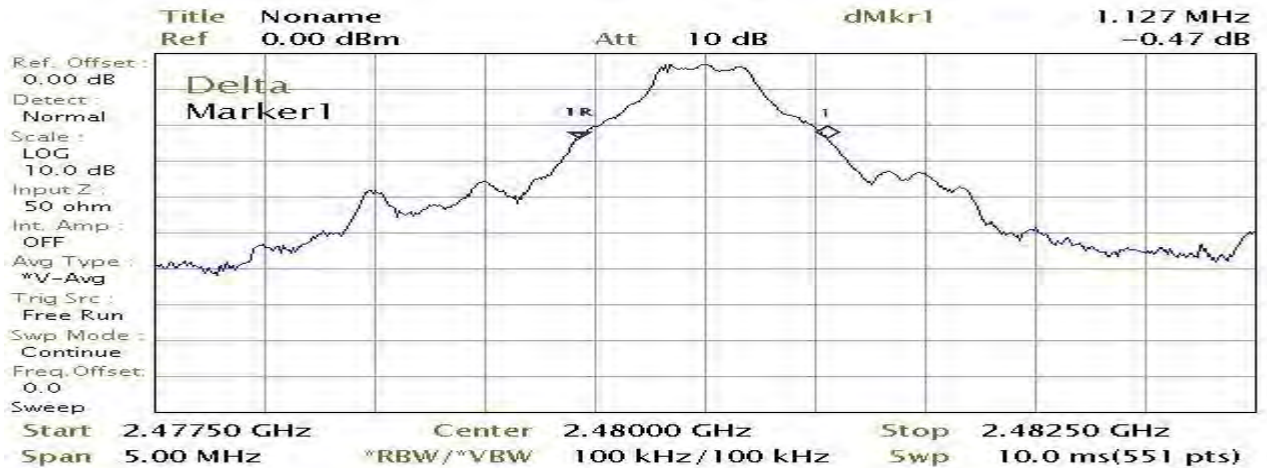

9. RADIATED EMISSION

9.1 TEST SETUP

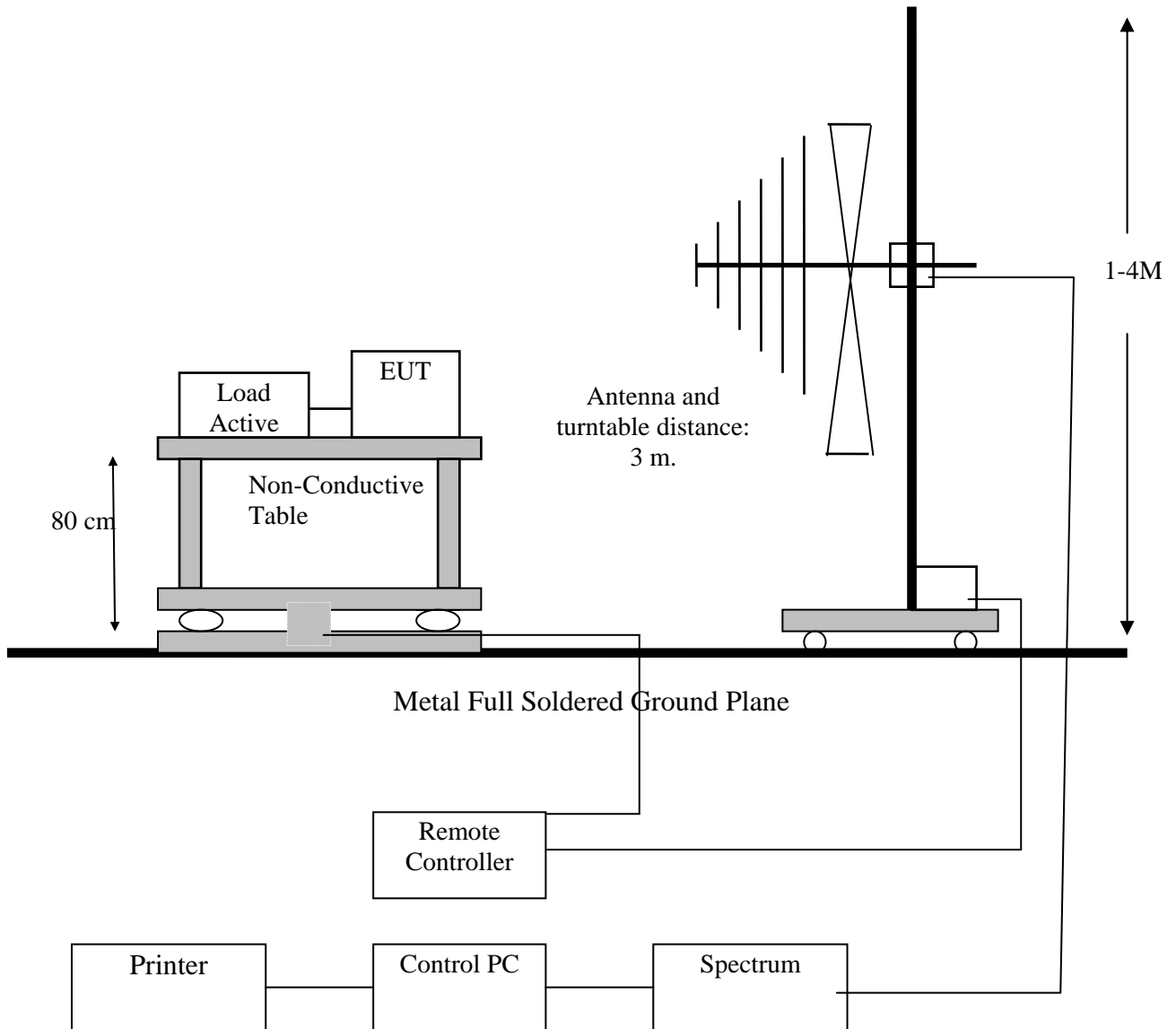



9.2 LIMIT

The field strength of any emissions which appear outside of this band shall not exceed the general radiated emission limits in section 15.209 as below.

Frequency (MHz)	Field Strength (mV/m)	Measurement Distance (m)
1.705-30	30	30
30-88	100*	3
88-216	150*	3
216-960	200*	3
Above 960	500*	3

**Except as provided in paragraph (g), fundamental emissions from intentional radiators operating under this Section shall not be located in the frequency bands 54-72 MHz, 76-88 MHz, 174-216 MHz or 470-806 MHz. However, operation within these frequency bands is permitted under other sections of this Part, e.g., Sections 15.231 and 15.241.*

In the above emission table, the tighter limit applies at the band edges.

Frequency (Hz)	Field Strength ($\mu\text{V/m}$ at 3-meter)	Field Strength ($\text{dB}\mu\text{V/m}$ at 3-meter)
1.705-30	30 (at 30-meter)	69.54
30-88	100	40
88-216	150	43
216-960	200	46
Above 960	500	54

9.3 TEST PROCEDURE

- 1、 The EUT was placed on a turntable, which was 0.8m above ground plane.
- 2、 The turntable was rotated for 360 degrees to determine the position of maximum emission level.
- 3、 EUT was set at 3m away from the receiving antenna, which was varied from 1m to 4m to find out the highest emissions.
- 4、 Maximum procedure was performed on the six highest emissions to ensure EUT compliance.
- 5、 And also, each emission was maximized by changing the polarization of receiving antenna, both horizontal and vertical.
- 6、 Repeated above procedures until the measurements for all frequencies are completed.

9.4 RESULT: PASS



9.5 TEST DATA:

All frequencies not described in this test report and within the range of the general radiated emission limits are not detectable significantly. The table as below is representing worst emissions found.

Lowest Channel (worst emissions found)

Horizontal

Frequency (MHz)	Reading (dBuV)	Correction factor(dB)	D.C.F	Spurious Emissions (dBuV/m)	Limit (dBuV/m)	Remark
70.74	36.15	-19.97		16.18	40.00	Peak
239.52	41.58	-15.13		26.45	46.00	Peak
480.08	30.21	-8.03		22.18	46.00	Peak
599.39	33.91	-5.23		28.68	46.00	Peak
665.35	38.74	-3.74		35.00	46.00	Peak
859.35	33.35	-0.02		33.33	46.00	Peak
4802.50	79.08	-14.84		64.24	74.00	Peak
4802.50	79.08	-14.84	-30.20	34.04	54.00	Average
7195.00	56.68	-11.24		45.44	74.00	Peak
9610.00	56.87	-9.71		47.16	74.00	Peak

Vertical

Frequency (MHz)	Reading (dBuV)	Correction factor(dB)	Spurious Emissions (dBuV/m)	Limit (dBuV/m)	Remark
70.74	36.01	-19.97	16.04	40.00	Peak
176.47	35.57	-15.81	19.76	43.00	Peak
344.28	34.54	-11.78	22.76	46.00	Peak
599.39	34.75	-5.23	29.52	46.00	Peak
665.35	36.06	-3.74	32.32	46.00	Peak
859.35	36.41	-0.02	36.39	46.00	Peak
4802.50	62.30	-14.84	47.46	74.00	Peak
7210.00	56.14	-11.23	44.91	74.00	Peak
9617.50	56.82	-9.71	47.11	74.00	Peak



Middle Channel

Horizontal

Frequency (MHz)	Reading (dBuV)	Correction factor(dB)	D.C.F	Spurious Emissions (dBuV/m)	Limit (dBuV/m)	Remark
70.74	34.47	-19.97		14.50	40.00	Peak
153.19	33.32	-14.63		18.69	43.00	Peak
450.01	39.03	-8.85		30.18	46.00	Peak
599.39	35.90	-5.23		30.67	46.00	Peak
665.35	35.26	-3.74		31.52	46.00	Peak
859.35	35.44	-0.02		35.42	46.00	Peak
4885.00	70.50	-14.74		55.76	74.00	Peak
4885.00	70.50	-14.74	-30.20	25.56	54.00	Average
7330.00	45.43	-11.17		34.26	74.00	Peak
9767.50	47.38	-9.62		37.76	74.00	Peak

Vertical

Frequency (MHz)	Reading (dBuV)	Correction factor(dB)	Spurious Emissions (dBuV/m)	Limit (dBuV/m)	Remark
70.74	35.39	-19.97	15.42	40.00	Peak
239.52	43.27	-15.13	28.14	46.00	Peak
299.66	34.62	-12.94	21.68	46.00	Peak
480.08	31.39	-8.03	23.36	46.00	Peak
666.32	37.28	-3.71	33.57	46.00	Peak
859.35	32.84	-0.02	32.82	46.00	Peak
4885.00	59.90	-14.74	45.16	74.00	Peak
7360.00	56.55	-11.16	45.39	74.00	Peak
9767.50	55.58	-9.62	45.96	74.00	Peak



Highest Channel

Horizontal

Frequency (MHz)	Reading (dBuV)	Correction factor(dB)	D.C.F	Spurious Emissions (dBuV/m)	Limit (dBuV/m)	Remark
70.74	35.08	-19.97		15.11	40.00	Peak
239.52	42.93	-15.13		27.8	46.00	Peak
299.66	34.60	-12.94		21.66	46.00	Peak
480.08	30.57	-8.03		22.54	46.00	Peak
665.35	35.92	-3.74		32.18	46.00	Peak
859.35	32.61	-0.02		32.59	46.00	Peak
4967.50	71.21	-14.65		56.56	74.00	Peak
4967.50	71.21	-14.65	-30.20	26.36	54.00	Average
7442.50	57.17	-11.12		46.05	74.00	Peak
9910.00	57.57	-9.54		48.03	74.00	Peak

Vertical

Frequency (MHz)	Reading (dBuV)	Correction factor(dB)	Spurious Emissions (dBuV/m)	Limit (dBuV/m)	Remark
70.74	33.89	-19.97	13.92	40.00	Peak
208.48	31.23	-15.78	15.45	43.00	Peak
345.25	30.78	-11.74	19.04	46.00	Peak
599.39	35.08	-5.23	29.85	46.00	Peak
666.32	34.43	-3.71	30.72	46.00	Peak
859.35	35.58	-0.02	35.56	46.00	Peak
4967.50	64.04	-14.65	55.47	74.00	Peak
7435.00	55.91	-11.12	54.61	74.00	Peak
9917.50	57.66	-9.53	55.26	74.00	Peak

Note:

1. Emission level = Reading level + Correction factor
2. Correction factor: Antenna factor + Cable loss – Preamp factor.
3. All emissions as described above were determining by rotating the EUT through three orthogonal axes to maximizing the emissions if the EUT belongs to hand-held or body-worn devices.
4. Measurements from 9 kHz to 150 kHz, Peak detector setting: 100 Hz RBW
5. Measurements from 150 kHz to 30MHz, Peak detector setting: 10 kHz RBW



6. Measurements from 30 MHz to 1000 MHz, Peak detector setting: 100 kHz RBW
7. Measurements from 9 kHz to 150 kHz, CISPR Quasi-Peak detector: 200 Hz RBW
8. Measurements from 150 kHz to 30MHz, CISPR Quasi-Peak detector: 9 kHz RBW
9. Measurements from 30 MHz to 1000 MHz, CISPR Quasi-Peak detector: 120 kHz RBW
10. Peak detector measurement data will represent the worst case results.
11. D.C.F (Duty Cycle Correction Factor) = $20\log(\text{the worst Case DWELL Time} / 100\text{ms})$
= $20\log(3.091\text{ms} / 100\text{ms}) = -30.20$

10. CONDUCTED EMISSIONS

10.1 TEST SETUP

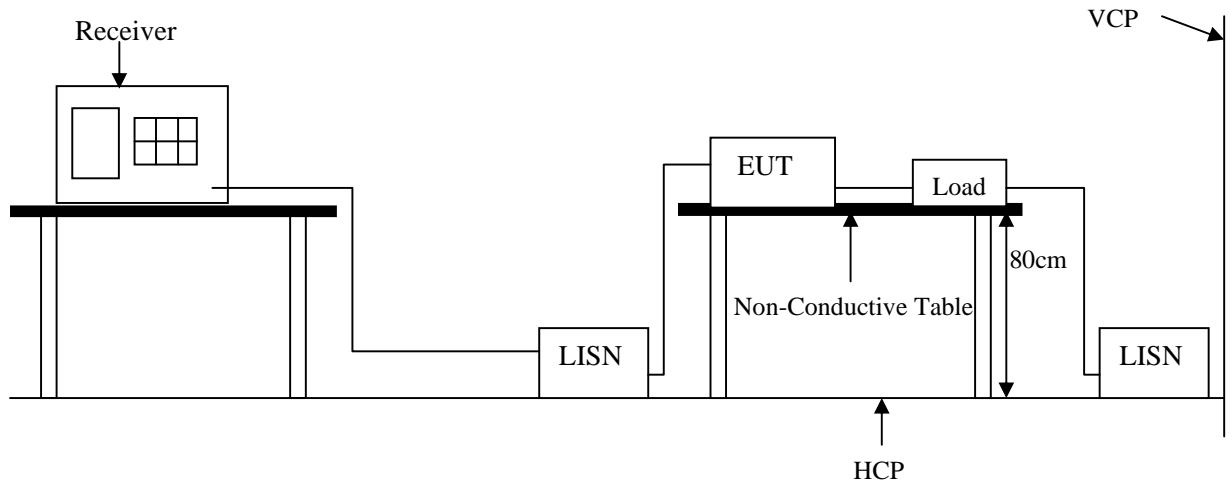

10.2 LIMIT

Frequency range (MHz)	CLASS A		CLASS B	
	QP dB(uV)	Average dB(uV)	QP dB(uV)	Average dB(uV)
0.15-0.5	79 dBuV	66 dBuV	66 - 56 dBuV	56 - 46 dBuV
0.5-5.0	73 dBuV	60 dBuV	56 dBuV	46 dBuV
5.0-30.0	73 dBuV	60 dBuV	60 dBuV	50 dBuV

Remark: In the above table, the tighter limit applies at the band edges.

10.3 TEST PROCEDURE

The EUT and simulators are connected to the main power through a line impedance stabilization network (LISN). It provides a 50 ohm / 50 μ H coupling impedance for the measuring equipment. The peripheral devices are also connected to the main power through a LISN that provides a 50 ohm / 50 μ H coupling impedance with 50 ohm termination. (Please refer to the block diagram of the test setup and photograph.)

Both sides of AC line are checked for the maximum conducted emission interference. In order to find the maximum emissions, the relating positions of equipment and all of the interference cables must be changed according to EN 55022 regulations: The measurement procedure on conducted emission interference.

The resolution bandwidth of the field strength meter is set at 9 KHz.

10.4 TEST SPECIFICATION

According to PART 15.207

10.5 RESULT:

Not applicable, because the EUT doesn't connect with the AC power source directly.

10.6 TEST DATA: N/A



11. SPURIOUS EMISSIONS (CHANNEL CARRIER FREQUENCIES SEPARATION)

11.1 CONDUCTED MEASUREMENT

11.2 TEST SETUP

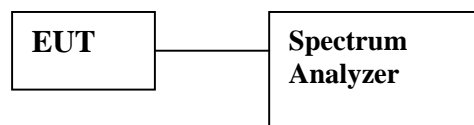

11.3 LIMIT

According to § 15.247(d) , in any 100 kHz bandwidth outside the frequency bands in which the spread spectrum intention radiator in operating , the radio radio frequency power that is produced by the intentional radiator shall be at least 20 dB below that in the 100 kHz bandwidth within the band that contains the highest level of the desired power , based on either an RF conducted or a radiated measurement , provided the transmitter demonstrates compliance with the peak conducted power limits. In addition, radiated emissions which fall in the restricted bands , as defined in § 15.205(a) , must also comply with the radiated emission limits specified in 15.209(a) (see Section 15.205(c)).

11.4 TEST PROCEDURE

Conducted RF measurements of the transmitter output were made to confirm that the EUT antenna port conducted emissions meet the specified limit and to identify any spurious signals that require further investigation or measurements on the radiated emissions site.

The transmitter output is connected to the spectrum analyzer. The resolution bandwidth is set to 100 kHz. The video bandwidth is set to 100 kHz.

11.5 TEST RESULTS: PASS



11.6 TEST DATA:

Modulation Standard: GFSK (1Mbps)

Channel	Frequency (MHz)	Channel Separation
00	2402	1000KHz
39	2441	1000KHz
78	2480	1000KHz

Lowest Channel

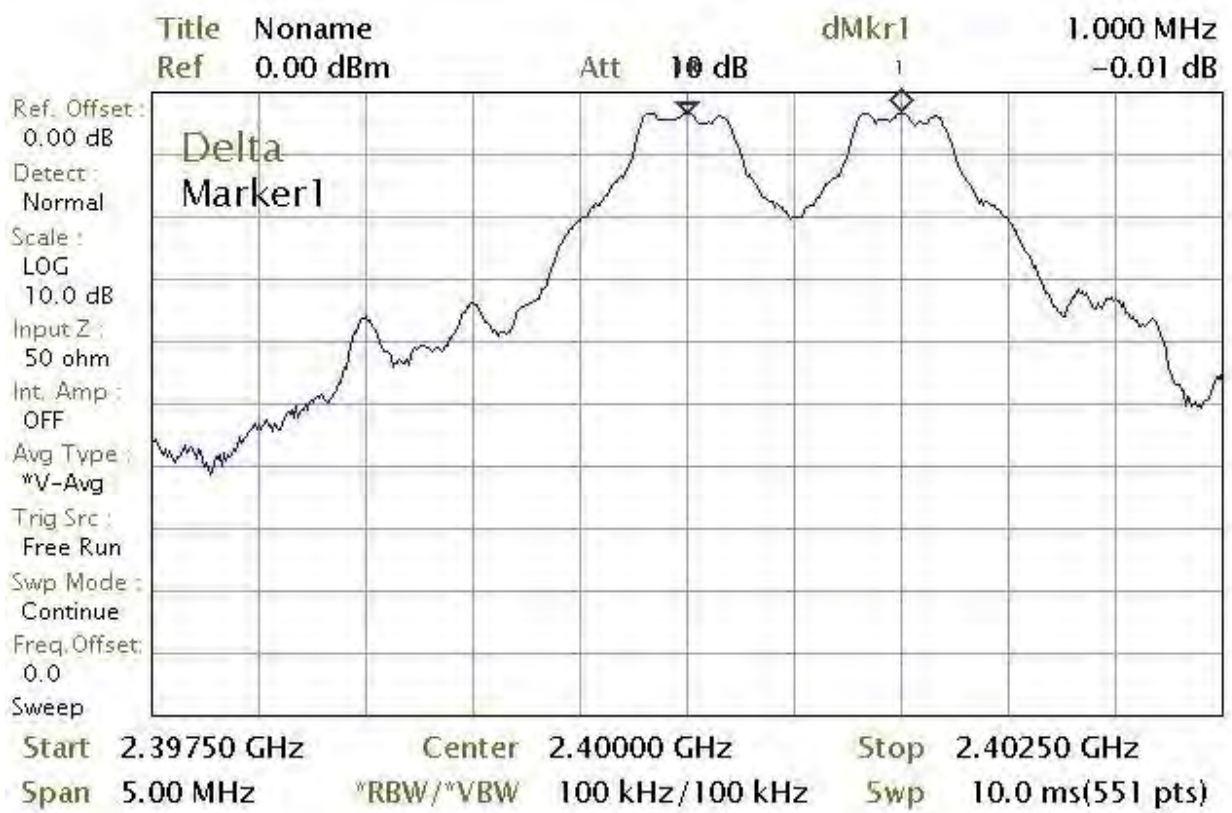



Middle Channel

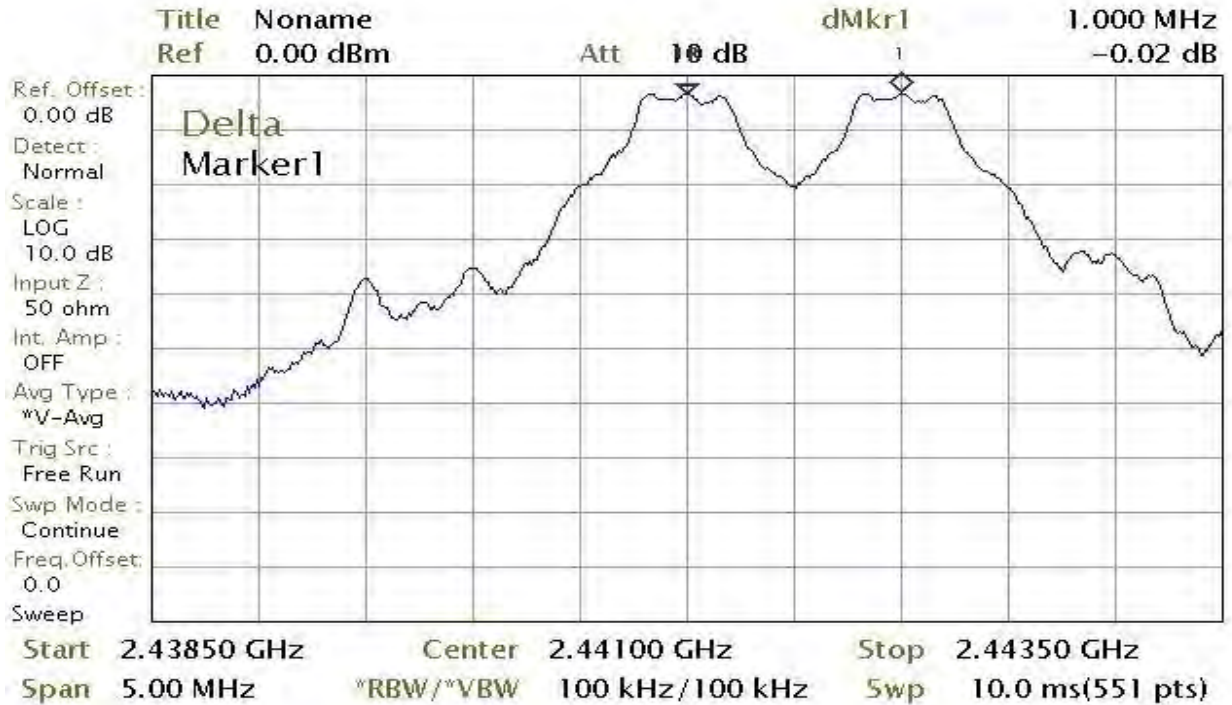

Highest Channel

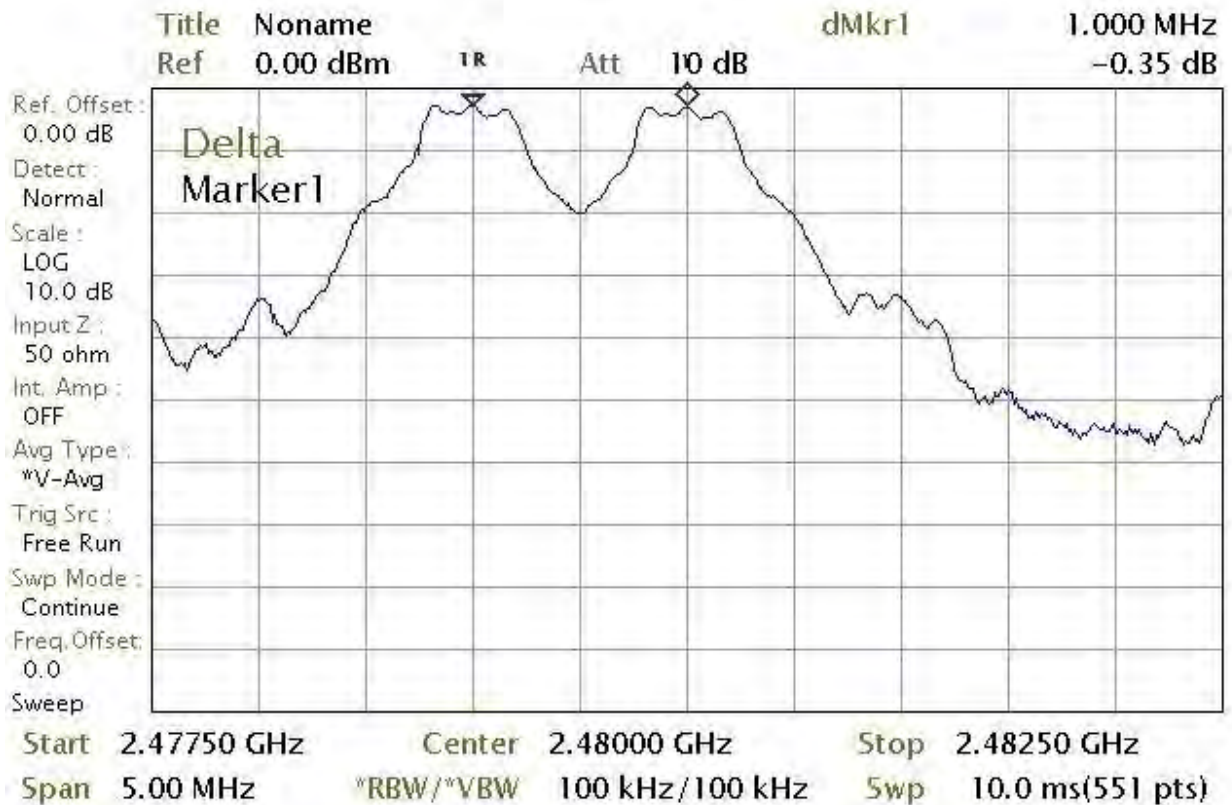



12. DWELL TIME ON EACH CHANNEL

12.1 TEST SETUP



12.2 TEST LIMIT

The average time of occupancy on any channel shall not be greater than 0.4 seconds within a period of 0.4 seconds multiplied by the number of hopping channels employed.

12.3 TEST PROCEDURES

- 1) The transmitter output was connected to the spectrum analyzer.
- 2) Adjust the center frequency to measure frequency, then set zero span mode.
- 3) Set RBW of spectrum analyzer to 1000 KHz and VBW to 1000 KHz.
- 4) Measure the time duration of one transmission on the measured frequency.

12.4 TEST RESULTS: PASS

12.5 TEST DATA:

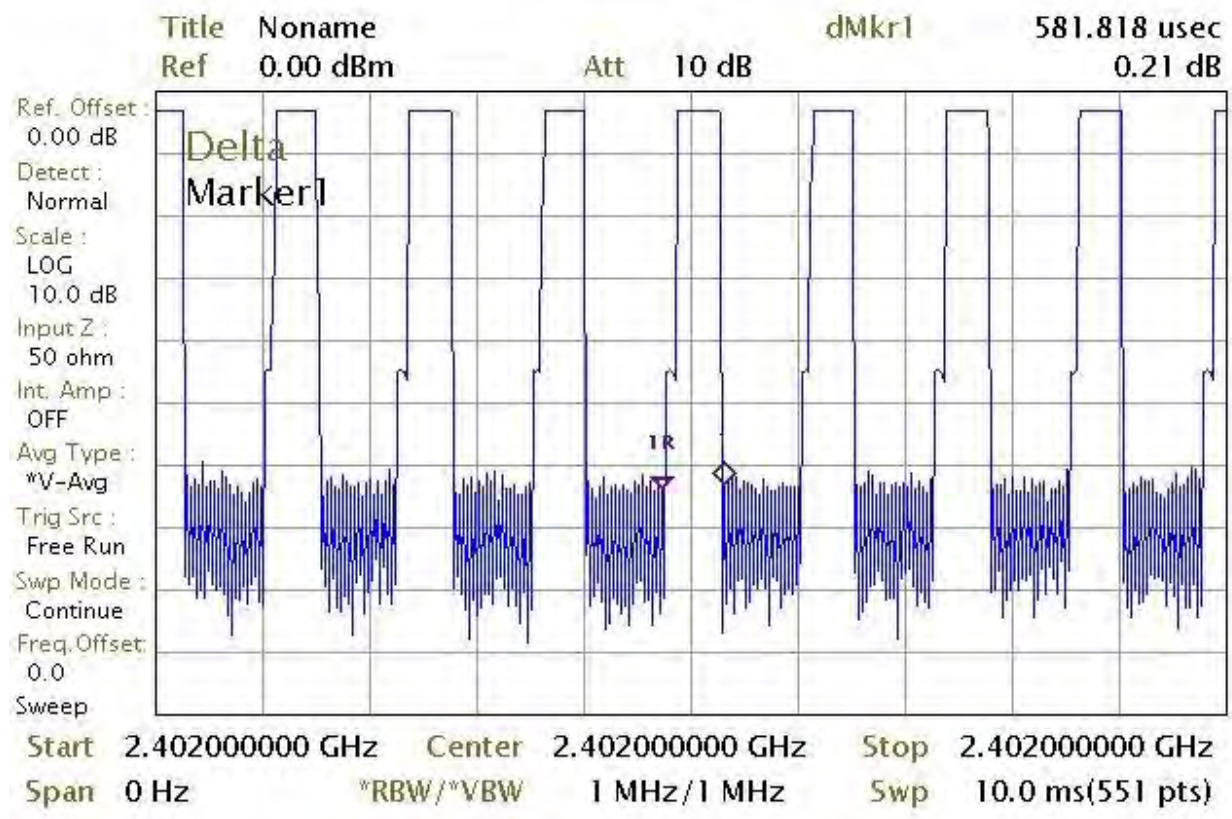

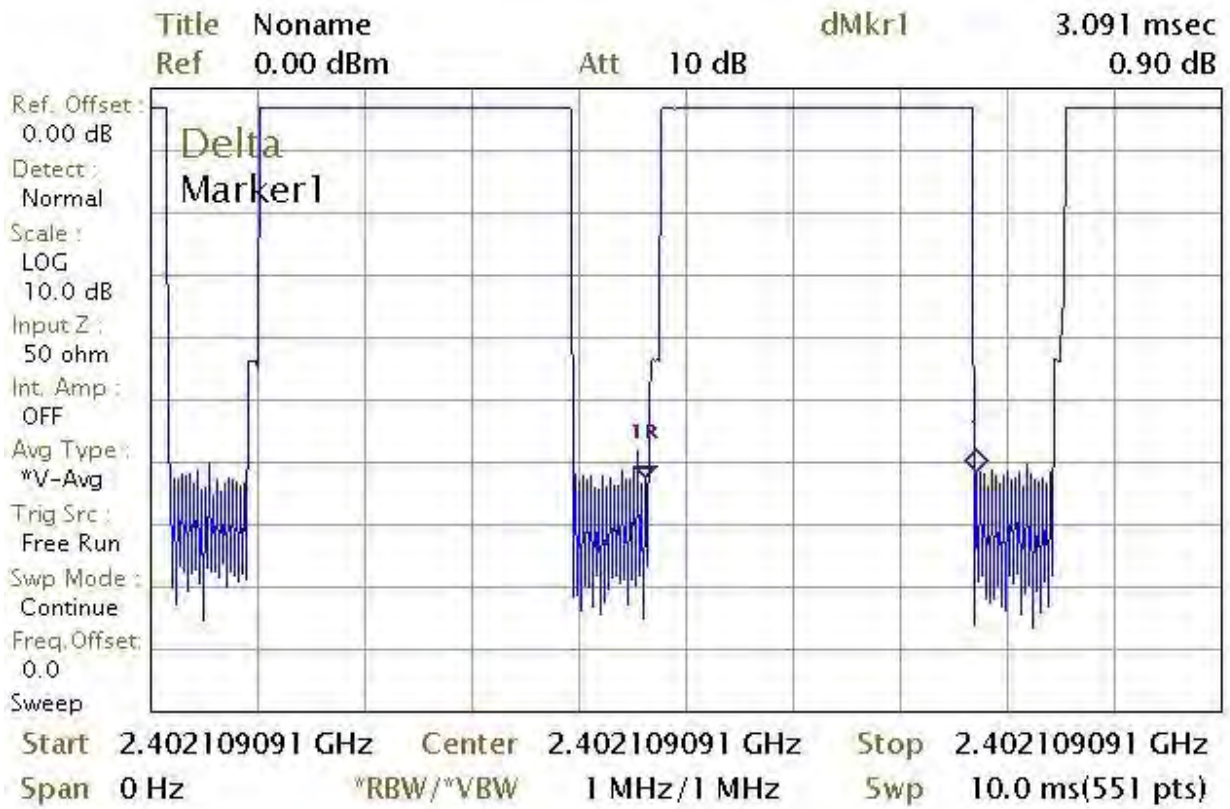
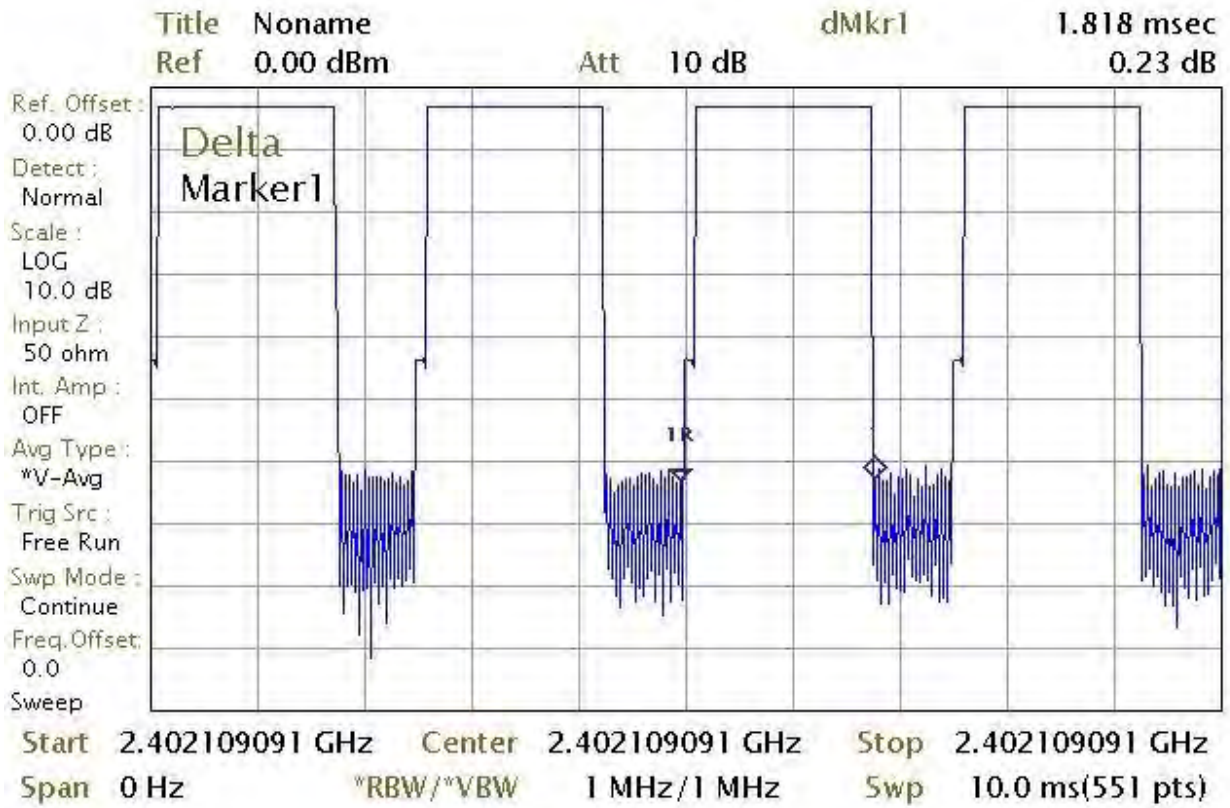



13. NUMBER OF HOPPING CHANNELS

13.1 TEST LIMIT

Frequency hopping systems in the 2400~2483.5MHz band shall use at least 15 channels.

13.2 TEST PROCEDURES

- a. The transmitter output was connected to the spectrum analyzer.
- b. 2. Set RBW of spectrum analyzer to 1000 KHz and VBW to 1000 KHz.
- c. 3. Set the Max Hold function, and then keep the EUT in hopping mode. Record all the signals from each channel until each one has been record.

13.3 TEST SETUP LAYOUT

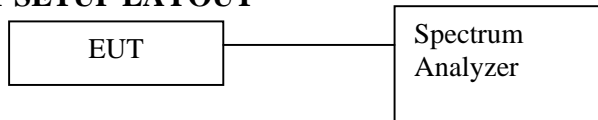

13.4 TEST RESULT AND DATA

Modulation Standard: GFSK (1Mbps)

Number of hopping channels:	79	channels
-----------------------------	----	----------

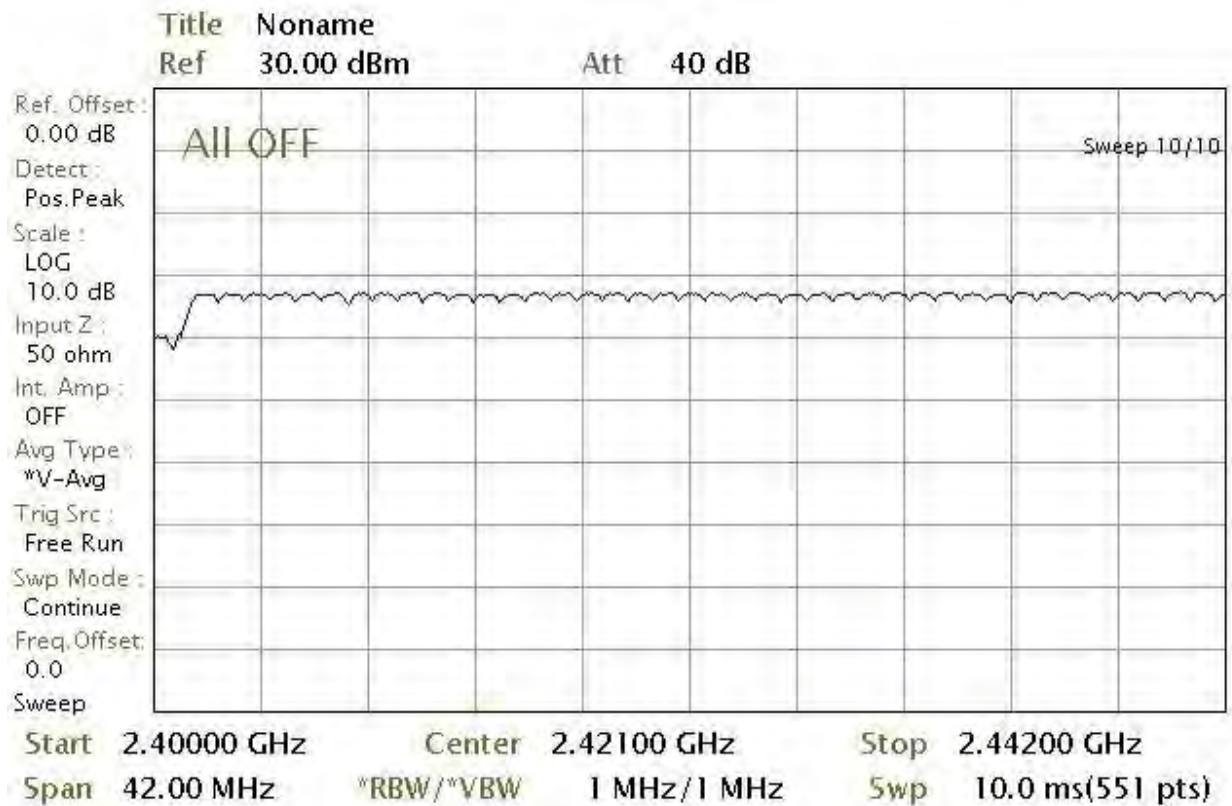

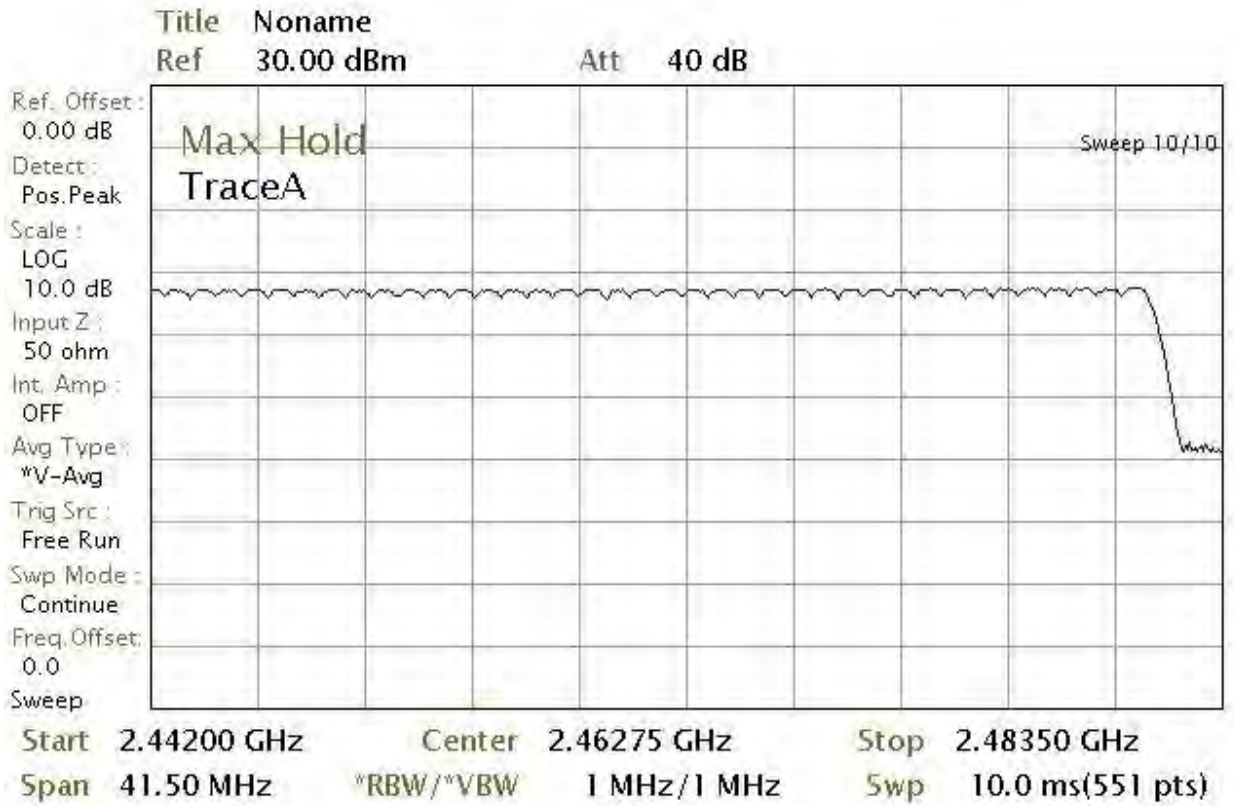



Global Certification Corp.

Appendix 1

RADIO FREQUENCY EXPOSURE