

H WIRELESS

 **steelseries**

STICKER



TRANSMITTER

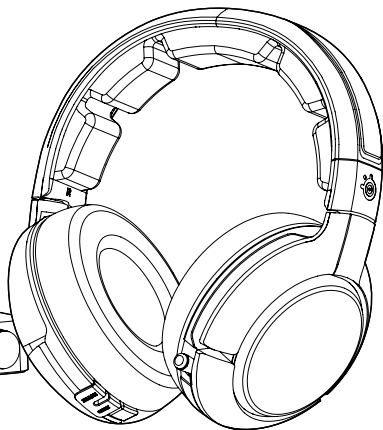
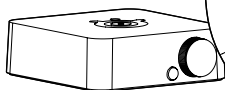

POWER

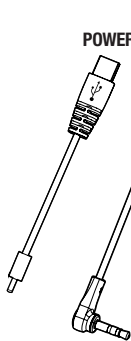

MOBILE



CHAT



ANALOG



OPTICAL



USB



2 BATTERIES (ONE IN HEADSET)

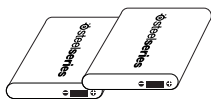

POWER ADAPTER

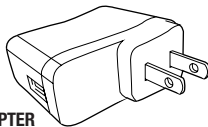

XBOX CONNECTION

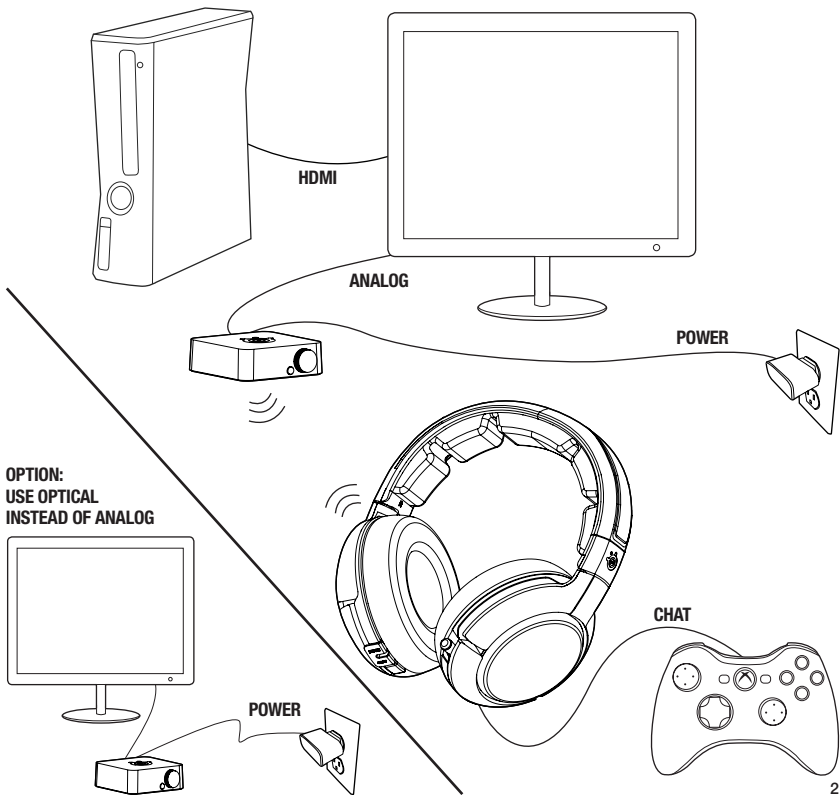

PLAYSTATION CONNECTION

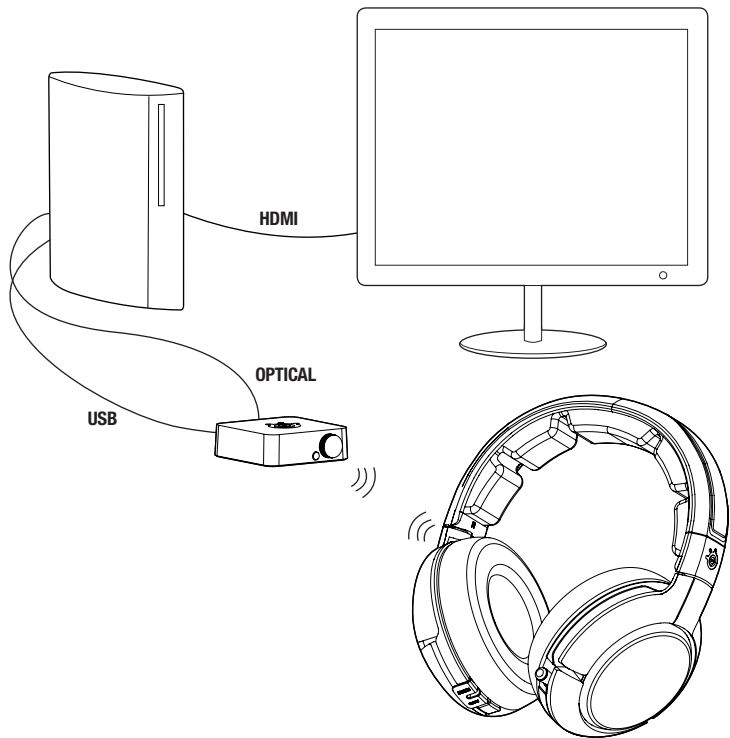

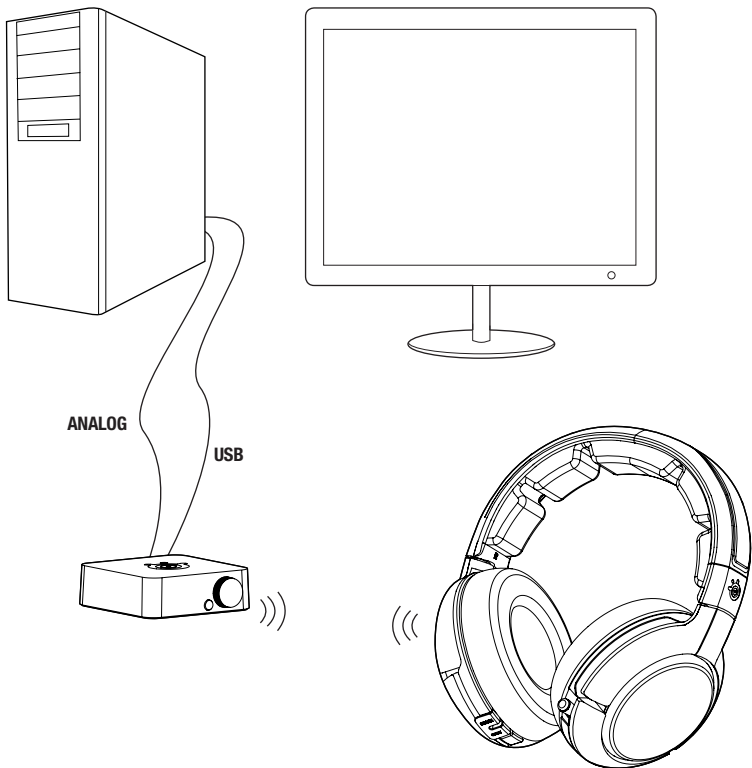

SOUND TEST

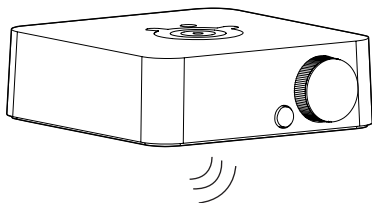

← **PRESS DIAL TO SELECT
AND TURN TO NAVIGATE**

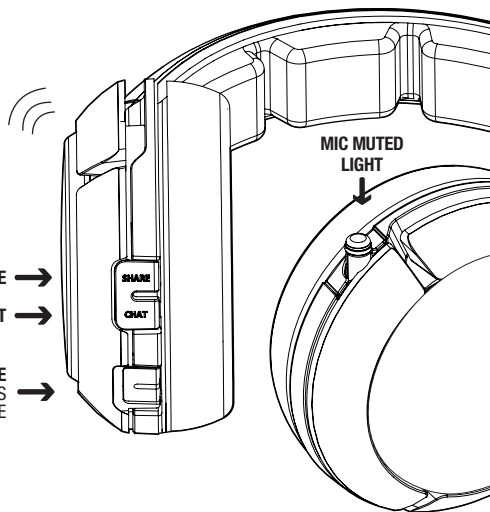

SHARE →

CHAT →

POWER / MUTE →
POWER: PRESS AND HOLD FOR TWO SECONDS
MUTE: PRESS AND RELEASE

**MIC MUTED
LIGHT**

MAIN MENU > AUDIO > CHATMIX



MAIN MENU > AUDIO > LIVEMIX



MAIN MENU > AUDIO > DOLBY



HOME SCREEN





BC

FCC Regulations:

- This device complies with Part 15 of the FCC Rules. Operation is subject to the following two conditions: (1) This device may not cause harmful interference, and (2) this device must accept any interference received, including interference that may cause undesired operation.
- This equipment has been tested and found to comply with the limits for a Class B digital device, pursuant to Part 15 of the FCC Rules. These limits are designed to provide reasonable protection against harmful interference in a residential installation. This equipment generates, uses and can radiate radio frequency energy and, if not installed and used in accordance with the instructions, may cause harmful interference to radio communications. However, there is no guarantee that interference will not occur in a particular installation. If this equipment does cause harmful interference to radio or television reception, which can be determined by turning the equipment off and on, the user is encouraged to try to correct the interference by one of the following measures:
 - A. Reorient or relocate the receiving antenna.
 - B. Increase the separation between the equipment and receiver.
 - C. Connect the equipment into an outlet on a circuit different from that to which the receiver is connected.
 - D. Consult the dealer or an experienced radio/TV technician for help.

- FCC Caution: Any changes or modifications not expressly approved by the party responsible for compliance could void the user's authority to operate this equipment.
- This transmitter must not be co-located or operating in conjunction with any other antenna or transmitter.
- **Radiation Exposure Statement: (For Model Name: 61298TX, FCC ID : ZHK-61298TX)**
This equipment complies with FCC radiation exposure limits set forth for an uncontrolled environment. This equipment should be installed and operated with minimum distance 20cm between the radiator & your body.

IC Regulations:

- This device complies with Industry Canada license-exempt RSS standard(s). Operation is subject to the following two conditions: (1) this device may not cause interference, and (2) this device must accept any interference, including interference that may cause undesired operation of the device.

Le présent appareil est conforme aux CNR d'Industrie Canada applicables aux appareils radio exempts de licence. L'exploitation est autorisée aux deux conditions suivantes: (1) l'appareil ne doit pas produire de brouillage, et (2) l'utilisateur de l'appareil doit accepter tout brouillage radioélectrique subi, même si le brouillage est susceptible d'en compromettre le fonctionnement.

- This Class B digital apparatus complies with Canadian ICES-003.

Cet appareil numérique de la classe B est conforme à la norme NMB-003 du Canada.

- This device and its antenna(s) must not be co-located or operating in conjunction with any other antenna or transmitter, except tested built-in radios. The County Code Selection feature is disabled for products marketed in the US/ Canada.

Cet appareil et son antenne ne doivent pas être situés ou fonctionner en conjonction avec une autre antenne ou un autre émetteur, exception faites des radios intégrées qui ont été testées. La fonction de sélection de l'indicateur du pays est désactivée pour les produits commercialisés aux États-Unis et au Canada.

- **Radiation Exposure Statement: (For Model Name: 61298TX, IC ID: 9638A-61298TX)**
This equipment complies with IC radiation exposure limits set forth for an uncontrolled environment. This equipment should be installed and operated with minimum distance 20cm between the radiator & your body.

Déclaration d'exposition aux radiations: (For Model Name: 61298TX, IC ID: 9638A-61298TX)

Cet équipement est conforme aux limites d'exposition aux rayonnements IC établies pour un environnement non contrôlé. Cet équipement doit être installé et utilisé avec un minimum de 20 cm de distance entre la source de rayonnement et votre corps.

R&TTE Regulations:

- Products with CE marking comply with the R&TTE Directive (99/5/EC), the EMC Directive (2004/108/EC), and the Low Voltage Directive (2006/95/EC) issued by the Commission of the European Community.
- *For the device which tests accordance to EN60950-1:2006+A11:2009+A1:2010+A12:2011, it is mandatory to perform audio tests for EN50332.
- This device have been tested to comply with the Sound Pressure Level requirement laid down in the applicable EN 50332-1and/or EN 50332-2 standards.
- Prevention of hearing loss



CAUTION: Permanent hearing loss may occur if earphones or headphones are used at high volume for prolonged periods of time.

Excessive sound pressure from earphones and headphones can cause hearing loss.

NOTE: For France, Earphone (listed below) for this device have been tested to comply with the Sound Pressure Level requirement laid down in the applicable NF EN 50332-1:2000 and/or NF EN 50332-2:2003 standards as required by French Article L. 5232-1.



RISK OF EXPLOSION IF BATTERY IS REPLACED BY AN INCORRECT TYPE. DISPOSE OF USED BATTERIES ACCORDING TO THE INSTRUCTIONS.

NCC Regulations:

- 經型式認證合格之低功率射頻電機，非經許可，公司、商號或使用者均不得擅自變更頻率、加大功率或變更原設計之特性及功能。
- 低功率射頻電機之使用不得影響飛航安全及干擾合法通信；經發現有干擾現象時，應立即停用，並改善至無干擾時方得繼續使用。前項合法通信，指依電信法規定作業之無線電通信。低功率射頻電機須忍受合法通信或工業、科學及醫療用電波輻射性電機設備之干擾。



The WEEE logo (shown at the left) on the product or on its box indicates that this product must not be disposed of or dumped with your other household waste. You are liable to dispose of all your electronic or electrical waste equipment by relocating over to the specified collection point for recycling of such hazardous waste. Isolated collection and proper recovery of your electronic and electrical waste equipment at the time of disposal will allow us to help conserving natural resources. Moreover, proper recycling of the electronic and electrical waste equipment will ensure safety of human health and environment. For more information about electronic and electrical waste equipment disposal, recovery, and collection points, please contact your local city center, household waste disposal service, shop from where you purchased the equipment, or manufacturer of the equipment.



FAQ.STEELSERIES.COM

PlayStation is a registered trademark of Sony Computer Entertainment Inc.

Mac is a trademark of Apple Inc., registered in the U.S. and other countries.

Xbox is a registered trademark of Microsoft Corporation in the United States and other countries.

Dolby, Dolby Headphone, Dolby Pro Logic, Dolby Digital and the double-D symbol are registered trademarks of Dolby Laboratories, Inc.



WWW.STEELSERIES.COM