

RADIO TEST REPORT

Report No: 1706002F01

Issued for

Cao Gadgets, LLC

50 Tesla Irvine California United States 92618

Product Name:	Outdoor Probe
Brand Name:	Wireless Sensor Tags
Model Name:	ZGW11
Series Model:	N/A
FCC ID:	ZGW11
Test Standard:	FCC Part 15.231

Any reproduction of this document must be done in full. No single part of this document may be reproduced without permission from BZT, All Test Data Presented in this report is only applicable to presented Test sample.

BZT Testing Technology Co., Ltd

Add. : Buliding 17, Xinghua Road Xingwei industrial Park Fuyong,
Baoan District, Shenzhen, Guangdong, China

TEL: +86-755 3307 1680 FAX: +86-755 27341758 E-mail:bruce@bzt.Cn

TEST REPORT CERTIFICATION

Applicant's name: Cao Gadgets, LLC

Address: 50 Tesla Irvine California United States 92618

Manufacture's Name.....: Cao Gadgets, LLC

Address: 50 Tesla Irvine California United States 92618

Product description

Product name: Outdoor Probe

Brand name.....: Wireless Sensor Tags

Model and/or type reference: ZGW11

Standards.....: FCC Part 15.231

Test procedure.....: ANSI C63.10-2013

This device described above has been tested by BZT, the test results show that the equipment under test (EUT) is in compliance with the FCC requirements. And it is applicable only to the tested sample identified in the report.

This report shall not be reproduced except in full, without the written approval of BZT, this document may be altered or revised by BZT, personal only, and shall be noted in the revision of the document.

Date of Test

Date of performance of tests..... 05 June. 2017 ~ 15 June. 2017

Date of Issue 17 June. 2017

Test Result..... **Pass**

Testing Engineer : 

(Sean she)

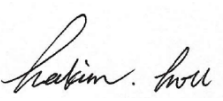
Technical Manager : 

(Hakim.hou)

Authorized Signatory : 

(Vita Li)

TABLE OF CONTENTS

1. SUMMARY OF TEST RESULTS	5
1.1 TEST FACTORY	6
1.2 MEASUREMENT UNCERTAINTY	6
2. GENERAL INFORMATION	7
2.1 GENERAL DESCRIPTION OF EUT	7
2.2 DESCRIPTION OF TEST MODES	9
2.3 BLOCK DIGRAM SHOWING THE CONFIGURATION OF SYSTEM TESTED	9
2.4 DESCRIPTION OF SUPPORT UNITS	10
2.5 EQUIPMENTS LIST FOR ALL TEST ITEMS	11
3. EMC EMISSION TEST	12
3.1 CONDUCTED EMISSION MEASUREMENT	12
3.2 TEST PROCEDURE	13
3.3 TEST SETUP	13
3.4 EUT OPERATING CONDITIONS	13
3.5 TEST RESULTS	14
4. RADIATED EMISSION MEASUREMENT	15
4.1 RADIATED EMISSION LIMITS	15
4.2 TEST PROCEDURE	16
4.3 DEVIATION FROM TEST STANDARD	16
5. BANDWIDTH TEST	29
5.1 APPLIED PROCEDURES / LIMIT	29
5.2 TEST REQUIREMENTS	29
5.3 TEST PROCEDURE	29
5.4 TEST SETUP	29
5.5 EUT OPERATION CONDITIONS	29
5.6 TEST RESULTS	30
6. DUTY CYCLE	39
6.1 TEST PROCEDURE	39
6.2 TEST SETUP	39
6.3 EUT OPERATION CONDITIONS	39
6.4 TEST RESULTS	40
7. AUTOMATICALLY DEACTIVATE	49
7.1 STANDARD REQUIREMENT	49
7.2 TEST PROCEDURE	49
8. ANTENNA REQUIREMENT	58
8.1 STANDARD REQUIREMENT	58
8.2 EUT ANTENNA	58

Revision History

Rev.	Issue Date	Report NO.	Effect Page	Contents
00	17 Aug. 2017	1706002F01	ALL	Initial Issue

1. SUMMARY OF TEST RESULTS

Test procedures according to the technical standards:

FCC Part 15.231, Subpart C			
Standard Section	Test Item	Judgment	Remark
15.207	Conducted Emission	N/A	--
15.205(a)/15.209/ 15.231.(b)	Radiated Spurious Emission	PASS	--
15.231(a)(1)	Transmission requirement	PASS	--
15.231(C)	20 dB Bandwidth	PASS	--
15.203	Antenna Requirement	PASS	--

NOTE: (1)"N/A" denotes test is not applicable in this Test Report

(2) All tests are according to ANSI C63.10-2013

1.1 TEST FACTORY

BZT Testing Technology Co., Ltd.

Add. : Buliding 17, Xinghua Road Xingwei industrial Park Fuyong,
Baoan District, Shenzhen, Guangdong, China

FCC Registration No.: 701733

1.2 MEASUREMENT UNCERTAINTY

The reported uncertainty of measurement $y \pm U$, where expanded uncertainty U is based on a standard uncertainty multiplied by a coverage factor of $k=2$, providing a level of confidence of approximately **95** %.

No.	Item	Uncertainty
1	Conducted Emission (9KHz-150KHz)	$\pm 2.88\text{dB}$
2	Conducted Emission (150KHz-30MHz)	$\pm 2.67\text{dB}$
3	RF power,conducted	$\pm 0.70\text{dB}$
4	Spurious emissions,conducted	$\pm 1.19\text{dB}$
5	All emissions,radiated(<1G) 30MHz-200MHz	$\pm 2.83\text{dB}$
6	All emissions,radiated(<1G) 200MHz-1000MHz	$\pm 2.94\text{dB}$
8	Temperature	$\pm 0.5^{\circ}\text{C}$
9	Humidity	$\pm 2\%$

2. GENERAL INFORMATION

2.1 GENERAL DESCRIPTION OF EUT

Equipment	Outdoor Probe
Trade Name	Wireless Sensor Tags
Model Name	ZGW11
Series Model	N/A
Model Difference	N/A
Frequency band	431.04MHz~439.36MHz
Power Rating	DC 3.6 V
Hardware version number	N/A
Software version number	N/A
Connecting I/O Port(s)	N/A

Note:

1. For a more detailed features description, please refer to the manufacturer's specifications or the User's Manual.

2. Table for filed Antenna

Ant.	Brand	Model Name	Antenna Type	Connector	Gain (dBi)	NOTE
1	Wireless Sensor Tags	ZGW11	PCB	N/A	0	Antenna

The EUT antenna is PCB Antenna. No antenna other than that furnished by the responsible party shall be used with the device.

3.Channel list

channel	Frequency(MHz)	channel	Frequency(MHz)	channel	Frequency(MHz)
01	431.04	95	438.56
02	431.12	96	438.64
03	431.20	97	438.72
04	431.28	98	438.80
05	431.36	51	435.04	99	438.88
06	431.44	52	435.12	100	438.96
07	431.52	53	435.20	101	439.04
08	431.60	54	435.28	102	439.12
09	431.68	103	439.20
10	431.76	104	439.28
11	431.84	105	439.36

4.Test channel

Test channel	Frequency(MHz)
01	431.04
53	435.28
105	439.36

2.2 DESCRIPTION OF TEST MODES

To investigate the maximum EMI emission characteristics generates from EUT, the test system was pre-scanning tested base on the consideration of following EUT operation mode or test configuration mode which possible have effect on EMI emission level. Each of these EUT operation mode(s) or test configuration mode(s) mentioned above was evaluated respectively.

Pretest Mode	Description
Mode 1	TX Mode(Low Channel)
Mode 2	TX Mode(Middle Channel)
Mode 3	TX Mode(High Channel)

	For Radiated Emission
Final Test Mode	Description
Mode 1	TX Mode(Low Channel)
Mode 2	TX Mode(Middle Channel)
Mode 3	TX Mode(High Channel)

2.3 BLOCK DIGRAM SHOWING THE CONFIGURATION OF SYSTEM TESTED

Note:

1. During test, Keep EUT is in continuous transmission mode.
2. scan with three emissions of send acknowledgement to Tag Manager, transmit the entire sensor reading information, and initiate transmission to Tag Manager to notify abnormal readings, only show the worst case of initiate transmission to transmit the entire sensor reading information

EUT

2.4 DESCRIPTION OF SUPPORT UNITS

The EUT has been tested as an independent unit together with other necessary accessories or support units. The following support units or accessories were used to form a representative test configuration during the tests.

Item	Equipment	Mfr/Brand	Model/Type No.	Serial No.	Note
N/A	N/A	N/A	N/A	N/A	N/A

Item	Shielded Type	Ferrite Core	Length	Note
N/A	N/A	N/A	N/A	N/A

Note:

(1)The support equipment was authorized by Declaration of Confirmation.

(2)For detachable type I/O cable should be specified the length in cm in 『Length』 column.

2.5 EQUIPMENTS LIST FOR ALL TEST ITEMS

Kind of Equipment	Manufacturer	Type No.	Serial No.	Last calibration	Calibrated until
Spectrum Analyzer	Agilent	E4407B	MY50140340	2016.10.23	2017.10.22
Test Receiver	R&S	ESCI	101427	2016.10.23	2017.10.22
Bilog Antenna	TESEQ	CBL6111D	34678	2014.11.24	2017.11.23
Horn Antenna	Schwarzbeck	BBHA 9120D(1201) 1G-18G	9120D-1343	2015.03.05	2018.03.04
50Ω Coaxial Switch	Anritsu	MP59B	6200264416	2016.10.23	2017.10.22
PreAmplifier	Agilent	8449B	60538	2016.10.23	2017.10.22
Pre-mpplier(0.1 M-3GHz)	EM330	EM	60538	2017.03.12	2018.03.11
Loop Antenna	EMCO	6502	9003-2485	2016.03.06	2019.03.05
Spectrum Analyzer	Agilent	E4407B	MY50140340	2016.10.23	2017.10.22
Low frequency cable (9KHz-1GHz)	SCHWARZBECK	R01	N/A	2016.10.23	2017.10.22
High frequency cable (1GHz-5GHz)	SCHWARZBECK	R02	N/A	2016.10.23	2017.10.22
Temporary Antenna Connector	N/A	P9MSP9MS	N/A	2016.10.23	2017.10.22
RF Cable	Murrata	MXHS83QE300 0	2085751	2016.10.23	2017.10.22
EMI Test Receiver	R&S	ESPI	102086	2016.10.23	2017.10.22
LISN	R&S	ENV216	101242	2016.10.23	2017.10.22
LISN	EMCO	3810/2NM	000-23625	2016.10.23	2017.10.22
Conduction Cable (150KHz-30MHz)	EM	C01	N/A	2016.10.23	2017.10.22

Note: The temporary antenna connector is soldered on the PCB board in order to perform conducted tests and this temporary antenna connector is listed in the equipment list.

3. EMC EMISSION TEST

3.1 CONDUCTED EMISSION MEASUREMENT

3.1.1 POWER LINE CONDUCTED EMISSION LIMITS

operating frequency band. In case the emission fall within the restricted band specified on Part 15. 207(a) limit in the table below has to be followed.

FREQUENCY (MHz)	Class B (dBuV)		Standard
	Quasi-peak	Average	
0.15 -0.5	66 - 56 *	56 - 46 *	CISPR
0.50 -5.0	56.00	46.00	CISPR
5.0 -30.0	60.00	50.00	CISPR

0.15 -0.5	66 - 56 *	56 - 46 *	FCC
0.50 -5.0	56.00	46.00	FCC
5.0 -30.0	60.00	50.00	FCC

Note:

(1) The tighter limit applies at the band edges.

(2) The limit of " * " marked band means the limitation decreases linearly with the logarithm of the frequency in the range.

The following table is the setting of the receiver

Receiver Parameters	Setting
Attenuation	10 dB
Start Frequency	0.15 MHz
Stop Frequency	30 MHz
IF Bandwidth	9 kHz

3.2 TEST PROCEDURE

- a. The EUT was placed 0.8 meters from the horizontal ground plane with EUT being connected to the power mains through a line impedance stabilization network (LISN). All other support equipments powered from additional LISN(s). The LISN provide 50 Ohm/ 50uH of coupling impedance for the measuring instrument.
- b. Interconnecting cables that hang closer than 40 cm to the ground plane shall be folded back and forth in the center forming a bundle 30 to 40 cm long.
- c. I/O cables that are not connected to a peripheral shall be bundled in the center. The end of the cable may be terminated, if required, using the correct terminating impedance. The overall length shall not exceed 1 m.
- d. LISN at least 80 cm from nearest part of EUT chassis.
- e. For the actual test configuration, please refer to the related Item –EUT Test Photos.

3.3 TEST SETUP

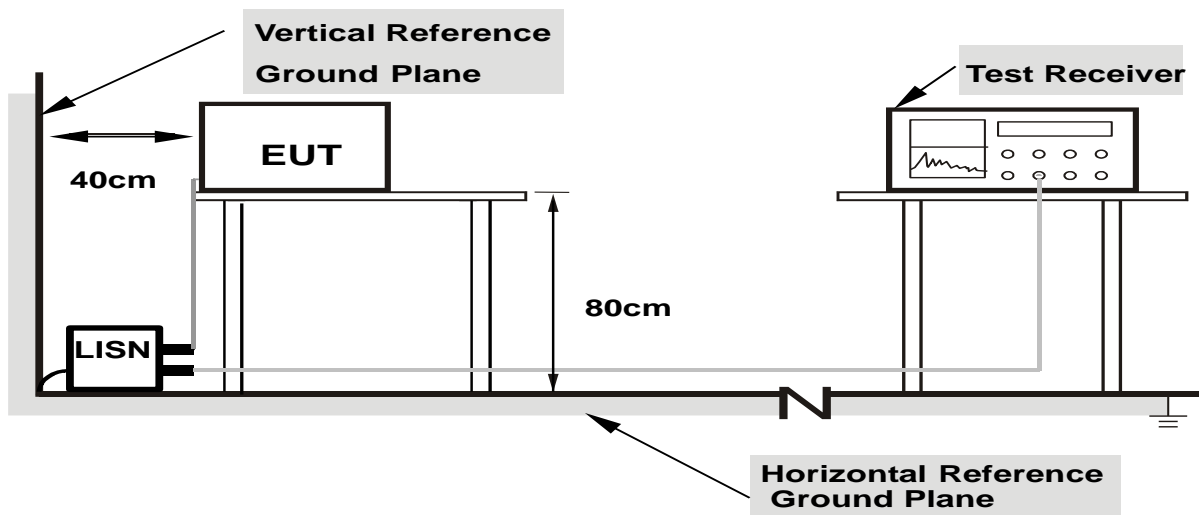

Note: 1. Support units were connected to second LISN.

2. Both of LISNs (AMN) are 80 cm from EUT and at least 80 cm from other units and other metal planes

3.4 EUT OPERATING CONDITIONS

The EUT was configured for testing in a typical fashion (as a customer would normally use it). The EUT has been programmed to continuously transmit during test. This operating condition was tested and used to collect the included data.

3.5 TEST RESULTS

Temperature:	26 °C	Relative Humidity:	60%
Pressure:	1010hPa	Phase :	L/N
Test Voltage:	DC 3.6V	Test Mode:	N/A

Note: EUT is only power by battery, So it is not applicable for this test.

4. RADIATED EMISSION MEASUREMENT

4.1 RADIATED EMISSION LIMITS

In case the emission fall within the restricted band specified on Part 15.205(a), then the Part 15.209(a) and Part 15.231(b) limit in the table below has to be followed.

LIMITS OF RADIATED EMISSION MEASUREMENT (0.009MHz - 1000MHz)

Frequencies (MHz)	Field Strength (micorvolts/meter)	Measurement Distance (meters)
0.009~0.490	2400/F(KHz)	300
0.490~1.705	24000/F(KHz)	30
1.705~30.0	30	30
30~40.66	100	3
40.70~70	100	3

Fundamental Frequency (MHz)	Field Strength of fundamental (microvolts/meter)	Field Strength of Unwanted Emissions (microvolts/meter)
40.66~40.70	2,250	225
70~130	1,250	125
130~174	1,250 to 3,750**	125 to 375**
174~260	3750	375
260~470	3,750 to 12,500**	375 to 1,250**
Above 470	12,500	1,250

LIMITS OF RADIATED EMISSION MEASUREMENT (Above 1000MHz)

FREQUENCY (MHz)	Class B (dBuV/m) (at 3M)	
	PEAK	AVERAGE
Above 1000	74	54

NOTE:

- (1)The limit for radiated test was performed according to FCC PART 15C.
- (2)Emission level (dBuV/m)=20log Emission level (uV/m).

Spectrum Parameter	Setting
Detector	Peak
Attenuation	Auto
Start Frequency	1000 MHz
Stop Frequency	10th carrier harmonic
RB / VB (emission in restricted band)	1 MHz / 3 MHz

Receiver Parameter	Setting
Attenuation	Auto
Start ~ Stop Frequency	9kHz~90kHz / RB 200Hz for PK & AV
Start ~ Stop Frequency	90kHz~110kHz / RB 200Hz for QP
Start ~ Stop Frequency	110kHz~490kHz / RB 200Hz for PK & AV
Start ~ Stop Frequency	490kHz~30MHz / RB 9kHz for QP
Start ~ Stop Frequency	30MHz~1000MHz / RB 120kHz for QP

4.2 TEST PROCEDURE

- a. The test is performed in a 3m Semi-Anechoic Chamber; the antenna factor, cable loss and so on of the site (factors) is calculated to correct the reading. The EUT is placed on a 0.8m high insulating Turn Table, and keeps 3m away from the Test Antenna, which is mounted on a variable-height antenna master tower.
During test, The table was rotated 360 degrees to determine the position of the highest radiation.
- b. In the frequency range of 9KHz to 30MHz, magnetic field is measured with Loop Test Antenna. The Test Antenna is positioned with its plane vertical at 1m distance from the EUT. The center of the Loop Test Antenna is 1m above the ground. During the measurement the Loop Test Antenna rotates about its vertical axis for maximum response at each azimuth about the EUT.
- c. In the frequency range 30MHz-1GHz, Bi-Log Test Antenna used. Test Antenna is 3m away from the EUT. Test Antenna height is varied from 1m to 4m above the ground to determine the maximum value of the field strength. The emission levels at both horizontal and vertical polarizations should be tested.
- d. In the frequency above 1GHz, Place the measurement antenna 3m away from the EUT for each area of the EUT determined to be a source of emissions at the specified measurement distance, while keeping the measurement antenna aimed at the source of emissions at each frequency of significant emissions, with polarization oriented for maximum response. The measurement antenna elevation for maximum emissions shall be restricted to a range of heights of from 1 m to 4 m above the ground or reference ground plane.
- f. The initial step in collecting conducted emission data is a spectrum analyzer peak detector mode pre-scanning the measurement frequency range. Significant peaks are then marked and then Quasi Peak detector mode re-measured.
- g. If the Peak Mode measured value compliance with and lower than Quasi Peak Mode Limit, the EUT shall be deemed to meet QP Limits and then no additional QP Mode measurement performed.
- h. For the actual test configuration, please refer to the related Item –EUT Test Photos.
Both horizontal and vertical antenna polarities and performed pretest to three orthogonal axis were tested. The worst case emissions were reported

4.3 DEVIATION FROM TEST STANDARD

No deviation

4.4 TEST SETUP

(A) Radiated Emission Test-Up Frequency Below 30MHz

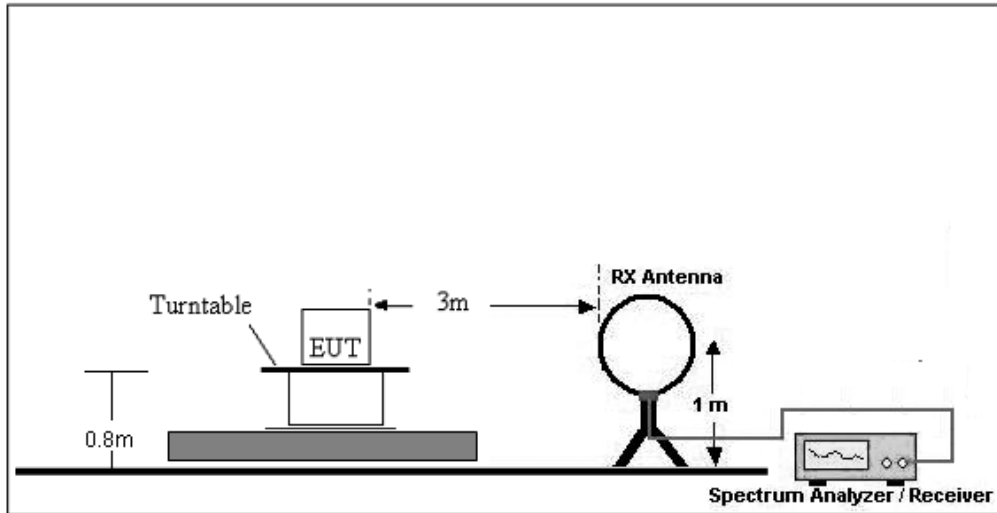

(B) Radiated Emission Test-Up Frequency 30MHz~1GHz

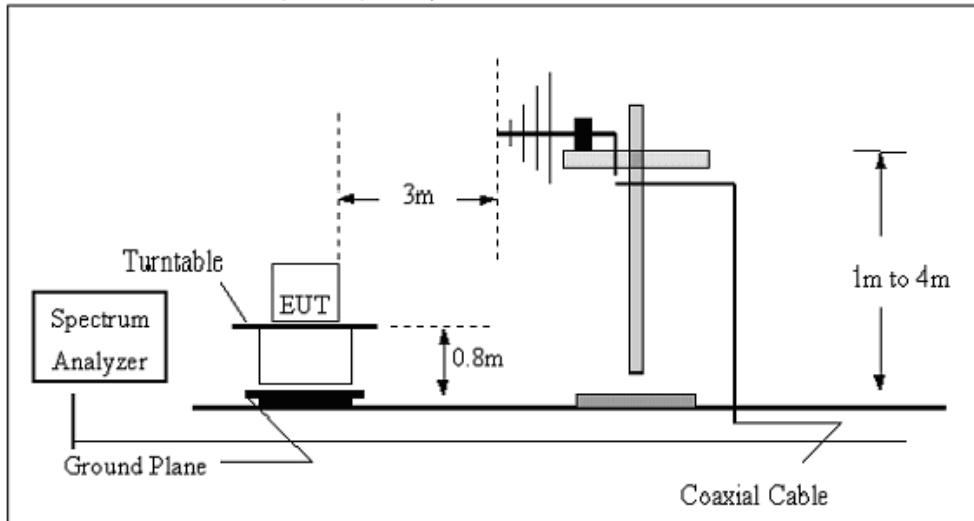

(C) Radiated Emission Test-Up Frequency Above 1GHz

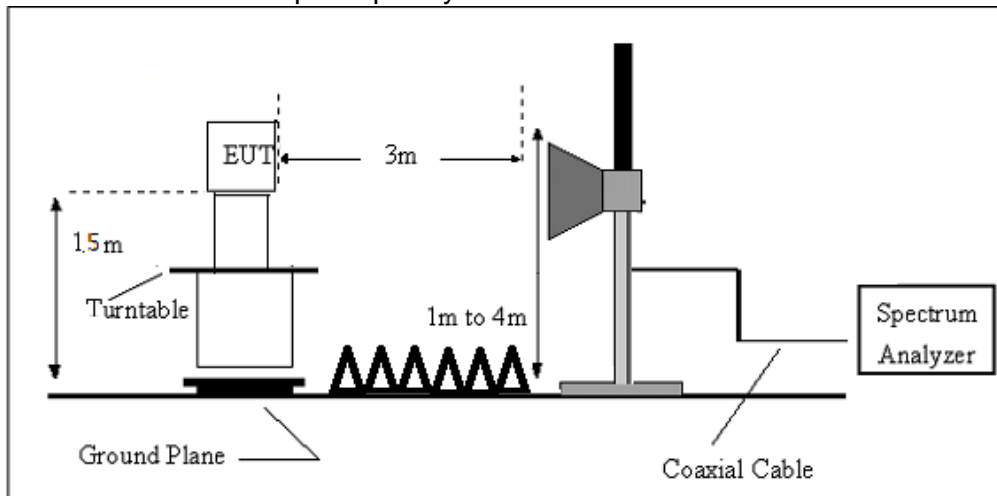

4.5 EUT OPERATING CONDITIONS

The EUT tested system was configured as the statements of 2.4 Unless otherwise a special operating condition is specified in the follows during the testing.

4.6 TEST RESULTS

INTRODUCTION TO PDCF

reference: (§15.35 Measurement detector functions and bandwidths.)

- a. Part 15 of the FCC Rules provides for the operation of low power communication devices without an individual license (e.g., intrusion detectors, pulsed water tank level gauges, etc.), subject to certain requirements. Some of these devices use extremely narrow pulses to generate wideband emissions, which are measured to determine compliance with the rules. These measurements are typically performed with a receiver or spectrum analyzer. Depending on a number of factors (e.g., resolution bandwidth, pulsewidth, etc.), the spectrum analyzer may not always display the true peak value of the measured emission. This effect, called “pulse desensitization,” relates to the capabilities of the measuring instrument. For the measurement and reporting of the true peak of pulsed emissions, it may be necessary to apply a “pulse desensitization correction factor” (PDCF) to the measured value, pursuant to 47 CFR 15.35(a).

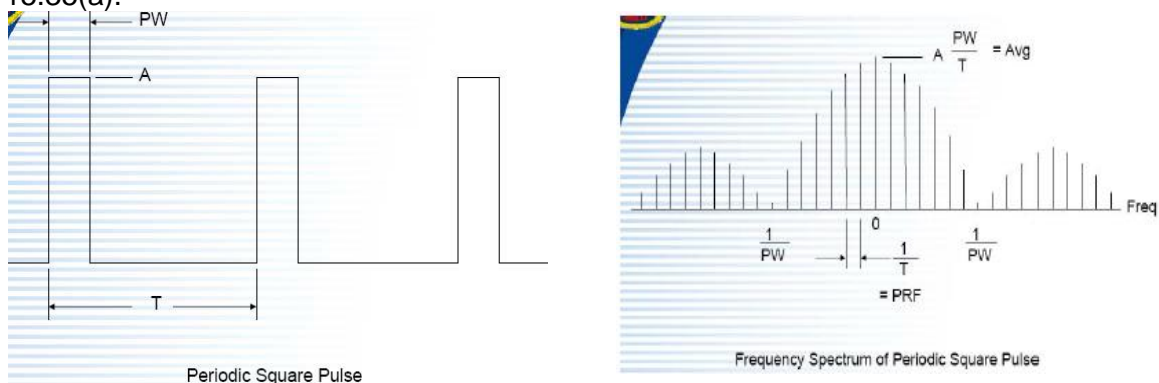

If using spectrum analyzer to measure pulse signal, it has to make sure the RBW use is at least $2/PW$.

•When RBW is less than $2/PW$, you are able to measure the true peak level of the pulse signal. If this is the case, PDCF is required to compensate to determine true peak value.

Pulse desensitization:

For 431.04MHz:

PW =36670usec, Period=53170usec, Level=A ;RBW>2/PW=0.055K , 1/T=0.02K

For 435.28MHz:

PW =36500usec, Period=53000usec, Level=A ;RBW>2/PW=0.055K , 1/T=0.02K

For 439.36MHz:

PW =36500usec, Period=53000usec, Level=A ;RBW>2/PW=0.055K , 1/T=0.02K

NOTE: $2 / PW < RBW$, first don't need

- b. For the actual test, please refer to the ANSI C63.10, Annex C refer to section 5 for more detail

4.7 TEST RESULTS

(Radiated Emission<30MHz (9KHz-30MHz, H-field))

Freq.	Reading	Limit	Margin	State
(MHz)	(dBuV/m)	(dBuV/m)	(dB)	P/F
--	--	--	--	PASS
--	--	--	--	PASS

Note: The amplitude of spurious emissions which are attenuated by more than 20dB below the permissible value has no need to be reported.

Distance extrapolation factor = $40 \log(\text{specific distance}/\text{test distance})$ (dB);

Limit line = specific limits(dBuv) + distance extrapolation factor.

Between 30MHz – 5000 MHz

431.04MHz			
Temperature:	26 °C	Relative Humidity:	60%
Pressure:	1010hPa	Phase:	Horizontal
Test Voltage:	DC 3.6V	Test Mode:	Mode 1

No.	Frequency (MHz)	Reading (dBuV/m)	Factor (dB)	Results (dBuV/m)	Limit (dBuV/m)	Margin (dB)	Detector
1	30.0000	33.56	-11.19	22.37	40.00	-17.63	QP
2	50.5860	35.16	-21.65	13.51	40.00	-26.49	QP
3	102.0014	32.29	-19.02	13.27	43.50	-30.23	QP
4	145.3506	34.18	-17.75	16.43	43.50	-27.07	QP
5	431.0400	84.77	-10.9	73.87	100.73	-26.86	PK
6	862.0800	48.04	-2.62	45.42	80.73	-35.31	QP

AV

No.	Frequency (MHz)	PK Result (dBuV/m)	Duty cycle Factor (dB)	Results (dBuV/m)	Limit (dBuV/m)	Margin (dB)	Detector
7	431.0400	73.87	-3.27	70.60	80.73	-10.13	AV

Remark:

1. All readings are Quasi-Peak and Average values.
2. Margin = Result (Result = Reading + Factor) – Limit

80.0 dBuV/m

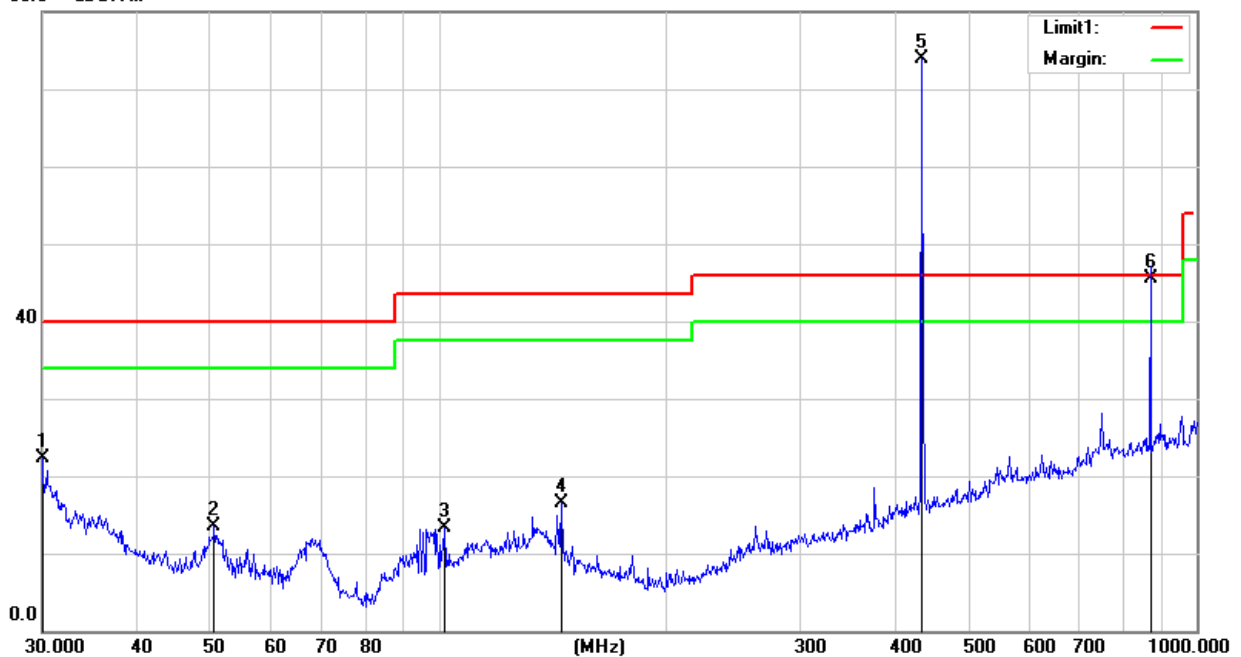

Temperature:	26 °C	Relative Humidity:	60%
Pressure:	1010hPa	Phase:	Vertical
Test Voltage:	DC 3.6V	Test Mode:	Mode 1

No.	Frequency (MHz)	Reading (dBuV/m)	Factor (dB)	Results (dBuV/m)	Limit (dBuV/m)	Margin (dB)	Detector
1	30.0000	30.87	-11.19	19.68	40.00	-20.32	QP
2	128.5630	32.81	-17.56	15.25	43.50	-28.25	QP
3	431.0400	84.36	-10.90	73.46	100.83	-27.37	PK
4	566.6223	29.63	-6.61	23.02	46.00	-22.98	QP
5	750.1083	31.16	-3.56	27.60	46.00	-18.40	QP
6	862.0800	39.78	-2.61	37.17	80.83	-43.66	QP

AV

No.	Frequency (MHz)	PK Result (dBuV/m)	Duty cycle Factor (dB)	Results (dBuV/m)	Limit (dBuV/m)	Margin (dB)	Detector
7	431.0400	73.46	-3.27	70.19	80.83	-10.64	AV

Remark:

- All readings are Quasi-Peak and Average values.
- Margin = Result (Result = Reading + Factor) - Limit

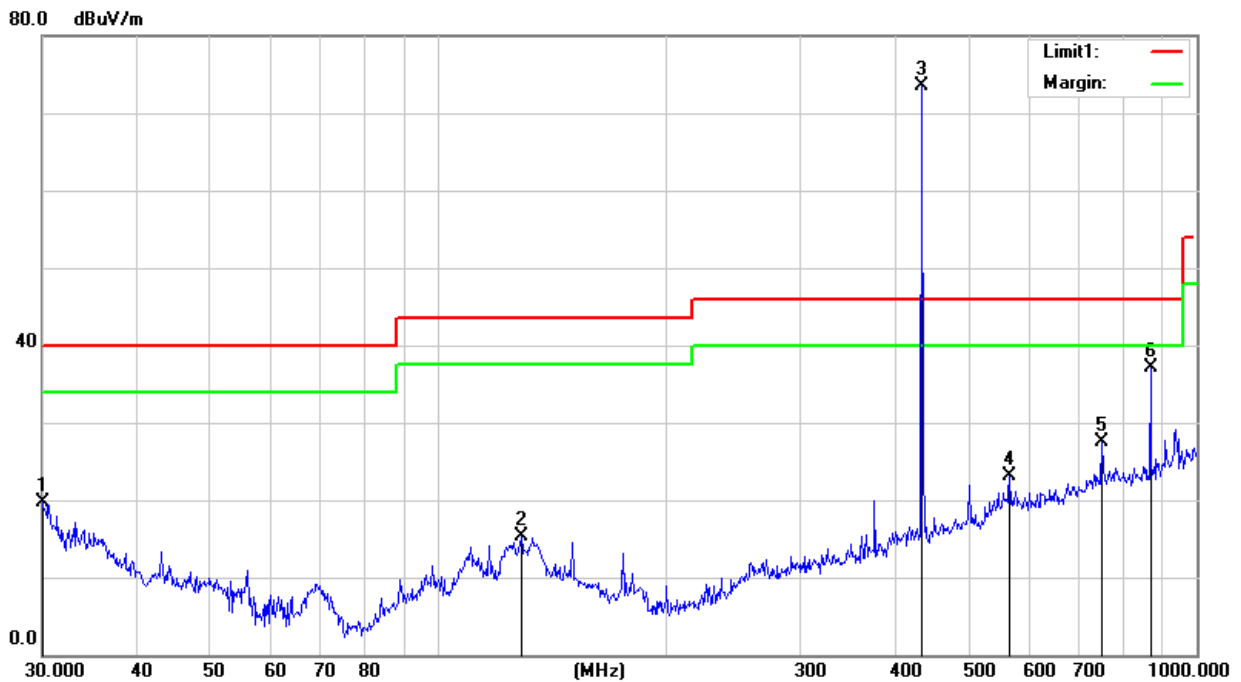

435.28MHz			
Temperature:	26 °C	Relative Humidity:	60%
Pressure:	1010hPa	Phase:	Horizontal
Test Voltage:	DC 3.6V	Test Mode:	Mode 2

No.	Frequency (MHz)	Reading (dBuV/m)	Factor (dB)	Results (dBuV/m)	Limit (dBuV/m)	Margin (dB)	Detector
1	47.4918	41.63	-20.19	21.44	40.00	-18.56	QP
2	91.8161	30.76	-20.02	10.74	43.50	-32.76	QP
3	136.9391	31.30	-17.52	13.78	43.50	-29.72	QP
4	316.5890	30.87	-14.28	16.59	46.00	-29.41	QP
5	435.2800	74.16	-10.89	63.27	100.87	-37.60	PK
6	750.1083	29.27	-3.56	25.71	46.00	-20.29	QP

AV

No.	Frequency (MHz)	PK Result (dBuV/m)	Duty cycle Factor (dB)	Results (dBuV/m)	Limit (dBuV/m)	Margin (dB)	Detector
7	435.2800	63.27	-3.18	60.09	80.87	-20.78	AV

Remark:

1. All readings are Quasi-Peak and Average values.
2. Margin = Result (Result = Reading + Factor) - Limit

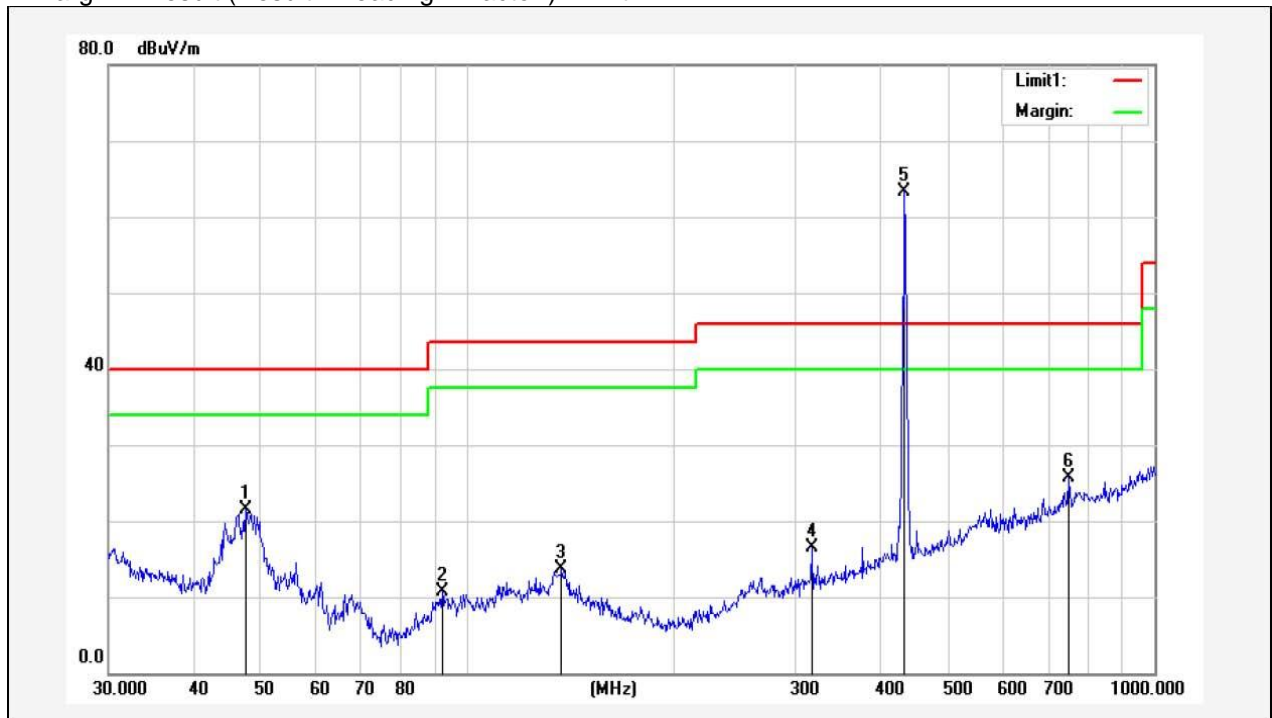

Temperature:	26 °C	Relative Humidity:	60%
Pressure:	1010hPa	Phase:	Vertical
Test Voltage:	DC 3.6V	Test Mode:	Mode 2

No.	Frequency (MHz)	Reading (dBuV/m)	Factor (dB)	Results (dBuV/m)	Limit (dBuV/m)	Margin (dB)	Detector
1	30.6380	30.96	-11.52	19.44	40.00	-20.56	QP
2	48.5016	37.39	-20.71	16.68	40.00	-23.32	QP
3	100.2286	32.68	-19.17	13.51	43.50	-29.99	QP
4	167.2368	42.46	-19.10	23.36	43.50	-20.14	QP
5	135.0320	32.10	-17.52	14.58	43.50	-28.92	QP
6	435.2800	74.82	-10.89	63.93	100.87	-36.94	PK

AV

No.	Frequency (MHz)	PK Result (dBuV/m)	Duty cycle Factor (dB)	Results (dBuV/m)	Limit (dBuV/m)	Margin (dB)	Detector
7	435.2800	63.93	-3.18	60.75	80.87	-20.12	AV

Remark:

1. All readings are Quasi-Peak and Average values.
2. Margin = Result (Result = Reading + Factor) - Limit

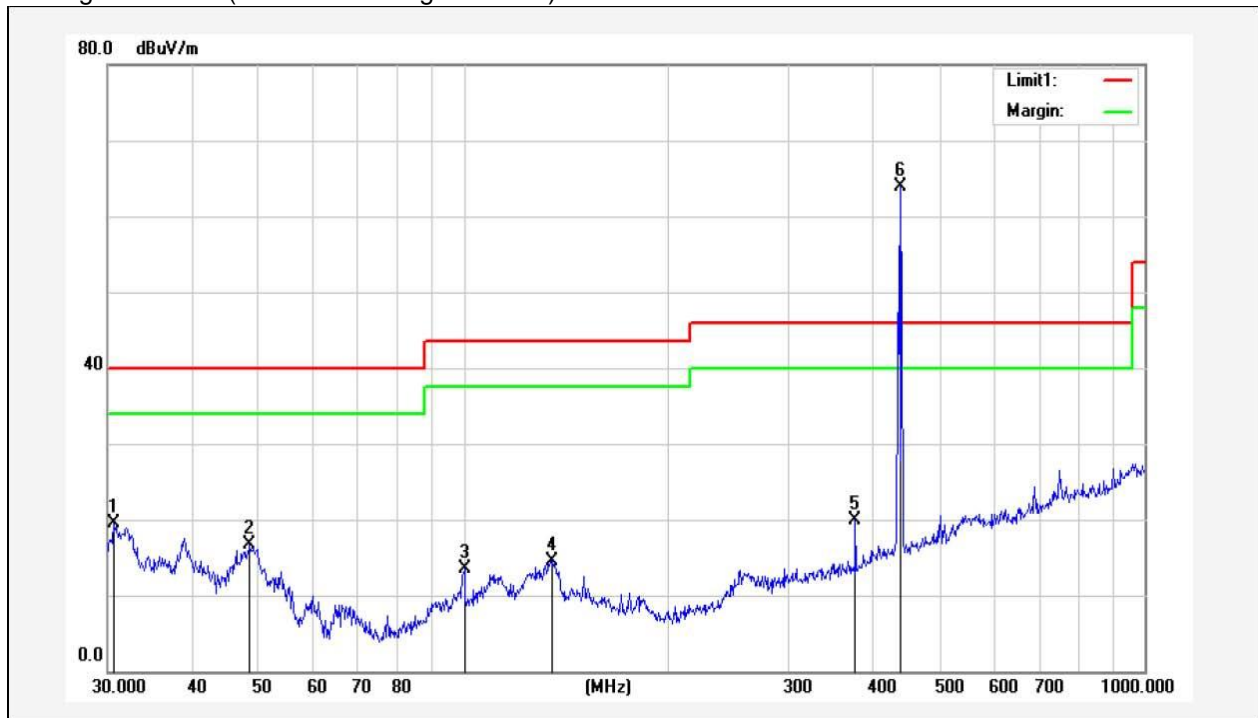

439.36MHz			
Temperature:	26 °C	Relative Humidity:	60%
Pressure:	1010hPa	Phase:	Horizontal
Test Voltage:	DC 3.6V	Test Mode:	Mode 3

No.	Frequency (MHz)	Reading (dBuV/m)	Factor (dB)	Results (dBuV/m)	Limit (dBuV/m)	Margin (dB)	Detector
1	30.5306	33.97	-11.47	22.50	40.00	-17.50	QP
2	49.7068	35.47	-21.33	14.14	40.00	-25.86	QP
3	94.7601	37.99	-19.72	18.27	43.50	-25.23	QP
4	192.4186	38.09	-20.24	17.85	43.50	-25.65	QP
5	439.3600	84.76	-10.90	73.86	101.00	-27.14	PK
6	878.7200	44.85	-2.61	42.24	81.00	-38.76	QP

AV

No.	Frequency (MHz)	PK Result (dBuV/m)	Duty cycle Factor (dB)	Results (dBuV/m)	Limit (dBuV/m)	Margin (dB)	Detector
7	439.3600	73.86	-3.15	70.71	81.00	-10.29	AV

Remark:

1. All readings are Quasi-Peak and Average values.
2. Margin = Result (Result = Reading + Factor) - Limit

80.0 dBuV/m

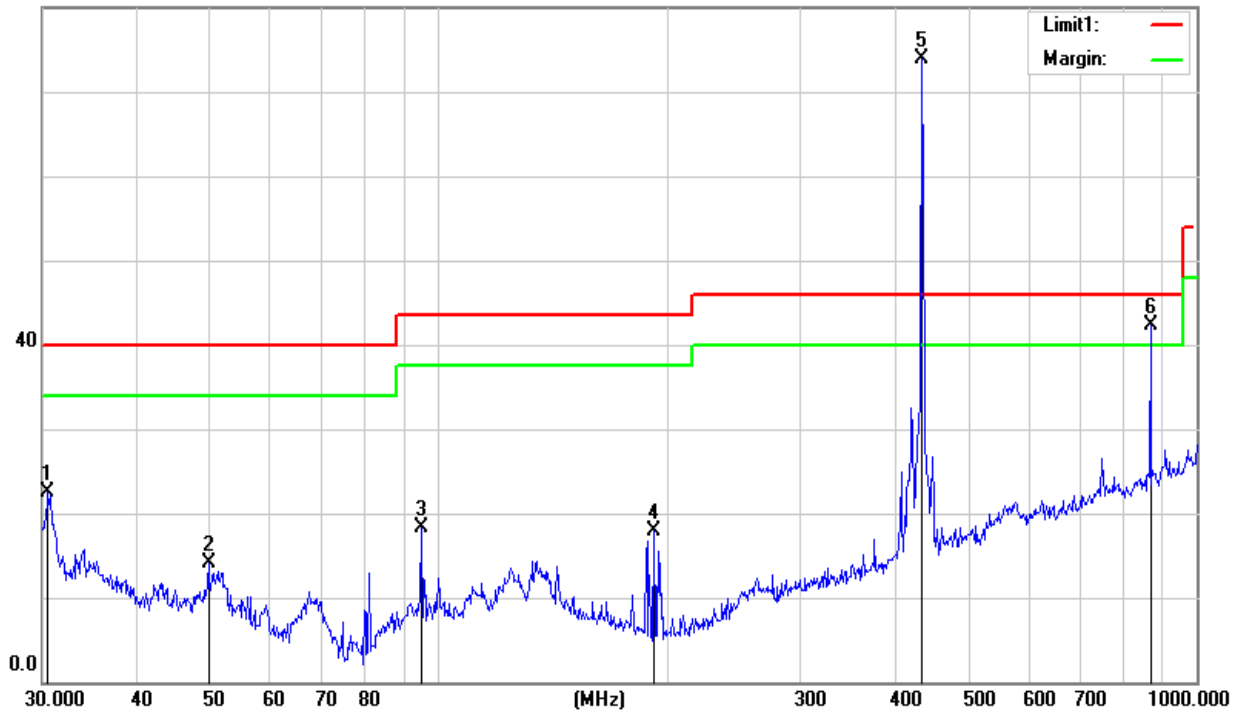

Temperature:	26 °C	Relative Humidity:	60%
Pressure:	1010hPa	Phase:	Vertical
Test Voltage:	DC 3.6V	Test Mode:	Mode 3

No.	Frequency (MHz)	Reading (dBuV/m)	Factor (dB)	Results (dBuV/m)	Limit (dBuV/m)	Margin (dB)	Detector
1	30.7455	32.18	-11.57	20.61	40.00	-19.39	QP
2	47.1600	32.59	-20.01	12.58	40.00	-27.42	QP
3	123.2655	33.23	-17.65	15.58	43.50	-27.92	PK
4	133.1511	32.87	-17.54	15.33	43.50	-28.17	QP
5	439.3600	85.36	-10.90	74.46	101.00	-26.54	QP
6	918.8326	33.35	-0.75	32.60	46.00	-13.40	QP

AV

No.	Frequency (MHz)	PK Result (dBuV/m)	Duty cycle Factor (dB)	Results (dBuV/m)	Limit (dBuV/m)	Margin (dB)	Detector
7	439.63600	74.46	-3.15	71.31	81.00	-9.69	AV

Remark:

1. All readings are Quasi-Peak and Average values.
2. Margin = Result (Result = Reading + Factor) - Limit

80.0 dBuV/m

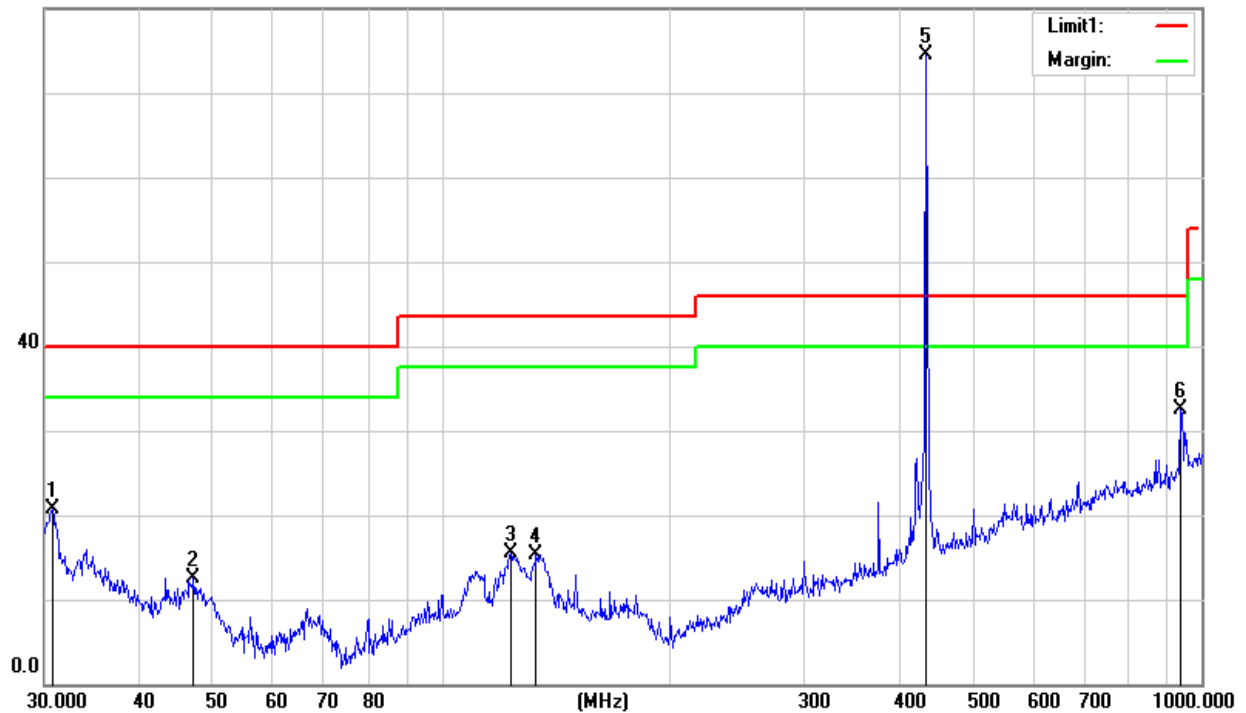

TEST RESULTS:(Above 1GHz)

431.04MHz										
Frequency	Reading	Detector	Amplifier	Loss	Antenna Factor	Corrected Factor	Corrected Amplitude	FCC Part 15.231/15.209/205		RX
								Limit	Margin	Antenna
(MHz)	(dB μ V/m)	(PK/QP/AV)	(dB)	(dB)	(dB/m)	(dB)	(dB μ V/m)	(dB μ V/m)	(dB)	(H/V)
1239.12	64.28	PK	45.10	4.00	25.10	-16.00	48.28	74.00	-25.72	H
1239.12	64.32	PK	45.10	4.00	25.10	-16.00	48.32	74.00	-25.68	V
1652.16	62.35	PK	44.10	5.30	25.00	-13.80	48.55	74.00	-25.45	H
1652.16	62.26	PK	44.10	5.30	25.00	-13.80	48.46	74.00	-25.54	V
2065.20	60.35	PK	43.80	5.43	25.90	-12.47	47.88	74.00	-26.12	H
2065.20	60.29	PK	43.80	5.43	25.90	-12.47	47.82	74.00	-26.18	V
2478.24	56.62	PK	44.40	6.03	27.60	-10.77	45.85	74.00	-28.15	H
2478.24	56.58	PK	44.40	6.03	27.60	-10.77	45.81	74.00	-28.19	V

Note: 1. Correded Factor=Antenna Factor+Loss-Amplifier

2. Corrected Amplitude= Reading+ Corrected Factor

3. Above 2.6 GHz The amplitude of spurious emissions which are attenuated by more than 20dB below the permissible value has no need to be reported.

AVG TEST RESULTS:

AV = Peak +20Log₁₀(duty cycle) =PK+(-3.27) [refer to section 6 for more detail]

Frequency	PK Reading	Duty cycle Factor	Corrected Amplitude	FCC Part 15.231/15.209/205		RX Antenna
				Limit	Margin	Polar
(MHz)	(dB μ V/m)	(dB)	(dB μ V/m)	(dB μ V/m)	(dB)	(H/V)
1239.12	48.28	-3.27	45.01	54.00	-8.99	H
1239.12	48.32	-3.27	45.05	54.00	-8.95	V
1652.16	48.55	-3.27	45.28	54.00	-8.72	H
1652.16	48.46	-3.27	45.19	54.00	-8.81	V
2065.20	47.88	-3.27	44.61	54.00	-9.39	H
2065.20	47.82	-3.27	44.55	54.00	-9.45	V
2478.24	45.85	-3.27	42.58	54.00	-11.42	H
2478.24	45.81	-3.27	42.54	54.00	-11.46	V

435.28MHz										
Frequency	Reading	Detector	Amplifier	Loss	Antenna Factor	Corrected Factor	Corrected Amplitude	FCC Part 15.231/15.209/205		RX Antenna
								Limit	Margin	Polar
(MHz)	(dB μ V/m)	(PK/QP/AV)	(dB)	(dB)	(dB/m)	(dB)	(dB μ V/m)	(dB μ V/m)	(dB)	(H/V)
1305.84	64.89	PK	45.10	4.00	25.10	-16.00	48.89	74.00	-25.11	H
1305.84	64.76	PK	45.10	4.00	25.10	-16.00	48.76	74.00	-25.24	V
1741.12	62.52	PK	44.10	5.30	25.00	-13.80	48.72	74.00	-25.28	H
1741.12	62.48	PK	44.10	5.30	25.00	-13.80	48.68	74.00	-25.32	V
2176.40	60.39	PK	43.80	5.43	25.90	-12.47	47.92	74.00	-26.08	H
2176.40	60.31	PK	43.80	5.43	25.90	-12.47	47.84	74.00	-26.16	V
2611.68	56.28	PK	44.40	6.03	27.60	-10.77	45.51	74.00	-28.49	H
2611.28	56.19	PK	44.40	6.03	27.60	-10.77	45.42	74.00	-28.58	V

Note: 1. Correded Factor=Antenna Factor+Loss-Amplifier

2. Corrected Amplitude= Reading+ Corrected Factor

3. Above 2.6 GHz The amplitude of spurious emissions which are attenuated by more than 20dB below the permissible value has no need to be reported.

AVG TEST RESULTS:

AV = Peak +20Log₁₀(duty cycle) =PK+(-3.18) [refer to section 6 for more detail]

Frequency	PK Reading	Duty cycle Factor	Corrected Amplitude	FCC Part 15.231/15.209/205		RX Antenna
				Limit	Margin	Polar
(MHz)	(dB μ V/m)	(dB)	(dB μ V/m)	(dB μ V/m)	(dB)	(H/V)
1305.84	48.89	-3.18	45.71	54.00	-8.29	H
1305.84	48.76	-3.18	45.58	54.00	-8.42	V
1741.12	48.72	-3.18	45.54	54.00	-8.46	H
1741.12	48.68	-3.18	45.50	54.00	-8.50	V
2176.40	47.92	-3.18	44.74	54.00	-9.26	H
2176.40	47.84	-3.18	44.66	54.00	-9.34	V
2611.68	45.51	-3.18	42.33	54.00	-11.67	H
2611.28	45.42	-3.18	42.24	54.00	-11.76	V

439.36MHz										
Frequency	Reading	Detector	Amplifier	Loss	Antenna Factor	Corrected Factor	Corrected Amplitude	FCC Part 15.231/15.209/205		RX Antenna
								Limit	Margin	Polar
(MHz)	(dB μ V/m)	(PK/QP/AV)	(dB)	(dB)	(dB/m)	(dB)	(dB μ V/m)	(dB μ V/m)	(dB)	(H/V)
1318.08	64.85	PK	45.10	4.00	25.10	-16.00	48.85	74.00	-25.15	H
1318.08	64.49	PK	45.10	4.00	25.10	-16.00	48.49	74.00	-25.51	V
1757.44	62.56	PK	44.10	5.30	25.00	-13.80	48.76	74.00	-25.24	H
1757.44	62.38	PK	44.10	5.30	25.00	-13.80	48.58	74.00	-25.42	V
2196.80	60.29	PK	43.80	5.43	25.90	-12.47	47.82	74.00	-26.18	H
2196.80	60.32	PK	43.80	5.43	25.90	-12.47	47.85	74.00	-26.15	V
2636.16	56.39	PK	44.40	6.03	27.60	-10.77	45.62	74.00	-28.38	H
2636.16	56.27	PK	44.40	6.03	27.60	-10.77	45.50	74.00	-28.50	V

Note: 1. Correded Factor=Antenna Factor+Loss-Amplifier

2. Corrected Amplitude= Reading+ Corrected Factor

3. Above 2.6 GHz The amplitude of spurious emissions which are attenuated by more than 20dB below the permissible value has no need to be reported.

AVG TEST RESULTS:

AV = Peak +20Log₁₀(duty cycle) =PK+(-3.15) [refer to section 6 for more detail]

Frequency	PK Reading	Duty cycle Factor	Corrected Amplitude	FCC Part 15.231/15.209/205		RX Antenna
				Limit	Margin	Polar
(MHz)	(dB μ V/m)	(dB)	(dB μ V/m)	(dB μ V/m)	(dB)	(H/V)
1318.08	48.85	-3.24	45.70	54.00	-8.30	H
1318.08	48.49	-3.24	45.34	54.00	-8.66	V
1757.44	48.76	-3.24	45.61	54.00	-8.39	H
1757.44	48.58	-3.24	45.43	54.00	-8.57	V
2196.80	47.82	-3.24	44.67	54.00	-9.33	H
2196.80	47.85	-3.24	44.70	54.00	-9.30	V
2636.16	45.62	-3.24	42.47	54.00	-11.53	H
2636.16	45.50	-3.24	42.35	54.00	-11.65	V

5. BANDWIDTH TEST

5.1 APPLIED PROCEDURES / LIMIT

FCC Part 15.231, Subpart C				
Section	Test Item	Limit	Frequency Range (MHz)	Result
15.231(C)	20 Bandwidth	The 20dB bandwidth of the emissions shall not exceed 0.25% of the center frequency	433.92	PASS

Spectrum Parameter	Setting
Attenuation	Auto
Span Frequency	> Measurement Bandwidth
RB	47 kHz
VB	470 kHz)
Detector	Peak
Trace	Max Hold
Sweep Time	Auto

5.2 TEST REQUIREMENTS

The bandwidth of the emission shall be no wider than 0.25% of the center frequency for devices operating above 70 MHz and below 900 MHz. For devices operating above 900 MHz, the emission shall be no wider than 0.5% of the center frequency. Bandwidth is determined at the points 20 dB down from the modulated carrier.

5.3 TEST PROCEDURE

- The EUT was directly connected to the spectrum analyzer and antenna output port as show in the block diagram below.
- Spectrum Setting : RBW= 47KHz, VBW=470KHz, Sweep time = Auto.

5.4 TEST SETUP



5.5 EUT OPERATION CONDITIONS

TX mode.

5.6 TEST RESULTS

For send acknowledgement to Tag Manager

Centre Frequency	Measurement		
	20dB Bandwidth (KHz)	Limit(kHz)	Result
431.04 MHz	20.16	1077.6	PASS

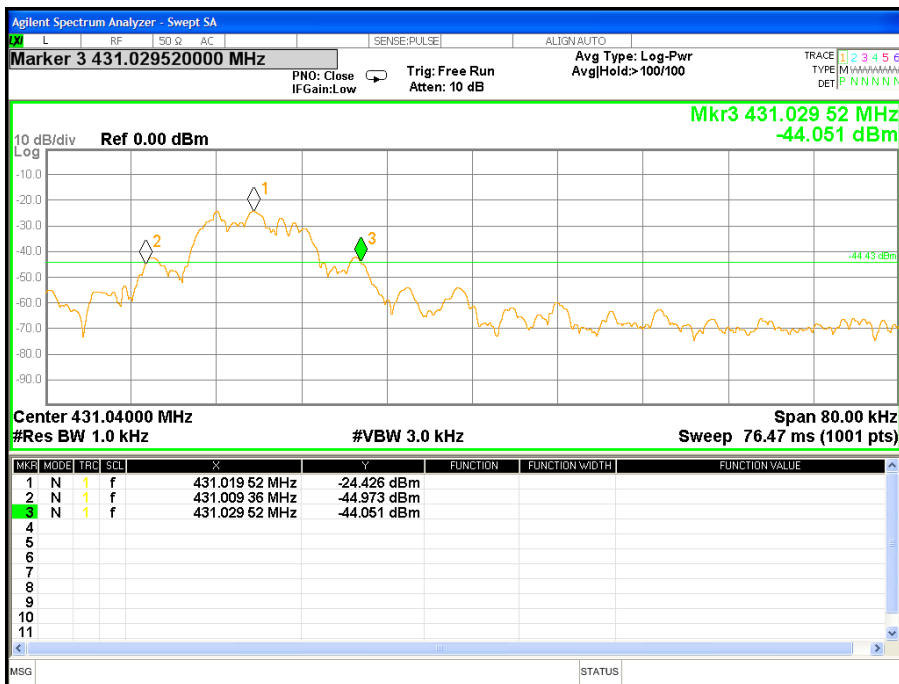

Centre Frequency	Measurement		
	20dB Bandwidth (KHz)	Limit(kHz)	Result
439.36 MHz	20.16	1098.4	PASS

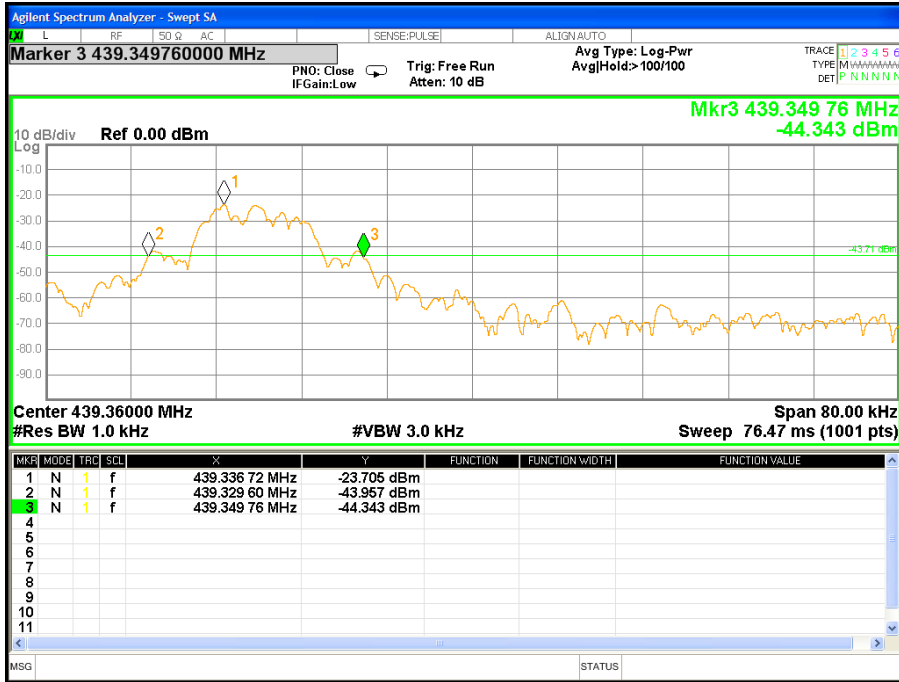

For initiate transmission to Tag Manager to notify abnormal readings

Centre Frequency	Measurement		
	20dB Bandwidth (KHz)	Limit(kHz)	Result
431.04 MHz	16.16	1077.6	PASS

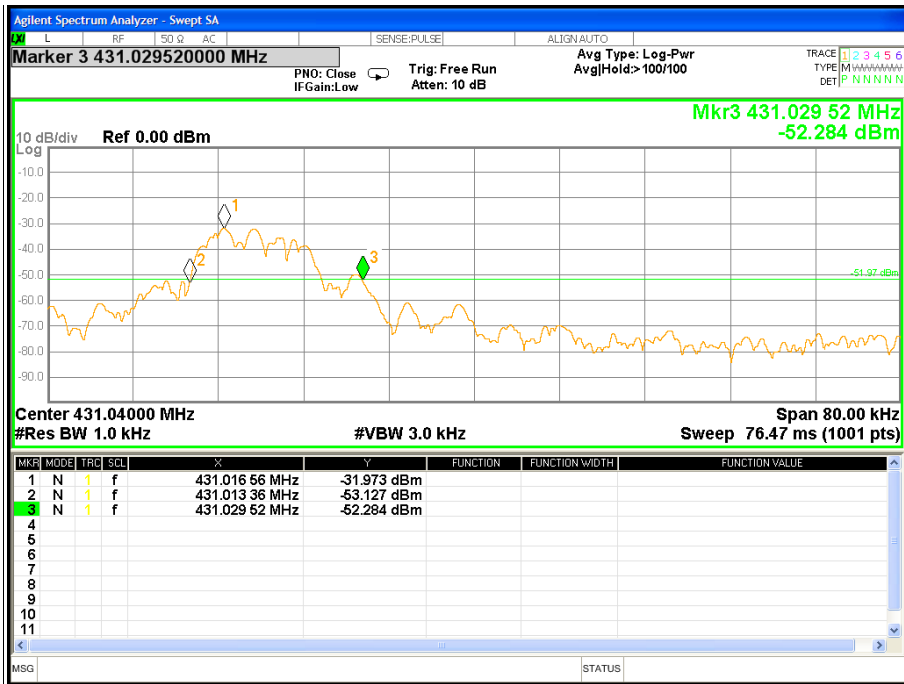

6. DUTY CYCLE

6.1 TEST PROCEDURE

The EUT was directly connected to the spectrum analyzer and antenna output port as show in the block diagram below.

The Duty Cycle Was Determined By The Following Equation: To Calculate The Actual Field Intensity,The Duty Cycle Correction Factor In Decibel Is Needed For Later Use And Can Be Obtained From Following Conversion

Duty Cycle(%)=Total On Interval In A Complete Pulse Train/ Length Of A Complete Pulse Train * %

Duty Cycle Correction Factor(Db)=20 * Log10(Duty Cycle(%))

6.2 TEST SETUP

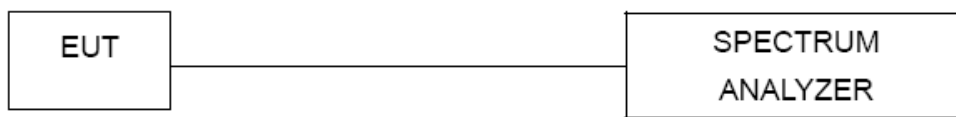

6.3 EUT OPERATION CONDITIONS

TX mode.

6.4 TEST RESULTS

Refer to the duty cycle plot (as below), This device meets the FCC requirement. Length of a complete pulse train

Remark: FCC part 15.35(c) required that a complete pulse train is more than 0.1 seconds, the measured field strength shall be determined from the average absolute voltage during a 0.1 second interval during which the field strength is at its maximum value.

Note: scan with three emissions of send acknowledgement to Tag Manager, transmit the entire sensor reading information, and initiate transmission to Tag Manager to notify abnormal readings,

For send acknowledgement to Tag Manager

431.04MHz	
Total On interval in a complete pulse train(ms)	36.67
Length of a complete pulse train(ms)	53.17
Duty Cycle(%)	68.97%
Duty Cycle Correction Factor(dB)	-3.22

TX Mode

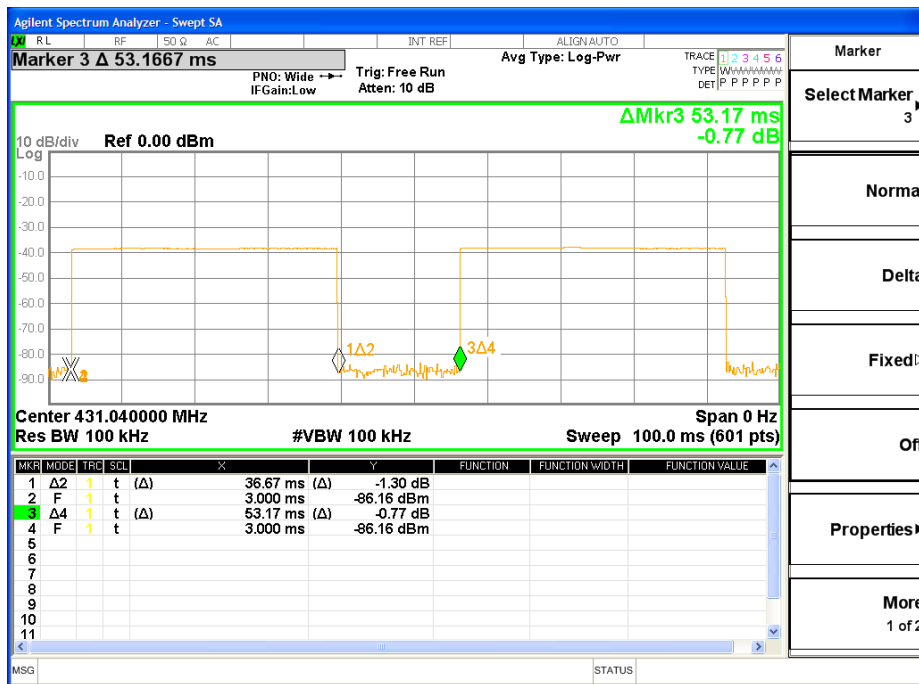

435.28MHz	
Total On interval in a complete pulse train(ms)	36.50
Length of a complete pulse train(ms)	53.00
Duty Cycle(%)	68.87%
Duty Cycle Correction Factor(dB)	-3.24

TX Mode



439.36MHz	
Total On interval in a complete pulse train(ms)	36.50
Length of a complete pulse train(ms)	53.00
Duty Cycle(%)	68.87%
Duty Cycle Correction Factor(dB)	-3.24

TX Mode

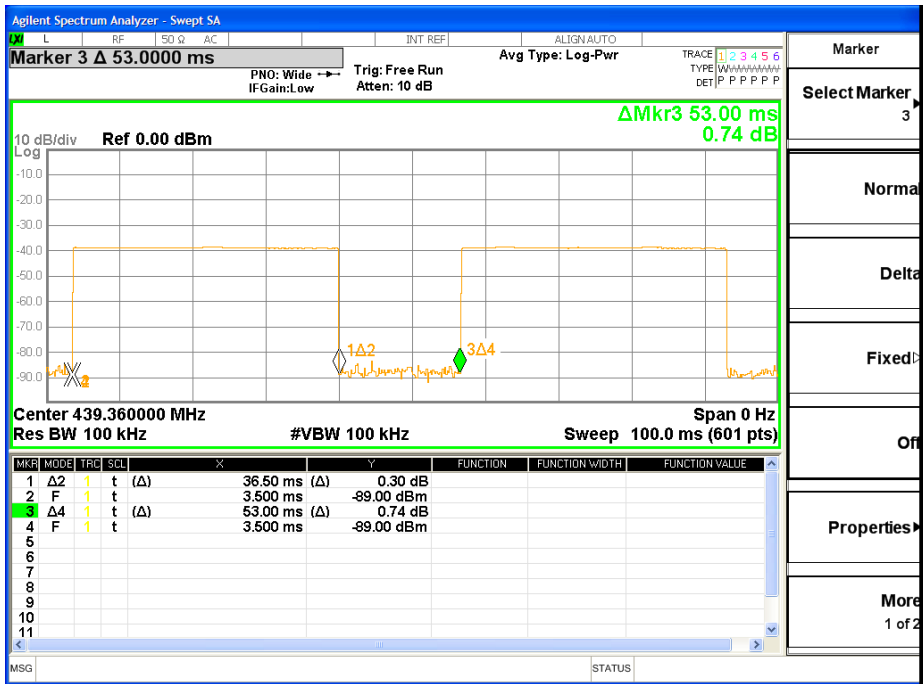

For transmit the entire sensor reading information

431.04MHz	
Total On interval in a complete pulse train(ms)	36.40
Length of a complete pulse train(ms)	53.10
Duty Cycle(%)	68.55%
Duty Cycle Correction Factor(dB)	-3.27

TX Mode

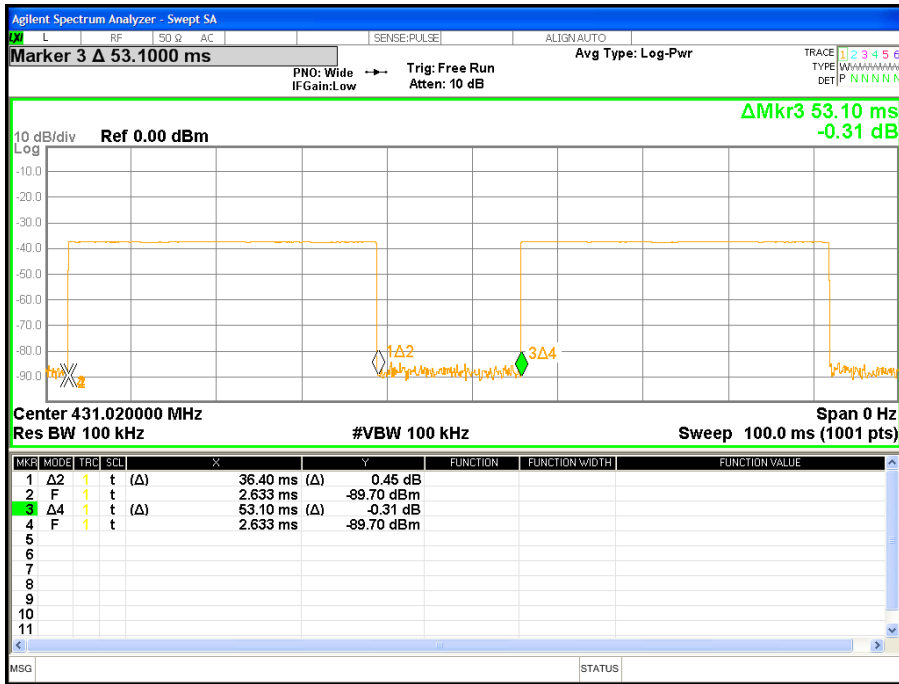

439.36MHz	
Total On interval in a complete pulse train(ms)	36.80
Length of a complete pulse train(ms)	52.90
Duty Cycle(%)	69.56%
Duty Cycle Correction Factor(dB)	-3.15

TX Mode

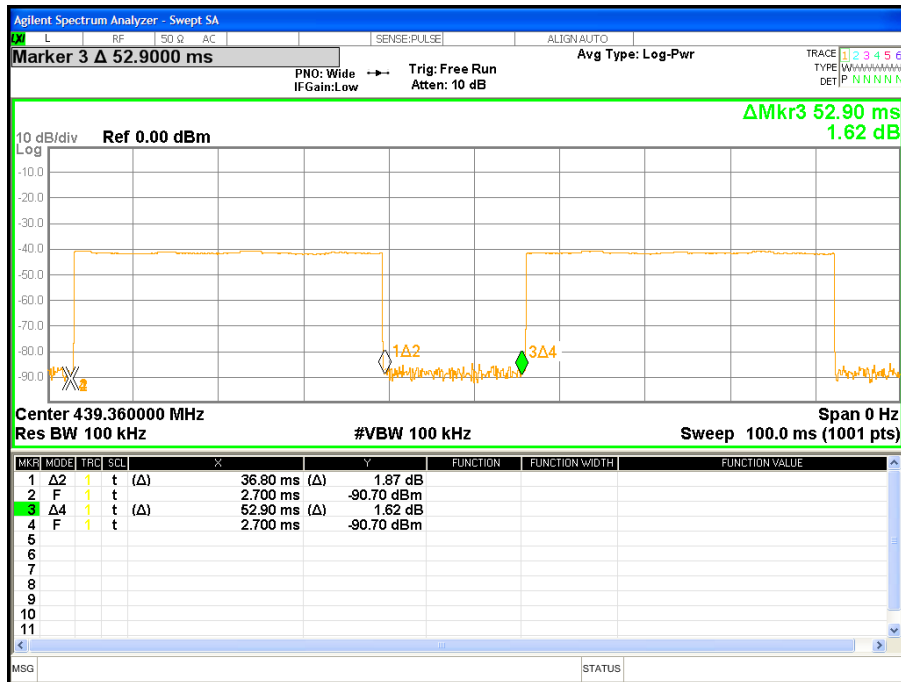

For initiate transmission to Tag Manager to notify abnormal readings

431.04MHz	
Total On interval in a complete pulse train(ms)	36.40
Length of a complete pulse train(ms)	53.10
Duty Cycle(%)	68.55%
Duty Cycle Correction Factor(dB)	-3.27

TX Mode

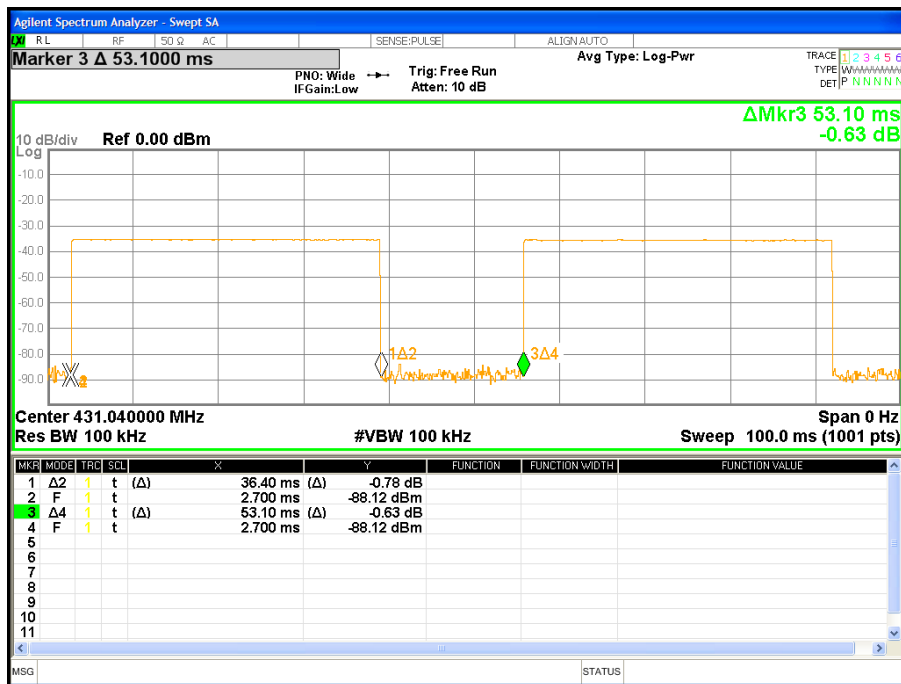

435.28MHz	
Total On interval in a complete pulse train(ms)	36.50
Length of a complete pulse train(ms)	52.80
Duty Cycle(%)	69.13%
Duty Cycle Correction Factor(dB)	-3.21

TX Mode



439.36MHz	
Total On interval in a complete pulse train(ms)	36.80
Length of a complete pulse train(ms)	52.90
Duty Cycle(%)	69.56%
Duty Cycle Correction Factor(dB)	-3.15

TX Mode



7. AUTOMATICALLY DEACTIVATE

7.1 STANDARD REQUIREMENT

A transmitter activated automatically shall cease transmission within 5 seconds after activation

7.2 TEST PROCEDURE

The EUT was directly connected to the spectrum analyzer and antenna output port as show in the block diagram below.

Spectrum Setting : RBW= 100KHz, VBW=100KHz.

Note:

(1)The EUT is comply with FCC PART 15 clause 15.231(a)(2).manually working mode are pre-tested.and only the worst result is reported.

7.3 TEST SETUP



7.4 TEST RESULTS

For send acknowledgement to Tag Manager

Test Channel(MHz)	Activation time	Limit(Sec)	Result
431.04	1.830 s	5 s	Pass

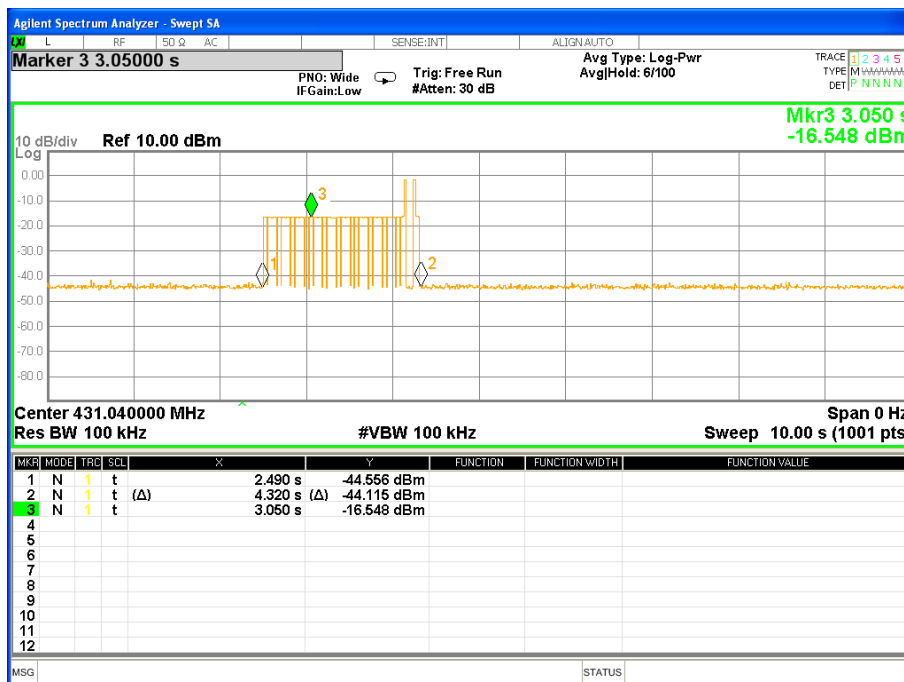

Mark 1: Start transmitting

Mark 2: Stop transmitting

Activation time= Mark 2- Mark 1=4.320-2.490=1.830s

Test Channel(MHz0)	Activation time	Limit(Sec)	Result
435.28	2.07s	5 s	Pass

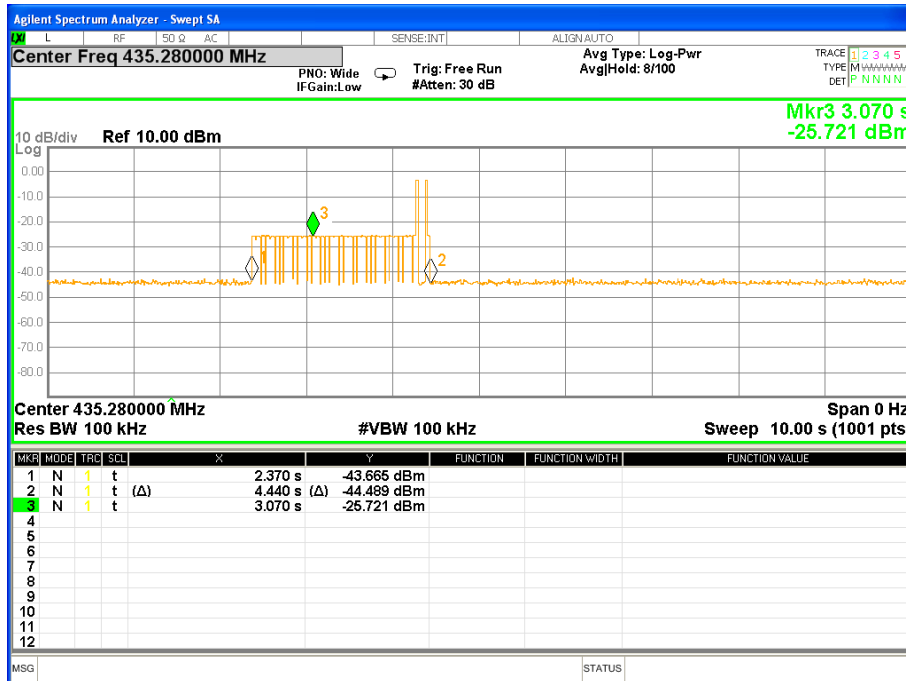

Mark 1: Start transmitting

Mark 2: Stop transmitting

Activation time= Mark 2- Mark 1=4.440-2.370=2.07s

Test Channel(MHz0	Activation time	Limit(Sec)	Result
439.36	1.34s	5 s	Pass

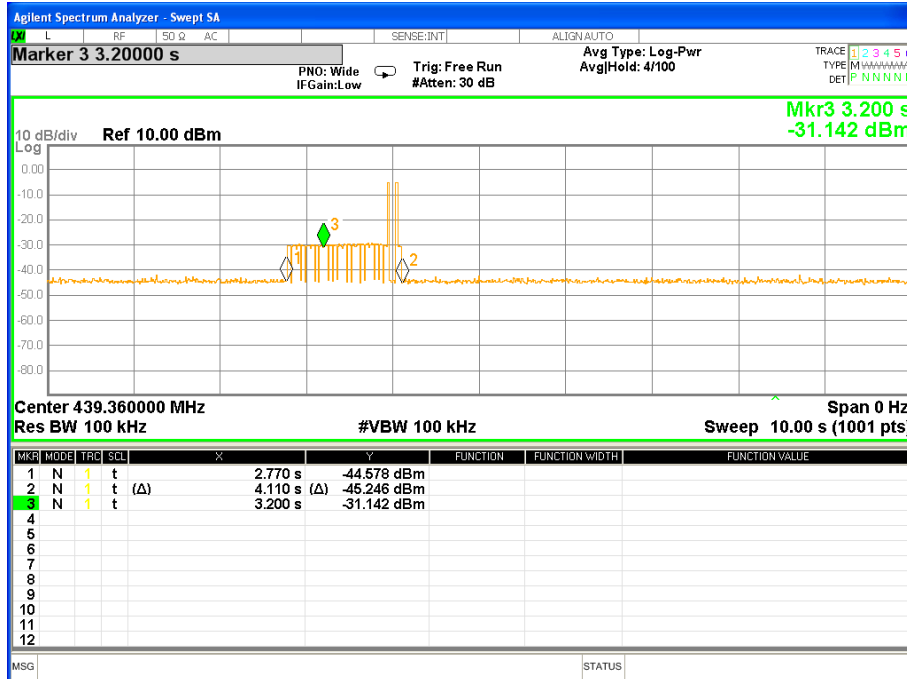

Mark 1: Start transmitting

Mark 2: Stop transmitting

Activation time= Mark 2- Mark 1=4.110-2.770=1.34s

For transmit the entire sensor reading information

Test Channel(MHz0)	Activation time	Limit(Sec)	Result
431.04	2.376 s	5 s	Pass

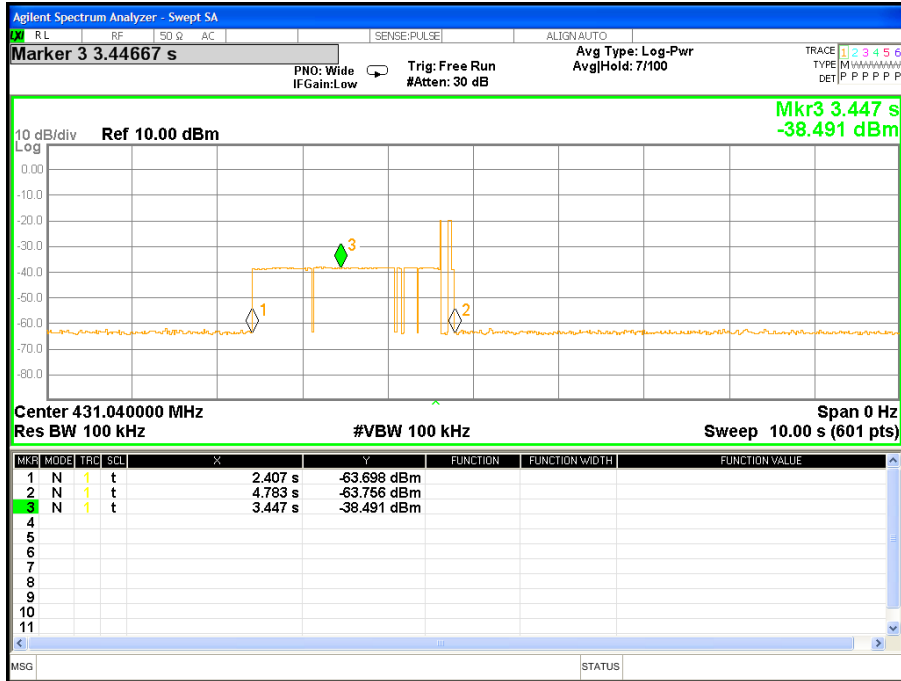

Mark 1: Start transmitting

Mark 2: Stop transmitting

Activation time= Mark 2- Mark 1=4.783-2.407=2.376s

Test Channel(MHz0)	Activation time	Limit(Sec)	Result
435.28	0.75s	5 s	Pass

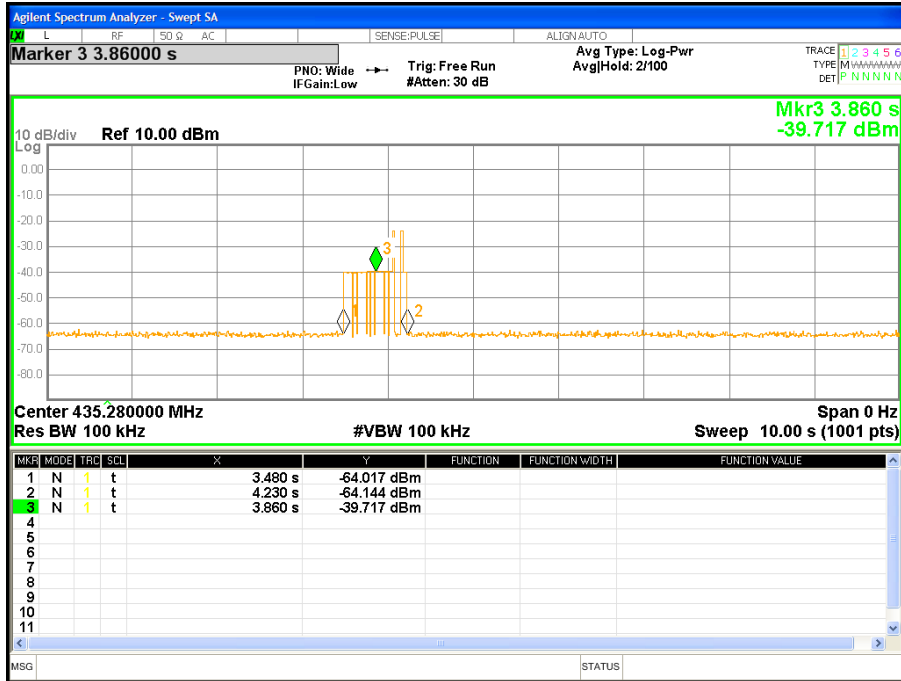

Mark 1: Start transmitting
 Mark 2: Stop transmitting
 Activation time= Mark 2- Mark 1=4.230-3.480=0.75s

Test Channel(MHz0	Activation time	Limit(Sec)	Result
439.36	1.66s	5 s	Pass

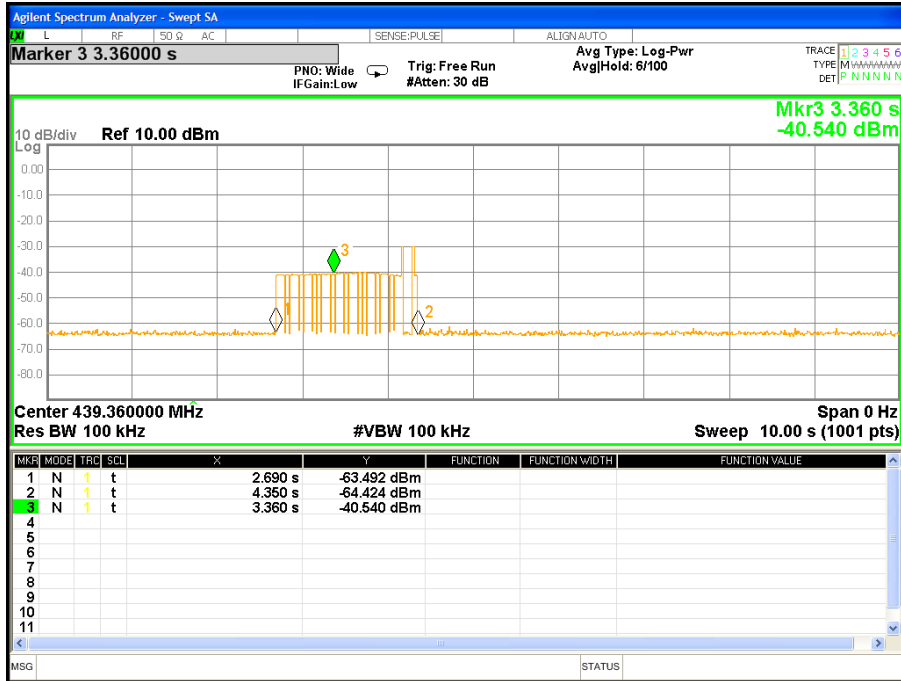

Mark 1: Start transmitting

Mark 2: Stop transmitting

Activation time= Mark 2- Mark 1=4.350-2.690=1.66s

For initiate transmission to Tag Manager to notify abnormal readings

Test Channel(MHz0)	Activation time	Limit(Sec)	Result
431.04	0.87 s	5 s	Pass



Mark 1: Start transmitting

Mark 2: Stop transmitting

Activation time= Mark 2- Mark 1=4.643-3.765=0.878s

Test Channel(MHz0)	Activation time	Limit(Sec)	Result
435.28	1.32s	5 s	Pass



Mark 1: Start transmitting

Mark 2: Stop transmitting

Activation time= Mark 2- Mark 1=4.930-3.610=1.32s

Test Channel(MHz0	Activation time	Limit(Sec)	Result
439.36	0.80s	5 s	Pass

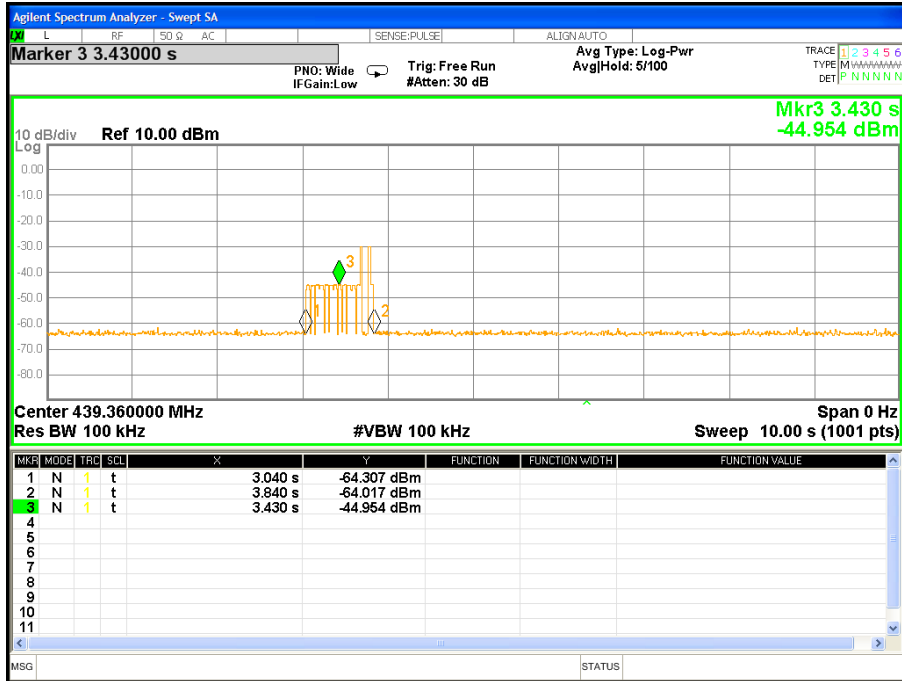

Mark 1: Start transmitting
 Mark 2: Stop transmitting
 Activation time= Mark 2- Mark 1=3.840-3.040=0.80s

8. ANTENNA REQUIREMENT

8.1 STANDARD REQUIREMENT

According to the FCC Part 15 Paragraph 15.203, an intentional radiator shall be designed to ensure that no antenna other than that furnished by the responsible party shall be used with the device. The use of a permanently attached antenna to the intentional radiator shall be considered sufficient to comply with the provisions of this section.

8.2 EUT ANTENNA

The EUT antenna is Internal PCB Antenna. It conforms to the standard requirements.

Radiated Measurement Photos(9KHz-30MHz)

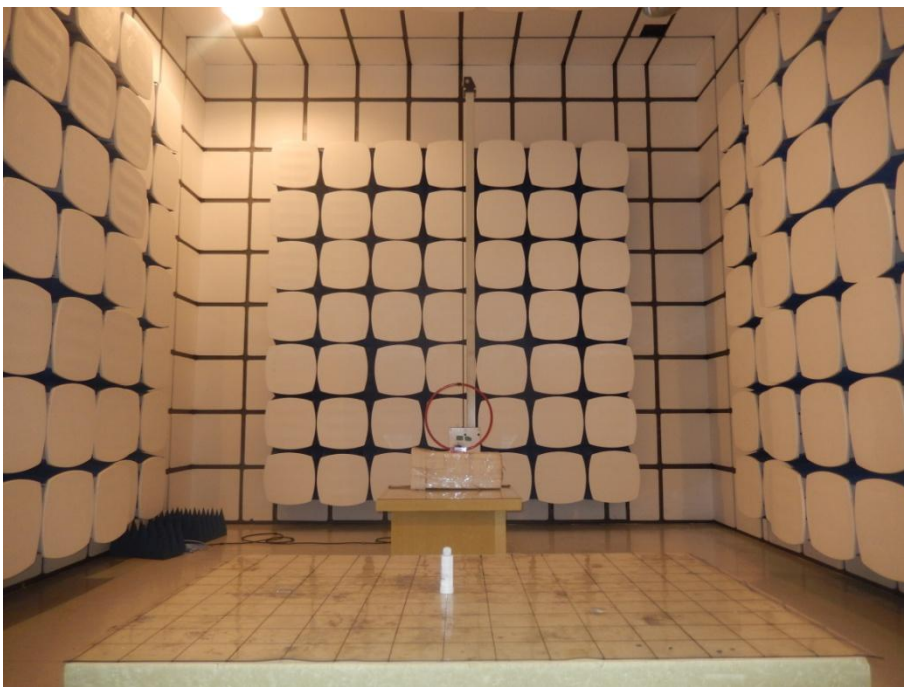

Radiated Measurement Photos(30MHz-1GHz)

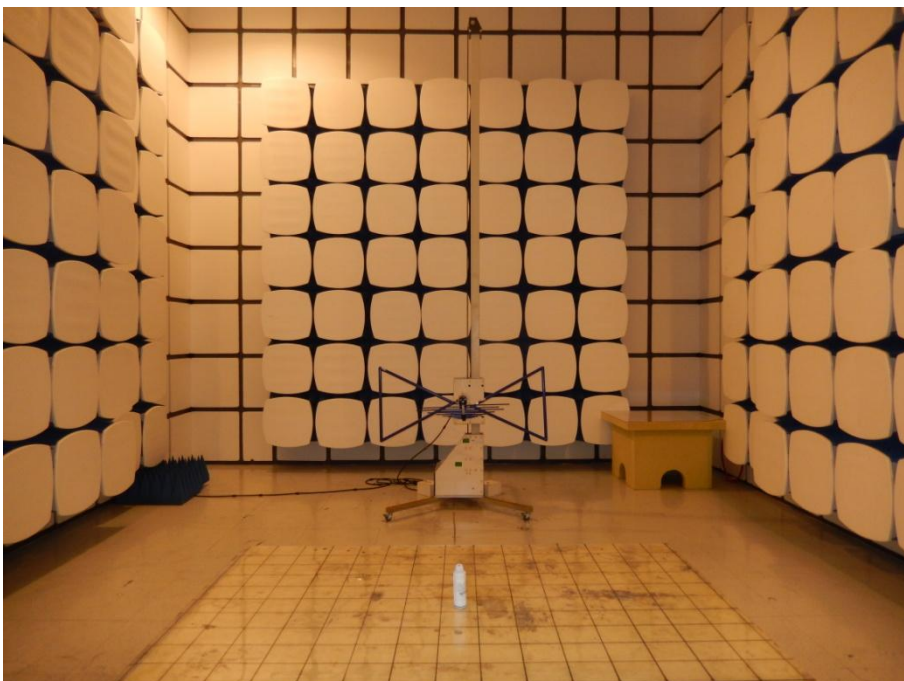

Radiated Measurement Photos(Above1GHz)

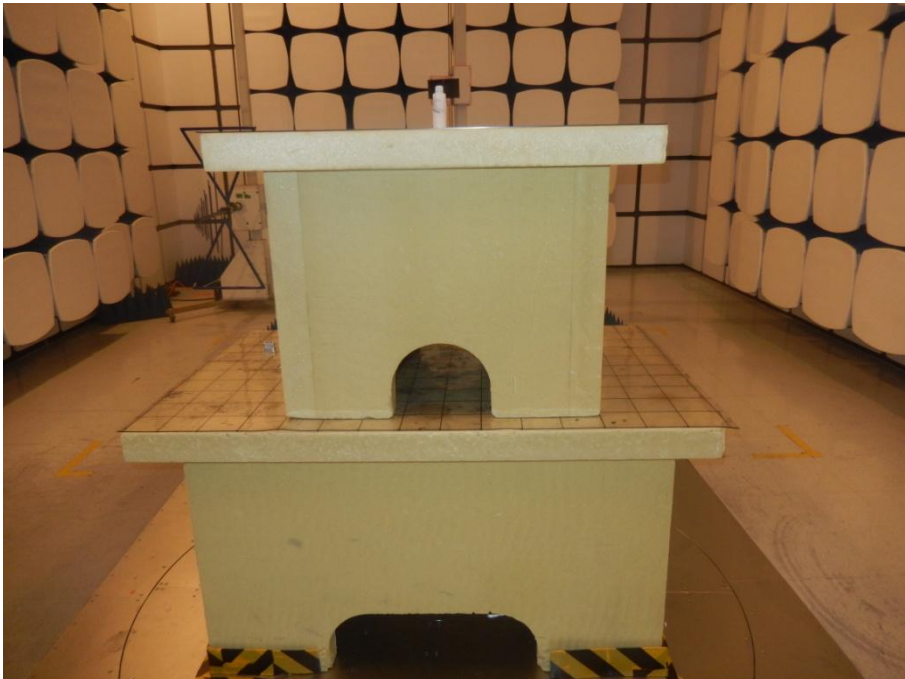

*****END OF THE REPORT*****