

7.4.4 End job

To finish a job, select the running job and click on "End job". Alternatively, right-click on the running job and select "End job".

WIN - WERMA Signaltechnik GmbH + Co. KG - [Job overview]

Control station Productivity Runtime Job Control Routing

Job overview Enter job Start job End job Edit job Delete job Full screen Report / Export Activation Settings Software update Manual Contact Info

ID Description Start date until Job number Machine State

ID	Job number	Description	Machine	State	Job progression
1	4856	841.225.978	00-0E-39	Completed	105%
2	6483	846.365.978	00-0E-39	Completed	101%
3	7984	207.866.124	00-0E-39	Completed	102%
4	1472	114.458.323	00-0E-39	Completed	96%
5	2643	846.365.978	00-0E-39	Completed	113%
7	8956	207.866.124	00-0E-39	Running	22%
8	7921	114.458.323	<not assigned>	Waiting	0%
9	1246	846.365.978	<not assigned>	Waiting	0%
10	468235	846.365.978	<not assigned>	Waiting	0%
11	154795	207.866.124	<not assigned>	Waiting	0%

Job details

Job information

ID 7 State Running

Job number 8956

Description 207.866.124

Machine 00-0E-39

Schedule deviation +0,0 hr

Job progression: 22%

Productivity: 71%

Ready. Connected to WIN receiver 1

7.4.5 Edit job

To edit a job, select the job and click on "Edit job". Alternatively, right-click on the job and select "Edit job".

WIN - WERMA Signaltechnik GmbH + Co. KG - [Job overview]

Control station Productivity Runtime Job Control Routing

Job overview Enter job Start job End job Edit job Delete job Full screen Report / Export Activation Settings Software update Manual Contact Info

ID Description Start date until Job number Machine State

ID	Job number	Description	Machine	State	Job progression
1	4856	841.225.978	00-0E-39	Completed	105%
2	6483	846.365.978	00-0E-39	Completed	101%
3	7984	207.866.124	00-0E-39	Completed	102%
4	1472	114.458.323	00-0E-39	Completed	96%
6	2643	846.365.978	00-0E-39	Completed	113%
7	8956	207.866.124	00-0E-39	Running	22%
8	7921	114.458.323	<not assigned>	Waiting	0%
9	1246	846.365.978	<not assigned>	Waiting	0%
10	468235	846.365.978	<not assigned>	Waiting	0%
11	154795	207.866.124	<not assigned>	Waiting	0%

Job details

Job information

ID 7 State Running

Job number 8956

Description 207.866.124

Machine 00-0E-39

Schedule deviation +0,0 hr

Job progression: 22%

Productivity: 71%

Ready. Connected to WIN receiver 1

7.4.6 Correction of a completed job

To correct a completed job, select the completed job and click "Edit job". Alternatively, right-click on the completed job and select "Edit job".

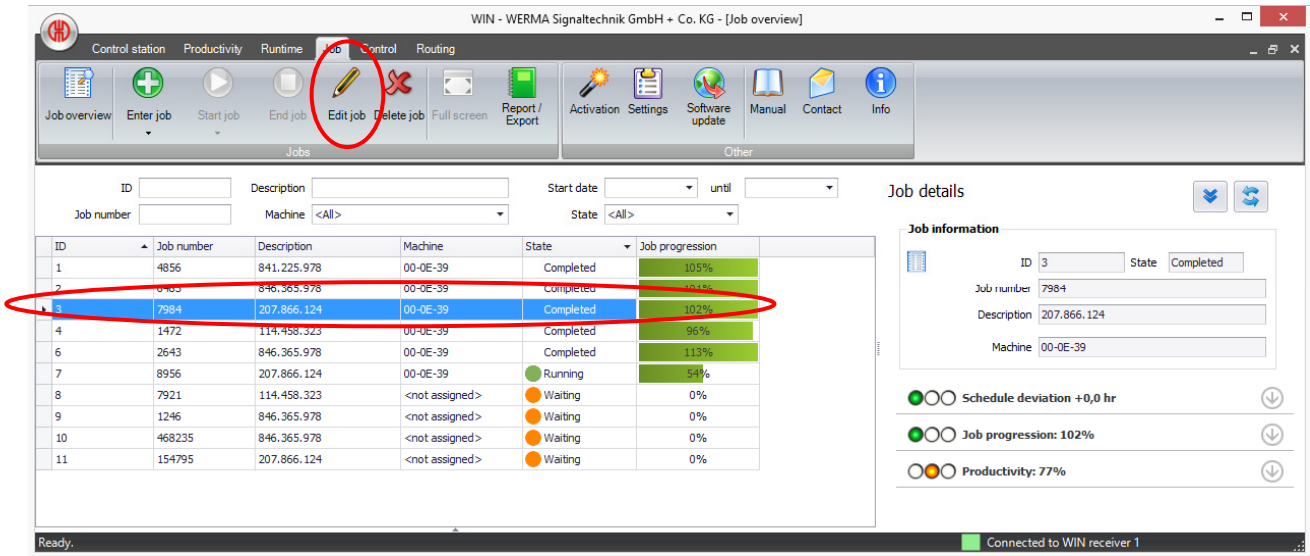

The following window opens:

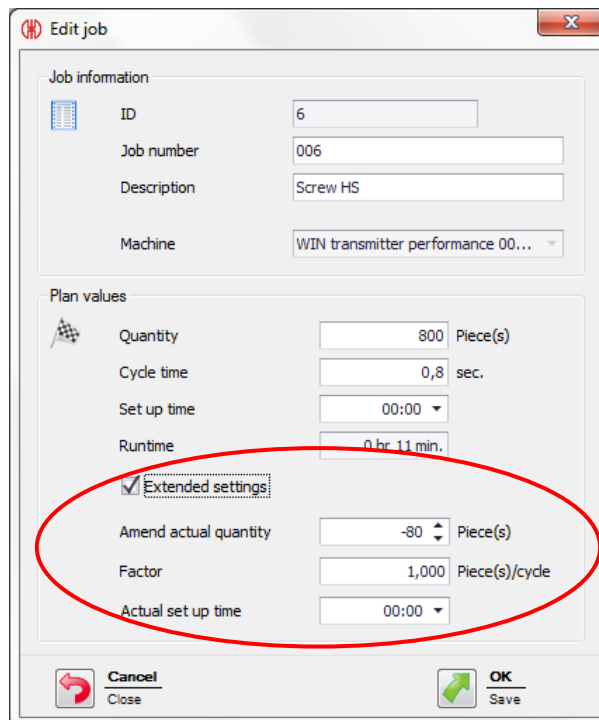

In the "Extended settings" tab, you can enter a positive or negative value (e.g. -10). In addition, it is also possible to enter the actual set up time.

7.4.7 Delete job

To delete a job, select a job and click on "Delete job". Alternatively, right-click on the waiting job and select "Delete job".

WIN - WERMA Signaltechnik GmbH + Co. KG - [Job overview]

Control station Productivity Runtime Job Control Routing

Job overview Enter job Start job End job Edit job **Delete job** Full screen Report / Export Activation Settings Software update Manual Contact Info

Jobs Other

ID Description Start date until Job details

Job number Machine <All> State <All>

ID	Job number	Description	Machine	State	Job progression
1	4856	841.225.978	00-OE-39	Completed	105%
2	6883	846.365.978	00-OE-39	Completed	101%
3	7984	207.866.124	00-OE-39	Completed	102%
4	1472	114.458.323	00-OE-39	Completed	96%
6	2643	846.365.978	00-OE-39	Completed	113%
7	8956	207.866.124	00-OE-39	Running	94%
8	7921	114.458.323	<not assigned>	Waiting	0%
9	1246	846.365.978	<not assigned>	Waiting	0%
10	468235	846.365.978	<not assigned>	Waiting	0%
11	154795	207.866.124	<not assigned>	Waiting	0%

Job information

ID 3 State Completed

Job number 7984

Description 207.866.124

Machine 00-OE-39

Schedule deviation +0,0 hr

Job progression: 102%

Productivity: 77%

Ready. Connected to WIN receiver 1

7.4.8 Duplicate a job

To duplicate a job, right-click on the job and select "Duplicate job".

7.4.9 Filter / sort jobs

All jobs in the job overview can be filtered and sorted according to various categories.

The following categories are available for selection:

- ID
- Job number
- Description
- Machine
- Start date
- State

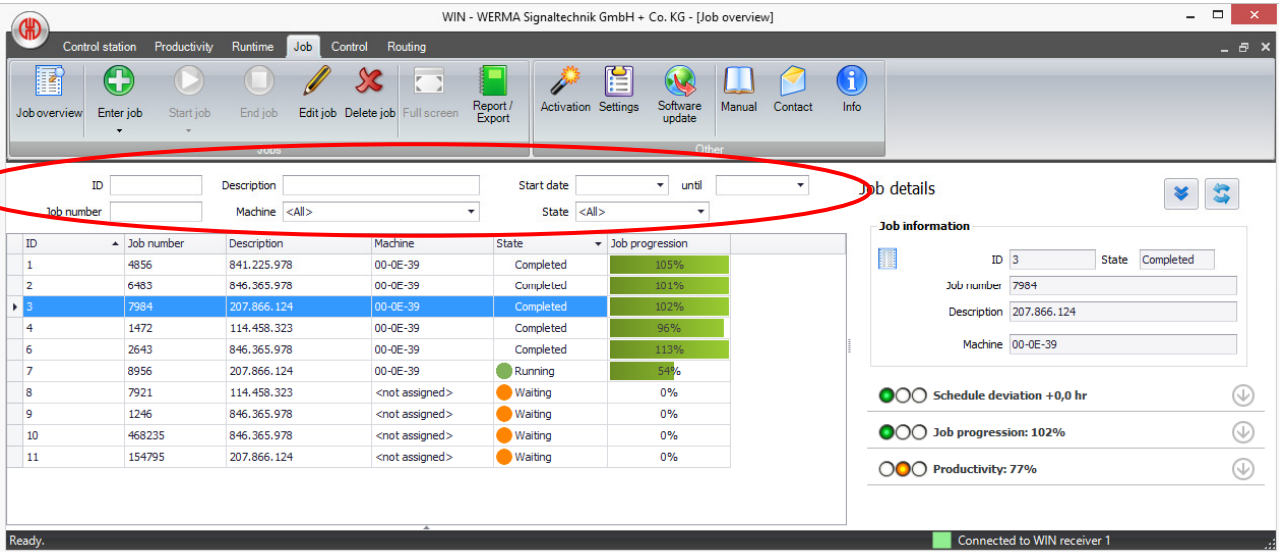

WIN - WERMA Signaltechnik GmbH + Co. KG - [Job overview]

Control station Productivity Runtime Job Control Routing

Job overview Enter job Start job End job Edit job Delete job Full screen Report / Export Activation Settings Software update Manual Contact Info

until

ID	Job number	Description	Machine	State	Job progression
1	4856	841.225.978	00-OE-39	Completed	105%
2	6483	846.365.978	00-OE-39	Completed	101%
3	7984	207.866.124	00-OE-39	Completed	102%
4	1472	114.458.323	00-OE-39	Completed	96%
6	2643	846.365.978	00-OE-39	Completed	113%
7	8956	207.866.124	00-OE-39	Running	54%
8	7921	114.458.323	<not assigned>	Waiting	0%
9	1246	846.365.978	<not assigned>	Waiting	0%
10	468235	846.365.978	<not assigned>	Waiting	0%
11	154795	207.866.124	<not assigned>	Waiting	0%

Job details

Job information

ID State

Job number

Description

Machine

Schedule deviation +0,0 hr

Job progression: 102%

Productivity: 77%

Ready. Connected to WIN receiver 1

To perform an ascending or descending sort, click on the column name in the job overview. The jobs are sorted accordingly.

The screenshot shows the 'Job overview' window with a table of jobs. The 'Job number' column is circled in red. The 'Job details' panel on the right shows the following information:

ID	Job number	Description	Machine	State	Job progression
9	1246	846.365.978	<not assigned>	Waiting	0%
4	1472	114.458.323	00-0E-39	Completed	96%
11	154795	207.866.124	<not assigned>	Waiting	0%
6	2643	846.365.978	00-0E-39	Completed	113%
10	468235	846.365.978	<not assigned>	Waiting	0%
1	4856	841.225.978	00-0E-39	Completed	105%
2	6483	846.365.978	00-0E-39	Completed	101%
8	7921	114.458.323	<not assigned>	Waiting	0%
3	7984	207.866.124	00-0E-39	Completed	102%
7	8956	207.866.124	00-0E-39	Running	86%

The 'Job details' panel shows:

- Job information: ID 9, State Waiting
- Job number: 1246
- Description: 846.365.978
- Machine: <not assigned>
- Schedule deviation: 0%
- Job progression: 0%
- Productivity: 0%

7.4.10 Job details

To view the job detail, select a job from the Job overview.

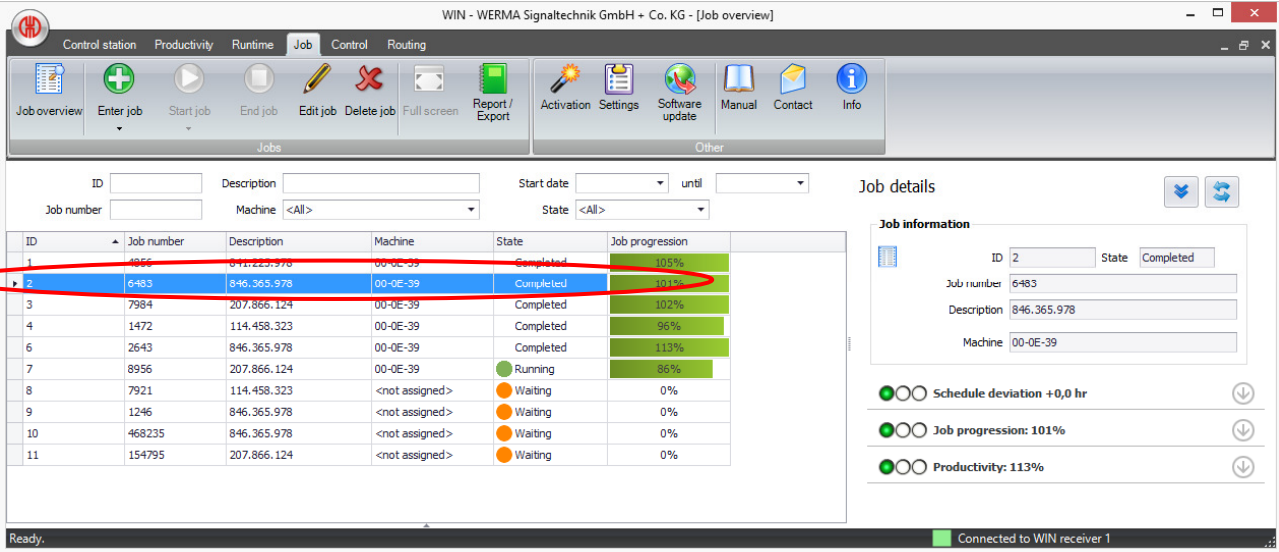

The screenshot shows the 'Job overview' window with a table of jobs. The job with ID 2 is selected, and its details are displayed in the 'Job details' panel on the right.

ID	Job number	Description	Machine	State	Job progression
1	4056	071.223.978	00-0E-39	Completed	105%
2	6483	846.365.978	00-0E-39	Completed	101%
3	7984	207.866.124	00-0E-39	Completed	102%
4	1472	114.458.323	00-0E-39	Completed	96%
6	2643	846.365.978	00-0E-39	Completed	113%
7	8956	207.866.124	00-0E-39	Running	86%
8	7921	114.458.323	<not assigned>	Waiting	0%
9	1246	846.365.978	<not assigned>	Waiting	0%
10	468235	846.365.978	<not assigned>	Waiting	0%
11	154795	207.866.124	<not assigned>	Waiting	0%

Job details

Job information

ID: 2 State: Completed

Job number: 6483

Description: 846.365.978

Machine: 00-0E-39

Schedule deviation: +0,0 hr

Job progression: 101%

Productivity: 113%

The following details are displayed:

- Job information
- Schedule deviation
- Job progression
- Productivity

The last three points are also equipped with a traffic light system, so you can see at a glance how the job is running.

7.4.10.1 Update job details

Click on "update" to refresh all data in this area for this job as well as the table on the left hand side.

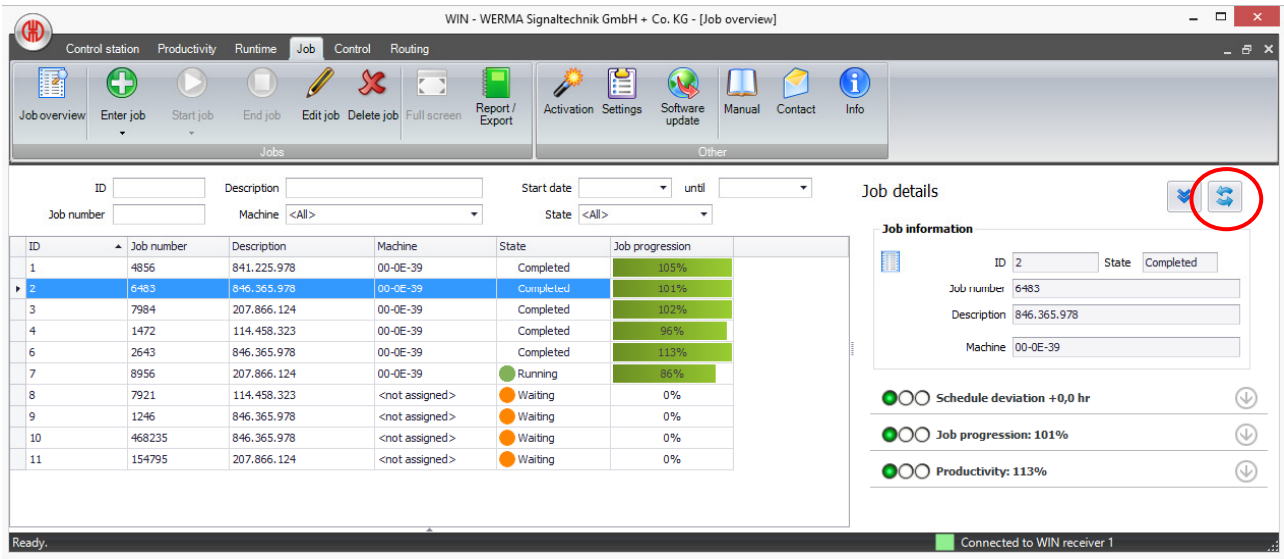

7.4.10.2 Module change

Clicking on the "arrow" takes you either to the Productivity module or to the Runtime module.

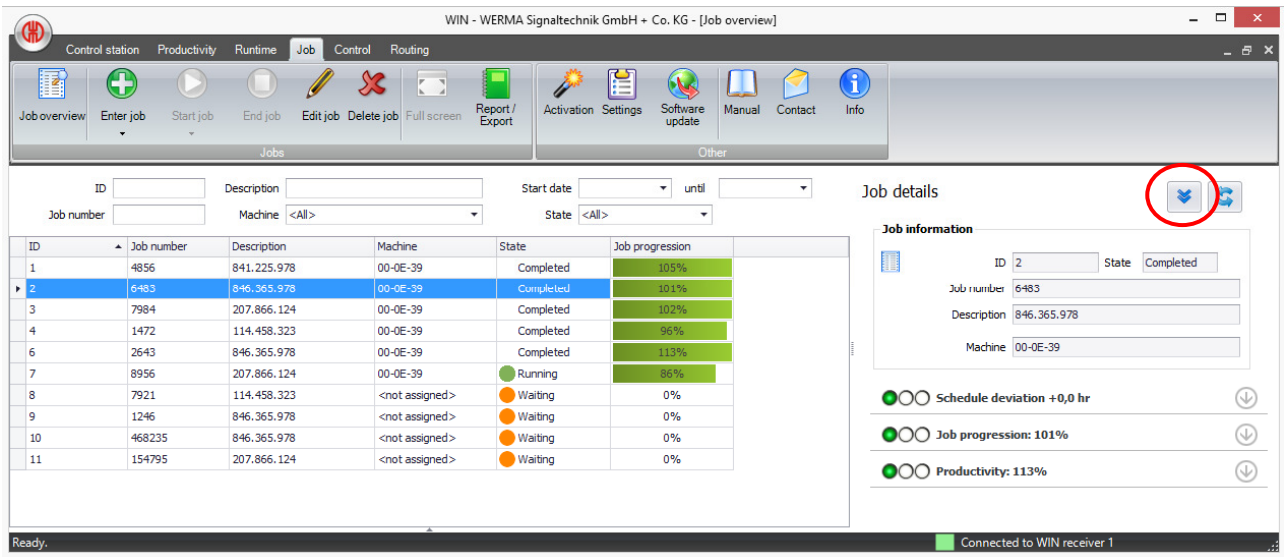

Note: The selected time period in the Productivity or the Runtime module corresponds to the time period of the chosen job.

7.4.10.3 Editing the traffic light settings

The traffic lights for schedule deviation, job progression and productivity can be individually adjusted.

Note: The traffic light settings are stored per user.

To configure the traffic light you need to adjust the locally stored ini-file.

To change go to:

- **<C:\ProgramData\WERMA\WERMA-WIN-3.0.>** in Windows Vista or Windows 7
- **<C:\Documents and Settings\All Users\Application Data\WERMA\WERMA-WIN-3.0.>** in Windows XP

and open the ini-file.

In the file, see the following section:

[Orders]

ProductivityGreenLimit=100

ProductivityYellowLimit=75

CompletionGreenLimit=100

CompletionYellowLimit=90

RuntimeGreenLimit=100

RuntimeYellowLimit=110

Proceed as follows to adjust the traffic light settings:

- For the schedule deviation traffic light:

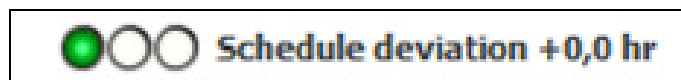

1. If the "RuntimeYellowLimit=110", the traffic light is set to red from +11%.
2. If the "RuntimeGreenLimit=100", the traffic light is set to yellow from +1% to +10% inclusive.
3. Only for +0% or a negative deviation the traffic light is set to green.
4. You can adjust the setting individually ($199 \geq 100$).
5. Save the ini file.

-
- For the job progression traffic light:



1. If the "CompletionYellowLimit=90", the traffic light is set to red from 0% to including 89%.
2. If the "CompletionGreenLimit=10", the traffic light is set to yellow from 90% to including 99%.
3. Only for >100% the traffic light is set to green.
4. You can adjust the setting individually (100≥0).
5. Save the ini file.

- For the productivity traffic light:



1. If the "ProductivityYellowLimit=75", the traffic light is set to red from 0% to including 74%.
2. If the "ProductivityGreenLimit=100", the traffic light is set to yellow from 75% to including 99%.
3. Only for >100% the traffic light is set to green.
4. You can adjust the setting individually (100≥0).
5. Save the ini file.

7.4.10.4 Schedule deviation

The schedule deviation area provides information about set up time, start time, runtime and end time. Plan and the Actual times are given for each of these. The schedule deviation is specified in machine hours.

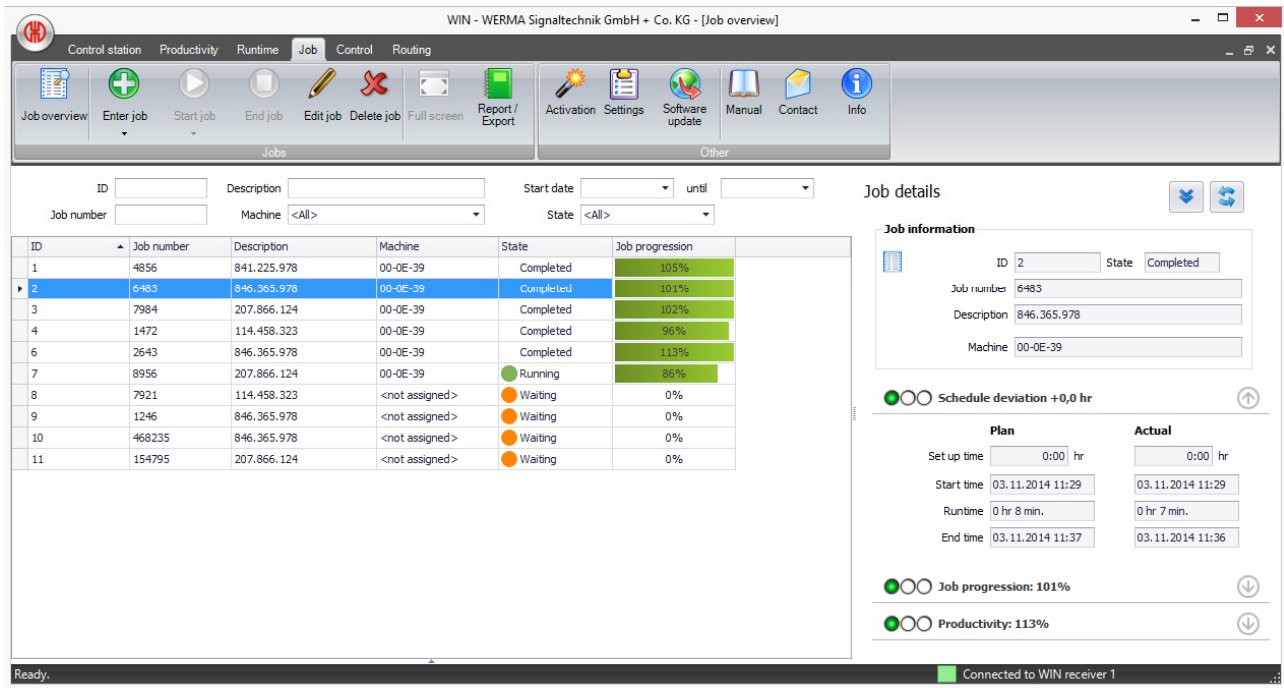

The screenshot shows the 'Job overview' window in the WERMA software. The main area contains a table of jobs with columns for ID, Job number, Description, Machine, State, and Job progression. Job 2 (ID 6483) is selected and highlighted in blue. To the right, the 'Job details' panel shows information for job ID 2, including its state (Completed), job number (6483), description (846.365.978), and machine (00-0E-39). Below this, the 'Schedule deviation' is shown as +0,0 hr. A comparison table for 'Plan' vs 'Actual' times is also visible, showing set up, start, runtime, and end times. The 'Job progression' is 101% and 'Productivity' is 113%.

ID	Job number	Description	Machine	State	Job progression
1	4856	841.225.978	00-0E-39	Completed	105%
2	6483	846.365.978	00-0E-39	Completed	101%
3	7984	207.866.124	00-0E-39	Completed	102%
4	1472	114.458.323	00-0E-39	Completed	96%
6	2643	846.365.978	00-0E-39	Completed	113%
7	8956	207.866.124	00-0E-39	Running	86%
8	7921	114.458.323	<not assigned>	Waiting	0%
9	1246	846.365.978	<not assigned>	Waiting	0%
10	468235	846.365.978	<not assigned>	Waiting	0%
11	154795	207.866.124	<not assigned>	Waiting	0%

Note: 0.1 machine hours correspond to 6 minutes; 1 machine hour corresponds to 60 minutes.

7.4.10.5 Job progression

The job progression area provides information about plan quantity and actual quantity. In addition, you can see and amend actual quantity and the factor, entered for this job.

For a **running job**, the Job progression is the **current** actual quantity divided by the **current** plan quantity, expressed as a percentage.

For a completed job the Job progression is the actual quantity divided by the plan quantity, expressed as a percentage.

The screenshot displays the 'Job overview' window of the WIN - WERMA Signaltechnik GmbH + Co. KG software. The main area contains a table of jobs with the following data:

ID	Job number	Description	Machine	State	Job progression
1	4856	841.225.978	00-0E-39	Completed	105%
2	6483	846.365.978	00-0E-39	Completed	101%
3	7984	207.866.124	00-0E-39	Completed	102%
4	1472	114.458.323	00-0E-39	Completed	96%
6	2643	846.365.978	00-0E-39	Completed	113%
7	8956	207.866.124	00-0E-39	Running	86%
8	7921	114.458.323	<not assigned>	Waiting	0%
9	1246	846.365.978	<not assigned>	Waiting	0%
10	468235	846.365.978	<not assigned>	Waiting	0%
11	154795	207.866.124	<not assigned>	Waiting	0%

The right-hand 'Job details' panel for Job 2 shows:

- Job information: ID 2, State Completed, Job number 6483, Description 846.365.978, Machine 00-0E-39.
- Schedule deviation: +0,0 hr.
- Job progression: 101%.
- Bar chart: Actual total quantity: 508, Plan total quantity: 500.
- Amend actual quantity: 0 Piece(s).
- Factor: 1 Piece(s)/cycle.
- Productivity: 113%.

7.4.10.6 Productivity

The productivity area provides information about plan cycle time and actual cycle time.

For a **running job**, the productivity is the **current** actual cycle time divided by the **current** plan cycle time, expressed as a percentage.

For a completed job, the productivity is the actual cycle time divided by the plan cycle time expressed as a percentage.

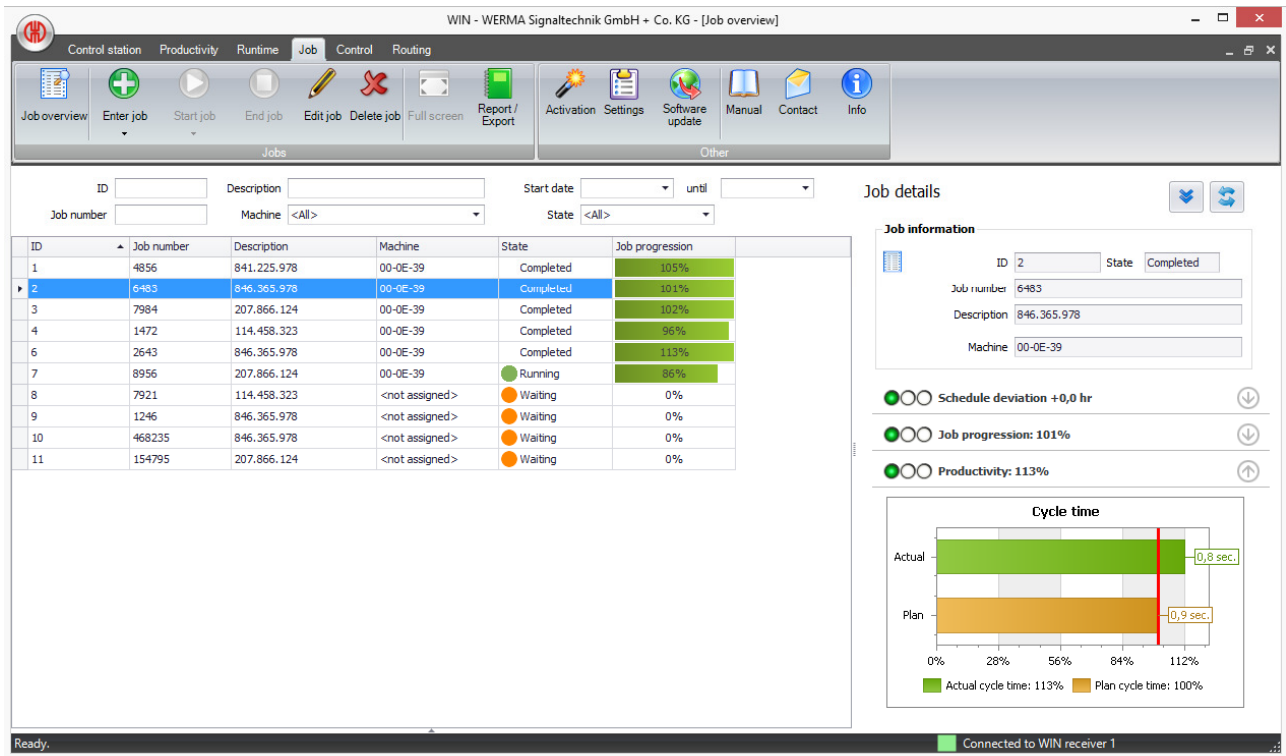

The screenshot shows the 'WIN - WERMA Signaltechnik GmbH + Co. KG - [Job overview]' window. It features a menu bar with 'Control station', 'Productivity', 'Runtime', 'Job', 'Control', and 'Routing'. Below the menu is a toolbar with icons for 'Job overview', 'Enter job', 'Start job', 'End job', 'Edit job', 'Delete job', 'Full screen', 'Report / Export', 'Activation', 'Settings', 'Software update', 'Manual', 'Contact', and 'Info'.

The main area is divided into 'Jobs' and 'Job details'. The 'Jobs' section contains a table with the following data:

ID	Job number	Description	Machine	State	Job progression
1	4856	841.225.978	00-0E-39	Completed	105%
2	6483	846.365.978	00-0E-39	Completed	101%
3	7984	207.866.124	00-0E-39	Completed	102%
4	1472	114.458.323	00-0E-39	Completed	96%
6	2643	846.365.978	00-0E-39	Completed	113%
7	8956	207.866.124	00-0E-39	Running	86%
8	7921	114.458.323	<not assigned>	Waiting	0%
9	1246	846.365.978	<not assigned>	Waiting	0%
10	468235	846.365.978	<not assigned>	Waiting	0%
11	154795	207.866.124	<not assigned>	Waiting	0%

The 'Job details' panel on the right shows information for Job ID 2 (Job number 6483, Description 846.365.978, Machine 00-0E-39, State Completed). It includes progress indicators for 'Schedule deviation +0,0 hr', 'Job progression: 101%', and 'Productivity: 113%'. A 'Cycle time' bar chart compares 'Actual' (green bar, 0,8 sec) and 'Plan' (orange bar, 0,9 sec) cycle times, with a legend indicating 'Actual cycle time: 113%' and 'Plan cycle time: 100%'.

7.4.11 Report

Note: Reports generated are based on the on the currently-selected filters and sorting. Filtering by machine will result in all jobs for that machine being considered.

To generate a report, proceed as follows:

1. Click on "Report/Export".

ID	Job number	Description	Machine	State	Job progression
1	4856	841.225.978	00-0E-39	Completed	105%
2	6483	846.365.978	00-0E-39	Completed	101%
3	7984	207.866.124	00-0E-39	Completed	102%
4	1472	114.458.323	00-0E-39	Completed	96%
6	2643	846.365.978	00-0E-39	Completed	113%
7	8956	207.866.124	00-0E-39	Running	86%
8	7921	114.458.323	<not assigned>	Waiting	0%
9	1246	846.365.978	<not assigned>	Waiting	0%
10	468235	846.365.978	<not assigned>	Waiting	0%
11	154795	207.866.124	<not assigned>	Waiting	0%

2. Now select which report you want to generate. Choose between:

- Tabular depiction of the data
- Tabular depiction of the data (individual)

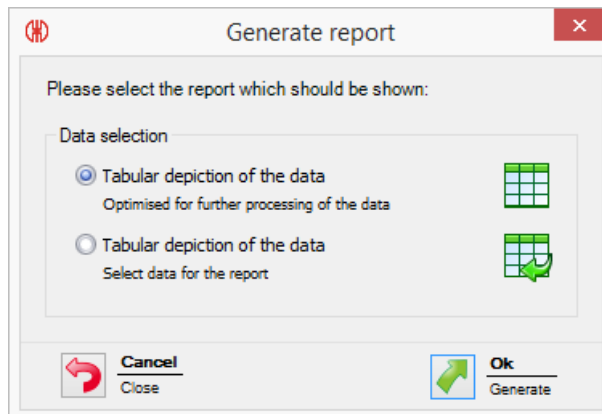

3. Confirm your selection with “OK”.

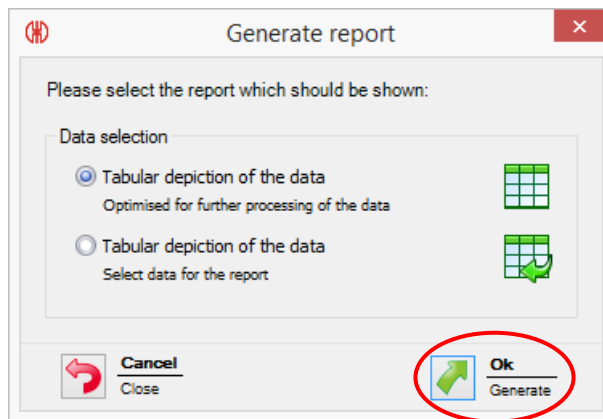

4. If you select the second option, a further window will open which allows you to select the columns for your report by checking the boxes.

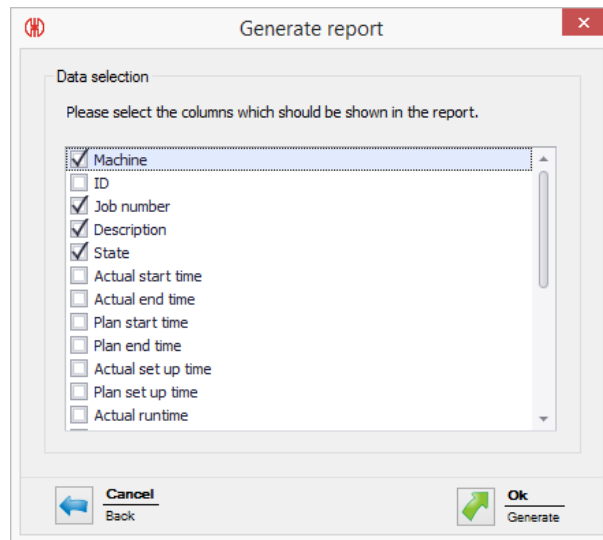

5. You can now see a preview of your selected report. Additional functions are described in section 7.7, “Report and Export Functions”.

7.5 Control Module

In this module you can define rules with certain logic functions with which you can switch or control a WIN transmitter control. You can use as an input signal for the logic function those WIN transmitters forming part of the network.

Note: A user with **WIN transmitter / WIN transmitter performance** cannot access this module – for this the WIN transmitter control hardware is required.

7.5.1 Overview of rules

In the overview of rules you can see all rules which have been set up.

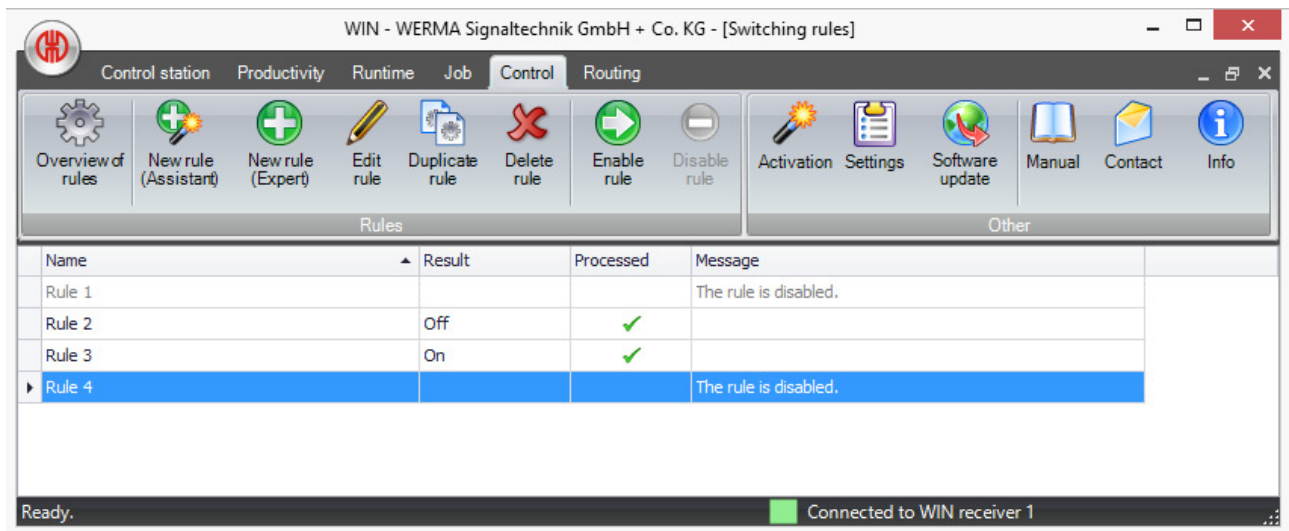

In the column "Result" you will see if the rule is running or not.

- Rule showing = "On"
- Rule not showing = "Off"

Column "Processed" shows the following:

- Rule being processed = "Green Tick"
- Transmission error to WIN control transmitter = "Red Cross"
- Switch being processed = "Egg timer"

Further information in whether the rule has been activated or not can be found in the column "Message".

7.5.2 Define a new rule

There are two ways to define a new rule. Firstly there is an Assistant which takes you through the process step by step or secondly the Expert option with which you can define your own individual rules.

7.5.2.1 New rule with Assistant

To define a new rule with the Assistant please proceed as follows:

1. Click on "New rule (Assistant)" to define a new rule.

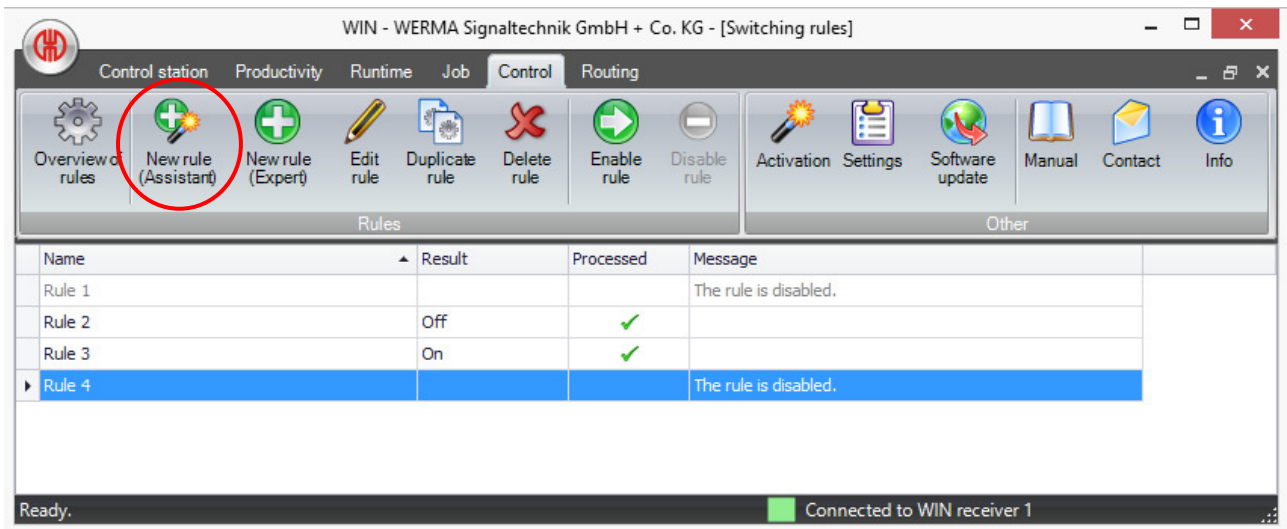

2. The following window appears which shows you an example using AND Logic. Click on "Next".

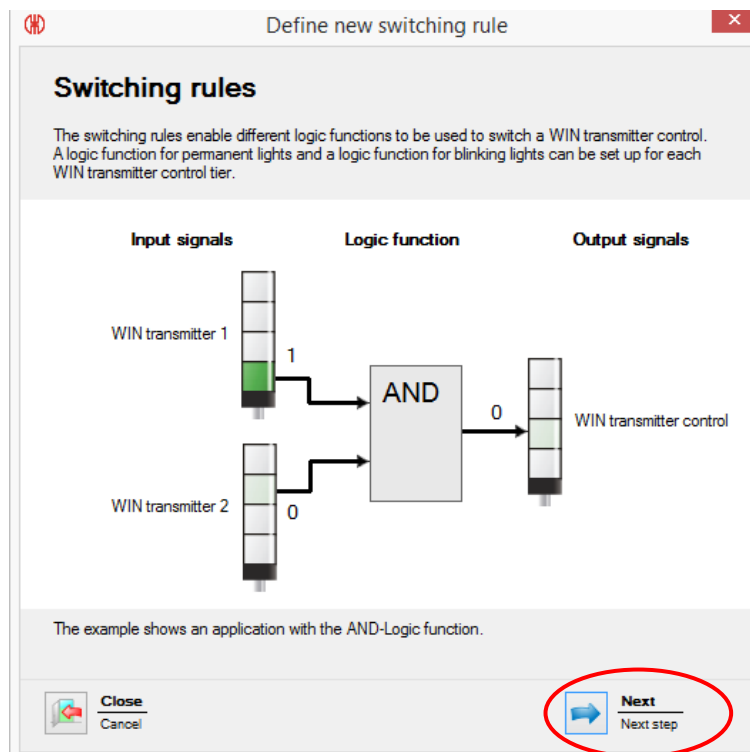

3. In the next window you can set the rule up and define the tiers to be switched by the new rule. You can choose between:

- AND – Each tier must be in the selected status
- OR – At least one tier must have the defined status
- NOR – No tier may be in the defined status
- Enter custom logic function (expert mode), see chapter **Fehler! Verweisquelle konnte nicht gefunden werden..**

Click then on “next”.

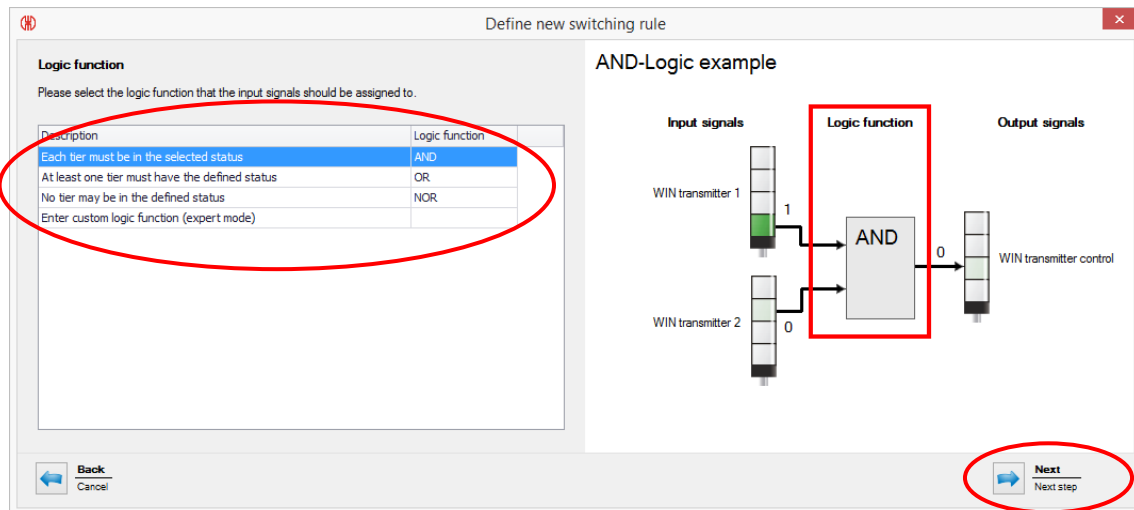

Note: In the picture right hand side you will see a picture of the selection made. You can define more than one input signal.

4. In the next step you can select the input signal which will apply for the selected Logic function. Click here on “Add”.

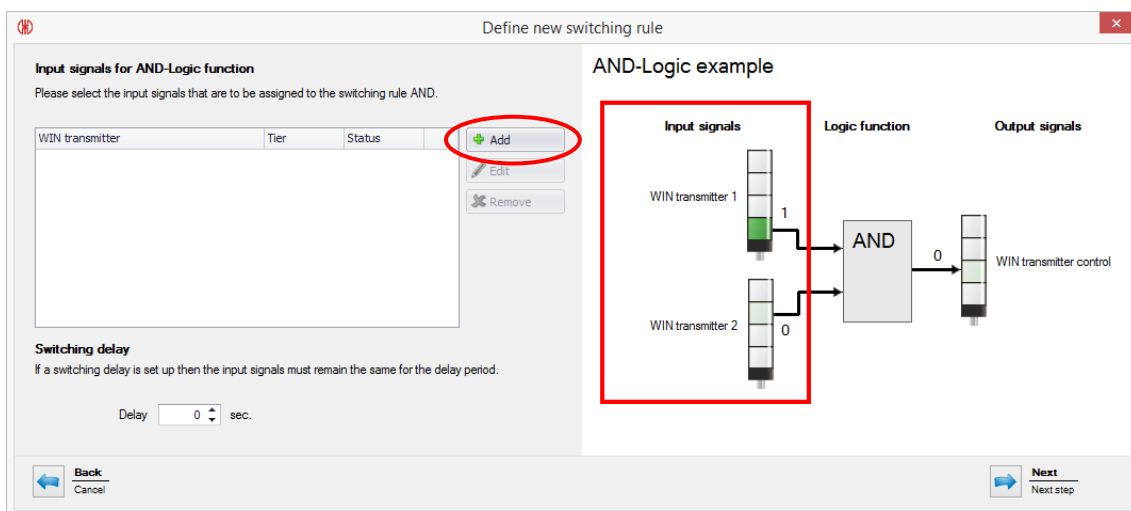

- In this dialogue box you can select the input signal by tier and status for one of the WIN transmitters connected to the WIN network.

First select a WIN transmitter from the left hand column. Then you will see the tiers displayed as have been defined in the control station view.

Select tier and then the status in which this tier must be for the input signal to apply. You have the choice between “On”, “Off”, “Connection error” and “Blinking”. “Blinking” is displayed only when the “blink recognition” has been activated for this tier.

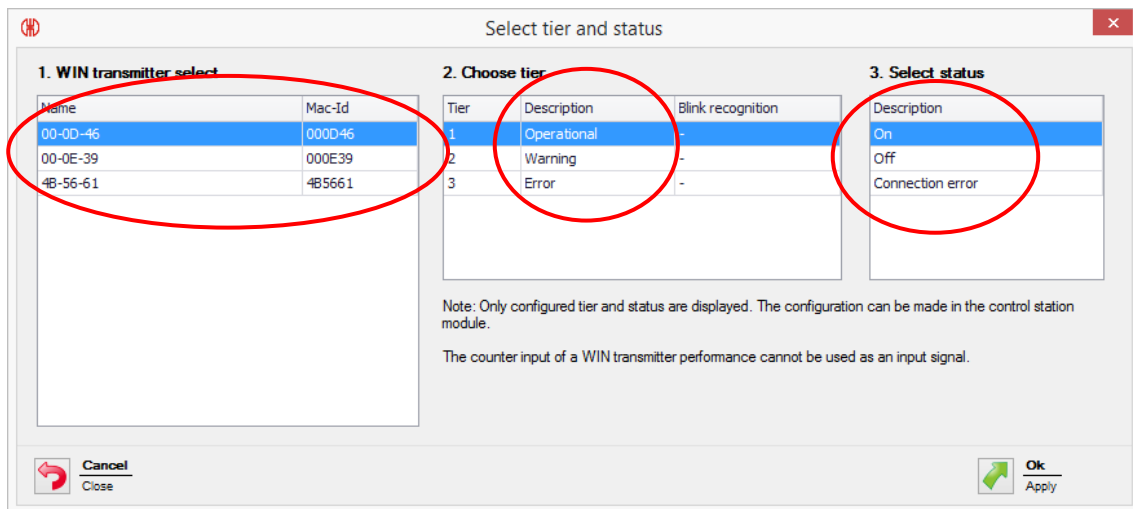

Note: The counting input signal of a WIN transmitter performance cannot be used as an input signal for a Logic function.

- Confirm your selection with “Ok”.

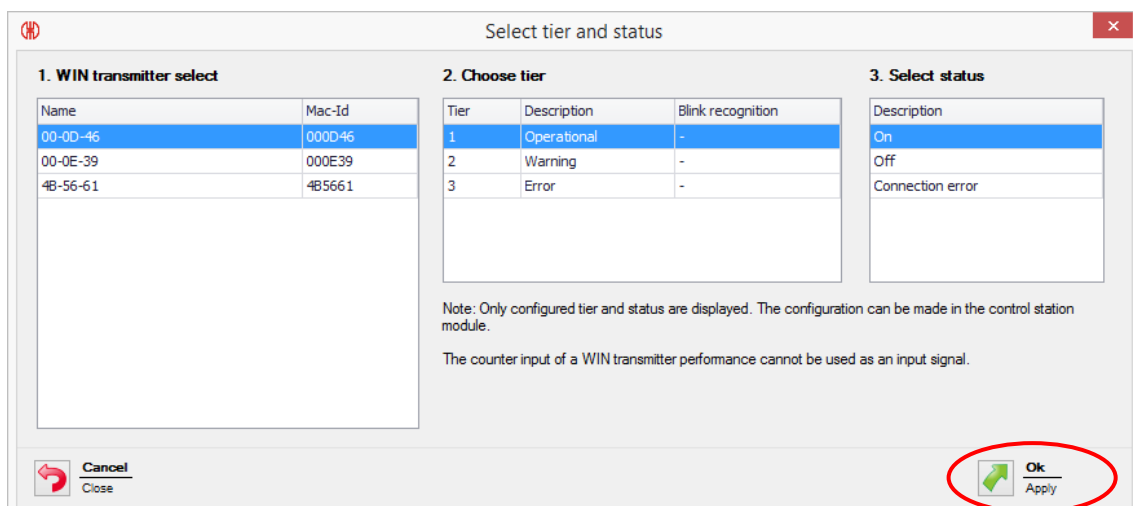

7. To define additional input signals click on "Add" and repeat steps 5 and 6 as before. The "Edit" function allows you to modify an input signal which has already been defined. "Remove" cancels an existing input signal.

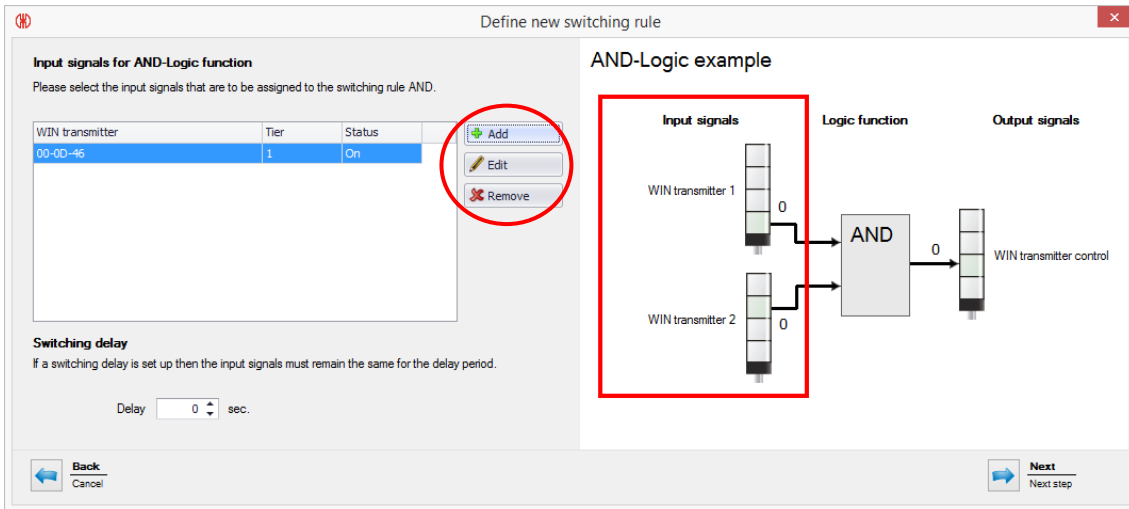

8. For each rule you can set up a switching delay. In this case every input signal must have been on for at least the time selected for the switching delay.

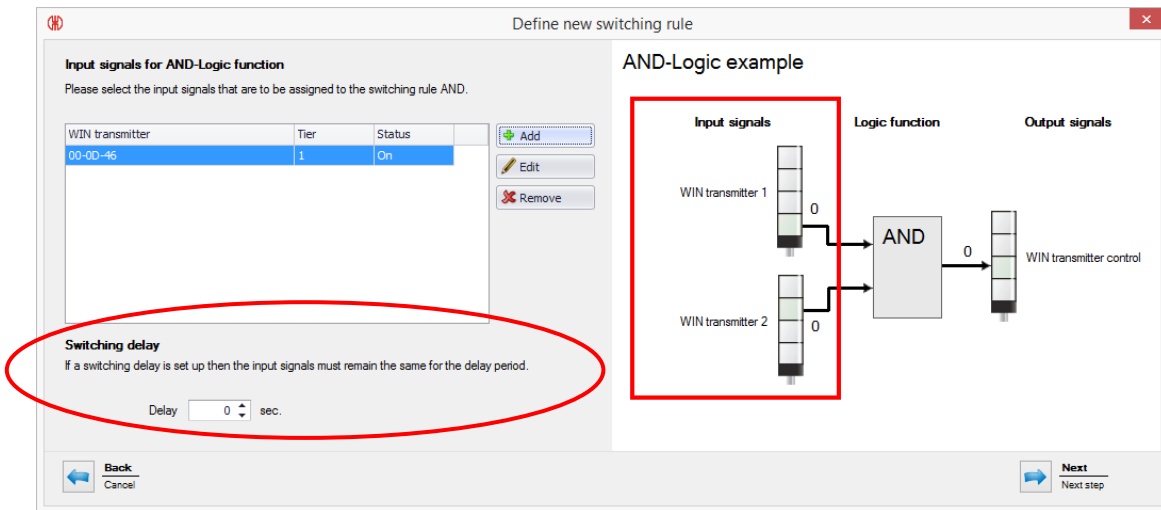

9. Click on "Next" to confirm your selection.

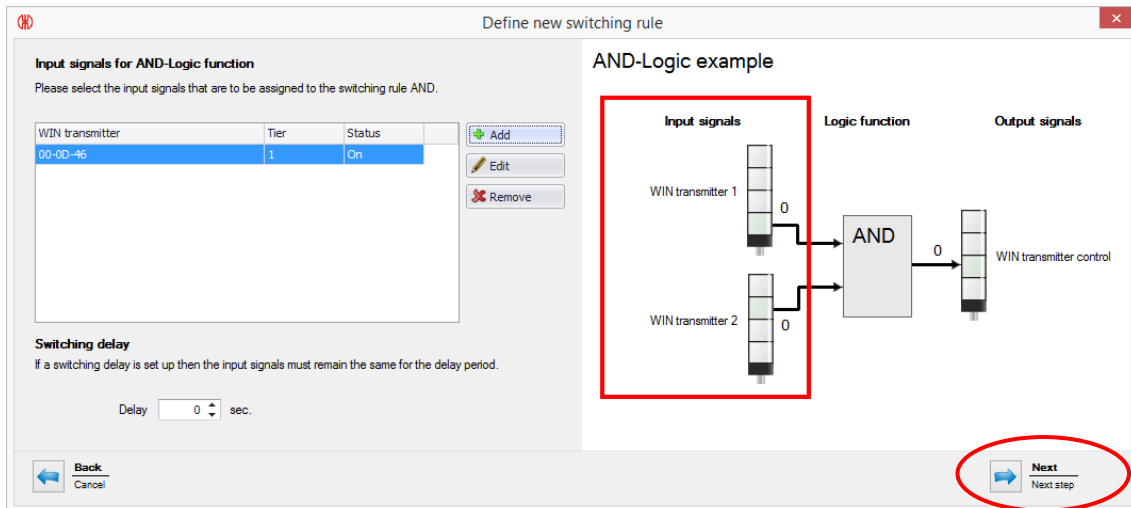

10. The last step of the Logic function is to define the output signal. Click on "Add".

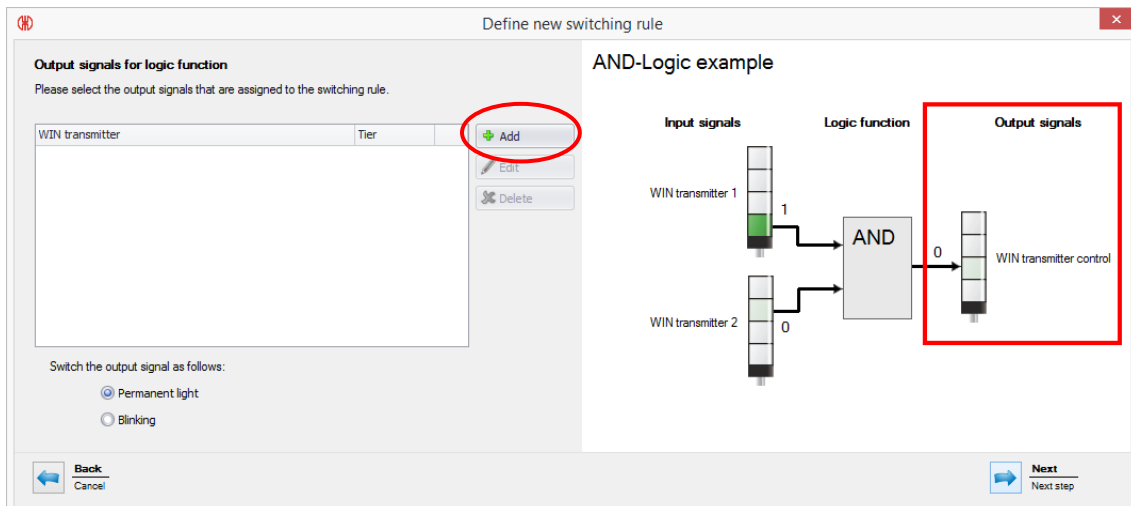

11. Only the tiers of the WIN transmitter control can be used as output signals.

Only those WIN transmitters control connected to the WIN network will be displayed as options for output signals.

Select the tier to be switched.

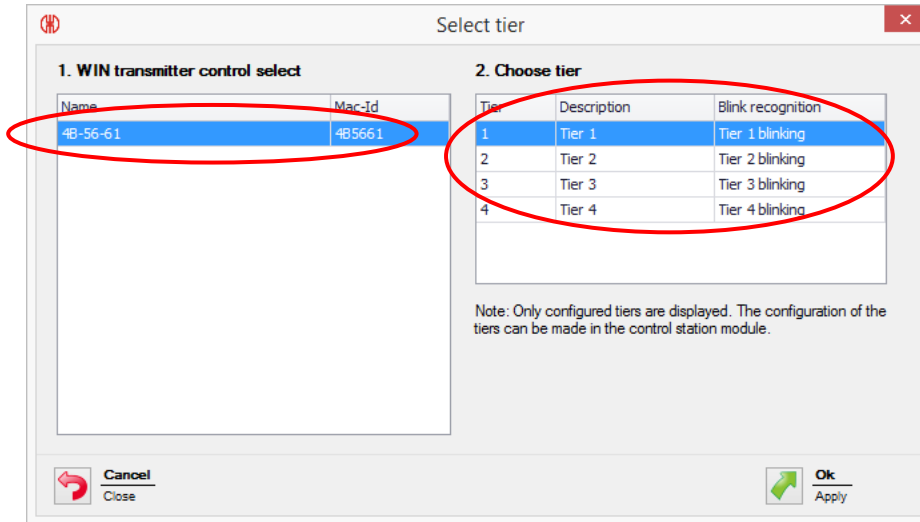

12. Confirm the selection with „Ok“.

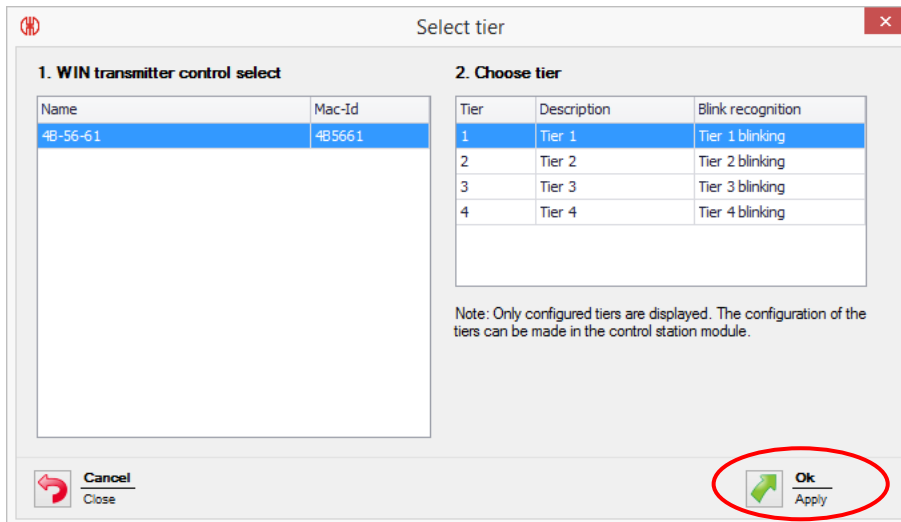

13. To set an additional output signal click on “Add” and repeat steps 11. and 12.

The “Edit” function allows you to modify an output signal which has already been defined.

“Delete” cancels an existing output signal.

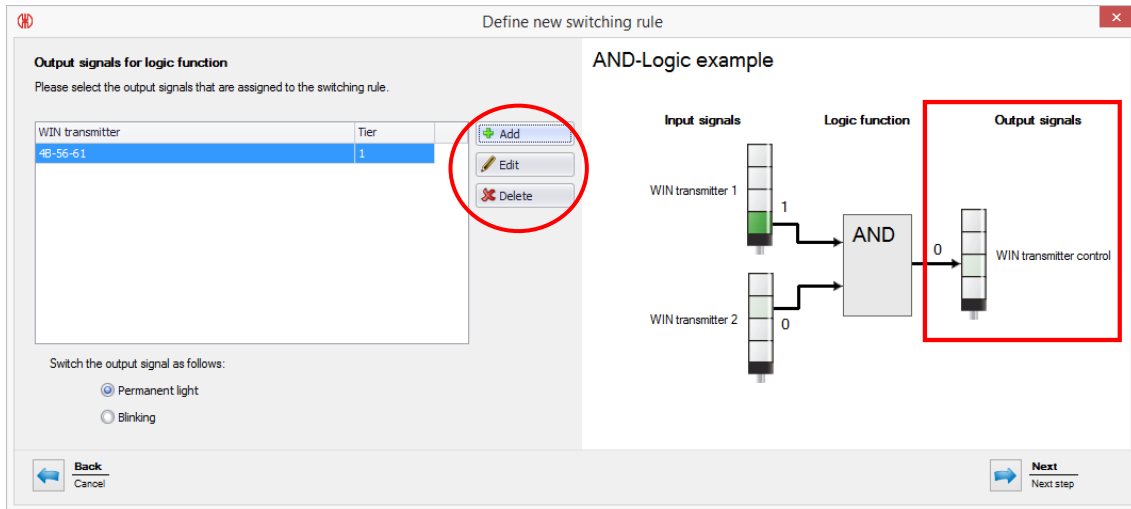

14. Define whether the output signal should be as a “permanent” or “blinking” light.

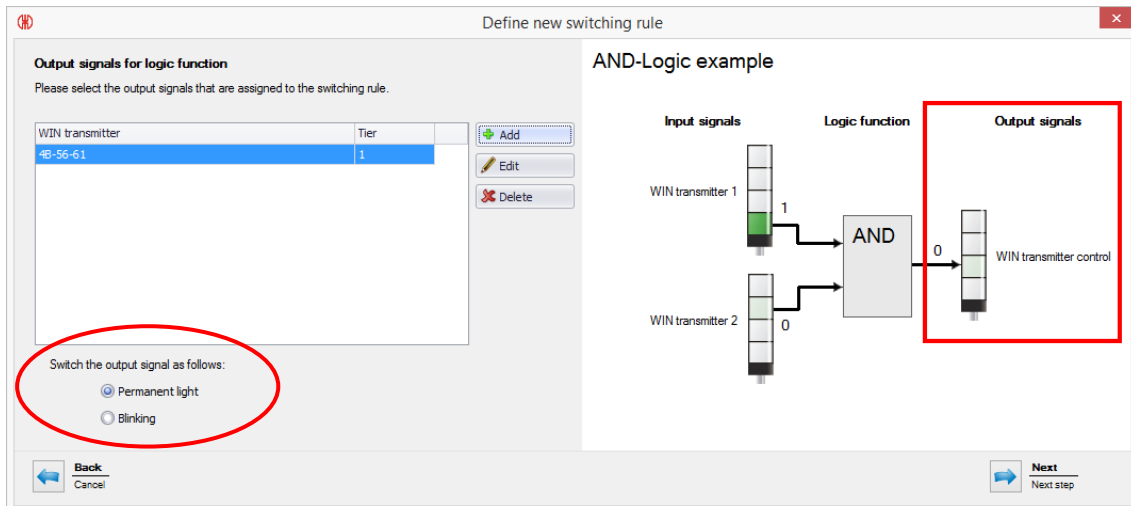

15. Confirm the selection with "Next".

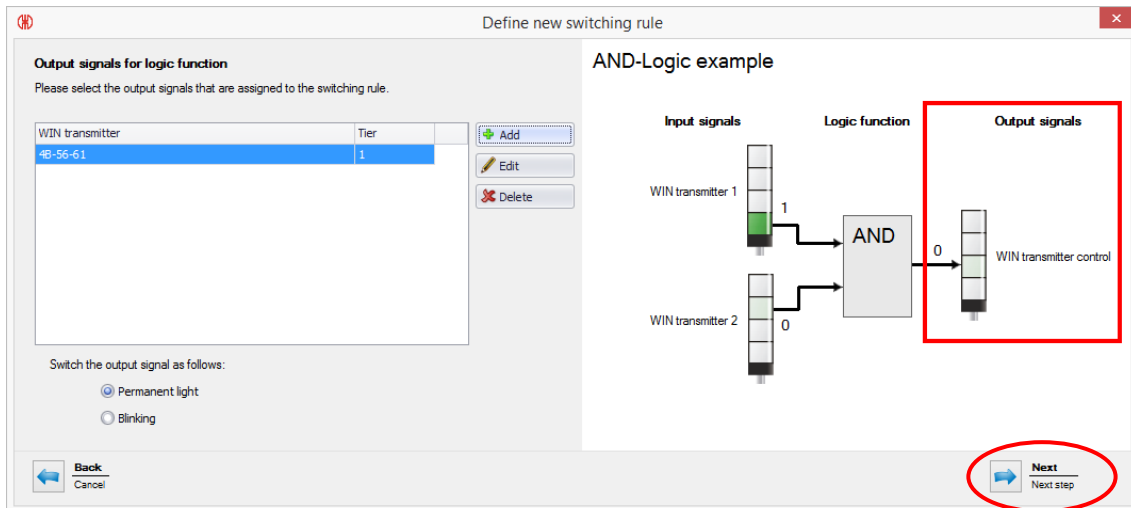

16. Save finally the rule set up with a name you define.

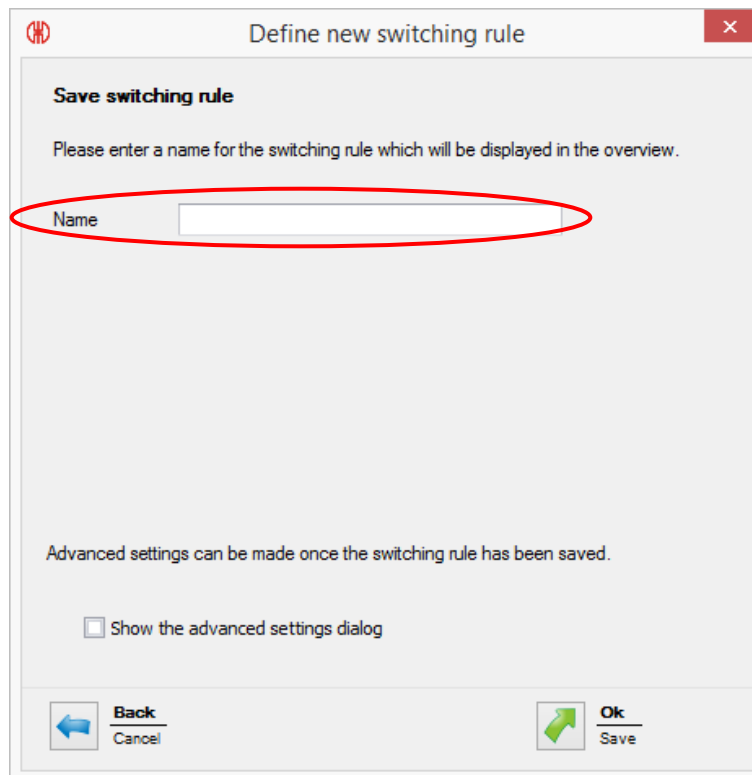

17. In order to make further adjustments to the rule, activate the check box.

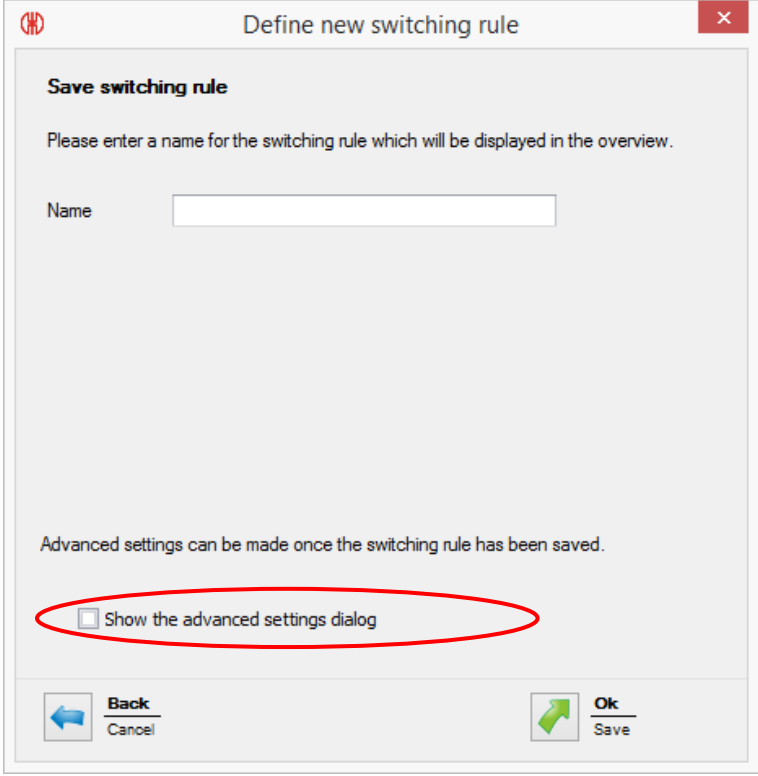

The screenshot shows a dialog box titled "Define new switching rule" with a close button (X) in the top right corner. The main content area is titled "Save switching rule" and contains the instruction "Please enter a name for the switching rule which will be displayed in the overview." Below this is a text input field labeled "Name". Further down, it says "Advanced settings can be made once the switching rule has been saved." At the bottom of the main area, there is a checkbox labeled "Show the advanced settings dialog", which is circled in red. The bottom of the dialog features two buttons: "Back" (with a left arrow icon) and "Cancel", and "Ok" (with a right arrow icon) and "Save".

18. Confirm your selection with „Ok“.

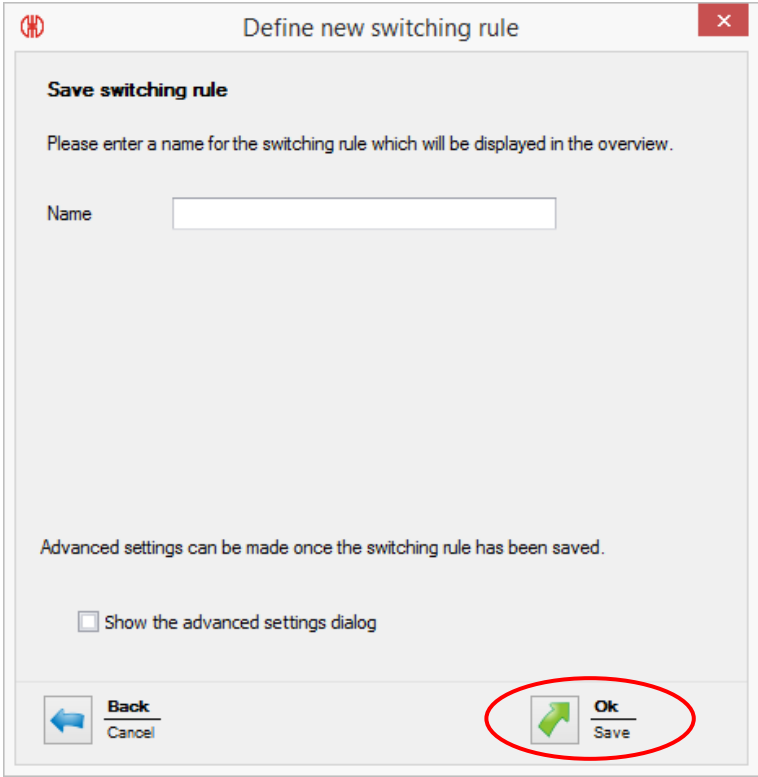

This screenshot is identical to the previous one, showing the "Define new switching rule" dialog box. In this step, the "Show the advanced settings dialog" checkbox is no longer highlighted. Instead, the "Ok" button (with a right arrow icon) and "Save" text are circled in red, indicating the next action to be taken.

7.5.2.2 Defining a new rule in the Expert mode

In order to set up a new rule in the expert mode proceed as follows:

1. Click on "New rule (Expert)".

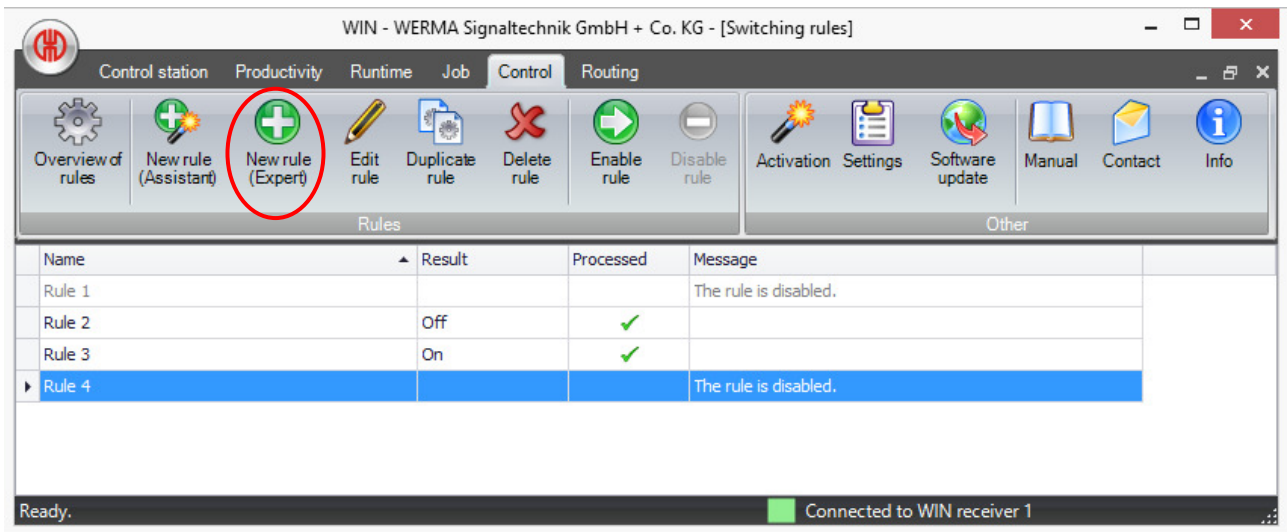

2. A window will open in which you can first define the name of the new rule.

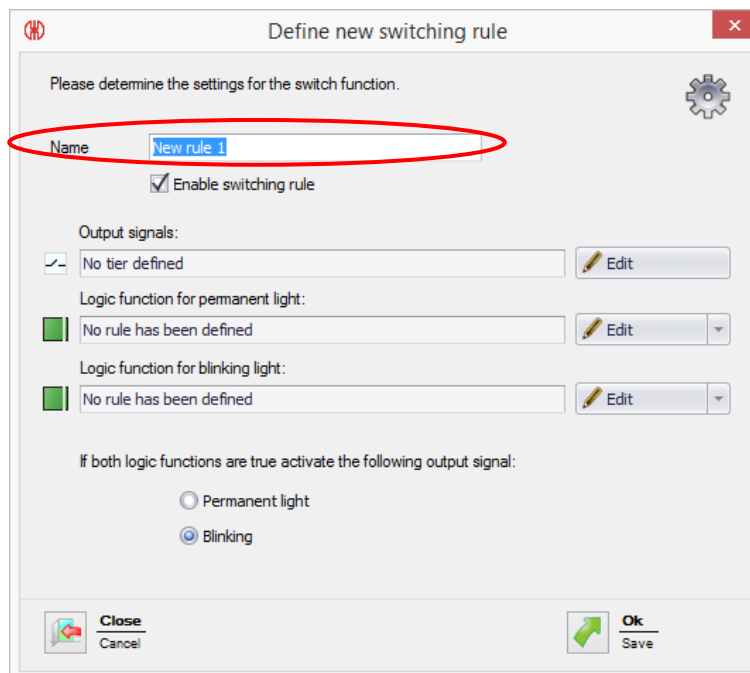

3. Next, define the output signal and click on “Edit”.

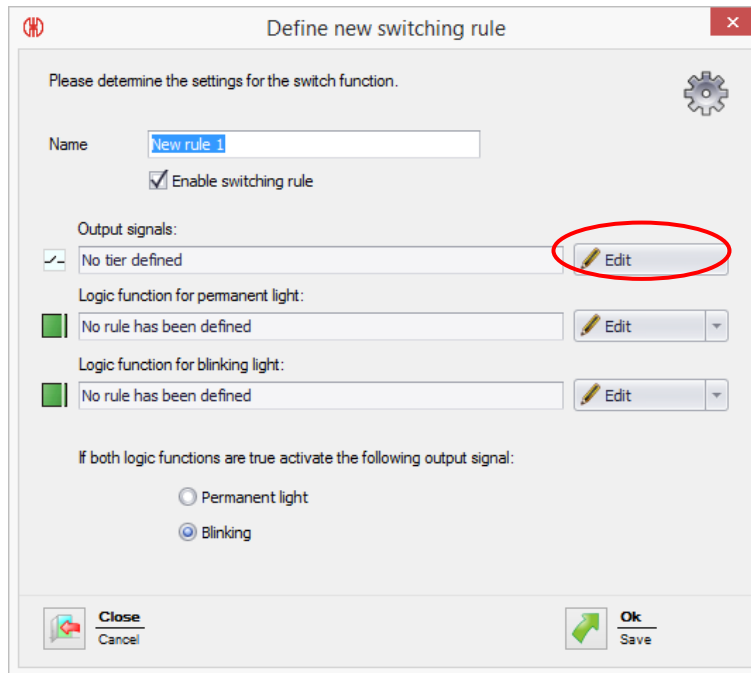

4. To define the output signal click on “Add”.

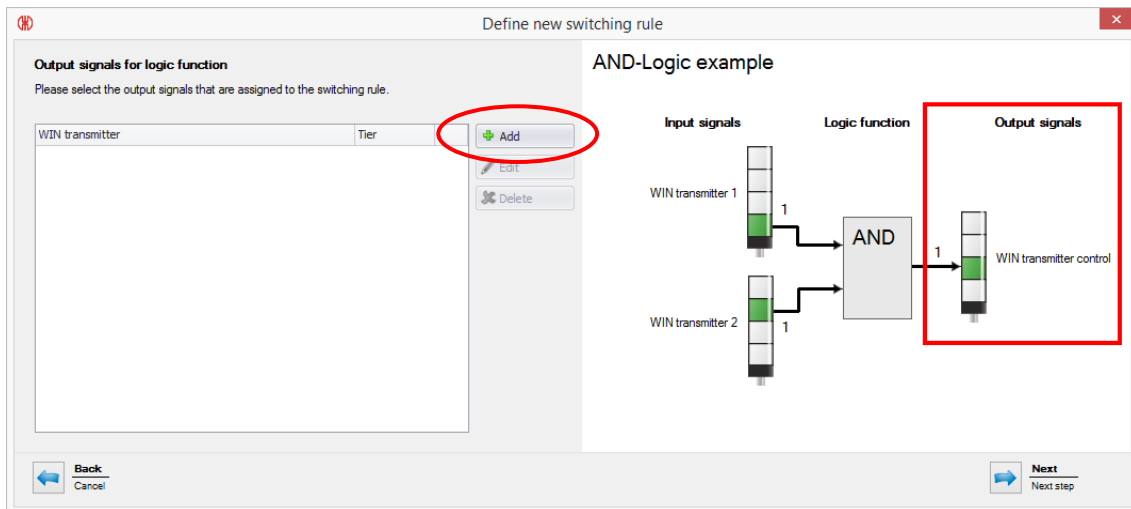

5. Only the tiers of the WIN transmitter control can be used as output signals.
Only those WIN transmitters control connected to the WIN network will be displayed as options for output signals.

Select the tier to be switched.

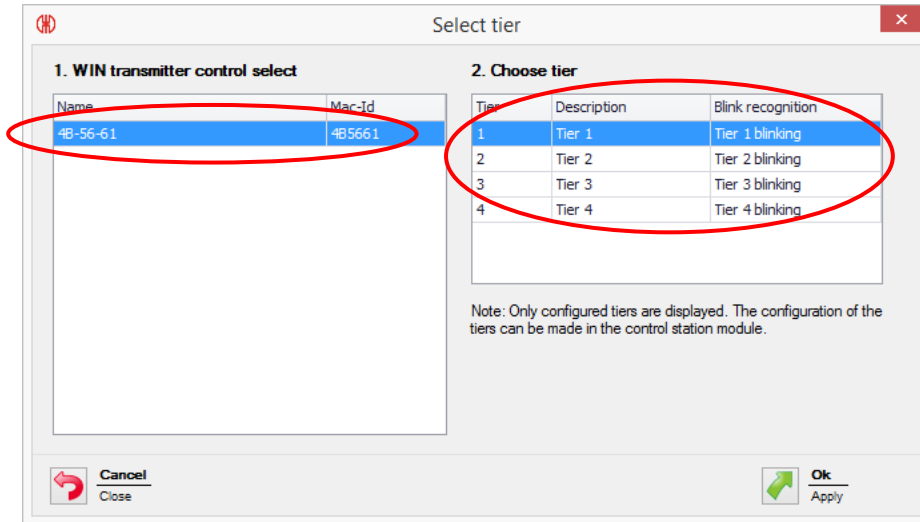

6. Confirm the selection with "Ok".

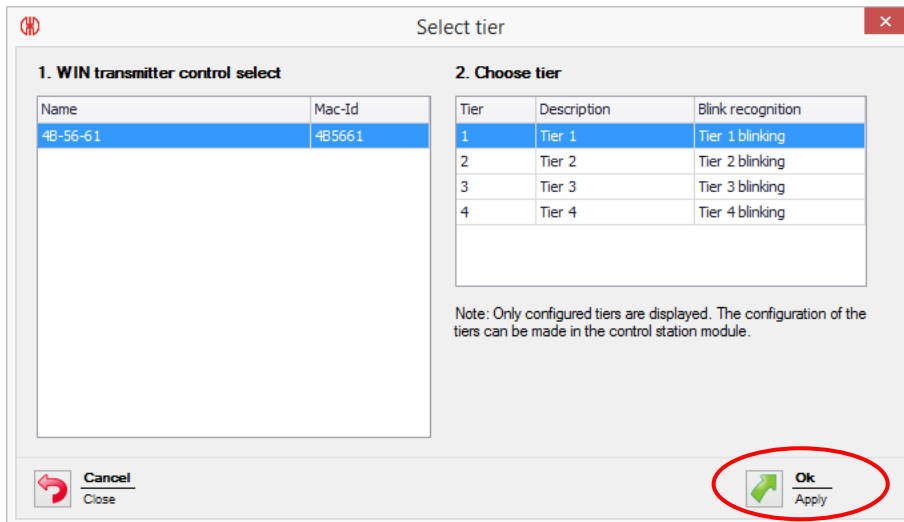

- To set an additional output signal click on "Add" and repeat steps 11. and 12.
The "Edit" function allows you to modify an output signal which has already been defined.
"Delete" cancels an existing output signal.

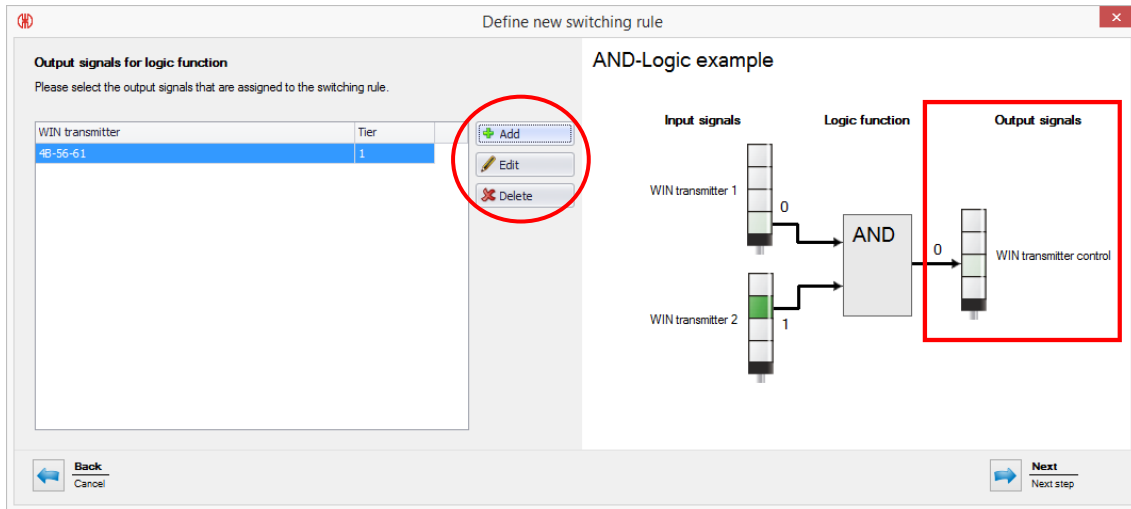

- Click on "Next" to confirm your selection.

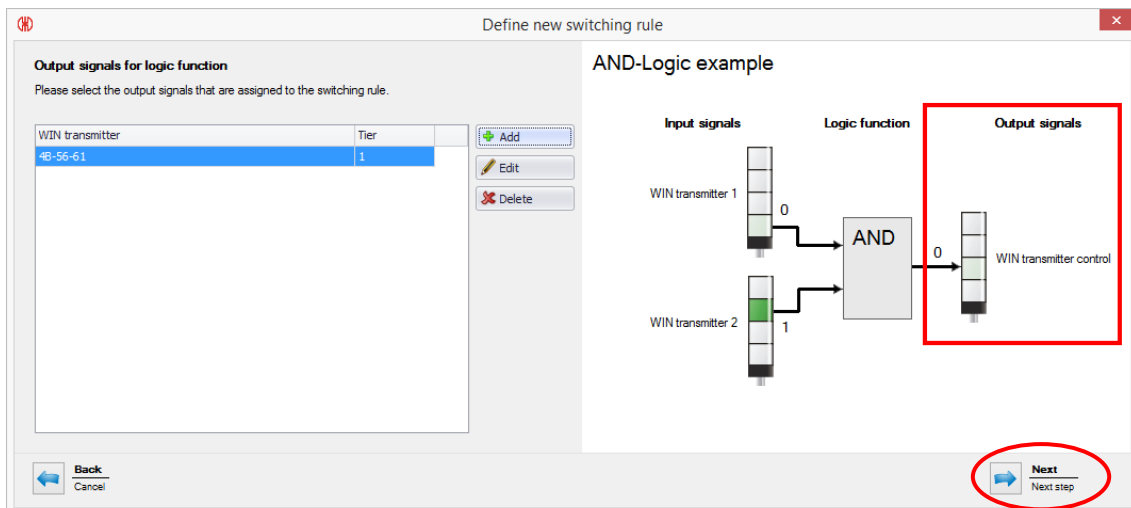

9. Next define the Logic function of the permanent light of the WIN transmitter control by clicking on "Edit".

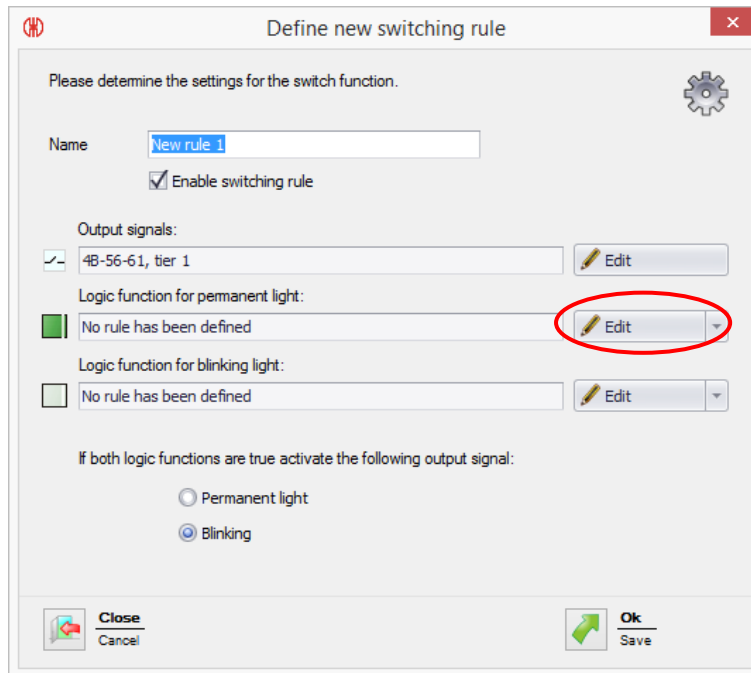

10. Next you will find the switching rule / Logic function with which the input signals should be connected. You can choose between:

- AND – Each tier must be in the selected status
- OR – At least one tier must have the defined status
- NOR – No tier may be in the defined status
- Enter custom logic function (expert mode), see chapter **Fehler! Verweisquelle konnte nicht gefunden werden.**

Click then on "Next".

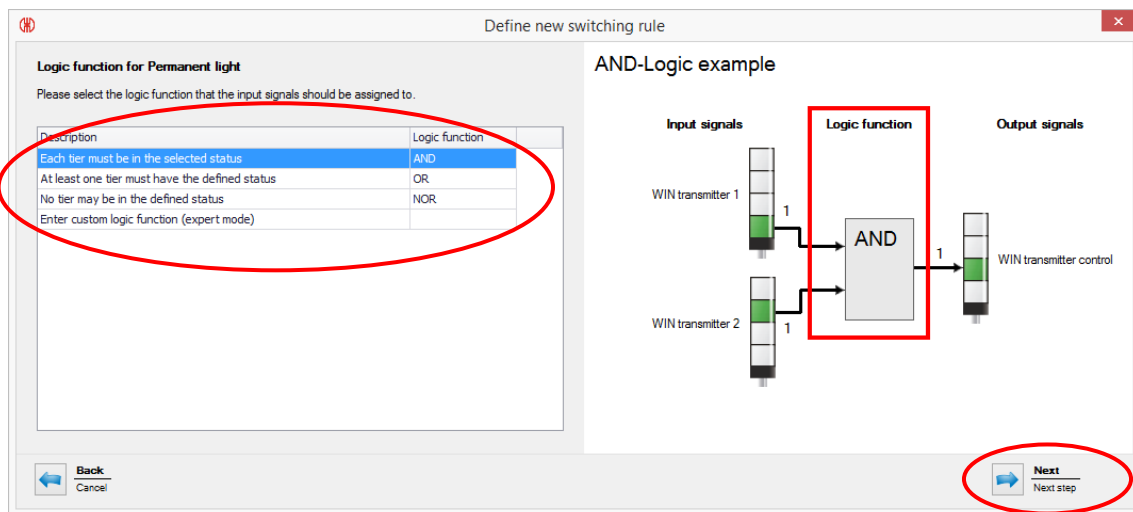

Note: The picture right shows you an example of the selected functions.

11. Next you can select the input signal for the chosen Logic function, click on “Add”.

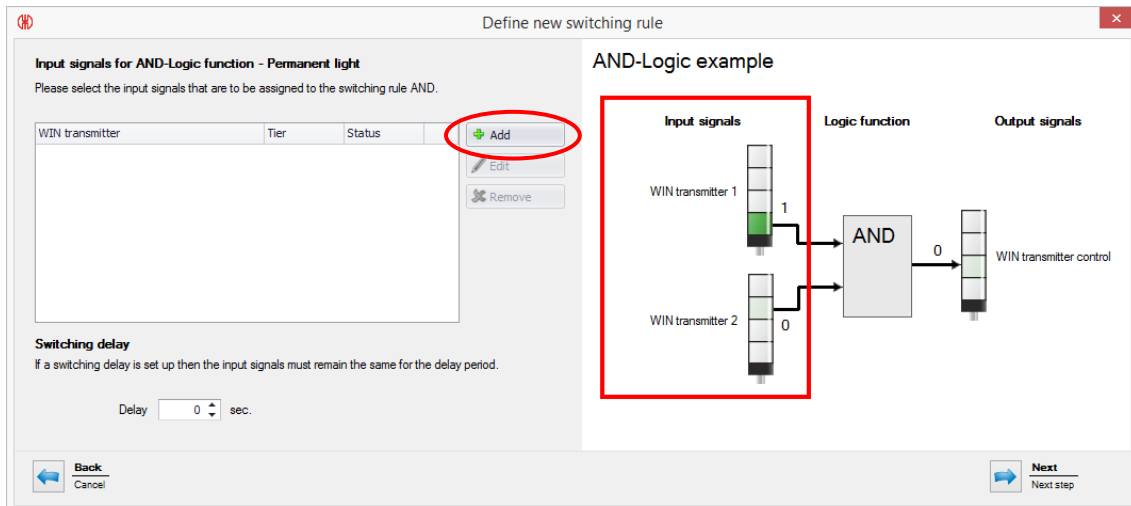

12. In this dialogue box you can select the input signal by tier and status for one of the WIN transmitters connected to the WIN network.

First select a WIN transmitter from the left hand column. Then you will see the tiers displayed as have been defined in the control station view.

Select tier and then the status in which this tier must be for the input signal to apply. You have the choice between “On”, “Off”, “Connection error” and “Blinking”. “Blinking” is displayed only when the “blink recognition” has been activated for this tier.

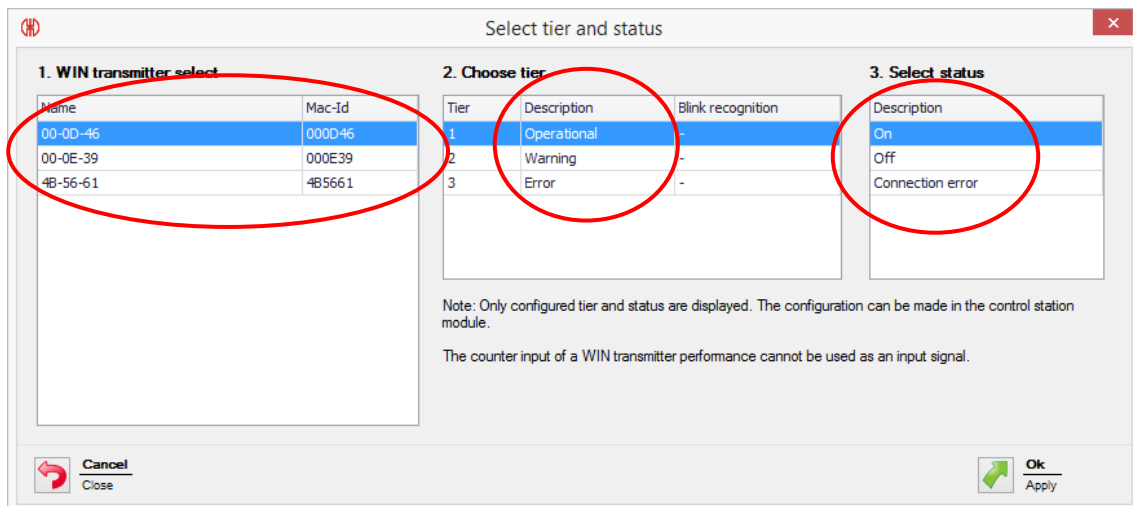

Note: The counter input of a WIN transmitter performance cannot be used as input to a logic function.

13. Confirm with "OK".

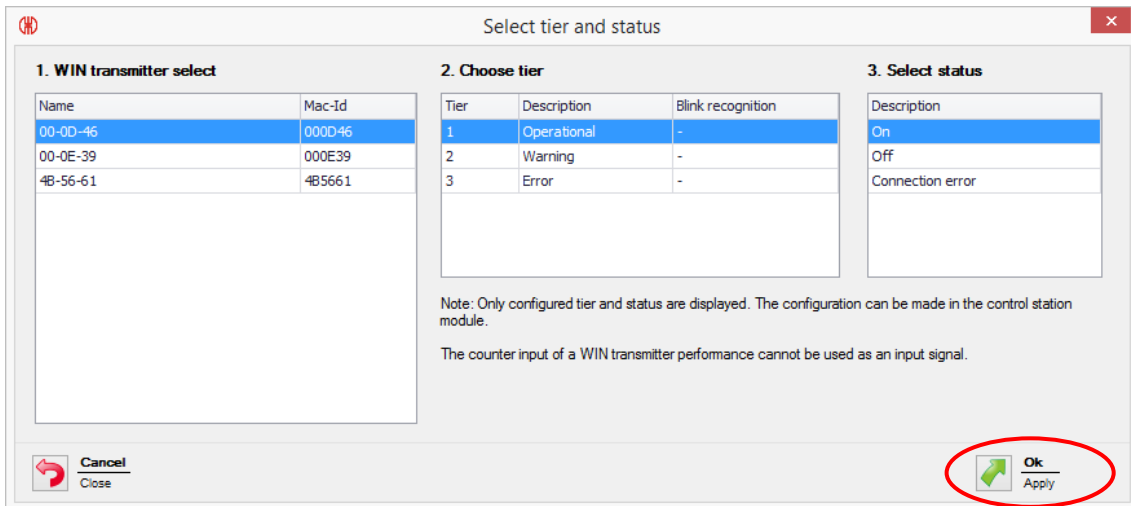

14. To define another input signal click on "Add" and repeat steps 5. and 6.

Click on "Edit" to alter an existing output signal.

Click on "Remove" to remove an output signal.

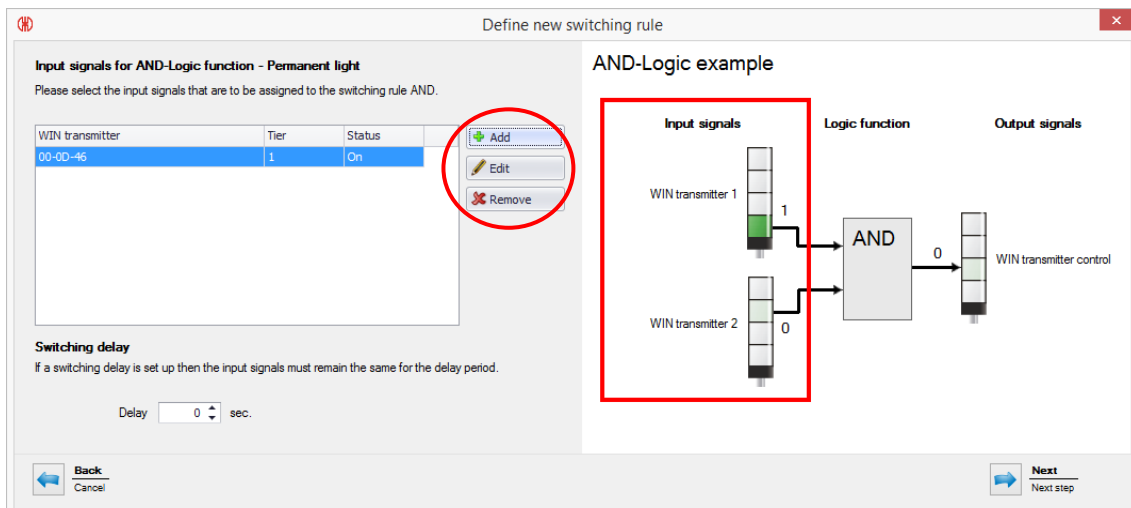

15. For each switching rule you can set a time delay but the input signal status must have been on for at least the same time as the time delay.

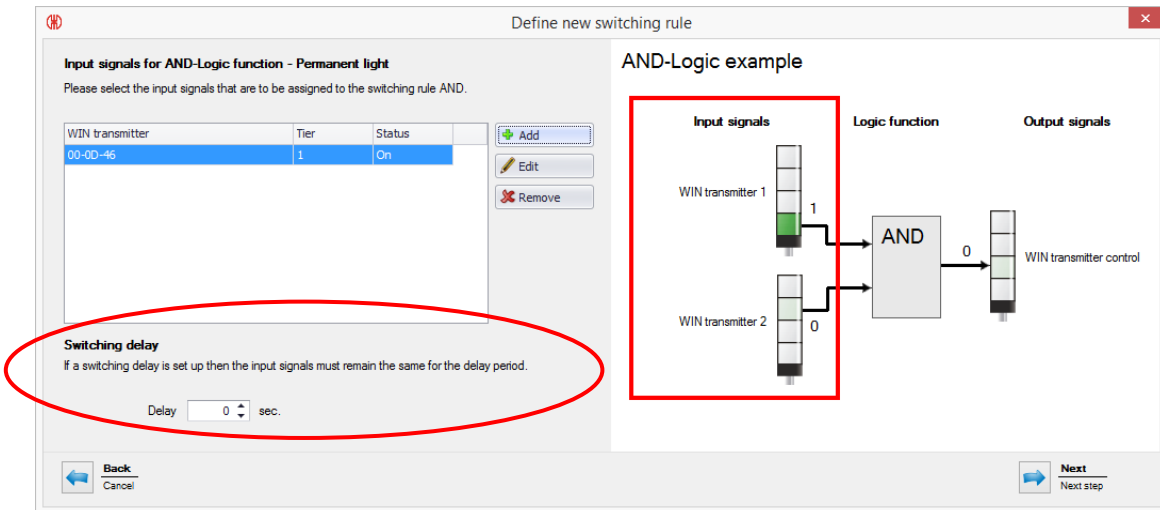

16. Select by clicking on "Next".

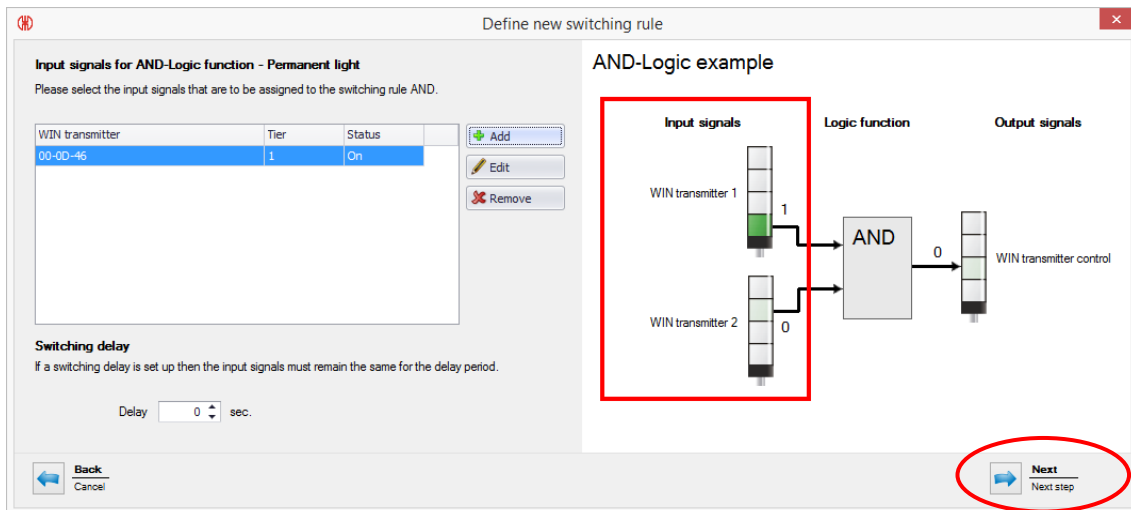

17. Next define the Logic function for the blinking of the WIN transmitter control by clicking on "Edit".

Repeat steps 9. to 15. as for a permanent light.

The screenshot shows a dialog box titled "Define new switching rule". It contains the following elements:

- Name: New rule 1
- Enable switching rule
- Output signals: 4B-56-61, tier 1 (with an Edit button)
- Logic function for permanent light: AND-Logic function with 1 input signals (with an Edit button)
- Logic function for blinking light: No rule has been defined (with an Edit button highlighted by a red circle)
- If both logic functions are true activate the following output signal:
 - Permanent light
 - Blinking
- Buttons: Close/Cancel and Ok/Save

18. Lastly please define which Logic function has the higher priority, which means which function should be switched first if both Logic functions occur at the same time.

This screenshot is identical to the one above, but with a red circle highlighting the "Blinking" radio button in the "If both logic functions are true activate the following output signal:" section.

19. Save the switching rule with "Ok".

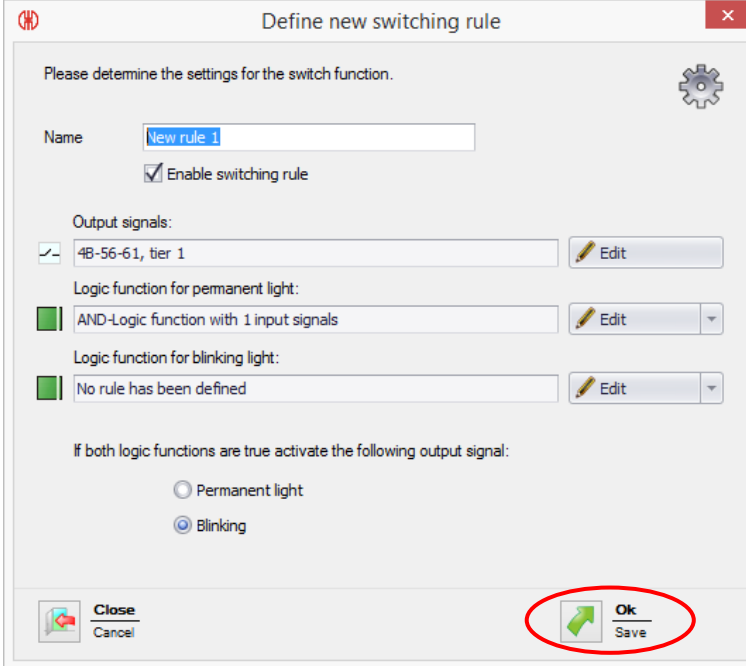

Define new switching rule

Please determine the settings for the switch function.

Name:

Enable switching rule

Output signals:

Logic function for permanent light:

Logic function for blinking light:

If both logic functions are true activate the following output signal:

Permanent light

Blinking

7.5.2.3 Customized Logic function in Expert mode

To input logic functions in expert mode follow these steps:

1. Select "Enter custom logic function (expert mode)" and click on "Next".

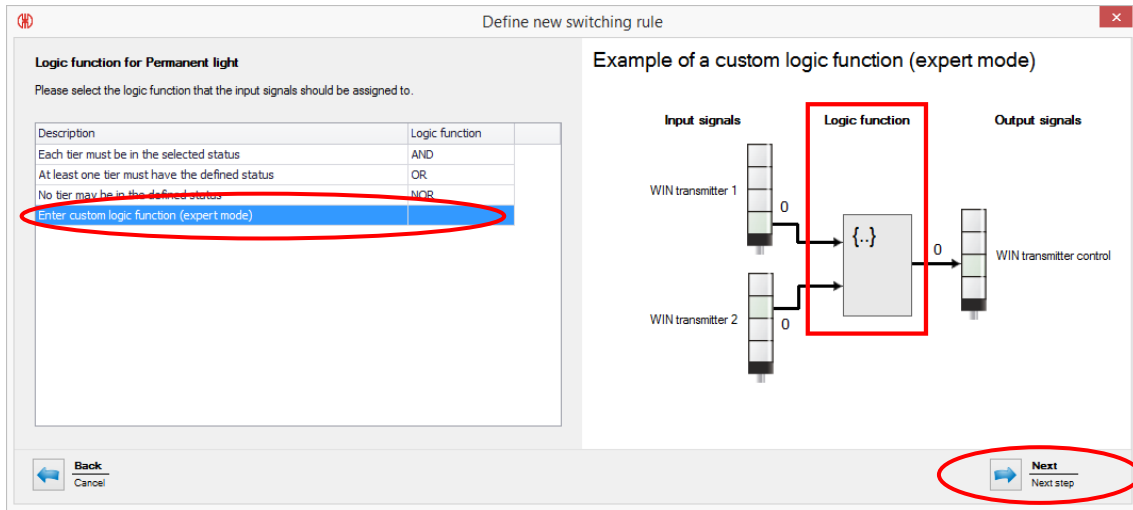

2. Next define your own logic function. The rule will be input as a program code in Visual Basic Syntax. You can make up more complex rules by using the functions "AND", "OR", "NOT" and brackets.

Use either the boxes or input the functions directly as text.

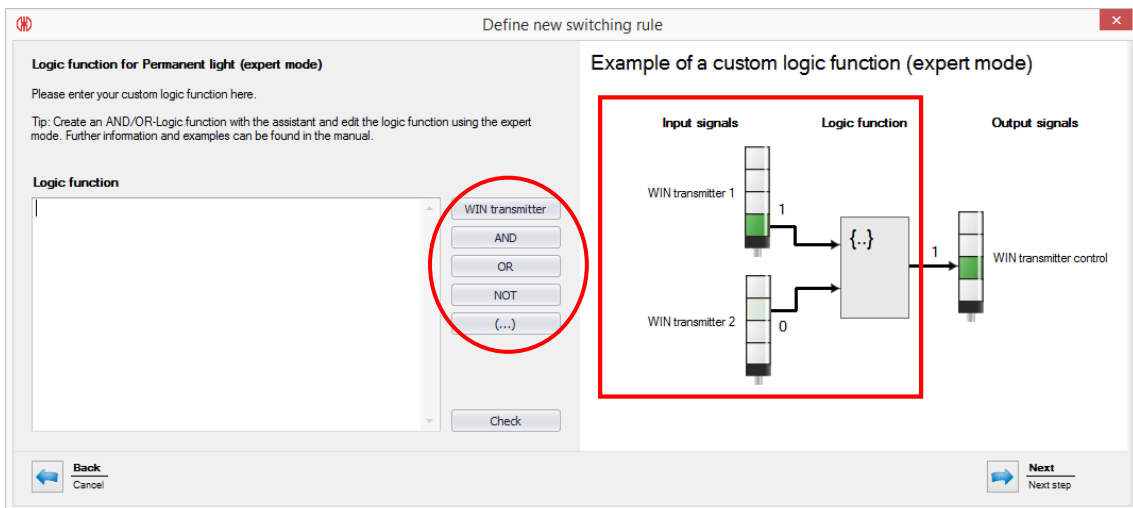

Note: The program code uses the MAC-IDs of the WIN transmitter, not the individual WIN transmitter names.

Note: You can find examples of functions in chapter Fehler! Verweisquelle konnte nicht gefunden werden..

3. Check your custom rule by clicking on “Check”.

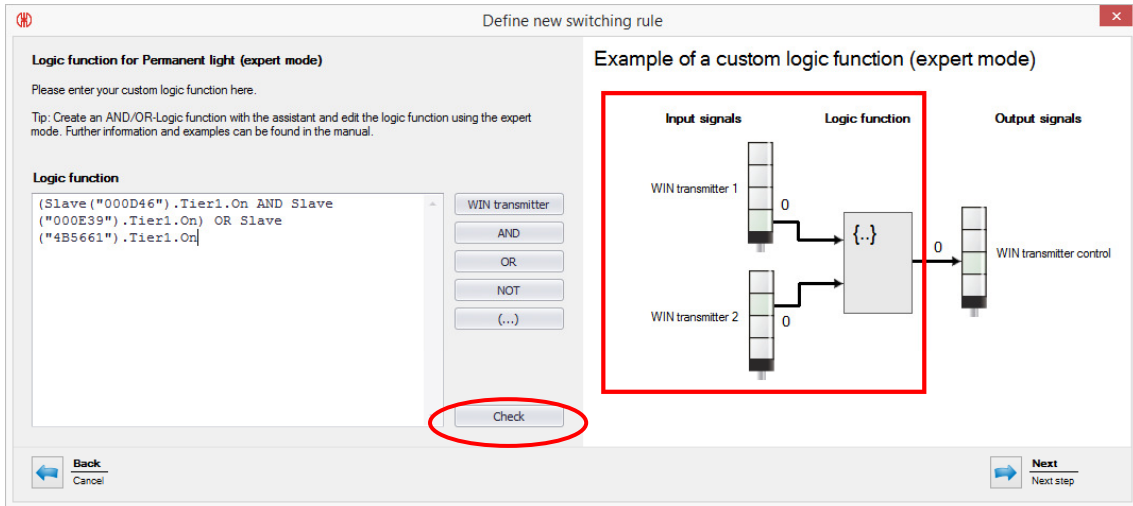

Note: You can scale the window for optimum definition of Logic function.

4. Save the switching rule by clicking on “Next”.

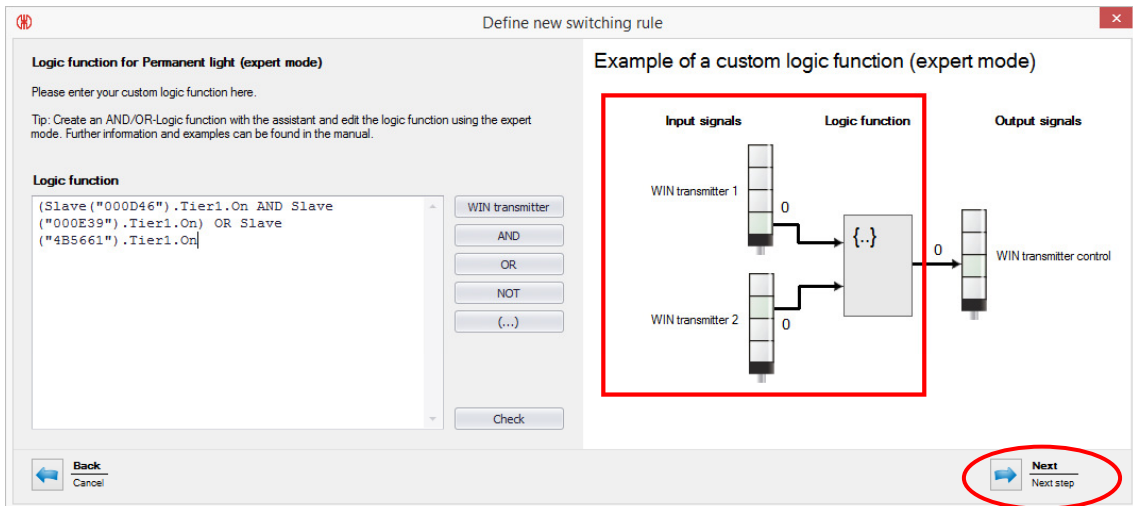

7.5.2.4 Examples of Logic functions in Expert mode

Example 1:

AND-Rule, under which tiers 1 and 2 of a WIN transmitter must be "On":

```
Slave("0024B1").Tier1.On AND Slave("0024B1").Tier2.On
```

Example 2:

OR-Rule, under which tier 1 "Blinks" or tier 2 is "Off".

```
Slave("0024B1").Tier1.Blink OR Slave("0024B1").Tier2.Off
```

Example 3:

NOR-Rule, under which neither of the two transmitters may show a transmission error:

```
NOT (Slave("0024B1").Tier1.Error OR Slave("0024B2").Tier1.Error)
```

Example 4:

Logic function using variables:

Note: You can use program code with Visual Basic Syntax.

```
' declare variables
Dim a As Boolean
Dim b As Boolean
Dim x As Boolean

' read out Slave status and store in variables
a = Slave("0024A1").Tier1.On
b = Slave("0024A2").Tier1.On

' Program code, that processes the variables.
x = a OR b

' Note: If multiple program lines are entered,
' the result of the logic function must be returned
' as Boolean data type with Return.
Return x
```

7.5.3 Edit Rule

1. To edit a rule, select the rule and click on "Edit rule". Alternatively, right-click on a rule and select "Edit".

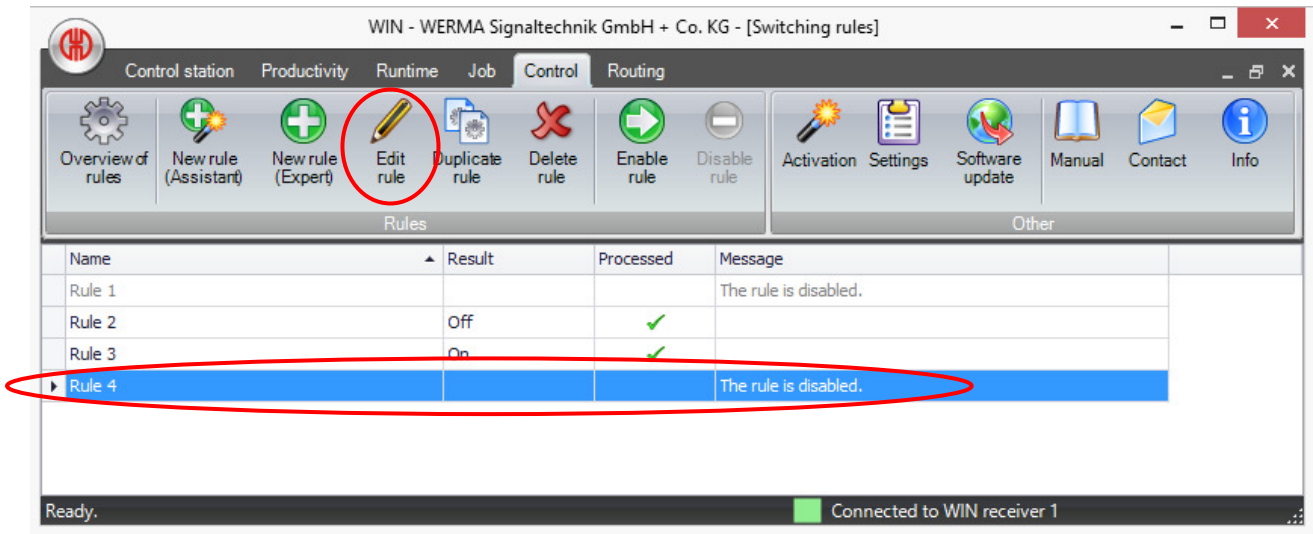

2. You can edit the output signals, input signals and Logic function by following the steps in 7.5.2.2.

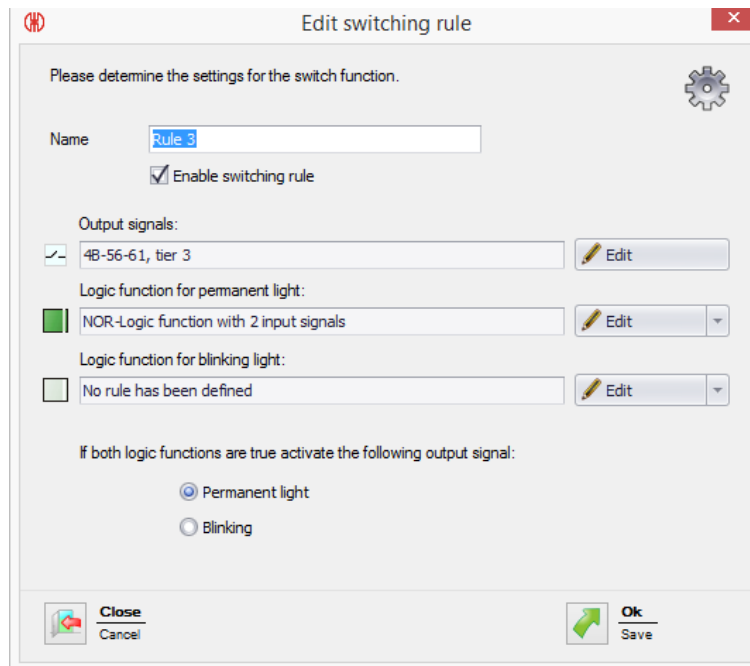

3. Confirm with "Ok".

7.5.4 Duplicate a rule

1. Select the rule and click on "Duplicate rule". Alternatively, right-click on a rule and select "Duplicate rule".

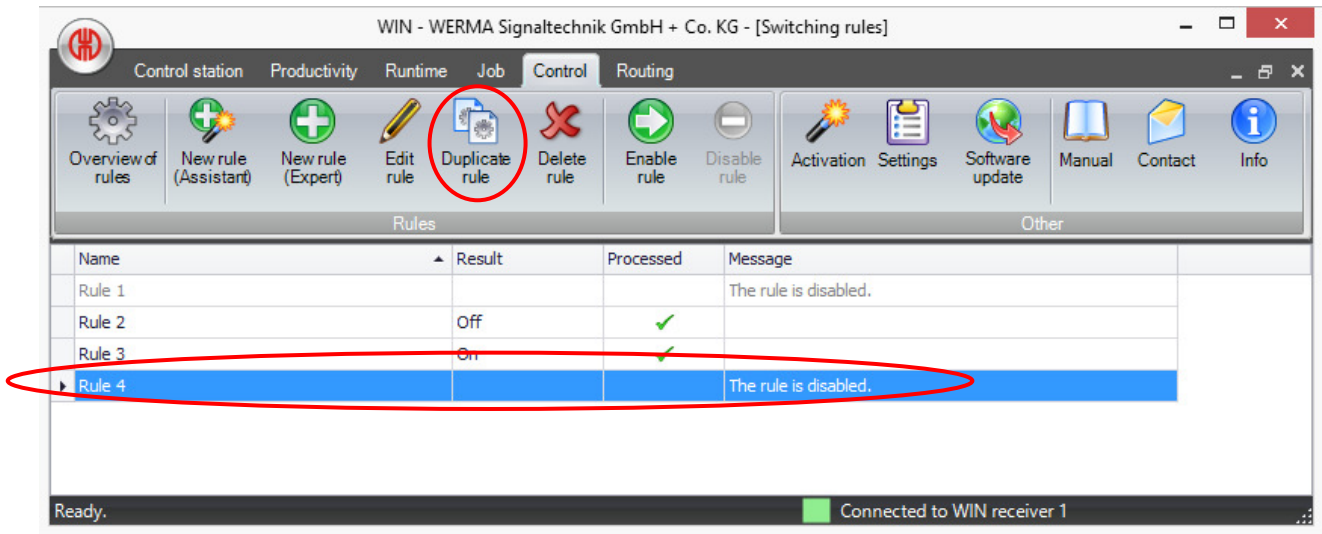

2. To duplicate the rule confirm with "Yes".
3. You can edit the output signals, input signals and Logic function by following the steps in 7.5.2.2.

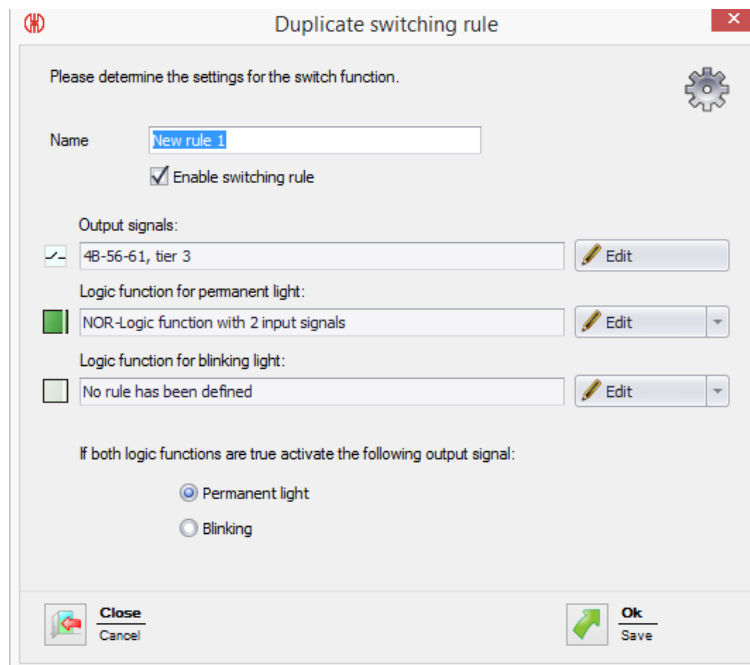

4. Confirm with "Ok".

Note: Should you duplicate a rule it will automatically be shown as a deactivated rule. Only one rule per output signal can be activated.

7.5.5 Delete rule

1. To delete a rule select the rule and click on "Delete rule". Alternatively, right-click on a rule and select "Delete rule".

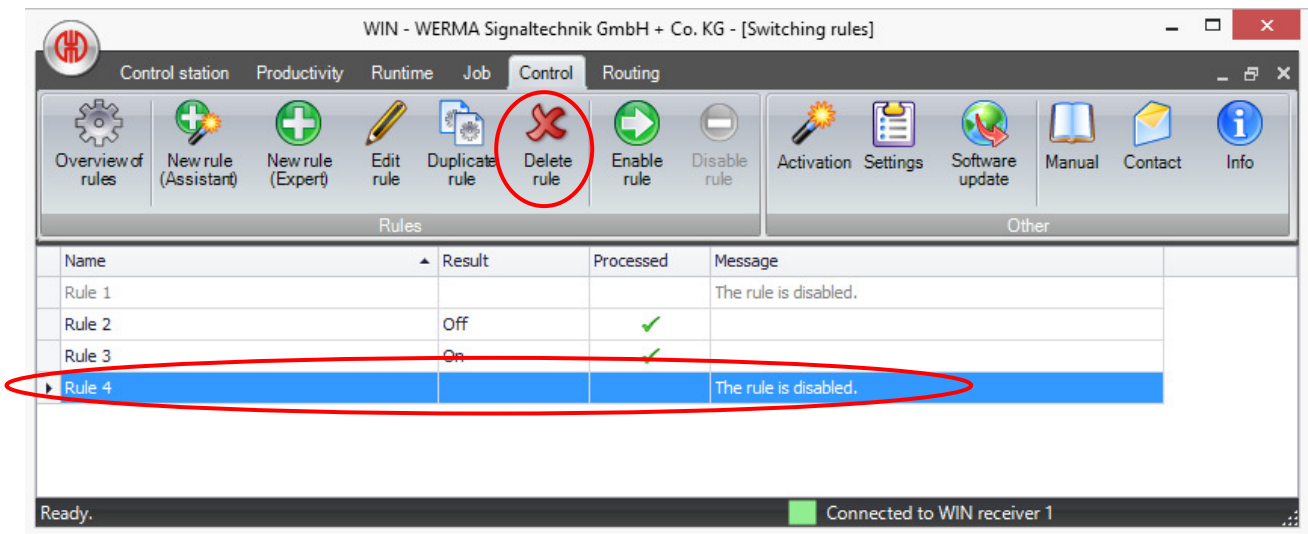

2. To delete the rule confirm with "Yes".

Note: If you delete the switching rule, the WIN transmitter control will remain in the last transmitted status.

7.5.6 Enable a rule

1. To enable a rule you must select a disabled rule and then click on "Enable rule". Alternatively, right-click on a rule and select "Enable rule".

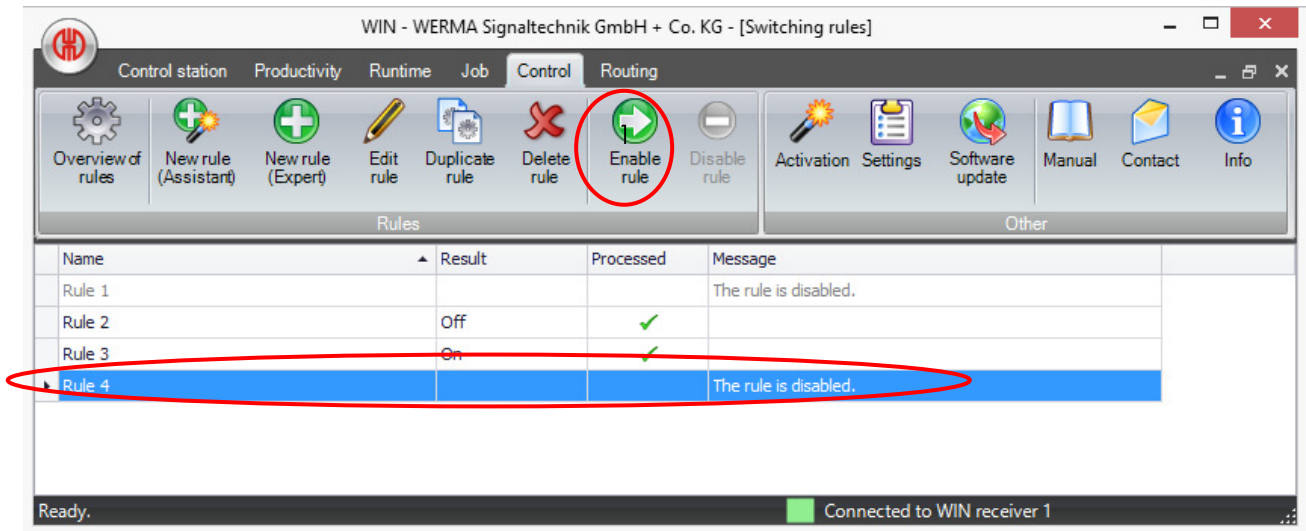

2. To enable the rule confirm with "Yes".

7.5.7 Disable a rule

1. To disable a rule you must select an enabled rule and then click on "Disable rule". Alternatively, right-click on a rule and select "Disable rule".

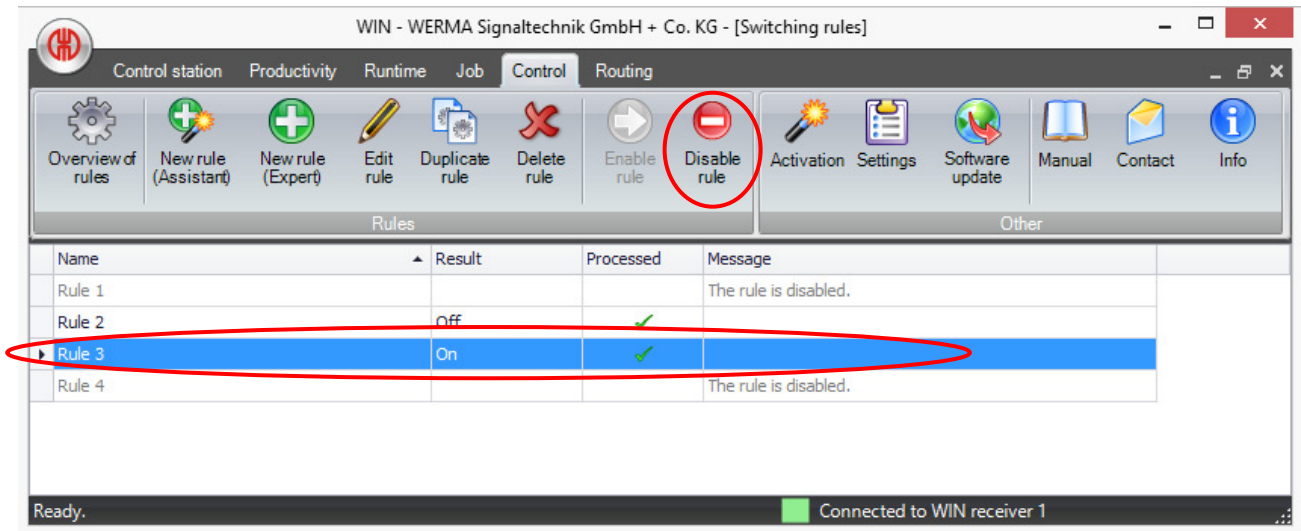

2. To disable the rule confirm with "Yes".

Note: If you disable the switching rule, the WIN transmitter control will remain in the last transmitted status.

7.6 Routing Module

The Routing Module assists in setting up or adjusting the best network for WIN. The network routing graphic shows the current set up of the WIN network and the signal strength of each WIN transmitter. Each WIN transmitter will automatically select the best route back to the WIN receiver either directly, or indirectly.

7.6.1 Wireless communication

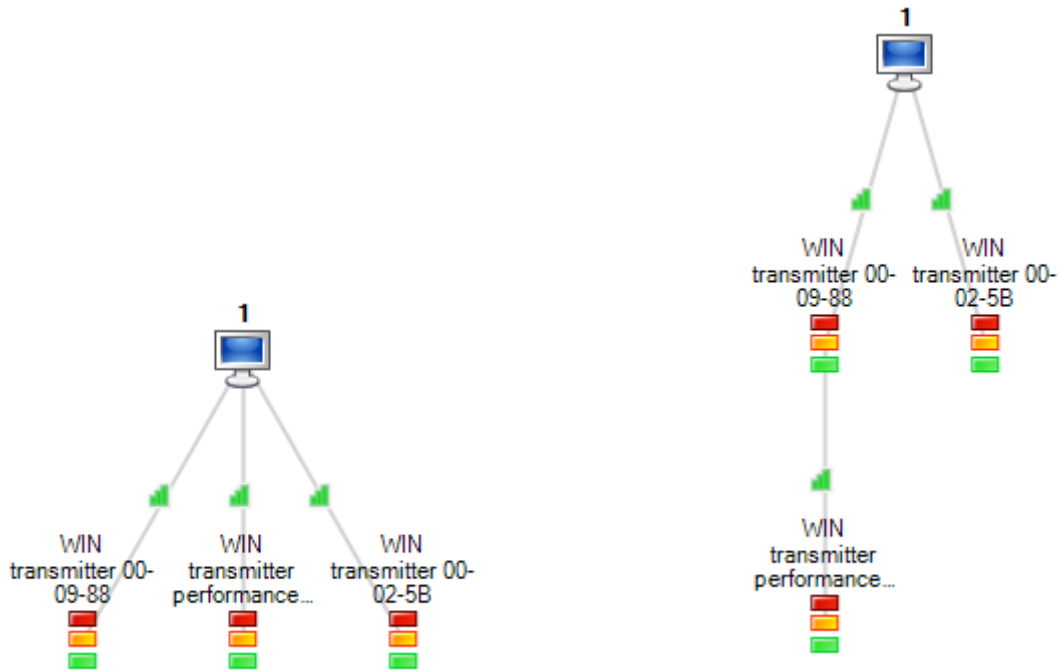

The WIN transmitter may either connect directly to the WIN receiver (left) or via another WIN transmitter, which acts as a "repeater" (right).

This repeater function is activated whenever wireless communication between the WIN transmitter and the WIN receiver can be improved by this function.

Note: A WIN transmitter can be connected to the WIN receiver via a maximum of two WIN transmitters. This will extend the transmission range.

7.6.2 Signal strength

The bar graphs on the connection lines indicate the signal quality. The more bars that are filled in, the better the signal strength.

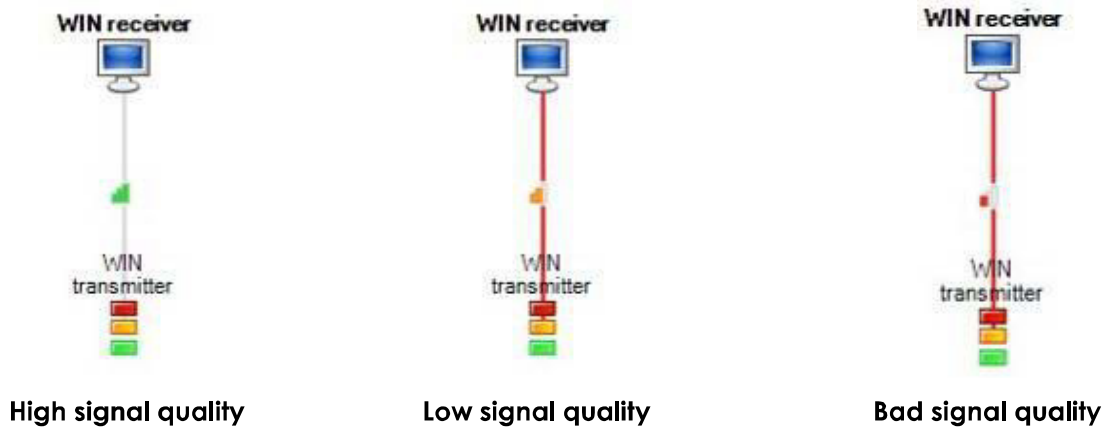

A red connection line indicates poor wireless communication between the stations.

Note: Low signal quality (red lines) may result in connection errors. It is recommended that the wireless communication be optimized (refer to chapter 7.6.3)

7.6.3 Optimizing wireless communication

Wireless communication can be improved by implementing the following measures:

- The stations should be positioned within line of sight.
- Remove metal surfaces between the stations.
- Position the WIN receiver in the best possible way (see chapter 4)
- Poor wireless communication can be improved by means of the "repeater" (WIN transmitter) function.
- System components outside the transmission range can be networked via another WIN receiver (refer to chapter 5.2.4).

7.7 Reporting and Data Export function

Reporting and Data Export functions are available in the following modules:

- Control Station Module
- Productivity Module
- Runtime Module
- Job Module

Details of how to generate a report in individual modules are given in the relevant module chapters (7.1 to 7.4)

After selection of data for the report, a preview is generated.

Runtime - machine statuses
Time period from 22.04.2014 23:29:38 to 24.04.2014 09:42:46
00-02-24

Machine	Start	End	Duration (Sec.)	Tier 1	Tier 2	Tier 3	Tier 4
00-02-24	22.04.2014 23:29:38*	23.04.2014 07:33:33	29.035	Operational			
00-02-24	23.04.2014 07:33:33	23.04.2014 07:33:36	3	Operational		Error	
00-02-24	23.04.2014 07:33:36	23.04.2014 07:34:52	76			Error	
00-02-24	23.04.2014 07:34:52	23.04.2014 07:34:55	3		Warning	Error	
00-02-24	23.04.2014 07:34:55	23.04.2014 07:40:46	351		Warning		
00-02-24	23.04.2014 07:40:46	23.04.2014 07:40:48	2	No data received			
00-02-24	23.04.2014 07:40:48	23.04.2014 07:40:58	10		Warning		
00-02-24	23.04.2014 07:40:58	23.04.2014 07:41:01	3	No data received			
00-02-24	23.04.2014 07:41:01	23.04.2014 07:41:08	7		Warning		
00-02-24	23.04.2014 07:41:08	23.04.2014 07:41:14	6	No data received			
00-02-24	23.04.2014 07:41:14	23.04.2014 08:05:22	1.448		Warning		
00-02-24	23.04.2014 08:05:22	23.04.2014 08:05:26	4				
00-02-24	23.04.2014 08:05:26	23.04.2014 08:12:32	427				
00-02-24	23.04.2014 08:12:32	23.04.2014 08:12:41	9	Operational			
00-02-24	23.04.2014 08:12:41	23.04.2014 08:50:58	2.297	Operational			
00-02-24	23.04.2014 08:50:58	23.04.2014 08:51:01	3				
00-02-24	23.04.2014 08:51:01	23.04.2014 09:01:53	652			Error	
00-02-24	23.04.2014 09:01:53	23.04.2014 09:01:56	3		Warning	Error	
00-02-24	23.04.2014 09:01:56	23.04.2014 14:40:35	20.319		Warning		
00-02-24	23.04.2014 14:40:35	23.04.2014 14:48:47	492	No data received			
00-02-24	23.04.2014 14:48:47	23.04.2014 17:07:14	8.307		Warning		
00-02-24	23.04.2014 17:07:14	23.04.2014 17:07:48	34	No data received			
00-02-24	23.04.2014 17:07:48	23.04.2014 17:08:11	23		Warning		
00-02-24	23.04.2014 17:08:11	23.04.2014 17:08:14	3	Operational	Warning		

* Start or End is outside the evaluated time period

Dienstag, 1. Juli 2014 WIN - Wireless Information Network Page 1 of 2

7.7.1 Print

In the "Print Menu" you can select two different printing options.

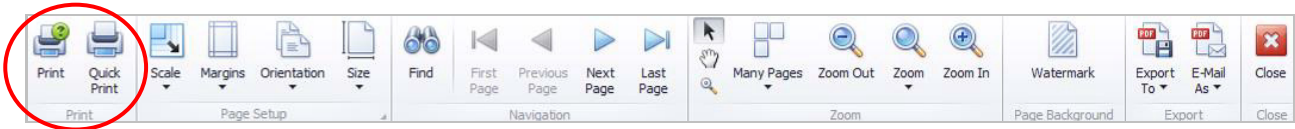

7.7.1.1 Print

Click on "Print" to select a printer, set up print settings, number of copies and further print preferences.

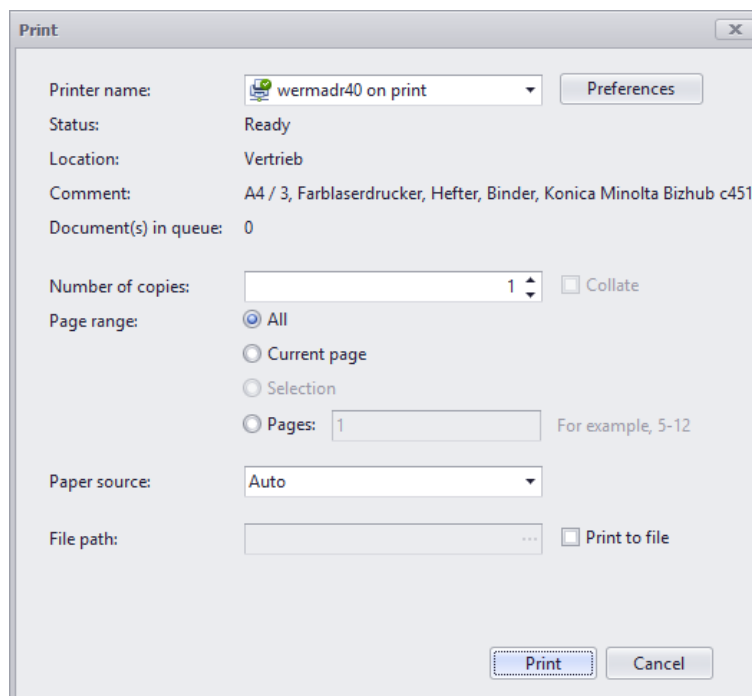
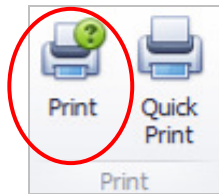

7.7.1.2 Quick Print

Click on "Quick Print" to print using the default printer settings.

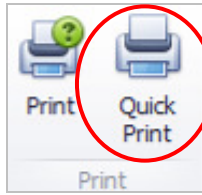

7.7.2 Page Setup

The "Page Setup Menu" allow you to alter the formatting of the report on the page.



7.7.2.1 Scale

Click on "Scale" to increase or decrease the percentage of original size of the report or to fit to a fixed number of page widths.

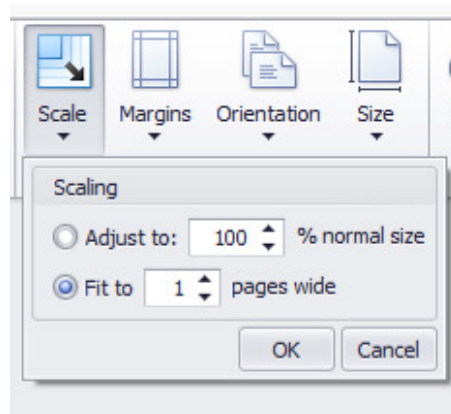
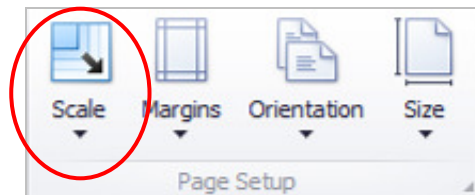

7.7.2.2 Margins

Click on "Margins" to open up a dialogue box to select preset or custom margins for your report.

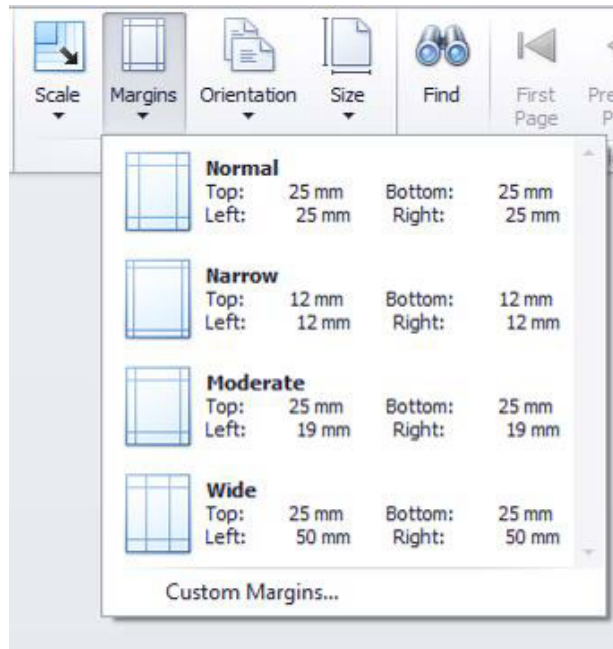
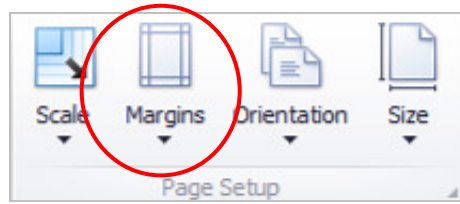

7.7.2.3 Orientation

Click on "Orientation" to switch between Portrait and Landscape formats.

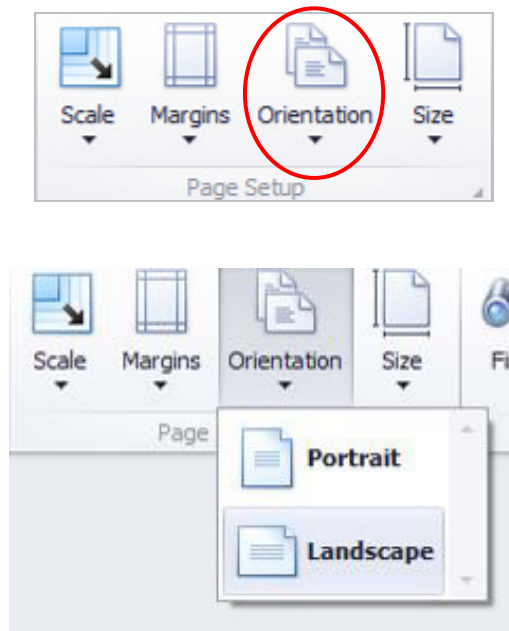

7.7.2.4 Size

Click on "Size" to select the desired paper size.

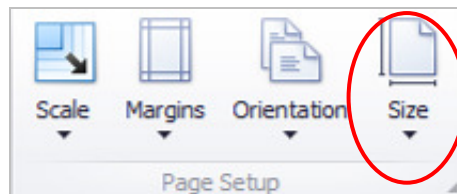

Note: All reports are optimized for size A4.

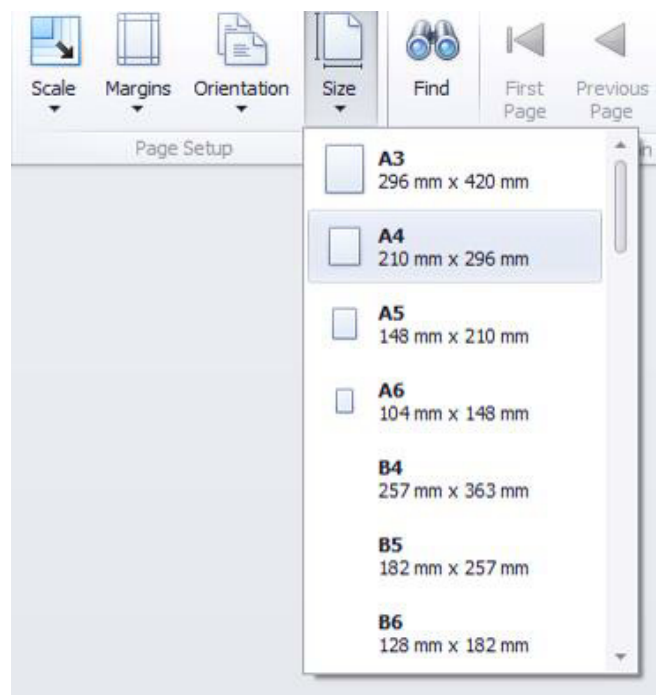

7.7.3 Navigation

The “Navigation Menu” allow you to search the report or move from page to page.

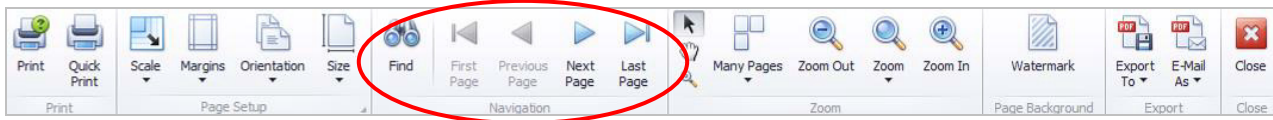

7.7.3.1 Find

Click on “Find” to open the dialogue box. Enter the text to be searched for and any additional criteria.

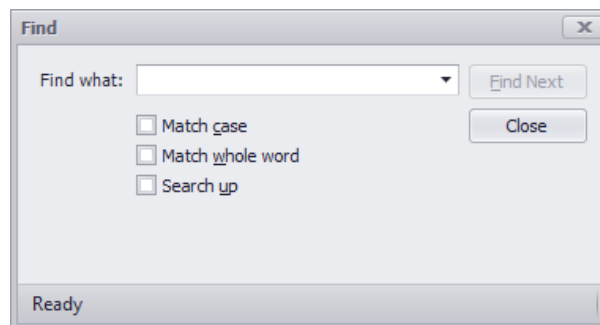
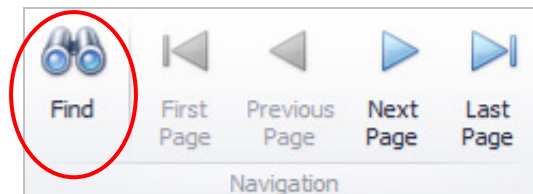

7.7.3.2 Navigation

Use the “Arrow Buttons” to move around the report; you can select First Page, Last Page, Previous Page or Next Page.

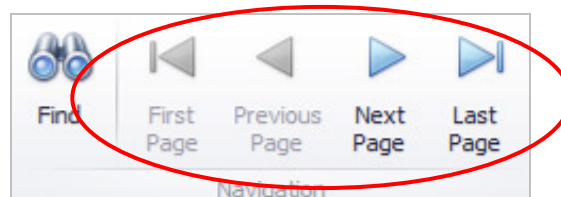

7.7.4 Zoom

The “Zoom Menu” gives you tools to scale the document to get a better overview.

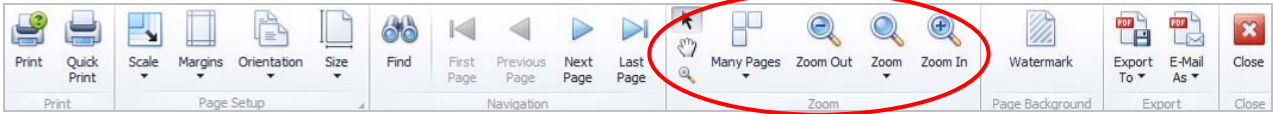

7.7.4.1 Cursor

Displays the “Cursor”.

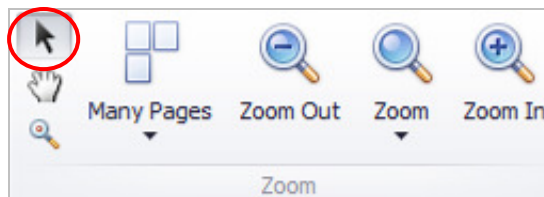

7.7.4.2 Hand

Uses the “Hand” to click and drag the page.

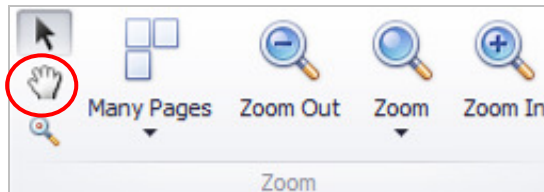

7.7.4.3 Magnifying Glass

Click on the report to zoom in. Clicking again will zoom out.

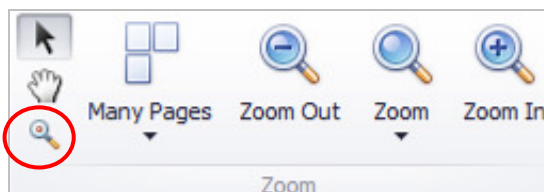

7.7.4.4 Many Pages

Selects the layout in which the Print Preview will be displayed.

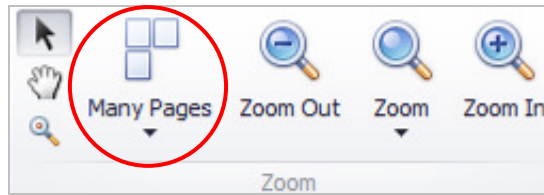

The dialogue box allows you to select the number of pages to be displayed.

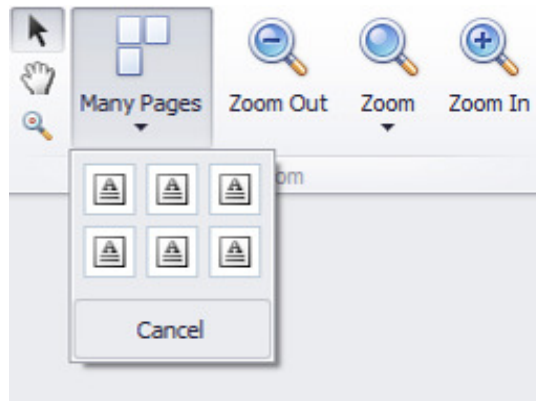

7.7.4.5 Zoom Out

Zooms out to the next size level.

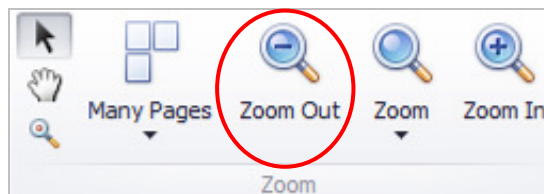

7.7.4.6 Zoom

Click to select preset or custom levels of Zoom.

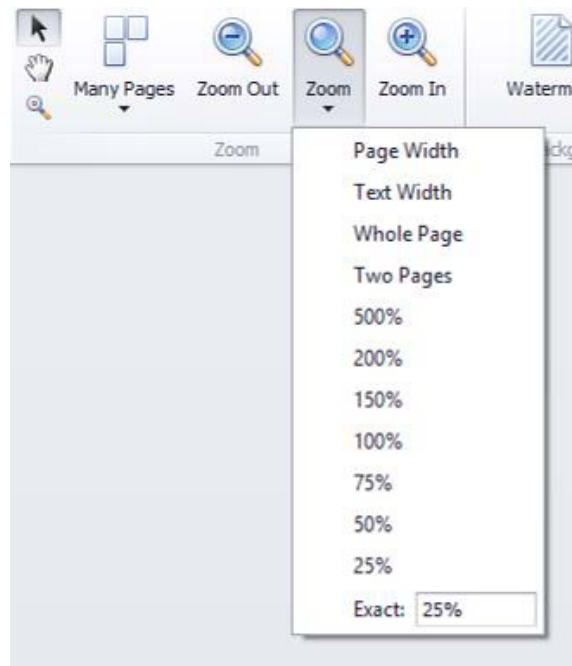
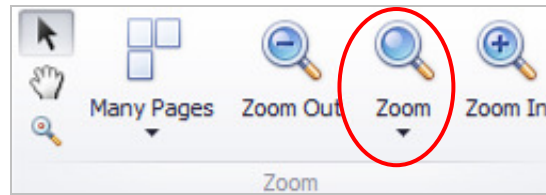

7.7.4.7 Zoom In

Zoom in to the next size level.

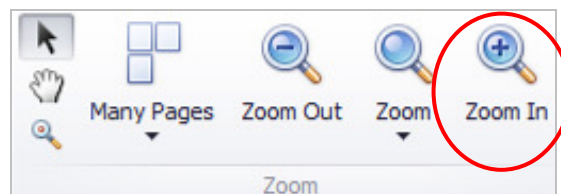

7.7.5 Watermark

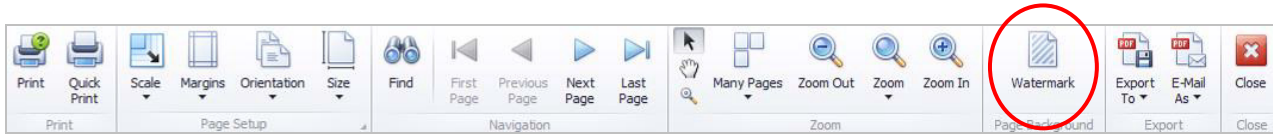

Click on “Watermark” to open the settings dialogue.

In the “Text Watermark tab”, you can add your text or select a predefined text. You can also define additional options, such as Direction, Colour, Font, Size, Transparency, etc.

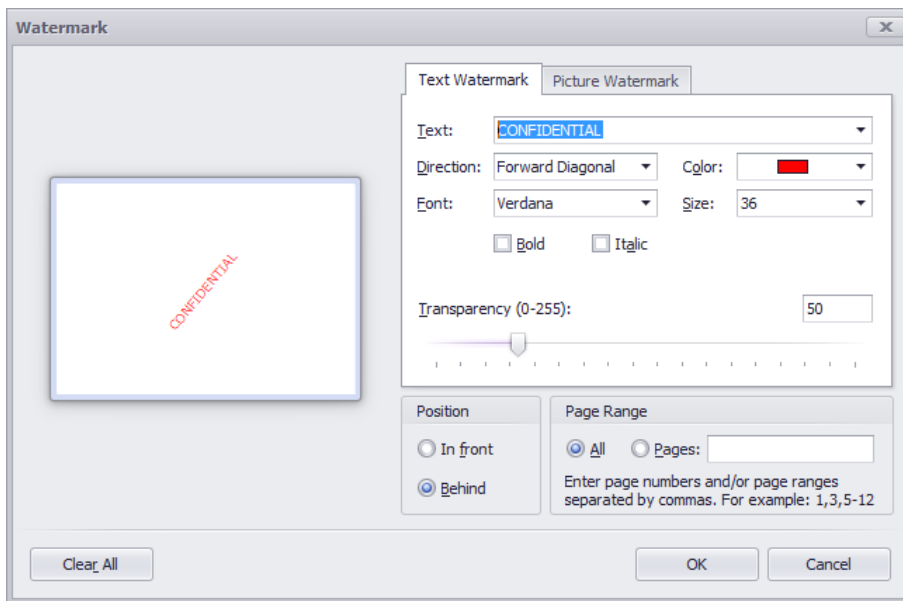

In the “Picture Watermark tab”, you can add an image as a watermark. Click Browse... to navigate to and select the desired image. You can also define additional options, such as Alignment, Transparency, etc.

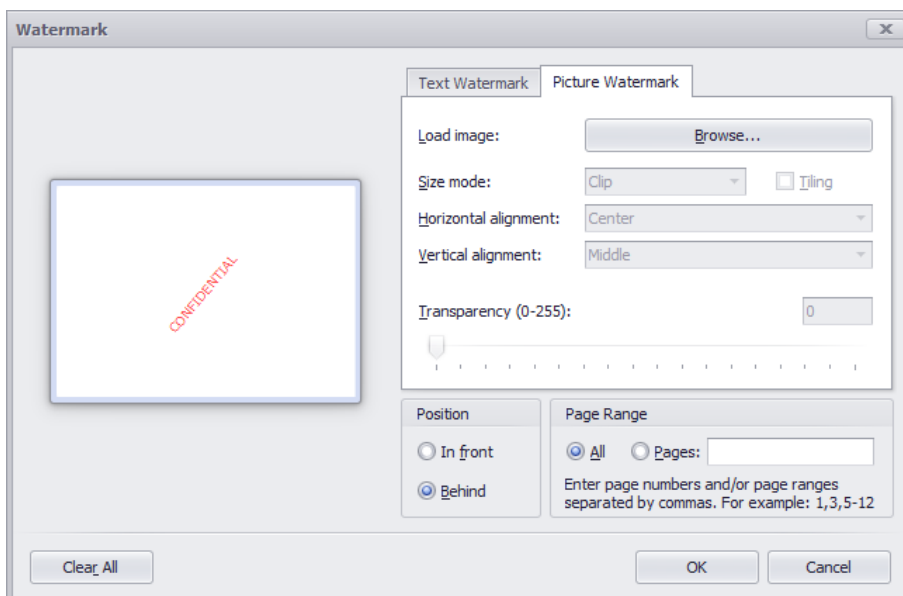

7.7.6 Export

The "Export Menu" allow you to save or send the report by email.



7.7.6.1 Export To

Click "Export To" and select the required file format from the dialogue box.

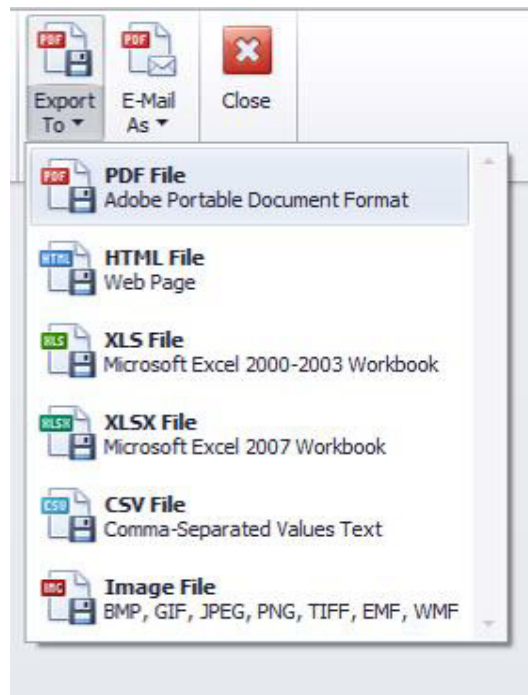
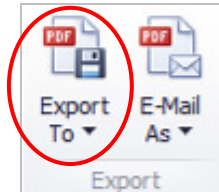

Example:

- PDF file:
 - In the PDF export, you can define security settings for the document.

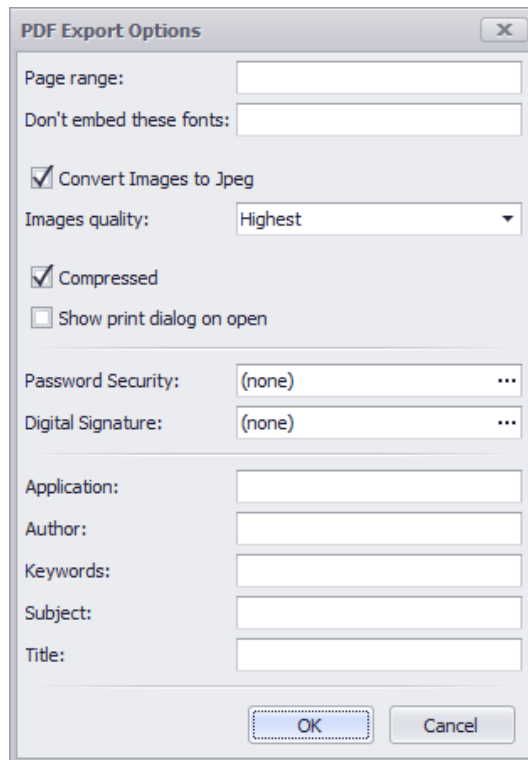

- HTML file:
 - Select an export mode and a character set to create your individual web page.

