

# Intel® Responsive Retail Sensor (RRS) H1000, H3000 and H4000 Sensors

User & Installation Guide

---

*Revision 0.4*  
*August 2018*



You may not use or facilitate the use of this document in connection with any infringement or other legal analysis concerning Intel products described herein. You agree to grant Intel a non-exclusive, royalty-free license to any patent claim thereafter drafted which includes subject matter disclosed herein.

No license (express or implied, by estoppel or otherwise) to any intellectual property rights is granted by this document.

All information provided here is subject to change without notice. Contact your Intel representative to obtain the latest Intel product specifications and roadmaps.

The products described may contain design defects or errors known as errata which may cause the product to deviate from published specifications. Current characterized errata are available on request.

Copies of documents which have an order number and are referenced in this document may be obtained by calling 1-800-548-4725 or by visiting: <http://www.intel.com/design/literature.htm>

Intel technologies' features and benefits depend on system configuration and may require enabled hardware, software or service activation. Learn more at <http://www.intel.com/> or from the OEM or retailer.

No computer system can be absolutely secure.

Intel and the Intel logo are trademarks of Intel Corporation in the U.S. and/or other countries.

\*Other names and brands may be claimed as the property of others.

Copyright © 2018, Intel Corporation. All rights reserved.



## Contents

<b>1.0</b>	<b>Regulatory, Certification and Environmental Compliance</b>	<b>7</b>
1.1	Federal Communications Commission (FCC) Compliance	7
1.2	Industry Canada (IC) Compliance	8
1.3	Europe – EU Declaration of Conformity	9
1.3.1	Other Regulatory Requirements	9
<b>2.0</b>	<b>Safety and Regulatory Information</b>	<b>11</b>
2.1.1	Safety & Regulatory Warnings	11
<b>3.0</b>	<b>Product Description</b>	<b>12</b>
3.1	Features	13
3.1.1	UHF RFID Reader	13
3.1.2	Internal RFID Antenna	13
3.1.3	Passive Infra-Red Detector	13
3.1.4	Accelerometer / Magnetometer	13
3.1.5	5MP Camera	13
3.1.6	Wi-Fi/BLE	13
3.1.7	Temperature / Humidity	13
3.2	Block Diagrams	14
3.2.1	Top Level	14
3.2.2	RF Subsystem	15
3.2.3	R2000 ASIC	15
<b>4.0</b>	<b>System Description</b>	<b>16</b>
4.1	Data Flow	16
4.2	Customer Cloud Applications	17
4.3	Responsive Retail Platform (RRP)	17
4.4	RFID Readers	17
4.5	RRP Device to Sensor Protocol	18
4.5.1	Request Object	18
4.5.2	Notification Object	18
4.5.3	Response Object	19
4.5.4	Error Codes	19
4.5.5	19	
4.5.6	Commands/Responses/Indications	20
<b>5.0</b>	<b>Product Specifications</b>	<b>21</b>
<b>6.0</b>	<b>Hardware Description</b>	<b>22</b>
6.1	H4000 and H3000 Models	22
6.1.1	Mounting Holes	22
6.1.2	Motion Sensor M1	22
6.1.3	Connector J1 (RJ-45)	22
6.1.4	Camera (C1)	22

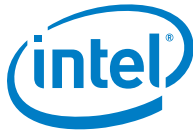

6.2	H1000 Model.....	23
6.2.1	Mounting.....	23
6.2.2	Connector J1 (RJ-45).....	23
6.2.3	Reverse-SMA Connectors RS 0-4.....	23
6.3	Visual Indicator D1 (Tri-Color LED) for all models.....	23
6.3.1	OFF.....	23
6.3.2	GREEN (Power On).....	24
6.3.3	Light BLUE.....	24
6.3.4	Flashing WHITE.....	24
6.3.5	Solid PURPLE.....	24
6.3.6	Flashing PURPLE.....	24
6.3.7	Solid Yellow (Idle).....	24
6.3.8	BLUE.....	24
6.3.9	Flashing BLUE.....	24
6.3.10	Flashing RED.....	24
<b>7.0</b>	<b>Software Description.....</b>	<b>25</b>
7.1	Operating System.....	25
7.2	Secure Platform.....	25
7.3	Security Provisioning.....	25
<b>8.0</b>	<b>Theory of Operation.....</b>	<b>26</b>
8.1	RFID Gateway Discovery.....	27
8.2	RFID Behavior Control.....	28
8.3	Managing Large Tag Populations.....	30
8.3.1	Normal Scan (Single Target).....	31
8.3.2	Normal Scan (Dual Target).....	32
8.3.3	High Mobility (Dual Target).....	33
8.3.4	Deep Scan (Single Target).....	34
8.3.5	Searching for a Single Tag or Group of Tags.....	35
<b>9.0</b>	<b>System Installation.....</b>	<b>38</b>
9.1	RF Exposure Statement.....	38
9.2	Information to the User.....	38
9.3	Cabling Infrastructure.....	39
9.3.1	Correct Wiring Standards.....	39
9.3.2	Proper Cable Type.....	40
9.3.3	Proper Cable Length.....	40
9.3.4	Environmental Conditions.....	41
9.3.5	Power over Ethernet.....	41
9.3.6	Cabling, Mounting and Antenna Consideration for the H1000 models.....	42
9.4	Connectivity.....	45
9.4.1	Physical.....	45
9.4.2	Network.....	46
9.5	Mounting (H4000 and H3000).....	47
9.5.1	Track Light Mounting Bracket.....	48
9.5.2	Wall Mounting Bracket.....	49



9.6 Mounting (H1000) ..... 50

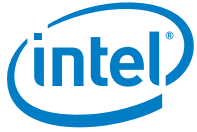

## Revision History

---

Date	Revision	Description
June 2018	0.0	Initial release.
July 2018	0.1	Updates from J. Belstner
July 2018	0.2	Regulatory updates (sections 2.1, 2.2, 2.3, 2.5)
July 2018	0.3	Updated various minor references, B. Wixom
August 2018	0.4	Added China RoHS Table, Section 2.5. B. Wixom

§

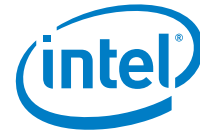

## 1.0 **Regulatory, Certification and Environmental Compliance**

---

Certifications have been acquired to operate in the following countries:

- US, FCC & NRTL
- EU Commission CE
- Argentina, ENACOM
- Australia, ACMA
- Brazil, ANATEL
- Canada, IC
- China, CCC & SRRC (if applicable)
- Colombia, CRC MinTIC ANTV and ANE
- Costa Rica, SUTEL
- Hong Kong, OFTA & KCC
- India, TRAI
- Indonesia, BRTI
- Japan, MIC JATE & VCCI
- Korea, KCC & RRL
- Malaysia, MCMC
- Mexico, IFT
- Russia, Minsvyaz
- Saudi Arabia, CITC
- Singapore, IMDA
- Taiwan, NCC BSMI
- Thailand, NBTC
- Turkey, ICTA
- United Arab Emirates, TRA
- Uruguay, URSEC
- Vietnam, YNTA
- International CB Scheme (IEC 62368-1)

### 1.1 **Federal Communications Commission (FCC) Compliance**

This device FCC ID: ZFL-H4000, ZFL-H3000 and ZFL-H1000 and contains FCC ID: XF6-RS9113DB(for H4000), IC: 1000H-H4000, 1000H-H3000 and 1000H-H1000 and contains IC ID: 8407A-RS9113DB (for H4000), complies with FCC Part 15 and ISED license-exempt RSS standards. Operation is subject to the following two conditions: (1) this device may not cause interference, and (2) this device must accept any interference, including interference that may cause undesired operation of the device.

Cet appareil, qui contient ID FCC: ZFL-H4000, ZFL-H3000 and ZFL-H1000 et contient FCC ID: XF6-RS9113DB (pour H4000), IC: 1000H-H4000, 1000H-H3000 et 1000H-H1000 et contient IC ID: 8407A-RS9113DB(pour H4000), est conforme aux exigences FCC et ISED pour les appareils radio autorisés. L'opération est soumise aux deux conditions suivantes: (1) cet appareil ne doit pas provoquer d'interférence, et (2) cet appareil peut provoquer des interférences, y compris des interférences pouvant entraîner un fonctionnement indésirable.

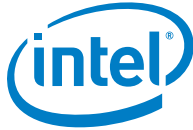

**Caution:** Changes to this product or modifications not expressly approved by the party responsible for compliance could void your authority to operate the equipment.

**WARNING:** This equipment has been tested and found to comply with the limits for a Class A digital device, pursuant to part 15 of the FCC Rules. These limits are designed to provide reasonable protection against harmful interference when the equipment is operated in a commercial environment. This equipment generates, uses, and can radiate radio frequency energy and, if not installed and used in accordance with the instruction manual, may cause harmful interference to radio communications. Operation of this equipment in a residential area is likely to cause harmful interference in which case the user will be required to correct the interference at his own expense.

## 1.2 Industry Canada (IC) Compliance

This device FCC ID: ZFL-H4000, ZFL-H3000 and ZFL-H1000 and contains FCC ID: XF6-RS9113DB(for H4000), IC: 1000H-H4000, 1000H-H3000 and 1000H-H1000 and contains IC ID: 8407A-RS9113DB(for H4000), complies with FCC Part 15 and ISED license-exempt RSS standards. Operation is subject to the following two conditions: (1) this device may not cause interference, and (2) this device must accept any interference, including interference that may cause undesired operation of the device.

Cet appareil, qui contient ID FCC: ZFL-H4000, ZFL-H3000 and ZFL-H1000 et contient FCC ID: XF6-RS9113DB(pour H4000), IC: 1000H-H4000, 1000H-H3000 et 1000H-H1000 et contient IC ID: 8407A-RS9113DB(pour H4000), est conforme aux exigences FCC et ISED pour les appareils radio autorisés. L'opération est soumise aux deux conditions suivantes: (1) cet appareil ne doit pas provoquer d'interférence, et (2) cet appareil peut provoquer des interférences, y compris des interférences pouvant entraîner un fonctionnement indésirable.



**Caution:** Changes to this product or modifications not expressly approved by the party responsible for compliance could void your authority to operate the equipment.

Innovation, Science and Economic Development Canada ICES-003 Compliance Label: CAN ICES-3(A)/NMB-3(A)

This device complies with Industry Canada license-exempt RSS standard(s). Operation is subject to the following two conditions: (1) this device may not cause interference, and (2) this device must accept any interference, including interference that may cause undesired option of the device.

Le présent appareil est conforme aux CNR d'Industrie Canada applicables aux appareils radio exempts de licence. L'exploitation est autorisée aux deux conditions suivantes : (1) l'appareil ne doit pas produire de brouillage, et (2) l'utilisateur de l'appareil doit accepter tout brouillage radioélectrique subi, même si le brouillage est susceptible d'en compromettre le fonctionnement.





### 1.3 Voluntary Control Council for Interference (VCCI) Warning

#### Class A ITE

この装置は、情報処理装置等電波障害自主規制協議会（VCCI）クラスA情報技術装置です。この装置を家庭環境で使用すると電波妨害を引き起こすことがあります。この場合には使用者が適切な対策を講ずるよう要求されることがあります。

### 1.4 Europe – EU Declaration of Conformity

Hereby, Intel Corporation declares that the radio equipment type RRS-H1000, RRS-H3000 and RRS-H4000 is in compliance with...

- Radio Equipment Directive (RED) 2014/53/EU
- EU directive 2011/65/EU (RoHS II)

The full text of the EU declaration of conformity is available at the following internet address:

#### 1.4.1 Other Regulatory Requirements

Hereby, Intel Corporation declares that the radio equipment type RRS-H1000, RRS-H3000 and RRS-H4000 is in compliance with...

- REACH Regulation (EC) 1907/2006
- WEEE Directive 2012/19/EU
- China RoHS Declaration

Management Methods on Control of Pollution From Electronic Information Products  
(China RoHS declaration)  
产品中有害物质的名称及含量  
Hazardous Substances Table

部件名称 (Parts)	铅 (Pb)	汞 (Hg)	镉 (Cd)	六价铬 (Cr(VI))	多溴联苯 (PBB)	多溴二苯醚 (PBDE)
主机板 Motherboard	x	○	○	○	○	○
机壳Chassis	x	○	○	○	○	○
缆线Cables	x	○	○	○	○	○
风扇 Fan	○	○	○	○	○	○
散热器Heat sink	○	○	○	○	○	○

本表格依据 SJ/T 11364 的规定编制。  
 ○：表示该有害物质在该部件所有均质材料中的含量均在GB/T 26572标准规定的限量要求以下。  
 ○：Indicates that this hazardous substance contained in all homogeneous materials of such component is within the limits specified in GB/T 26572.  
 ×：表示该有害物质至少在该部件的某一均质材料中的含量超出GB/T 26572标准规定的限量要求。  
 ×：Indicates that the content of such hazardous substance in at least a homogeneous material of such component exceeds the limits specified in GB/T 26572.  
 对销售之日的所售产品,本表显示我公司供应链的电子产品信息产品可能包含这些物质。注意：在所售产品中可能会也可能不会含有所有所列的部件。  
 This table shows where these substances may be found in the supply chain of our electronic information products, as of the date of sale of the enclosed product. Note that some of the component types listed above may or may not be a part of the enclosed product



除非另外特别的标注,此标志为针对所涉及产品的环保使用期限标志。  
某些可更换的零部件可能会有一个不同的环保使用期限(例如,电池单元模块)。  
此环保使用期限只适用于产品在产品手册中所规定的条件下工作。



The Environmental Protection Use Period (EPU) for all enclosed products and their parts are per the symbol shown here, unless otherwise marked. Certain field-replaceable parts may have a different EPU (for example, battery modules) number. The Environment-Friendly Use Period is valid only when the product is operated under the conditions defined in the product manual.

## 1.5 H1000 Specific Instruction & Warning

This device has been designed to operate with the antennas listed below, and having a maximum gain of 8.5 dBi. Antennas not included in this list or having a gain greater than 8.5 dBi are strictly prohibited for use with this device. The required antenna impedance is 50 ohms.

Ce dispositif a été désigné pour fonctionner avec les antennes énumérées ci-dessous, et ayant un gain maximum de 8.5 dBi. Les antennes non incluses dans cette liste ou ayant un gain plus grand que 8.5 dBi sont strictement interdites pour l'utilisation avec cet appareil. L'antenne requise impédance est 50 ohms.

- (A) The recommended antenna types for the H1000 unit are listed below (and section 10.3.6.2):
  - a. Ceiling/Wall Mounting: Laird RFID Panel Antenna, S8655P (ETSI) or S9025P (FCC). This antenna has a circularly polarized pattern and provide 5.5 dBi gain.
  - b. Tabletop Point-of-Sale (POS): Times-7 RFID Near-Field Antenna, A1030. This antenna has a circularly polarized pattern and provides -15.0 dBi gain.
- (B) The H1000 has 4x external ports, connector type Reverse Polarity SMA (SMA-R). The maximum allowable torque for these external connectors is 10 in-lbs, max.
- (C) It is possible that these port connectors require an RF adapter depending upon the actual antenna that is used and it's mating connector type.

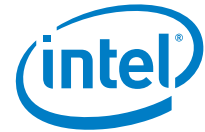

## 2.0 *Safety and Regulatory Information*

---

### 2.1.1 Safety & Regulatory Warnings



**USERS:** This device is intended to be use/operated by Instructed Persons & Skilled Persons only.

**Do Not Open:** This device is not intended to be open by the operator. There are no user serviceable parts.

**Installation and Maintenance:** Do not connect/disconnect any cables to or perform installation/maintenance on this device during an electrical storm.

This equipment is only to be connected to PoE networks without routing to outside plants.

This unit is supplied by an UL Listed I.T.E.

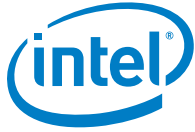

### 3.0 *Product Description*

---

The RRS-H1000 (Model: H1000), RRS-H3000 (Model: H3000) and RRS-H4000 (Model: H4000) are members of the “Smart Sensor” family that is part of the Intel® Responsive Retail System (RRS). These devices have capabilities for several on-board sensors including an EPC Gen 2 UHF RFID Interrogator (reader). These sensors are designed to work stand-alone, or in a network of other “Smart Sensors” as part of an Internet-of-Things (IoT) system where computing power is pushed out to the edge devices.





**Figure 1: Responsive Retail Sensor Hx000 Family**



### 3.1 Features

The H3000 and H4000 are designed to be ceiling or wall mounted facing into the retail space and hidden from view. H1000 is designed to be mounted under a table or flush mounted to a wall or cabinet and hidden from view. The following features are unique to the three different models

		H1000	H3000	H4000
<b>Feature</b>	<b>Description &amp; Purpose</b>			
<b>UHF RFID Reader</b>	UHF EPC Gen 2 RFID Reader module. This module supports the core functionality of RRS (i.e. inventory management)	✓	✓	✓
<b>Internal RFID Antenna</b>	7.67 dBi Slot Coupled Microstrip Antenna	*	✓	✓
<b>Passive Infra-Red Detector</b>	Detect human motion		✓	✓
<b>Accelerometer / Magnetometer</b>	Reading the orientation of the device as it is mounted.		✓	✓
<b>5MP Camera</b>	Omnivision OV5640 5MP camera for video and still image capture			✓
<b>Wi-Fi/BLE</b>	Redpine Systems RS9113 integrated Wi-Fi/BLE			✓
<b>Temperature / Humidity</b>	Read the temperature and humidity of the environment where the device is mounted.	✓	✓	✓

\* The H1000 model is designed to support up to four **reverse-SMA RF ports** for connecting up to four UHF RFID external antennas (not included) on the front panel.



## 3.2 Block Diagrams

### 3.2.1 Top Level

A block diagram of t

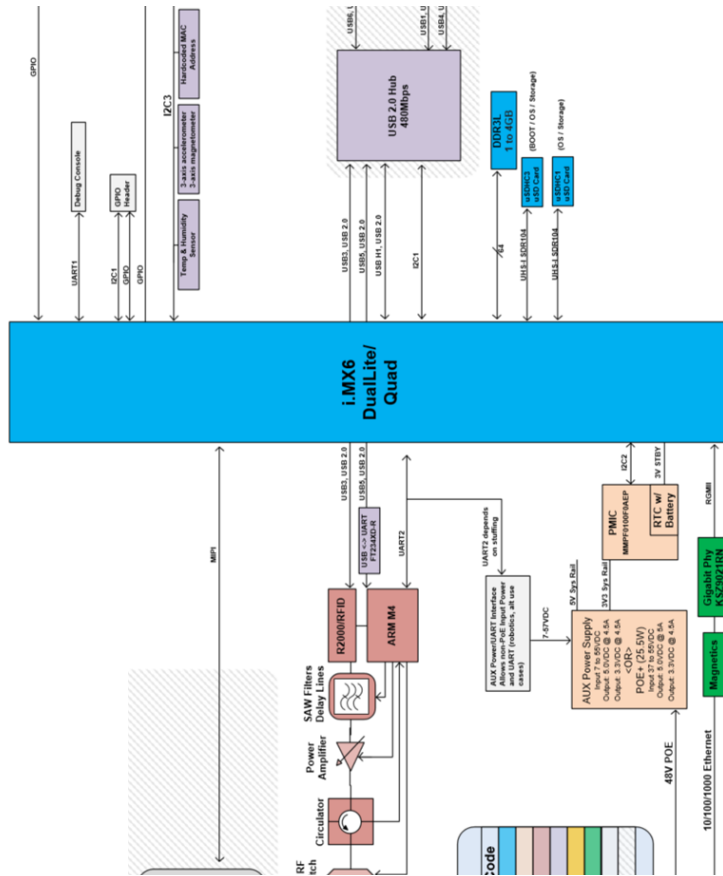
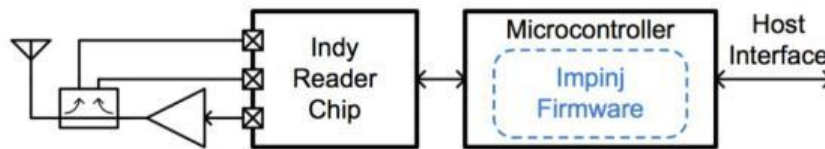

Figure 2: Hx000 Functional Block Diagram

### 3.2.2 RF Subsystem

The R2000 subsystem (aka “RF Circuitry”) is defined as the ARM M4 (aka Microcontroller), R2000/RFID transceiver (aka “Indy Reader Chip”), power amplifier, directional coupler, 4-port antenna switch and associated matching components. The Sensors uses an internal dual linear antenna that only requires two of the four ports. The H1000 brings out all four of the antenna ports to external R-SMA connectors allowing the System Integrator to use antennas that are not collocated with the H1000reader. Below is a block diagram of the R2000 Sub-System.



### 3.2.3 R2000 ASIC

For reference, a block diagram of the Impinj R2000 ASIC internal components is shown below.

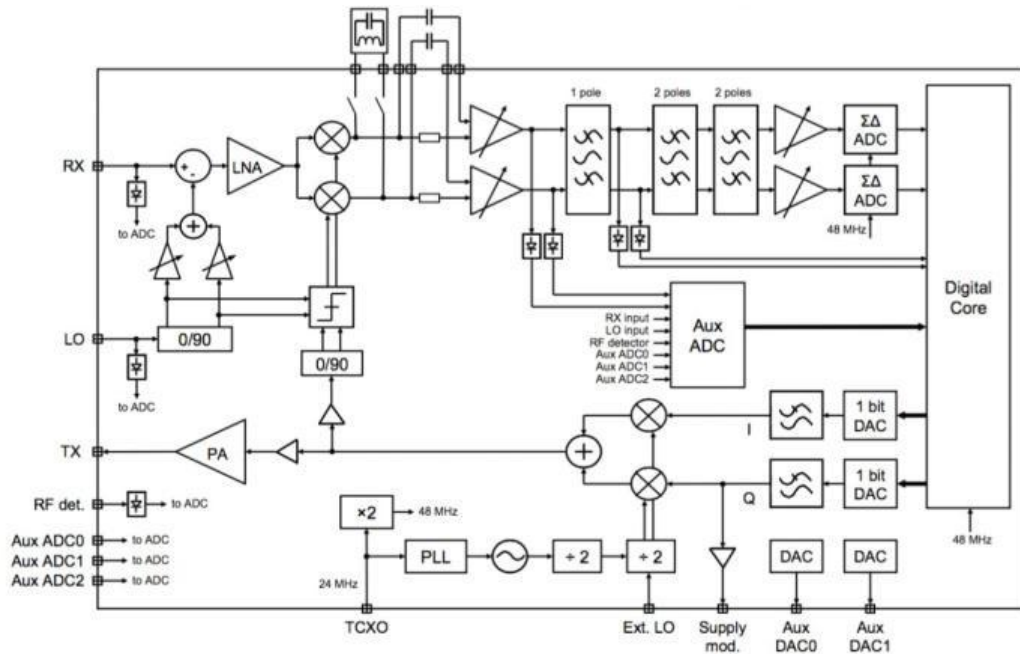

Figure 3: R2000 ASIC Block Diagram



## 4.0 System Description

The RRS-Hx Sensor is just one component of the larger Intel® Responsive Retail Platform (RRP) shown in Figure 3.1 below. The system is comprised of one or more Retail Sensors and a RRP appliance for control and orchestration. Customers may integrate their own cloud infrastructure component for data storage and analytics.

### What's included...

#### Intel® Responsive Retail Sensors

- Low Cost, Multi-Sensor Platform

#### Intel® Responsive Retail Platform

- RFID Provider (behavior orchestration and raw data processing)
- Inventory Service (database and qualified event generation)

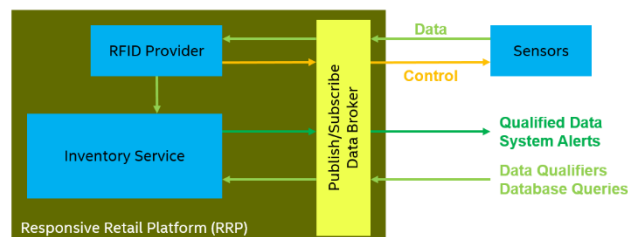

Figure 4: RRS Functional Block Diagram

The power of the RRP is in the networked communication and coordination that exists between the RRS's themselves and between the RRS and the RRP device. Whether a system deployment has 5 or 500 Retail Sensor Platforms, this communication and coordination greatly simplifies initial configuration as well as the operational management.

### 4.1 Data Flow

From a data flow perspective, RFID reader interrogates the tag population within its field of view and passes information regarding the tags as well as information from other various on-board sensors to the RRP appliance. The RRP appliance does more than just aggregate the data from the sensor population, it also orchestrates the behavior of each sensor to optimize the overall in-store data collection process. Inventory Events, Alerts and System Status can be forwarded from the RRP device to applications running in the customer's cloud infrastructure. Figure 9 illustrates the flow of data and control within the RRS.



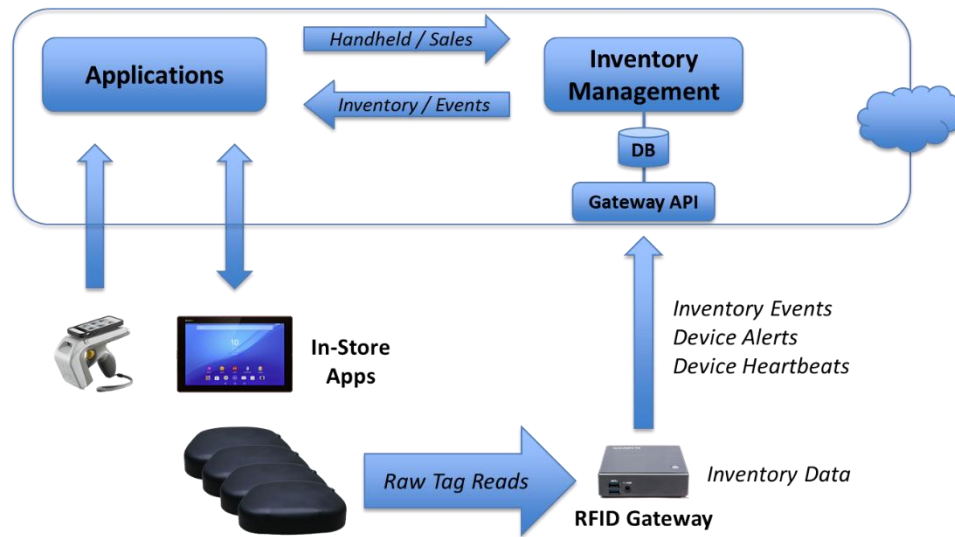

Figure 5: System Data Flow

## 4.2 Customer Cloud Applications

Customers may utilize their own cloud infrastructure to process the data. RRP will provide a set of REST interfaces for customer applications to obtain the data necessary to determine item identification, location, movement and status.

## 4.3 Responsive Retail Platform (RRP)

The Responsive Retail Platform (RRP) performs sensor control, sensor management, sensor data aggregation, data processing, event generation and event management. It supports configuration and management from a local interface.

## 4.4 RFID Readers

The RRS-Sensor devices provide the ability to remote command, control, status, and data collection via Ethernet. Data from RFID tag reads as well as data from other on-board sensors is published to an MQTT broker. The data API is based on JSON RPC commands, responses and indications. JSON-RPC is a text based, stateless, lightweight remote procedure call (RPC) protocol.



## 4.5 RRP Device to Sensor Protocol

The RRS Sensor provides a remote capability for command, control, status and data collection via JSON Remote Procedure Call (RPC) over MQTT. The Retail Gateway Command set follows the JSON RPC 2.0 specification. JSON-RPC is a stateless, lightweight protocol that is transport agnostic.

### 4.5.1 Request Object

The Request object has the following members:

- **jsonrpc**
  - A String specifying the version of the JSON-RPC protocol.
- **method**
  - A String containing the name of the method to be invoked.
- **params**
  - A Structured value that holds the parameter values to be used during the invocation of the method.
  - This member may be omitted.
- **id**
  - An identifier containing a String or Number value (if included).
  - This member is used to correlate the context between the two objects.

### 4.5.2 Notification Object

A Notification is a Request object without an "id" member. A Request object that is a Notification signifies that a corresponding Response object is not expected.



### 4.5.3 Response Object

The Response is expressed as a single JSON Object, with the following members:

- **jsonrpc**
  - A String specifying the version of the JSON-RPC protocol.
- **result**
  - The presence of this member indicates successful execution of the corresponding method.
  - This member is not present when the execution of the method resulted in an error.
- **error**
  - The presence of this member indicates unsuccessful execution of the corresponding method.
  - This member is not present when the execution of the method was successful.
  - When present, the error Object contains the following members:
    - **code**
      - An integer that indicates the error type that occurred.
    - **message**
      - A String providing a short description of the error.
    - **data**
      - A Primitive or Structured value that contains additional formation about the error (optional).
  - See table below for supported error codes.
- **id**
  - This member is always present on a response and contains the same value as the id member in the corresponding Request Object.
  - This member is not present on indications.

### 4.5.4 Error Codes

The RFID Sensor Platform provides one of the following error codes when an error occurs.

Code	Message	Meaning
-32001	Wrong State	Cannot be executed in the current state
-32002	Function not supported	The requested functionality is not supported
-32100	No facility assigned	The RRS has no Facility ID assigned yet
-32601	Method not found	The method does not exist
-32602	Invalid Parameter	Out of range or invalid format
-32603	Internal Error	RFID Sensor Platform application error
-32700	Parse error	Invalid JSON Object

### 4.5.5





## 4.5.6 Commands/Responses/Indications

Commands	Brief Description
connect	Request connect credentials from the GW
get_state	Retrieve the capabilities and current configuration
set_frequency_plan	Set the Region of Operation frequency plan
set_antenna_config	Configure the per antenna port parameters
set_select	Define a set of tag select criteria
set_post_match	Define the post singulation match criteria
apply_behavior	Applies a set of RFID parameters and...
start_inventory	Command a single or multiple inventory round(s)
stop_inventory	Stop the inventory round in progress.
tag_read_memory	Read up to 32 16-bit words from the tag memory
tag_write_memory	Write up to 32 16-bit words to the tag memory
get_tag_database	Retrieve the Tag Database from the RRS
get_bist_results	Query the Built-In-Self-Test (BIST) data of the RRS
set_device_alert	Configures and/or acknowledges device alerts
set_alert_threshold	Configure a particular "device_alert" threshold
ack_alert	Acknowledge a particular "device_alert"
set_motion_event	Configure the "motion_event" thresholds
get_sw_version	Retrieve the software versions of the RRS
load_defaults	Command to load the power-on default settings
capture_image	Capture an image using the on-board camera
start_video	Start streaming video using the on-board camera
stop_video	Stop streaming video using the on-board camera
set_led	Control the RFID Sensor Platform LED
reset	Perform a soft reset of the Embedded RFID module
reboot	Perform a reboot of the entire sensor platform
shutdown	Perform a clean shutdown of the entire sensor
set_facility_id	Set the Facility ID string assigned to this sensor
set_dense_reader_mode	Command the use of "Dense Reader Mode"

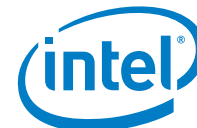
Indications	Brief Description
device_alert	Indicates a Built-In-Test event has occurred
heartbeat	Indicates the RRS is still operational
motion_event	Indicates the detection of motion from the IR sensor
status_update	Indicates a change in status
inventory_data	Indicates the receipt of RFID tag information
inventory_complete	Indicates that the inventory round is complete
inventory_event	Indicates that an inventory "event" has occurred



## 5.0 Product Specifications

			
Model	H1000	H3000	H4000
<b>Electrical:</b>			
Air Interface Protocol	EPC UHF RFID Class 1 Gen 2 (ISO 18000-6C)	EPC UHF RFID Class 1 Gen 2 (ISO 18000-6C)	EPC UHF RFID Class 1 Gen 2 (ISO 18000-6C)
Operating Frequency	902-928 MHz (US), 865-868 MHz (ETSI)	902-928 MHz (US), 865-868 MHz (ETSI)	902-928 MHz (US), 865-868 MHz (ETSI)
Radiated Power	N/A	Up to 4W EIRP (2W ERP)	Up to 4W EIRP (2W ERP)
Antenna	N/A	Integrated 6 dBi Dual-Linear Polarized	Integrated 6 dBi Dual-Linear Polarized
Power Output	Up to +27.03 dBm	Up to +28.15 dBm	Up to +28.16 dBm
Power Source	PoE+ (IEEE 802.3af, 802.3at, Cisco UPOE)	PoE+ (IEEE 802.3af, 802.3at, Cisco UPOE)	PoE+ (IEEE 802.3af, 802.3at, Cisco UPOE)
Power Consumption	16W max, 5W max idle	16W max, 5W max idle	13W max, 5W max idle
Tag Read Range	Based on external antenna type	>15m	>15m
Tag Read Rate	>600 tag reads/sec	>600 tag reads/sec	>600 tag reads/sec
Visual Indicators	Single tri-color LED	Single tri-color LED	Single tri-color LED
IR Detection	N/A	Panasonic PIR Sensor	Panasonic PIR Sensor
Video Camera	N/A	N/A	5MP, FOV-D 110°, H.264 or raw video, module rotation 0° to 90°
Antenna Ports	4-Ports, Reverse SMA	N/A	N/A
<b>Mechanical:</b>			
Dimensions	6.25" x 6.25" x 1.25" (15.9cm x 15.9cm x 3.2cm)	10.4" x 9" x 2" (26.4cm x 22.9cm x 5.1cm)	12" x 9" x 2" (30.5cm x 22.9cm x 5.1cm)
Weight	1.46 lbs. (0.66 kg)	4.00 lbs. (1.82 kg)	4.35 lbs. (1.98 kg)
Mounting	Custom mounting plate, or desk top	VESA 75mm pattern, M4 threads	VESA 75mm pattern, M4 threads
Color	Black	Black or White	Black or White
<b>Environmental:</b>			
Operating Temperature	0°C to +35°C	0°C to +35°C	0°C to +35°C
Rating	IP-50	IP-50	IP-50
<b>Application Interface:</b>			
Network Connectivity	Ethernet 10/100	Ethernet 10/100	Ethernet 10/100
IP Address Configuration	DHCP or static	DHCP or static	DHCP or static
Data Protocol	JSON-RPC 2.0 over MQTT	JSON-RPC 2.0 over MQTT	JSON-RPC 2.0 over MQTT
Configuration/Management	mDNS/DNS-SD	mDNS/DNS-SD	mDNS/DNS-SD
Time Synchronization	Network Time Protocol (NTP)	Network Time Protocol (NTP)	Network Time Protocol (NTP)
Software/Firmware Update	Remotely upgradable	Remotely upgradable	Remotely upgradable
Sensor Provisioning Function	Near Field Communications (NFC), no power required	Near Field Communications (NFC), no power required	Near Field Communications (NFC), no power required
4x External Antenna Ports	For use with customer supplied external antenna, up to 4x simultaneously. 4-Ports, Reverse SMA	N/A	N/A
<b>Regulatory:</b>			
Safety Compliance	IEC 60950-1	IEC 60950-1	IEC 60950-1
Radio Approvals	<sup>1</sup> FCC, ETSI, PRC (China), Singapore, Japan, among others	<sup>1</sup> FCC, ETSI, PRC (China), Singapore, Japan, among others	<sup>1</sup> FCC, ETSI, PRC (China), Singapore, Japan, among others



## 6.0 Hardware Description

### 6.1 H4000 and H3000 Models

Figure 6 highlights the external interfaces.

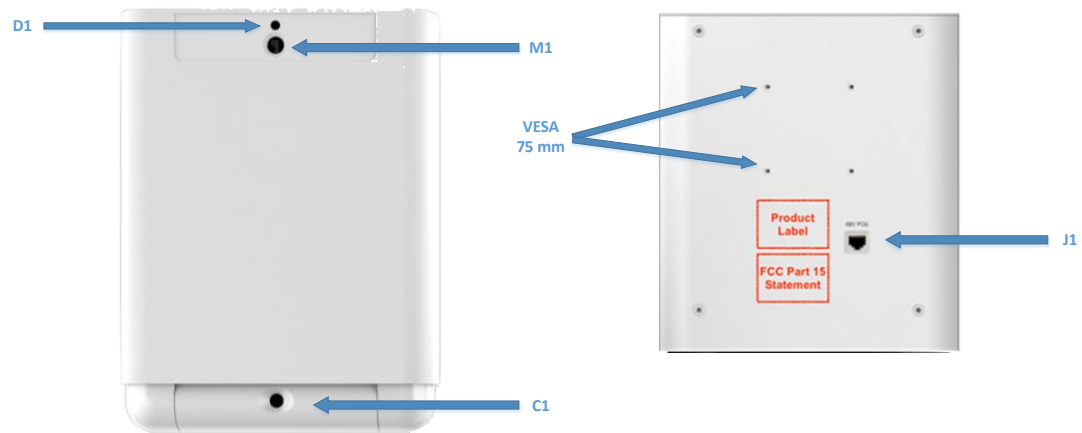

Figure 6: H400/H3000 Front and Back interfaces

#### 6.1.1 Mounting Holes

The RRS-H3000(Model: H3000) and RRS-H4000(Model: H4000) sensors provide a 75-mm hole pattern compatible with several types of mounting brackets. The holes are threaded to accept up to a 1 cm M4 stud.

#### 6.1.2 Motion Sensor M1

The RRS-H3000(Model: H3000) and RRS-H4000(Model: H4000) sensors use a passive infrared sensor to detect human motion in the field of the RFID antenna.

#### 6.1.3 Connector J1 (RJ-45)

The RRS-H3000 and RRS-H4000 sensor is a 48V Power Over Ethernet (POE) Class 3 device as defined in IEEE 802.3af. The sensors support 10/100 Ethernet on this same connector.

#### 6.1.4 Camera (C1)

The RRS-H4000 uses an Omnivision 5MP camera with a 100 degree horizontal field of view. The H4000 microprocessor is capable of streaming 1080p video at 30 frames per second. The camera module offers a rotation range of 0° to 90°.

## 6.2 H1000 Model

Figure 7 highlights the external interfaces.

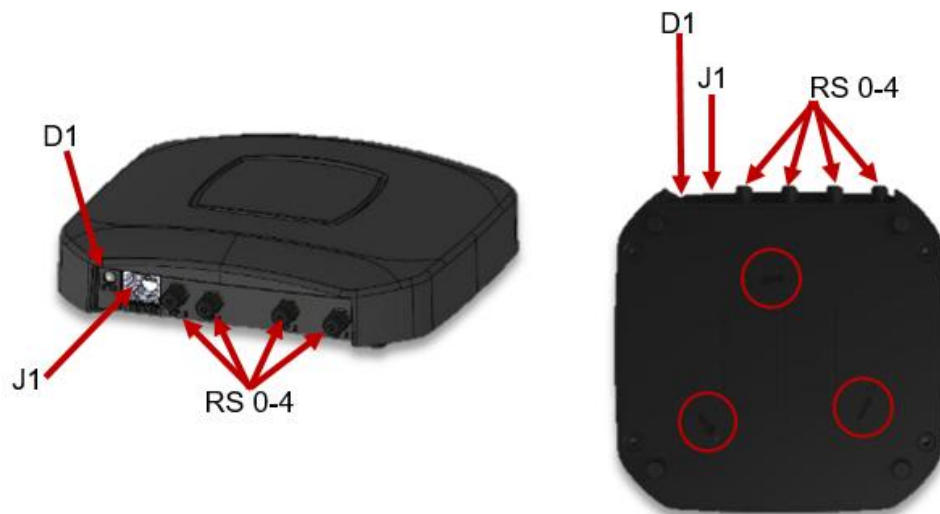

Figure 7:

RRS-H1000

### 6.2.1 Mounting

### 6.2.2 Connector J1 (RJ-45)

The RRS-H1000 is a 48V Power Over Ethernet (POE) Class 3 device as defined in IEEE 802.3af. The RRS-H1000 supports 10/100 Ethernet on this same connector.

### 6.2.3 Reverse-SMA Connectors RS 0-4

The RRS-H1000 provides four Reverse-SMA RF ports for connecting up to four UHF RFID external antennas (not included).

## 6.3 Visual Indicator D1 (Tri-Color LED) for all models

The RRS-Sensors provides a multicolored visual indicator to notify the user of the following operational states.

### 6.3.1 OFF

An LED state of "off" indicates the RRS-Sensors has either been commanded to disable its visual indicator or is otherwise non-operational.

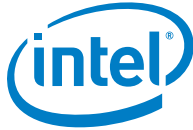

### **6.3.2 GREEN (Power On)**

An LED state of "solid green" is the default to indicate power has been successfully applied to the RRS. This initial LED state should not last longer than 2 – 3 minutes. After 2 – 3 minutes, the LED color should transition to indicate successful OS boot.

### **6.3.3 Light BLUE**

An LED state of "solid light blue" indicates the RRS-Sensors has successfully booted to the Linux OS, but the RFID Applications are not yet running.

### **6.3.4 Flashing WHITE**

An LED state of "flashing white" after boot up indicates the RRS-Sensors is in the process of discovering the RFID Gateway. The state of "flashing white" can also be commanded (i.e. Beacon Mode) by the Gateway via JavaScript Object Notation (JSON) Remote Procedure Call (RPC) for visually identifying the RRS.

### **6.3.5 Solid PURPLE**

An LED state of "solid purple" indicates the RRS-Sensors is waiting to read a security provisioning tag.

### **6.3.6 Flashing PURPLE**

After a security provisioning tag has been successfully read, the RRS-Sensors LED state will be "flashing purple" for a period of 5 seconds.

### **6.3.7 Solid Yellow (Idle)**

Following Gateway Discovery, an LED state of "solid yellow" indicates that The RRS-Sensors is in the idle state and ready to accept commands.

### **6.3.8 BLUE**

An LED state of "solid blue" indicates the RRS-Sensors is currently in an Inventory Cycle (i.e. transmitting) but not receiving any tag data.

### **6.3.9 Flashing BLUE**

An LED state of "flashing blue" indicates the RRS-Sensors is currently in an Inventory Cycle (i.e. transmitting) and successfully communicating with RFID tags.

### **6.3.10 Flashing RED**

An LED state of "flashing red" indicates the RRS-Sensors has detected a failure. This will continue until the alert is acknowledged by the RFID Gateway or the CLI.



## 7.0 Software Description

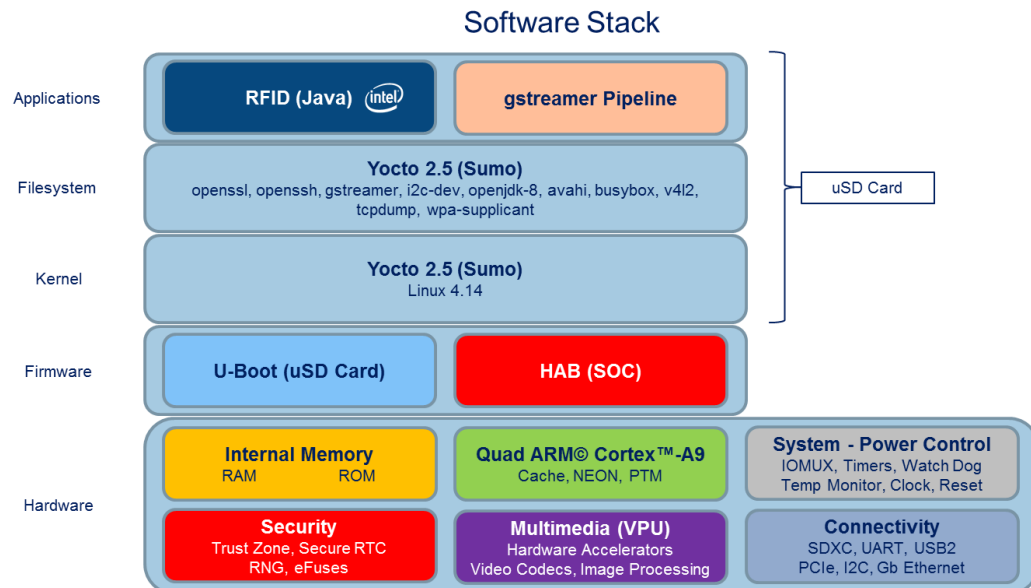

Figure 8: RRS-Hx000 Software Stack

### 7.1 Operating System

The H4000/H3000 uses the Freescale i.MX6 processor running a Yocto Project Linux kernel and file system.

### 7.2 Secure Platform

The H4000/H3000 incorporates both secure boot, file system encryption and software packages that are signed by Intel's EDSS to insure that only the software intended for this device is allowed to run.

### 7.3 Security Provisioning

The H4000/H3000 includes an embedded NFC tag for programming the security information required to join the Responsive Retail Platform. An Android Application is available to easily program this information into the sensor. The screenshots below show how to use this application to program the H4000/H3000. **TODO Add screenshots here)**



## 8.0 *Theory of Operation*

---

The power of RRS is in the networked communication and coordination that exists between the Sensor Platforms themselves and between the RFID Gateway. Whether a particular RFID system deployment has 5 or 500 RRS devices, this communication and coordination greatly simplifies initial configuration as well as the operational management. This section defines the set of messages used between the RFID Retail Sensor Platform and the RFID Gateway that facilitates this orchestration.

Some of these messages affect the RF power output and modulation scheme being transmitted. The Impinj R2000 RF subsystem buffers all commands received from the RFID Gateway via the Host Processor. NOTE: Any command that attempts to set a parameter to a value that is outside its valid range or would otherwise cause the RRS-Sensors to no longer be compliant with its certification will return an error code and the previous command settings will persist.

Several Use Cases have been defined that illustrate initial discovery, configuration and tag population management. Detailed message definitions can be found in the Retail Sensor Platform API.

## 8.1 RFID Gateway Discovery

A goal of the RFID Sensor Platform is to be as much of a “zero-conf” installation as possible. Once power is applied, the RRS Sensor autonomously acquires a network address via DHCP and discover the RRS Gateway. The RRS Sensor also supports encryption via a TLS connection to the MQTT broker. An optional “provisioning tag” containing a hash and token can be used for the RRS Sensor to authenticate the Cloud and the RRS Gateway to authenticate the sensor as it connects. Figure 9 illustrates the message exchange involved in this use case.

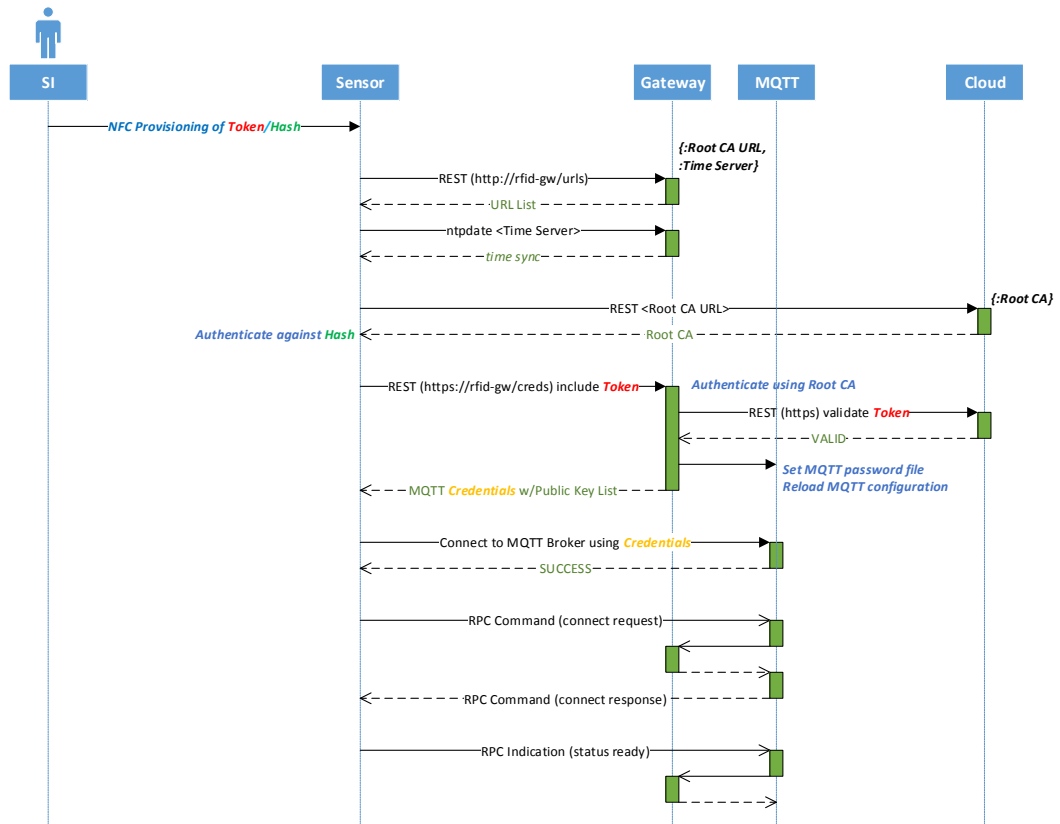

Figure 9: Device Discovery



## 8.2 RFID Behavior Control

In addition to using default values, the RFID Sensor Platform supports the detailed RFID configuration via the “apply\_behavior” API command. This command is shown below (see the RFID API Command Set document for a complete set of command definitions).

Parameter	Definition
action	Specifies the action to be taken. The valid values are “START” and “STOP”.
action_time	Specifies the millisecond epoch time to apply the behavior. If zero or not included, the behavior is applied immediately.
behavior	Optional set of behavior parameters (see below).
id	The ID string assigned to this behavior
operation_mode	The embedded RFID module transmit operation mode. The valid values are "Continuous" and "NonContinuous". The default value is "NonContinuous".
link_profile	The RF Link Profile to be used for this behavior. (see <a href="#">錯誤! 找不到參照來源。</a> ) The valid range is 0 – 4.
power_level	The power output level in dBm to be used for this behavior. The valid range is 0 – 27.03.
dwll_time	The maximum amount of time (ms) spent on a particular virtual port before switching to the next virtual port during an inventory cycle. If this parameter is zero, the “inv_cycles” parameter may not be zero. The valid range is 0 – 65535.
inv_cycles	The maximum amount of inventory cycles to attempt on a particular virtual port before switching to the next virtual port during an inventory cycle. If this parameter is zero, the “dwll_time” parameter may not be zero. The valid range is 0 – 65535.
selected_state	Specifies the state of the “SL” flag to be used for this behavior when specifying a select protocol operation. The valid values are: “Any”, “Deasserted” and “Asserted”.
session_flag	Specifies which inventory session flag is matched against the state specified by “target_state”. (see <a href="#">錯誤! 找不到參照來源。</a> ) The valid values are “S0”, “S1”, “S2” and “S3”.
target_state	Specifies the state of the inventory session flag specified by “session_flag” that are to apply the subsequent tag protocol operation. (see <a href="#">錯誤! 找不到參照來源。</a> ) The valid values are “A” and “B”.
q_algorithm	The specific Q algorithm being configured. The valid values are “Fixed” and “Dynamic”. When using a “Fixed” algorithm, the number of time slots is 2 <sup>Q</sup> . When using a “Dynamic” algorithm, the Smart Sensor Platform’s embedded module will vary the number of slots dynamically based on the number of tags responding.
fixed_q_value	The fixed Q value to use (valid when q_algorithm = Fixed). The valid range of this parameter is 0 – 15.
repeat_until_no_tags	Specifies whether or not the singulation algorithm should

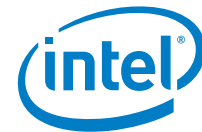

	continue until no more tags are singulated. The valid values are "true" or "false".
start_q_value	The initial Q value to use at the beginning of an inventory round (valid when q_algorithm = Dynamic). The valid range of this parameter is 0 – 15.
min_q_value	The minimum Q value that would ever be used during an inventory round (valid when q_algorithm = Dynamic). The valid range of this parameter is 0 – 15.
max_q_value	The maximum Q value that would ever be used during an inventory round (valid when q_algorithm = Dynamic). The valid range of this parameter is 0 – 15.
threshold_multiplier	A 4X multiplier applied to the Q-adjustment threshold as part of the dynamic-Q algorithm. The valid range of this parameter is 0 – 255.
retry_count	The number of times to try another execution of the singulation algorithm before either toggling the target flag or terminating the operation. The valid range of this parameter is 0 – 255.
toggle_target_flag	Specifies whether or not to toggle the targeted flag. The valid values are "true" or "false".
toggle_mode	When toggle_target_flag is true, this value specifies when to toggle the targeted flag. The valid values are "None", "OnInvCycle", "OnInvRound", or "OnReadRate".
perform_select	Specifies whether or not to perform a select command based on the previously configured criteria The valid values are "true" and "false".
perform_post_match	Specifies whether or not to perform a post singulation match based on the previously configured criteria. The valid values are "true" and "false".
filter_duplicates	Specifies whether or not the RFID Sensor Platform should filter out duplicate tag information before sending to the Gateway. The valid values are "true" or "false".
auto_repeat	Specifies whether or not to continue performing inventory rounds until the "stop_inventory" command is received. When this value is "No", an "inventory_complete" indication will be sent from the RFID Sensor Platform to the RRS Gateway at the end of the inventory round. The valid values are "true" and "false".
delay_time	The amount of time (ms) that the transmitter is turned off between subsequent inventory rounds. Used when "auto_repeat" is true to control the transmit duty cycle. The valid range is 0 – 65535.

Parameter / Profile Index	0	1	2	3	4
Modulation Type	DSB-ASK	PR-ASK	PR-ASK	DSB-ASK	DSB-ASK
Tari Duration (us)	25	25	25	6.25	6.25
Data 0/1 Difference	1	0.5	0.5	0.5	0.5
Pulse Width (us)	12.5	12.5	12.5	3.13	3.13
R-T Calculation (us)	75	62.5	62.5	15.63	15.63

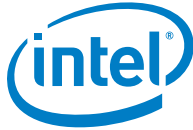

T-R Calculation (us)	200	85.33	71.11	20	33.33
Divide Ratio	8	21.33	21.33	8	21.33
Data Encoding	FM0	Miller-4	Miller-4	FM0	FM0
Pilot Tone	1	1	1	1	1
Link Frequency (kHz)	40	250	300	400	640
Data Rate (kbps)	40	62.5	75	400	640

Session	Tag Energized	Tag Not Energized
S0	Indefinite	None
S1	500 ms < persistence < 5 s	2 s < persistence
S2	Indefinite	2 s < persistence
S3	Indefinite	2 s < persistence

### 8.3 Managing Large Tag Populations

The RFID Gateway can segregate a large tag population into several smaller ones using the Retail Sensor Platform's "select" and "post-match" functions. Segregation allows the RRS-Sensors to more accurately inventory a tag population by avoiding collisions. This same functionality can also be used to isolate a single tag that might be located in a challenging RF environment or perhaps physically oriented in a less than optimal fashion.

A challenge in managing larger tag populations is dealing with "tag collisions" during the query-response (more than one tag responding at exactly the same time). The RRS-Sensors offers an adaptive algorithm (Dynamic-Q) function to mitigate tag collisions. An adaptive Q algorithm increases the reading efficiency significantly thereby reducing the time it takes to completely inventory a large tag population. The RRS-Sensors allows the RFID Gateway to optimally configure the Q Algorithm based on a known tag population. Dynamic-Q is used by default, which relieves the Gateway from having to explicitly set the Q-value.

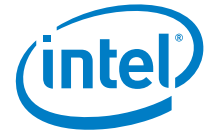

### 8.3.1 Normal Scan (Single Target)

This Use-Case illustrates the most common situation where a number of tagged items are being continuously inventoried on an RFID-enabled “smart shelf” or perhaps an overhead Retail Sensor Platform in an RFID-enabled “smart store”. This mode will allow multiple reads per tag for a moderate update of tag status to alert the RFID system should a tagged item be moved. No tag filtering is specified. The figure below illustrates the message exchange involved in this use case.

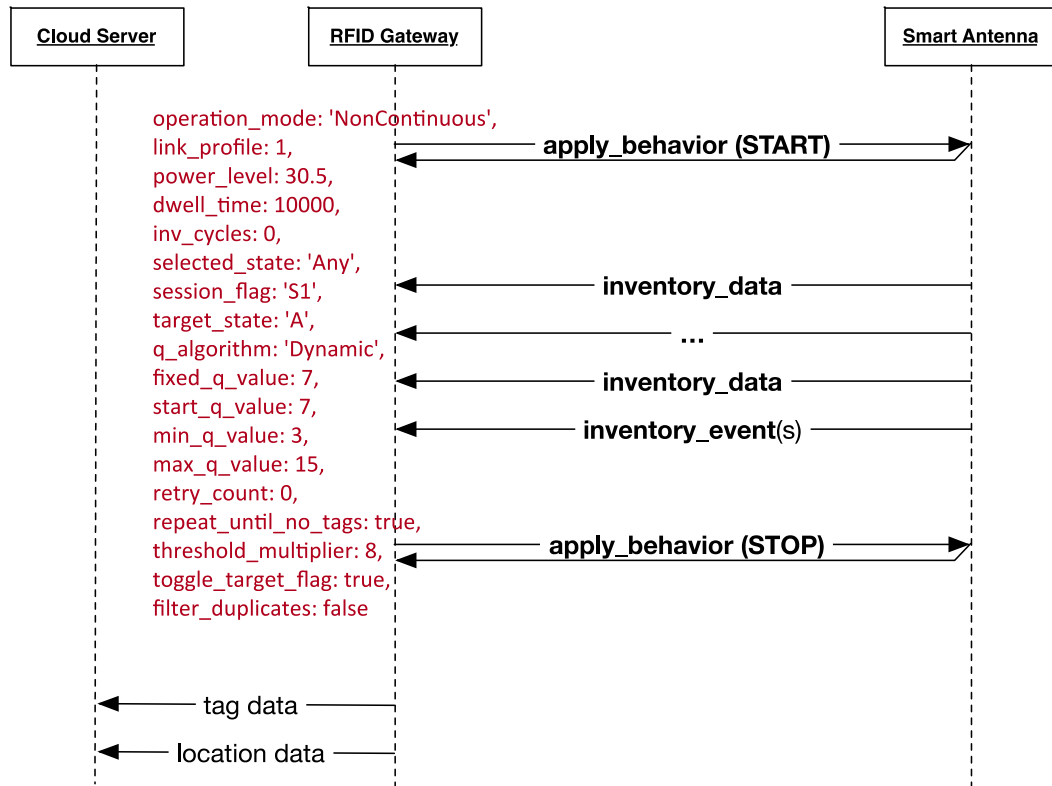
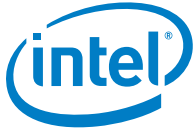

Figure 10 Normal Scan (Single Target) Data Flow



### 8.3.2 Normal Scan (Dual Target)

This Use-Case illustrates the most common situation where a number of tagged items are being continuously inventoried on an RFID-enabled “smart shelf” or perhaps an overhead Retail Sensor Platform in an RFID-enabled “smart store”. This mode will allow multiple reads per tag for a moderate update of tag status to alert the RFID system should a tagged item be moved. No tag filtering is specified. The figure below illustrates the message exchange involved in this use case.

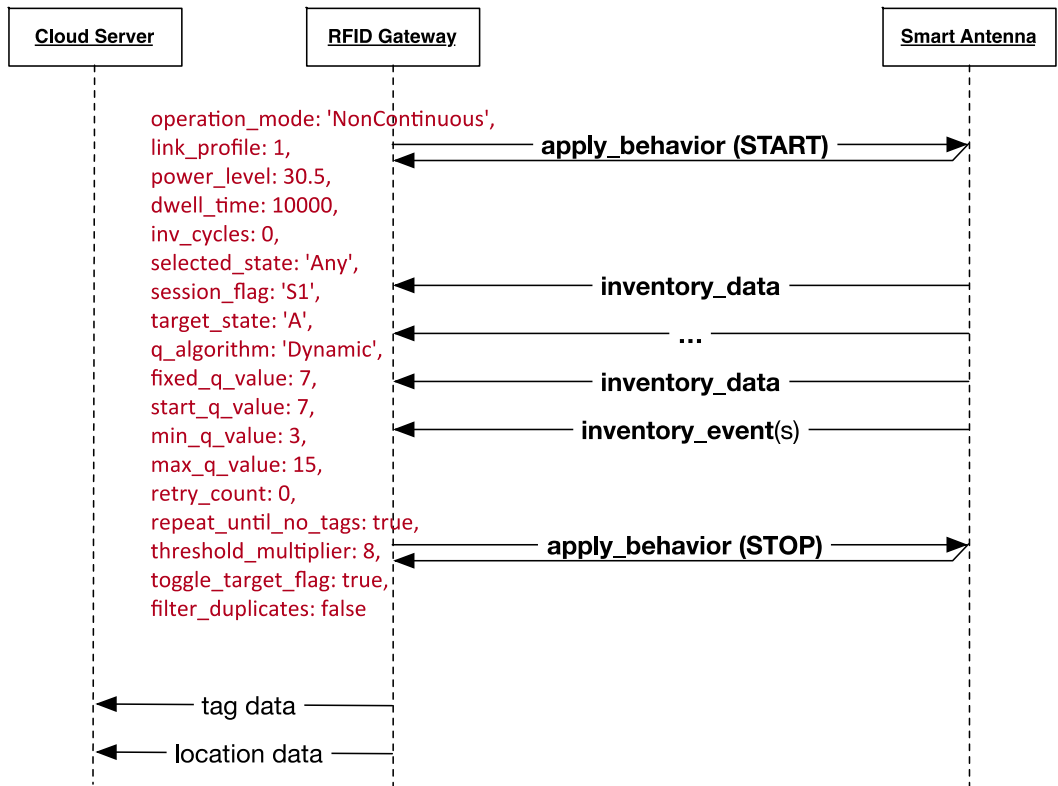
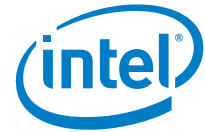

Figure 11 Normal Scan (Dual Target) Data Flow





### 8.3.3 High Mobility (Dual Target)

This Use-Case addresses the situation where a number of tagged items are being continuously inventoried, and higher numbers of reads per tag are required to detect tag mobility. Figure 4 illustrates the message exchange involved in this use case.

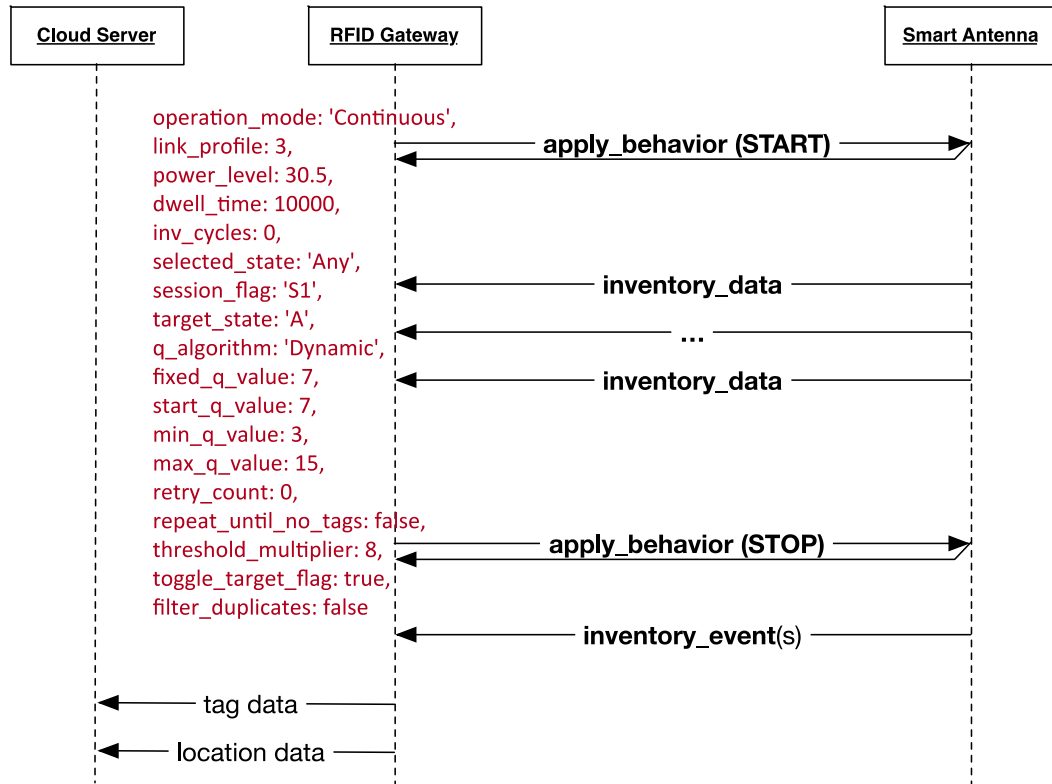

Figure 12 High Mobility Data Flow



### 8.3.4 Deep Scan (Single Target)

This Use-Case illustrates a thorough “Deep Scan” using the most robust RF link to insure that all tags within the coverage area are successfully read at least once. This mode also uses suppression to allow weaker tags to respond without competing with the multiple responses of other tags and is recommended only in situations where multiple reads per tag is not required. Sessions 2 and 3 are used to provide longer suppression times while scanning. Alternating between sessions 2 and 3 (and between A and B) allows for a rapid recovery when rescanning the tag population. This use-case insures that even the most distant tags with the weakest backscatter signal can be eventually read. Figure 6 illustrates the message exchange involved in this use case.

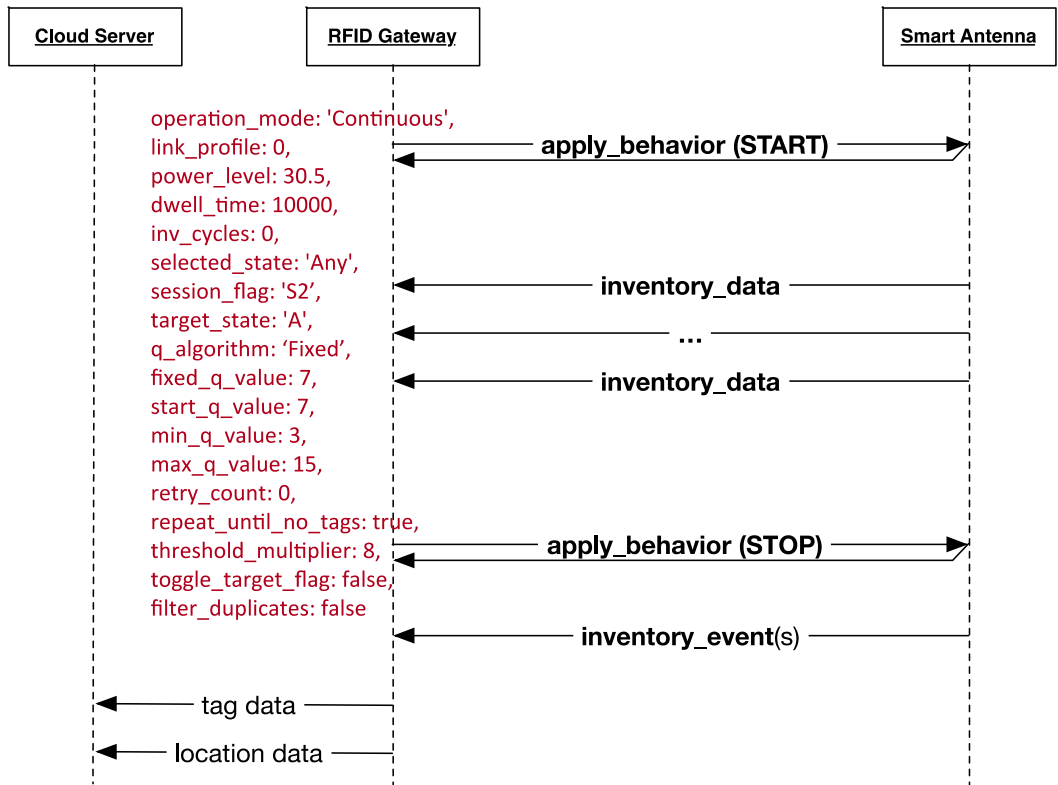

Figure 13 Deep Scan Data Flow



### 8.3.5 Searching for a Single Tag or Group of Tags

There are two ways to search for an individual tag or group of tags using The RRS-Sensors.

The "select" function configures the RRS-Sensors with set of tag filter criteria and instructs those tags that match that filter criteria to modify a certain register flag, forcing it to a known value prior to singulation. The tag protocol operation (i.e. read, write, kill) is applied only to those tags that meet the filter criteria. When tag populations are relatively large (> 1000) or when it is critical to apply a tag protocol operation to only a single tag, this method of filtering is preferred. A good example of an applied use of the "select" function would be at the point-of-sale (POS) where tags could be deactivated (killed) prior to exiting a controlled area.

The "post-match" function configures The RRS-Sensors with set of tag filter criteria that is applied "post" singulation or after a particular tag protocol operation is performed. Even though the tag still has to compete in the RF environment of the singulation process, the only data sent to the RFID Gateway is from those tags that match the filter criteria defined in the "post match" function. "Post Match" filtering is a single step process, tag memory is not modified and all tags respond to the inventory request. When tag populations are relatively small (< 1000), this method of filtering on certain tags is more efficient. A good example of an applied use of the "post match" function would be when searching a larger tag population with a hand scanner for a particular tag or group of tags.



### 8.3.5.1 Tag "Select"

This Use-Case shows an example of the tag "select" function to search for a single tag or group of tags. Figure 7 below illustrates the message exchange involved in this use case.

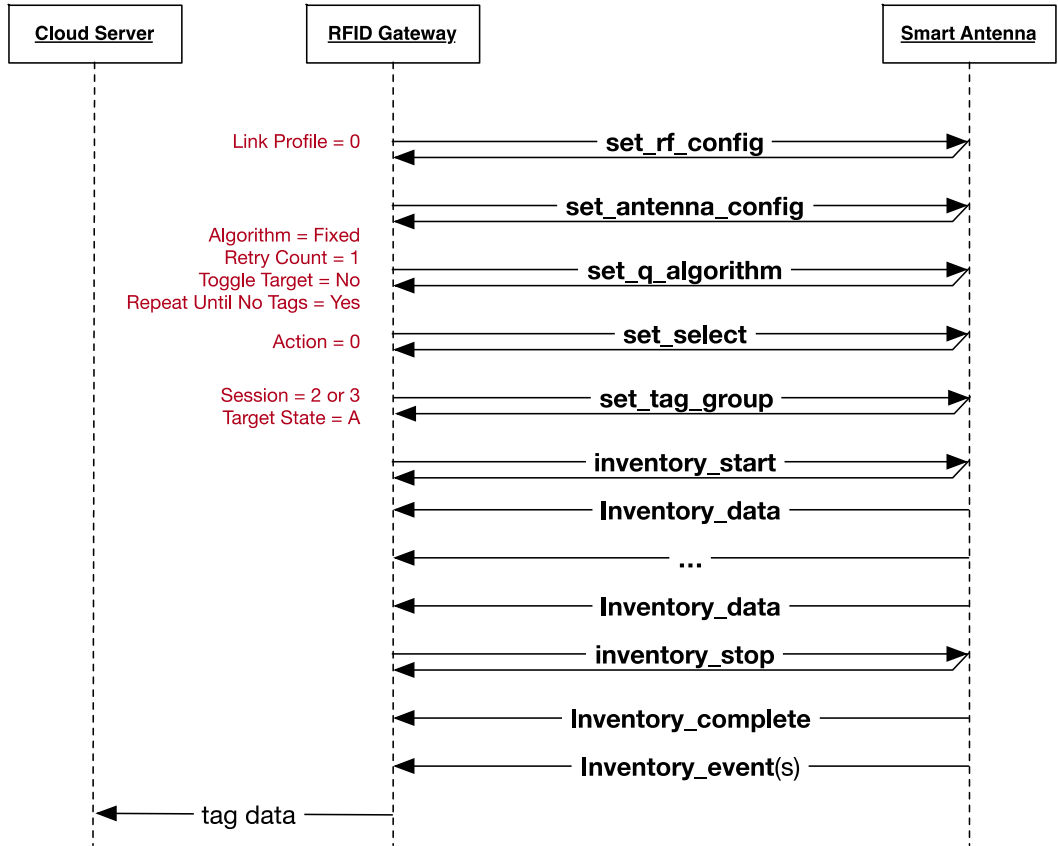
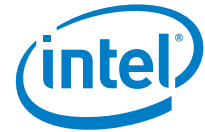

Figure 14 Tag Select Data Flow



### 8.3.5.2 "Post Match" Filtered Inventory

This Use-Case shows an example of the tag "post match" function to search for a single tag or group of tags. Figure 8 illustrates the message exchange involved in this use case.

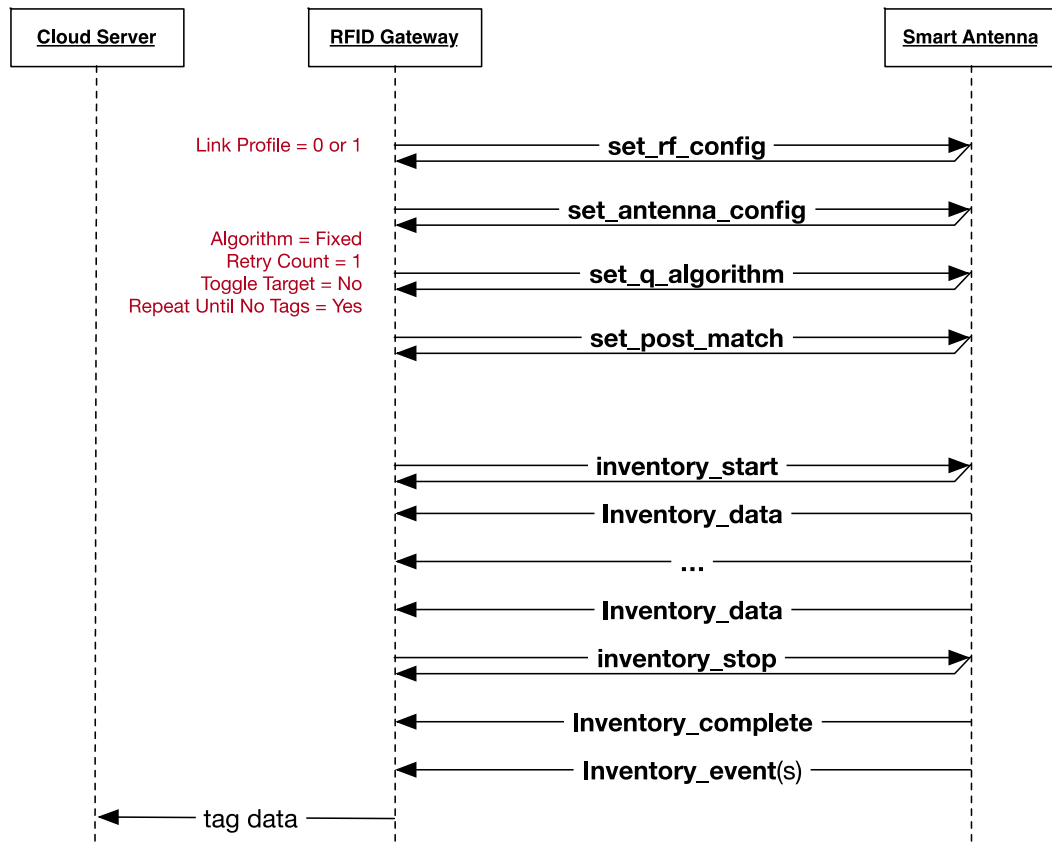

Figure 15 Post Match Data Flow



## 9.0 System Installation

---

### 9.1 RF Exposure Statement



**Caution:** The radiated output power of this device is below the FCC and International radio frequency exposure limits. To avoid the possibility of exceeding these exposure limits, always maintain a minimum distance of 34 cm (minimum distance of model H1000 is 26 cm) between the antenna and the human body. Details regarding the authorized configurations can be found at <http://www.fcc.gov/oet/ea/> by entering the FCC ID from the device.



**Caution:** L'antenne (s) utilisée (s) pour cet émetteur doit être installée pour assurer une distance de séparation d'au moins 34 cm (la distance minimale du modèle H1000 est de 26 cm) de Personnes et ne doivent pas être co-situés ou fonctionner conjointement avec une autre antenne ou émetteur. Utilisateurs et Les installateurs doivent être munis d'instructions d'installation d'antenne et de conditions d'exploitation de l'émetteur pour Conformité à l'exposition RF.

### 9.2 Information to the User



#### §15.105 Information to the user

Note: This equipment has been tested and found to comply with the limits for a Class A digital device, pursuant to part 15 of the FCC Rules. These limits are designed to provide reasonable protection against harmful interference in a residential installation. This equipment generates, uses and can radiate radio frequency energy and, if not installed and used in accordance with the instructions, may cause harmful interference to radio communications. However, there is no guarantee that interference will not occur in a particular installation. If this equipment does cause harmful interference to radio or television reception, which can be determined by turning the equipment off and on, the user is encouraged to try to correct the interference by one or more of the following measures:

- Reorient or relocate the receiving antenna.
- Increase the separation between the equipment and receiver.
- Connect the equipment to another POE source.
- Consult the system integrator or authorized technician for help.

This Class A digital apparatus complies with Canadian ICES-003.  
Cet appareil numérique de la classe B est conforme à la norme NMB-003 du Canada.

## 9.3 Cabling Infrastructure

Poorly or incorrectly installed network cabling can cause numerous problems in the RRS-Sensors network. However small it may appear, a problem with network cabling can have a catastrophic effect on the operation of the network. Even a small kink in a cable can cause an RRS to have intermittent connection with the RFID Gateway, and a poorly crimped connector may compromise Power over Ethernet (POE) functionality.

If there is existing cabling in an installation, it should be tested first using a Fluke Networks LSPRNTR-100 or equivalent device to insure proper RJ-45 connector pin out and Power over Ethernet (POE) capability before using with power an RRS.

### 9.3.1 Correct Wiring Standards

There are two wiring standards for network cabling: T568a and T568b. **DO NOT COMBINE** T568a and T568b on the same cable!

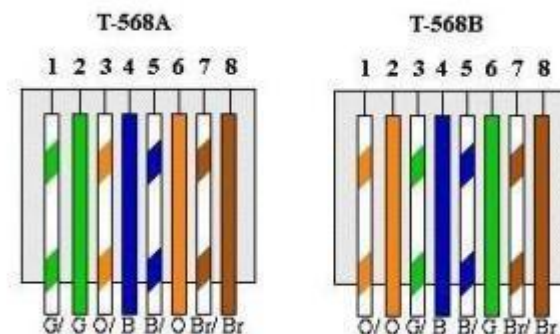

Figure 16 T-568A vs. T-568B

RJ-45 connectors are designed for either stranded or solid cable, but usually not both. Ensure use of the correct crimping tool for the specific type of connector. Ethernet cables have four pairs of color-coded twisted wires (orange, green, blue and brown). These cables are designed for high-speed data transfer with very little cross talk. It is important that no more than about 6 mm of the cable is untwisted at either end.



### 9.3.2 Proper Cable Type

For in-store RRS installations, it is recommended to use high-quality CAT 5e or CAT 6 cabling. Cables are categorized according to the data rates that they can transmit effectively. The specifications also describe the material, the connectors and the number of times each pair is twisted per meter. The most widely installed category is CAT 5e. Ensure that the category (CAT) of cabling used in the RFID system installation fulfills the required data rates.

- Cat 3 (no longer used) up to 16 MHz
- Cat 5e up to 100 MHz
- Cat 6 up to 250 MHz
- Cat 6A up to 500 MHz
- Cat 7 up to 600 MHz
- Cat 7A up to 1 GHz

Video and image files are generally much larger than JSON text files and need to be moved around the network as quickly as possible. In general, it is possible to use good-quality CAT 5 cabling for gigabit networks. However, it is generally recommended to use CAT 5e or CAT 6 cabling for gigabit connectivity, even if the existing network switches and routers support only 100 Mbps. This will ensure that the infrastructure in place can support gigabit data rates when an upgrade becomes necessary.

### 9.3.3 Proper Cable Length

Ensure that your cabling meets the requirements of your equipment. The distance between an RRS and the switch cannot be greater than 100 m. If installing sockets, remember to consider the distance between the socket and the RRS. A good rule of thumb is 90 meters for horizontal runs, and ten meters for the patch cabling.

Do **NOT** run cabling next to electrical cabling due to the potential for interference.

Since network cabling typically uses solid wire, cabling should not be twisted or bent into a tight radius (not less than 4 times the diameter of the cable). Do not use metal staples to secure cable runs, nor tightly adjusted cable wraps.

Avoid a daisy chain network topology using intermediate switches or butt connectors to extend the length of an otherwise "too short" cable run. Use a single continuous cable run from the RRS to the switch.



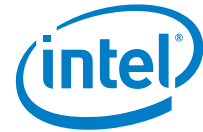

### 9.3.4 Environmental Conditions

The RRS-Hx Series Sensor is designed to operate at 100% transmit duty-cycle in ambient temperature conditions of up to 50 C provided there is airflow across the back plate of the device. The RRS can also operate at 100% transmit duty-cycle in ambient temperature conditions of up to 35 C when mounted with the back-plate flush against a horizontal surface.

The RRS-Sensor can operate at higher ambient temperature conditions by autonomously controlling the transmit duty-cycle. However, once the internal microprocessor reaches a temperature of 104 C, the RRS software will shut down to prevent damage and memory corruption.

### 9.3.5 Power over Ethernet

Power over Ethernet (POE) is a mechanism for supplying power to network devices over the same cabling used to carry network traffic. POE allows the RRS to receive both power and data over a single cable. This feature simplifies network installation and maintenance by using an Ethernet switch with integrated POE as a central power source for all RRSs. The challenge during installation is to calculate the total power consumption required making sure it is less than the power budget of the Ethernet switch. The Juniper EX2200-24P-4G is a recommended switch for RRS networks due to its remote manageability and sufficient 400W power budget to provide POE for an RRS on each of the 24 ports. However, any 48V POE+ switch is sufficient.



## 9.3.6 Cabling, Mounting and Antenna Consideration for the H1000 models

### 9.3.6.1 Antenna Cabling Infrastructure

Poorly or incorrectly installed RFID Antenna cabling can cause problems with the RRS-H1000. Even a small kink in the cable can cause an impedance mismatch resulting in poor tag read performance. Always be sure to follow the instructions provided by the antenna manufacturer.

### 9.3.6.2 Recommended Antennas

This device has been designed to operate with the antennas listed below, and having a maximum gain of 6 dB. Antennas not included in this list or having a gain greater than 6 dB are strictly prohibited for use with this device. The required antenna impedance is 50 ohms.

Ce dispositif a été désigné pour fonctionner avec les antennes énumérées ci-dessous, et ayant un gain maximum de 6 dB. Les antennes non incluses dans cette liste ou ayant un gain plus grand que 6 dB sont strictement interdites pour l'utilisation avec cet appareil. L'antenne requise impédance est 50 ohms.

#### 9.3.6.2.1 Ceiling or Wall Mount

For ceiling or wall mount installations, the Laird RFID Panel Antenna S8655P (ETSI) or S9025P (FCC) is recommended. These antennas have a circularly polarized pattern and provide 5.5 dBi gain.



Figure 17 Circular Polarized Panel Antenna



### 9.3.6.2.2 Tabletop Point-of-Sale (POS)

For Point-of-Sale (POS) installations, the Times-7 RFID Near-Field Antenna A1030 is recommended. The A1030 antenna offers outstanding near field performance in a unique and optimized footprint, improving workflow and eliminating stray tag reads. These antennas have a circularly polarized pattern and have -15.0 dBi gain.



Figure 18 Near Field POS Antenna

### 9.3.6.3 Proper RF Cable Type

The type and length of coax cable can greatly affect the tag read performance of the installation. RF performance (aka read range) is determined by a combination of transmit power, receive sensitivity, cable losses, antenna gain and tag type. For a given RFID reader and tag, the variables to consider during installation are cable losses and antenna gain. The longer the cable, the greater the loss. If longer coax cable runs are required, a larger diameter, lower loss cable type should be used to mitigate the losses due to the increased length. Table 4 Cable Loss Chart is provided for common coax cables used for RFID installations

Length (ft)	LMR-195	LMR-240	LMR-400	LMR-600
5	0.6 dB	0.4 dB	0.2 dB	0.1 dB
10	1.1 dB	0.8 dB	0.4 dB	0.3 dB
25	2.8 dB	1.9 dB	1.0 dB	0.6 dB



### 9.3.6.4 Power Output Calculations

One of the parameters in the “apply\_behavior” command from the RFID Gateway is the output power level. This level can be adjusted from 0 to 27.03 dBm. To ensure compliance with the maximum EIRP restrictions defined in the certification grant, these commands must be scripted by an authorized installer or system integrator.

The maximum power level is a function of the antenna gain and the cable/connector losses as shown in the equation below.

$$P_{out} + G_{ant} - L_{cable} < EIRP_{limit}$$

The table below shows the maximum power level allowed for the various types of antennas, including the two recommended in this section.

EIRP Limit (dBm)	Ant Gain (dB)	Cable Loss (dB)	Max Power Level	Cable and Connector detail
36	9	0.5	27.5	1 m of RG-400 (teflon) R-SMA and TNC connectors
36	9	3.1	30.1	10 m of RG-400 (teflon) R-SMA and TNC connectors
36	7	1.1	30.1	3 m of RG-400 (teflon) R-SMA and TNC connectors
36	5.5	0.5	31.0	1 m of RG-178 (teflon) R-SMA and TNC connectors
36	-10	0.5	27.03	16 cm of RG-178 (teflon) R-SMA and TNC connectors

## 9.4 Connectivity

### 9.4.1 Physical

Figure 10 shows all the physical components of an in-store RFID network deployment and how they would be connected to one another.

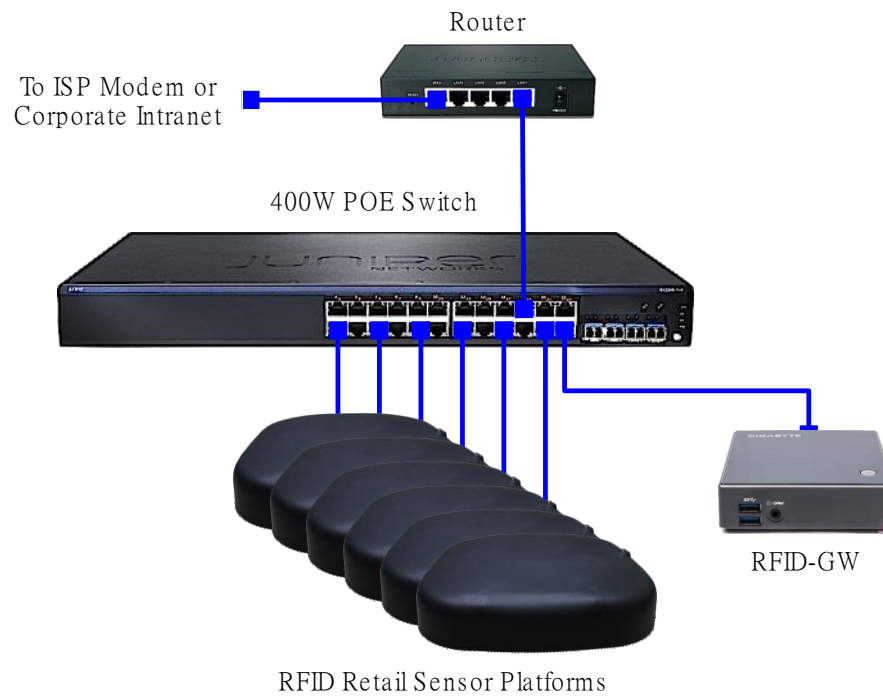

**Figure 19 Physical In-Store Connectivity**



## 9.4.2 Network

Certain firewall rules may be necessary for proper functionality of the system. In addition to a more traditional network diagram, [錯誤! 找不到參照來源。](#) shows a list of domains, protocols and ports that the RRS requires access to for proper functionality of the system.

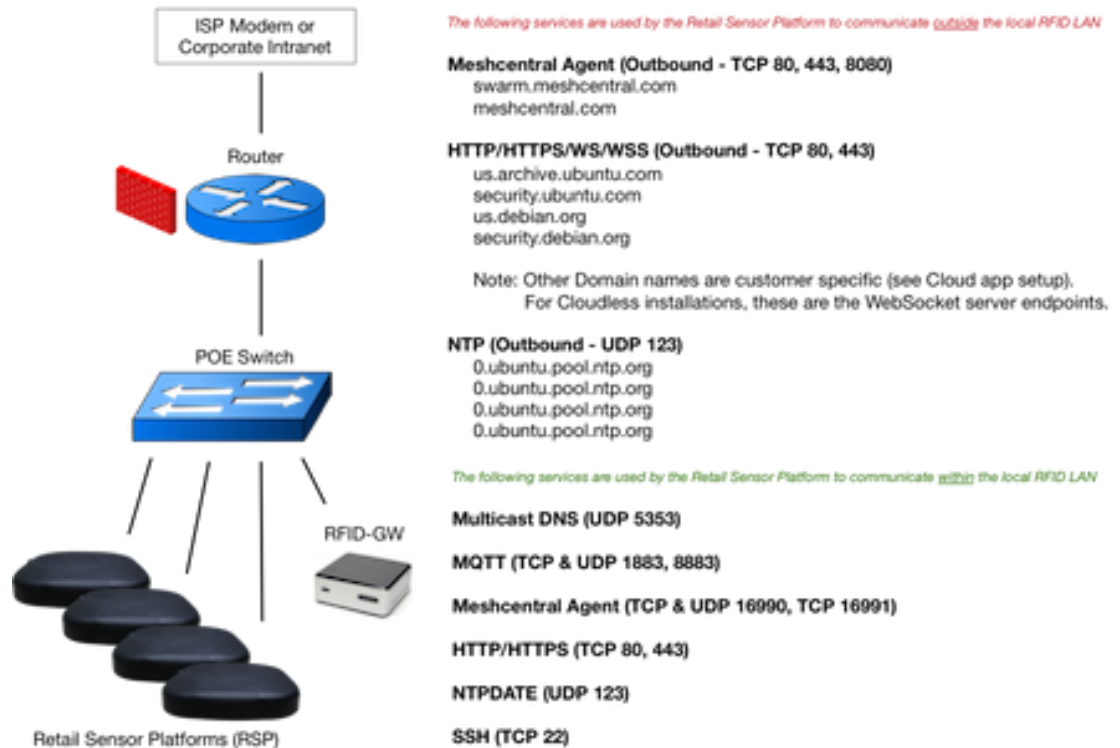

Figure 20 Network Diagram with IP Port Identification

## 9.5 Mounting (H4000 and H3000)

The typical Retail RFID installation will require the RRS sensors to be mounted from the ceiling. A common mounting technique is to utilize existing track-light rails. Figure 13 shows how the RRS can blend in with the actual lights mounted to the same rail.

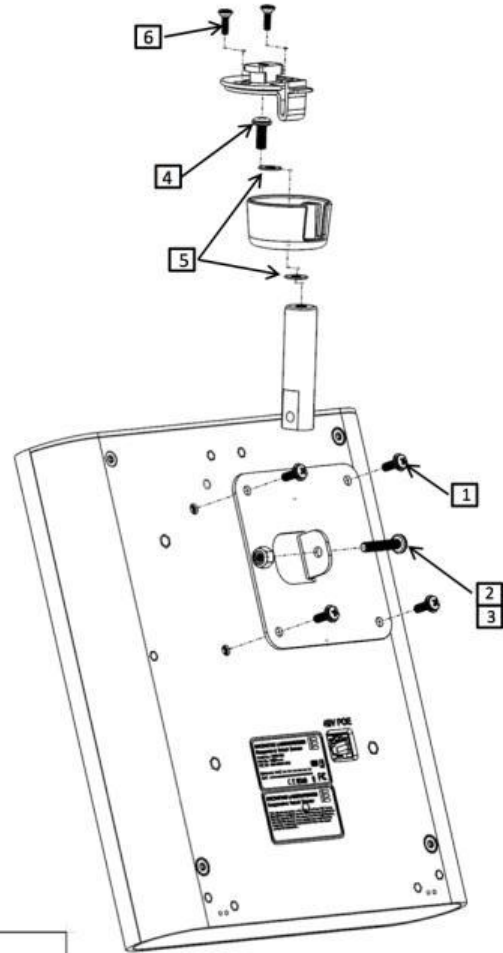
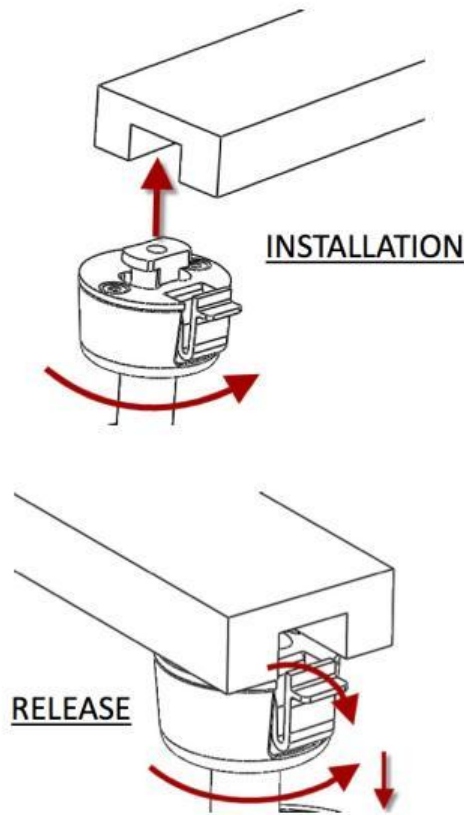

**Figure 21 RRS-H4000 Stealth**



## 9.5.1 Track Light Mounting Bracket

Encinitas Labs provides a mounting bracket that allows the SENSOR to be mounted from a track light rail. (see Figure 14)



Hardware Legend		
Item	Qty	Description
1	4	Screw, M4 x 12mm L, w/ captive washer, PH, Phil Drive
2	1	Screw, 10-32 x 1" L, PH, Phil Drive
3	1	Nut, 10-32 with nylon locking
4	1	Screw, 10-32 x .5" L with nylon patch, PH, Phil Drive
5	2	Washer, #10, Nylon
6	2	Screw, M3.5 x 12mm L, Flat Head, Torx 15 Drive

**ASSEMBLY DIAGRAM**

**Figure 22 H4000/H3000 Track Light Mount Assembly**



## 9.5.2 Wall Mounting Bracket

Encinitas Labs provides a mounting bracket that allows the sensor to be mounted to a flat surface (see Figure 15).

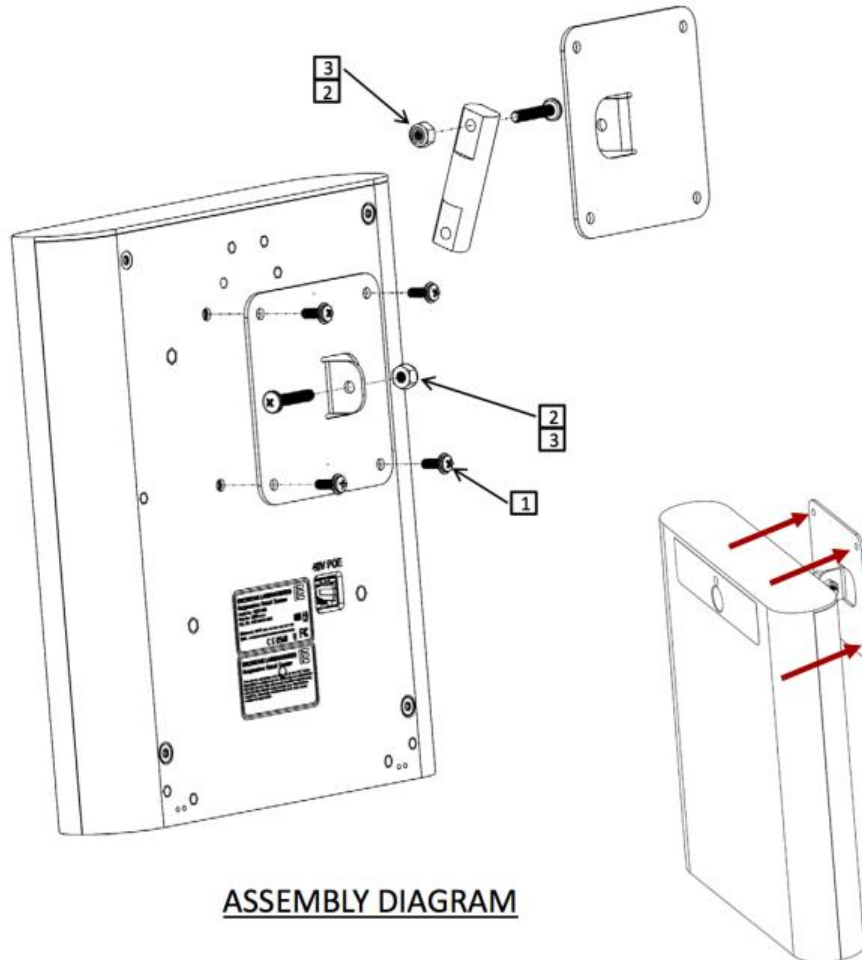

**ASSEMBLY DIAGRAM**

Hardware Legend		
Item	Qty	Description
1	4	Screw, M4 x 12mm L, w/ captive washer, PH, Phil Drive
2	2	Screw, 10-32 x 1" L, PH, Phil Drive
3	2	Nut, 10-32 with nylon locking

Install onto mounting surface using Customer supplied hardware, 4x.

**Figure 23 H4000/H3000 Wall Mount Assembly**



## 9.6 Mounting (H1000)

In a typical RRS-H1000 installation, the sensor can be mounted vertically in the case of portal over a doorway or horizontally under a table in the case of “point-of-sale”. The RRS-H1000 is mounted using the plate provided (see Figure 24)

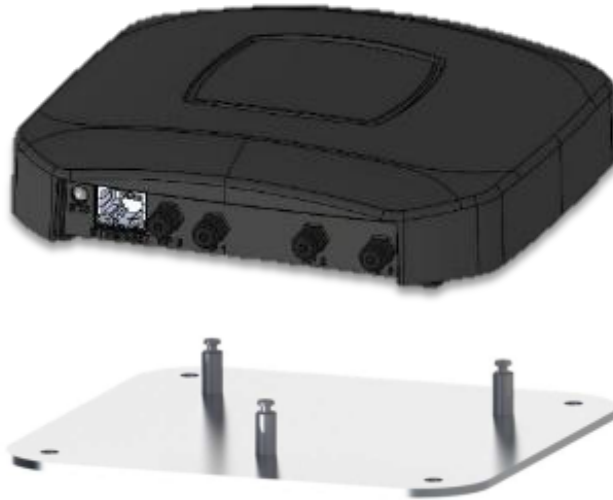

**Figure 24 H1000 Mounting Plate**

If at all practical or possible, the RRS-H1000 should be mounted onto a vertical surface for the best possible convection cooling. The device should not be mounted in a way that blocks air flow between the unit and the mounting plate and the device should be mounted in a way to allow free air flow for passive cooling.