



FCC RADIO TEST REPORT

Applicant : Sariana LLC

Address : 7365 Mission Gorge Road, Suite G, San Diego , CA 92120, USA

Equipment : 3-in-1 Foldable Qi2 Wireless Charging Stand

Model No. : ST-Q31FM, ST-Q31FM-EA, ST-Q31FM-AP,
CT-Q31FM, CT-Q31FM-EA, CT-Q31FM-AP

Trademark : S A T E C H I

FCC ID : ZE9-ST-Q31FM

I HEREBY CERTIFY THAT:

The sample was received on Jan. 25, 2024 and the test items were conducted during Feb. 5, 2024 ~ Feb. 20, 2024 at CerpPASS Technology Corp. The test result refers exclusively to the test presented test model / sample. Without written approval of CerpPASS Technology Corp., the test report shall not be reproduced except in full.

Approved by:

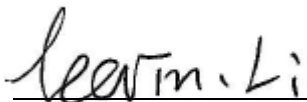

Leevin Li / Supervisor



Contents

1. Report of Measurements and Examinations	4
1.1 List of Measurements and Examinations	4
2. Test Configuration of Equipment under Test	5
2.1 Feature of Equipment under Test.....	5
2.2 Description of the test mode	6
2.3 Description of Test System.....	8
2.4 General Information of Test.....	9
2.5 Measurement Uncertainty	9
3. Test Equipment and Ancillaries Used for Tests	10
4. Antenna Requirements	11
4.1 Standard Applicable	11
4.2 Antenna Construction.....	11
4.3 Result	11
5. Test of Conducted Emission	12
5.1 Test Limit	12
5.2 Test Procedures	12
5.3 Typical Test Setup	13
5.4 Test Result and Data.....	14
6. Test of Radiated Emission	16
6.1 Test Limit	16
6.2 Test Procedures.....	17
6.3 Typical Test Setup	18
6.4 Test Result and Data	19
7. 20dB Bandwidth	29
7.1 Test Limit	29
7.2 Test Procedures.....	29
7.3 Typical Test Setup	29
7.4 Test Result and Data	30



History of this test report

Original.

Additional attachment as following record:

Attachment No.	Issue Date	Description
DEFC24010156	Feb. 29, 2024	Initial Issue



1. Report of Measurements and Examinations

1.1 List of Measurements and Examinations

FCC CFR Title 47 Part 15 Subpart C Section 15.209

FCC Rule	Description of Test	Result
§ 15.203	. Antenna Requirement	Pass
§ 15.207(a)	. Conducted Emission	Pass
§ 15.209(a)	. Radiated Emission	Pass
§ 15.215	20dB Bandwidth	Pass

Note: Deviations Yes No
*The lab has reduced the uncertainty risk factor from test equipment, environment and staff technicians which according to the standard on contract. Therefore, the test result will only be determined by standard requirement.



2. Test Configuration of Equipment under Test

2.1 Feature of Equipment under Test

Product	3-in-1 Foldable Qi2 Wireless Charging Stand
Test Model	ST-Q31FM, ST-Q31FM-EA, ST-Q31FM-AP, CT-Q31FM, CT-Q31FM-EA, CT-Q31FM-AP
Model Discrepancy	All the models are identical except for model names, adapter plugs and sales companies. ST-Q31FM and CT-Q31FM are not equipped with adapter plugs. ST-Q31FM-EA and CT-Q31FM-EA are equipped with European and British adapter plugs. ST-Q31FM-AP and CT-Q31FM-AP are equipped with Korean and Australian adapter plugs. ST and CT represent different sales companies.
Frequency Range	Output Wireless 1: MPP: 360KHz, BPP: 120~148.5KHz Output Wireless 2: 110KHz~148KHz Output Wireless 3 (Apple Watch): 326.5KHz and 1.778MHz
Antenna Type	Coil Antenna
Modulation Type	Output Wireless 1: ASK Output Wireless 2: ASK Output Wireless 3: ASK
Power Rating	Input: 9V 3A/12V 3A/15V 3A, 45W(Max) Output Wireless 1: 15W(Max)/Qi MPP; 5W (Max)/Qi BPP Output Wireless 2: 5W(Max)/Qi BPP Output Wireless 3(Apple Watch): 5W(Max)
Temperature	Operating Temp: 0°C~+35°C Storage Temp: -20°C~+60°C

Note: For more details, please refer to the User's manual of the EUT.



2.2 Description of the test mode

To investigate the maximum EMI emission characteristics generates from EUT, the test system was pre-scanning tested base on the consideration of following EUT operation mode or test configuration mode which possible have effect on EMI emission level. Each of these EUT operation mode(s) or test configuration mode(s) mentioned above was evaluated respectively.

The EUT was tested under the following modes, the worst mode was recorded in this report.

For Conducted Emission	
Pre-tested Mode:	Description
Mode 1	Wireless Charging for Wireless 1(Standby mode) +Wireless 2(Standby mode) + Wireless 3(Standby mode) for 120V
Mode 2	Wireless Charging for Wireless 1(15W for Wireless Load, Operating @ MPP 360KHz) +Wireless 2(5W for AirPods) +Wireless 3(5W for Apple watch 3, Operating @326.5KHz) for 120V
Mode 3	Wireless Charging for Wireless 1(5W for Wireless Load, Operating @ BPP: 120~148.5KHz) +Wireless 2(5W for AirPods) +Wireless 3(5W for Apple watch 7, Operating @1.778MHz) for 120V
Mode 4	Wireless Charging for Wireless 1(15W for Wireless Load, Operating @ MPP 360KHz) +Wireless 2(5W for AirPods) +Wireless 3(5W for Apple watch 7, Operating @1.778MHz) for 120V
Mode 5	Wireless Charging for Wireless 1(5W for Wireless Load, Operating @ BPP: 120~148.5KHz) +Wireless 2(5W for AirPods) +Wireless 3(5W for Apple watch 3, Operating @326.5KHz) for 120V
Mode 6	Wireless Charging for Wireless 1(15W for Wireless Load, Operating @ MPP 360KHz) +Wireless 2(5W for AirPods) +Wireless 3(5W for Apple watch 3, Operating @326.5KHz) for 240V
Worst test Mode	Description
Mode 6	Wireless Charging for Wireless 1(15W for Wireless Load, Operating @ MPP 360KHz) +Wireless 2(5W for AirPods) +Wireless 3(5W for Apple watch 3, Operating @326.5KHz) for 240V
For Radiated Emission	
Pre-tested Mode:	Description
Mode 1	Wireless Charging for Wireless 1(Standby mode) +Wireless 2(Standby mode) + Wireless 3(Standby mode)
Mode 2	Wireless Charging for Wireless 1(15W for Wireless Load, Operating @ MPP 360KHz) +Wireless 2(5W for AirPods) +Wireless 3(5W for Apple watch 3, Operating @326.5KHz)
Mode 3	Wireless Charging for Wireless 1(5W for Wireless Load, Operating @ BPP: 120~148.5KHz) +Wireless 2(5W for AirPods) +Wireless 3(5W for Apple watch 7, Operating @1.778MHz)
Mode 4	Wireless Charging for Wireless 1(15W for Wireless Load, Operating @ MPP 360KHz) +Wireless 2(5W for AirPods) +Wireless 3(5W for Apple watch 7, Operating @1.778MHz)
Mode 5	Wireless Charging for Wireless 1(5W for Wireless Load, Operating @ BPP: 120~148.5KHz) +Wireless 2(5W for AirPods) +Wireless 3(5W for Apple



	watch 3, Operating @326.5KHz)
Worst test Mode	For Radiated Emission (9KHz-30MHz) : Description
Mode 2	Wireless Charging for Wireless 1(15W for Wireless Load, Operating @ MPP 360KHz) +Wireless 2(5W for AirPods) +Wireless 3(5W for Apple watch 3, Operating @326.5KHz)
Mode 3	Wireless Charging for Wireless 1(5W for Wireless Load, Operating @ BPP: 120~148.5KHz) +Wireless 2(5W for AirPods) +Wireless 3(5W for Apple watch 7, Operating @1.778MHz)
Worst test Mode	For Radiated Emission (30MHz-1GHz) : Description
Mode 2	Wireless Charging for Wireless 1(15W for Wireless Load, Operating @ MPP 360KHz) +Wireless 2(5W for AirPods) +Wireless 3(5W for Apple watch 3, Operating @326.5KHz)

Note:

a: While charging, client devices were between 20% to 50% state of charge.

b: The EUT Have three coils, the specific location is shown below:

Wireless 1 for Qi2
Magnetic Wireless
Charger (15W/Qi MPP;
5W/Qi BPP)

Wireless 2 for
AirPods(5W
Max)



Wireless 3 for
Apple watch(5W)



2.3 Description of Test System

Product	Manufacturer	Model No.	Power Cord
1 Adapter	Xinspower	PN453I	N/A
2 Apple watch	Apple	Apple watch 7	N/A
3 Apple watch	Apple	Apple watch 3	N/A
4 Wireless Load	N/A	N/A	N/A
5 Air pods	Apple	A2190	N/A

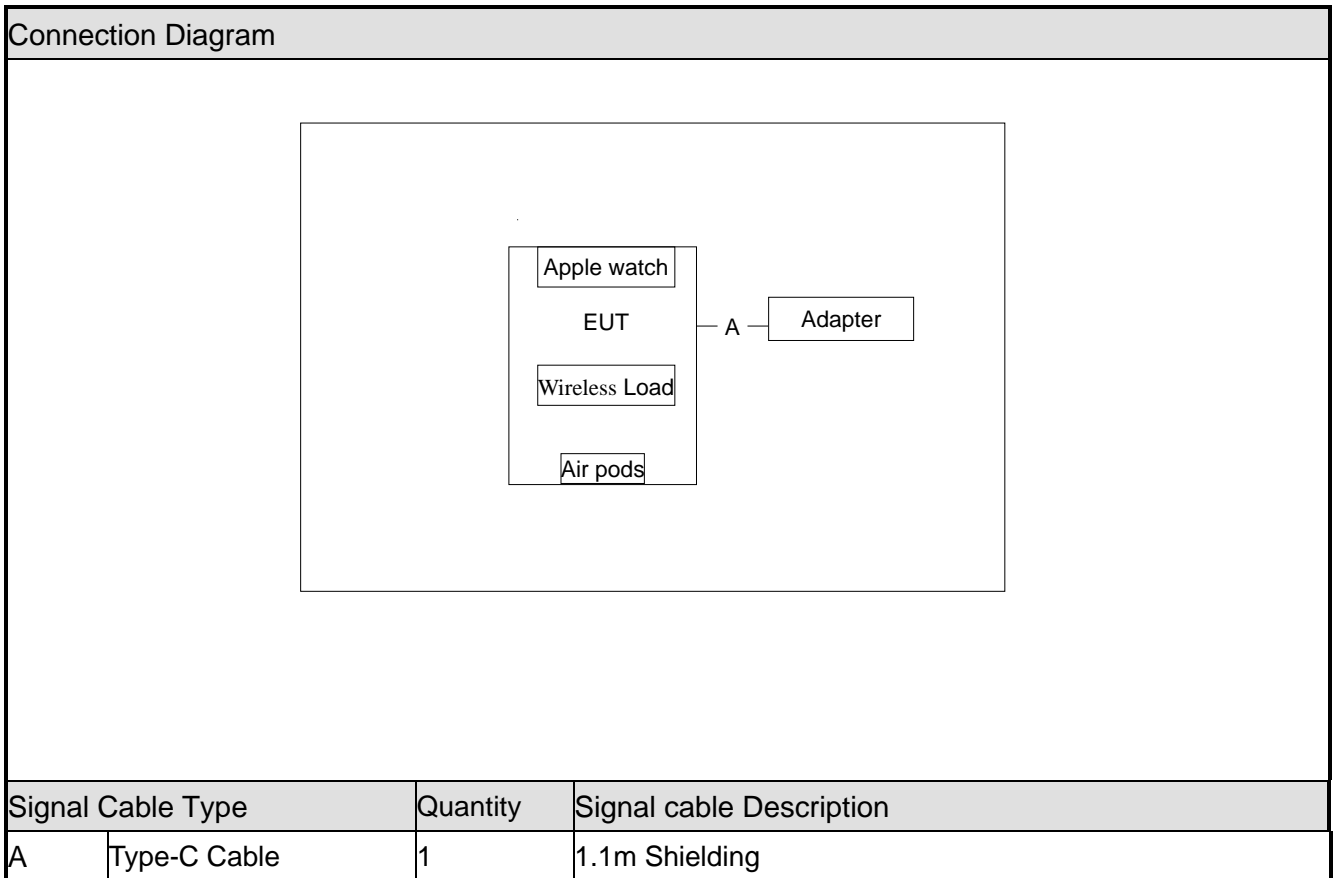



2.4 General Information of Test

Test Site	CerpPASS Technology Corporation(CerpPASS Laboratory) Address: Room 102, No. 5, Xing'an Road, Chang'an Town, Dongguan City, Guangdong Province Tel: +86-769-8547-1212 Fax: +86-769-8547-1912
FCC Designation No.:	CN1288
Frequency Range Investigated:	Conducted: from 150kHz to 30 MHz Radiation: from 9kHz to 40,000MHz
Test Distance:	9KHz~30MHz: radiated emission from antenna to EUT is 3 M. 30MHz~1GHz: radiated emission from antenna to EUT is 3 M.

Test Item	Test Site	Test period	Environmental Conditions	Tested By
Radiated Emissions	3M01-DG	2024/02/05~2024/02/20	22~24°C / 53~54%	Amos Zhang
AC Power Line Conducted Emission	CON01-DG	2024/02/05	24°C / 57%	Amos Zhang

2.5 Measurement Uncertainty

Measurement Item	Uncertainty
AC Power Line Conduction(150K~30MHz)	±2.60dB
Radiated Spurious Emission(9KHz~30MHz)	±4.10dB
Radiated Spurious Emission(30MHz~1GHz)	±4.51dB
Radiated Spurious Emission(1GHz~18GHz)	±5.36dB
6dB Bandwidth&20dB Bandwidth	±4.8%



3. Test Equipment and Ancillaries Used for Tests

AC Power Line Conducted Emission					
Instrument/Ancillary	Manufacturer	Model No.	Serial No.	Calibration Date	Valid Date.
Test Receiver	R&S	ESCI	100564	2024/01/03	2025/01/02
LISN	SCHWARZBECK	NSLK 8127	8127749	2023/08/03	2024/08/02
LISN	R&S	ENV216	100024	2024/01/03	2025/01/02
Cable	Aoda	RG214	Cable-06	2024/01/03	2025/01/02
Pulse Limiter with 10dB Attenuation	SCHWARZBECK	VTSD 9561-F	9561-F106	2024/01/03	2025/01/02
Temperature/ Humidity Meter	GEMLEAD	STH200A	N/A	2023/08/03	2024/08/02

Radiated Emissions					
Instrument	Manufacturer	Model No.	Serial No.	Calibration Date	Valid Date
EMI Test Receiver	R&S	ESCI	100565	2023/08/03	2024/08/02
Amplifier	EMCI	EMC330	980082	2024/01/03	2025/01/02
Loop Antenna	R&S	HFH2-Z2	100150	2024/01/03	2026/01/02
Bilog Antenna	Sunol Science	JB1	A072414-3	2023/06/18	2025/06/17
Preamplifier	Agilent	8449B	3008A02342	2023/08/03	2024/08/02
Preamplifier	COM-POWER	PA-840	711885	2024/01/03	2025/01/02
Broad-Band Horn Antenna	Schwarzbeck	BBHA9120D	9120D-619	2024/01/03	2026/01/02
Standard Gain Horn Antenna	TRC	HA-2640	18050	2024/01/03	2026/01/02
Standard Gain Horn Antenna	TRC	HA-1726	18051	2024/01/03	2026/01/02
FSQ Signal Analyzer	R&S	FSQ40	200012	2024/01/03	2025/01/02
Cable	EMCI	EM104-NMS M-8.5M	Cable-03	2023/08/03	2024/08/02
Cable	Jiuzhoubona	T-SMA	SMA48AL-7000	2023/08/03	2024/08/02
Cable	CH-CoDesigh	CCXA40-2.92 -2.92-1M	21071954	2023/08/03	2024/08/02
Cable	CH-CoDesigh	CCX40-2.92M -2.92M-9M	21070892	2023/08/03	2024/08/02
Temperature/ Humidity Meter	GEMLEAD	STH200A	N/A	2023/08/03	2024/08/02



4. Antenna Requirements

4.1 Standard Applicable

For intentional device, according to FCC 47 CFR Section 15.203, an intentional radiator shall be designed to ensure that no antenna other than that furnished by the responsible party shall be used with the device.

4.2 Antenna Construction

The antenna is Coil Antenna, and the antenna connector is de-signed with permanent attachment and on consideration of replacement. Please see the EUT photo for details.

4.3 Result

The EUT antenna is Loop Antenna. It complies with the standard requirement.



5. Test of Conducted Emission

5.1 Test Limit

According to §15.207: For all the consumer devices which is designed to be connected to the public utility (AC) power line, the radio frequency voltage that is conducted back onto the AC power line on any frequency or frequencies within the band 150 kHz to 30 MHz shall not exceed 250 microvolts (The limit decreases linearly with the logarithm of the frequency in the range 0.15 MHz to 0.50 MHz). The limits at specific frequency range are listed as follows:

Frequency (MHz)	Quasi Peak (dB μ V)	Average (dB μ V)
0.15 – 0.5	66-56*	56-46*
0.5 – 5.0	56	46
5.0 – 30.0	60	50

Remark: (1)*Decreases with the logarithm of the frequency.

(2)The lower limit shall apply at the transition frequency.

5.2 Test Procedures

- The EUT was placed 0.4 meter from the conducting wall of the shielding room was kept at least 80 centimeters from any other grounded conducting surface.
- Connect EUT to the power mains through a line impedance stabilization network (LISN).
- All the support units are connecting to the other LISN.
- The LISN provides 50 ohm coupling impedance for the measuring instrument.
- The FCC states that a 50 ohm, 50 micro-Henry LISN should be used.
- Both sides of AC line were checked for maximum conducted interference.
- The frequency range from 150 kHz to 30 MHz was searched.
- Set the test-receiver system to Peak Detect Function and Specified Bandwidth with Maximum Hold Mode.



5.3 Typical Test Setup

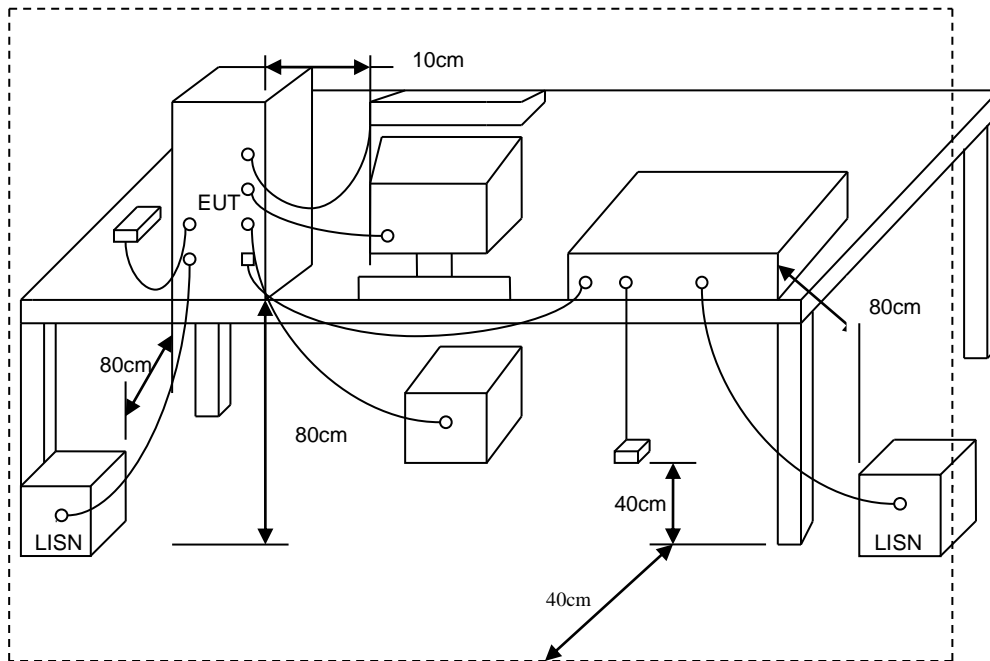



5.4 Test Result and Data

Test Mode :	Mode 6	Phase :	Line
Power :	AC 240V/60Hz		

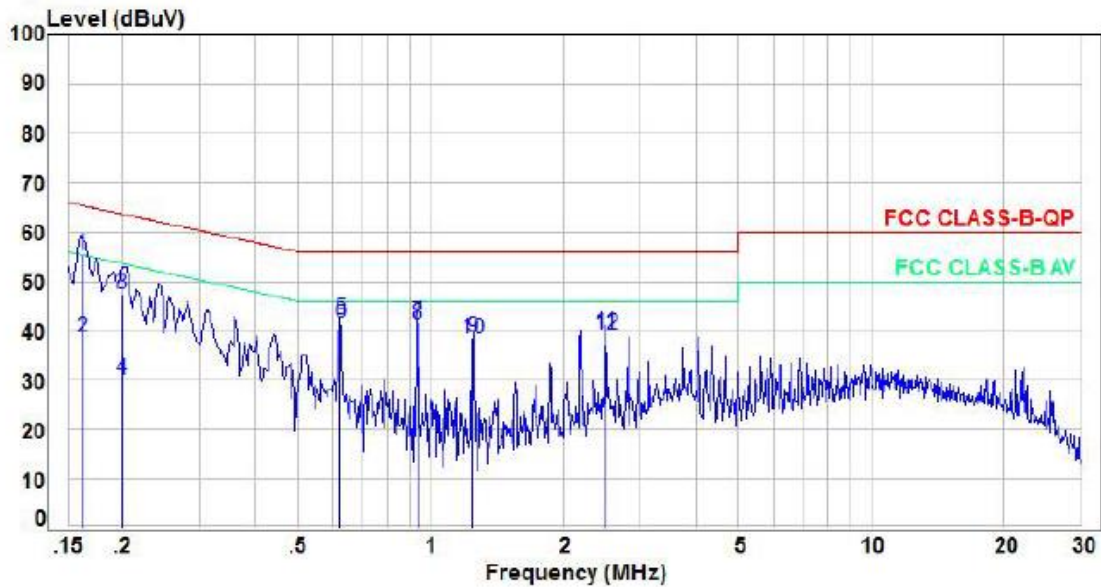

No.	Frequency (MHz)	Factor (dB)	Reading (dBuV)	Level (dBuV)	Limit (dBuV)	Margin (dB)	Detector	P/F
1	0.16	9.85	45.55	55.40	65.35	-9.95	QP	P
2	0.16	9.85	28.86	38.71	55.35	-16.64	Average	P
3	0.20	9.82	37.58	47.40	63.64	-16.24	QP	P
4	0.20	9.82	20.25	30.07	53.64	-23.57	Average	P
5	0.62	9.89	32.30	42.19	56.00	-13.81	QP	P
6	0.62	9.89	31.86	41.75	46.00	-4.25	Average	P
7	0.94	9.82	31.90	41.72	56.00	-14.28	QP	P
8	0.94	9.82	31.48	41.30	46.00	-4.70	Average	P
9	1.25	9.90	28.80	38.70	56.00	-17.30	QP	P
10	1.25	9.90	28.38	38.28	46.00	-7.72	Average	P
11	2.49	10.05	29.57	39.62	56.00	-16.38	QP	P
12	2.49	10.05	29.04	39.09	46.00	-6.91	Average	P

Site: CON01-DG

Note: Level=Reading+Factor

Margin=Level-Limit

Factor=(LISM or ISN or Current/Voltage Probe or Combining Network) Factor +Cabel loss



Test Mode :	Mode 6	Phase :	Neutral
Power :	AC 240V/60Hz		

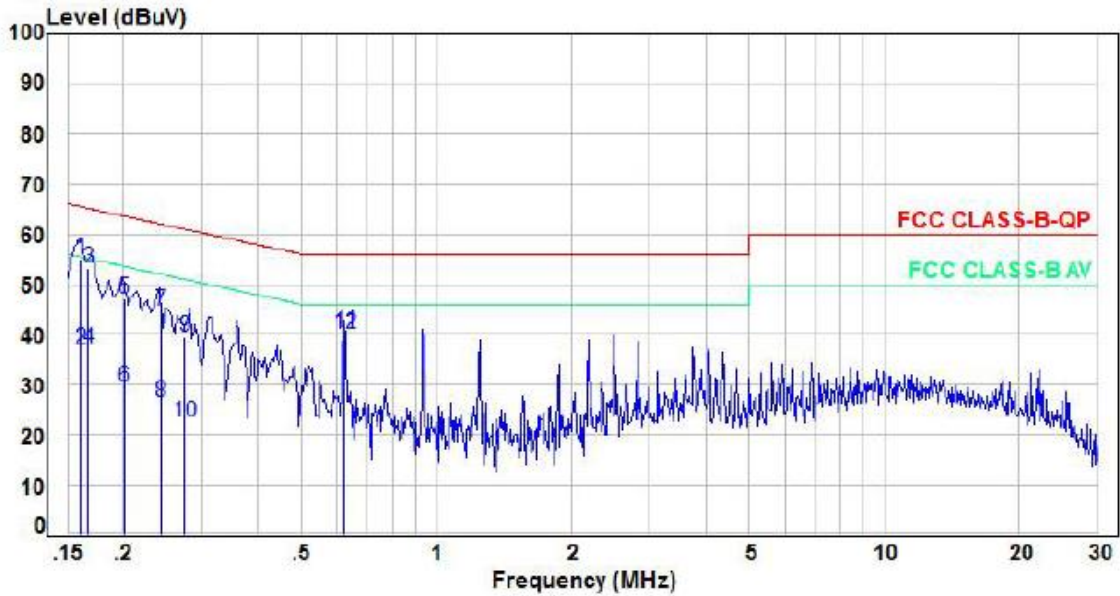

No.	Frequency (MHz)	Factor (dB)	Reading (dBuV)	Level (dBuV)	Limit (dBuV)	Margin (dB)	Detector	P/F
1	0.16	9.77	45.37	55.14	65.43	-10.29	QP	P
2	0.16	9.77	27.39	37.16	55.43	-18.27	Average	P
3	0.17	9.78	43.49	53.27	65.12	-11.85	QP	P
4	0.17	9.78	27.43	37.21	55.12	-17.91	Average	P
5	0.20	9.85	37.31	47.16	63.58	-16.42	QP	P
6	0.20	9.85	19.70	29.55	53.58	-24.03	Average	P
7	0.24	9.84	34.85	44.69	62.00	-17.31	QP	P
8	0.24	9.84	16.70	26.54	52.00	-25.46	Average	P
9	0.27	9.85	29.56	39.41	61.01	-21.60	QP	P
10	0.27	9.85	12.56	22.41	51.01	-28.60	Average	P
11	0.62	9.80	30.65	40.45	56.00	-15.55	QP	P
12	0.62	9.80	30.23	40.03	46.00	-5.97	Average	P

Site: CON01-DG

Note: Level=Reading+Factor

Margin=Level-Limit

Factor=(LISN or ISN or Current/Voltage Probe or Combining Network) Factor +Cabel loss



6. Test of Radiated Emission

6.1 Test Limit

In any 100kHz bandwidth outside the frequency band, the radio frequency power produced by According to §15.209(a), for a intentional device, the general requirement of field strength of radiated emissions from intentional radiators at a distance of 3 meters shall not exceed the following values:

Radiated Emission Limit (9KHz~1000MHz)

FREQUENCIES(MHz)	FIELD STRENGTH(microvolts/meter)	MEASUREMENT DISTANCE(meters)
0.009~0.490	2400/F(kHz)	300
0.490~1.705	24000/F(kHz)	30
1.705~30.0	30	30
30~88	100	3
88~216	150	3
216~960	200	3
Above 960	500	3

Note:

- (1) The tighter limit applies at the band edges.
- (2) Emission Level (dBuV/m)=20log Emission Level(uV/m)



6.2 Test Procedures

- a. The EUT was placed on a rotatable table top 0.8 meter above ground.
- b. The EUT was set 1/3 meters from the interference receiving antenna which was mounted on the top of a variable height antenna tower.
- c. The table was rotated 360 degrees to determine the position of the highest radiation.
- d. The antenna is a broadband antenna and its height is varied between one meter and four meters above ground to find the maximum value of the field strength both horizontal polarization and vertical polarization of the antenna are set to make the measurement.
- e. For each suspected emission the EUT was arranged to its worst case and then tune the antenna tower (from 1 M to 4 M) and turn table (from 0 degree to 360 degrees) to find the maximum reading.
- f. Set the test-receiver system to Peak or CISPR quasi-peak Detect Function and specified bandwidth with Maximum Hold Mode.
- g. If the emission level of the EUT in peak mode was 3 dB lower than the limit specified, then testing will be stopped and peak values of EUT will be reported, otherwise, the emissions which do not have 3 dB margin will be repeated one by one using the quasi-peak method and reported.
- h. For testing above 1GHz, the emission level of the EUT in peak mode was 20dB lower than average limit (that means the emission level in peak mode also complies with the limit in average mode), then testing will be stopped and peak values of EUT will be reported, otherwise, the emissions will be measured in average mode again and reported.



6.3 Typical Test Setup

Below 30MHz Test Setup

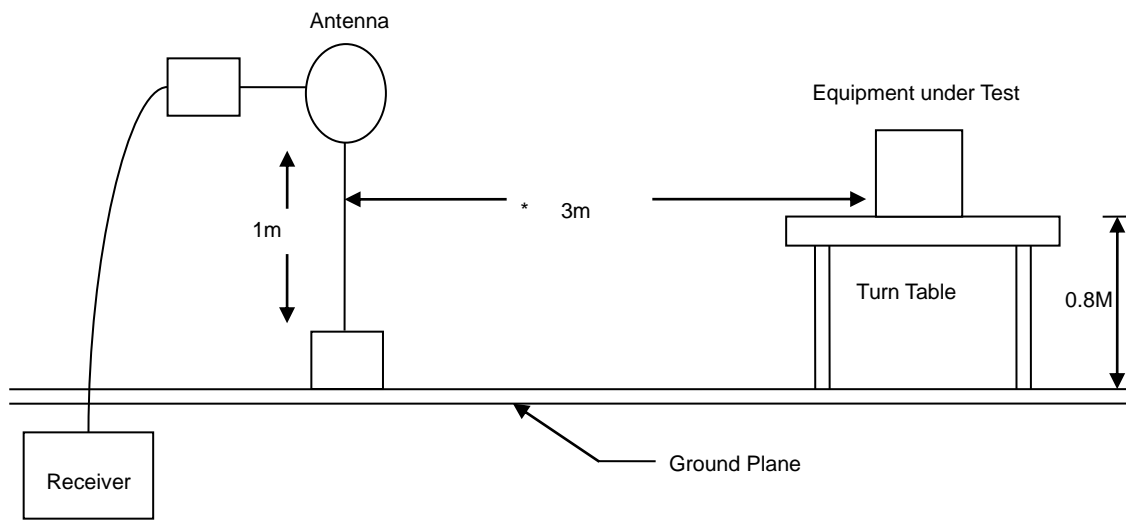

30M - 1GHz Test Setup

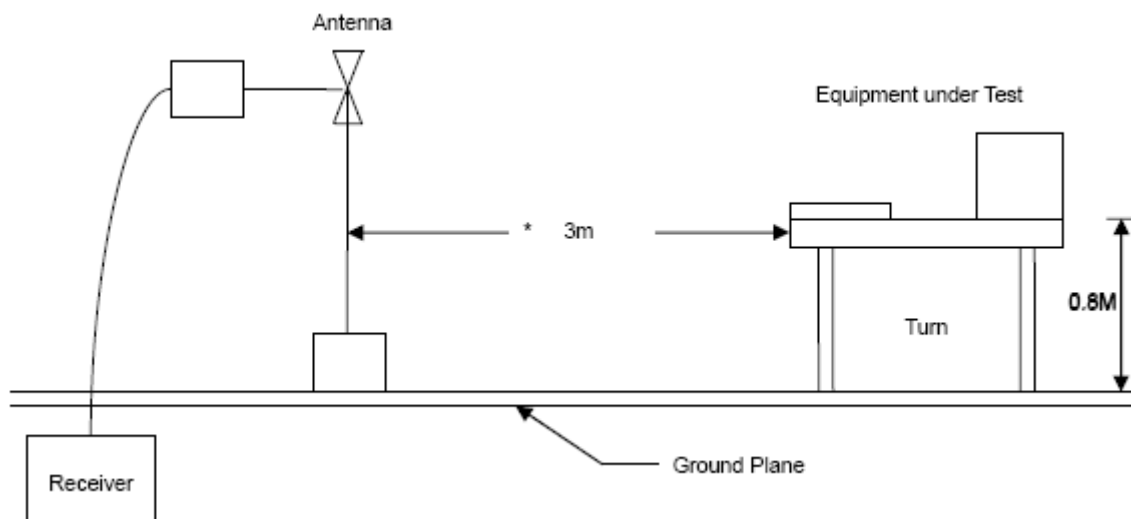



6.4 Test Result and Data

For 9KHz~30MHz

Test Mode	: Mode 2	Polarization	: X
Power	: AC 120V/60Hz	Frequency range	9KHz-150KHz

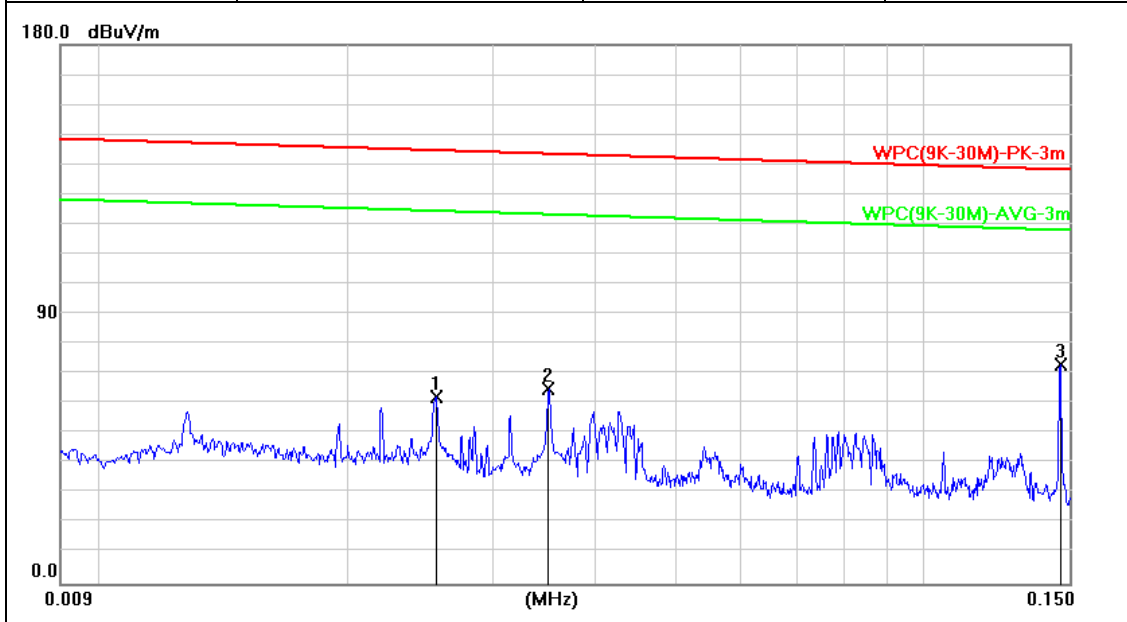

No.	Frequency (MHz)	Factor (dB/m)	Reading (dBuV)	Level (dBuV/m)	Limit (dBuV/m)	Margin (dB)	Det.
1	0.0256	20.64	41.69	62.33	119.44	-57.11	AVG
2	0.0350	20.78	44.36	65.14	116.72	-51.58	AVG
3	0.1461	20.14	52.85	72.99	104.31	-31.32	AVG

Note: Level = Reading + Factor
Margin = Level – Limit
Factor= Antenna Factor + Cable Loss - Amplifier Factor



Test Mode	: Mode 2	Polarization	: X
Power	: AC 120V/60Hz	Frequency range	: 150KHz-30MHz

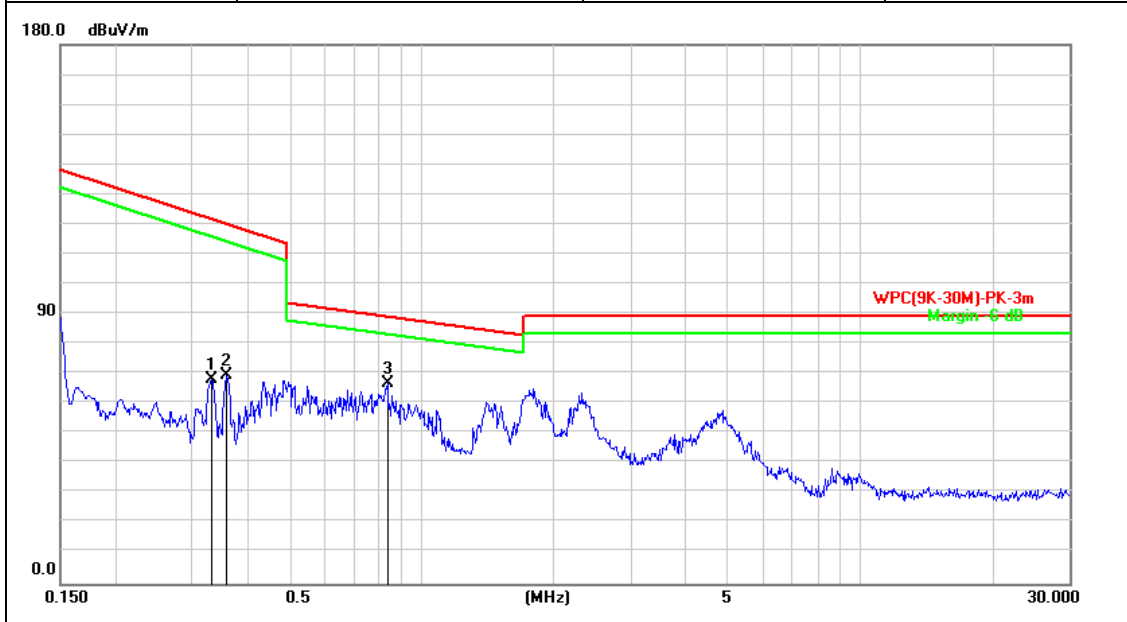

No.	Frequency (MHz)	Factor (dB/m)	Reading (dBuV)	Level (dBuV/m)	Limit (dBuV/m)	Margin (dB)	Det.
1	0.3265	20.52	47.83	68.35	97.33	-28.98	AVG
2	0.3596	20.58	48.74	69.32	96.49	-27.17	AVG
3	0.8346	20.77	45.84	66.61	69.17	-2.56	QP

Note: Level = Reading + Factor
Margin = Level – Limit
Factor= Antenna Factor + Cable Loss - Amplifier Factor

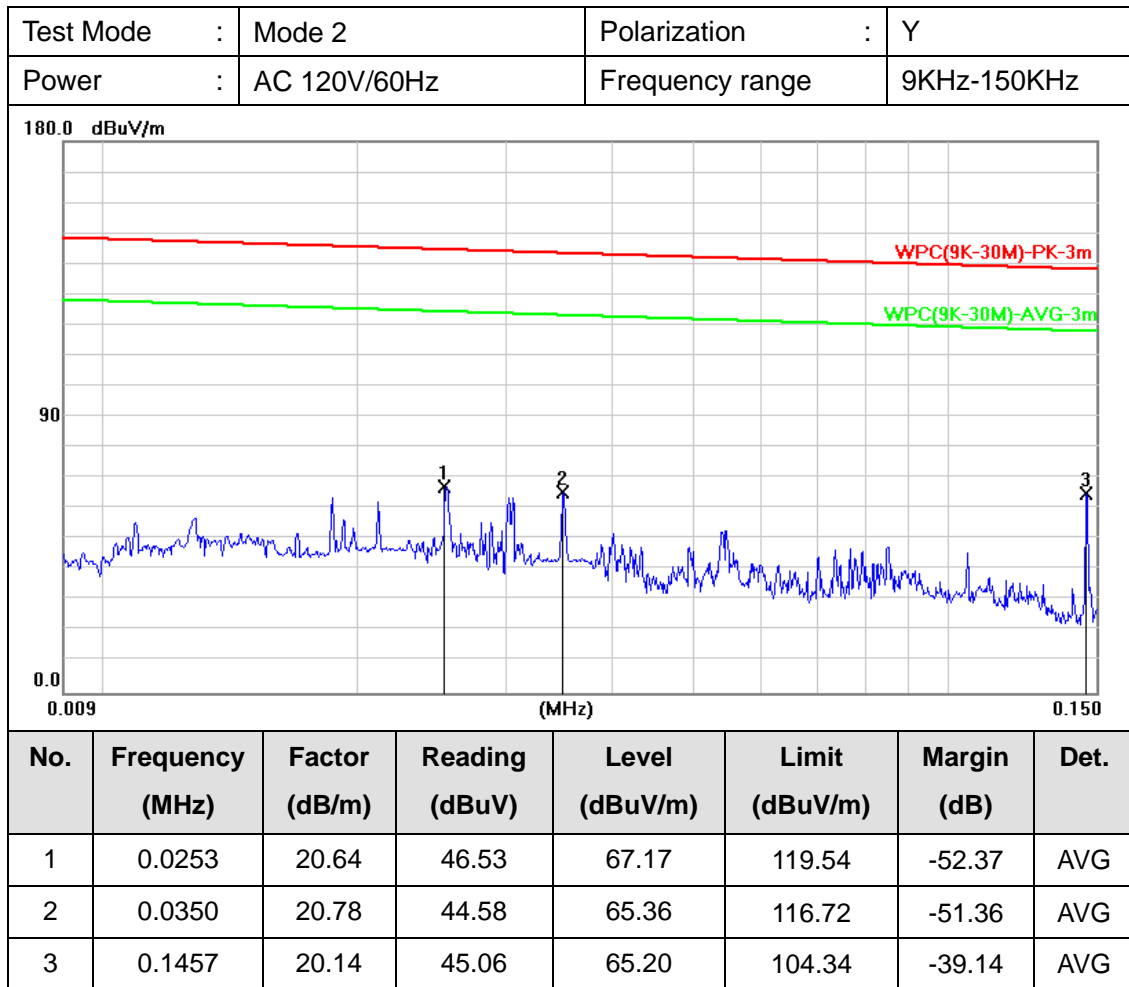

Note: Level = Reading + Factor
 Margin = Level – Limit
 Factor= Antenna Factor + Cable Loss - Amplifier Factor



Test Mode	: Mode 2	Polarization	: Y
Power	: AC 120V/60Hz	Frequency range	: 150KHz-30MHz

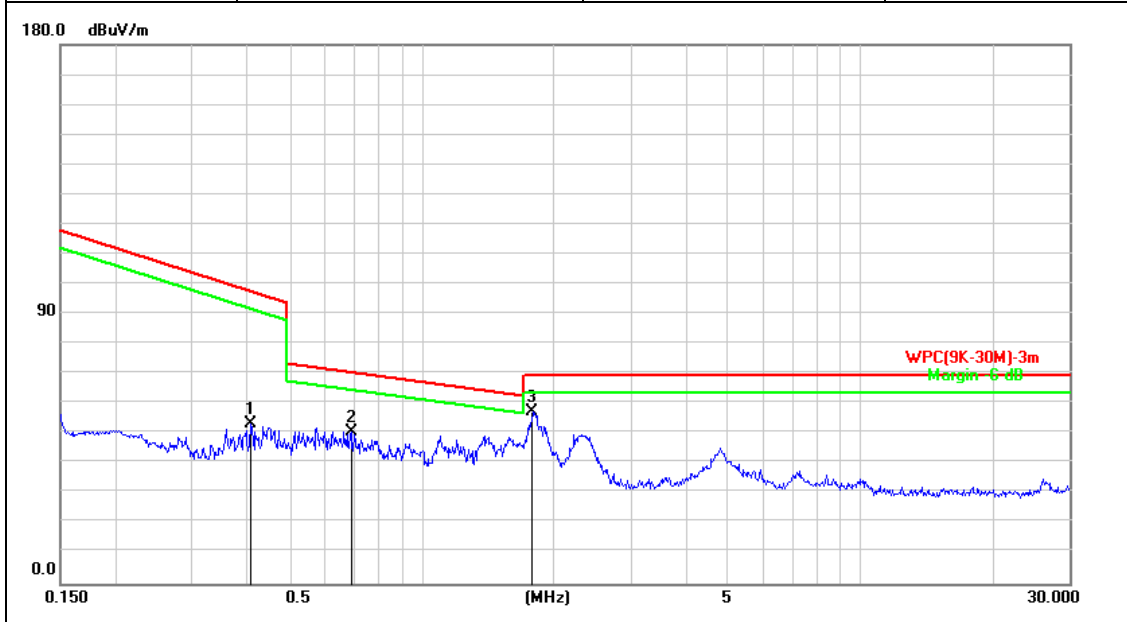

No.	Frequency (MHz)	Factor (dB/m)	Reading (dBuV)	Level (dBuV/m)	Limit (dBuV/m)	Margin (dB)	Det.
1	0.3265	20.51	45.67	66.18	97.33	-31.15	AVG
2	0.3596	20.58	53.98	74.56	96.49	-21.93	AVG
3	1.0264	20.70	43.12	63.82	67.38	-3.56	QP

Note: Level = Reading + Factor
Margin = Level – Limit
Factor= Antenna Factor + Cable Loss - Amplifier Factor



Test Mode	: Mode 3	Polarization	: X
Power	: AC 120V/60Hz	Frequency range	: 9KHz-150KHz

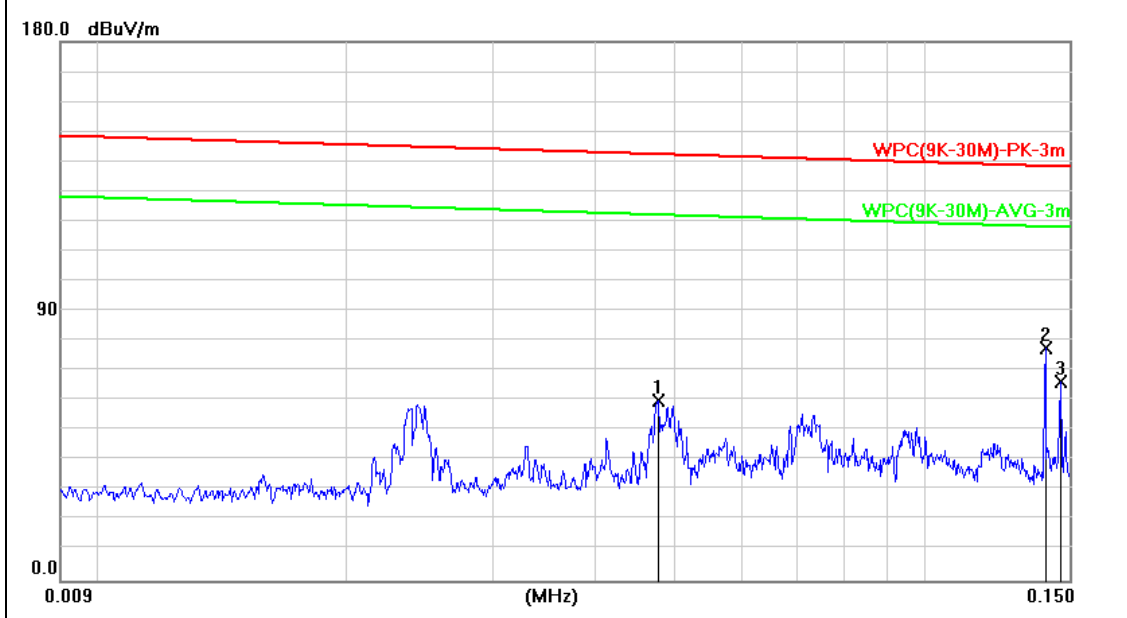

No.	Frequency (MHz)	Factor (dB/m)	Reading (dBuV)	Level (dBuV/m)	Limit (dBuV/m)	Margin (dB)	Det.
1	0.0476	21.22	39.02	60.24	114.05	-53.81	AVG
2	0.1402	20.20	57.53	77.73	104.67	-26.94	AVG
3	0.1462	20.14	46.38	66.52	104.31	-37.79	AVG

Note: Level = Reading + Factor
Margin = Level – Limit
Factor= Antenna Factor + Cable Loss - Amplifier Factor

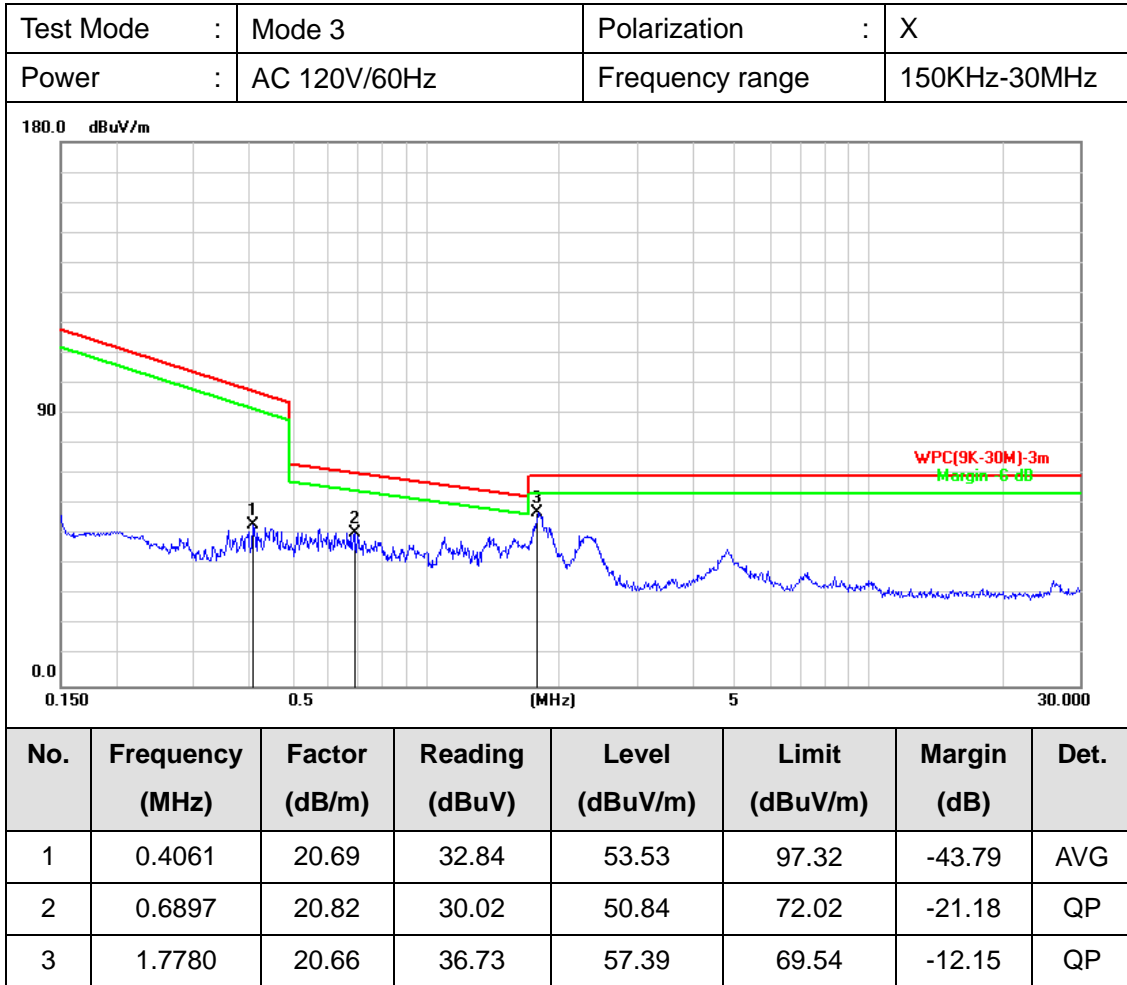

Note: Level = Reading + Factor
 Margin = Level – Limit
 Factor= Antenna Factor + Cable Loss - Amplifier Factor



Test Mode	: Mode 3	Polarization	: Y
Power	: AC 120V/60Hz	Frequency range	: 9KHz-150KHz

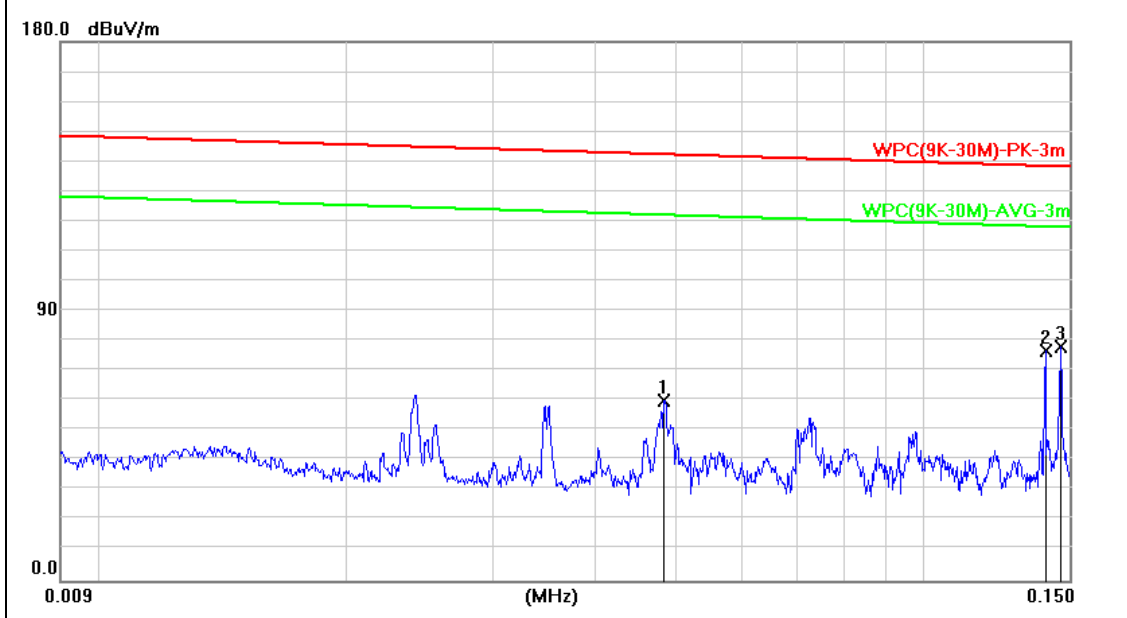

No.	Frequency (MHz)	Factor (dB/m)	Reading (dBuV)	Level (dBuV/m)	Limit (dBuV/m)	Margin (dB)	Det.
1	0.0483	21.24	38.92	60.16	113.93	-53.77	AVG
2	0.1402	20.20	56.67	76.87	104.67	-27.80	AVG
3	0.1462	20.14	57.86	78.00	104.31	-26.31	AVG

Note: Level = Reading + Factor
Margin = Level – Limit
Factor= Antenna Factor + Cable Loss - Amplifier Factor

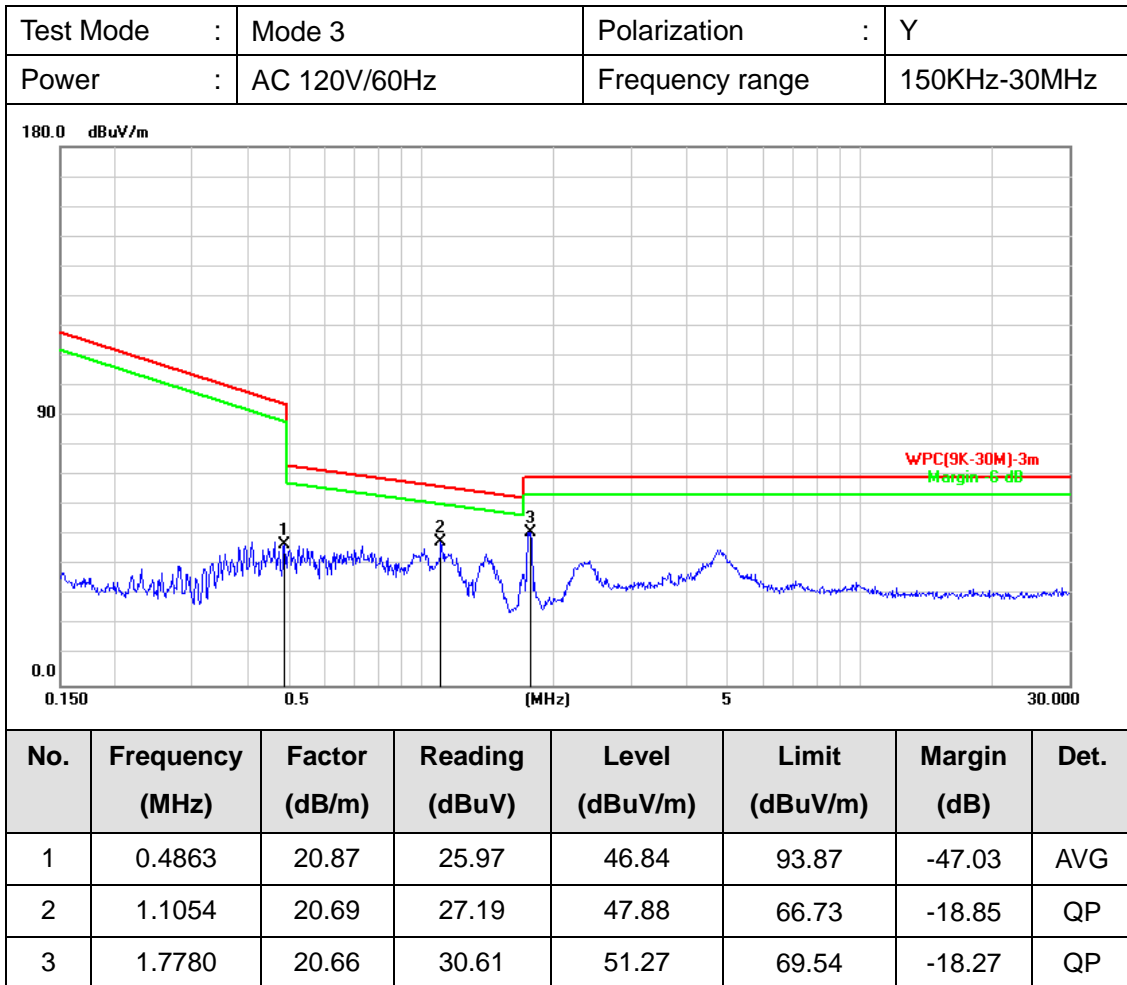

Note: Level = Reading + Factor
 Margin = Level – Limit
 Factor= Antenna Factor + Cable Loss - Amplifier Factor



For 30MHz~1GHz

Test Mode	: Mode 2	Pol/Phase	: VERTICAL
Power	: AC 120V/60Hz		

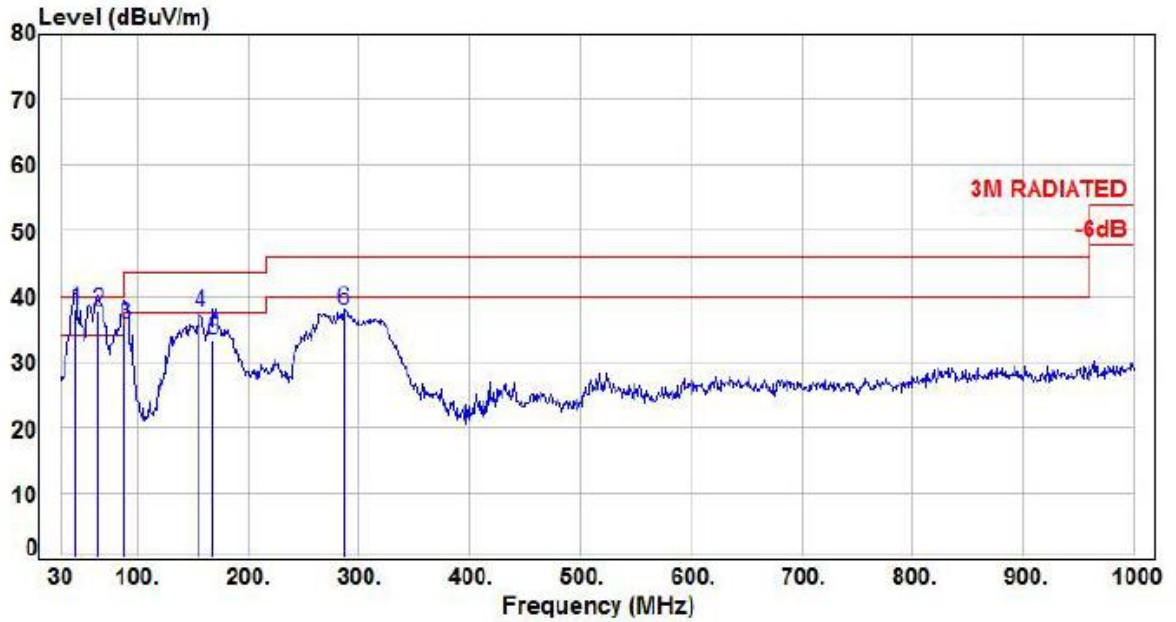

No.	Frequency (MHz)	Factor (dB/m)	Reading (dBuV)	Level (dBuV/m)	Limit (dBuV/m)	Margin (dB)	Detector	P/F
1	43.58	-12.94	50.80	37.86	40.00	-2.14	QP	P
2	63.95	-16.47	54.27	37.80	40.00	-2.20	QP	P
3	88.20	-14.49	50.24	35.75	43.50	-7.75	QP	P
4	156.10	-9.56	46.96	37.40	43.50	-6.10	Peak	P
5	167.74	-9.94	43.35	33.41	43.50	-10.09	QP	P
6	286.08	-8.81	46.69	37.88	46.00	-8.12	Peak	P

Note: Level=Reading+Factor
Margin=Level-Limit
Factor=Antenna Factor + cable loss - Amplifier Factor



Test Mode	: Mode 2	Pol/Phase	: Horizontal
Power	: AC 120V/60Hz		

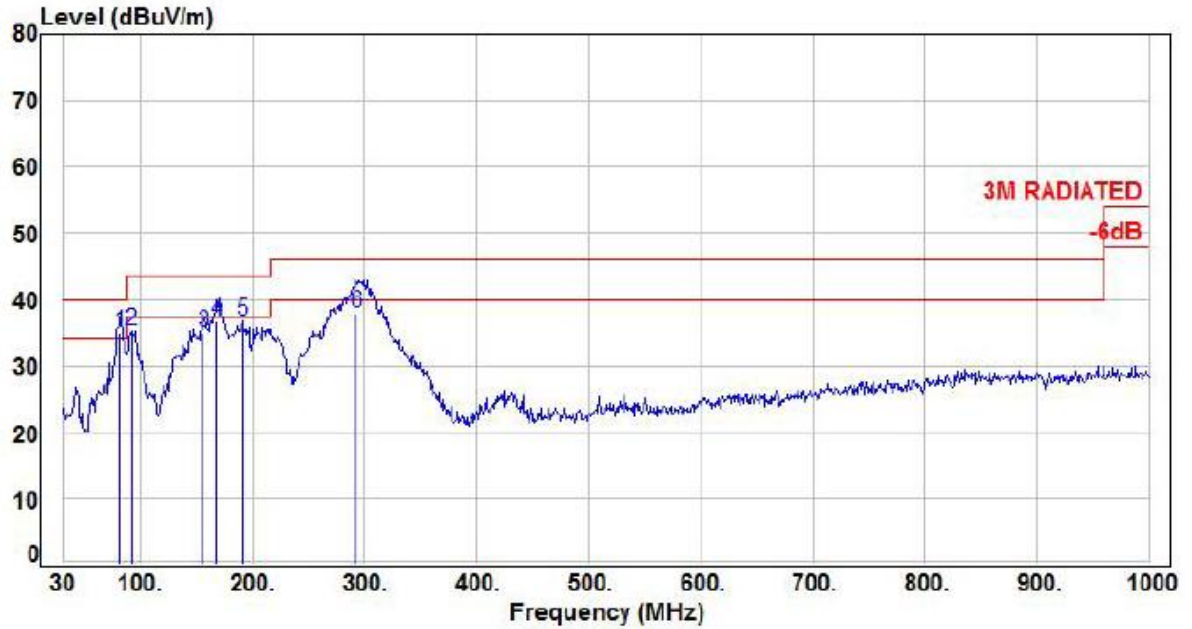

No.	Frequency (MHz)	Factor (dB/m)	Reading (dBUV)	Level (dBUV/m)	Limit (dBUV/m)	Margin (dB)	Detector	P/F
1	81.41	-15.24	50.18	34.94	40.00	-5.06	QP	P
2	92.08	-13.63	49.01	35.38	43.50	-8.12	Peak	P
3	156.10	-9.56	44.53	34.97	43.50	-8.53	QP	P
4	167.74	-9.94	46.61	36.67	43.50	-6.83	QP	P
5	191.02	-10.45	47.11	36.66	43.50	-6.84	Peak	P
6	292.87	-8.83	46.75	37.92	46.00	-8.08	QP	P

Note: Level=Reading+Factor
 Margin=Level-Limit
 Factor=Antenna Factor + cable loss - Amplifier Factor



7. 20dB Bandwidth

7.1 Test Limit

None: for reporting purposed only.

7.2 Test Procedures

Intentional radiators operating under the alternative provisions to the general emission limits, as contained in §15.215, must be designed to ensure that 20dB bandwidth of the emission, or whatever bandwidth may otherwise be specified in the specific rule section under which the equipment operates is contained within the frequency band designated in the rule section under which the equipment is operated.

7.3 Typical Test Setup

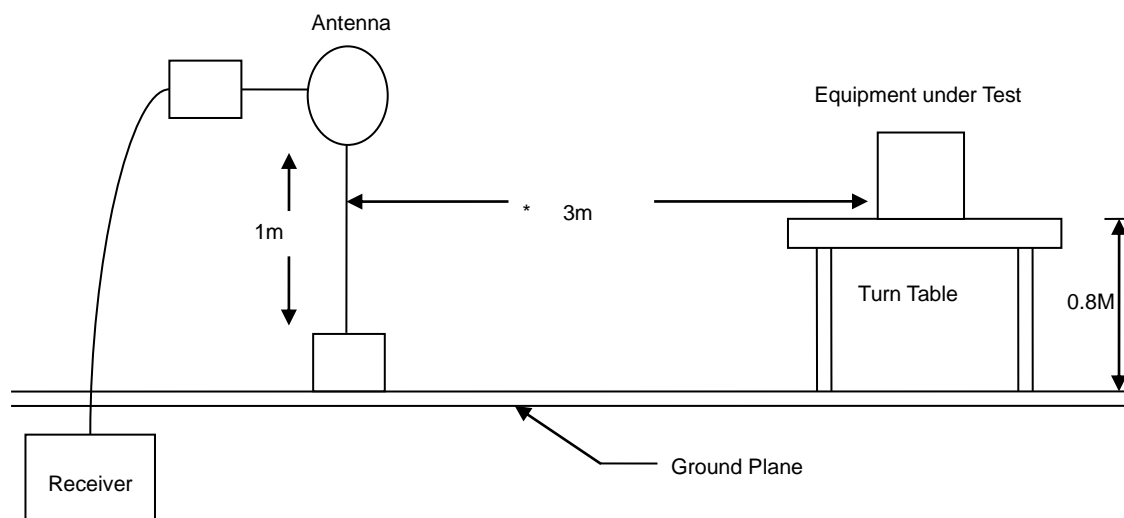



7.4 Test Result and Data

Wireless 1(5W for Wireless Load, Operating @ BPP: 120~148.5KHz)

Frequency (kHz)	20 dB bandwidth (kHz)
139.9KHz	0.048

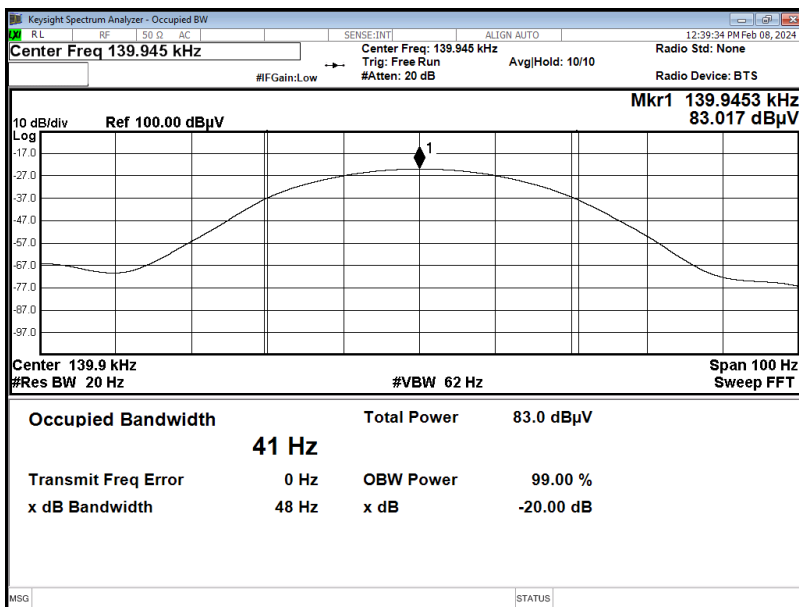

Wireless 1(15W for Wireless Load, Operating @ MPP 360KHz)

Frequency (kHz)	20 dB bandwidth (kHz)
360KHz	0.049

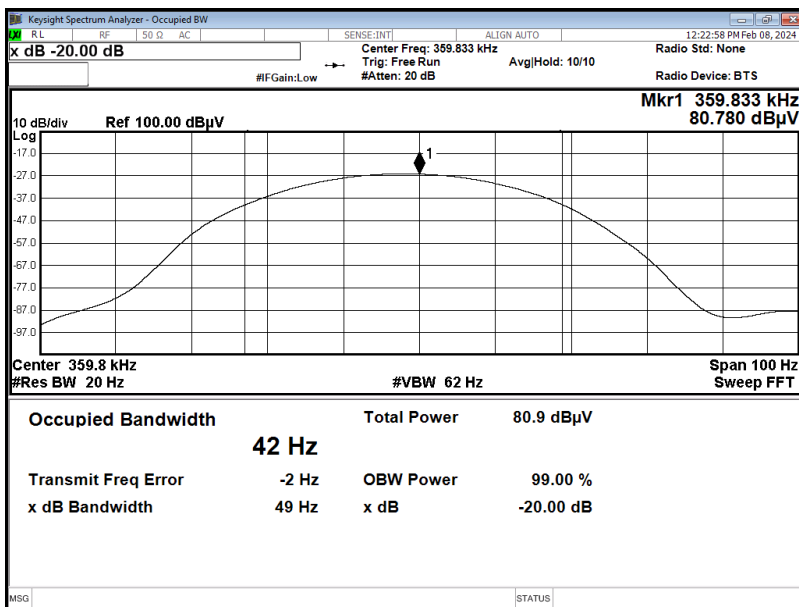



Wireless 2 Charging for AirPods

Frequency (kHz)	20 dB bandwidth (kHz)
146KHz	0.066

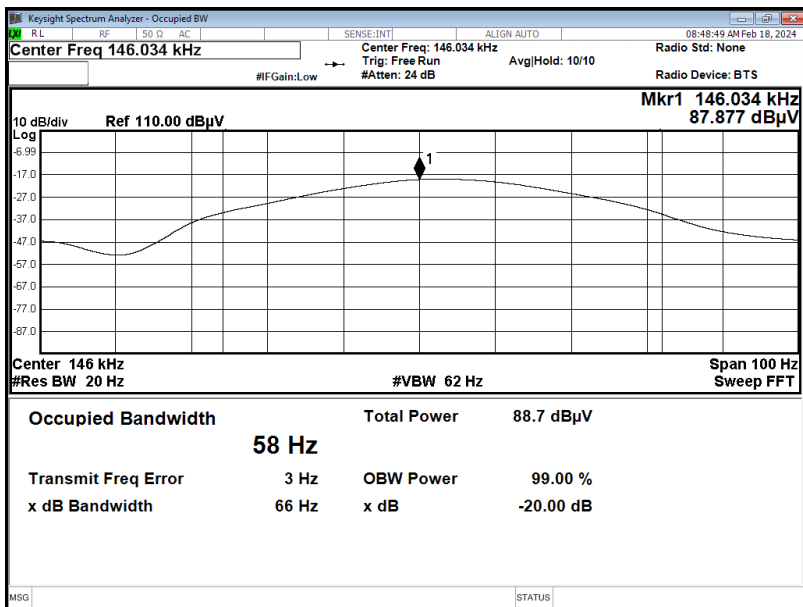

Wireless 3 Charging for Apple watch @326.5KHz

Frequency (kHz)	20 dB bandwidth (kHz)
326.5KHz	0.049

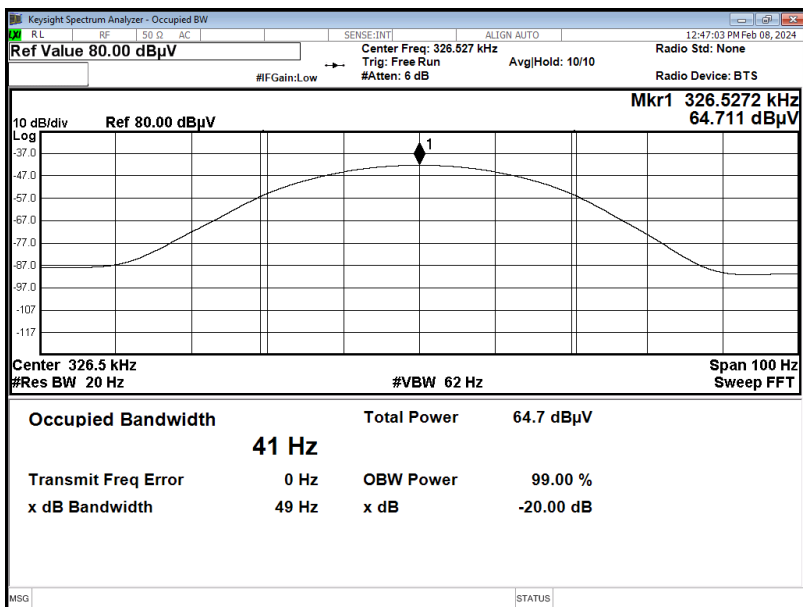



Wireless 3 Charging for Apple watch @1.778MHz

Frequency (MHz)	20 dB bandwidth (kHz)
1.778MHz	0.048

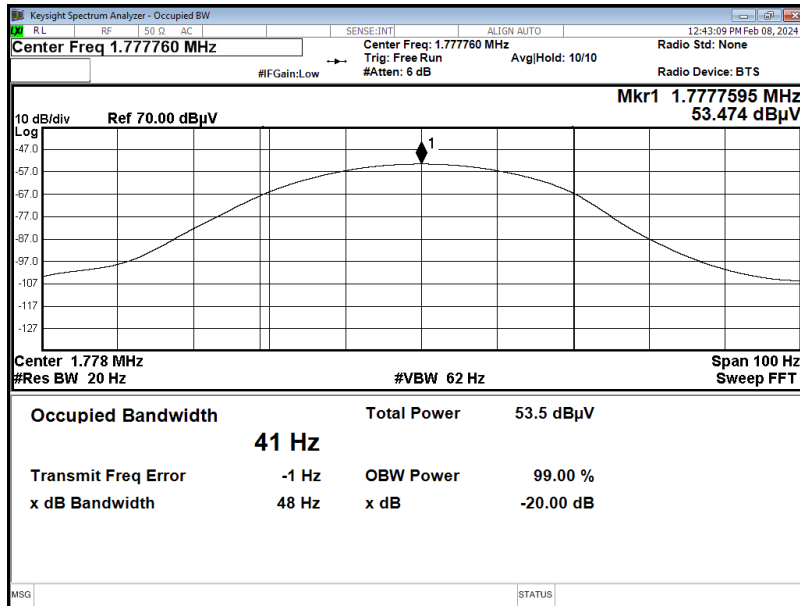

----- End of the report -----