



CTC Laboratories, Inc.

1-2/F., Building 2, Jiaquan Building, Guanlan High-Tech Park, Shenzhen, Guangdong, China
Tel: +86-755- 27521059 Fax: +86-755- 27521011 Http://www.sz-ctc.com.cn

TEST REPORT

Report No.: **GTI20190229F**

FCC ID.....: **ZE9-ST-ABTCM**

Applicant.....: **SARIANA LLC.**

Address.....: 7365 Mission Gorge Road, Suite G, San Diego , CA 92120, USA

Manufacturer.....: SARIANA LLC.

Address.....: 7365 Mission Gorge Road, Suite G, San Diego , CA 92120, USA

Product Name.....: **M1 Bluetooth Mouse**

Trade Mark.....: SATECHI

Model/Type reference.....: ST-ABTCM

Listed Model(s): /

Standard.....: **FCC CFR Title 47 Part 15 Subpart C Section 15.247**
ANSI C63.10-2013

Date of receipt of test sample....: 2019-01-30

Date of testing.....: 2019-01-31 to 2019-02-14

Date of issue.....: 2019-02-14

Result.....: **PASS**

Compiled by:
(Printed name+signature) Torny Fang

Torny Fang

Supervised by:
(Printed name+signature) Cary Luo

Cary Luo

Approved by:
(Printed name+signature) Walter Chen

Walter Chen

Testing Laboratory Name..... **CTC Laboratories, Inc.**

Address..... 1-2/F., Building 2, Jiaquan Building, Guanlan High-Tech Park,
Shenzhen, Guangdong, China

This test report may be duplicated completely for legal use with the approval of the applicant. It should not be reproduced except in full, without the written approval of our laboratory. The client should not use it to claim product endorsement by CTC. The test results in the report only apply to the tested sample. The test report shall be invalid without all the signatures of testing engineers, reviewer and approver. Any objections must be raised to CTC within 15 days since the date when the report is received. It will not be taken into consideration beyond this limit. The test report merely correspond to the test sample.



Table of Contents

Page

- 1. TEST SUMMARY 3
 - 1.1. TEST STANDARDS..... 3
 - 1.2. REPORT VERSION..... 3
 - 1.3. TEST DESCRIPTION..... 4
 - 1.4. TEST FACILITY 5
 - 1.5. MEASUREMENT UNCERTAINTY 6
 - 1.6. ENVIRONMENTAL CONDITIONS 6
- 2. GENERAL INFORMATION 7
 - 2.1. CLIENT INFORMATION 7
 - 2.2. GENERAL DESCRIPTION OF EUT 7
 - 2.3. OPERATION STATE..... 8
 - 2.4. MEASUREMENT INSTRUMENTS LIST 9
- 3. TEST ITEM AND RESULTS 10
 - 3.1. CONDUCTED EMISSION..... 10
 - 3.2. RADIATED EMISSION 12
 - 3.3. BAND EDGE EMISSIONS 18
 - 3.4. BANDWIDTH..... 21
 - 3.5. PEAK OUTPUT POWER 25
 - 3.6. POWER SPECTRAL DENSITY 28
 - 3.7. ANTENNA REQUIREMENT 31
- 4. EUT TEST PHOTOS 32
- 5. PHOTOGRAPHS OF EUT CONSTRUCTIONAL 33

CTC Laboratories, Inc.

1-2/F., Building 2, Jiaquan Building, Guanlan High-Tech Park, Shenzhen, Guangdong, China
Tel.: (86)755-27521059 Fax: (86)755-27521011 Http://www.sz-ctc.org.cn



For anti-fake verification, please visit the official website of Certification and Accreditation Administration of the People's Republic of China : yz.cncaic.cn



1. TEST SUMMARY

1.1. Test Standards

The tests were performed according to following standards:

[FCC Rules Part 15.247](#): Operation within the bands of 902-928MHz, 2400-2483.5MHz, and 5725-5850MHz.

[ANSI C63.10-2013](#): American National Standard for Testing Unlicensed Wireless Devices.

1.2. Report version

Revised No.	Date of issue	Description
01	2019-02-14	Original



1.3. Test Description

FCC Part 15 Subpart C(15.247)/ RSS 247 Issue 5				
Test Item	Standard Section		Result	Test Engineer
	FCC	IC		
Antenna Requirement	15.203	/	Pass	Terry Su
Conducted Emission	15.207(a)	RSS-GEN 7.2.4	Pass	Terry Su
Band-Edge & Unwanted Emissions into Restricted Frequency	15.205&15.247(d)	RSS-GEN 7.2.2	Pass	Terry Su
6dB Bandwidth	15.247(a)(2)	RSS 247 5.2 (1)	Pass	Terry Su
Conducted Max Output Power	15.247(b)(3)	RSS 247 5.4 (4)	Pass	Terry Su
Power Spectral Density	15.247(e)	RSS 247 5.2 (2)	Pass	Terry Su
Transmitter Radiated Spurious & Unwanted Emissions into Restricted Frequency	15.205, 15.209&15.247(d)	RSS 247 5.5	Pass	Terry Su

Note: The measurement uncertainty is not included in the test result.



1.4. Test Facility

Address of the report laboratory

CTC Laboratories, Inc.

Add: 1-2/F., Building 2, Jiaquan Building, Guanlan High-Tech Park, Shenzhen, Guangdong, China

Laboratory accreditation

The test facility is recognized, certified, or accredited by the following organizations:

CNAS-Lab Code: L5365

CTC Laboratories, Inc has been assessed and proved to be in compliance with CNAS-CL01 Accreditation Criteria for Testing and Calibration Laboratories (identical to ISO/IEC17025:2005 General Requirements) for the Competence of Testing and Calibration Laboratories.

A2LA-Lab Cert. No.: CN1208

CTC Laboratories, Inc EMC Laboratory has been accredited by A2LA for technical competence in the field of electrical testing, and proved to be in compliance with ISO/IEC 17025:2005 General Requirements for the Competence of Testing and Calibration Laboratories and any additional program requirements in the identified field of testing.

IC Registration No.: 9783A-1

The 3m alternate test site of CTC Laboratories, Inc. EMC Laboratory has been registered by Certification and Engineer Bureau of Industry Canada for the performance of with Registration NO.: 9783A-1 on Jan, 2016.

FCC-Registration No.: 951311

CTC Laboratories, Inc. EMC Laboratory has been registered and fully described in a report filed with the (FCC) Federal Communications Commission. The acceptance letter from the FCC is maintained in our files. Registration 951311, Aug 26, 2017



1.5. Measurement Uncertainty

The data and results referenced in this document are true and accurate. The reader is cautioned that there may be errors within the calibration limits of the equipment and facilities. The measurement uncertainty was calculated for all measurements listed in this test report acc. to TR-100028-01” Electromagnetic compatibility and Radio spectrum Matters (ERM);Uncertainties in the measurement of mobile radio equipment characteristics; Part 1” and TR-100028-02 “Electromagnetic compatibility and Radio spectrum Matters (ERM);Uncertainties in the measurement of mobile radio equipment characteristics; Part 2 “ and is documented in the CTC Laboratories, Inc. quality system acc. to DIN EN ISO/IEC 17025. Furthermore, component and process variability of devices similar to that tested may result in additional deviation. The manufacturer has the sole responsibility of continued compliance of the device.

Below is the best measurement capability for CTC Laboratories, Inc.

Test Items	Measurement Uncertainty	Notes
Transmitter power conducted	0.42 dB	(1)
Transmitter power Radiated	2.14 dB	(1)
Conducted spurious emissions 9kHz~40GHz	1.60 dB	(1)
Radiated spurious emissions 9kHz~40GHz	2.20 dB	(1)
Conducted Emissions 9kHz~30MHz	3.20 dB	(1)
Radiated Emissions 30~1000MHz	4.70 dB	(1)
Radiated Emissions 1~18GHz	5.00 dB	(1)
Radiated Emissions 18~40GHz	5.54 dB	(1)
Occupied Bandwidth	-----	(1)

Note (1): This uncertainty represents an expanded uncertainty expressed at approximately the 95% confidence level using a coverage factor of k=1.96.

1.6. Environmental conditions

During the measurement the environmental conditions were within the listed ranges:

Temperature:	15~35°C
Relative Humidity:	30~60 %
Air Pressure:	950~1050mba



2. GENERAL INFORMATION

2.1. Client Information

Applicant:	SARIANA LLC.
Address:	7365 Mission Gorge Road, Suite G, San Diego , CA 92120, USA
Manufacturer:	SARIANA LLC.
Address:	7365 Mission Gorge Road, Suite G, San Diego , CA 92120, USA
Factory:	SARIANA LLC.
Address:	7365 Mission Gorge Road, Suite G, San Diego , CA 92120, USA

2.2. General Description of EUT

Product Name:	M1 Bluetooth Mouse
Model/Type reference:	ST-ABTCM
Marketing Name:	SATECHI
Listed Model(s):	/
Model Difference:	/
Power supply:	Battery: DC 3.7V 500mAh
Hardware version:	N/A
Software version:	N/A
Bluetooth 4.0	
Modulation:	GFSK
Operation frequency:	2402MHz~2480MHz
Max Peak Output Power:	0.01 dBm
Channel number:	40
Channel separation:	2MHz
Antenna type:	PCB Antenna
Antenna gain:	-6.98 dBi



2.3. Operation state

Operation Frequency List: The EUT has been tested under typical operating condition. The Applicant provides communication tools software to control the EUT for staying in continuous transmitting and receiving mode for testing. BT BLE, 40 channels are provided to the EUT. Channels 00/20/39 were selected for testing.

Operation Frequency List:

Channel	Frequency (MHz)
00	2402
01	2404
⋮	⋮
19	2440
20	2442
21	2444
⋮	⋮
38	2478
39	2480

Note: The display in grey were the channel selected for testing.

Test mode

For RF test items:
The software test program was provided and enabled to make EUT continuous transmit (duty cycle>98%).
For AC power line conducted emissions:
The EUT was set to connect with the Bluetooth instrument under large package sizes transmission.
For Radiated spurious emissions test item:
The engineering test program was provided and enabled to make EUT continuous transmit. The EUT in each of three orthogonal axis emissions had been tested, but only the worst case (X axis) data recorded in the report.



2.4. Measurement Instruments List

Tonscend JS0806-2 Test system					
Item	Test Equipment	Manufacturer	Model No.	Serial No.	Calibrated until
1	Spectrum Analyzer	Rohde & Schwarz	FSU26	100105	Dec. 28, 2019
2	Spectrum Analyzer	Rohde & Schwarz	FUV40-N	101331	Dec. 28, 2019
3	MXG Vector Signal Generator	Agilent	N5182A	MY47420864	Dec. 28, 2019
4	Signal Generator	Agilent	E8257D	MY46521908	Dec. 28, 2019
5	Power Sensor	Agilent	U2021XA	MY5365004	Dec. 28, 2019
6	Power Sensor	Agilent	U2021XA	MY5365006	Dec. 28, 2019
7	Simultaneous Sampling DAQ	Agilent	U2531A	TW54493510	Dec. 28, 2019
8	Climate Chamber	TABAI	PR-4G	A8708055	Dec. 28, 2019
9	Wideband Radio Communication Tester	Rohde & Schwarz	CMW500	116410	Dec. 28, 2019
10	Climate Chamber	ESPEC	MT3065	/	Dec. 28, 2019
11	300328 v2.1.1 test system	TONSCEND	v2.6	/	/

Item	Test Equipment	Manufacturer	Model No.	Serial No.	Calibrated until
1	EMI Test Receiver	Rohde & Schwarz	ESCI	100658	Dec. 28, 2019
2	High pass filter	micro-tranics	HPM50111	142	Dec. 28, 2019
3	Log-Bicon Antenna	Schwarzbeck	CBL6141A	4180	Dec. 28, 2019
4	Ultra-Broadband Antenna	ShwarzBeck	BBHA9170	25841	Dec. 28, 2019
5	Loop Antenna	LAPLAC	RF300	9138	Dec. 28, 2019
6	Spectrum Analyzer	Rohde & Schwarz	FSU26	100105	Dec. 28, 2019
7	Horn Antenna	Schwarzbeck	BBHA 9120D	647	Dec. 28, 2019
8	Pre-Amplifier	HP	8447D	1937A03050	Dec. 28, 2019
9	Pre-Amplifier	EMCI	EMC051835	980075	Dec. 28, 2019
10	Antenna Mast	UC	UC3000	N/A	N/A
11	Turn Table	UC	UC3000	N/A	N/A
12	Cable Below 1GHz	Schwarzbeck	AK9515E	33155	Dec. 28, 2019
13	Cable Above 1GHz	Hubersuhner	SUCOFLEX102	DA1580	Dec. 28, 2019
14	Splitter	Mini-Circuit	ZAPD-4	400059	Dec. 28, 2019
15	RF Connection Cable	HUBER+SUHNER	RE-7-FL	N/A	Dec. 28, 2019
16	RF Connection Cable	Chengdu E-Microwave	---	---	Dec. 28, 2019
17	High pass filter	Compliance Direction systems	BSU-6	34202	Dec. 28, 2019
18	Attenuator	Chengdu E-Microwave	EMCAXX-10R NZ-3	---	Dec. 28, 2019

Note:1. The Cal. Interval was one year.

2. The cable loss has calculated in test result which connection between each test instruments.

CTC Laboratories, Inc

1-2/F., Building 2, Jiaquan Building, Guanlan High-Tech Park, Shenzhen, Guangdong, China

Tel.: (86)755-27521059

Fax: (86)755-27521011

Http://www.sz-ctc.org.cn



中国国家认证认可监督管理委员会
Certification and Accreditation Administration of the People's Republic of China

For anti-fake verification, please visit the official website of Certification and Accreditation Administration of the People's Republic of China : yz.cncaic.cn

3. TEST ITEM AND RESULTS

3.1. Conducted Emission

Limit

Conducted Emission Test Limit

Frequency	Maximum RF Line Voltage (dBμV)	
	Quasi-peak Level	Average Level
150kHz~500kHz	66 ~ 56 *	56 ~ 46 *
500kHz~5MHz	56	46
5MHz~30MHz	60	50

Notes:

- (1) *Decreasing linearly with logarithm of the frequency.
- (2) The lower limit shall apply at the transition frequencies.
- (3) The limit decrease in line with the logarithm of the frequency in the range of 0.15 to 0.50MHz.

Test Configuration

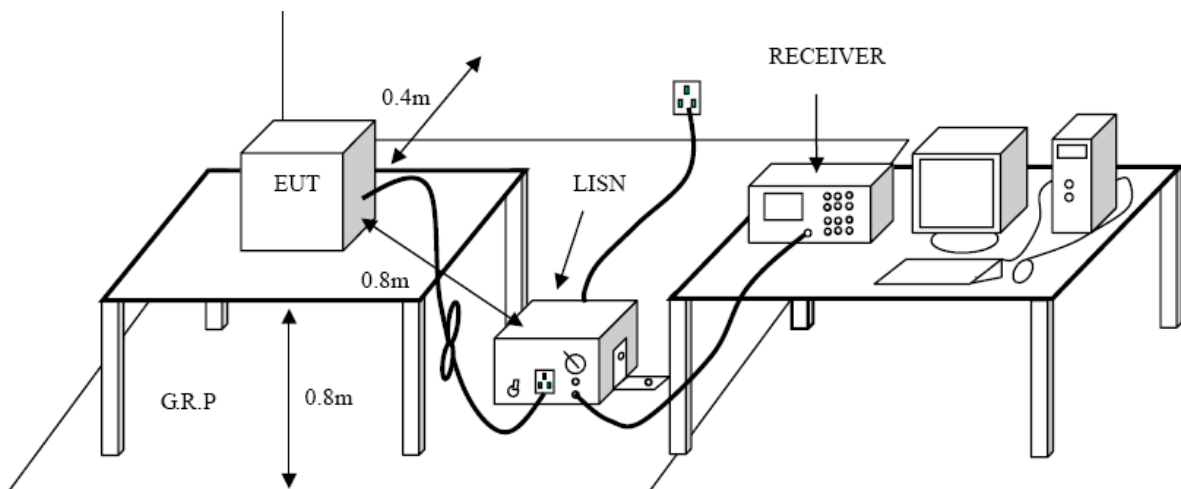

Test Procedure

1. The EUT was setup according to ANSI C63.10:2013 requirements.
2. The EUT was placed on a platform of nominal size, 1 m by 1.5 m, raised 80 cm above the conducting ground plane. The vertical conducting plane was located 40 cm to the rear of the EUT. All other surfaces of EUT were at least 80 cm from any other grounded conducting surface.
3. The EUT and simulators are connected to the main power through a line impedances stabilization network (LISN). The LISN provides a 50ohm /50uH coupling impedance for the measuring equipment.
The peripheral devices are also connected to the main power through a LISN. (Please refer to the block diagram of the test setup and photographs)
4. Each current-carrying conductor of the EUT power cord, except the ground (safety) conductor, was individually connected through a LISN to the input power source.
5. The excess length of the power cord between the EUT and the LISN receptacle were folded back and forth at the center of the lead to form a bundle not exceeding 40 cm in length.
6. Conducted Emissions were investigated over the frequency range from 0.15MHz to 30MHz using a receiver bandwidth of 9 kHz.
7. During the above scans, the emissions were maximized by cable manipulation.



Test Mode:

Please refer to the clause 2.2.

Test Results

For the mouse, battery powered, no testing required.

3.2. Radiated Emission

Limit

Radiated Emission Limits (9 kHz~1000 MHz)

Frequency (MHz)	Field Strength (microvolt/meter)	Measurement Distance (meters)
0.009~0.490	2400/F(KHz)	300
0.490~1.705	24000/F(KHz)	30
1.705~30.0	30	30
30~88	100	3
88~216	150	3
216~960	200	3
Above 960	500	3

Radiated Emission Limit (Above 1000MHz)

Frequency (MHz)	Distance Meters(at 3m)	
	Peak	Average
Above 1000	74	54

Note:

- (1) The tighter limit applies at the band edges.
- (2) Emission Level (dBuV/m)=20log Emission Level (uV/m).

Test Configuration

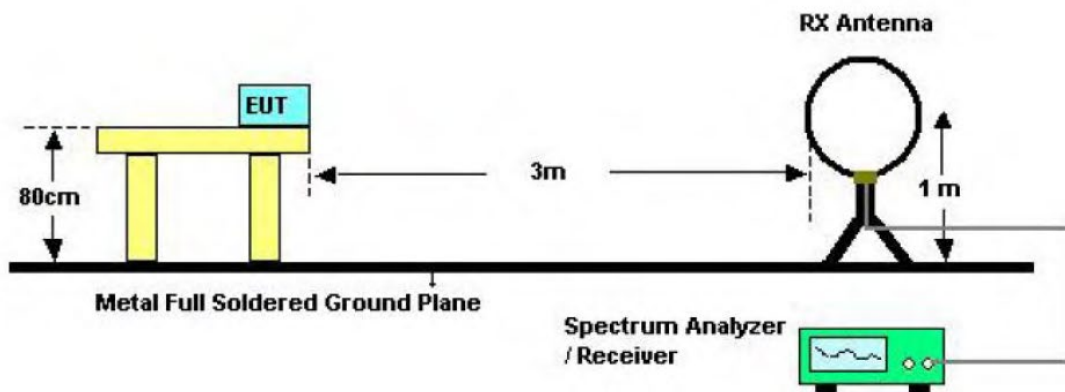

Below 30MHz Test Setup

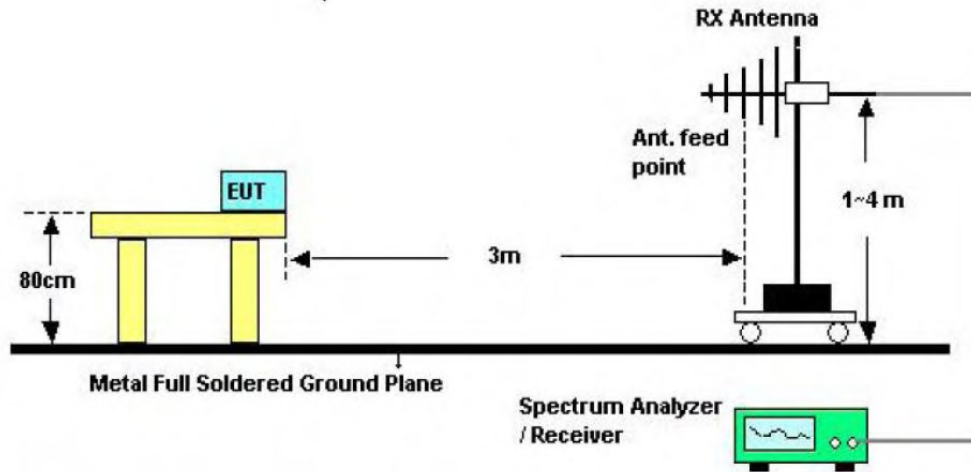

Below 1000MHz Test Setup

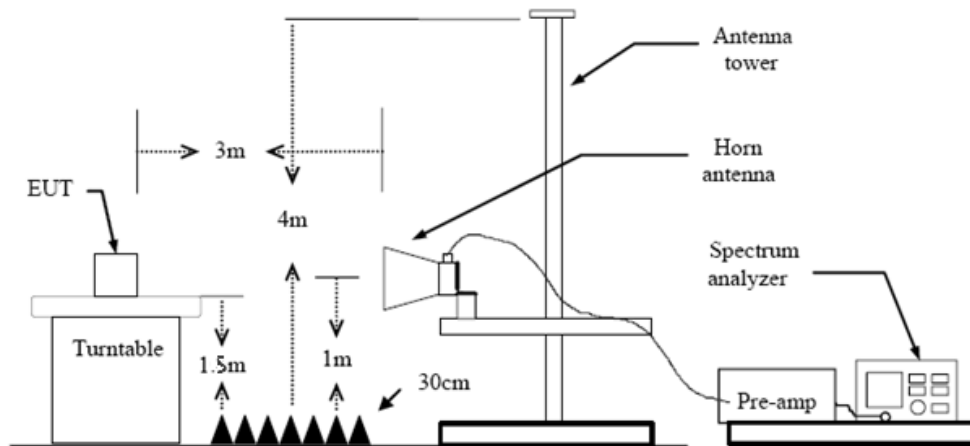

Above 1GHz Test Setup

Test Procedure

1. The EUT was setup and tested according to ANSI C63.10:2013
2. The EUT is placed on a turn table which is 0.8 meter above ground for below 1 GHz, and 1.5 m for above 1 GHz. The turn table is rotated 360 degrees to determine the position of the maximum emission level.
3. The EUT was set 3 meters from the receiving antenna, which was mounted on the top of a variable height antenna tower.
4. For each suspected emission, the EUT was arranged to its worst case and then tune the Antenna tower (from 1 m to 4 m) and turntable (from 0 degree to 360 degrees) to find the maximum reading. A pre-amp and a high pass filter are used for the test in order to get better signal level to comply with the guidelines.
5. Set to the maximum power setting and enable the EUT transmit continuously.
6. Use the following spectrum analyzer settings
 - (1) Span shall wide enough to fully capture the emission being measured;
 - (2) Below 1 GHz:
 RBW=120 kHz, VBW=300 kHz, Sweep=auto, Detector function=peak, Trace=max hold;
 If the emission level of the EUT measured by the peak detector is 3 dB lower than the applicable limit, the peak emission level will be reported. Otherwise, the emission measurement will be repeated using the quasi-peak detector and reported.
 - (3) From 1 GHz to 10th harmonic:



RBW=1MHz, VBW=3MHz Peak detector for Peak value.
RBW=1MHz, VBW=3MHz RMS detector for Average value.

Test Mode

Please refer to the clause 2.2.

Test Result

9 KHz~30 MHz

From 9 KHz to 30 MHz: Conclusion: PASS

Note: The amplitude of spurious emissions which are attenuated by more than 20dB below the permissible value has no need to be reported.



30MHz-1GHz

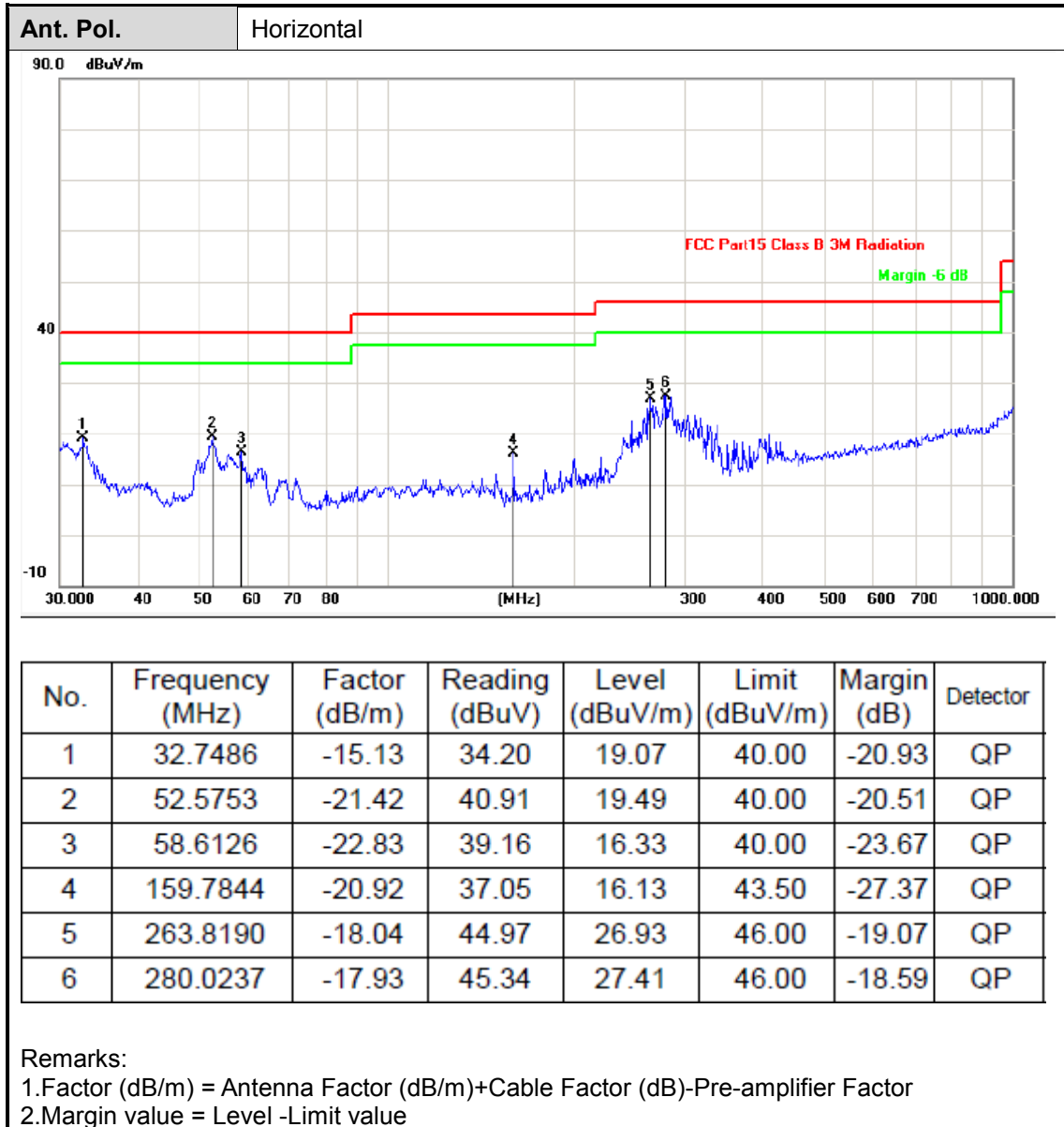

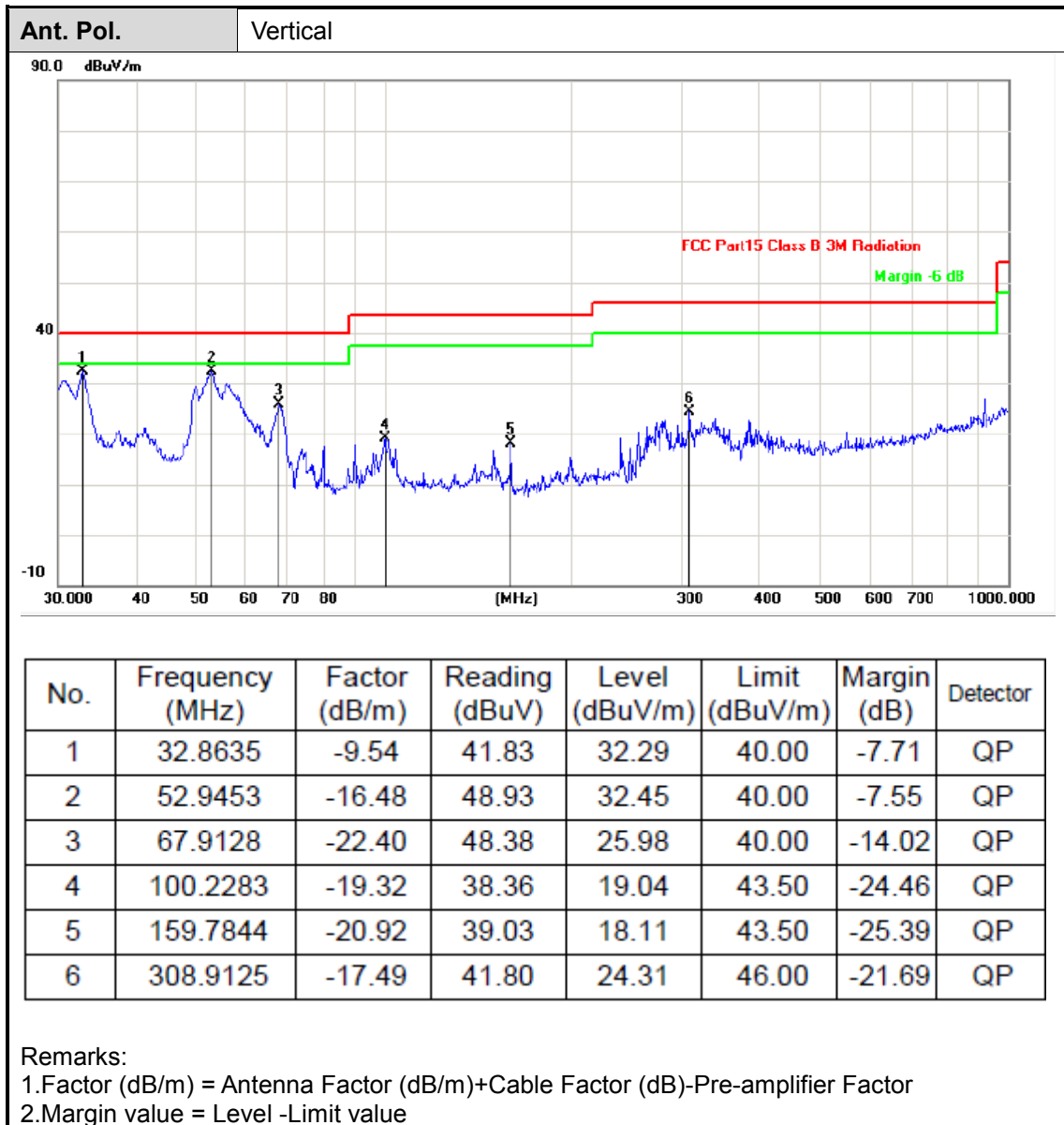



Above 1GHz

No report for the emission which more than 10 dB below the prescribed limit.

Test Mode: BLE - 2402MHz							
Frequency (MHz)	Reading (dBuV)	Antenna Factor (dB/m)	Level (dBuV/m)	Limit (dBuV/m)	Margin (dB)	Antenna Pole (V/H)	Remark
4804	41.68	3.09	44.77	74	-29.23	V	peak
7206	40.69	5.21	45.9	74	-28.1	V	peak
4804	42.98	3.09	46.07	74	-27.93	H	peak
7206	43.21	5.21	48.42	74	-25.58	H	peak

Remark:

- 1.Factor (dB/m) = Antenna Factor (dB/m)+Cable Factor (dB)-Pre-amplifier Factor
- 2.Margin value = Level -Limit value

Test Mode: BLE - 2442MHz							
Frequency (MHz)	Reading (dBuV)	Antenna Factor (dB/m)	Level (dBuV/m)	Limit (dBuV/m)	Margin (dB)	Antenna Pole (V/H)	Remark
4884	42.35	3.37	45.72	74	-28.28	V	peak
7326	41.62	5.56	47.18	74	-26.82	V	peak
4884	43.68	3.37	47.05	74	-26.95	H	peak
7326	41.23	5.56	46.79	74	-27.21	H	peak

Remark:

- 1.Factor (dB/m) = Antenna Factor (dB/m)+Cable Factor (dB)-Pre-amplifier Factor
- 2.Margin value = Level -Limit value

Test Mode: BLE - 2480MHz							
Frequency (MHz)	Reading (dBuV)	Antenna Factor (dB/m)	Level (dBuV/m)	Limit (dBuV/m)	Margin (dB)	Antenna Pole (V/H)	Remark
4960	40.88	3.44	44.32	74	-29.68	V	peak
7440	41.57	5.64	47.21	74	-26.79	V	peak
4960	42.86	3.44	46.3	74	-27.7	H	peak
7440	41.67	5.64	47.31	74	-26.69	H	peak

Remark:

- 1.Factor (dB/m) = Antenna Factor (dB/m)+Cable Factor (dB)-Pre-amplifier Factor
- 2.Margin value = Level -Limit value

3.3. Band Edge Emissions

Limit

Restricted Frequency Band (MHz)	(dBuV/m)(at 3m)	
	Peak	Average
2310 ~2390	74	54
2483.5 ~2500	74	54

Note: All restriction bands have been tested, only the worst case is reported.

Test Configuration

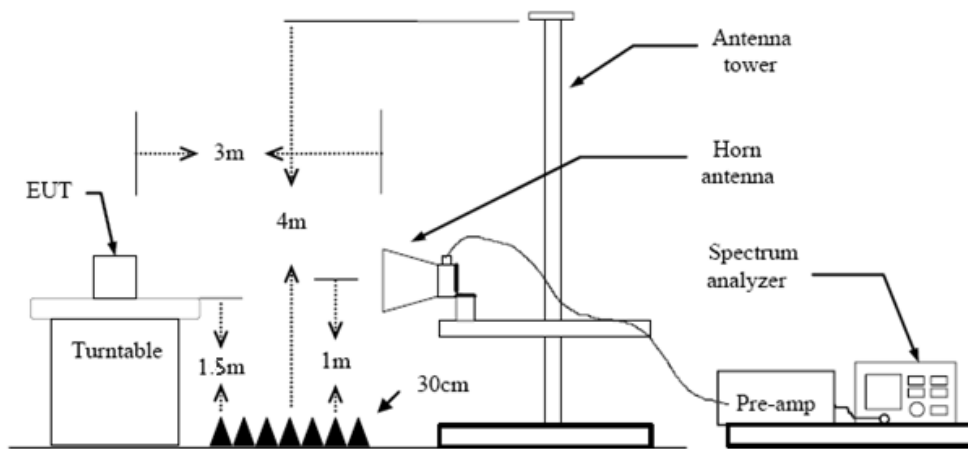

Test Procedure

1. The EUT was setup and tested according to ANSI C63.10:2013 requirements.
2. The EUT is placed on a turn table which is 1.5 meter above ground. The turn table is rotated 360 degrees to determine the position of the maximum emission level.
3. The EUT was positioned such that the distance from antenna to the EUT was 3 meters.
4. The antenna is scanned from 1 meter to 4 meters to find out the maximum emission level. This is repeated for both horizontal and vertical polarization of the antenna. In order to find the maximum emission, all of the interface cables were manipulated according to ANSI C63.10:2013 on radiated measurement.
5. The receiver set as follow:
 RBW=1MHz, VBW=3MHz PEAK detector for Peak value.
 RBW=1MHz, VBW=10Hz with PEAK Detector for Average Value.

Test Mode

Please refer to the clause 2.2.

Test Results



(1) Radiation Test

BLE				CH00			
Frequency (MHz)	Read Level (dBuV)	Factor (dB/m)	Level (dBuV/m)	Limit Line (dBuV/m)	Margin (dB)	Polarization	Test value
2310	50.32	3.28	53.6	74	-20.4	Vertical	Peak
2390	49.86	3.85	53.71	74	-20.29	Vertical	Peak
2310	51.34	3.02	54.36	74	-19.64	Horizontal	Peak
2390	50.23	3.67	53.9	74	-20.1	Horizontal	Peak
2310	42.13	3.28	45.41	54	-8.59	Vertical	Average
2390	41.78	3.85	45.63	54	-8.37	Vertical	Average
2310	41.68	3.02	44.7	54	-9.3	Horizontal	Average
2390	40.24	3.67	43.91	54	-10.09	Horizontal	Average

Remark: Margin= Limit Line-(Read Level + Factor)

BLE				CH39			
Frequency (MHz)	Read Level (dBuV)	Factor (dB/m)	Level (dBuV/m)	Limit Line (dBuV/m)	Margin (dB)	Polarization	Test value
2483.5	51.23	3.79	55.02	74	-18.98	Vertical	Peak
2500	47.68	4.09	51.77	74	-22.23	Vertical	Peak
2483.5	51.46	3.65	55.11	74	-18.89	Horizontal	Peak
2500	51.22	3.95	55.17	74	-18.83	Horizontal	Peak
2483.5	41.32	3.79	45.11	54	-8.89	Vertical	Average
2500	41.25	4.09	45.34	54	-8.66	Vertical	Average
2483.5	40.38	3.65	44.03	54	-9.97	Horizontal	Average
2500	40.35	3.95	44.3	54	-9.7	Horizontal	Average

Remark: Margin= Limit Line-(Read Level + Factor)



(2) Conducted Test

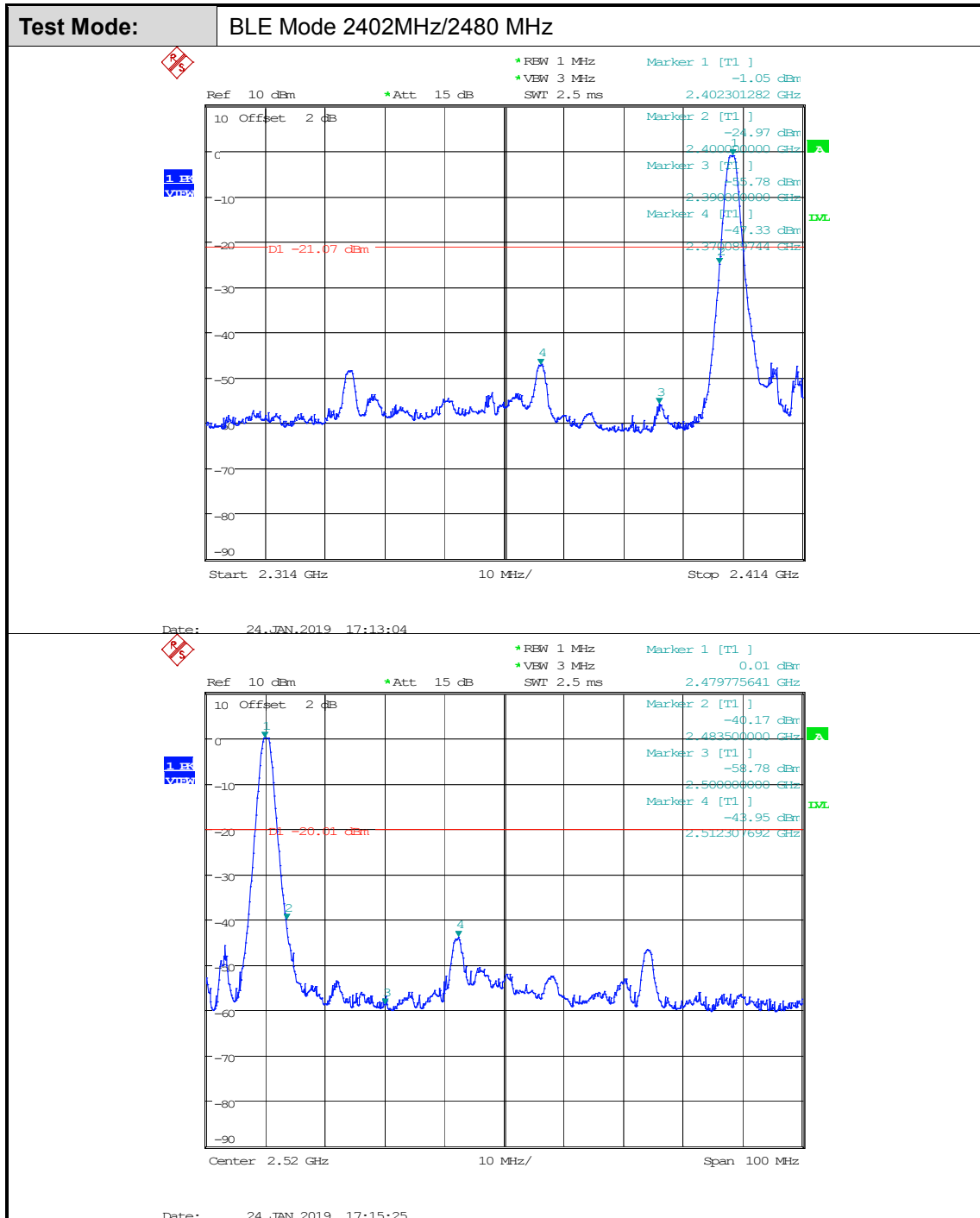

CTC Laboratories, Inc

1-2/F., Building 2, Jiaquan Building, Guanlan High-Tech Park, Shenzhen, Guangdong, China
Tel.: (86)755-27521059 Fax: (86)755-27521011 Http://www.sz-ctc.org.cn



For anti-fake verification, please visit the official website of Certification and Accreditation Administration of the People's Republic of China : yz.cncaic.cn

3.4. Bandwidth

Limit

Test Item	Limit	Frequency Range(MHz)
Bandwidth	≥ 500 KHz (6dB bandwidth)	2400~2483.5

Test Configuration

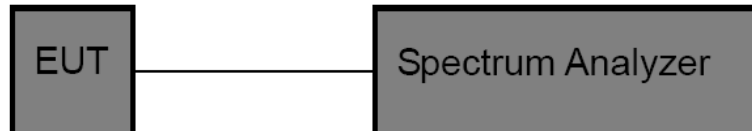

Test Procedure

1. The EUT was directly connected to the spectrum analyzer and antenna output port as show in the block diagram above.
2. Spectrum Setting:
 - Set RBW = 100 kHz.
 - Set the video bandwidth (VBW) ≥ 3 RBW.
 - Detector = Peak.
 - Trace mode = Max hold.
 - Sweep = Auto couple.

NOTE: The EUT was set to continuously transmitting in each mode and low, Middle and high channel for the test.

Test Mode

Please refer to the clause 2.2.

Test Results

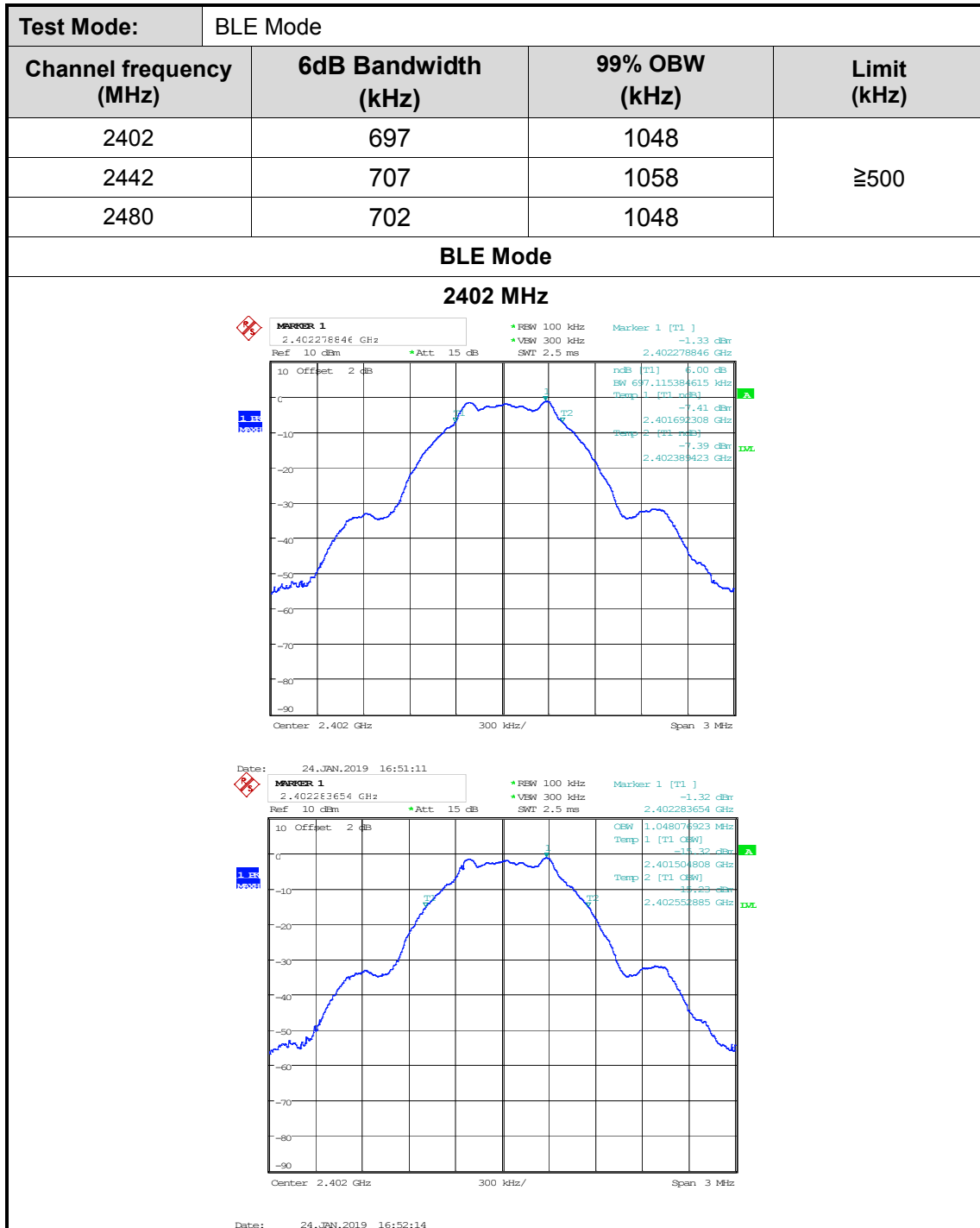



BLE Mode

2442 MHz

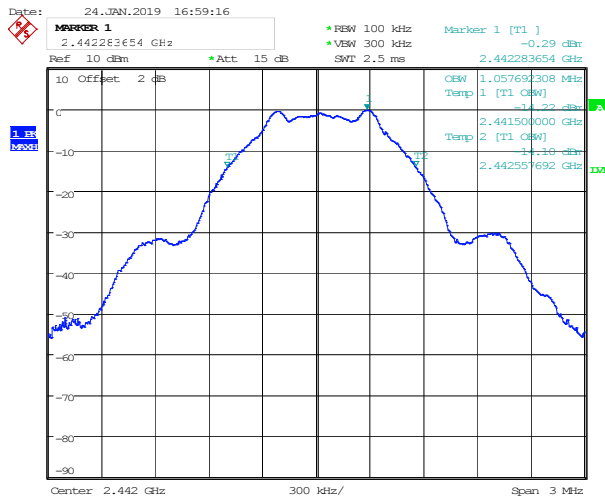
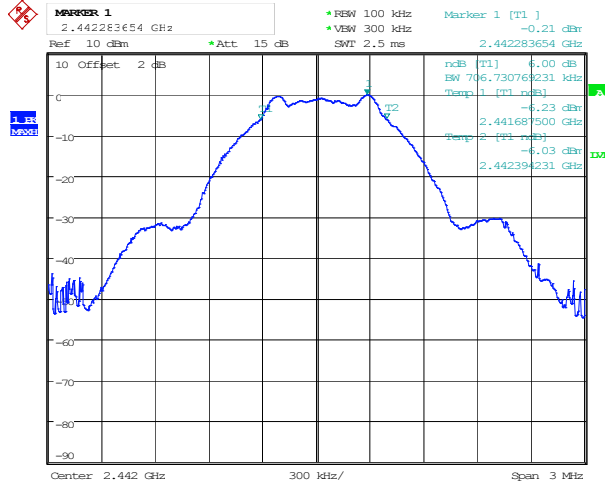

Date: 24.JAN.2019 16:56:21

BLE Mode

2480 MHz

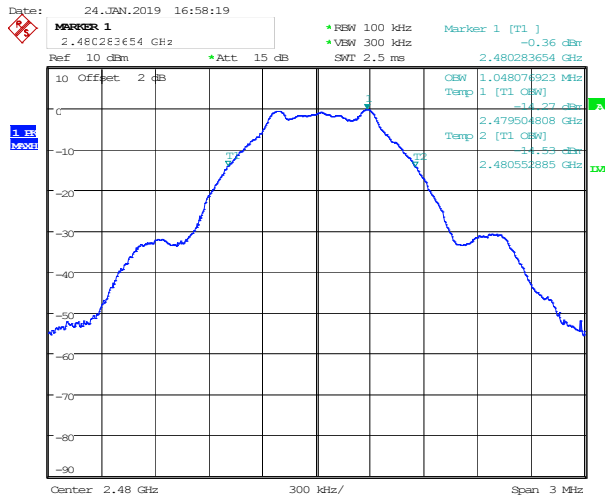
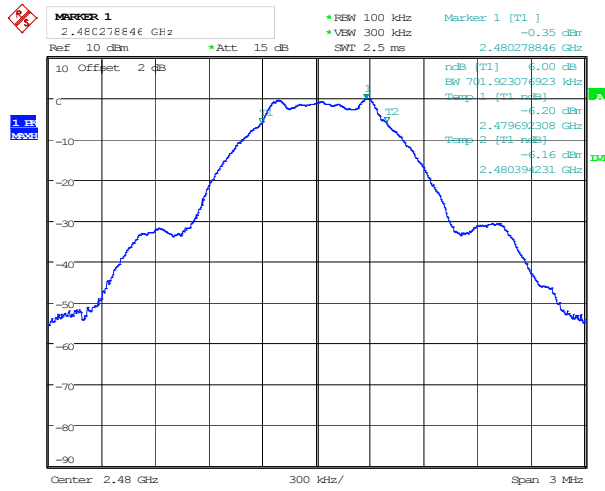

Date: 24.JAN.2019 16:57:14

3.5. Peak Output Power

Limit

Test Item	Limit	Frequency Range(MHz)
Peak Output Power	1 Watt or 30dBm	2400~2483.5

Test Configuration

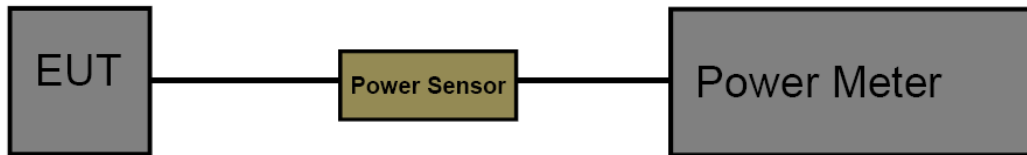

Test Procedure

1. The EUT was directly connected to the spectrum analyzer and antenna output port as show in the block diagram above.
2. Spectrum Setting:
Peak Detector: $RBW \geq DTS \text{ Bandwidth}$, $VBW \geq 3 * RBW$.
Sweep time=Auto.
Detector= Peak.
Trace mode= Maxhold.
Allow trace to fully stabilize. Then use the peak marker function to determine the maximum amplitude level.

Test Mode

Please refer to the clause 2.2

Test Result

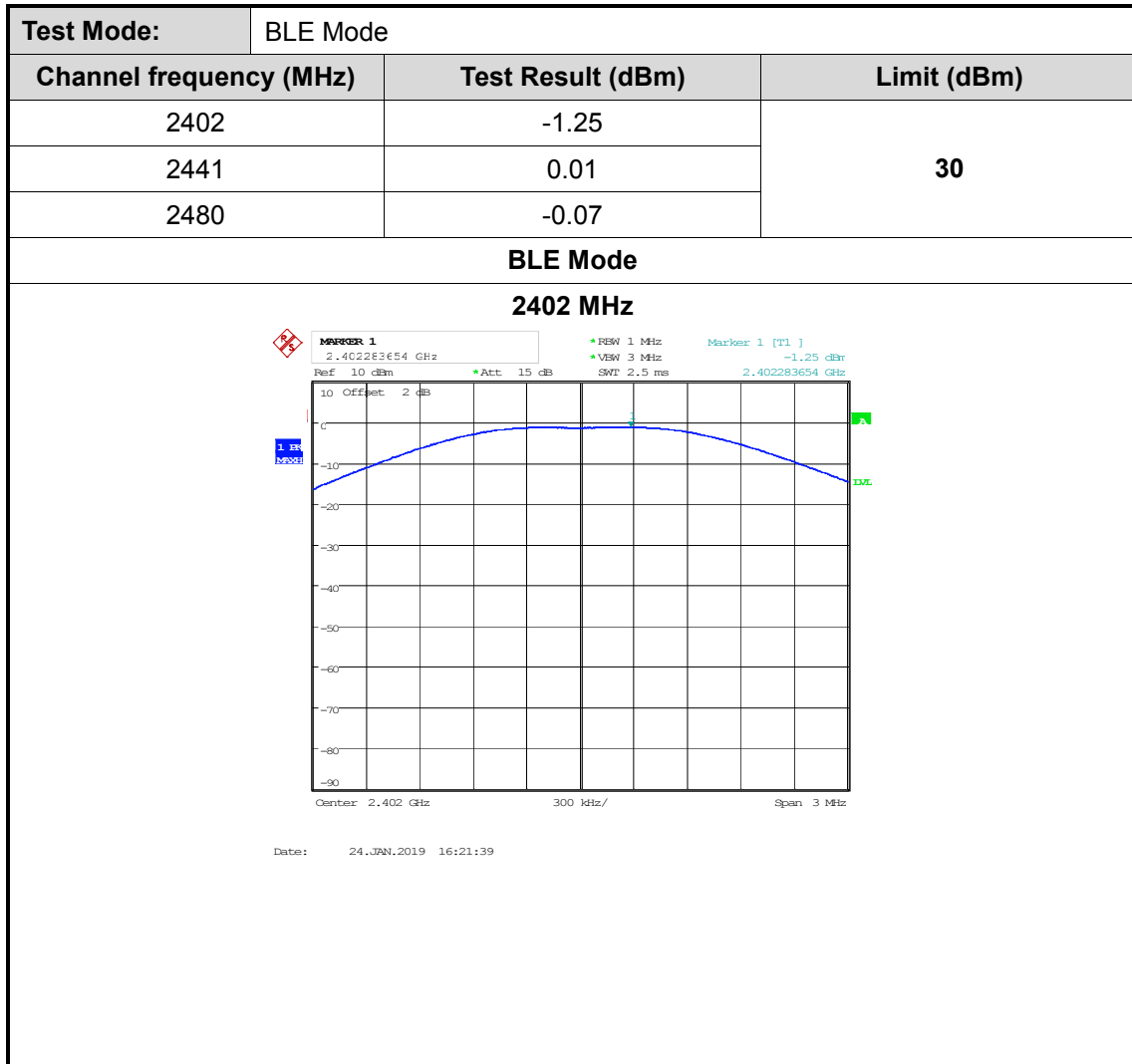



BLE Mode

2442 MHz

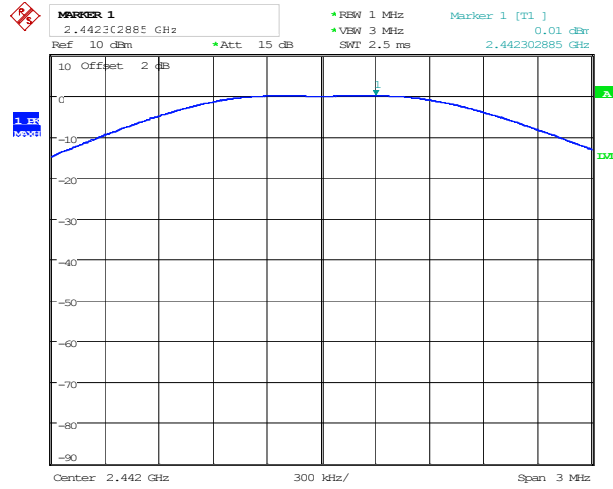

Date: 24.JAN.2019 17:00:42

BLE Mode

2480 MHz

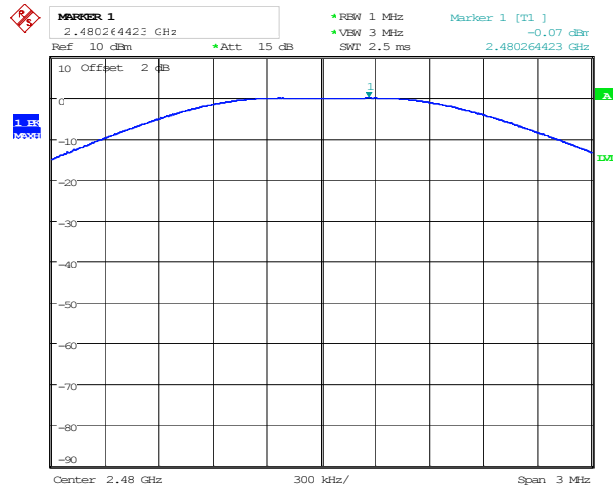

Date: 24.JAN.2019 17:01:42

3.6. Power Spectral Density

Limit

FCC Part 15 Subpart C(15.247)		
Test Item	Limit	Frequency Range(MHz)
Power Spectral Density	8dBm(in any 3 kHz)	2400~2483.5

Test Configuration

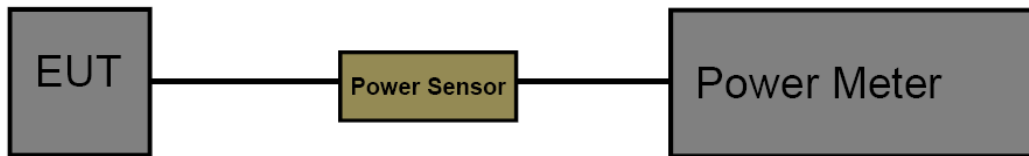

Test Procedure

1. The EUT was directly connected to the spectrum analyzer and antenna output port as show in the block diagram above.
2. The EUT was directly connected to the Spectrum Analyzer and antenna output port as show in the block diagram above. The measurement according to section 10.2 of KDB 558074 D01 DTS Meas Guidance v04.
3. Spectrum Setting:
 - Set analyser center frequency to DTS channel center frequency.
 - Set the span to 1.5 times the DTS bandwidth.
 - Set the RBW to: 3 kHz
 - Set the VBW to: 10 kHz
 - Detector: peak
 - Sweep time: auto
 - Allow trace to fully stabilize. Then use the peak marker function to determine the maximum amplitude level.

Test Mode

Please refer to the clause 2.2

Test Result

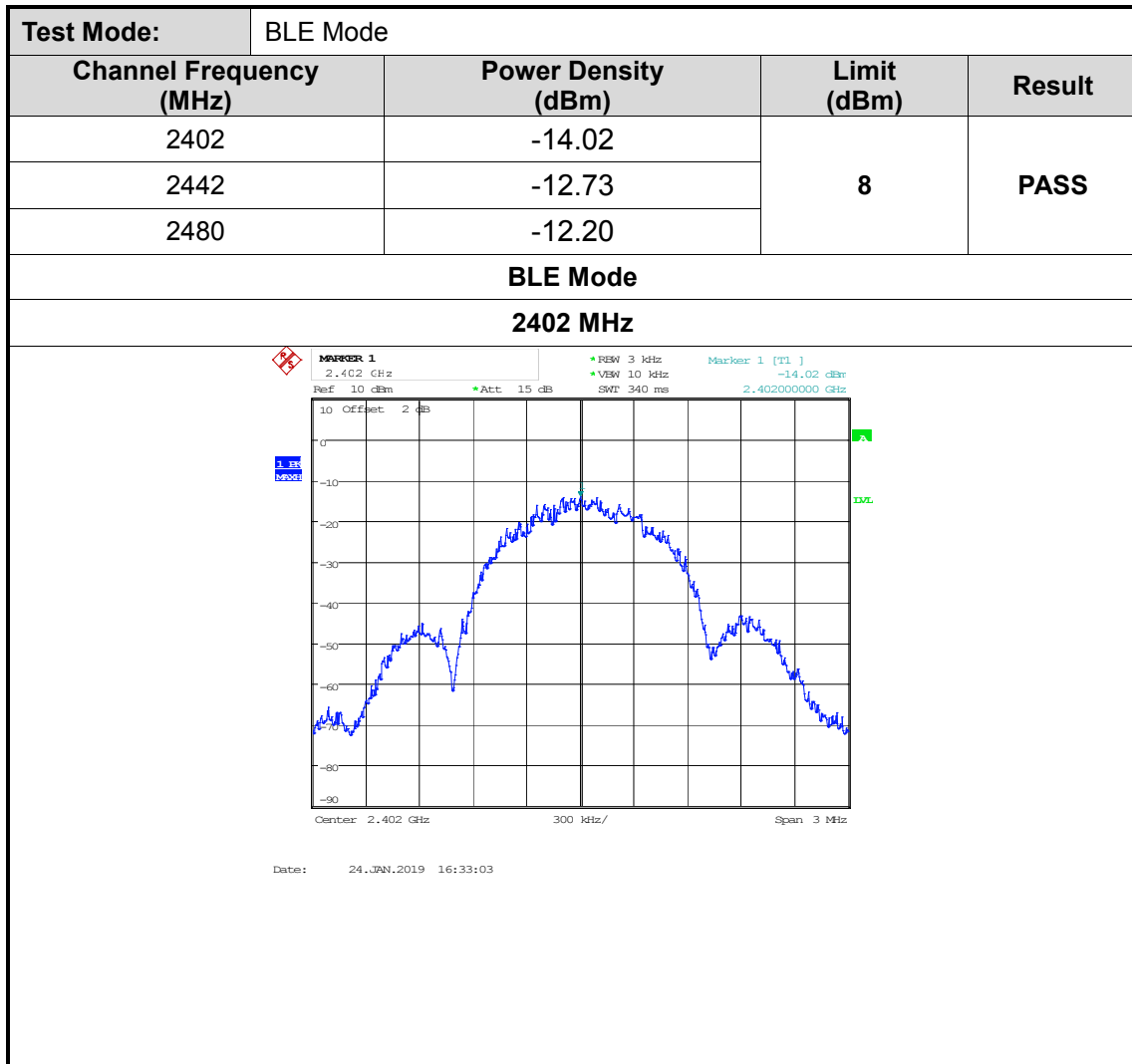

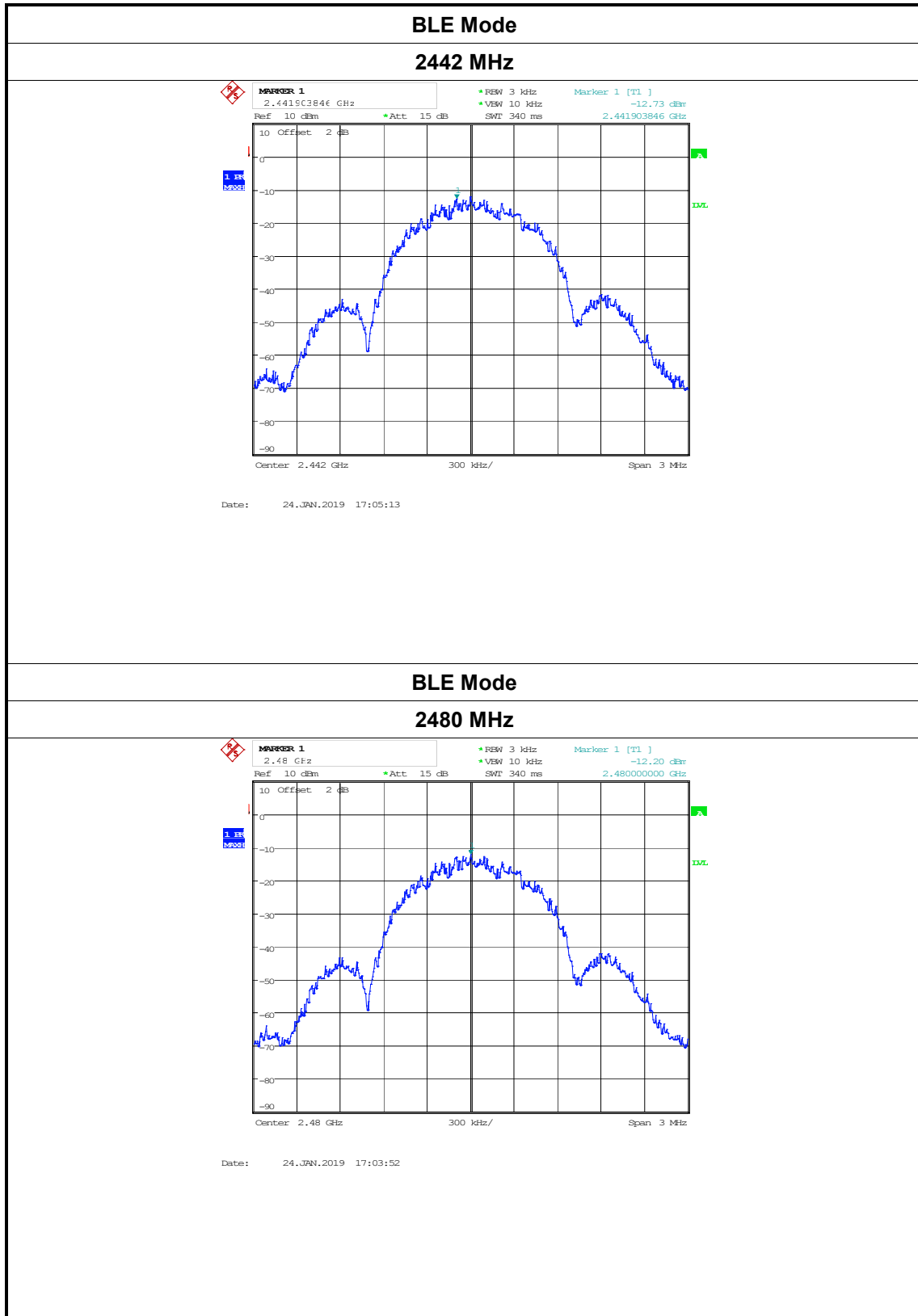



3.7. Antenna requirement

Requirement

FCC CFR Title 47 Part 15 Subpart C Section 15.203:

An intentional radiator shall be designed to ensure that no antenna other than that furnished by the responsible party shall be used with the device. The use of a permanently attached antenna or of antenna that uses a unique coupling to the intentional radiator, the manufacturer may design the unit so that a broken antenna can be replaced by the user, but the use of a standard antenna jack or electrical connector is prohibited.

FCC CFR Title 47 Part 15 Subpart C Section 15.247(c) (1)(i):

(i) Systems operating in the 2400~2483.5 MHz band that is used exclusively for fixed. Point-to-point operations may employ transmitting antennas with directional gain greater than 6dBi provided the maximum conducted output power of the intentional radiator is reduced by 1 dB for every 3 dB that the directional gain of the antenna exceeds 6dBi.

Test Result

The EUT's antenna is soldered to the PCB. The gain of the antenna is -6.98 dBi. Meet the standards.

Please reference to the annex: Internal photos



4.EUT TEST PHOTOS

Please reference to the annex: Test Photo



5.PHOTOGRAPHS OF EUT CONSTRUCTIONAL

Please reference to the annex: EUT Photo

*****THE END*****