

TEST REPORT

Testing Laboratory:**SK Tech Co., Ltd.**

88, Geulgaetul-ro, 81beon-gil,

Wabu-eup, Namyangju-si,

Gyeonggi-do, Korea

TEL: +82-31-576-2204

FAX: +82-31-576-2205

Test Report Number: SKT-RFC-220005**Date of issue: October 7, 2022****Applicant:****KYUNGWOO SYSTECH INC.**#401, Daeryung Post Tower 5, 68, Digital-ro 9, Geumcheon-gu, Seoul,
South Korea**Manufacturer:****KYUNGWOO SYSTECH INC.**#401, Daeryung Post Tower 5, 68, Digital-ro 9, Geumcheon-gu, Seoul,
South Korea**Product:**

SMK CONTROLLER UNIT

Model:**SMK-DWS-00****FCC ID:**

ZE8- SMK-DWS-00

Project number:

SKTEU22-0958

EUT received:

July 6, 2022

Applied standards:

ANSI C63.10-2020

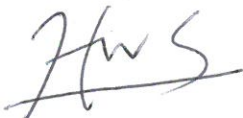
ANSI C63.4-2014 and ANSI C63.4a-2017

Rule parts:

FCC Part 15 Subpart C - Intentional radiators

Equipment Class:**DSC - Part 15 Security/Remote Control Transmitter****Remarks to the standards:** None

The above equipment has been tested by SK Tech Co., Ltd., and found compliance with the requirements set forth in the technical standards mentioned above. The results of testing in this report apply only to the product or system, which was tested.

Wonsik Ham / **Testing Engineer**Jongsoo Yoon / **Technical Manager**

This report shall not be reproduced except in full, without the written approval of SK Tech Co., Ltd. The client should not use it to claim product endorsement by any government agencies.



Revision History of Test Report

Rev.	Revisions	Effect page	Approved by	Date
-	Initial issue	All	Jongsoo Yoon	Oct. 7, 2022



TABLE OF CONTENTS

1	Summary of test results	4
2	Description of equipment under test (EUT)	5
3	Test and measurement conditions	6
	3.1. Test configuration (arrangement of EUT)	6
	3.2. Description of support units (accessory equipment).....	6
	3.3. Interconnection and I/O cables	6
	3.4. Measurement Uncertainty (<i>U</i>)	6
	3.5. Test date	6
4	Facilities and accreditations	7
	4.1. Facilities.....	7
	4.2. Accreditations	7
	4.3. List of test and measurement instruments.....	7
5	Test and measurements	8
	5.1. Antenna requirement	8
	5.2. 20 dB Emission Bandwidth.....	9
	5.3. Transmission Time.....	11
	5.4. Radiated emissions	14



1 Summary of test results

Requirement	CFR 47 Section	Result
Antenna Requirement	15.203	Meets the requirements
20dB Emission Bandwidth	15.231(c)	Meets the requirements
Transmission Time	15.231(a)	Meets the requirements
Spurious Emission, Band Edge, and Restricted bands	15.231(b), 15.205(a), 15.209(a)	Meets the requirements
AC power line Conducted emissions	15.207(a)	N/A

Note: *The EUT is operated from the battery (DC 12 V or DC 24 V) in a vehicle, and therefore the test suites related to AC Mains port were not applicable.*



2 Description of equipment under test (EUT)

Product: SMK CONTROLLER UNIT
 Model: SMK-DWS-00
 Serial number: None (prototype)

Model differences:

Model name	Difference	Tested (checked)
SMK-DWS-00	fully tested model that was provided by the applicant	<input checked="" type="checkbox"/>

Technical data:

Power source	DC 12 V / DC 24 V (powered from the battery in a vehicle)	
Local Oscillator or X-Tal	4 MHz, 8 MHz, 16 MHz, 26 MHz	
Transmit Frequency	433.92 MHz	133 kHz
Antenna Type	Integral chip antenna	Integral loop coil antenna (3 pcs)
Type of Modulation	GFSK	ASK
RF Output power	96.9 dB μ V/m (PEAK) (measured @ 3m)	92.1 dB μ V/m(AVERAGE) (measured @ 3m)

Note: * The test report for Equipment Class DCD was issued with other test report number.

** The test report for the compliance with FCC Part 15B as a digital device was issued with other test report number.

I/O port	Type	Q'ty	Remark
CN1	26-pin connector (DC IN, ACC, Actuator, etc.)	1	
CN2	16-pin connector (LF ANT, SSB ANT, CAN. etc.)	1	

Modification of EUT during the compliance testing:

The two test samples were provided for the tests; SAMPLE #1 was modified to transmit RF signal continuously. SAMPLE #2 was used the normal operation for the measurements of Transmission Time.

The firmware of the EUTs was modified as below:

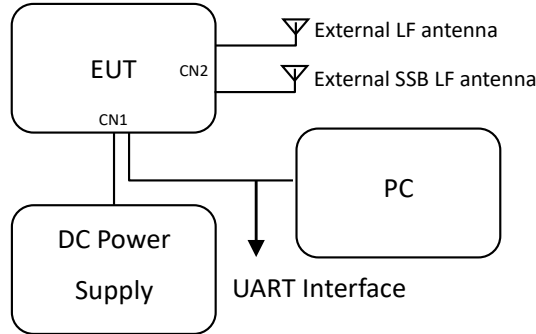
- (a) In the normal operation, the product shortly transmitted RF signals. Therefore the SAMPLE #1 was modified for the tests in order to transmit the RF signals continuously as described on the page 16. The SAMPE #1 were operated in the test mode by using Tera Term Progam to change the operating mode (Unmodulated TX 433.92 MHz, Stand-by, Internal LF 133 kHz TX, External LF 133 kHz TX, External SSB LF 134 kHz TX, and then Modulated 433.92 MHz).



3 Test and measurement conditions

3.1. Test configuration (arrangement of EUT)

The EUT was operated from DC Power Supply (12 V or 24 V). The measurements were taken while the EUT (SAMPLE #1) was transmitting the RF signals continuously. For the radiated measurements, the PC was removed after setting the EUT in transmitting mode.



NOTE: the Transmission Time was measured in the normal operation for the EUT (SAMPLE #2; without the firmware modification used for the continuous operation of SAMPLE #1). The RF signals manually transmitted when pairing with SMK FOB (FCC ID: ZE8-SMK-DWS-01, model SMK-DWS-01) in order for the EUT to register SMK FOB. The software (SMK_DWS_JIG.exe) was used to activate the EUT during the Transmission Time measurements. The Test jig was connected for the normal operation.

3.2. Description of support units (accessory equipment)

The following support units or accessories were used to form a representative test configuration during the tests.

#	Equipment	Manufacturer	Model No.	Serial No.
1	DC Power Supply	HP	6633A	2838A-01000

3.3. Interconnection and I/O cables

The following support units or accessories were used to form a representative test configuration during the tests.

#	Start		End		Cable	
	Name	I/O port	Name	I/O port	length (m)	shielded (Y/N)
1	EUT	DC IN	DC Power Supply	DC OUT	2.0	N

Note: 1) All the equipment/cables were placed in the worst-case configuration to maximize the emission during the test.
2) Grounding was established in accordance with the manufacturer's requirements and conditions for the intended use.

3.4. Measurement Uncertainty (U)

Measurement Item	Combined Standard Uncertainty U_c	Expanded Uncertainty $U = k \times U_c (k = 2)$
Conducted RF power	±0.64 dB	±1.28 dB
Conducted emissions	±1.4 dB	±2.8 dB
Radiated emissions (9 kHz to 30 MHz)	±1.45 dB	±2.9 dB
Radiated emissions (30 MHz to 1000 MHz)	±2.5 dB	±5.0 dB
Radiated emissions (1 GHz to 6 GHz)	±2.5 dB	±5.0 dB

3.5. Test date

Date Tested	August 30, 2022 – September 16, 2022
-------------	--------------------------------------



4 Facilities and accreditations

4.1. Facilities

All of the measurements described in this report were performed at SK Tech Co., Ltd.

Site I: 88, Geulgaetul-ro, 81beon-gil, Wabu-eup, Namyangju-si, Gyeonggi-do, Korea

Site II: 124-8, Geulgaetul-ro, Wabu-eup, Namyangju-si, Gyeonggi-do, Korea

The sites are constructed in conformance with the requirements of ANSI C63.4 and CISPR 16-1-4. The sites comply with the Normalized Site Attenuation requirements given in ANSI C63.4, and site VSWR requirements specified in CISPR 16-1-4. The FAR used for the radiated spurious emissions fulfills the NSA requirements specified in ETSI TS 102 321 V1.1.1 (2004-05) and ETSI TR 102 273-2 V1.2.1 (2001-12). The measuring apparatus and ancillary equipment conform to CISPR 16-1 series.

4.2. Accreditations

The laboratory has been also notified to FCC and ISED by RRA as a Conformity Assessment Body, and designated to perform compliance testing on equipment subject to Certification under Parts 15, 18, 22, 24, 25, 27, 74, 90, 95, 97 and 101 of the FCC Rules, and RSS-GEN, RSS-170, RSS-210, RSS-247, RSS-248, and RSS-102 (RF Exp.)^{MEAS}.

Designation No.	KR0007
Company Number (IC)	5429A

4.3. List of test and measurement instruments

No	Description	Model	Manufacturer	Serial No.	Cal. due	Use
1	Spectrum Analyzer	E4405B	Agilent	US40520856	2023.02.07	<input checked="" type="checkbox"/>
2	EMI Test Receiver	ESR26	Rohde&Schwarz	101441	2023.06.29	<input checked="" type="checkbox"/>
3	EMI Receiver	N9048B	Keysight	MY62220109	2023.09.15	<input checked="" type="checkbox"/>
4	Pre-amplifier (30 MHz - 1 GHz)	MLA-10K01-B01-27	TSJ	2005350	2023.05.11	<input checked="" type="checkbox"/>
5	Pre-amplifier (1 GHz - 18 GHz)	MLA-0118-J01-40	TSJ	14879	2023.05.09	<input checked="" type="checkbox"/>
6	Attenuator (6dB)	18N5W	API Technology	-	2023.06.08	<input checked="" type="checkbox"/>
7	High Pass Filter	WHKE3-500.2-610-4000-40SS	Wainwright	1	2023.05.11	<input checked="" type="checkbox"/>
8	High Pass Filter	WHKX 1.0/15G-12SS	Wainwright	17	2023.05.11	<input checked="" type="checkbox"/>
9	Loop Antenna	HFH2-Z2E	Rohde&Schwarz	100883	2023.12.16	<input checked="" type="checkbox"/>
10	BILOG Broadband Antenna	VULB9168	Schwarzbeck	9168-230	2023.06.08	<input checked="" type="checkbox"/>
11	Horn Antenna (1 GHz - 18 GHz)	3117	ETS-LINDGREN	00205960	2023.06.07	<input checked="" type="checkbox"/>
12	DC Power Supply	6633A	HP	2838A-01000	2023.05.09	<input checked="" type="checkbox"/>
13	Vector Signal Generator	E4438C	Agilent	MY42080359	2023.02.07	<input checked="" type="checkbox"/>
14	Digital Thermo-Hygrometer	608-H1	Testo	41383411	2023.05.20	<input checked="" type="checkbox"/>



5 Test and measurements

5.1. Antenna requirement

5.1.1 Regulation

An intentional radiator shall be designed to ensure that no antenna other than that furnished by the responsible party shall be used with the device. The use of a permanently attached antenna or of an antenna that uses a unique coupling to the intentional radiator shall be considered sufficient to comply with the provisions of this section. The manufacturer may design the unit so that a broken antenna can be replaced by the user, but the use of a standard antenna jack or electrical connector is prohibited. This requirement does not apply to carrier current devices or to devices operated under the provisions of §15.211, 15.213, 15.217, 15.219, 15.221, or §15.236. Further, this requirement does not apply to intentional radiators that must be professionally installed, such as perimeter protection systems and some field disturbance sensors, or to other intentional radiators which, in accordance with §15.31(d), must be measured at the installation site. However, the installer shall be responsible for ensuring that the proper antenna is employed so that the limits in this part are not exceeded.

5.1.2 Result: **PASS**

The EUT has an internal chip antenna and meets the requirements of this section.



5.2. 20 dB Emission Bandwidth

5.2.1 Regulation

According to §15.231(c), The bandwidth of the emission shall be no wider than 0.25 % of the center frequency for devices operating above 70 MHz and below 900 MHz. Bandwidth is determined at the points 20 dB down from the modulated carrier.

5.2.2 Test Procedure

The EUT repeatedly transmitted RF signals and the small antenna, to which the Spectrum Analyzer was connected, placed in the vicinity of the EUT. The Occupied Bandwidth (99 %) and 20 dB emission bandwidth were measured with the following setting according to ANSI C63.10, 12.4.

- (a) Set RBW = approximately 1 % of the emission bandwidth
- (b) Set the VBW > RBW
- (c) Detector = peak
- (d) Trace mode = max hold

5.2.3 Test Results: **PASS**

Table 1: Measured values of the 20 dB Emission Bandwidth

Operated from DC 12 V

Operating frequency	Occupied Bandwidth (99 %)	20 dB Emission Bandwidth	Limit
433.92 MHz	68.8 kHz	69.7 kHz	< 1084.8 kHz

Operated from DC 24 V

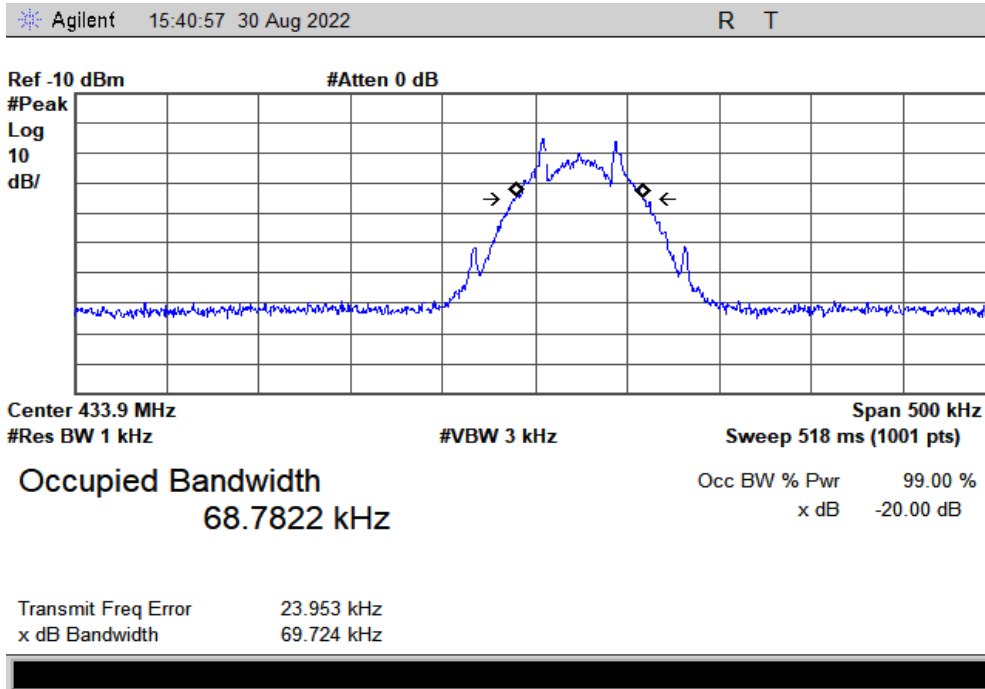
Operating frequency	Occupied Bandwidth (99 %)	20 dB Emission Bandwidth	Limit
433.92 MHz	68.5 kHz	68.8 kHz	< 1084.8 kHz

** The small loop antenna with 50 Ω connector was used as a field probe. The small loop antenna was located at the proximity of the EUT, and fixed not to influence the measuring results.

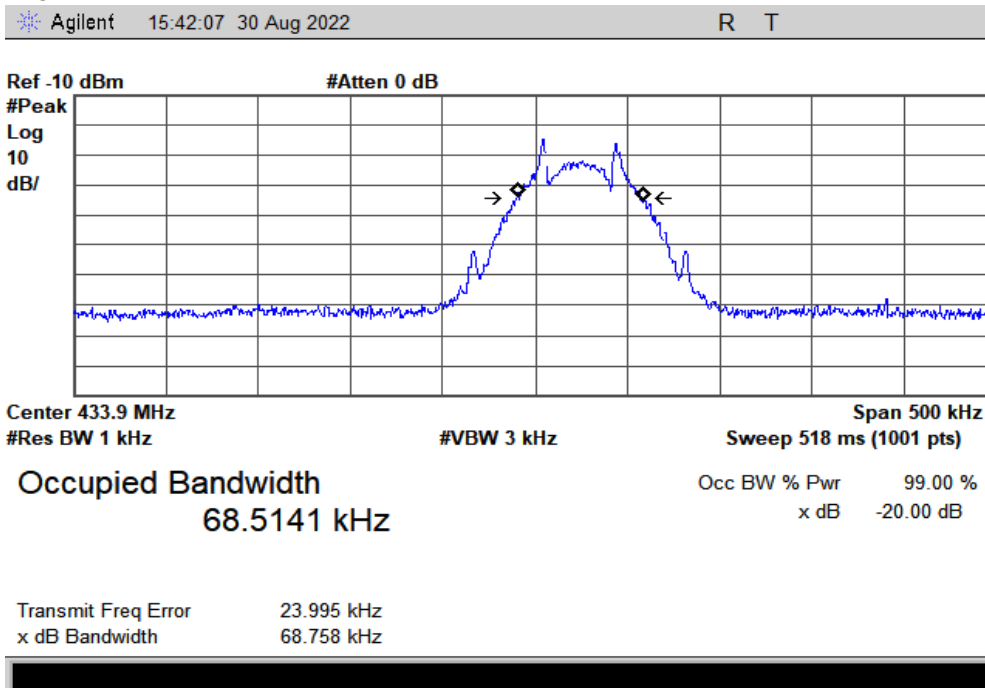


Figure 1. Plot of the 20 dB Emission Bandwidth & Occupied Bandwidth

Operated from DC 12 V



Operated from DC 24 V





5.3. Transmission Time

5.3.1 Regulation

- (1) A manually operated transmitter shall employ a switch that will automatically deactivate the transmitter within not more than 5 seconds of being released.
- (2) A transmitter activated automatically shall cease transmission within 5 seconds after activation.
- (3) Periodic transmissions at regular predetermined intervals are not permitted. However, polling or supervision transmissions, including data, to determine system integrity of transmitters used in security or safety applications are allowed if the total duration of transmissions does not exceed more than two seconds per hour for each transmitter. There is no limit on the number of individual transmissions, provided the total transmission time does not exceed two seconds per hour.

5.3.2 Test Procedure

The EUT transmitted RF signals and the small antenna, to which the Spectrum Analyzer was connected, placed in the vicinity of the EUT. The Transmission Time was measured in the normal operating conditions for pairing with SMART KEY FOB after sending the RF command by the software. The Spectrum Analyzer was set as below:

- (a) Set the center frequency to the operating frequency
- (b) Set RBW > 20 dB Emission Bandwidth (or Occupied Bandwidth)
- (c) Set Trigger level to start the measurement when the EUT transmitted RF signals
- (d) Set Sweep time to capture the pulse trains and/or to capture the burst ON time

5.3.3 Test Results: **PASS**

Table 2: Measured values of the Transmission Time

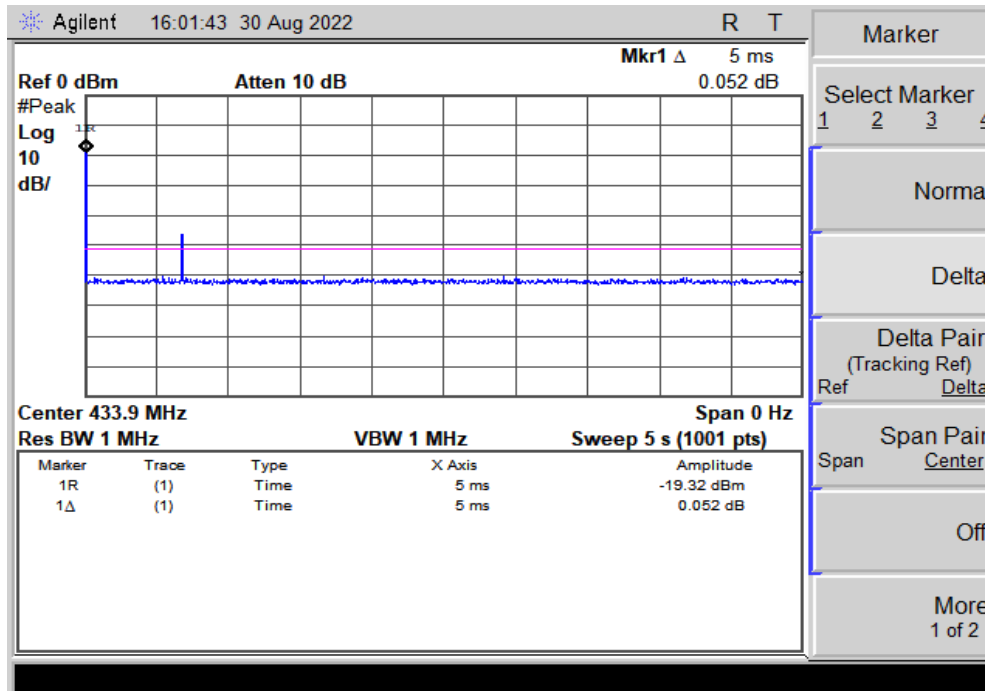
Operated from DC 12 V

Operating frequency	Transmission Type	Transmission Time	Limit
		[ms]	[s]
433.92 MHz	Manually	5	5

Operated from DC 24 V

Operating frequency	Transmission Type	Transmission Time	Limit
		[ms]	[s]
433.92 MHz	Manually	5	5

** The small loop antenna with 50 Ω connector was used as a field probe. The small loop antenna was located at the proximity of the EUT, and fixed not to influence the measuring results.

Figure 2. Plot of the Transmission Time (Operated from DC 12 V)


Manual transmission when sending the RF command for pairing with SMK FOB by the software [remark: one burst signal with lower signal level was for SMK FOB]

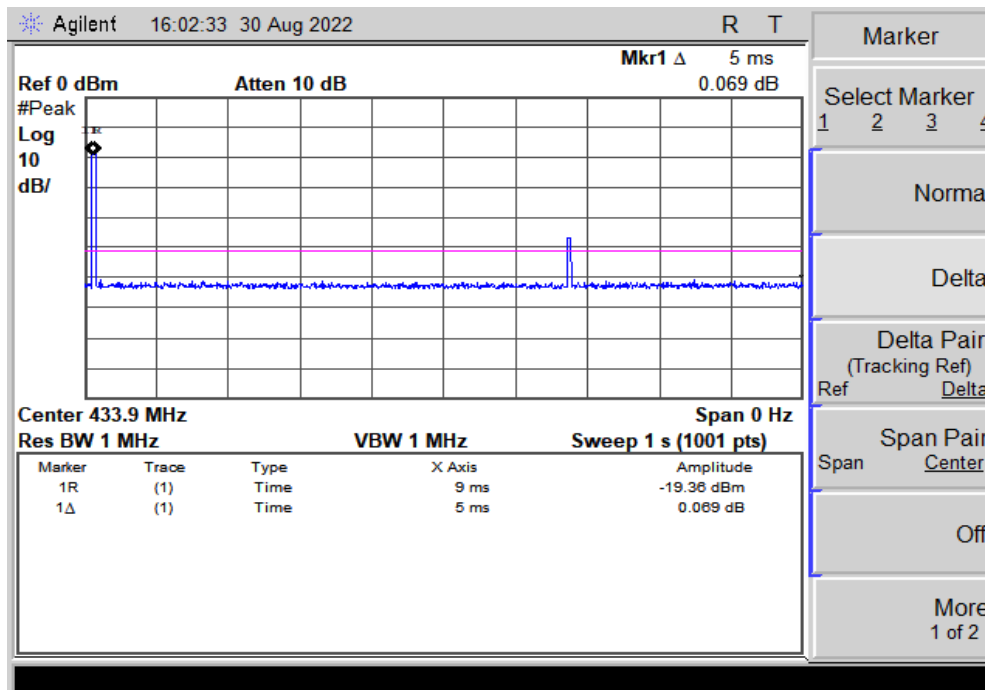
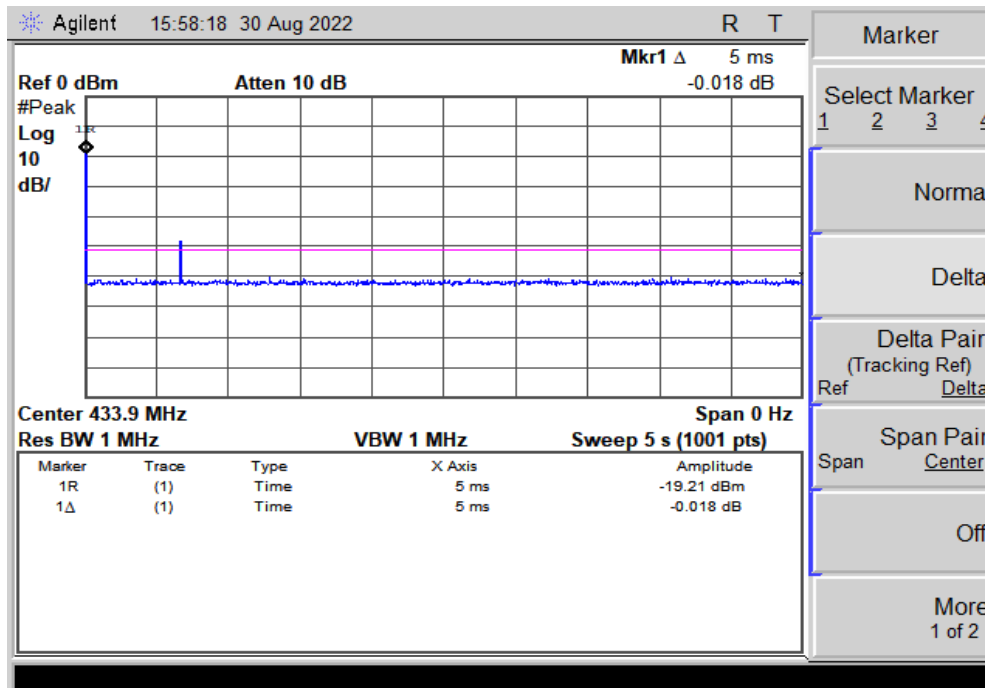
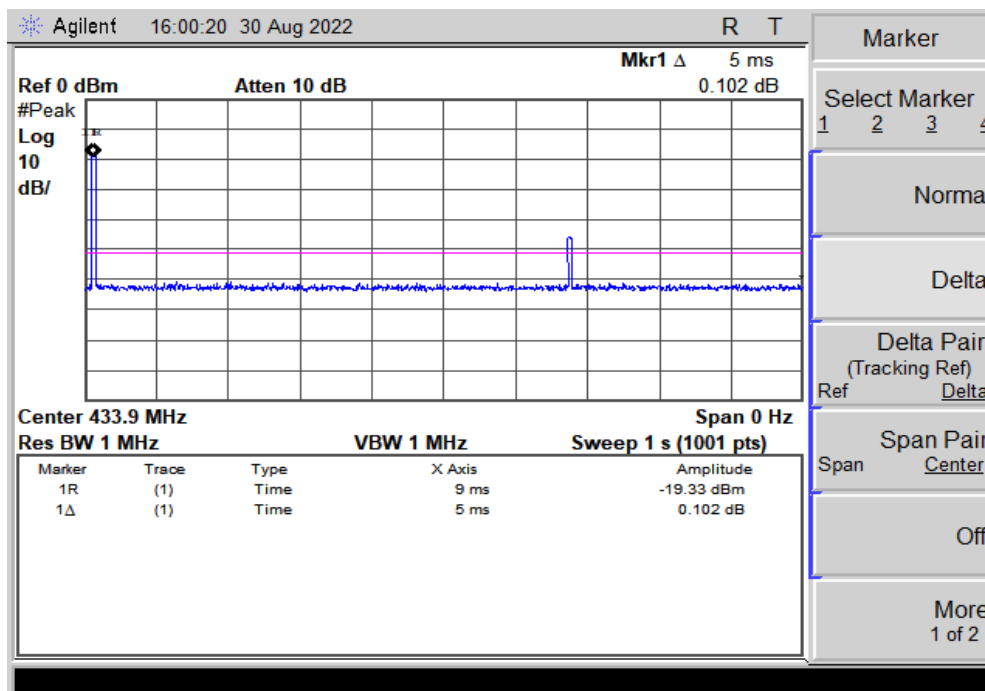


Figure 2. Plot of the Transmission Time (Operated from DC 24 V)


Manual transmission when sending the RF command for pairing with SMK FOB by the software
 [remark: one burst signal with lower signal level was for SMK FOB]





5.4. Radiated emissions

5.4.1 Regulation

FCC 47CFR15 – 15.231

According to §15.231(b), the field strength of emissions from intentional radiators operated under this section shall not exceed the following:

Fundamental frequency (MHz)	Field strength of fundamental (µV/m) @ 3 m	Field strength of spurious emissions (µV/m) @ 3 m
40.66 – 40.70	2,250	225
70 – 130	1,250	125
130 – 174	1,250 to 3,750**	125 to 375**
174 – 260	3,750	375
260 – 470	3,750 to 12,500**	375 to 1,250**
Above 470	12,500	1,250

** linear interpolations

Intentional radiators operating under the provisions of this section shall demonstrate compliance with the limits on the field strength of emissions, as shown in the above table, based on the average value of the measured emissions. As an alternative, compliance with the limits in the above table may be based on the use of measurement instrumentation with a CISPR quasi-peak detector. The specific method of measurement employed shall be specified in the application for equipment authorization. If average emission measurements are employed, the provisions in §15.35 for averaging pulsed emissions and for limiting peak emissions apply. Further, compliance with the provisions of §15.205 shall be demonstrated using the measurement instrumentation specified in that section.

The limits on the field strength of the spurious emissions in the above table are based on the fundamental frequency of the intentional radiator. Spurious emissions shall be attenuated to the average (or, alternatively, CISPR quasi-peak) limits shown in this table or to the general limits shown in §15.209, whichever limit permits a higher field strength.

FCC 47CFR15 – 15.209

(a) Except as provided elsewhere in this Subpart, the emissions from an intentional radiator shall not exceed the field strength levels specified in the following table:

Frequency (MHz)	Field strength limit (µV/m)	Field strength limit (dBµV/m)	Measurement Distance (m)
0.009 – 0.490	2400/F (kHz) = 266.7 – 4.9	48.5 – 13.8	300
0.490 – 1.705	24000/F (kHz) = 49.0 – 14.1	33.8 – 23.0	30
1.705 – 30.0	30	29.5	30
30 – 88	100	40.0	3
88 – 216	150	43.5	3
216 – 960	200	46.0	3
Above 960	500	54.0	3



5.4.2 Measurement Procedure

The EUT repeatedly transmitted RF signals and the following measurement procedure specified in ANSI C63.10-2020 was used.

Radiated Emissions Test, 9 kHz to 30 MHz (Magnetic Field Test)

- (a) The preliminary radiated measurements were performed to determine the frequency producing the maximum emissions at a distance of 3 meters according to Section 15.31(f)(2).
- (b) The EUT was placed on the top of the 0.8-meter height, 1 × 1.5 meter non-metallic table.
- (c) Emissions from the EUT are maximized by adjusting the orientation of the Loop antenna and rotating the EUT on the turntable. Manipulating the system cables also maximizes EUT emissions if applicable.
- (d) To obtain the final measurement data, each frequency found during preliminary measurements was re-examined and investigated. The test-receiver system was set up to average, peak, and quasi-peak detector function with specified bandwidth.
- (e) The EUT was situated in three orthogonal planes (if appropriate).

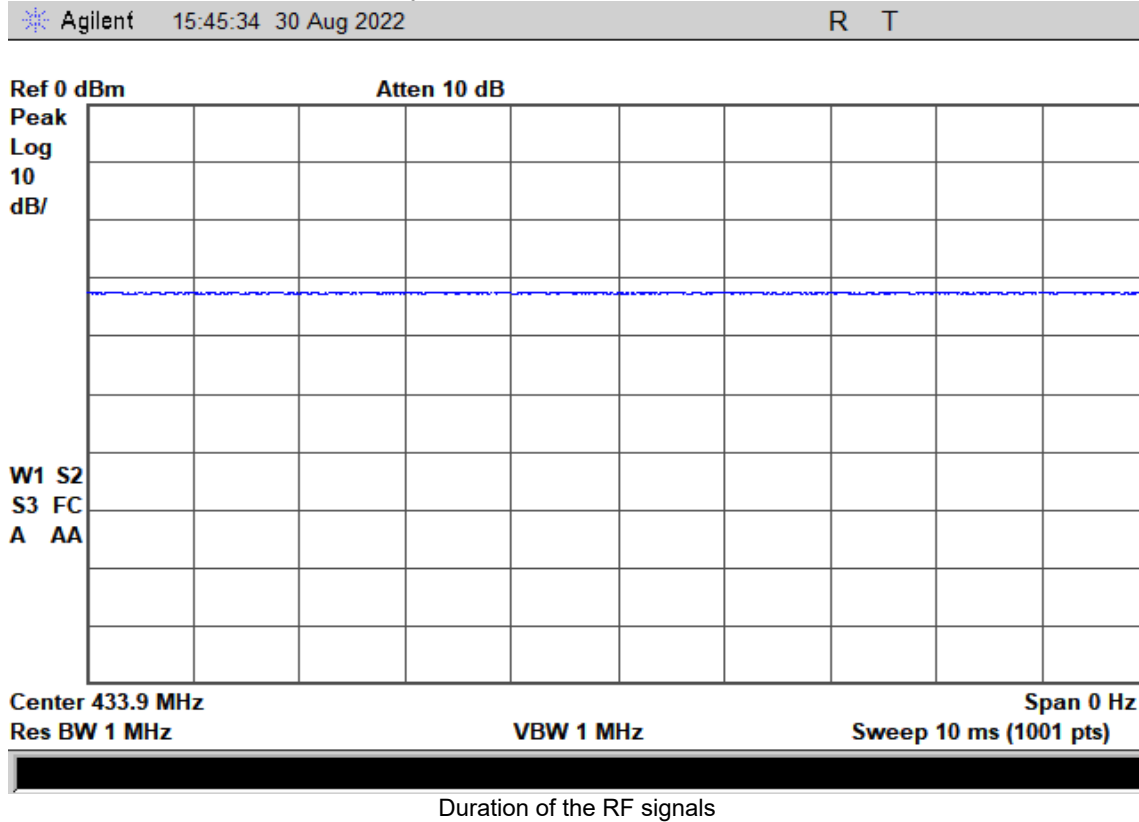
Radiated Emissions Test, above 30 MHz

- (a) The preliminary radiated measurements were performed to determine the frequency producing the maximum emissions in an anechoic chamber at a distance of 3 meters.
- (b) The EUT was placed on the top of the 0.8-meter height (or 1.5 meter height for above 1 GHz), 1 × 1.5 meter non-metallic table. To find the maximum emission levels, the height of a measuring antenna was changed and the turntable was rotated 360°.
- (c) The antenna polarization was also changed from vertical to horizontal. The spectrum was scanned from 30 to 1000 MHz using the Bilog broadband antenna, and from 1 GHz to tenth harmonic of the highest fundamental frequency using the horn antenna.
- (d) Each frequency found during preliminary measurements was re-examined and investigated. The test-receiver system was set up to average, peak, and quasi-peak detector function with specified bandwidth.
- (e) The EUT was situated in three orthogonal planes (if appropriate).

Measurement software: TEPTO-DV/RE_Version: 3.1.0044



Figure 3. RF signals during the measurements achieved by the modification of firmware EUT (SAMPLE#1) firmware modification transmits a signal when the button is released RF signal has been modified to transmit continuously



According to §ANSI 63.10 (7.5 Procedure for determining the average value of pulsed emissions)

Unless otherwise specified, when the radiated emission limits are expressed in terms of the average value of the emission, and pulsed operation is employed, the measurement field strength shall be determined by averaging over one complete pulse train, including blanking intervals, as long as the pulse train does not exceed 0.1 s (100 ms). In cases where the pulse train exceeds 0.1 s, the measured field strength shall be determined during a 0.1 s interval. The following procedure is an example of how the average value may be determined. The average field strength may be found by measuring the peak pulse amplitude (in log equivalent units) and determining the duty cycle correction factor (in dB) associated with the pulse modulation as shown in Equation

$$\delta(\text{dB}) = 20\log(\Delta)$$

δ is the duty cycle correction factor (dB)

Δ is the duty cycle (dimensionless)



5.4.3 Test Results:

PASS

Table 3: Measured values of the Field strength

For the measurements under below 30 MHz

Freq. (kHz)	RBW (kHz)	Reading (dBµV)			AF (dB/m)	Cable Loss (dB)	Actual (dBµV/m)			Limit (at 3m) (dBµV/m)			Margin (dB)			Remark
		PK	AV	QP			PK	AV	QP	PK	AV	QP	PK	AV	QP	
No Radiated Spurious Emissions Found																

Actual (dBµV/m) = Reading + AF + Cable Loss

Margin (dB) = Limit – Actual

Note: These test results were measured at the 3 m distance.

X-axis is worst-case configuration among 3 axis. So the measurements from 30 MHz to 1 GHz for 24 V was performed in X-axis only.

For the measurements from 30 MHz to 1 GHz (for X-axis, 12 V), except for the emissions in 15.205

Frequency (MHz)	Pol. (V/H)	Height (m)	Reading (dBµV)		AMP (dB)	AF (dB/m)	CL (dB)	DCCF (dB)	Actual (dBµV/m)		Limit (dBµV/m)		Margin (dB)	
			PK	AV					PK	AV	PK	AV	PK	AV
433.957	H	1.03	72.7	-	0	22.1	2.1	-26.0	96.9	70.9	100.8	80.8	3.9	9.9
433.957	V	1.00	69.4	-	0	22.1	2.1	-26.0	93.6	67.6	100.8	80.8	7.2	13.2

For the measurements from 30 MHz to 1 GHz (for X-axis, 24 V), except for the emissions in 15.205

Frequency (MHz)	Pol. (V/H)	Height (m)	Reading (dBµV)		AMP (dB)	AF (dB/m)	CL (dB)	DCCF (dB)	Actual (dBµV/m)		Limit (dBµV/m)		Margin (dB)	
			PK	AV					PK	AV	PK	AV	PK	AV
433.957	H	1.03	72.7	-	0	22.1	2.1	-26.0	96.9	70.9	100.8	80.8	3.9	9.9
433.957	V	1.00	69.6	-	0	22.1	2.1	-26.0	93.8	67.8	100.8	80.8	7.0	13.0

For the measurements from 30 MHz to 1 GHz (for Y-axis, 12 V), except for the emissions in 15.205

Frequency (MHz)	Pol. (V/H)	Height (m)	Reading (dBµV)		AMP (dB)	AF (dB/m)	CL (dB)	DCCF (dB)	Actual (dBµV/m)		Limit (dBµV/m)		Margin (dB)	
			PK	AV					PK	AV	PK	AV	PK	AV
433.955	H	1.00	70.3	-	0	22.1	2.1	-26.0	94.5	68.5	100.8	80.8	6.3	12.3
433.955	V	1.01	71.6	-	0	22.1	2.1	-26.0	95.8	69.8	100.8	80.8	5.0	11.0

For the measurements from 30 MHz to 1 GHz (for Z-axis, 12 V), except for the emissions in 15.205

Frequency (MHz)	Pol. (V/H)	Height (m)	Reading (dBµV)		AMP (dB)	AF (dB/m)	CL (dB)	DCCF (dB)	Actual (dBµV/m)		Limit (dBµV/m)		Margin (dB)	
			PK	AV					PK	AV	PK	AV	PK	AV
433.958	H	1.95	67.1	-	0	22.1	2.1	-26.0	91.3	65.3	100.8	80.8	9.5	15.5
433.958	V	1.00	70.6	-	0	22.1	2.1	-26.0	94.8	68.8	100.8	80.8	6.0	12.0

V/H: Vertical / Horizontal polarization

AMP, AF and CL: pre-amplifier gain, antenna factor and cable loss including an attenuator/filter if used

Peak Actual = Peak Reading - AMP + AF + CL

AV Actual = Peak Reading - AMP + AF + CL + DCCF

DCCF = 20*LOG(Transmission Time/100)

Margin = Limit – Actual



For the measurements from 30 MHz to 1 GHz with quasi-peak detector
(emissions in the restricted bands specified in 15.205)

Frequency (MHz)	Pol. (V/H)	Height (m)	Reading (dB μ V)	AMP (dB)	AF (dB/m)	CL (dB)	Actual (dB μ V/m)	Limit (dB μ V/m)	Margin (dB)	Remark
										No Radiated Spurious Emissions Found

V/H: Vertical / Horizontal polarization

AMP, AF and CL: pre-amplifier gain, antenna factor and cable loss including an attenuator/filter if used

Actual = Reading - AMP + AF + CL

Margin = Limit - Actual

remark: the Reading value was measured with PEAK detector, and the CISPR quasi-peak detector was not used because the PEAK values were low the QP limits.



For the measurements above 1 GHz (for X-axis, 12 V)

Frequency (MHz)	Pol. (V/H)	Height (m)	Reading (dBμV)		AMP (dB)	AF (dB/m)	CL (dB)	DCCF (dB)	Actual (dBμV/m)		Limit (dBμV/m)		Margin (dB)	
			PK	AV					PK	AV	PK	AV	PK	AV
1301.715	V	1.64	64.8	-	47.7	28.5	5.8	-26.0	51.4	25.4	80.8	60.8	29.4	35.4
1301.910	H	1.32	72.2	-	47.7	28.5	5.8	-26.0	58.8	32.8	80.8	60.8	22.0	28.0
1735.699	H	1.36	62.2	-	47.3	29.8	6.7	-26.0	51.4	25.4	80.8	60.8	29.4	35.4
3037.431	H	1.57	56.5	-	46.9	32.6	8.7	-26.0	50.9	24.9	80.8	60.8	29.9	35.9

For the measurements above 1 GHz (for Y-axis, 12 V)

Frequency (MHz)	Pol. (V/H)	Height (m)	Reading (dBμV)		AMP (dB)	AF (dB/m)	CL (dB)	DCCF (dB)	Actual (dBμV/m)		Limit (dBμV/m)		Margin (dB)	
			PK	AV					PK	AV	PK	AV	PK	AV
1301.877	V	1.67	74.2	-	47.7	28.5	5.8	-26.0	60.8	34.8	80.8	60.8	20.0	26.0
1301.970	H	1.40	60.4	-	47.7	28.5	5.8	-26.0	47.0	21.0	80.8	60.8	33.8	39.8

For the measurements above 1 GHz (for Z-axis, 12 V)

Frequency (MHz)	Pol. (V/H)	Height (m)	Reading (dBμV)		AMP (dB)	AF (dB/m)	CL (dB)	DCCF (dB)	Actual (dBμV/m)		Limit (dBμV/m)		Margin (dB)	
			PK	AV					PK	AV	PK	AV	PK	AV
1301.921	H	1.32	69.6	-	47.7	28.5	5.8	-26.0	56.2	30.2	80.8	60.8	24.6	30.6
1301.946	V	2.25	70.8	-	47.7	28.5	5.8	-26.0	57.4	31.4	80.8	60.8	23.4	29.4

V/H: Vertical / Horizontal polarization

AMP, AF and CL: pre-amplifier gain, antenna factor and cable loss including an attenuator/filter if used

Peak Actual = Peak Reading - AMP + AF + CL

AV Actual = Peak Reading - AMP + AF + CL + DCCF

DCCF = 20*LOG(Transmission On-time/100 ms)

Margin = Limit - Actual



For the measurements above 1 GHz (for X-axis, 24 V)

Frequency (MHz)	Pol. (V/H)	Height (m)	Reading (dB μ V)		AMP (dB)	AF (dB/m)	CL (dB)	DCCF (dB)	Actual (dB μ V/m)		Limit (dB μ V/m)		Margin (dB)	
			PK	AV					PK	AV	PK	AV	PK	AV
1301.915	V	1.69	61.7	-	47.7	28.5	5.8	-26.0	48.3	22.3	80.8	60.8	32.5	38.5
1301.929	H	1.35	72.4	-	47.7	28.5	5.8	-26.0	59.0	33.0	80.8	60.8	21.8	27.8

For the measurements above 1 GHz (for Y-axis, 24 V)

Frequency (MHz)	Pol. (V/H)	Height (m)	Reading (dB μ V)		AMP (dB)	AF (dB/m)	CL (dB)	DCCF (dB)	Actual (dB μ V/m)		Limit (dB μ V/m)		Margin (dB)	
			PK	AV					PK	AV	PK	AV	PK	AV
1301.785	V	1.78	74.3	-	47.7	28.5	5.8	-26.0	60.9	34.9	80.8	60.8	19.9	25.9
1301.790	H	1.31	59.8	-	47.7	28.5	5.8	-26.0	46.4	20.4	80.8	60.8	34.4	40.4

For the measurements above 1 GHz (for Z-axis, 24 V)

Frequency (MHz)	Pol. (V/H)	Height (m)	Reading (dB μ V)		AMP (dB)	AF (dB/m)	CL (dB)	DCCF (dB)	Actual (dB μ V/m)		Limit (dB μ V/m)		Margin (dB)	
			PK	AV					PK	AV	PK	AV	PK	AV
1301.880	V	2.34	70.7	-	47.7	28.5	5.8	-26.0	57.3	31.3	80.8	60.8	23.5	29.5
1301.883	H	1.27	68.5	-	47.7	28.5	5.8	-26.0	55.1	29.1	80.8	60.8	25.7	31.7

V/H: Vertical / Horizontal polarization

AMP, AF and CL: pre-amplifier gain, antenna factor and cable loss including an attenuator/filter if used

Peak Actual = Peak Reading - AMP + AF + CL

AV Actual = Peak Reading - AMP + AF + CL + DCCF

DCCF = 20*LOG(Transmission On-time/100 ms)

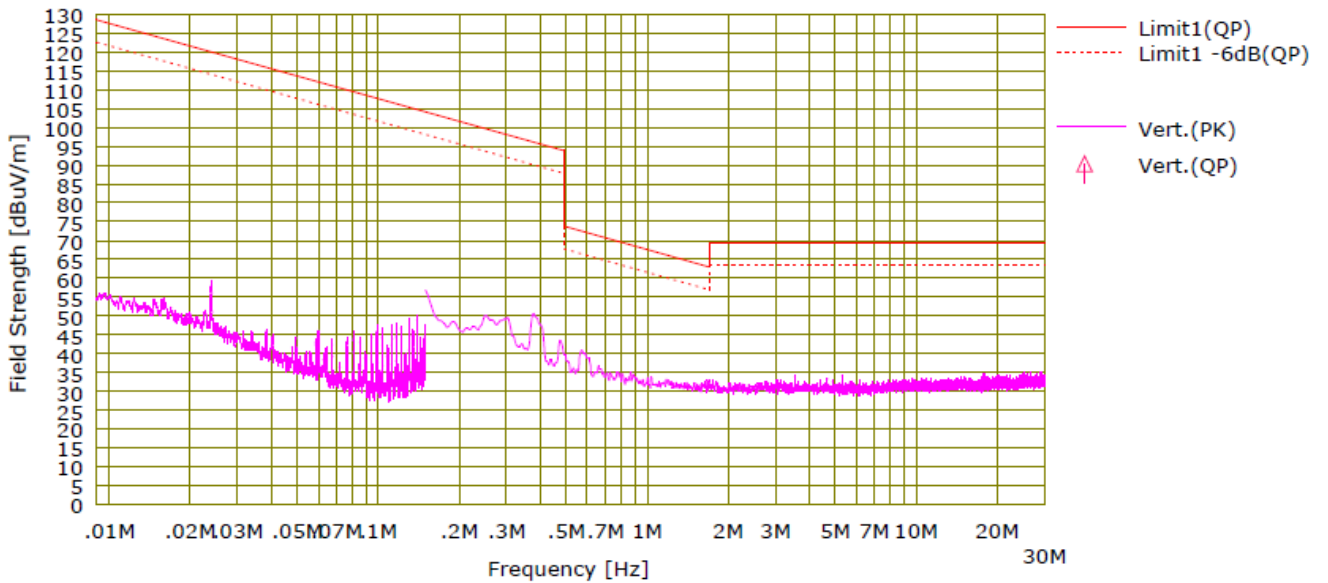
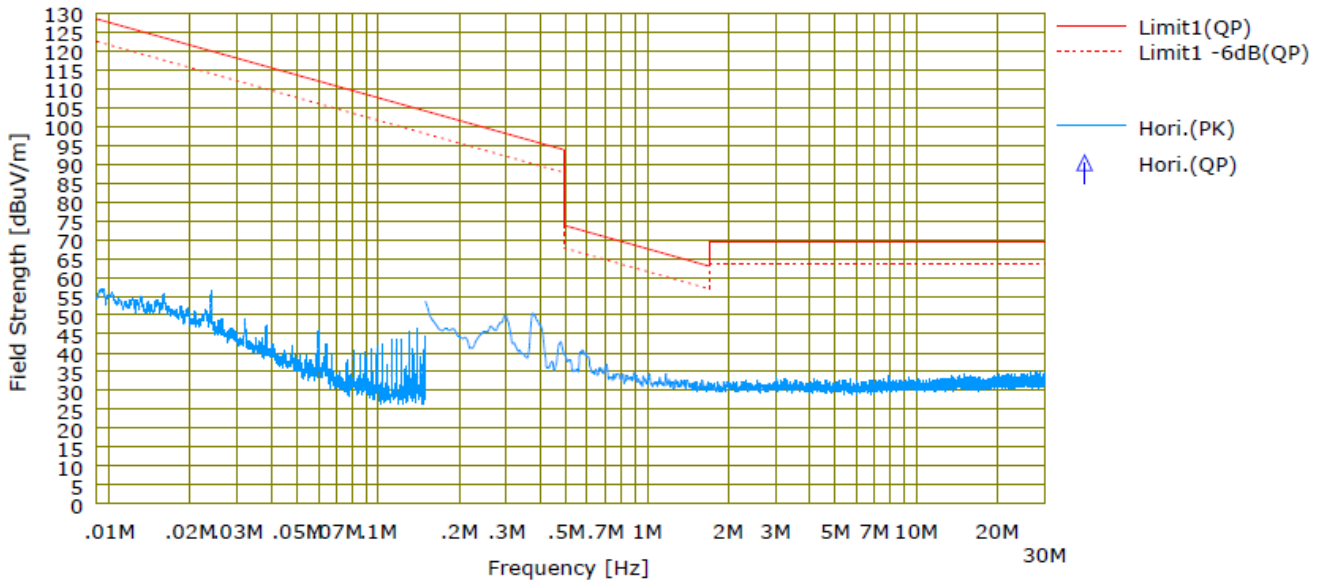
Margin = Limit - Actual

Figure 4. Emission plot for the preliminary radiated measurements

The worst-case plots were attached.

Frequency Range: 9 kHz ~ 30 MHz

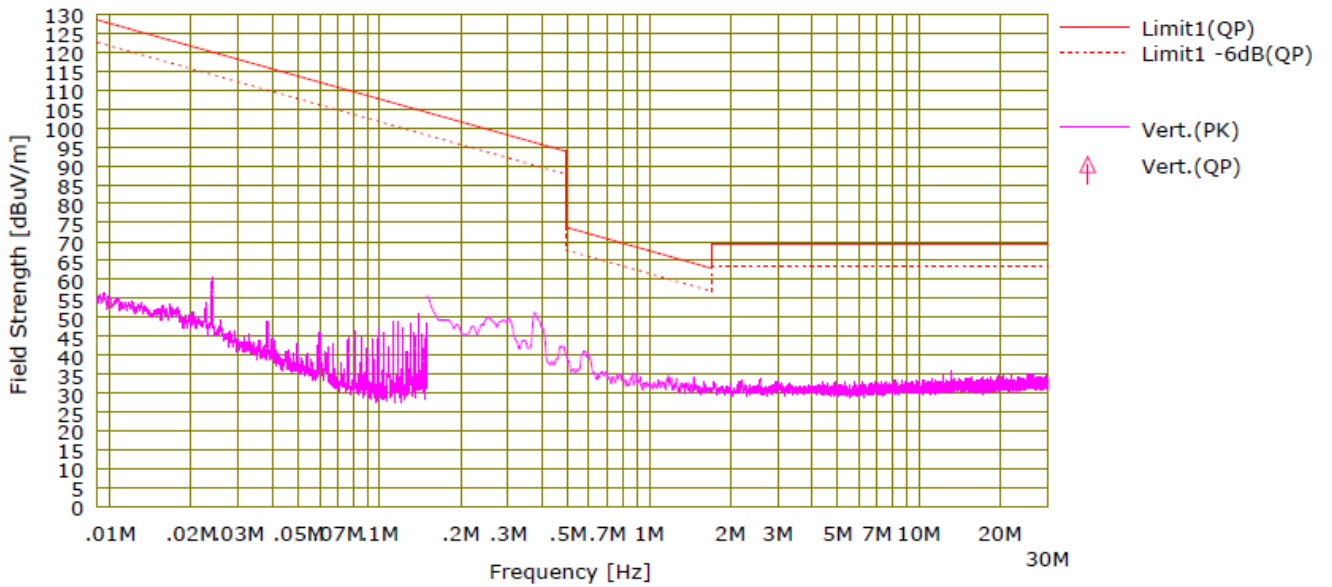
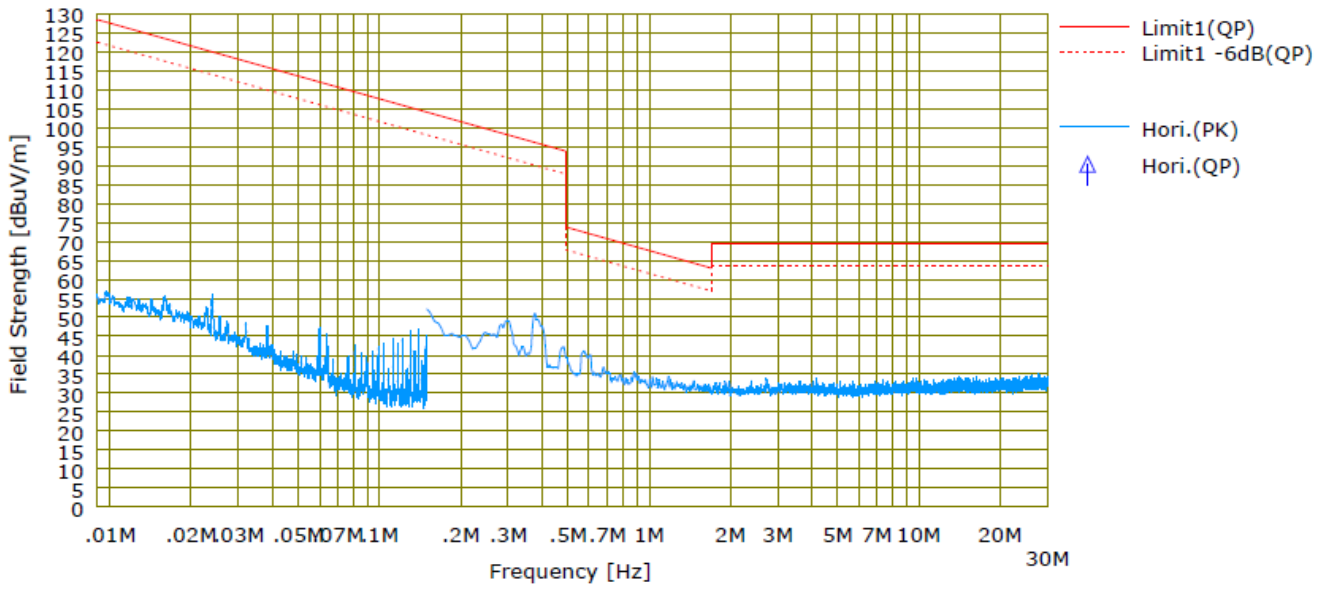
Operated from DC 12 V





Frequency Range: 9 kHz ~ 30 MHz

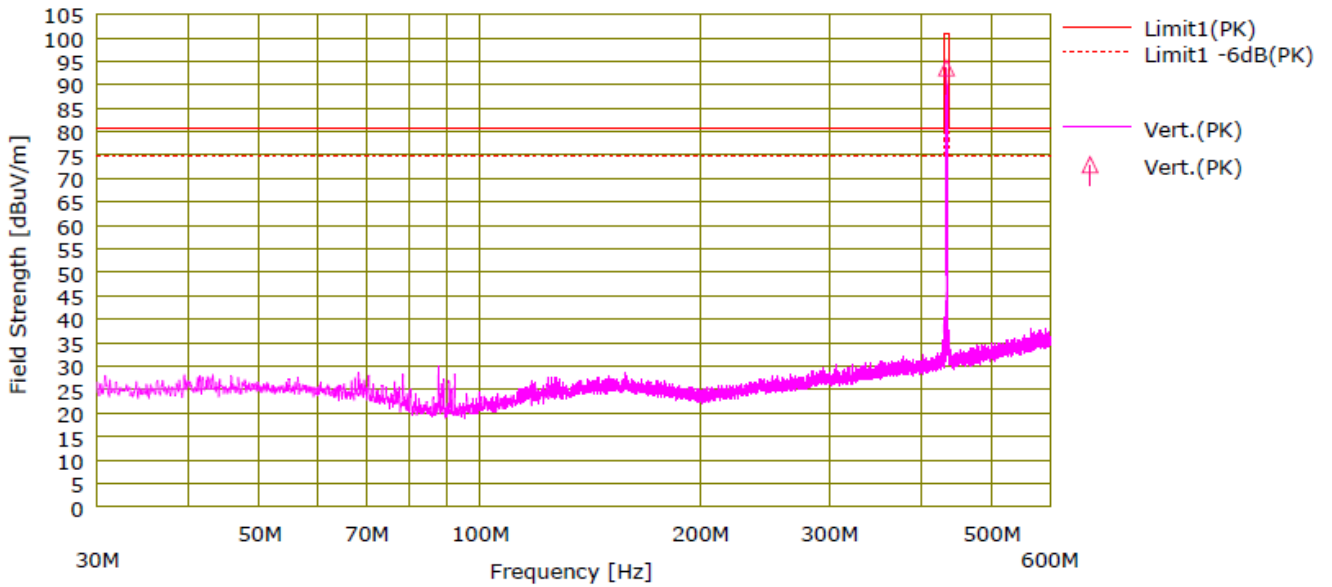
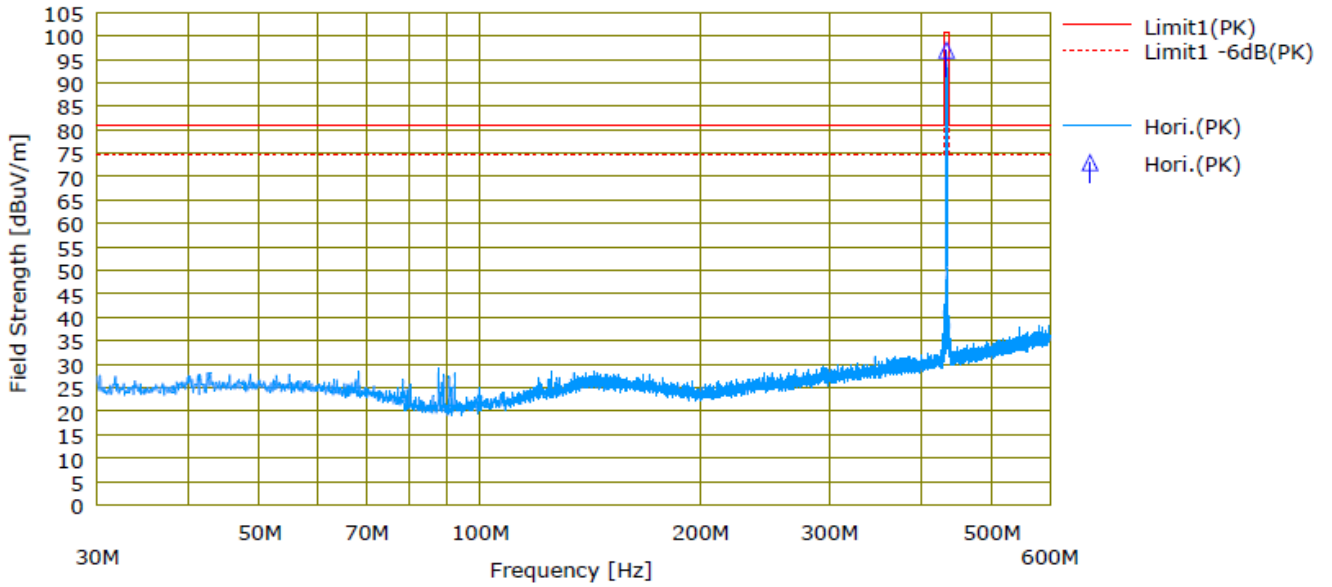
Operated from DC 24 V





Frequency Range: 30 MHz ~ 600 MHz

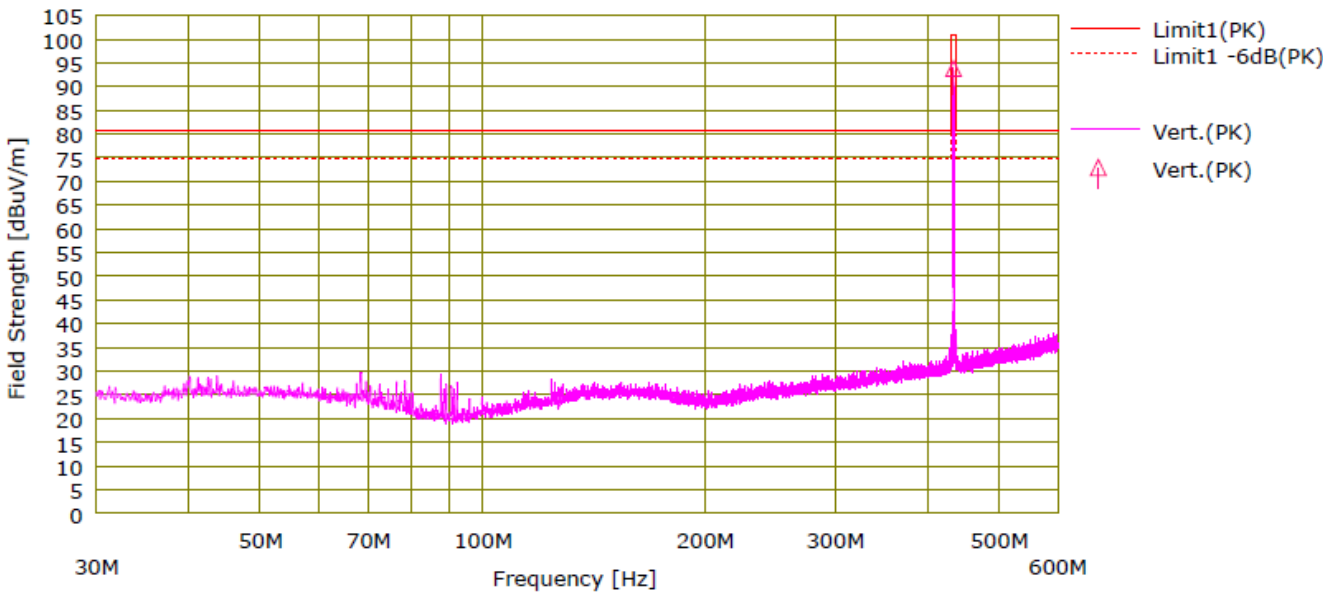
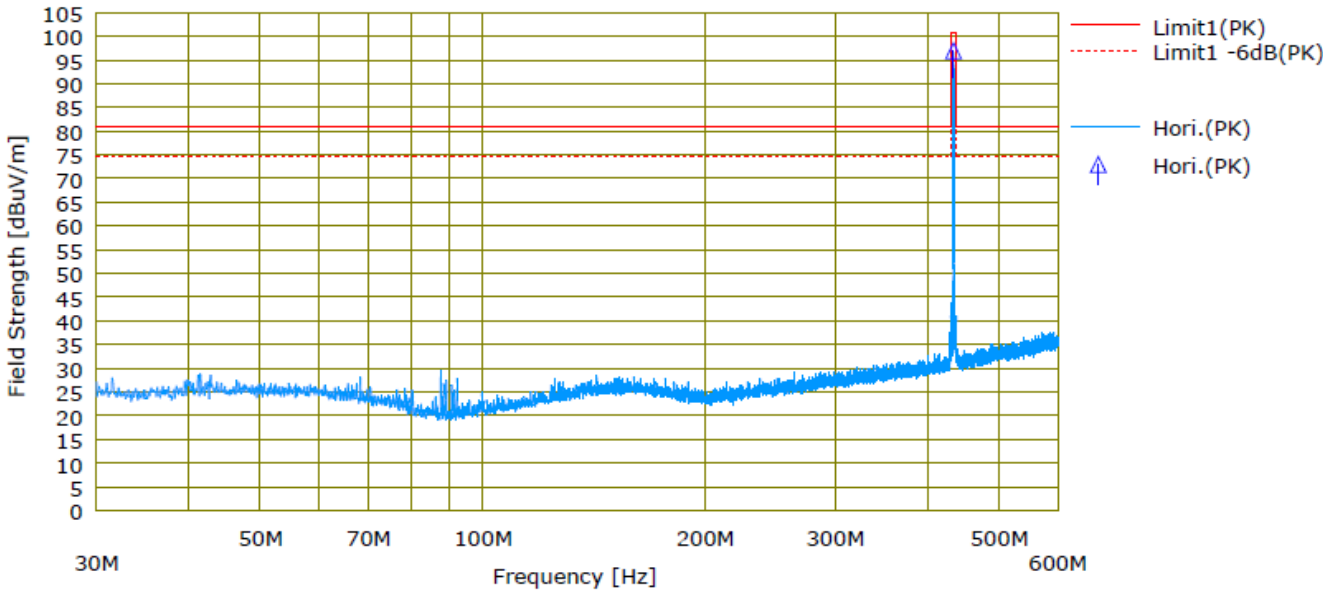
Operated from DC 12 V





Frequency Range: 30 MHz ~ 600 MHz

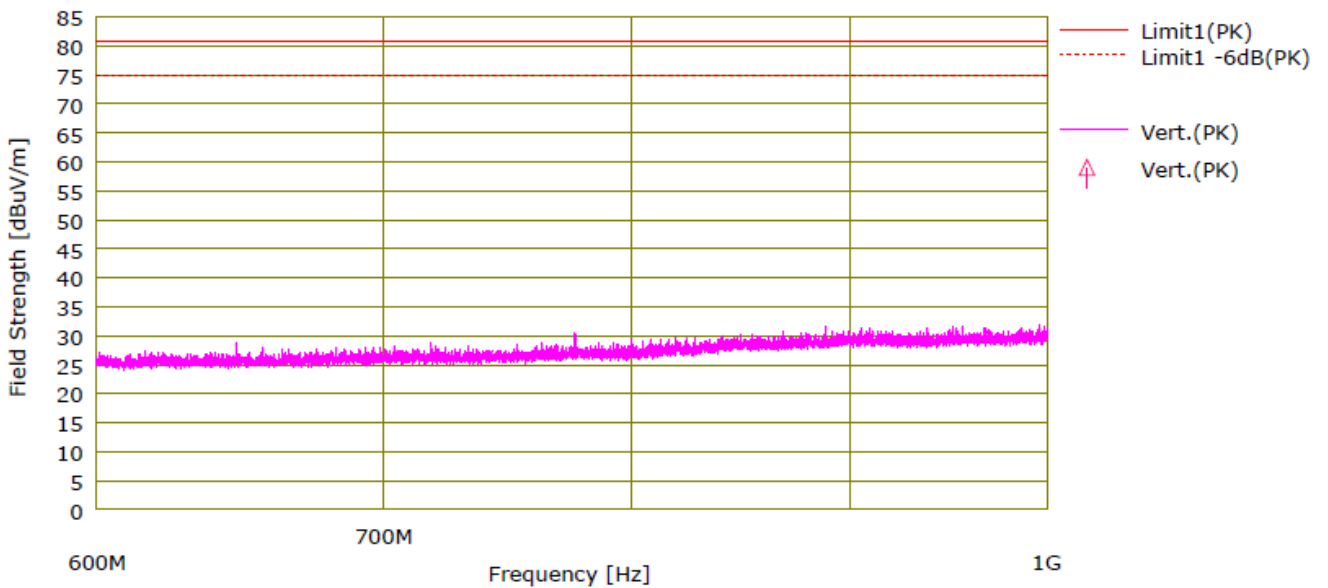
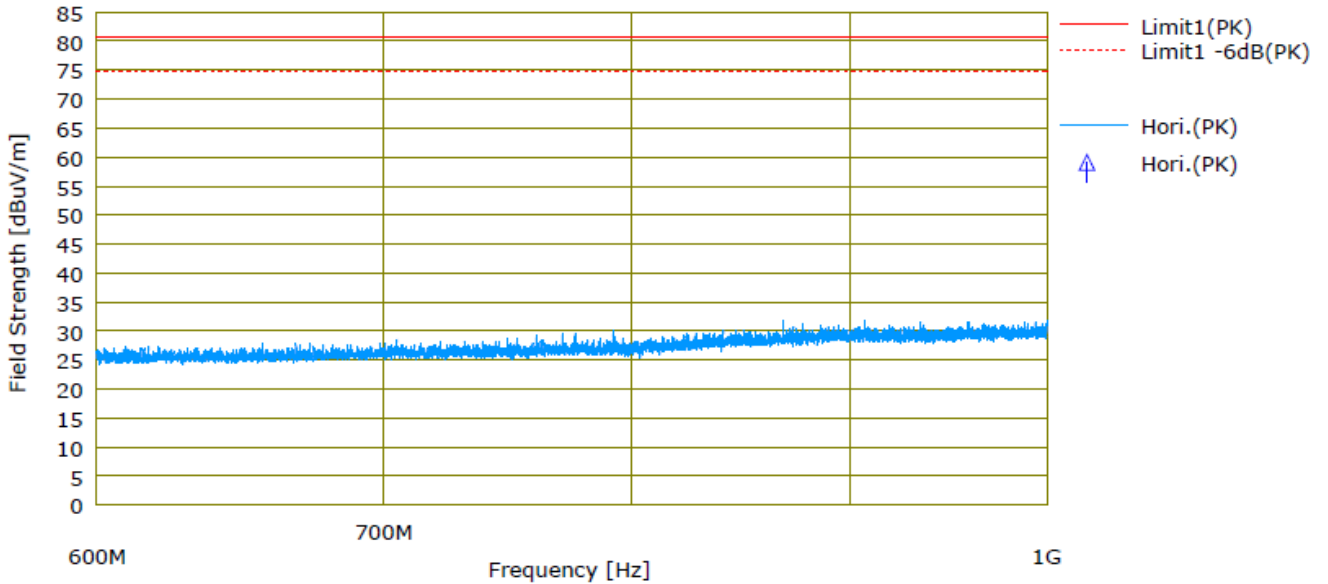
Operated from DC 24 V





Frequency Range: 600 MHz ~ 1 GHz

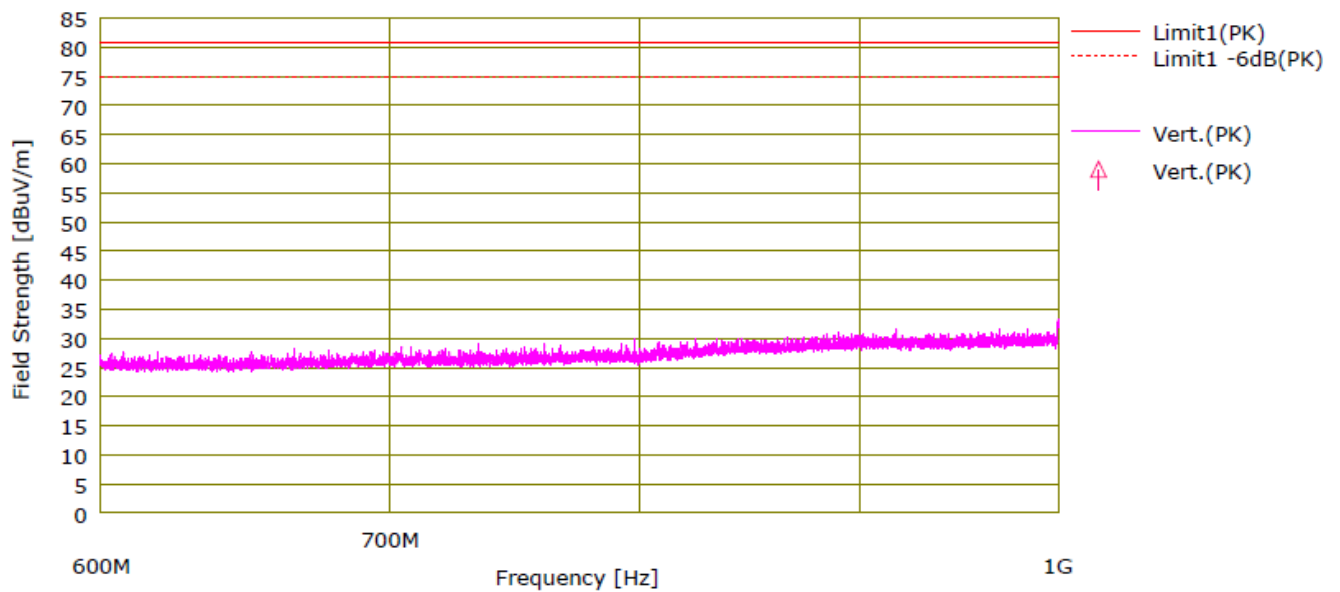
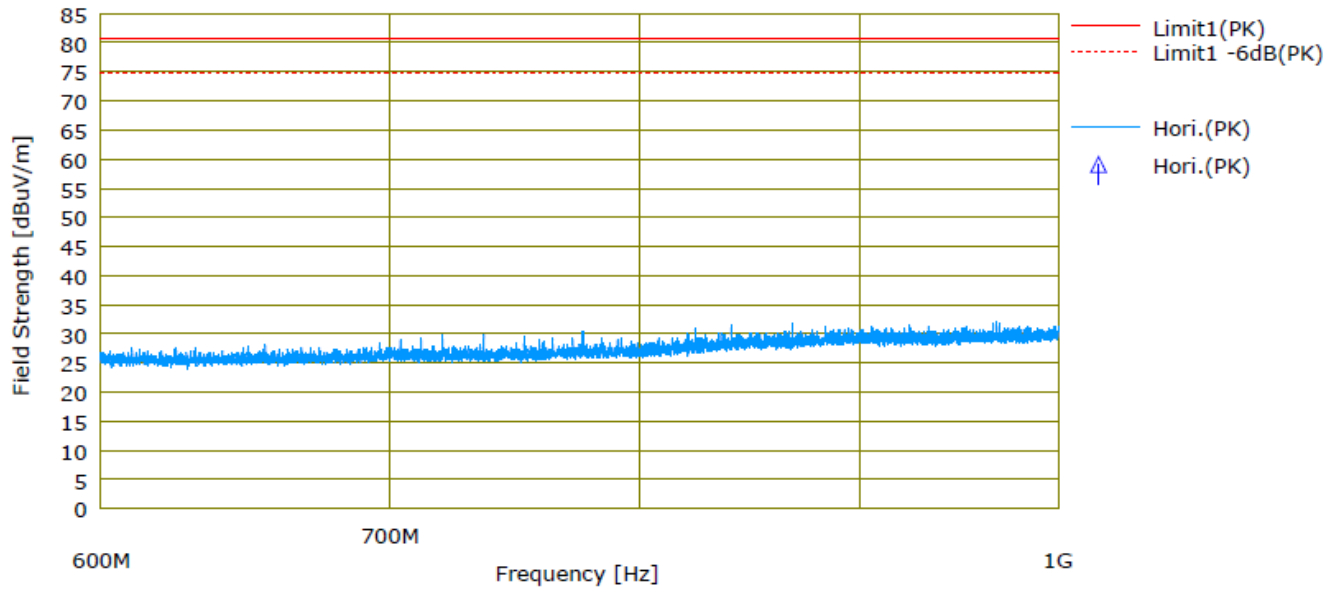
Operated from DC 12 V





Frequency Range: 600 MHz ~ 1 GHz

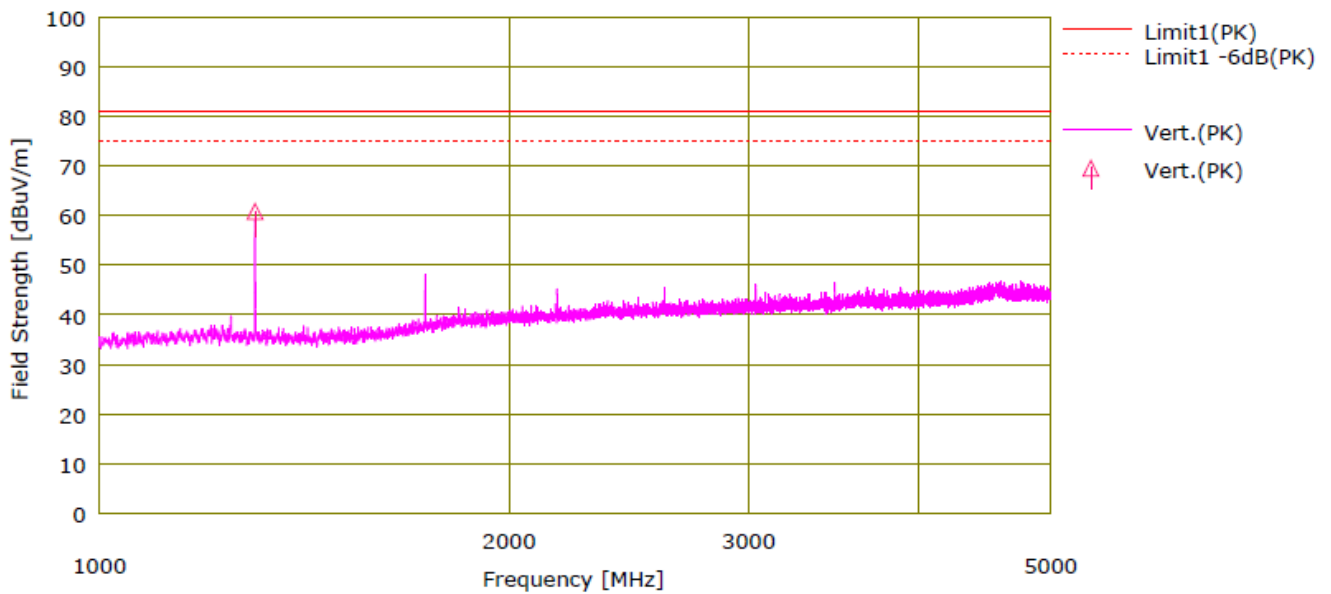
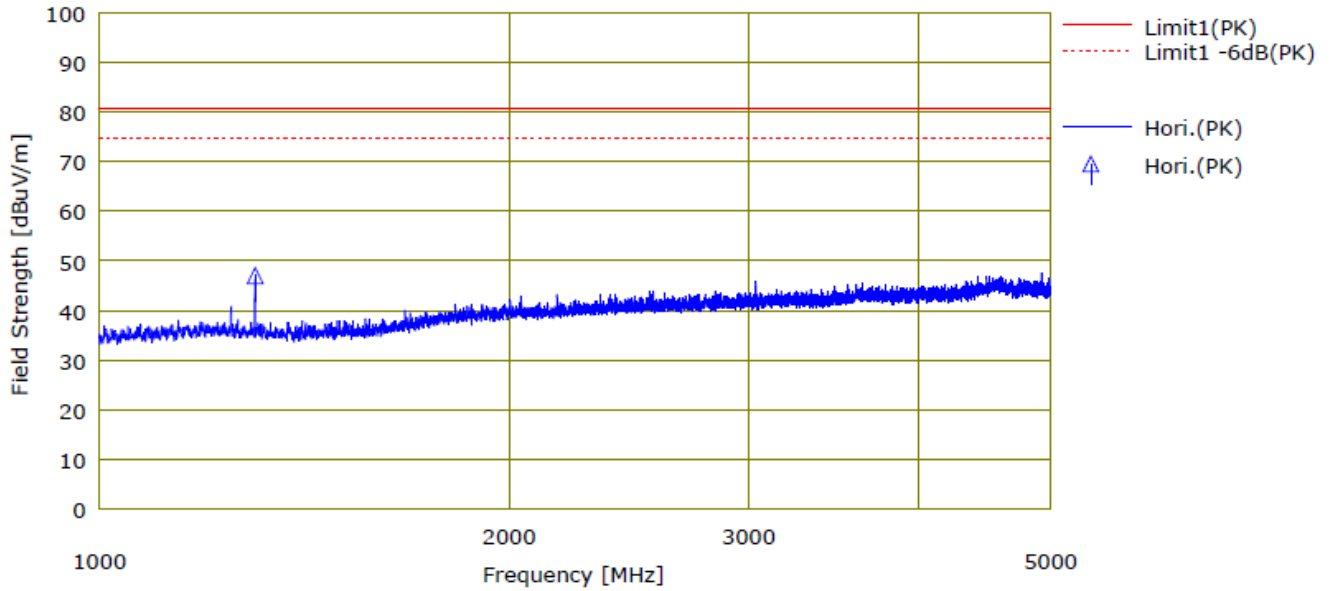
Operated from DC 24 V





Frequency Range: 1 GHz ~ 5 GHz

Operated from DC 12 V





Frequency Range: 1 GHz ~ 5 GHz

Operated from DC 24 V

