

**ELECTRO MAGNETIC TEST, INC.**

1547 Plymouth Street, Mountain View, CA 94043 Tel: (650)965-4000 Fax: (650)965-3000

**FCC PART 15.519, SUBPART F  
TEST REPORT**
*for*
*the*
**IPAS Vehicle Tag**
**MODEL: PAS-K01-12**

Prepared for

**KYUNGWOO SYSTECH, INC.**  
 #401, Daeryung Post Tower 5, Gasan-dong,  
 Geumcheon-gu, Seoul 153-702 South Korea

Prepared by:

**ANDREAS DAVIDSSON**

Approved by:

**KEVIN BOTHMANN**
**ELECTRO MAGNETIC TEST, INC.**  
 1547 PLYMOUTH STREET  
 MOUNTAIN VIEW, CALIFORNIA 94043  
 (650) 965-4000

DATE: October 23, 2018

	REPORT BODY	APPENDICES				TOTAL
		<i>A</i>	<i>B</i>	<i>C</i>	<i>D</i>	
PAGES	27	12	3	2	2	46

This report shall not be reproduced except in full, without the written approval of Electro Magnetic Test, Inc.

**ELECTRO MAGNETIC TEST, INC.**1547 Plymouth Street, Mountain View, CA 94043 Tel: (650)965-4000 Fax: (650)965-3000

---

**REVISION HISTORY**

<b>REVISION</b>	<b>DATE</b>	<b>COMMENTS</b>	<b>MODIFIED BY</b>
1.0	October 23, 2018	Original Document	-
2.0	October 30, 2018	Updated due to comments from client.	Andreas Davidsson
3.0	November 30, 2018	Updated 10dB BW range.	Andreas Davidsson
4.0	March 29, 2019	Updated Radiated Emissions data.	Andreas Davidsson.
4.1	April 3, 2019	Updated due to comments from client.	Andreas Davidsson
4.2	April 29, 2019	Updated with Correction Factors for applicable tests.	Andreas Davidsson



**ELECTRO MAGNETIC TEST, INC.**

1547 Plymouth Street, Mountain View, CA 94043 Tel: (650)965-4000 Fax: (650)965-3000

**TABLE OF CONTENTS**

**GENERAL REPORT SUMMARY.....5**

**SUMMARY OF TEST RESULTS .....6**

**1. PURPOSE .....8**

2.1 LOCATION OF TESTING .....9

2.2 TRACEABILITY STATEMENT .....9

2.3 COGNIZANT PERSONNEL .....9

2.4 DATE TEST SAMPLE WAS RECEIVED.....9

2.5 DISPOSITION OF THE TEST SAMPLE .....9

**3. APPLICABLE DOCUMENTS.....10**

**4. DESCRIPTION OF TEST CONFIGURATION .....11**

4.1 DESCRIPTION OF TEST CONFIGURATION – EMI .....11

4.1.1 Cable Construction and Termination .....12

**5. LISTS OF EUT, ACCESSORIES AND TEST EQUIPMENT .....13**

5.1 EUT AND ACCESSORY LIST .....13

5.2 EMI TEST EQUIPMENT .....14

**6. TEST SITE DESCRIPTION .....16**

6.1 TEST FACILITY DESCRIPTION .....16

6.2 EUT MOUNTING, BONDING AND GROUNDING .....16

6.3 FACILITY ENVIRONMENTAL CHARACTERISTICS .....16

**7. TEST PROCEDURES.....17**

7.1 OPERATIONAL LIMITATIONS .....17

7.2 RADIATED EMISSIONS.....18

7.2.1 Limits .....18

7.2.3 Test Procedure (Radiated).....19

7.3 UWB BANDWIDTH .....20

7.3.1 Limit (FCC PART 15 Section 15.519(b), 15.503(d)) .....20

7.3.2 Test Procedure.....20

7.3.3 Test Result.....20

7.4 RADIATED EMISSIONS IN GPS BANDS .....21

7.4.1 Limit (FCC PART 15 Section 15.519(b), 15.503(d)) .....21

7.4.2 Test Procedure.....21

7.4.3 Test Result.....21

7.5 PEAK EMISSIONS WITHIN A 50 MHZ BANDWITDH .....22

7.5.1 Limit (FCC PART 15 Section 15.519(e)) .....22

7.5.2 Test Procedure.....22

7.5.3 Test Result.....22

7.6 ANTENNA REQUIREMENT .....23

7.6.1 Requirement (FCC PART 15 SECTION 15.203) .....23

7.6.2 Test Result.....23

**8. CONCLUSIONS / COMPLIANCE STATEMENT .....26**

**APPENDIX A.....1**

**APPENDIX B.....1**

**APPENDIX C.....1**

**APPENDIX D.....1**



***ELECTRO MAGNETIC TEST, INC.***

1547 Plymouth Street, Mountain View, CA 94043 Tel: (650)965-4000 Fax: (650)965-3000

## LIST OF APPENDICES

APPENDIX	TITLE
A	Radiated Data and Conducted Sheets <ul style="list-style-type: none"> <li>• Radiated Emissions Test Data</li> <li>• Peak Emissions Test Data</li> <li>• UWB Bandwidth Test Data</li> <li>• Transmission Test Data</li> <li>• Conducted Emissions Test Data</li> </ul>
B	Test Setup Diagrams
C	Modifications To The EUT
D	Additional Models Covered Under This Report

## LIST OF FIGURES

FIGURE	TITLE
1	Layout of 3 Meter Semi-Anechoic Chamber
2	Conducted Emissions Test Setup



## ***ELECTRO MAGNETIC TEST, INC.***

1547 Plymouth Street, Mountain View, CA 94043 Tel: (650)965-4000 Fax: (650)965-3000

### **GENERAL REPORT SUMMARY**

This electromagnetic emission test report is generated by Electro Magnetic Test, Inc., which is an independent testing and consulting firm. The test report is based on testing performed Electro Magnetic Test, Inc. personnel according to the measurement procedure described in the test specification given below and in the "Test Procedures" section of this report.

The measurement data and conclusions appearing herein relate only to the sample tested and this report may not be reproduced in any form unless done so in full.

This report must not be used to claim product certification, approval, or endorsement by NVLAP, NIST, or any agency of the U.S. Federal Government.

The measurement data and conclusions contained in this test report are deemed satisfactory evidence of compliance with Industry Canada Interference-Causing Equipment Standard ICES-003, Issue 5, August 2012.

Electro Magnetic Test, Inc. is recognized by the following agencies for performing EMI/EMC testing:

<b>COUNTRY</b>	<b>AGENCY</b>	<b>IDENTIFYING #</b>
USA	Federal Communications Commission (FCC) (EMT's test site is recognized by the FCC)	Registration Number: 90576
USA, Canada, Taiwan, Australia/New Zealand, European Community	National Voluntary Lab Accreditation Program (NVLAP) (EMT is accredited by NVLAP. A copy of the NVLAP Scope Of Accreditation is available upon request.)	Lab Code: 200147-0
Canada	Industry Canada	File No.: IC 2804
Japan	Voluntary Control Council For Interference (VCCI)	A-0118
	Open Field Test Site "A"	-
	Mains Conducted Emissions Test Site "D"	-
	Telecom Conducted Emissions Test Site "D"	-
	3 Meter Semi-Anechoic Chamber Site "E"	-
	3 Meter Semi-Anechoic Chamber Site "E" (1GHz – 6GHz)	-
	Mains Conducted Emissions Test Site "E"	-
	Telecom Conducted Emissions Test Site "E"	-
Korea	Ministry of Information and Communication's Radio Research Laboratory (RRL) under the Asia Pacific Economic Cooperation (APEC) Mutual Recognition Arrangement (A copy of the Scope Of Accreditation is available upon request)	US0036
Taiwan	Bureau Of Standards, Metrology and Inspection (BSMI)	Reference Number: SL2-IN-E-1024
Australia / New Zealand	Australian Communications Authority (AUSTEL)	*

\*These agencies do not issue an identifying number to test labs.

**ELECTRO MAGNETIC TEST, INC.**

1547 Plymouth Street, Mountain View, CA 94043 Tel: (650)965-4000 Fax: (650)965-3000

**GENERAL REPORT SUMMARY (CONTINUED)**

Device Tested: IPAS Vehicle Tag  
 Model: PAS-K01-12  
 S/N: 1301-18B270080

Product Description: When the pedestrian enters the warning or danger range, The indicator sounds “watch out” or “Danger” message repeatedly and the pedestrian gets vibration and beep alarm at the same time.

Modifications: The EUT was not modified during the testing.

Manufacturer: KYUNGWOO SYSTECH, INC.  
 #401, Daeryung Post Tower 5, Gasan-dong, Geumcheon-gu,  
 Seoul 153-702 South Korea

Test Date(s): 6/20/2018,10/18/2018, 03/21/2019, 04/03/2019

Test Specifications: EMI requirements  
 Limits: FCC Title 47, Part 15 Subpart F, Section 15.519  
 Test Procedure: ANSI C63.10.2013

Test Deviations: The test procedure was not deviated from during the testing.

**SUMMARY OF TEST RESULTS**

TEST	DESCRIPTION	FCC STANDARD	REMARKS	RESULTS
7.1	Operational Limitations	15.519(a)	Radiated	<b>PASS</b>
7.2	Radiated Emissions	15.519(c)	Radiated	<b>PASS</b>
7.3	UWB Bandwidth	15.519(b)	Radiated	<b>PASS</b>
7.4	Radiated Emissions in GPS Bands	15.519(d)	Radiated	<b>PASS</b>
7.5	Peak Emissions within a 50 MHz Bandwidth	15.519(e)	Radiated	<b>PASS</b>
7.6	Antenna Requirement	15.203	N/A	<b>PASS</b>
7.7	Conducted Emissions	15.207	Conducted	<b>PASS</b>

**ELECTRO MAGNETIC TEST, INC.**1547 Plymouth Street, Mountain View, CA 94043 Tel: (650)965-4000 Fax: (650)965-3000

---

**TECHNICAL DESCRIPTION OF THE EUT**

<b>Manufacturer:</b>	KYUNGWOO SYSTECH, INC.
<b>Manufacturer Address:</b>	#401, Daeryung Post Tower 5, Gasan-dong, Geumcheon-gu, Seoul 153-702 South Korea
<b>EUT Name:</b>	Vehicle Tag
<b>Model No:</b>	PAS-K01-12
<b>Operation frequency:</b>	3993.6 MHz
<b>Maximum Output Power:</b>	54.6 dB $\mu$ v @ 3m



***ELECTRO MAGNETIC TEST, INC.***

1547 Plymouth Street, Mountain View, CA 94043 Tel: (650)965-4000 Fax: (650)965-3000

---

**1. PURPOSE**

This document is a qualification test report based on the Electromagnetic Interference (EMI) tests performed on the Vehicle Tag Model: PAS-K01-12. The EMI measurements were performed according to the measurement procedure described in ANSI C63.10-2013. The tests were performed in order to determine whether the electromagnetic emissions from the equipment under test, referred to as EUT hereafter, are within the specification limits defined in FCC Title 47, Part 15, Subpart F, Section 15.519.





## ***ELECTRO MAGNETIC TEST, INC.***

1547 Plymouth Street, Mountain View, CA 94043 Tel: (650)965-4000 Fax: (650)965-3000

---

## **2. ADMINISTRATIVE DATA**

### **2.1 Location of Testing**

The EMI tests described herein were performed at the test facility of Electro Magnetic Test, Inc., 1547 Plymouth Street, Mountain View, California, 94043.

### **2.2 Traceability Statement**

The calibration certificates of all test equipment used during the test are on file at the location of the test. The measurement results in this report and the calibration of the test equipment are traceable to the National Institute of Standards and Technology (NIST).

### **2.3 Cognizant Personnel**

#### Kyungwoo Systech, Inc.

Won-Sik Bae                      Research Engineer

#### Electro Magnetic Test, Inc.

Alok Patel	Test Technician
Andreas Davidsson	Test Technician
David Vivanco	Test Technician
Manan Modi	Test Technician
Sagar Bombaywala	Test Technician
Simeet Gandhi	Test Technician
Kevin Bothmann	Lab Manager

### **2.4 Date Test Sample was Received**

The test sample was received on June 20, 2018.

### **2.5 Disposition of the Test Sample**

The test sample has not yet been returned to Kyungwoo Systech, Inc.

### **2.6 Abbreviations and Acronyms**

The following abbreviations and acronyms may be used in this document.

RF	Radio Frequency
EMI	Electromagnetic Interference
EUT	Equipment Under Test
P/N	Part Number
S/N	Serial Number
HP	Hewlett Packard
ITE	Information Technology Equipment
CML	Corrected Meter Limit
LISN	Line Impedance Stabilization Network
CISPR	International Special Committee On Radio Interference
FCC	Federal Communications Commission

**ELECTRO MAGNETIC TEST, INC.**

1547 Plymouth Street, Mountain View, CA 94043 Tel: (650)965-4000 Fax: (650)965-3000

**3. APPLICABLE DOCUMENTS**

The following documents are referenced or used in the preparation of this EMI Test Report.

SPEC	TITLE
FCC Title 47, Part 15, Subpart F	FCC Rules - Radio frequency devices, Ultra Wideband Operation
FCC Title 47, Part 15, Subpart C	FCC Rules - Radio frequency devices, Intentional Radiators
FCC Publication 393764 D01 UWB FAQ v02	Ultra-Wide Band (UWB) Device Frequently Asked Questions, January 29, 2018
ANSI C63.10-2013	American National Standard of Procedures for Compliance Testing of Unlicensed Wireless Devices.
CISPR 22: 1997 plus A1:2000 & A2:2002	Information technology equipment - Radio disturbance characteristics - Limits and methods of measurement



***ELECTRO MAGNETIC TEST, INC.***

1547 Plymouth Street, Mountain View, CA 94043 Tel: (650)965-4000 Fax: (650)965-3000

---

#### **4. DESCRIPTION OF TEST CONFIGURATION**

##### **4.1 Description of Test Configuration – EMI**

During testing the UWB radio was continuously transmitting. The EUT was tested in two positions; laying horizontally along the table and set vertically along the table. The horizontal layout was chosen for testing.

It was determined that the emissions were at their highest level when the EUT was operating in the above configuration. The EUT emissions were investigated in all 3 orthogonal planes. The final radiated data was taken in this mode of operation. All initial investigations were performed with the EMI receiver in manual mode scanning the frequency range continuously.



***ELECTRO MAGNETIC TEST, INC.***

1547 Plymouth Street, Mountain View, CA 94043 Tel: (650)965-4000 Fax: (650)965-3000

---

#### **4.1.1 Cable Construction and Termination**

##### Cables #1

This is a 20 foot DC power cable connecting the EUT to the DC Power Generator. It has a 6 Pin DIN 60° connector at the EUT end and a Positive and Negative lead on the DC Generator end.



***ELECTRO MAGNETIC TEST, INC.***

1547 Plymouth Street, Mountain View, CA 94043 Tel: (650)965-4000 Fax: (650)965-3000

**5. LISTS OF EUT, ACCESSORIES AND TEST EQUIPMENT**

**5.1 EUT and Accessory List**

<b>EQUIPMENT TYPE</b>	<b>MANUFACTURER</b>	<b>MODEL</b>	<b>SERIAL NUMBER</b>
Vehicle Tag (EUT)	Kyungwoo Systech Inc.	PAS-K01-12	1301-18B270080
<b>THE FOLLOWING WERE LOCATED OUTSIDE THE TEST SITE:</b>			
DC Power Generator	Mastech	HY1803DL	243591

**ELECTRO MAGNETIC TEST, INC.**

1547 Plymouth Street, Mountain View, CA 94043 Tel: (650)965-4000 Fax: (650)965-3000

**5.2 EMI Test Equipment**

<b>EQUIPMENT TYPE</b>	<b>MANUFACTURER</b>	<b>MODEL NUMBER</b>	<b>SERIAL NUMBER</b>	<b>CAL. DATE</b>	<b>CAL. CYCLE</b>
Spectrum Analyzer	Hewlett Packard	8566B	3024A20115	September 30, 2018	1 Year
RF Preselector	Hewlett Packard	85685A	3010A01157	September 30, 2018	1 Year
Quasi-Peak Adapter	Hewlett Packard	85650A	2430A00451	September 30, 2018	1 Year
Radiated EMI Software	Sector Design	N/A	Ver.1.4.6	N/A	N/A
EMI Receiver (Conducted EMI)	Rohde & Schwarz	ESU40	100295	July 18, 2018	1 Year
Conducted EMI Software	ETS-Lindgren	Tile!	Rev. 7.0.12.697	N/A	N/A
Preamplifier	Hewlett Packard	8447D	1937A02579	March 5, 2018	1 Year
RF Attenuator	Com-Power	LIT-153A	531175	December 15, 2017	1 Year
LISN	Solar Electronics	Type 21107-50-TS-50-N	21107150701	June 2, 2018	1 Year
LISN	Solar Electronics	Type 21107-50-TS-50-N	21107150702	June 2, 2018	1 Year
LISN	Solar Electronics	Type 21107-50-TS-50-N	21107150703	June 2, 2018	1 Year
LISN	Solar Electronics	Type 21107-50-TS-50-N	21107150704	June 2, 2018	1 Year
Biconical Antenna	Com Power	AB-100	01557	July 20, 2018	1 Year
Log Periodic Antenna	Com Power	AL-100	16001	July 7, 2018	1 Year
Antenna Mast	Com Power	AM-400	N/A	N/A	N/A
Turntable	Com Power	TT-100	N/A	N/A	N/A
Computer	Dell, Inc.	DHS	DNSV641	N/A	N/A
Printer	Hewlett Packard	C8124A	CN39A220ZD	N/A	N/A

**ELECTRO MAGNETIC TEST, INC.**

1547 Plymouth Street, Mountain View, CA 94043 Tel: (650)965-4000 Fax: (650)965-3000

**5.2 EMI Test Equipment (Continued)**

<b>EQUIPMENT TYPE</b>	<b>MANUFACTURER</b>	<b>MODEL NUMBER</b>	<b>SERIAL NUMBER</b>	<b>CAL. DATE</b>	<b>CAL. CYCLE</b>
EMI Receiver	Rohde & Schwarz	ESU40	100127	February 2, 2018	1 Year
EMI Test Software	Rohde & Schwarz	EMC32	V8.54.0	N/A	N/A
BiConiLog Antenna	ETS-Lindgren	3143B	00206757	August 28, 2018	1 Year
Horn Antenna	ETS-Lindgren	3117	00109294	February 5, 2018	1 Year
Preamplifier	Rohde & Schwarz	TS-PR18	100056	December 12, 2017	1 Year
Antenna Mast	ETS-Lindgren	2171B	00150364	N/A	N/A
Turntable	ETS-Lindgren	2187-3.0	00118231	N/A	N/A
Computer	Dell, Inc.	Optiplex 745	4T50WC1	N/A	N/A
Multi-Function Controller	ETS-Lindgren	2090	00102270	N/A	N/A

**ELECTRO MAGNETIC TEST, INC.**

1547 Plymouth Street, Mountain View, CA 94043 Tel: (650)965-4000 Fax: (650)965-3000

**6. TEST SITE DESCRIPTION**
**6.1 Test Facility Description**

Please refer to the table below and section 7 of this report for the details of which sites were used for testing. All sites are located at 1547 Plymouth Street, Mountain View, California 94043.

Site Used For Test	Site Description
	Open Field Test Site "A"
X	Mains Conducted Emissions Test Site "D"
X	3 Meter Semi-Anechoic Chamber Site "E"
	Mains Conducted Emissions Test Site "E"

**6.2 EUT Mounting, Bonding and Grounding**

The EUT was mounted on a 1.0 by 1.5 meter non-conductive table 0.8 meters above the ground plane, with the height increased to 1.5 meters for radiated emissions testing above 1 GHz.

The EUT was not grounded.

**6.3 Facility Environmental Characteristics**

All tests were performed in a climate controlled building. The temperature was 23° C, humidity 53%, and barometric pressure 102.7 kPa.





***ELECTRO MAGNETIC TEST, INC.***

1547 Plymouth Street, Mountain View, CA 94043 Tel: (650)965-4000 Fax: (650)965-3000

---

## 7. TEST PROCEDURES

### 7.1 Operational Limitations

#### FCC 47 CFR Section 15.519 (a) (1)

A UWB device operating under the provisions of this section shall transmit only when it is sending information to an associated receiver. The UWB intentional radiator shall cease transmission within 10 seconds unless it receives an acknowledgement from the associated receiver that its transmission is being received. An acknowledgement of reception must continue to be received by the UWB intentional radiator at least every 10 seconds or the UWB device must cease transmitting.

The EUT was tested for this requirement and found to comply, please see the datasheets in Appendix A for the measurement results.

#### FCC 47 CFR Section 15.519 (a) (2)

The use of antennas mounted on outdoor structures, e.g., antennas mounted on the outside of a building or on a telephone pole, or any fixed outdoors infrastructure is prohibited. Antennas may be mounted only on the hand held UWB device.

The client has been informed of this requirement.

#### FCC 47 CFR Section 15.519 (a) (3)

UWB devices operating under the provisions of this section may operate indoors or outdoors.

The client has been informed of this requirement.



## **ELECTRO MAGNETIC TEST, INC.**

1547 Plymouth Street, Mountain View, CA 94043 Tel: (650)965-4000 Fax: (650)965-3000

## 7.2 Radiated Emissions

### 7.2.1 Limits

#### General Requirements Limit (FCC PART 15 Section 15.209(a)(1))

Frequency of Emission (MHz)	Field Strength		Measurement Distance (Meters)
	$\mu\text{V/m}$	$\text{dB}\mu\text{V/m}$	
0.009-0.49	2400/F(kHz)		300
0.49-1.705	24000/F(kHz)		30
1.705-30	30		30
30-88	100	40	3
88-216	150	43.5	3
216-960	200	46	3
Above 960*	500*	54*	3*

\*Not applicable for above 960 MHz measurements

#### (FCC PART 15 Section 15.519(c))

The radiated emissions at or below 960 MHz from a device operating under the provisions of this section shall not exceed the emission levels in §15.209. The radiated emissions above 960 MHz from a device operating under the provisions of this section shall not exceed the following average limits when measured using a resolution bandwidth of 1 MHz:

Frequency in MHz	EIRP in dBm
960-1610	-75.3
1610-1990	-63.3
1990-3100	-61.3
3100-10600	-41.3
Above 10600	-61.3



***ELECTRO MAGNETIC TEST, INC.***

1547 Plymouth Street, Mountain View, CA 94043 Tel: (650)965-4000 Fax: (650)965-3000

### 7.2.3 Test Procedure (Radiated)

The Rohde & Schwarz ESU40 EMI receiver was used as a measuring meter while under software control by the Rohde & Schwarz EMC32 software. To increase the sensitivity of the instrument, the built in preamplifier was used from 9 KHz to 0.960 GHz. From 0.960 GHz to 1.610 GHz both built in and external preamplifiers were used. From 1.610 GHz to 40 GHz only external preamplifiers were used.

The EMI receiver was used in the peak detect mode with the "Max Hold" feature activated. In this mode, the EMI receiver records the highest measured reading over all the sweeps. The built in quasi-peak or average detector was used only for those readings which are marked accordingly on the data sheets.

The Loop Antenna, Broadband BiConiLog and horn antennas were used as transducers during the measurement. The Loop antenna was used from 9 KHz to 30 MHz, the BiConiLog antenna was used from 30 MHz to 1000 MHz and horn antennas were used from 1GHz – 40GHz. The frequency spans were wide (9 kHz to 150 kHz, 150 kHz to 30 MHz, 30 MHz to 88 MHz, 88 MHz to 216 MHz, 216 to 300 MHz, 300 MHz to 1 GHz, 1 GHz to 18 GHz and 18 GHz to 26.5 GHz) during preliminary investigations. Furthermore, the frequency span was reduced during the preliminary investigations as deemed necessary.

The 3 meter semi-anechoic chamber of Electro Magnetic Test, Inc. was used for radiated emission testing. This test site is set up according to ANSI C63.10-2013. Please see section 6.2 of this report for mounting, bonding and grounding of the EUT. The turntable supporting the EUT is remote controlled using a motor. The turntable permits EUT rotation of 360 degrees in order to maximize emissions. Also, the antenna mast allows height variation of the antenna from 1 meter to 4 meters. Data was collected in the worst case (highest emission) configuration of the EUT. The EUT was rotated 360 degrees and the antenna height was varied from 1 to 4 meters (for E field radiated field strength).

The presence of non EUT signals was verified by turning the EUT off. In case a non EUT signal was detected, the measurement bandwidth was reduced temporarily and verification was made that an additional adjacent peak did not exist. This ensures that the other signal does not hide any emissions from the EUT. The EUT was tested at a 3 meter test distance (unless noted) from 30 MHz to 18 GHz. to obtain final test data.

Calculation Of Radiated Emission Test Data:

Amplitude - Gain + Antenna Factor + Cable Loss = Corrected Amplitude

Corrected Amplitude - Limit = Margin

**ELECTRO MAGNETIC TEST, INC.**

1547 Plymouth Street, Mountain View, CA 94043 Tel: (650)965-4000 Fax: (650)965-3000

**7.3 UWB Bandwidth**
**7.3.1 Limit (FCC PART 15 Section 15.519(b), 15.503(d))**
**FCC PART 15 Section 15.519(b)**

(b) The UWB bandwidth of a UWB system operating under the provisions of this section must be contained between 3100 MHz and 10600 MHz

<b>Limit</b>
UWB bandwidth within 3100 MHz and 10600 MHz

**FCC PART 15 Section 15.503(d)**

Ultra-wideband (UWB) transmitter. An intentional radiator that, at any point in time, has a fraction bandwidth equal to or greater than 0.20 or has a UWB bandwidth equal to or greater than 500 MHz, regardless of the fractional bandwidth

<b>Limit</b>
Fractional Bandwidth $\geq 0.20$ Or UWB Bandwidth (10 dB below highest radiated emission) $\geq 500$ MHz

**7.3.2 Test Procedure**

Set EUT and test equipment as indicted in Radiated Emissions Procedure

RBW: 1 MHz

VBW:  $\geq 3 \times$  RBW

Detector: Peak

Trace Mode: Max Hold

- (1) Set analyzer center frequency to center of signal.
- (2) Set measurement to 10 db down.
- (3) Wait for Trace to stabilize.
- (4) Mark delta of bandwidth frequency.
- (5) Compare marker to limit.

**7.3.3 Test Result**

The EUT meets the requirements. Please see the datasheets in Appendix A for the measurement results.

**ELECTRO MAGNETIC TEST, INC.**

1547 Plymouth Street, Mountain View, CA 94043 Tel: (650)965-4000 Fax: (650)965-3000

**7.4 Radiated Emissions in GPS Bands**
**7.4.1 Limit (FCC PART 15 Section 15.519(b), 15.503(d))**

In addition to the radiated emission limits specified in the table in paragraph (c) of this section, UWB transmitters operating under the provisions of this section shall not exceed the following average limits when measured using a resolution bandwidth of no less than 1 kHz:

Frequency in MHz	EIRP in dBm
1164-1240	-85.3
1559-1610	-85.3

**7.4.2 Test Procedure**

Set EUT and test equipment as indicted in Radiated Emissions Procedure

RBW: 1 MHz

VBW:  $\geq 3 \times$  RBW

Detector: Peak

Trace Mode: Max Hold

- (1) Set analyzer center frequency to 1164-1240 MHz
- (2) Wait for the result to stabilize.
- (3) Compare peak emission to limit.
- (4) Repeat for frequency range 1559-1610 MHz.

**7.4.3 Test Result**

The EUT meets the requirements. Please see the datasheets in Appendix A for the measurement results.

**ELECTRO MAGNETIC TEST, INC.**

1547 Plymouth Street, Mountain View, CA 94043 Tel: (650)965-4000 Fax: (650)965-3000

**7.5 Peak Emissions within a 50 MHz Bandwidth**
**7.5.1 Limit (FCC PART 15 Section 15.519(e))**

There is a limit on the peak level of the emissions contained within a 50 MHz bandwidth centered on the frequency at which the highest radiated emission occurs,  $f(m)$ . That limit is 0 dBm EIRP. It is acceptable to employ a different resolution bandwidth, and a correspondingly different peak emission limit, follow the procedures described in 15.521

<b>Limit</b>
0 dBm EIRP when using 50 MHz measurement bandwidth

**7.5.2 Test Procedure**

Set EUT and test equipment as indicated in Radiated Emissions Procedure

RBW: 1 MHz

VBW:  $\geq$  RBW

Detector: Peak

Trace Mode: Max Hold

- (1) Set analyzer center frequency to center of signal.
- (2) Let trace complete and turn on marker peak search mode.
- (3) Compare peak emission to limit.

**7.5.3 Test Result**

The EUT meets the requirements. Please see the datasheets in Appendix A for the measurement results and relevant calculations.

**ELECTRO MAGNETIC TEST, INC.**1547 Plymouth Street, Mountain View, CA 94043 Tel: (650)965-4000 Fax: (650)965-3000

---

## **7.6 Antenna Requirement**

### **7.6.1 Requirement (FCC PART 15 SECTION 15.203)**

An intentional radiator shall be designed to ensure that no antenna other than that furnished by the responsible party shall be used with the device. The use of a permanently attached antenna or of an antenna that uses a unique coupling to the intentional radiator shall be considered sufficient to comply with the provisions of this section. The manufacturer may design the unit so that a broken antenna can be replaced by the user, but the use of a standard antenna jack or electrical connector is prohibited. This requirement does not apply to carrier current devices or to devices operated under the provisions of §§15.211, 15.213, 15.217, 15.219, 15.221, or §15.236. Further, this requirement does not apply to intentional radiators that must be professionally installed, such as perimeter protection systems and some field disturbance sensors, or to other intentional radiators which, in accordance with §15.31(d), must be measured at the installation site. However, the installer shall be responsible for ensuring that the proper antenna is employed so that the limits in this part are not exceeded.

### **7.6.2 Test Result**

The antenna is permanently attached.



**ELECTRO MAGNETIC TEST, INC.**

1547 Plymouth Street, Mountain View, CA 94043 Tel: (650)965-4000 Fax: (650)965-3000

**7.7 Conducted Emissions**

**7.7.1 Limits (FCC PART 15 SECTION 15.207)**

An intentional radiator that is designed to be connected to the public utility (AC) power line, the radio frequency voltage that is conducted back onto the AC power line on any frequency or frequencies, within the band 150 kHz to 30 MHz, shall not exceed the limits in the following table, as measured using a 50 μH/50 ohms line impedance stabilization network (LISN). Compliance with the provisions of this paragraph shall be based on the measurement of the radio frequency voltage between each power line and ground at the power terminal. The lower limit applies at the boundary between the frequency ranges.

Frequency of emission (MHz)	Conducted limit (dBμV)	
	Quasi-peak	Average
0.15-0.5	66 to 56*	56 to 46*
0.5-5	56	46
5-30	60	50

\*Decreases with the logarithm of the frequency.

**7.7.2 Test Procedure**

The Rohde & Schwarz ESU40 EMI receiver was used as a measuring meter. The data was collected with the EMI receiver in the peak detect mode with the "Max Hold" feature activated. The quasi-peak and average detectors were used only where indicated in the data sheets. A 10 dB attenuation pad was used for the protection of the EMI receiver input stage, and the EMI receiver offset was adjusted accordingly to read the actual data measured. The LISN output was read by the Rohde & Schwarz ESU40 EMI receiver. The output of the second LISN was terminated by a 50 ohm termination. The effective measurement bandwidth used for the conducted emissions test was 9 kHz.

Please see section 6.2 of this report for mounting, bonding and grounding of the EUT. The EUT was powered through the LISN, which was bonded to the ground plane. The LISN power was filtered and the filter was bonded to the ground plane. The EUT was set up with the minimum distances from any conductive surfaces as specified in ANSI C63.4: 2014. The excess power cord was wrapped in a figure eight pattern to form a bundle not exceeding 0.4 meters in length.

The initial test data was taken in manual mode while scanning the frequency ranges of 0.15 MHz to 1.6 MHz, 1.6 MHz to 5 MHz and 5 MHz to 30 MHz. The conducted emissions from the EUT were maximized for operating mode as well as cable and peripheral placement. Once a predominant frequency (within 12 dB of the limit) was found, it was more closely examined with the spectrum analyzer span adjusted to 1 MHz.





***ELECTRO MAGNETIC TEST, INC.***

1547 Plymouth Street, Mountain View, CA 94043 Tel: (650)965-4000 Fax: (650)965-3000

---

The final data was collected under program control by the ETS-Lindgren Tile! software in several overlapping sweeps by running the spectrum analyzer at a minimum scan rate of 10 seconds per octave.

Associated with the conducted emission test data in this report is a  $\pm 3.4$ dB measurement uncertainty.

### **7.7.3**

#### **Test Result**

The EUT meets the requirements. Please see the datasheets in Appendix A for the measurement results and relevant calculations.



***ELECTRO MAGNETIC TEST, INC.***

1547 Plymouth Street, Mountain View, CA 94043 Tel: (650)965-4000 Fax: (650)965-3000

---

**8. CONCLUSIONS / COMPLIANCE STATEMENT**

Based upon the results contained in this report, Electro Magnetic Test, Inc. has determined that the Vehicle Tag, Model: PAS-K01-12 meets all of the specification limits defined in FCC Title 47, Part 15, Subpart F, Section 15.519



***ELECTRO MAGNETIC TEST, INC.***

1547 Plymouth Street, Mountain View, CA 94043 Tel: (650)965-4000 Fax: (650)965-3000

---

**APPENDIX A**

***RADIATED DATA SHEETS***



**ELECTRO MAGNETIC TEST, INC.**

1547 Plymouth Street, Mountain View, CA 94043 Tel: (650)965-4000 Fax: (650)965-3000

**Radiated Emissions**

<b>EUT:</b>	Vehicle Tag	<b>Model Name:</b>	PAS-K01-12
<b>Test Mode:</b>	UWB	<b>Test Date:</b>	3/21/2019
<b>Test Engineer:</b>	Andreas Davidsson	<b>Measurement:</b>	30 MHz to 1 GHz

**Limit Calculation (960 GHz to 1.610 GHz):**

$E(\text{dB}\mu\text{V}/\text{m}) = 95.2 + \text{EIRP}(\text{dBm})$

Distance = 3 M

$E(\text{dB}\mu\text{V}/\text{m}) = 95.2 + (-75.3)$

$E(\text{dB}\mu\text{V}/\text{m}) = 19.9$

FCC 15.519 (c) 30-1000MHz Radiated Scan 3m PK AVG

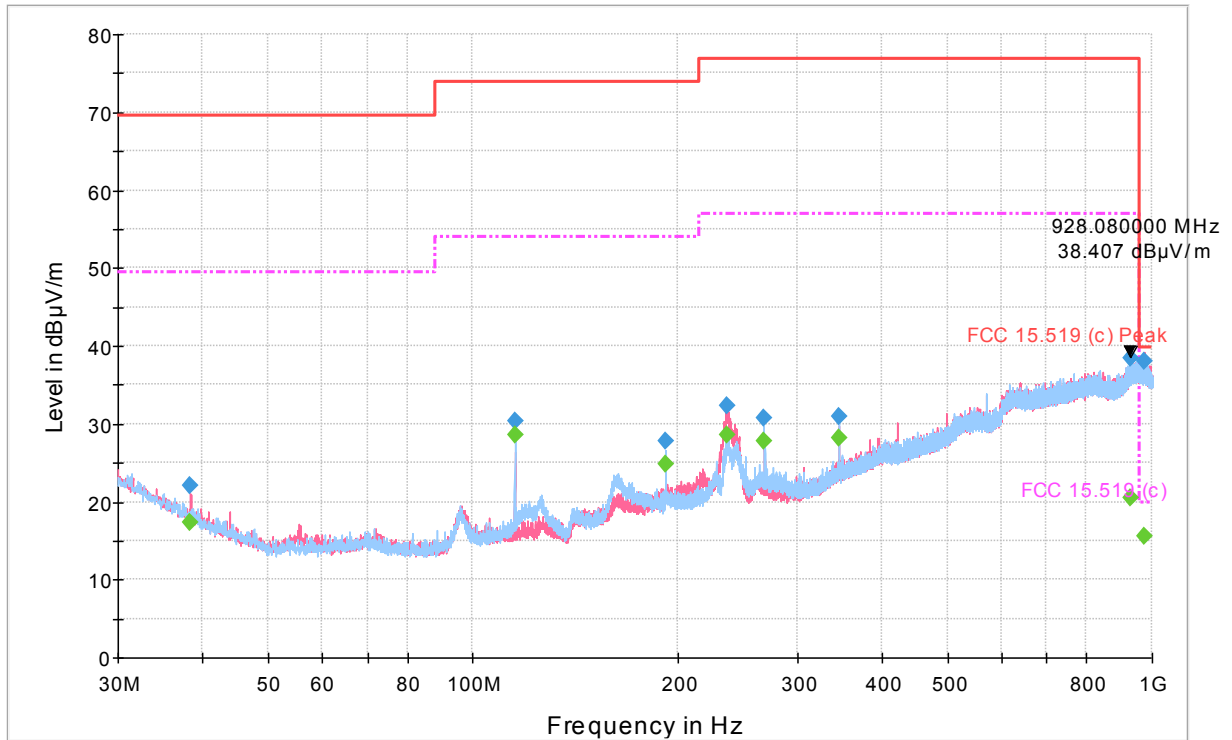

- ◆ FCC 15.519 (c) Final Result 1-PK+
- ◆ Preview Result 1V-PK+ Final Result 2-QPK
- ◆ Preview Result 1H-PK+
- ◆ FCC 15.519 (c) Peak

Frequency (MHz)	QuasiPeak (dBµV/m)	Height (cm)	Polarization	Azimuth (deg)	Corr. (dB)	Margin (dB)	Limit (dBµV/m)
38.370000	17.1	131.0	V	1.0	16.0	32.39	49.50
115.200000	27.9	177.0	H	263.0	13.3	26.08	54.00
192.000000	24.3	148.0	H	105.0	15.1	29.66	54.00
236.460000	28.2	100.0	V	190.0	17.2	28.70	56.90
268.800000	27.6	100.0	H	71.0	18.2	29.32	56.90
345.600000	27.6	100.0	H	85.0	21.0	29.33	56.90
928.080000	20.4	268.0	V	189.0	31.7	36.52	56.90
974.130000	15.1	317.0	V	195.0	31.6	4.78	19.90

**ELECTRO MAGNETIC TEST, INC.**

1547 Plymouth Street, Mountain View, CA 94043 Tel: (650)965-4000 Fax: (650)965-3000

**Radiated Emissions**

<b>EUT:</b>	Vehicle Tag	<b>Model Name:</b>	PAS-K01-12
<b>Test Mode:</b>	UWB	<b>Test Date:</b>	3/21/2019
<b>Test Engineer:</b>	Andreas Davidsson	<b>Measurement:</b>	1GHz to 18 GHz

**Limit Calculation (1 GHz to 1.610 GHz):**

$$E(\text{dBuV/m}) = 95.2 + \text{EIRP}(\text{dBm})$$

$$\text{Distance} = 3 \text{ M}$$

$$E(\text{dBuV/m}) = 95.2 + (-75.3)$$

$$E(\text{dBuV/m}) = 19.9$$

**Limit Calculation (1.610 GHz to 1.990 GHz):**

$$E(\text{dBuV/m}) = 95.2 + \text{EIRP}(\text{dBm})$$

$$\text{Distance} = 3 \text{ M}$$

$$E(\text{dBuV/m}) = 95.2 + (-63.3)$$

$$E(\text{dBuV/m}) = 31.9$$

**Limit Calculation (1.990 GHz to 3.100 GHz):**

$$E(\text{dBuV/m}) = 95.2 + \text{EIRP}(\text{dBm})$$

$$\text{Distance} = 3 \text{ M}$$

$$E(\text{dBuV/m}) = 95.2 + (-61.3)$$

$$E(\text{dBuV/m}) = 33.9$$

**Limit Calculation (3.100 GHz to 10.6 GHz):**

$$E(\text{dBuV/m}) = 95.2 + \text{EIRP}(\text{dBm})$$

$$\text{Distance} = 3 \text{ M}$$

$$E(\text{dBuV/m}) = 95.2 + (-41.3)$$

$$E(\text{dBuV/m}) = 53.9$$

**Limit Calculation (10.6 GHz to 18 GHz):**

$$E(\text{dBuV/m}) = 95.2 + \text{EIRP}(\text{dBm})$$

$$\text{Distance} = 3 \text{ M}$$

$$E(\text{dBuV/m}) = 95.2 + (-61.3)$$

$$E(\text{dBuV/m}) = 33.9$$



**ELECTRO MAGNETIC TEST, INC.**

1547 Plymouth Street, Mountain View, CA 94043 Tel: (650)965-4000 Fax: (650)965-3000

FCC 15.519 (c) 1000-18000MHz Radiated Scan 3m PK AVG

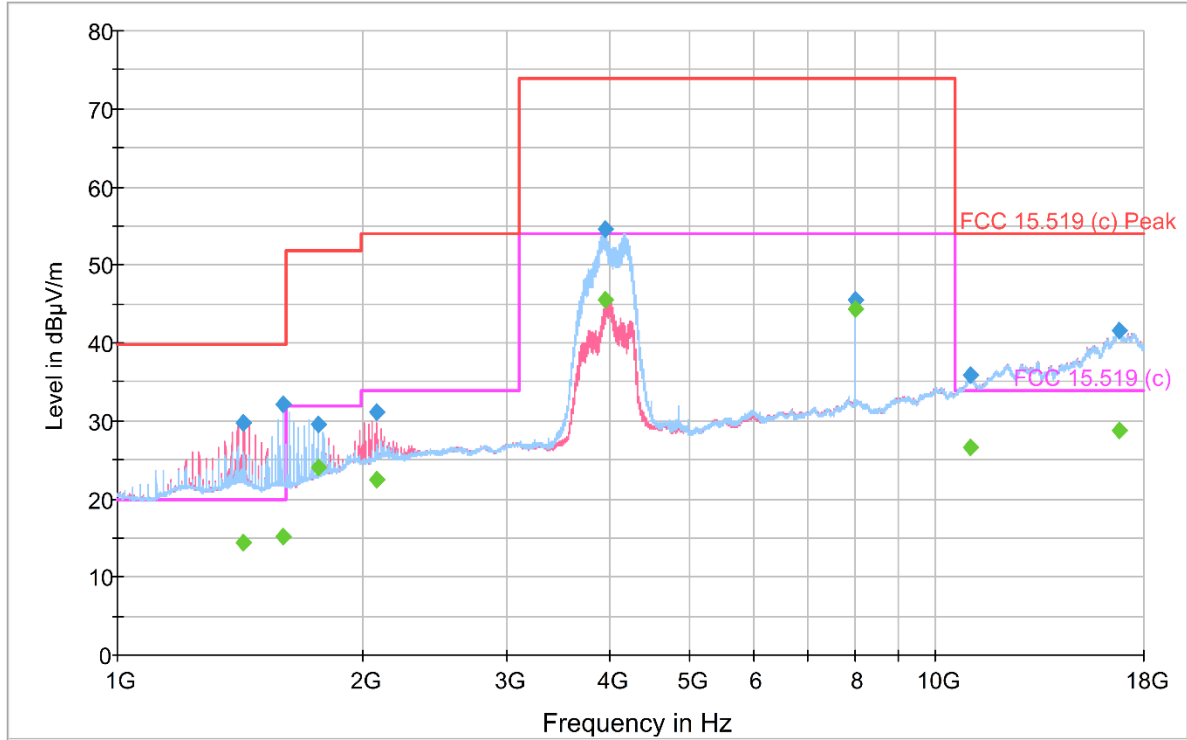

◆ FCC 15.519 (c) Final Result 1-PK+     
 — Preview Result 1V-PK+ Final Result 2-AVG     
 — Preview Result 1H-PK+ FCC 15.519 (c) Peak

Frequency (MHz)	Average (dBµV/m)	Height (cm)	Polarization	Azimuth (deg)	Corr. (dB)	Margin (dB)	Limit (dBµV/m)
1428.000000	14.3	175.0	V	113.0	-2.7	5.61	19.90
1596.000000	15.1	315.0	H	58.0	-2.8	4.82	19.90
1764.000000	24.0	314.0	H	85.0	-1.4	7.88	31.90
2076.000000	22.4	350.0	V	211.0	1.2	11.48	33.90
3949.250000	45.4	297.0	H	78.0	4.6	8.47	53.90
7987.250000	44.9	247.0	H	86.0	11.1	8.98	53.90
11045.500000	26.2	148.0	V	342.0	15.6	7.71	33.90
16763.250000	28.8	149.0	V	16.0	23.7	5.10	33.90



## ELECTRO MAGNETIC TEST, INC.

1547 Plymouth Street, Mountain View, CA 94043 Tel: (650)965-4000 Fax: (650)965-3000

### Radiated Emissions in GPS Bands

<b>EUT:</b>	Vehicle Tag	<b>Model Name:</b>	PAS-K01-12
<b>Test Mode:</b>	UWB	<b>Test Date:</b>	04/03/2019
<b>Test Engineer:</b>	Andreas Davidsson	<b>Measurement:</b>	1164MHz to 1240 MHz and 1559 MHz to 1610 MHz

#### Limit Calculation (1164-1240 MHz and 1559-1610 MHz):

$$E(\text{dBuV/m}) = 95.2 + \text{EIRP}(\text{dBm})$$

$$\text{Distance} = 3 \text{ M}$$

$$E(\text{dBuV/m}) = 95.2 + (-85.3)$$

$$E(\text{dBuV/m}) = 9.9$$

#### **Corrected Peak Power Calculation:**

- (1) Calculate the Field strength at 3 Meters.
  - (a)  $E_3 = \text{Results} - G_p + \text{AF} + \text{CL} - 107$   
Where:
    - (b) Results = Specific uncorrected results from test (dBuV)
    - (c)  $G_p$  = Pre-Amp Gain (dB)
    - (d) AF = Antenna Factor (dB/m)
    - (e) CL = Cable Loss (dB)
- (2) Calculate the EIRP by using the following equation:
  - (a)  $\text{EIRP} = E_3 - (20 \text{ Log } F + 20 \text{ Log } D - 27.5)$   
Where:
    - (b)  $E_3$  = See Step 2 (dBuV/m @ 3m)
    - (c) F = Center frequency of radiated EUT signal, in MHz
    - (d) D = Measurement distance, in meters.

Frequency (MHz)	Peak Output Power (dBm)	Limit (dBm)	Conclusion
1164 MHz to 1240 MHz	-144.48	$\leq -85.3$	Pass
1559 MHz to 1610 MHz	-148.25	$\leq -85.3$	Pass
Test Equipment: Please refer to section 5.2			
Peak Power Calculation (See above for calculation explanation)			
1164 MHz to 1240 MHz: $((8.865-34.7+28.4+3.5-107)-(20*\text{LOG}(1188)+20*\text{LOG}(3)-27.5)+0= -144.48$			
1559 MHz to 1610 MHz: $((7.66-34.7+28.4+3.5-107)-(20*\text{LOG}(1596)+20*\text{LOG}(3)-27.5)+0= -148.25$			



**ELECTRO MAGNETIC TEST, INC.**

1547 Plymouth Street, Mountain View, CA 94043 Tel: (650)965-4000 Fax: (650)965-3000

**Radiated Emissions in GPS Bands**

<b>EUT:</b>	Vehicle Tag	<b>Model Name:</b>	PAS-K01-12
<b>Test Mode:</b>	UWB	<b>Test Date:</b>	04/03/2019
<b>Test Engineer:</b>	Andreas Davidsson	<b>Measurement:</b>	1164MHz to 1240 MHz

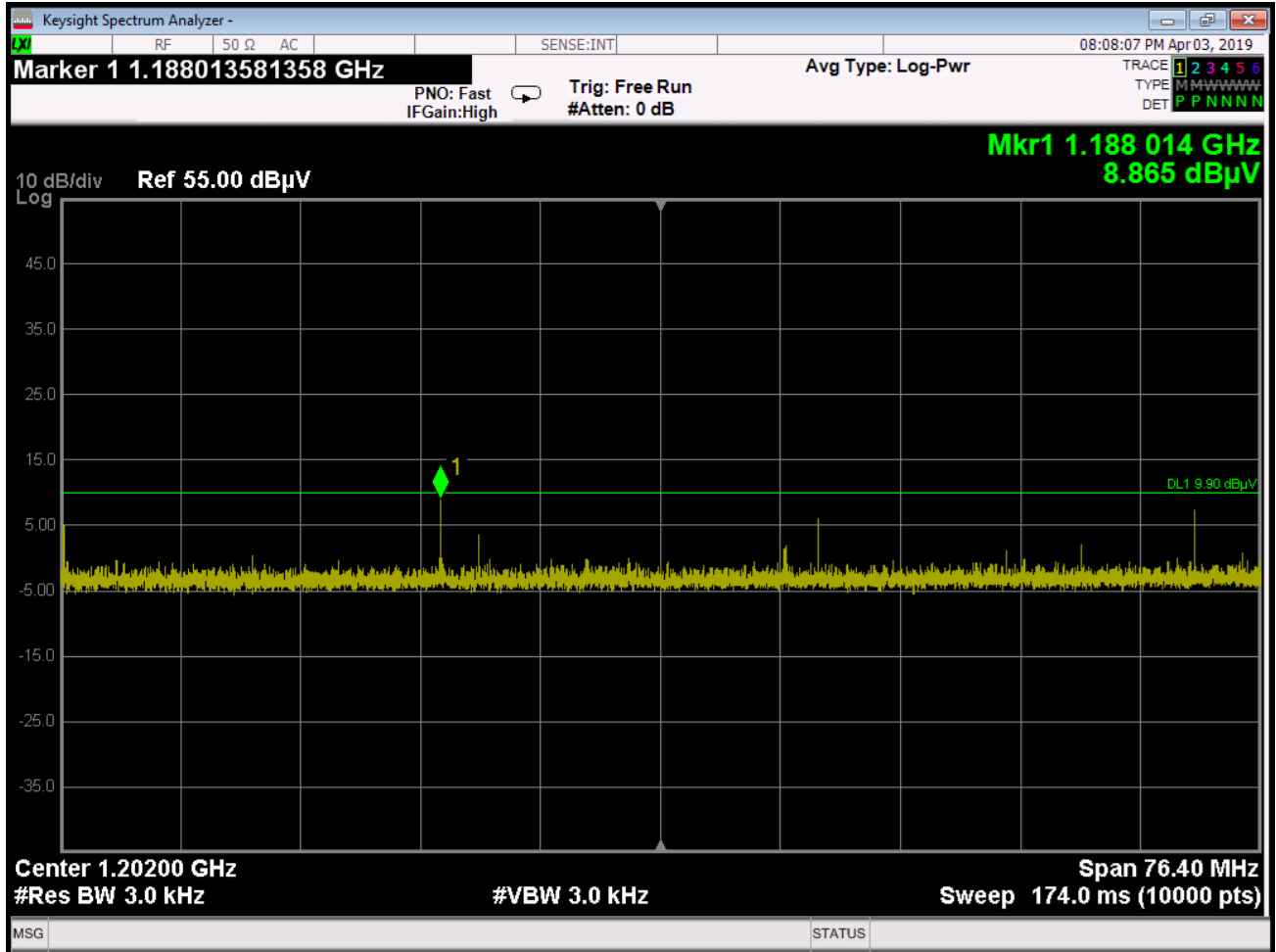

**1164-1240 MHz, Antenna Polarization**





**ELECTRO MAGNETIC TEST, INC.**

1547 Plymouth Street, Mountain View, CA 94043 Tel: (650)965-4000 Fax: (650)965-3000

**Radiated Emissions in GPS Bands**

<b>EUT:</b>	Vehicle Tag	<b>Model Name:</b>	PAS-K01-12
<b>Test Mode:</b>	UWB	<b>Test Date:</b>	04/03/2019
<b>Test Engineer:</b>	Andreas Davidsson	<b>Measurement:</b>	1559 MHz to 1610 MHz

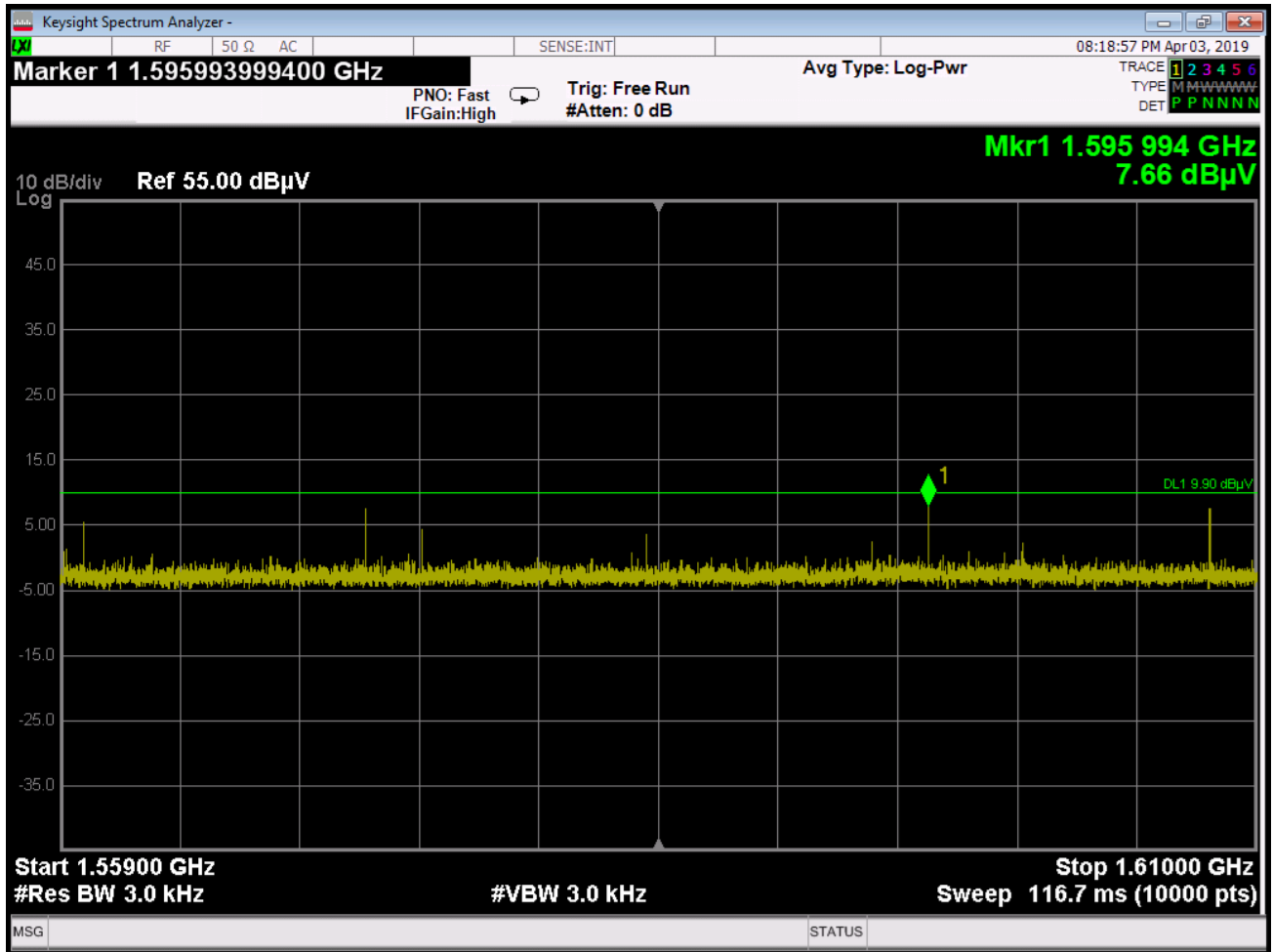

**1559-1610 MHz, Antenna Polarization**



**ELECTRO MAGNETIC TEST, INC.**

1547 Plymouth Street, Mountain View, CA 94043 Tel: (650)965-4000 Fax: (650)965-3000

**Peak Emissions within a 50 MHz Bandwidths**

<b>EUT:</b>	Vehicle Tag	<b>Model Name:</b>	PAS-K01-12
<b>Test Mode:</b>	UWB	<b>Test Date:</b>	10/16/2018
<b>Test Engineer:</b>	Andreas Davidsson	<b>Measurement:</b>	Fundamental

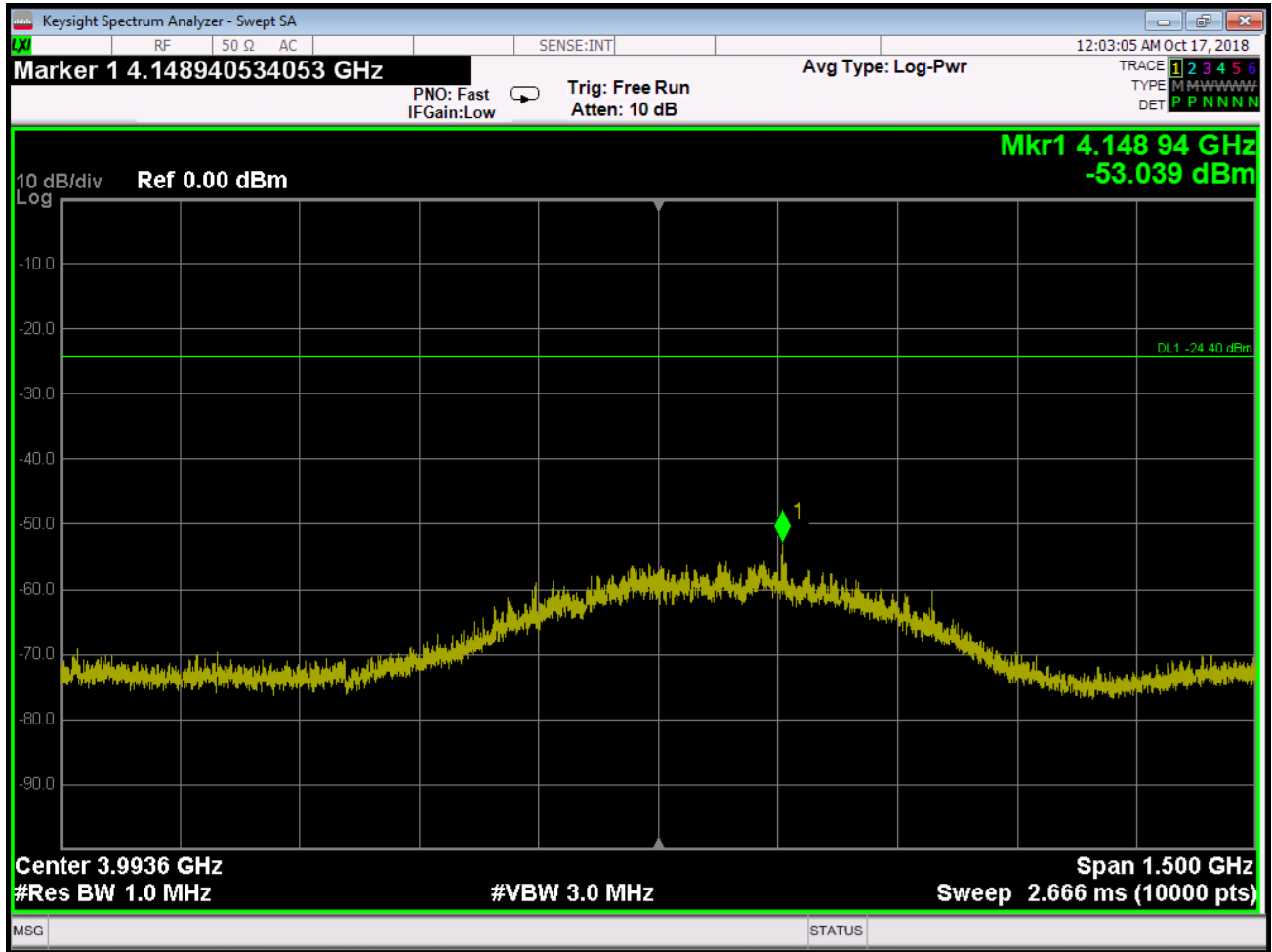

**Result Peak**



**ELECTRO MAGNETIC TEST, INC.**

1547 Plymouth Street, Mountain View, CA 94043 Tel: (650)965-4000 Fax: (650)965-3000

**Bandwidth Test**

<b>Company:</b>	Kyungwoo Systech, Inc.	<b>Test Date:</b>	10/16/2018
<b>EUT Name:</b>	Vehicle Tag	<b>Test Engineer:</b>	Andreas Davidsson
<b>Model:</b>	PAS-K01-12	<b>Test Result:</b>	PASS



Limit:	Test Result:	Conclusion:
10 dB bandwidth contained between 3100 to 10600 MHz	10 dB bandwidth contained between 3805.69 MHz and 4317.14 MHz	PASS
10 dB bandwidth $\geq$ 500 MHz	511MHz	PASS



**ELECTRO MAGNETIC TEST, INC.**

1547 Plymouth Street, Mountain View, CA 94043 Tel: (650)965-4000 Fax: (650)965-3000

**Transmission Test**

<b>Company:</b>	Kyungwoo Systech, Inc.	<b>Test Date:</b>	10/16/2018
<b>EUT Name:</b>	Vehicle Tag	<b>Test Engineer:</b>	Andreas Davidsson
<b>Model:</b>	PAS-K01-12	<b>Test Result:</b>	PASS

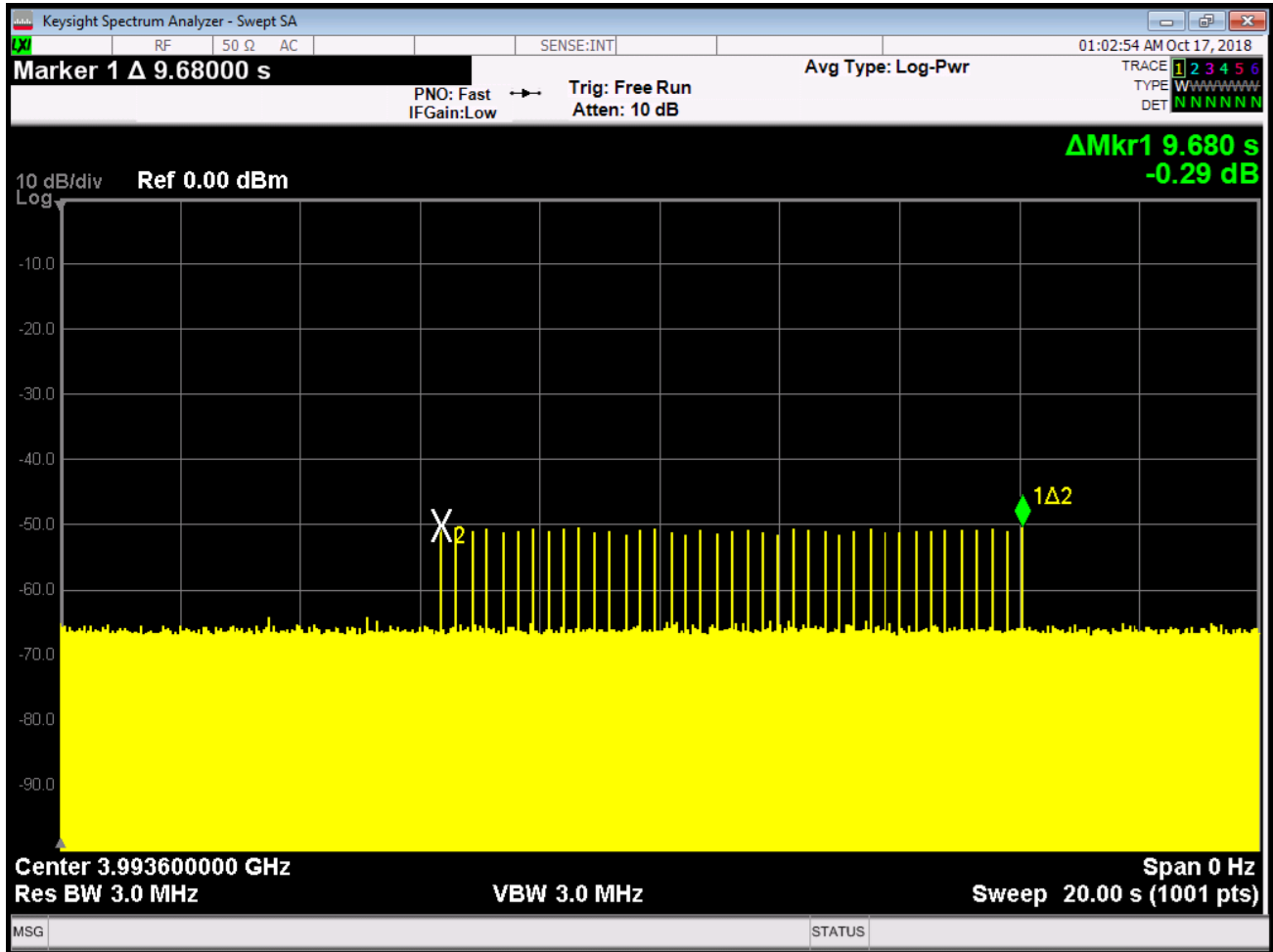

Limit:	Test Result:	Conclusion:
An acknowledgment of reception must continue to be received by the UWB intentional radiator at least every 10 seconds or the UWB device must cease transmitting.	EUT stops transmission if it does not receive an acknowledgement within 10 seconds.	PASS



***ELECTRO MAGNETIC TEST, INC.***

1547 Plymouth Street, Mountain View, CA 94043 Tel: (650)965-4000 Fax: (650)965-3000

---

**APPENDIX B**

***TEST SETUP DIAGRAMS***



**ELECTRO MAGNETIC TEST, INC.**

1547 Plymouth Street, Mountain View, CA 94043 Tel: (650)965-4000 Fax: (650)965-3000

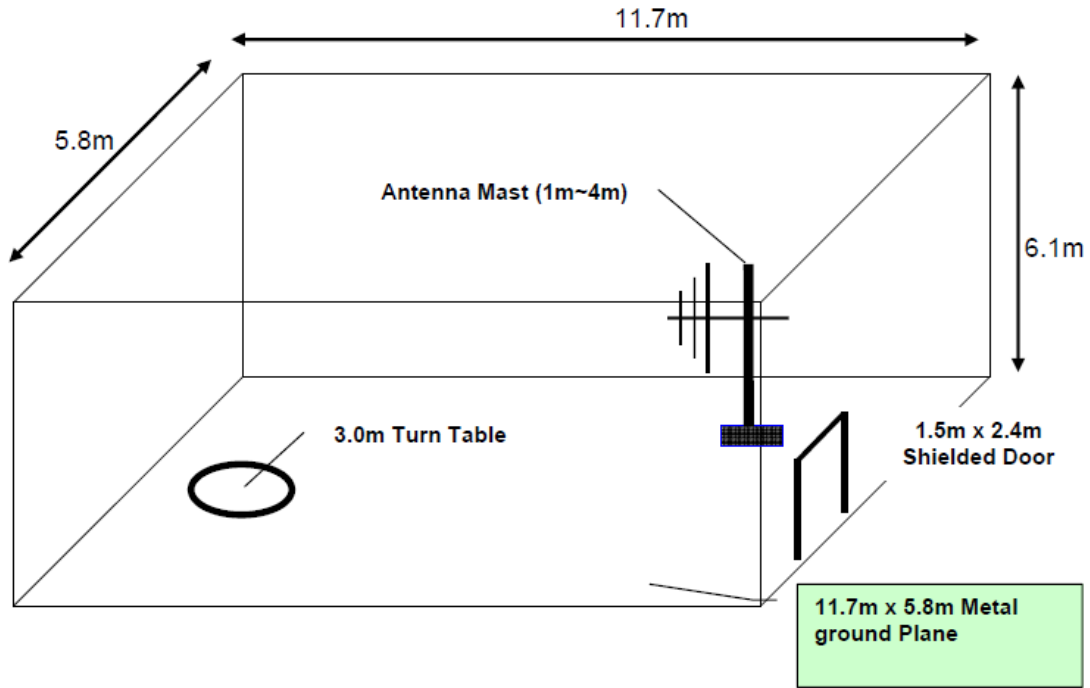

**FIGURE 1 - LAYOUT OF 3 METER SEMI-ANECHOIC CHAMBER**



# ELECTRO MAGNETIC TEST, INC.

1547 Plymouth Street, Mountain View, CA 94043 Tel: (650)965-4000 Fax: (650)965-3000

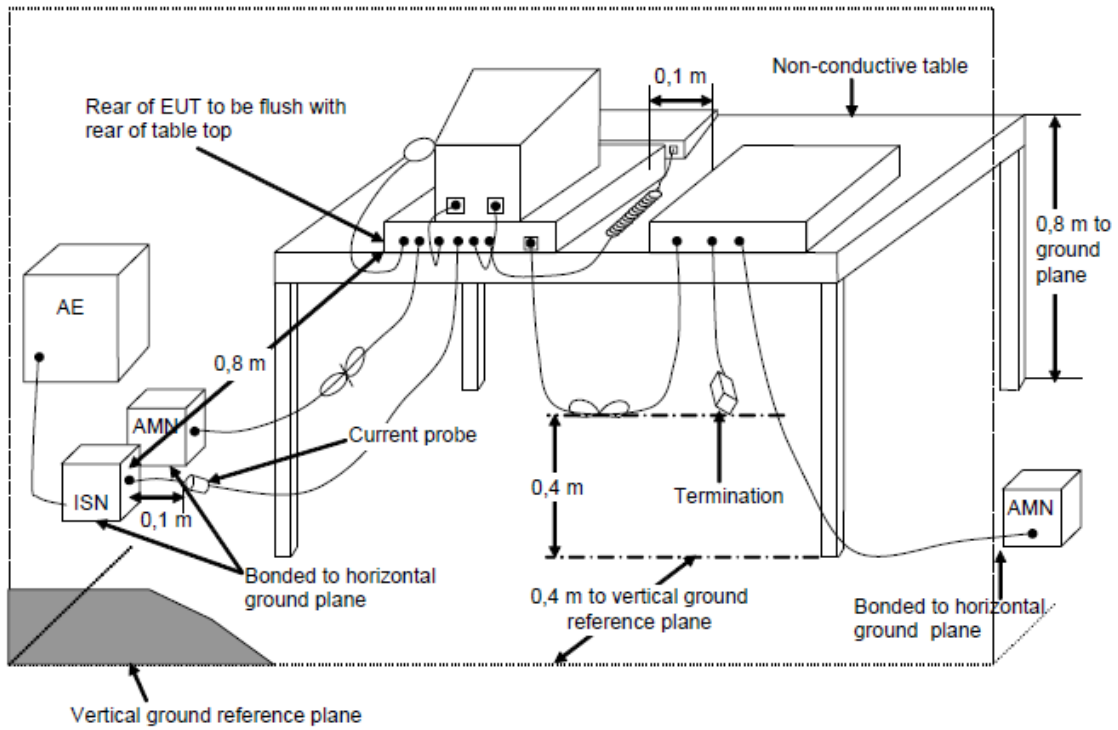

FIGURE 2 – TABLETOP CONDUCTED EMISSIONS TEST SETUP – SITE “D”

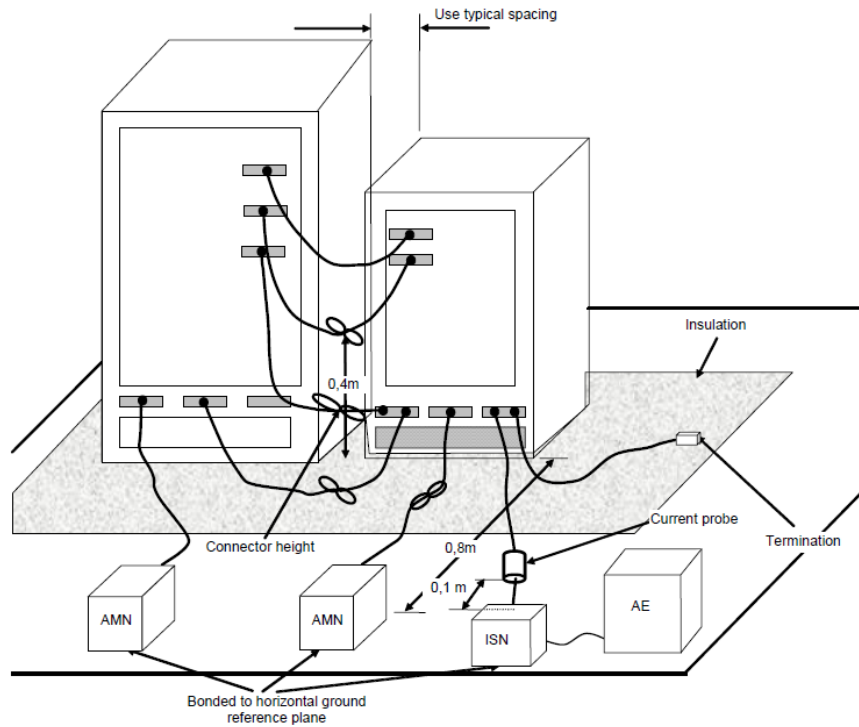

FIGURE 2a – FLOORSTANDING CONDUCTED EMISSIONS TEST SETUP – SITE “D”



***ELECTRO MAGNETIC TEST, INC.***

1547 Plymouth Street, Mountain View, CA 94043 Tel: (650)965-4000 Fax: (650)965-3000

---

**APPENDIX C**

***MODIFICATIONS TO THE EUT***





***ELECTRO MAGNETIC TEST, INC.***

1547 Plymouth Street, Mountain View, CA 94043 Tel: (650)965-4000 Fax: (650)965-3000

---

## **MODIFICATIONS TO THE EUT**

No modifications were made to the EUT by Electro Magnetic Test, Inc. personnel during the testing.



***ELECTRO MAGNETIC TEST, INC.***

1547 Plymouth Street, Mountain View, CA 94043 Tel: (650)965-4000 Fax: (650)965-3000

---

**APPENDIX D**

***ADDITIONAL MODELS COVERED  
UNDER THIS REPORT***



***ELECTRO MAGNETIC TEST, INC.***

1547 Plymouth Street, Mountain View, CA 94043 Tel: (650)965-4000 Fax: (650)965-3000

---

## **ADDITIONAL MODELS COVERED UNDER THIS REPORT**

There are no additional models to be covered under this report.