



## 4G LTE SMD Antenna

## SZP-C-0L02

4G LTE/3G/2G: 698 – 960 MHz; 1710 – 2690MHz

### Description

A highly compact yet high-performance solution for devices that require embedded antenna designs. Synzen have created the optimal solution for 4G LTE applications that also simplifies the design in process.

- Designed to work in compact devices with limited space
- Resistant to de-tuning
- For 4G LTE Applications, but also backward compatible for 3G/2G systems
- Less dependency on GND plane length
- SMD component supplied in Tape and reel
- Higher performance than larger OTS solutions
- Simple design in process
- Project life support Direct from Synzen Engineers
- Suitable for sealing with resin / potting compounds

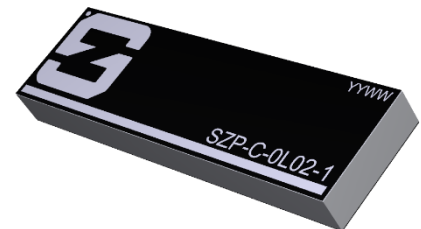

### Applications

Telematics  
Smart City  
Drones

Smart Metering  
Gateways  
POS

Home Automation  
Healthcare  
OBD-II



*Patent pending design*



## General Specifications

### Mechanical Specifications

<b>Part Number</b>	SZP-C-0L02
<b>Name</b>	OPALA
<b>Dimensions</b>	32.8 x 9.6 x 3.3 (mm)
<b>Required Clearance area</b>	32.8 x 11.6 (mm)
<b>Weight</b>	<2g
<b>Antenna Type</b>	Surface Mount Device

### RF Specifications

<b>Frequency Range (MHz)</b>	698-960	1710-2200	2300-2400	2500-2690
<b>Average Efficiency (Linear)</b>	>50%	>55%	>50%	>50%
<b>Peak Gain (dBi)</b>	1.50	3.40	2.70	1.50
<b>S11 (max) dB</b>	<-6.0	<-7.5	<6.0	<-5.0
<b>VSWR (max)</b>	3.10:1	2.90:1	3.25:1	3.50:1
<b>Impedance</b>	50 $\Omega$			
<b>Polarization</b>	Linear			

*The data shown was measured on Synzen OPALA DVK (SZDV-C-0L02)*

### Environmental Specifications

<b>Operational Temperature</b>	-40 to +125 (°C)
<b>Storage Temperature</b>	-10 to +40 (°C)
<b>Relative Humidity</b>	≤75%



## LTE Bands Covered by SZP-C-0L02

### Supported band list

LTE Band	Frequency Band	Uplink (MHz)	Downlink (MHz)	Supported
1	2100	1920 – 1980	2110 – 2170	YES
2	1900	1850 – 1910	1930 – 1990	YES
3	1800	1710 – 1785	1805 – 1880	YES
4	1700	1710 – 1755	2110 – 2155	YES
5	850	824 – 849	869 – 894	YES
7	2600	2500 – 2570	2620 – 2690	YES
8	900	880 – 915	925 – 960	YES
10	1700	1710 – 1770	2110 – 2170	YES
11	1500	1427.9 – 1447.9	1475.9 – 1495.9	NO
12	700	699 – 716	729 – 746	YES
13	700	777 – 787	746 – 756	YES
14	700	788 – 798	758 – 768	YES
17	700	704 – 716	734 – 746	YES
18	850	815 – 830	860 – 875	YES
19	850	830 – 845	875 – 890	YES
20	800	832 – 862	791 – 821	YES
21	1500	1447.9 – 1462.9	1495.9 – 1510.9	NO
22	3500	3410 – 3490	3510 – 3590	NO
24	1600	1626.5 – 1660.5	1525 – 1559	NO
25	1900	1850 – 1915	1930 – 1995	YES
26	850	814 – 849	859 – 894	YES
27	800	807 – 824	852 – 869	YES
28	700	703 – 748	758 – 803	YES
29	700	N/A	717 – 728	YES
30	2300	2305 – 2315	2350 – 2360	YES
31		452.5 – 457.5	462.5 – 467.5	NO
32	1500	N/A	1452 – 1496	NO
33	2100	1900 – 1920		YES
34	2100	2010 – 2025		YES
35	1900	1850 – 1910		YES
36	1900	1930 – 1990		YES
37		1910 – 1930		YES
38	2600	2570 – 2620		YES
39	1900	1880 – 1920		YES
40	2300	2300 – 2400		YES
41	2500	2496 – 2690		YES
42	3500	3400 – 3600		NO
43	3700	3600 – 3800		NO
44	700	703 – 803		YES
45	1500	1447 – 1467		NO
46	5200	5150 – 5925		NO
47	5900	5855 – 5925		NO
48	3600	3550 – 3700		NO
50	1500	1432 – 1517		NO
51	1500	1427 – 1432		NO
65	2100	1920 – 2010	2110 – 2200	YES
66	1700	1710 – 1780	2110 – 2200[2]	YES
67	700	N/A	738 – 758	YES
68	700	698 – 728	753 – 783	YES
69	2600	N/A	2570 – 2620	YES
70	2000	1695 – 1710	1995 – 2020	NO



## RF Characteristics

### S11 Parameter

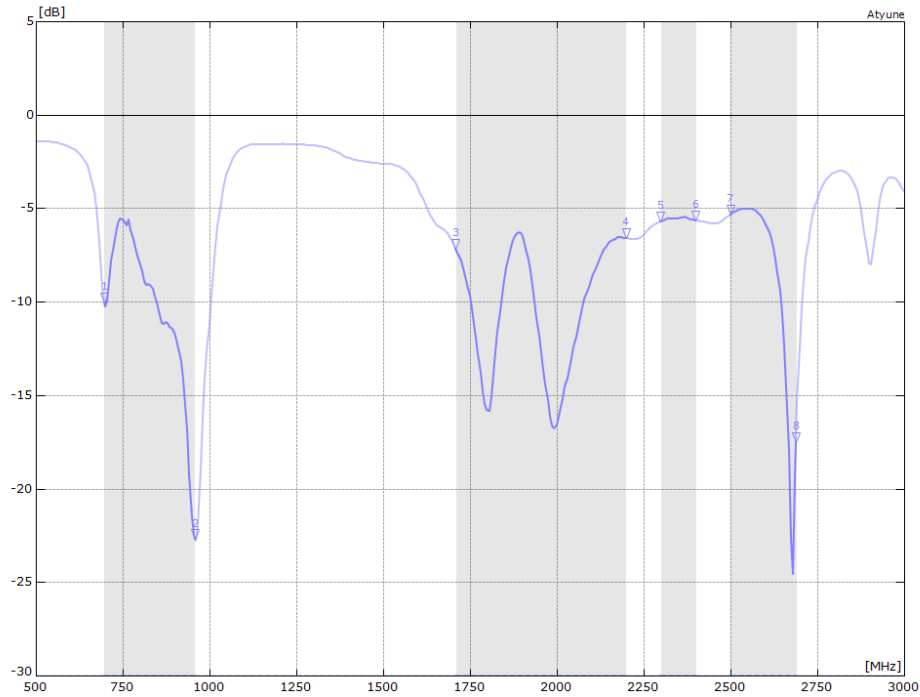

### VSWR

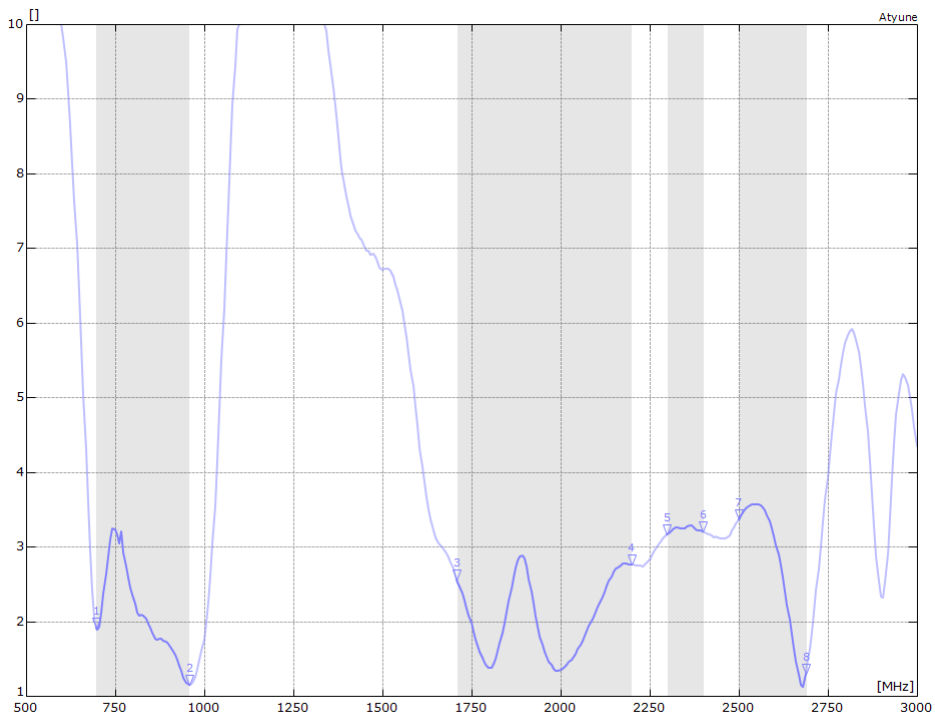



## Radiated Performance

### 2D Polar Plot

The data shown was measured on Synzen OPALA DVK (SZDV-C-0L02)

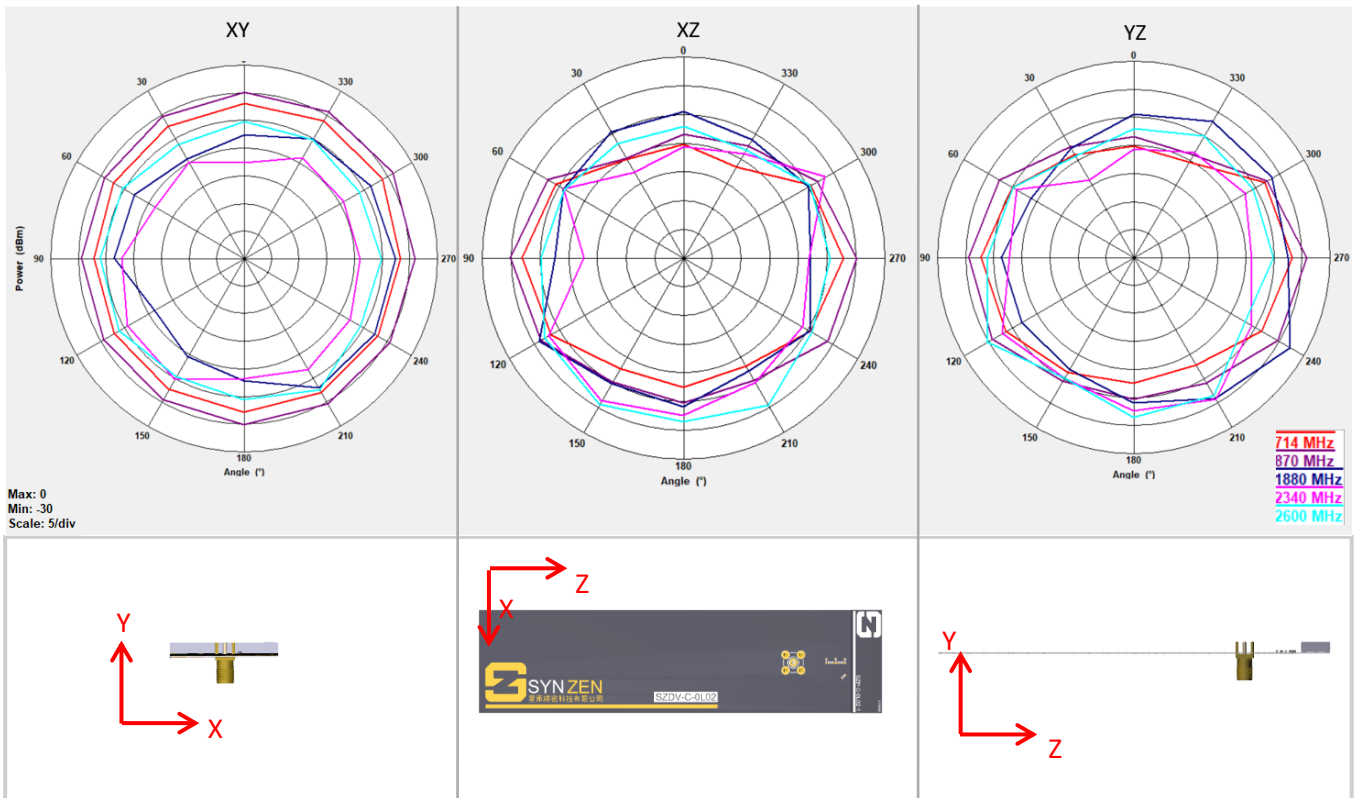



## Radiated Performance

### 3D Radiation Pattern at 714MHz

The data shown was measured on Synzen OPALA DVK (SZDV-C-0L02).

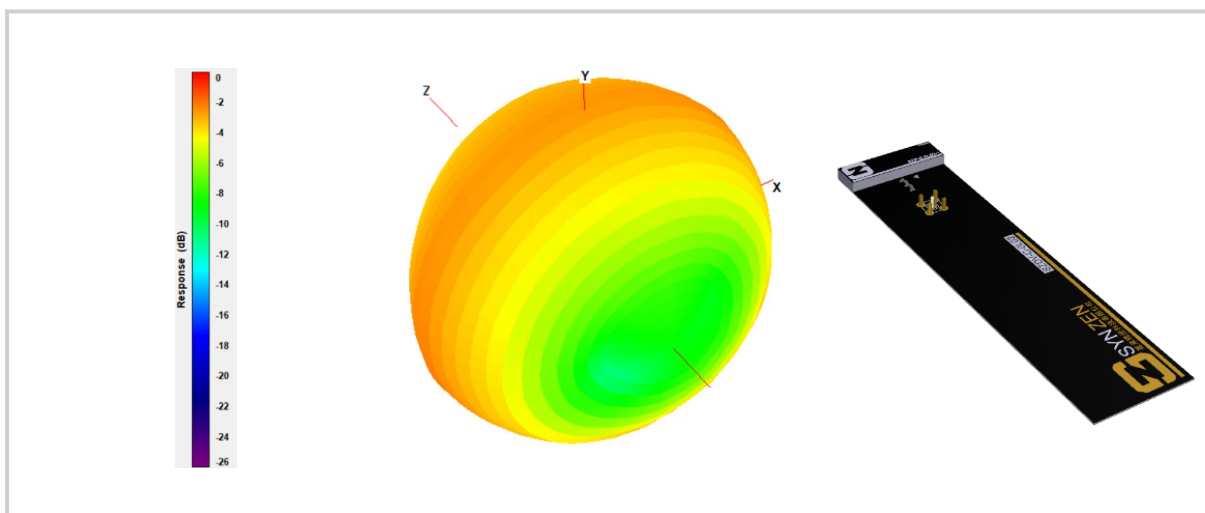
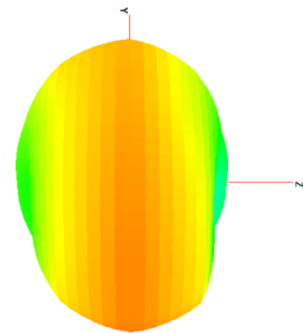
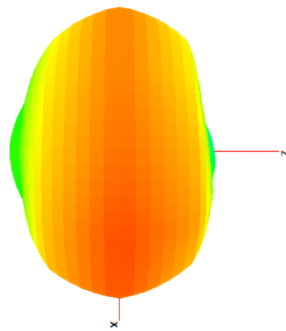
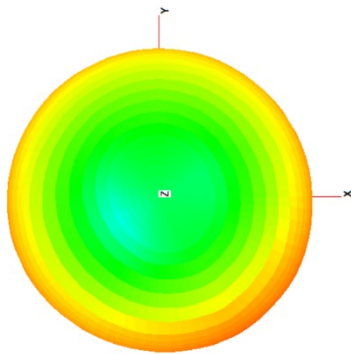
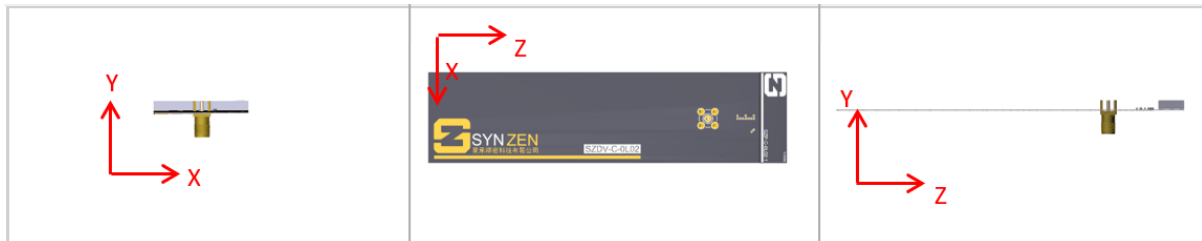



## Radiated Performance

### 3D Radiation Pattern at 870MHz

The data shown was measured on Synzen DVK (SZDV-C-0L02).

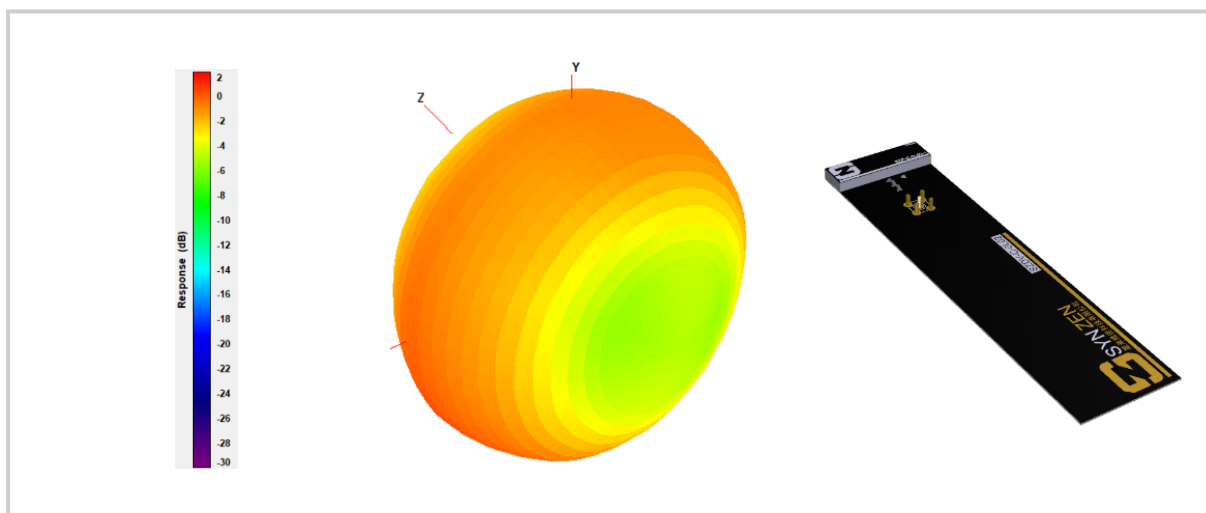
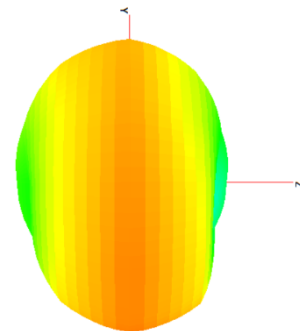
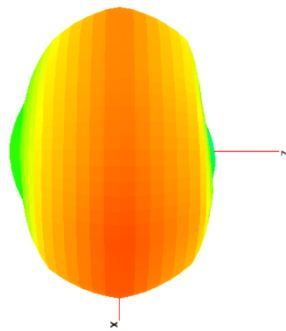
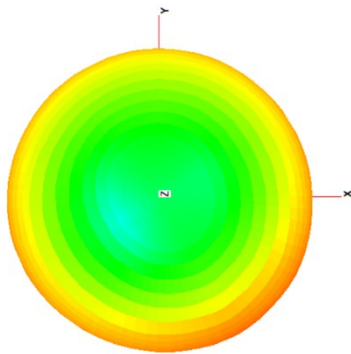
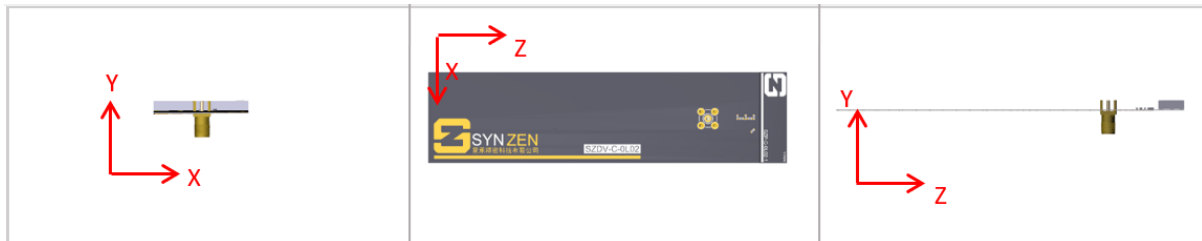



## Radiated Performance

### 3D Radiation Pattern at 1880MHz

The data shown was measured on Synzen DVK (SZDV-C-0L02).

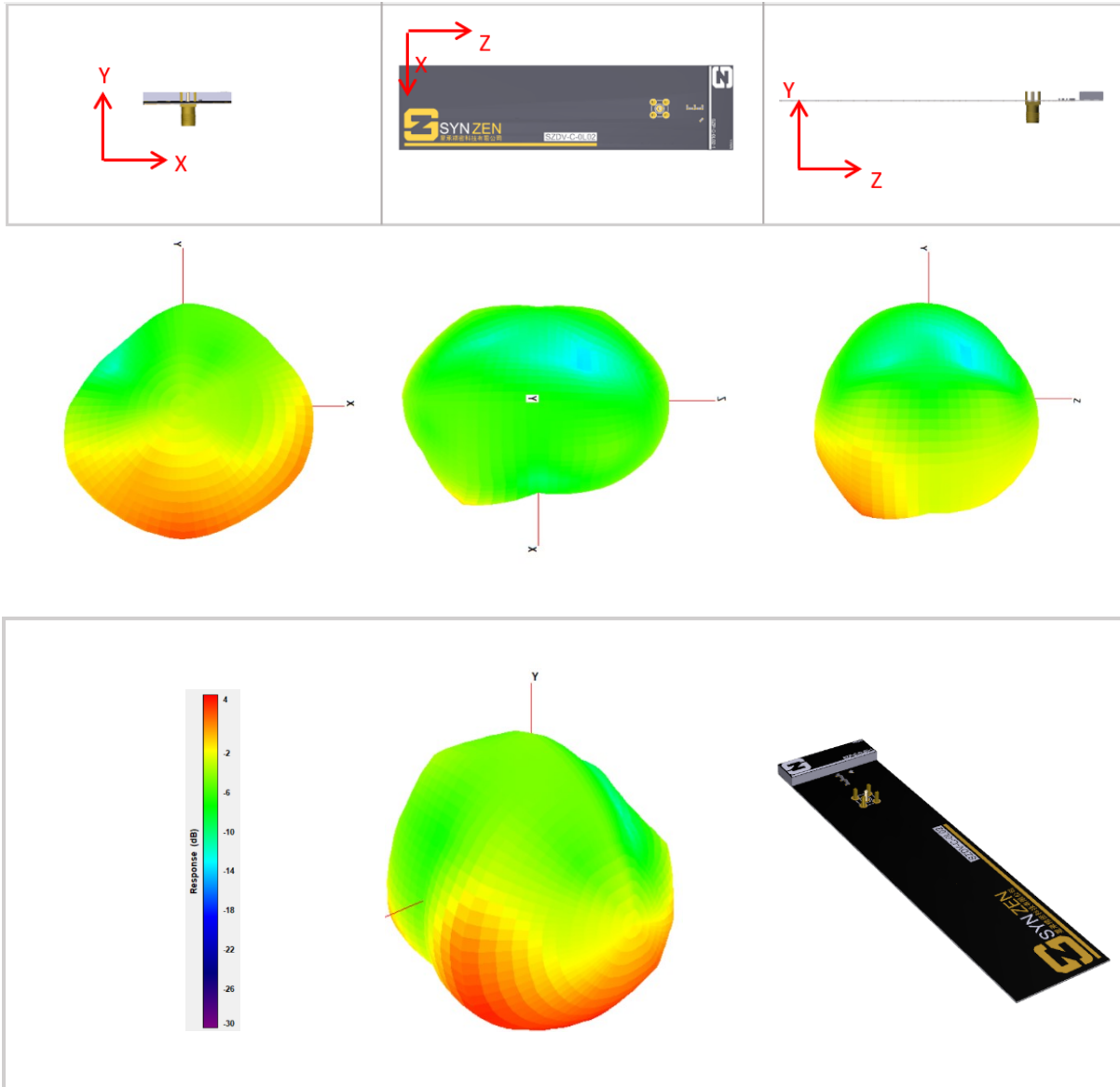





## Radiated Performance

### 3D Radiation Pattern at 2600MHz

The data shown was measured on Synzen OPALA DVK (SZDV-C-0L02).

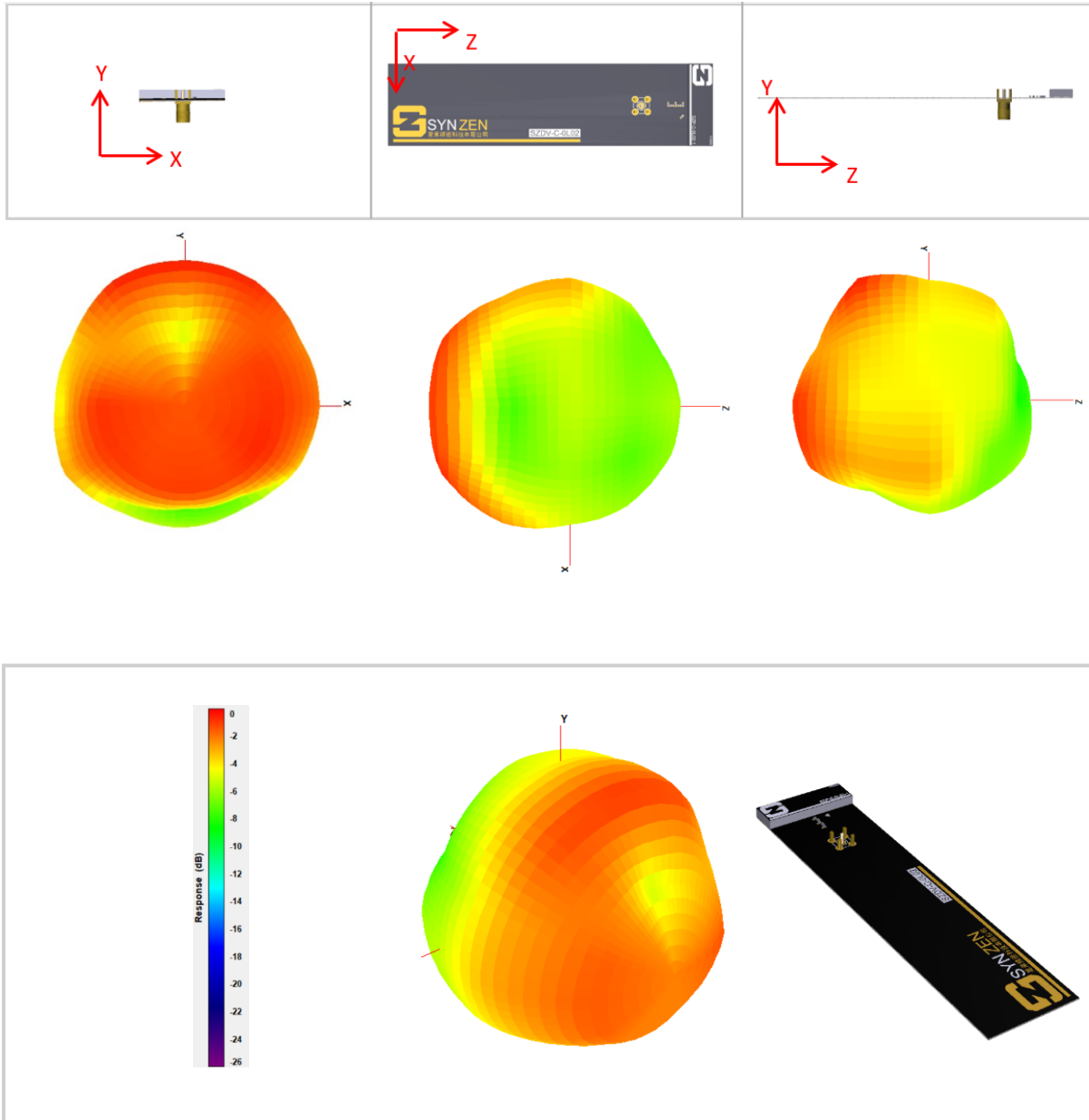

## Mechanical

### Antenna Mechanical Drawing

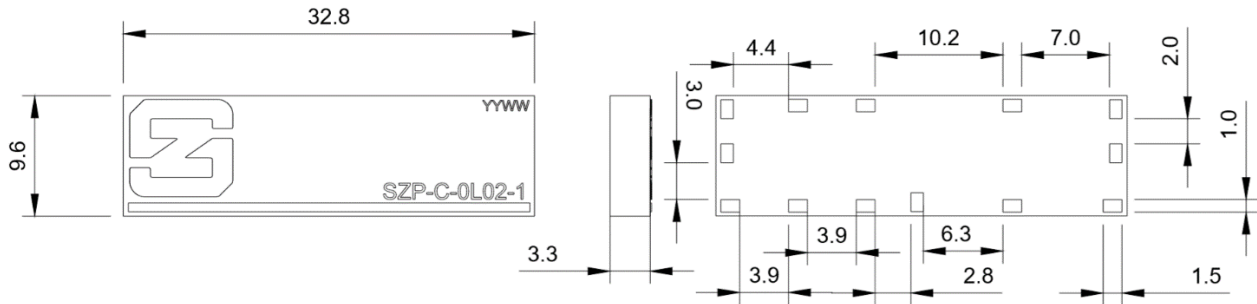

All dimensions in mm

### Required Host PCB Footprint

The host PCB requires the footprint shown below. PCB library files and DXF is available from our website [www.synzen.com.tw/products](http://www.synzen.com.tw/products).

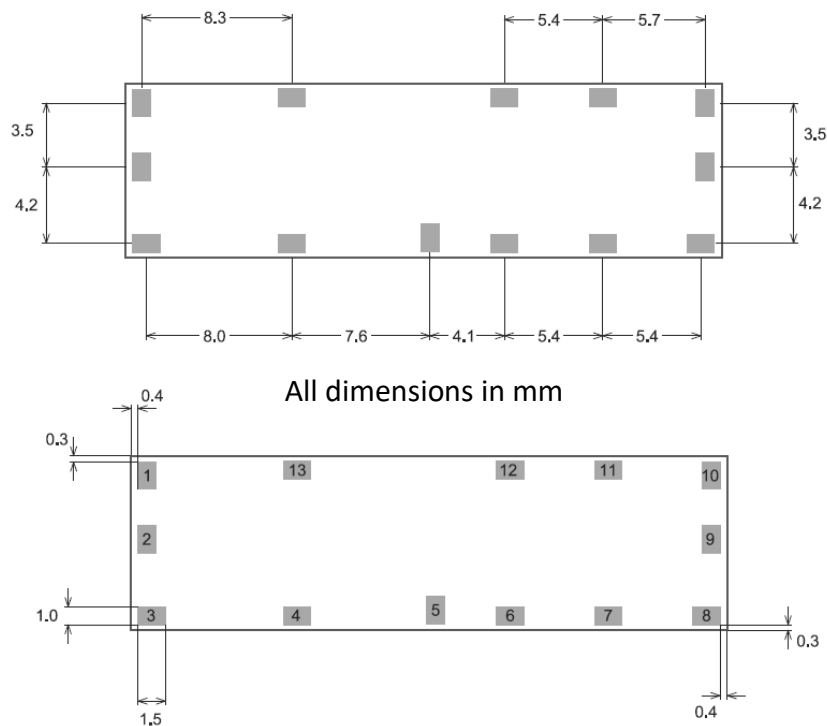

All dimensions in mm

## Antenna Pinout

### SZP-C-0L02 Schematic Symbol

The schematic symbol for the antenna is shown below with a description of each pin.

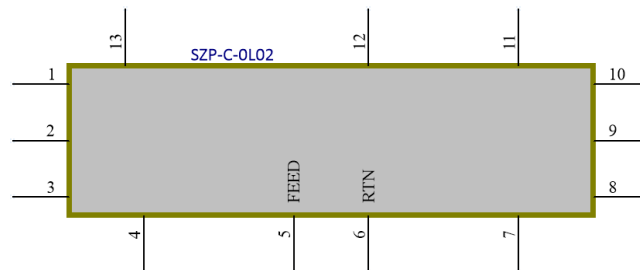

Pin	Description
1,2,3,4,7,8,9,10,11,12,13	Not used (Mechanical support)
5	Feed to Matching network
6	Tuning Return

## Development Kit Mechanical

### SZDV-C-0L02 Development Kit

The SZDV-C-0L02 development kit is a PCBA with the LTE antenna (OPALA) fitted and optimised with a matching network. Connection to the antenna is made using the fitted female SMA connector.

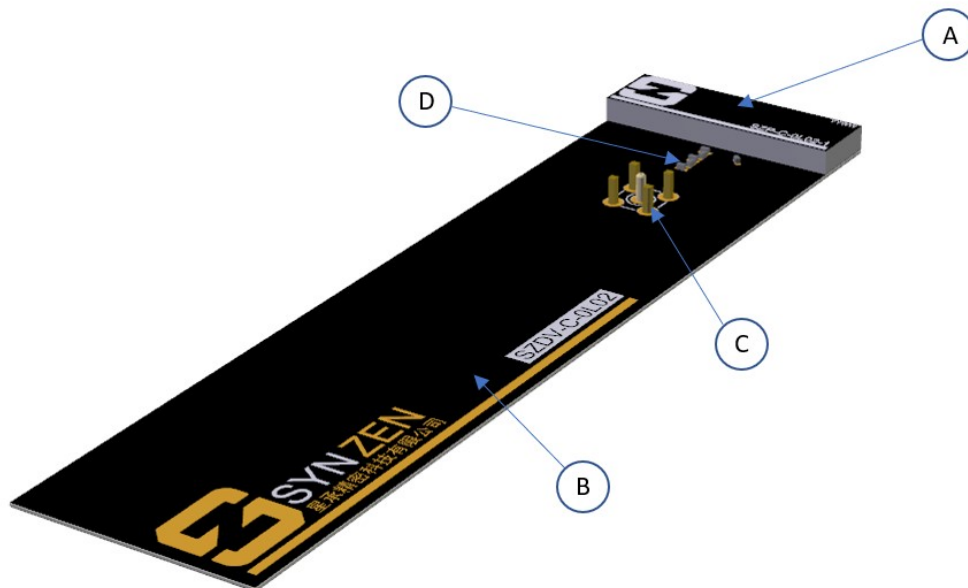
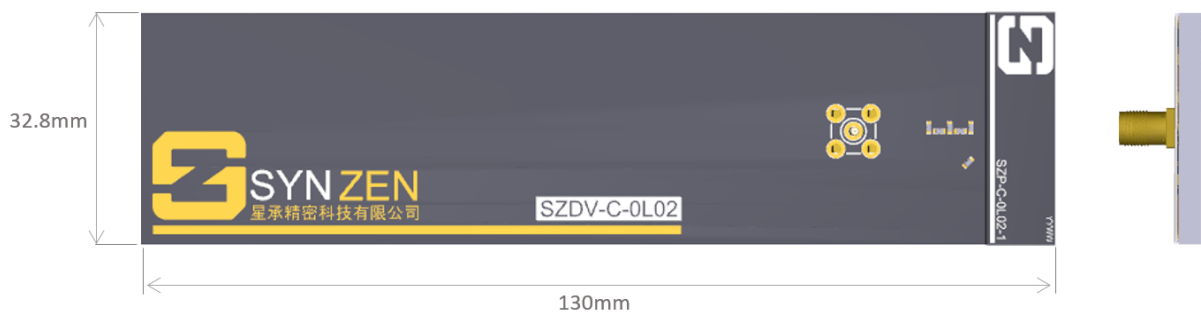

A	SZP-C-0L02 (Antenna)
B	Host PCB
C	SMA Connector
D	Matching Circuit

## Development Kit Circuit

### Development Kit Matching Circuit

The circuit of the DEV kit along with the BOM is shown below. The matching network topology should be used on the device host PCB although the matching values will be dependent on the host PCB and device environment. Synzen provide a matching service to optimise your device to ensure the best performance, please contact [sales@synzen.com.tw](mailto:sales@synzen.com.tw) for more information.

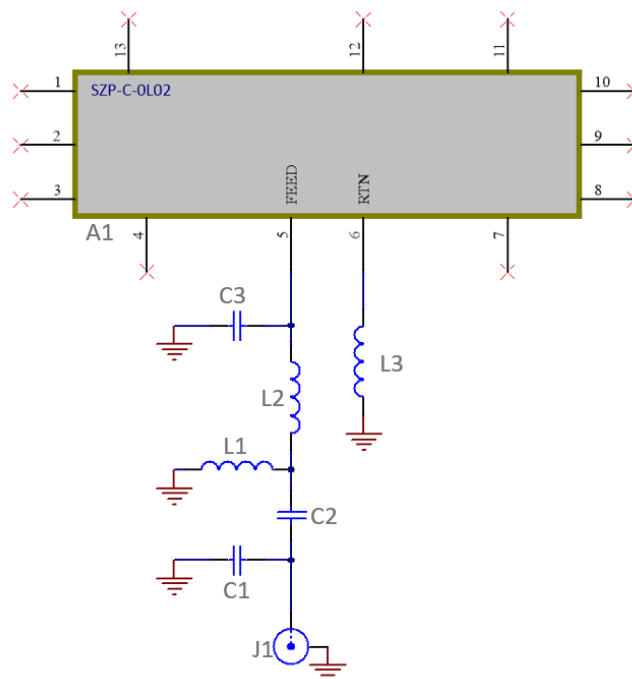

Designator	Component Type	Value	Size	Manufacturing Part No.
A1	Antenna	OPALA	-	SZP-C-0L02
C2	Resistor	0R	0402	Non-specific part
L2	Inductor	3.3nH	0402	LQG15HS3N3S02D
C1	NA	DNP	0402	Do Not Place
C3	Capacitor	0.5pF	0402	GJM1555C1H0R5CB01D
L1, L3	Inductor	15nH	0402	LQG15HS1NJ02D
J1	SMA Connector	-	-	ACE solution A3SAFTST135



## Host PCB Placement and Clearance

### Placement

The antenna is designed to function placed at the shortest PCB edge to utilise the PCB length for best low band performance.

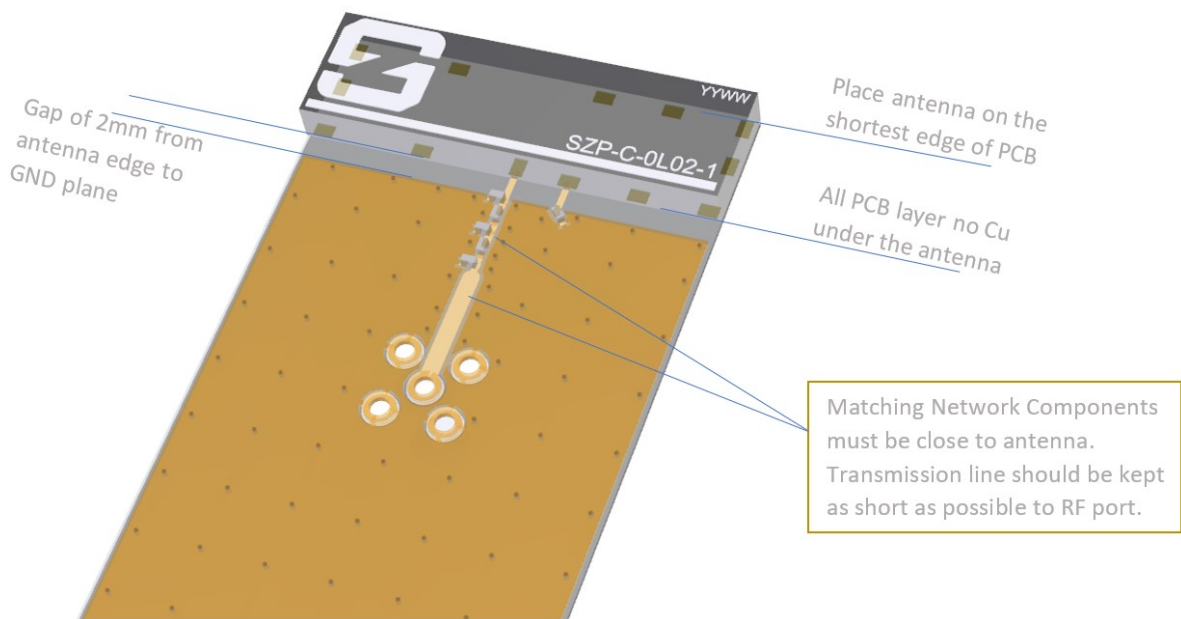

### Clearance

A clearance is required through all PCB layers for the precise area shown. No components must be placed within this area otherwise RF coupling from the antenna to any conductor will occur reducing performance significantly. Also, any components such as battery or display must also avoid this area.

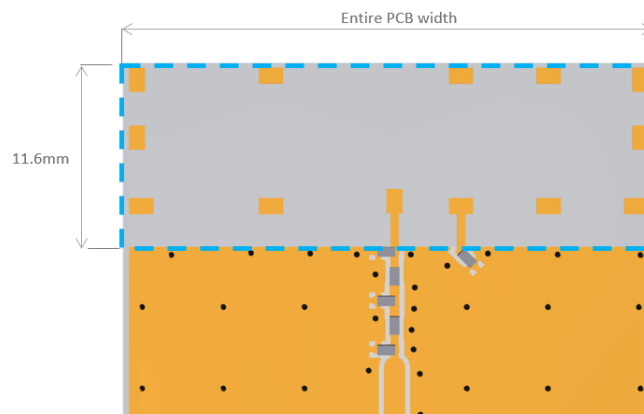



## Application Note for Smaller Devices

### Small host PCB Performance

Other antennas rely on the host PCB GND length for the low band to perform well. Opala still relies on the host GND to radiate but due to innovative antenna element design it can still function and perform well on a GND plane of only 60 x 33 (mm), smaller than a credit card.



### Example 1: AT&T CatM1 bands (2,4,12): 698-746MHz; 1710-2155MHz

PCB Dimensions	60 x 30 (mm)	
Frequency Range (MHz)	698-746	1710-2155
Average Efficiency (Linear)	21%	55%
Peak Gain (dBi)	-3.0	3.50
S11 (max) dB	<-3.5	<-6.0
VSWR (max)	3.10:1	2.90:1

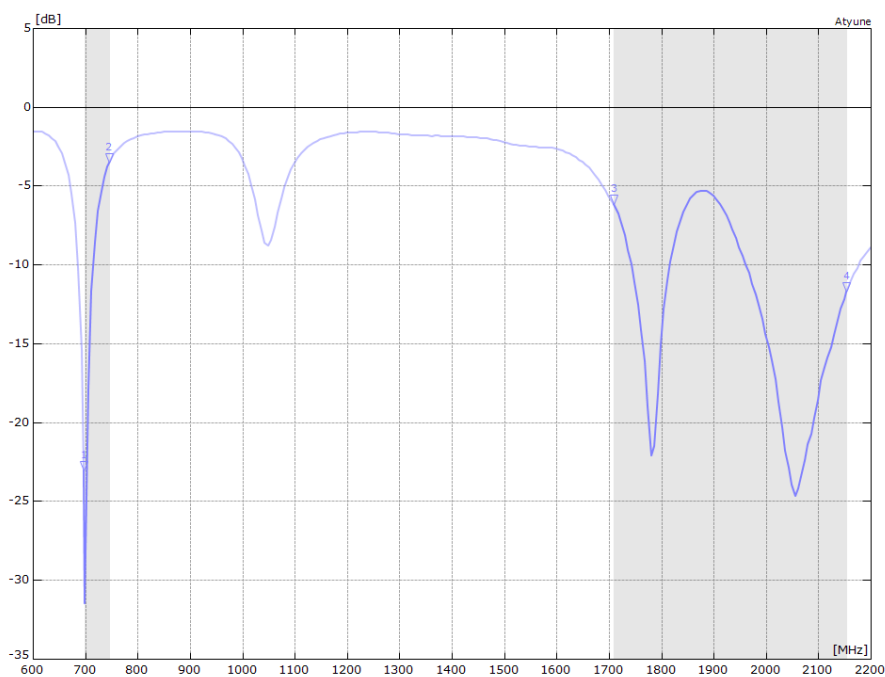

## Application Note for Smaller Devices

**Example 2: LTE bands: 698-746MHz;1710-2170MHz;2300-2400;2500-2690MHz**



Frequency Range (MHz)	698-960	1710-2200	2300-2400	2500-2690
Average Efficiency (Linear)	15%	60%	45%	40%
Peak Gain (dBi)	-3.20	3.45	2.8.	0.50
Peak Gain (dBi)	1.50	3.40	2.70	1.80
S11 (max) dB	<-3.0	<-8.0	<-6.5	<-5.0

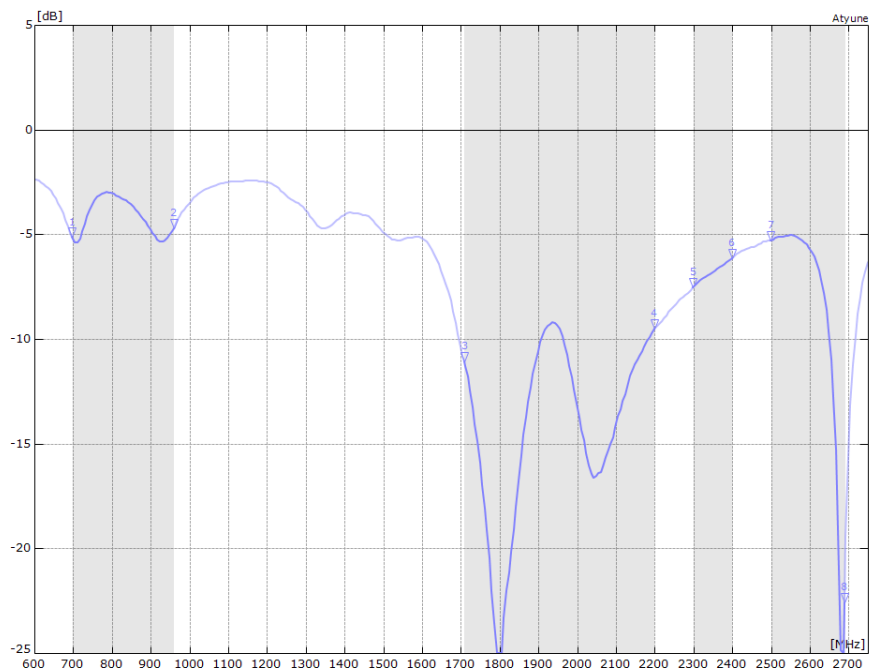



## Soldering

### Reflow Profile

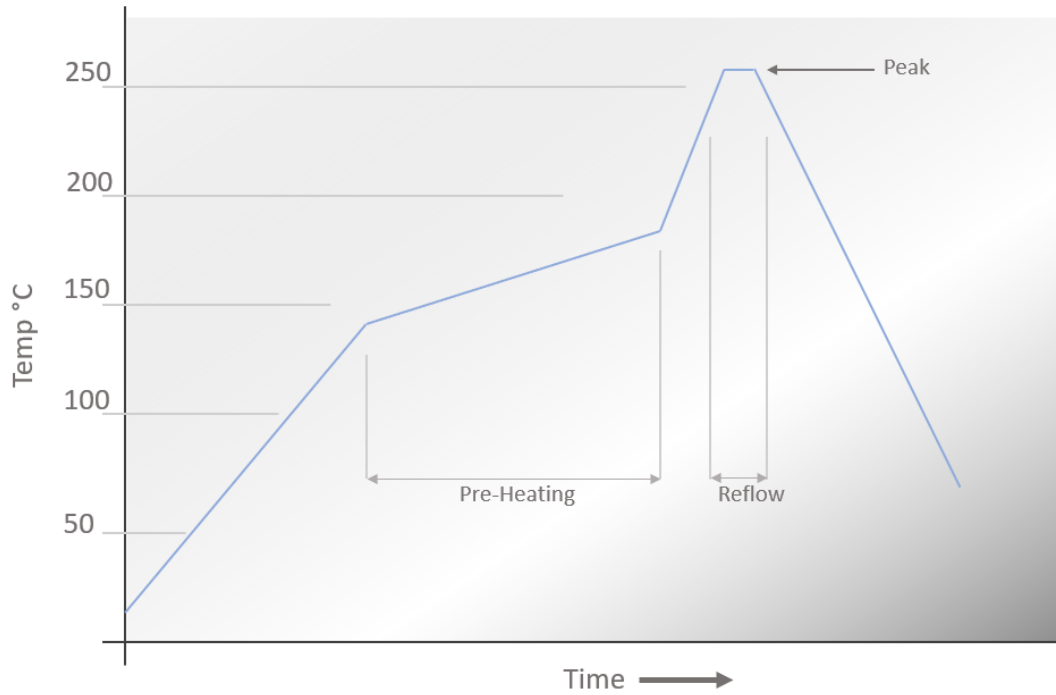

<b>Pre-Heating</b>	130 - 180°C	50 to 190 seconds
<b>Reflow</b>	>220 °C	50 to 160 seconds
<b>Peak Temperature</b>	260 °C	15 to 45 seconds

## Packaging

### Tape and Reel

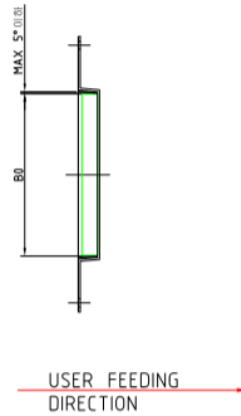
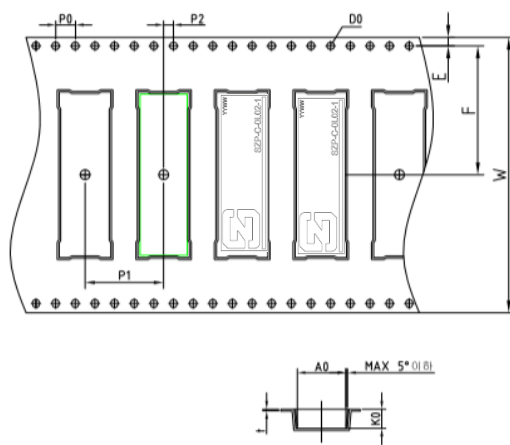

NAME	SPEC.
W	56.0±0.3
E	1.75±0.1
F	26.20±0.1
Do	1.55±0.05
P1	16.0±0.1
Po	4.0±0.1
P2	2.0±0.1
Ao	9.90±0.1
Bo	33.10±0.1
Ko	3.90±0.1
T	0.40±0.05

1. 10 sprocket hole pitch cumulative tolerance  $\pm 0.2$
2. Camber not to exceed 1mm in 100mm.
3. Ao and Bo measured on a plane 0.1mm above the bottom of the pocket
4. Ko measured from a plane on the inside bottom of the pocket to the top surface of the carrier.

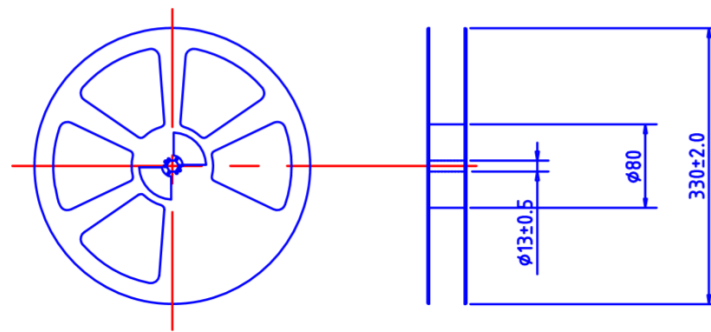

#### ANTI-STATIC

REEL DIMENSION	Type	Color	Size	Hub
		PS	Black	Ø330



## Environmental

### Material Regulation

The antenna has been tested to conform to RoHS requirements. A certificate of conformance is available upon request.

This product is Halogen free.



Synzen Precision Technology Ltd



Synzen Precision Technology Ltd makes no warranties based on the accuracy or completeness of the contents of this document and reserves the right to make changes to specifications and product descriptions at any time without notice. Synzen reserves all rights to this document and the information contained herein. Reproduction use or disclosure to third parties without express permission is strictly prohibited.