



TEST REPORT

Test Report No. : UL-RPT-RP13946797-616A V2.0

Customer : Buddi Limited
Model No. / HVIN : 3430013
PMN : Smart Tag 4
FCC ID : ZDLST6
ISED Certification No. : IC: 20371-ST6
Technology : LTE Cat M1 – Bands 4 & 12
Test Standard(s) : FCC Parts 2.1053, 27.53(g), 27.53(h)(1) & 15.209(a)
Innovation, Science and Economic Development Canada
RSS-139 Issue 3 Section 6.6
RSS-130 Issue 2 Section 4.7
RSS-Gen Issue 5 Section 6.13
Test Laboratory : UL International (UK) Ltd, Basingstoke, Hampshire, RG24 8AH,
United Kingdom

1. This test report shall not be reproduced except in full, without the written approval of UL International (UK) Ltd.
2. The results in this report apply only to the sample(s) tested.
3. The sample tested is in compliance with the above standard(s).
4. The test results in this report are traceable to the national or international standards.
5. Version 2.0 supersedes all previous versions.

Date of Issue: 01 December 2021

Checked by:

Sarah Williams
RF Operations Leader, Radio Laboratory

Company Signatory:

Ben Mercer
Lead Project Engineer, Radio Laboratory



5772

UL International (UK) LTD

Unit 1-3 Horizon, Kingsland Business Park, Wade Road, Basingstoke, Hampshire, RG24 8AH, UK
Telephone: +44 (0)1256 312000
Facsimile: +44 (0)1256 312001

Customer Information

Company Name:	Buddi Limited
Address:	Talbot House 17 Church Street Rickmansworth Hertfordshire WD3 1DE United Kingdom

Report Revision History

Version Number	Issue Date	Revision Details	Revised By
1.0	01/12/2021	Initial Version	Sarah Williams
2.0	01/12/2021	Hardware Version updated	Sarah Williams

Table of Contents

Customer Information.....	2
Report Revision History	2
Table of Contents.....	3
1 Attestation of Test Results.....	4
1.1 Description of EUT	4
1.2 General Information	4
1.3 Summary of Test Results	5
1.4 Deviations from the Test Specification	5
2 Summary of Testing.....	6
2.1 Facilities and Accreditation	6
2.2 Methods and Procedures	6
2.3 Calibration and Uncertainty	7
2.4 Test and Measurement Equipment	8
3 Equipment Under Test (EUT)	9
3.1 Identification of Equipment Under Test (EUT)	9
3.2 Modifications Incorporated in the EUT	9
3.3 Additional Information Related to Testing	10
3.4 Description of Available Antennas	10
3.5 Description of Test Setup	11
4 Radiated Test Results.....	14
4.1 Transmitter Out of Band Radiated Emissions – Band 4	14
4.2 Transmitter Out of Band Radiated Emissions – Band 12	18

1 Attestation of Test Results





1.1 Description of EUT

The equipment under test was an Electronic Monitoring (EM) device which communicates to a server-based monitoring platform providing data such as: event time, GPS location, geo-fence data, position type, speed of motion, battery level, signal strength, strap on/off, alerts. It contains a 2G and 4G cellular module (FCC ID: XPYUBX18ZO01, IC: 8595A-UBX18ZO01), a 2.4 GHz WLAN transceiver and a 915 MHz ISM transceiver.

1.2 General Information

Specification Reference:	47CFR27
Specification Title:	Code of Federal Regulations Volume 47 (Telecommunications): Part 27 Subpart C (Miscellaneous Wireless Communication Services)
Specification Reference:	47CFR15.209
Specification Title:	Code of Federal Regulations Volume 47 (Telecommunications): Part 15 Subpart C (Intentional Radiators) - Section 15.209
Specification Reference:	RSS-Gen Issue 5, February 2021
Specification Title:	General Requirements for Compliance of Radio Apparatus
Specification Reference:	RSS-139 Issue 3, July 2015
Specification Title:	Advanced Wireless Services Equipment Operating in the Bands 1710-1755 MHz and 2110-2180 MHz
Specification Reference:	RSS-130 Issue 2, February 2019
Specification Title:	Equipment Operating in the Frequency Bands 617-652 MHz, 663-698 MHz, 698-756 MHz and 777-787 MHz
Site Registration:	FCC: 685609, ISEDC: 20903
FCC Lab. Designation No.:	UK2011
ISEDC CABID:	UK0001
Location of Testing:	Unit 3 Horizon, Wade Road, Kingsland Business Park, Basingstoke, Hampshire, G24 8AH, United Kingdom
Test Dates:	09 November 2021 to 16 November 2021

1.3 Summary of Test Results

FCC Reference (47CFR)	ISED Canada Reference	Measurement	Result
LTE Band 4			
Part 15.209(a) / 2.1053 / 27.53(h)	RSS-Gen 6.13 / RSS-139 6.6	Transmitter Out of Band Radiated Emissions	
LTE Band 12			
Part 15.209(a) / 2.1053 / 27.53(g)	RSS-Gen 6.13 / RSS-130 4.7	Transmitter Out of Band Radiated Emissions	
Key to Results			
 = Complied  = Did not comply			

1.4 Deviations from the Test Specification

For the measurements contained within this test report, there were no deviations from, additions to, or exclusions from the test specification identified above.

2 Summary of Testing

2.1 Facilities and Accreditation

The test site and measurement facilities used to collect data are located at Unit 3 Horizon, Wade Road, Kingsland Business Park, Basingstoke, Hampshire, RG24 8AH, United Kingdom. The following table identifies which facilities were utilised for radiated emission measurements documented in this report. Specific facilities are also identified in the test results sections.

Site 1	X
Site 2	-
Site 17	-

UL International (UK) Ltd is accredited by the United Kingdom Accreditation Service (UKAS). UKAS is one of the signatories to the International Laboratory Accreditation Co-operation (ILAC) Arrangement for the mutual recognition of test reports. The tests reported herein have been performed in accordance with its terms of accreditation.

2.2 Methods and Procedures

Reference:	ANSI/TIA-603-E 2016
Title:	Land Mobile FM or PM Communications Equipment Measurement and Performance Standards
Reference:	ANSI C63.26-2015
Title:	American National Standard for Compliance Testing of Transmitters Used in Licensed Radio Services
Reference:	FCC KDB 971168 D01 v03r01, April 9, 2018
Title:	Measurement Guidance for Certification of Licensed Digital Transmitters
Reference:	Notice 2020 - DRS0023
Title:	Guidance on magnetic field strength radiated emission measurements (9 kHz - 30 MHz)

2.3 Calibration and Uncertainty

Measuring Instrument Calibration

In accordance with UKAS requirements all the measurement equipment is on a calibration schedule. All equipment was within the calibration period on the date of testing.

Measurement Uncertainty & Decision Rule

Overview

No measurement or test can ever be perfect and the imperfections give rise to error of measurement in the results. Consequently the result of a measurement is only an approximation to the value of the measurand (the specific quantity subject to measurement) and is only complete when accompanied by a statement of the uncertainty of the approximation.

The expression of uncertainty of a measurement result allows realistic comparison of results with reference values and limits given in specifications and standards.

Decision Rule

The decision rule applied is based upon the accuracy method criteria. The measurement uncertainty is met and the result is considered in conformance with the requirement criteria if the observed value is within the prescribed limit.

Measurement Uncertainty

The reported expanded uncertainties below are based on a standard uncertainty multiplied by an appropriate coverage factor such that a confidence level of approximately 95% is maintained. For the purposes of this document “approximately” is interpreted as meaning “effectively” or “for most practical purposes”.

Measurement Type	Range	Confidence Level (%)	Calculated Uncertainty
Radiated Spurious Emissions	9 kHz to 30 MHz	95%	±5.32 dB
Radiated Spurious Emissions	30 MHz to 1 GHz	95%	±3.30 dB
Radiated Spurious Emissions	1 GHz to 18 GHz	95%	±2.94 dB

The methods used to calculate the above uncertainties are in line with those recommended within the various measurement specifications. Where measurement specifications do not include guidelines for the evaluation of measurement uncertainty the published guidance of the appropriate accreditation body is followed.

2.4 Test and Measurement Equipment

Test Equipment Used for Transmitter Radiated Emissions Tests

Asset No.	Instrument	Manufacturer	Type No.	Serial No.	Date Calibration Due	Cal. Interval (Months)
M2040	Thermohygrometer	Testo	608-H1	45124934	10 Dec 2021	12
K0001	3m RSE Chamber	Rainford	N/A	N/A	06 Sep 2022	12
M2044	Test Receiver	Rohde & Schwarz	ESU26	100122	29 Apr 2022	12
A3154	Pre-Amplifier	Com-Power	PAM-103	18020012	24 Aug 2022	12
A3155	Pre-Amplifier	Com-Power	PAM-118A	18040037	24 Aug 2022	12
A3265	Pre-Amplifier	Schwarzbeck	BBV 9721	9721-069	03 Nov 2022	12
A3198	Magnetic Loop Antenna	ETS-Lindgren	6502	00221887	12 Aug 2022	12
A553	Antenna	Chase	CBL6111A	1593	15 Mar 2022	6
A3138	Antenna	Schwarzbeck	BBHA 9120 B	00702	27 Aug 2022	12
A3139	Antenna	Schwarzbeck	HWRD750	00027	27 Aug 2022	12
A2892	Antenna	Schwarzbeck	BBHA 9170	9170-727	02 Nov 2022	12
A2937	Attenuator	AtlanTecRF	AN18W5-06	208147#1	03 Feb 2022	12
A2523	Attenuator	AtlanTecRF	AN18W5-10	832827#1	03 Feb 2022	12
A3083	Low Pass Filter	AtlanTecRF	AFL-01000	18010900076	03 Feb 2022	12
A2908	High Pass Filter	Wainright	WHJE5-920-1000-4000-60EE	3	01 Feb 2022	12
A3093	High Pass Filter	AtlanTecRF	AFH-03000	18051800077	03 Feb 2022	12
A3091	High Pass Filter	AtlanTecRF	AFH-02000	18051600017	03 Feb 2022	12
A3095	High Pass Filter	AtlanTecRF	AFH-07000	18051600012	03 Feb 2022	12
G0615	Signal Generator	Rohde & Schwarz	SMBV100A	260473	19 Mar 2023	36
M2027	Power sensor	Boonton	55006	9912	19 Mar 2022	12
A3097	Antenna	Link Microtek Ltd.	AM1-18HA	15275	24 Aug 2024	36

3 Equipment Under Test (EUT)

3.1 Identification of Equipment Under Test (EUT)

Brand Name:	Buddi
Model Name or Number / HVIN:	3430013
PMN:	Smart Tag 4
Test Sample Serial Number:	STV00007 (<i>Radiated sample #1</i>)
Test Sample IMEI:	359159970397353
Hardware Version:	3430013
Firmware Version:	1.40.12
FCC ID:	ZDLST6
ISED Canada Certification Number:	IC: 20371-ST6

Brand Name:	Buddi
Model Name or Number / HVIN:	3430013
PMN:	Smart Tag 4
Test Sample Serial Number:	STV00008 (<i>Radiated sample #2</i>)
Test Sample IMEI:	359159970394335
Hardware Version:	3430013
Firmware Version:	1.40.12
FCC ID:	ZDLST6
ISED Canada Certification Number:	IC: 20371-ST6

3.2 Modifications Incorporated in the EUT

No modifications were applied to the EUT during testing.

3.3 Additional Information Related to Testing

Technology Tested:	LTE Cat M1- Band 4		
Type of Equipment:	Transceiver		
Channel Bandwidth:	1.4 MHz		
Modulation:	QPSK		
Power Supply Requirement(s):	3.7 VDC		
Transmit Frequency Range:	1710 MHz to 1755 MHz		
Transmit Channels Tested:	Channel ID	N_{ul}	Frequency of Uplink (MHz)
	Bottom	19957	1710.7
	Middle	20175	1732.5
	Top	20393	1754.3

Technology Tested:	LTE Cat M1- Band 12		
Type of Equipment:	Transceiver		
Channel Bandwidth:	1.4 MHz		
Modulation:	QPSK		
Power Supply Requirement(s):	3.7 VDC		
Transmit Frequency Range:	699 MHz to 716 MHz		
Transmit Channels Tested:	Channel ID	N_{ul}	Frequency of Uplink (MHz)
	Bottom	23017	699.7
	Middle	23095	707.5
	Top	23173	715.3

3.4 Description of Available Antennas

The radio utilizes an integrated antenna, with the following maximum gain:

Frequency Range (MHz)	Antenna Gain (dBi)
699 to 716	0.4
1710 to 1755	0.4

3.5 Description of Test Setup

Support Equipment

The following support equipment was used to exercise the EUT during testing:

Description:	Buddi
Brand Name:	On Body Charger (Battery pack)
Model Name or Number:	OBC V3/3610000
Serial Number:	OBX00012

Description:	Buddi
Brand Name:	On Body Charger (Battery pack)
Model Name or Number:	OBC
Serial Number:	OBZ03018

Description:	Buddi
Brand Name:	AC Dock (to charge the OBC)
Model Name or Number:	OBC V3 Dock/3620000
Serial Number:	Not marked or stated

Operating Modes

The EUT was tested in the following operating mode(s):

- Transmitting at maximum power on bottom, middle or top channel as required.

Configuration and Peripherals

The EUT was tested in the following configuration(s):

- The EUT was connected via a radiated link to an Anritsu LTE system simulator, operating in a transceiver mode. The Anritsu LTE simulator was used to configure the EUT operating mode.
- The EUT was placed in three orthogonal orientations X, Y and Z with and without the battery pack to determine the worst case orientation for radiated spurious emissions. This was determined to be the X position without the battery pack for LTE Band 4 and Y position with the battery pack for LTE band 12. All pre-scans and final measurements were performed in this orientation.

Test Setup Diagrams

Radiated Tests:

Test Setup for Transmitter Radiated Emissions

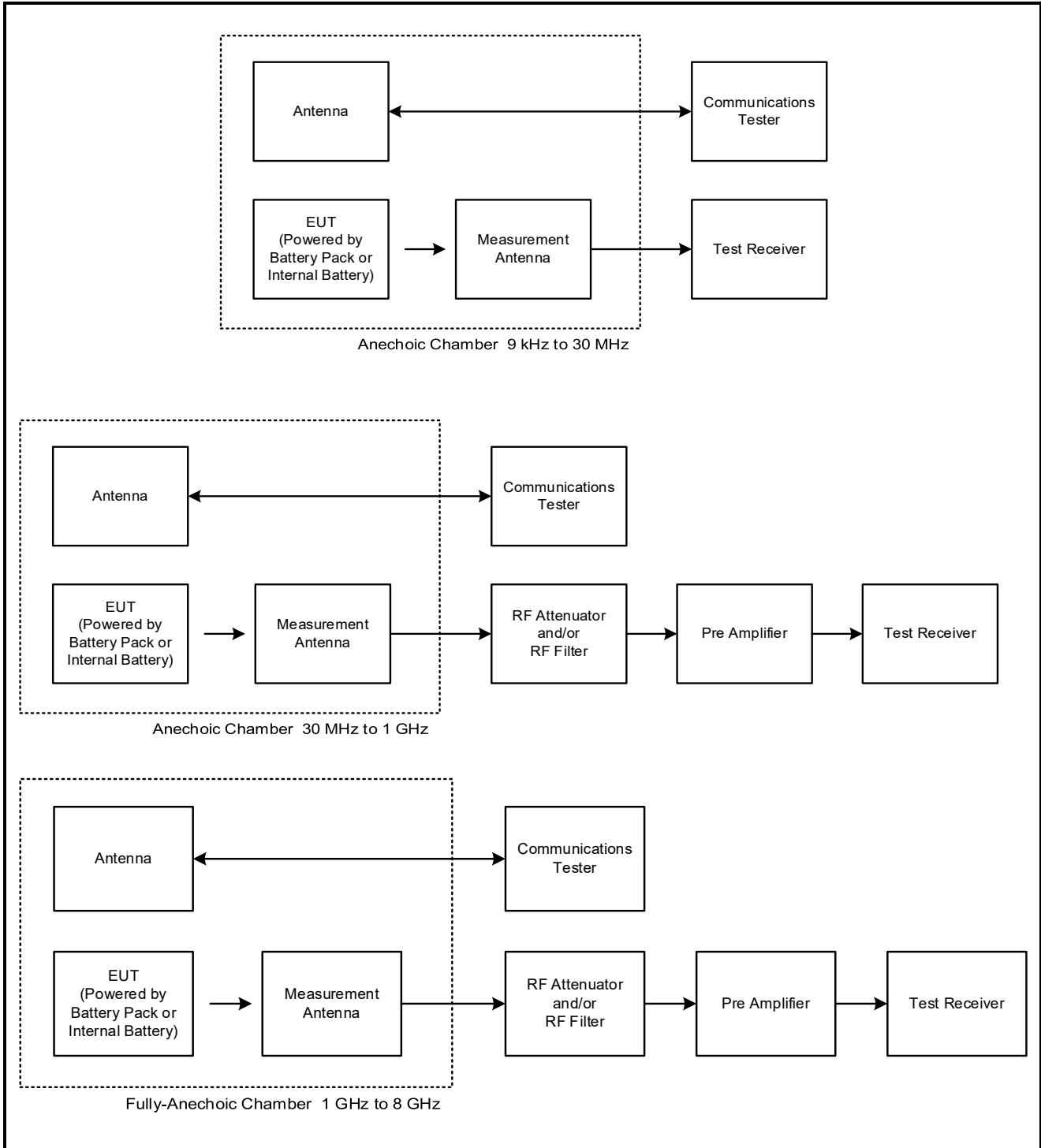

Test Setup Diagrams (continued)

Test Setup for Transmitter Radiated Emissions (continued)

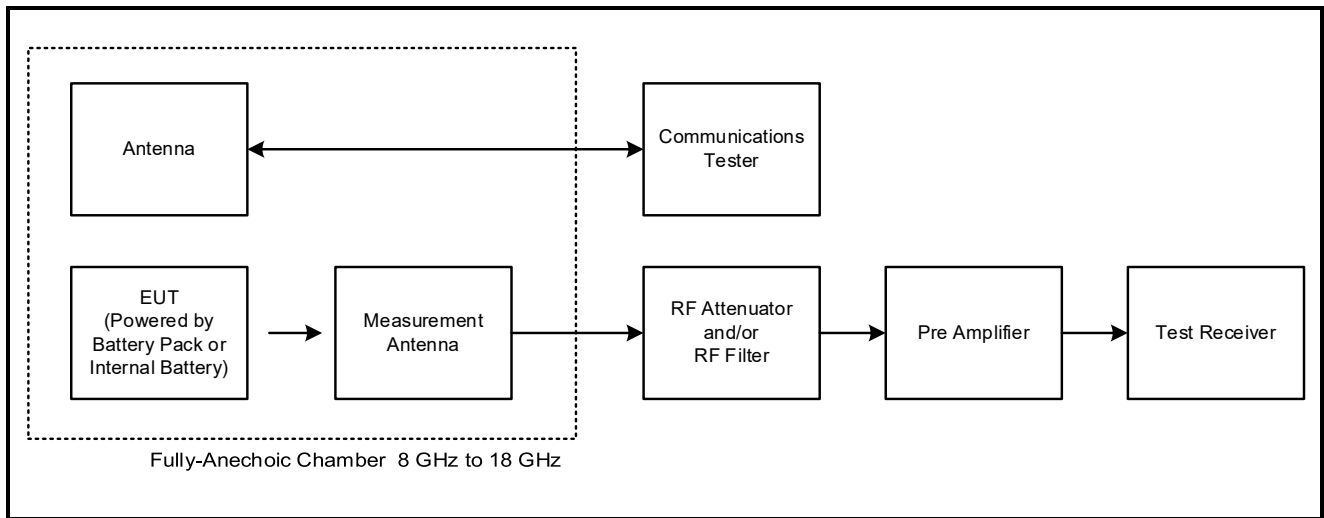

4 Radiated Test Results

4.1 Transmitter Out of Band Radiated Emissions – Band 4

Test Summary:

Test Engineers:	Marco Zunarelli & Nick Raptopoulos	Test Dates:	10 November 2021 to 16 November 2021
Test Sample IMEIs:	359159970397353 & 359159970394335		

FCC Reference:	Parts 2.1053, 15.209(a) & 27.53(h)(1)
ISED Canada Reference:	RSS-Gen 6.13 / RSS-139 6.6
Test Method Used:	KDB 971168 Section 6 referencing ANSI C63.26 Section 5.7
Frequency Range	9 kHz to 18 GHz

Environmental Conditions:

Temperature (°C):	21 to 23
Relative Humidity (%):	41 to 46

Transmitter Out of Band Radiated Emissions – Band 4 (continued)

Note(s):

1. The EUT was set to transmit with a 1.4 MHz channel bandwidth with QPSK modulation applied and 2 resource block with 0 offset, as this was found to be the worst case modulation scheme with regards to emissions after preliminary investigations and, as this mode emits the highest transmit output power level, it was deemed to be the worst case.
2. The emission seen on the 1 GHz to 3 GHz plot at approximately 1732.5 MHz is the EUT carrier.
3. All other emissions shown on the pre-scans were investigated and found to be ambient, or > 20 dB below the appropriate limit or below the noise floor of the measurement system.
4. FCC: Measurements below 30 MHz were performed in a semi-anechoic chamber (Asset Number K0001) at 3 metres. The EUT was placed at a height of 80 cm above the reference ground plane in the centre of the chamber turntable. The limit was extrapolated to 3 metres in accordance ANSI C63.10 clause 6.4.3; measurements may be performed at a closer distance and the measured level extrapolated to the specified measurement distance using the method described in clause 6.4.4.2.
5. ISEDC: Measurements below 30 MHz were performed in a semi-anechoic chamber (Asset Number K0001) at 3 metres. The EUT was placed at a height of 80 cm above the reference ground plane in the centre of the chamber turntable. The limit was extrapolated to 3 metres, as allowed by ANSI C63.10 clause 5.2; an alternative test site that can demonstrate equivalence to an open area test site may be used for measurements below 30 MHz. Therefore, measurements were performed in a semi-anechoic chamber. The correlation data between semi-anechoic chamber and an open field test site is available upon request.
6. Measurements from 30 MHz to 1 GHz were performed in a semi-anechoic chamber (Asset Number K0001) at a distance of 3 metres. The EUT was placed at a height of 80 cm above the reference ground plane in the centre of the chamber turntable. Maximum emission levels were determined by height searching the measurement antenna over the range 1 metre to 4 metres.
7. Pre-scans above 1 GHz were performed in a fully-anechoic chamber (Asset Number K0001) at a distance of 3 metres. The EUT was placed at a height of 1.5 metres above the test chamber floor in the centre of the chamber turntable. Maximum emission levels were determined by height searching the measurement antenna over the range 1 metre to 4 metres.
8. Final measurements above 1 GHz were performed in a semi-anechoic chamber (Asset Number K0001) at a distance of 3 metres. The EUT was placed at a height of 1.5 m above the reference ground plane in the centre of the chamber turntable. Maximum emission levels were determined by height searching the measurement antenna over the range 1 metre to 4 metres.

Results: Bottom Channel

Frequency (MHz)	Peak Level (dBm)	Limit (dBm)	Margin (dB)	Result
3420.668	-26.2	-13.0	13.2	Complied

Results: Middle Channel

Frequency (MHz)	Peak Level (dBm)	Limit (dBm)	Margin (dB)	Result
3464.316	-26.9	-13.0	13.9	Complied

Results: Top Channel

Frequency (MHz)	Peak Level (dBm)	Limit (dBm)	Margin (dB)	Result
3507.996	-31.2	-13.0	18.2	Complied

Transmitter Out of Band Radiated Emissions – Band 4 (continued)

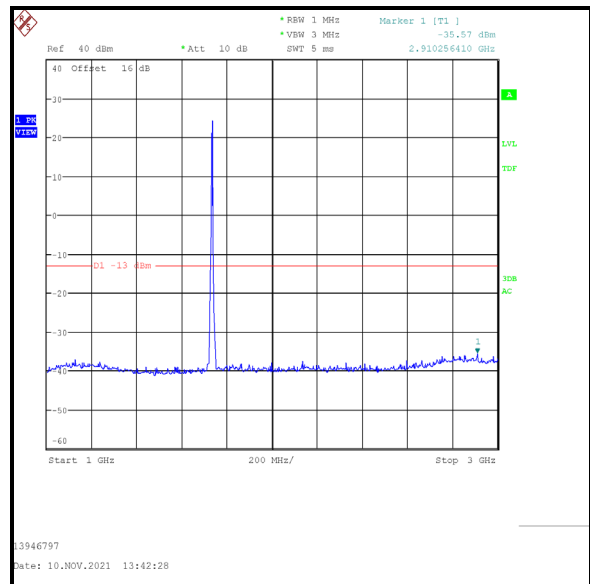
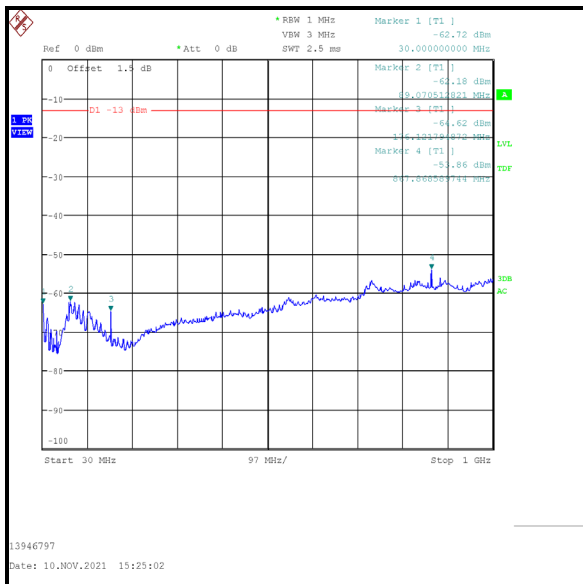
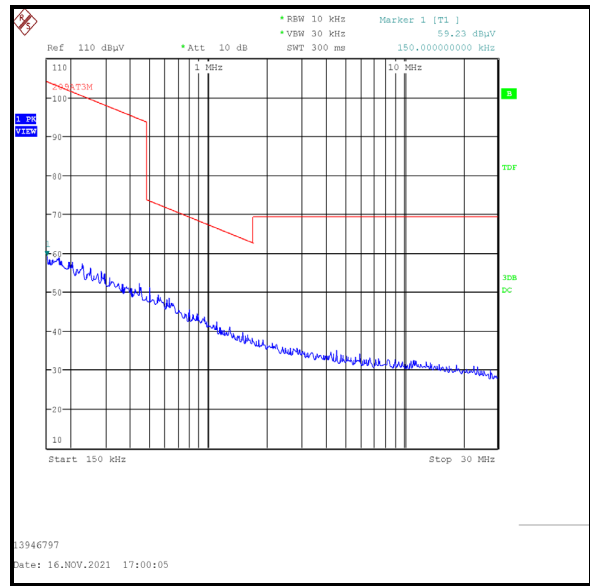
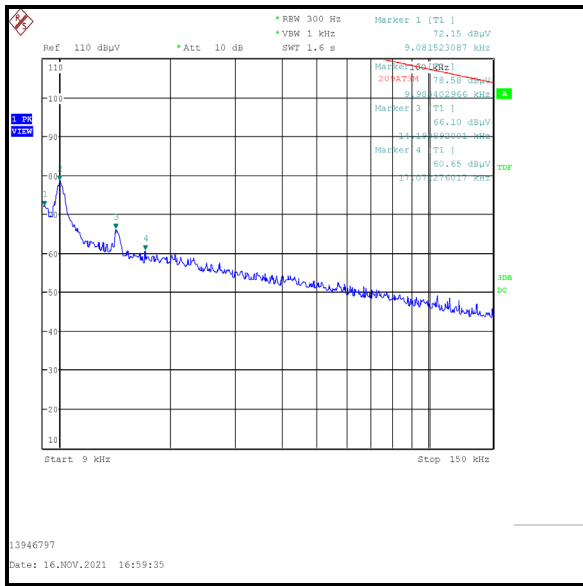

Note: This plot is a pre-scan and for indication purposes only. For final measurements, see accompanying table.

Transmitter Out of Band Radiated Emissions – Band 4 (continued)

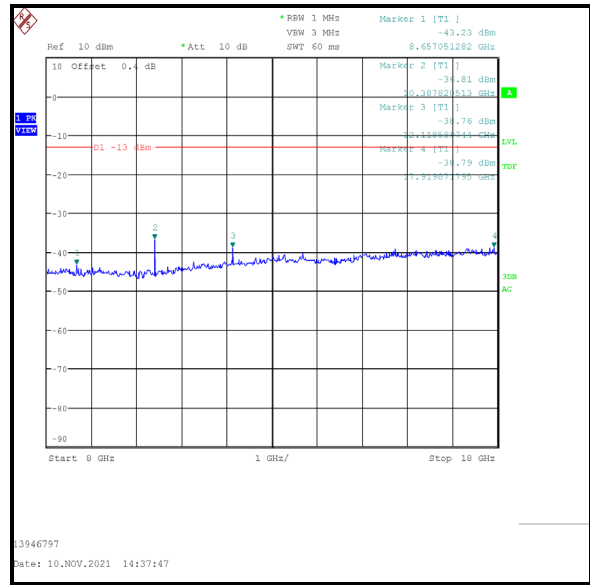
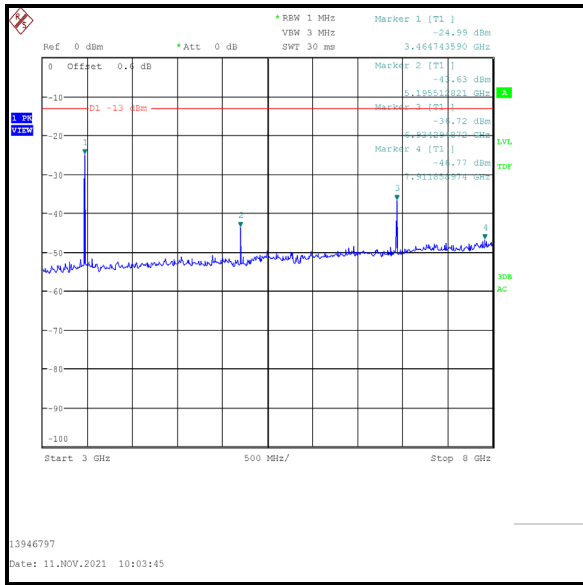

Note: This plot is a pre-scan and for indication purposes only. For final measurements, see accompanying table.

4.2 Transmitter Out of Band Radiated Emissions – Band 12

Test Summary:

Test Engineers:	Marco Zunarelli & Nick Raptopoulos	Test Dates:	09 November 2021 to 16 November 2021
Test Sample IMEIs:	359159970397353 & 359159970394335		

FCC Reference:	Parts 2.1053 & 27.53(g)
ISED Canada Reference:	RSS-Gen 6.13 / RSS-130 4.7
Test Method Used:	KDB 971168 Section 6 referencing ANSI C63.26 Section 5.7
Frequency Range	9 kHz to 8 GHz

Environmental Conditions:

Temperature (°C):	21 to 23
Relative Humidity (%):	41 to 46

Note(s):

- The EUT was set to transmit with a 1.4 MHz channel bandwidth with QPSK modulation applied and 2 resource block with 0 offset, as this was found to be the worst case modulation scheme with regards to emissions after preliminary investigations and, as this mode emits the highest transmit output power level, it was deemed to be the worst case.
- The emission seen on the 30 MHz to 1 GHz plot at approximately 707.5 MHz is the EUT carrier.
- All emissions shown on the pre-scans were investigated and found to be ambient, or > 20 dB below the appropriate limit or below the noise floor of the measurement system. Therefore the highest peak noise floor reading of the measuring receiver was recorded in the table below.
- FCC: Measurements below 30 MHz were performed in a semi-anechoic chamber (Asset Number K0001) at 3 metres. The EUT was placed at a height of 80 cm above the reference ground plane in the centre of the chamber turntable. The limit was extrapolated to 3 metres in accordance ANSI C63.10 clause 6.4.3; measurements may be performed at a closer distance and the measured level extrapolated to the specified measurement distance using the method described in clause 6.4.4.2.
- ISED: Measurements below 30 MHz were performed in a semi-anechoic chamber (Asset Number K0001) at 3 metres. The EUT was placed at a height of 80 cm above the reference ground plane in the centre of the chamber turntable. The limit was extrapolated to 3 metres, as allowed by ANSI C63.10 clause 5.2; an alternative test site that can demonstrate equivalence to an open area test site may be used for measurements below 30 MHz. Therefore, measurements were performed in a semi-anechoic chamber. The correlation data between semi-anechoic chamber and an open field test site is available upon request.
- Measurements from 30 MHz to 1 GHz were performed in a semi-anechoic chamber (Asset Number K0001) at a distance of 3 metres. The EUT was placed at a height of 80 cm above the reference ground plane in the centre of the chamber turntable. Maximum emission levels were determined by height searching the measurement antenna over the range 1 metre to 4 metres.
- Pre-scans above 1 GHz were performed in a fully-anechoic chamber (Asset Number K0001) at a distance of 3 metres. The EUT was placed at a height of 1.5 metres above the test chamber floor in the centre of the chamber turntable. Maximum emission levels were determined by height searching the measurement antenna over the range 1 metre to 4 metres.

Transmitter Out of Band Radiated Emissions – Band 12 (continued)

Results: Middle Channel

Frequency (MHz)	Peak Level (dBm)	Limit (dBm)	Margin (dB)	Result
7929.487	-46.2	-13.0	33.2	Complied

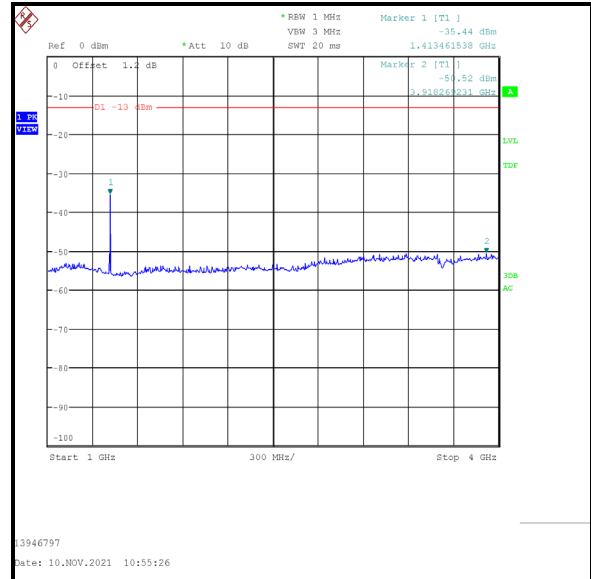
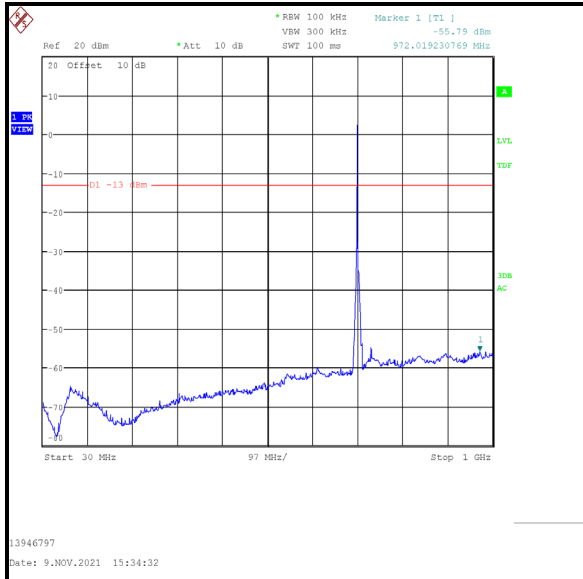
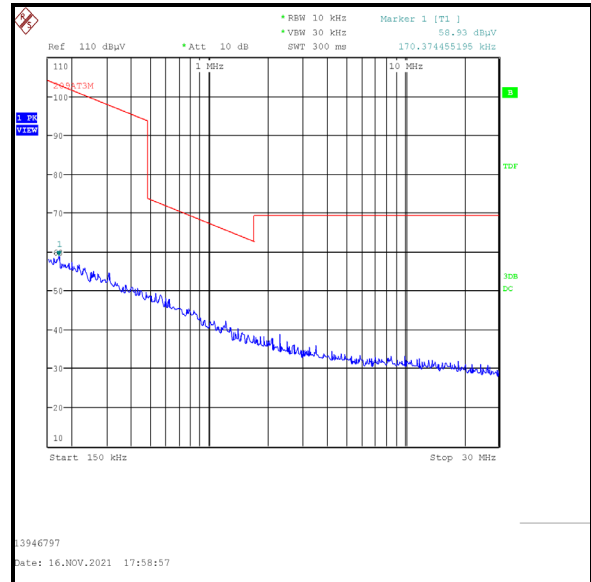
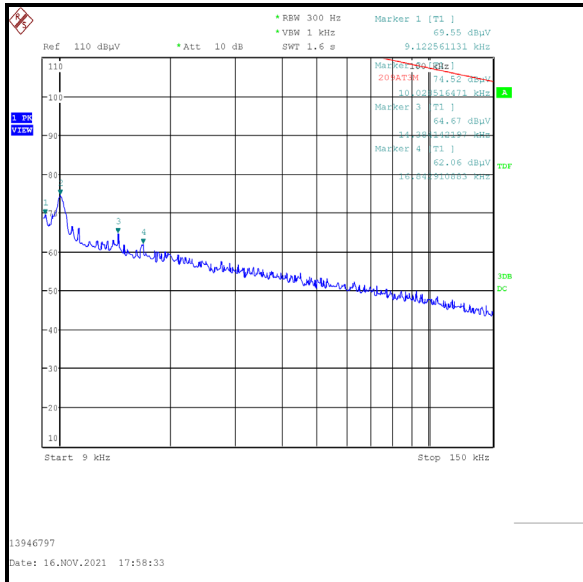

Transmitter Out of Band Radiated Emissions – Band 12 (continued)

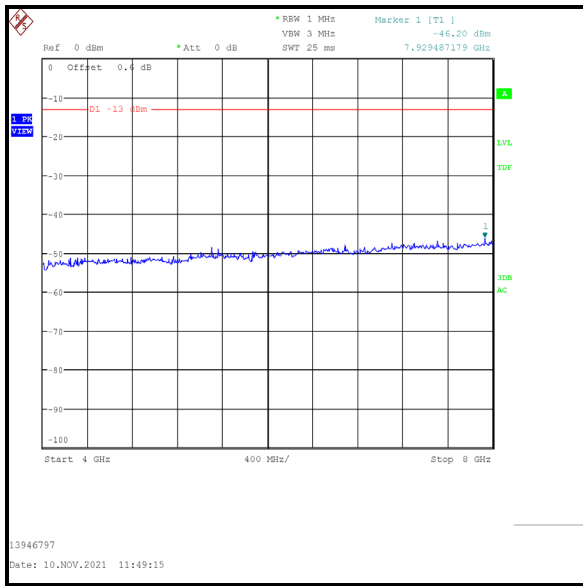

--- END OF REPORT ---