FCC Test Report

Report No.: AGC00M110101-3F2B

FCC ID : ZDIK2-544DW
PRODUCT DESIGNATION : 11N Wireless USB Dongle
BRAND NAME : KINGNET
TEST MODEL : K2-544DW
CLIENT : Shenzhen Kingnet Technology Co.,Ltd
DATE OF ISSUE : February 23, 2011
STANDARD(S) : FCC Part 15 Rules

Attestation of Global Compliance Co., Ltd.

CAUTION: This report shall not be reproduced except in full without the written permission of the test laboratory and shall not be quoted out of context.

VERIFICATION OF COMPLIANCE

Applicant	Shenzhen Kingnet Technology Co.,Ltd
	3F,Building 5,Civil Science Industry Zone,Pingshan,Xili,Nanshan,Shenzhen China
Manufacturer	Shenzhen Kingnet Electronic Co.,Ltd
	1-4F,Building 5Civil Science Industry Zone,Pingshan,Xili,Nanshan,Shenzhen China
Product Designation	11N Wireless USB Dongle
Brand Name	KINGNET
Model Name	K2-544D,K2-544DW,VNT9271BU05K
Model difference	The models all the same except for model name
FCC ID	ZDIK2-544DW
Report Number	AGC00M110101-3F2B
Date of Test	February 18-February 23, 2011

WE HEREBY CERTIFY THAT:

The above equipment was tested by Attestation of Global Compliance Co., Ltd. The test data, data evaluation, test procedures, and equipment configurations shown in this report were made in accordance with the procedures given in ANSI C63.4 (2003) and the energy emitted by the sample EUT tested as described in this report is in compliance with radiated emission limits of FCC Rules Part 15.247.

Checked By: _____

Forrest Lei Feb.23, 2011

Authorized By _____

King Zhang Feb.23, 2011

TABLE OF CONTENTS

1. GENERAL INFORMATION.....	4
1.1 PRODUCT DESCRIPTION.....	4
1.2 TABLE OF CARRIER FREQUENCYS.....	4
1.3 IEEE 802.11N MODULATION SCHEME.....	5
1.4 RELATED SUBMITTAL(S) / GRANT (S).....	5
1.5 TEST METHODOLOGY.....	5
1.6 TEST FACILITY.....	5
1.7 SPECIAL ACCESSORIES.....	5
1.8 EQUIPMENT MODIFICATIONS.....	5
1.9 TABLE FOR TEST MODES.....	6
2. SYSTEM TEST CONFIGURATION.....	7
2.1 CONFIGURATION OF TESTED SYSTEM.....	7
2.2 EQUIPMENT USED IN TESTED SYSTEM.....	7
3. SUMMARY OF TEST RESULTS.....	8
4. DESCRIPTION OF TEST MODES.....	8
5 MAXIMUM OUTPUT POWER.....	9
5.1 MEASUREMENT PROCEDURE.....	9
5.2 TEST SET-UP (BLOCK DIAGRAM OF CONFIGURATION).....	9
5.3 MEASUREMENT EQUIPMENT USED.....	9
5.4 LIMITS AND MEASUREMENT RESULT.....	10
6 6 DB BANDWIDTH.....	11
6.1 MEASUREMENT PROCEDURE.....	11
6.2 TEST SET-UP (BLOCK DIAGRAM OF CONFIGURATION).....	11
6.3 MEASUREMENT EQUIPMENT USED.....	11
6.4 LIMITS AND MEASUREMENT RESULTS.....	11
7. MAXIMUM CONDUCTED OUTPUT POWER SPECTRAL DENSITY.....	15
7.1 MEASUREMENT PROCEDURE.....	15
7.2 TEST SET-UP (BLOCK DIAGRAM OF CONFIGURATION).....	15
7.3 MEASUREMENT EQUIPMENT USED.....	15
7.4 LIMITS AND MEASUREMENT RESULT.....	15
8. RADIATED EMISSION MEASUREMENT.....	20
8.1 MEASUREMENT PROCEDURE.....	20
8.2 TEST SET-UP (BLOCK DIAGRAM OF CONFIGURATION).....	20
8.3 MEASUREMENT EQUIPMENT USED.....	21
8.4 LIMITS AND MEASUREMENT RESULT.....	22
9 BAND EDGE EMISSION.....	28
9.1 MEASUREMENT PROCEDURE.....	28
9.2 TEST SET-UP.....	28
9.3 TEST RESULT.....	28
10 FCC LINE CONDUCTED EMISSION TEST.....	33
10.1 LIMITS OF LINE CONDUCTED EMISSION TEST.....	33
10.2 BLOCK DIAGRAM OF LINE CONDUCTED EMISSION TEST.....	33
10.3 PRELIMINARY PROCEDURE OF LINE CONDUCTED EMISSION TEST.....	34

10.4 FINAL PROCEDURE OF LINE CONDUCTED EMISSION TEST	34
10.5 TEST RESULT OF LINE CONDUCTED EMISSION TEST	35
APPENDIX I	37
PHOTOGRAPHS OF THE EUT	37
APPENDIX II	39
PHOTOGRAPHS OF THE TEST SETUP	39

1. GENERAL INFORMATION

1.1 PRODUCT DESCRIPTION

The EUT is a **11N Wireless USB Dongle** designed as an “WiFi Device”. It is designed by way of utilizing the OFDM technology to achieve the system operation.

A major technical description of EUT is described as following

Operation Frequency	2.412 GHz to 2.462GHz
Rated Output Power	11n(20):12.85dBm ,11n(40):12.97dBm
Modulation	BPSK,QPSK,16-QAM,64-QAM
Data Rate	See Section 1.3
Number of channels	11
Antenna Designation	Integrated Antenna
Antenna Gain	0.9dBi(max)
Power Supply	DC5V

Note:The test report only included 802.11n test data.

1.2 TABLE OF CARRIER FREQUENCIES

Frequency Band	Channel Number	Frequency
2400~2483.5MHZ	1	2412MHZ
	2	2417MHZ
	3	2422 MHZ
	4	2427 MHZ
	5	2432 MHZ
	6	2437 MHZ
	7	2442 MHZ
	8	2447 MHZ
	9	2452 MHZ
	10	2457 MHZ
	11	2462MHZ

Note: For 20MHZ bandwidth system use Channel 1 to Channel 13
For 40MHZ bandwidth system use Channel 3 to Channel 9

1.3 IEEE 802.11N MODULATION SCHEME

MCS Index	Nss	Modulation	R	NBPS	NCBPS		NDBPS		Data rate(Mbps)	
					20MHz	40MHz	20MHz	40MHz	800nsGI	
									20MHz	40MHz
0	1	BPSK	1/2	1	52	108	26	54	6.5	13.5
1	1	QPSK	1/2	2	104	216	52	108	13.0	27.0
2	1	QPSK	3/4	2	104	216	78	162	19.5	40.5
3	1	16-QAM	1/2	4	208	432	104	216	26.0	54.0
4	1	16-QAM	3/4	4	208	432	156	324	39.0	81.0
5	1	64-QAM	2/3	6	312	648	208	432	52.0	108.0
6	1	64-QAM	3/4	6	312	648	234	486	58.5	121.5
7	1	64-QAM	5/6	6	312	648	260	540	65.0	135.0

Symbol	Explanation
NSS	Number of spatial streams
R	Code rate
NBPS	Number of coded bits per single carrier
NCBPS	Number of coded bits per symbol
NDBPS	Number of data bits per symbol
GI	guard interval

1.4 RELATED SUBMITTAL(S) / GRANT (S)

This submittal(s) (test report) is intended for **FCC ID:ZDIK2-544DW** filing to comply with Section 15.247 of the FCC Part 15, Subpart C Rules.

1.5 TEST METHODOLOGY

Both conducted and radiated testing were performed according to the procedures in ANSI C63.4 (2003). Radiated testing was performed at an antenna to EUT distance 3 meters.

1.6 TEST FACILITY

All measurement facilities used to collect the measurement data are located at Attestation of Global Compliance Co., Ltd. 1F., No.2 Building, Huafeng No.1 Technical Industrial Park, Sanwei, Xixiang, Baoan District, Shenzhen. The test site is constructed and calibrated to meet the FCC requirements in documents ANSI C63.4: 2003. FCC register No.: 259865

1.7 SPECIAL ACCESSORIES

Not available for this EUT intended for grant.

1.8 EQUIPMENT MODIFICATIONS

Not available for this EUT intended for grant.

1.9 TABLE FOR TEST MODES

Preliminary tests were performed in different data rate to find the worst radiated emission The data rate shown in the table below is the worst-case rate with respect to the specific test item. Investigation has been done on the entire possible configuration for searching the worst cases. The following table is a list of the test modes shown in this test report.

Test Items	Mode	Data Rate	Channel
Conducted Emissions	MCS0 (20MHZ)	Auto	-
Maximum Conducted Output Power Power Spectral Density 6dB Spectrum Bandwidth Radiated Emissions 1GHz~10 th Harmonic Band Edge Emissions	MCS0 (20MHZ)	6.5Mbps	1/7/11
	MCS0 (40MHZ)	13.5Mbps	3/7/9

2. SYSTEM TEST CONFIGURATION

2.1 CONFIGURATION OF TESTED SYSTEM

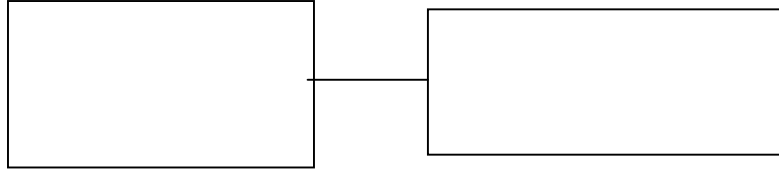

2.2 EQUIPMENT USED IN TESTED SYSTEM

Item	Equipment	Mfr/Brand	Model/Type No.	FCC ID
1	11N Wireless USB Dongle	Kingnet Electronic	K2-544DW	ZDIK2-544DW

3. SUMMARY OF TEST RESULTS

FCC RULES	DESCRIPTION OF TEST	RESULT
§15.207	Conduction Emission	Not applicable
§15.209	Radiated Emission	Compliant
§15.247	Maximum Output Power	Compliant
§15.247	6dB Bandwidth	Compliant
§15.247	Band Edges	Compliant
§15.247	Spurious Emission	Compliant
§15.247	Power Spectral Density	Compliant

4. DESCRIPTION OF TEST MODES

1. The EUT has been set to operate continuously on the lowest,middle and highest operation frequency individually.
2. The EUT stays in continuous transmitting mode on the operation frequency being set.

5 MAXIMUM OUTPUT POWER

5.1 MEASUREMENT PROCEDURE

1. The EUT was placed on a turn table which is 0.8m above ground plane.
2. Connect EUT RF output port to the Spectrum Analyzer through an RF attenuator
3. Set the EUT Work on the top, the middle and the bottom operation frequency individually.
4. Set SPA Centre Frequency = Operation Frequency, RBW= 1 MHz, VBW= 1 MHz.
5. Set SPA Trace 1 Max hold, then View.

5.2 TEST SET-UP (BLOCK DIAGRAM OF CONFIGURATION)

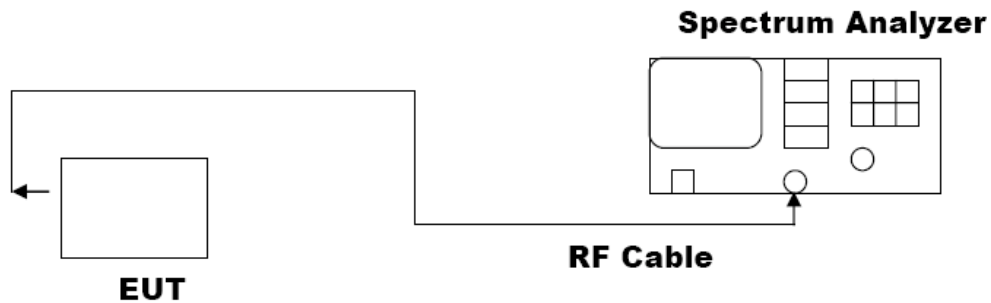

5.3 MEASUREMENT EQUIPMENT USED

Description	Manufacturer	Model	SERIAL NUMBER	Cal. Date	Cal. Due
Spectrum Analyzer	Agilent	E4440A	N/A	06/29/2010	06/28/2011
Amplifier	EM	EM30180	0607030	06/29/2010	06/28/2011
Horn Antenna	EM	EM-AH-1018 0	N/A	06/29/2010	06/28/2011
EMI Test Receiver	Rohde & Schwarz	ESCI	N/A	06/29/2010	06/28/2011
Amplifier	EM	EM30180	N/A	06/29/2010	06/28/2011
Biological Antenna	A.H. Systems Inc.	SAS-521-4	N/A	06/29/2010	06/28/2011
Loop Antenna	Daze	ZN30900N	SEL0097	06/29/2010	06/28/2011
Isolation Transformer	LETEAC	LTBK	--	06/08/2010	06/07/2011

5.4 LIMITS AND MEASUREMENT RESULT

802.11n(20)

LIMITS AND MEASUREMENT RESULT			
Frequency (GHz)	Result (dBm)	Applicable Limits (dBm)	Pass or Fail
2.412	12.85	30	Pass
2.442	12.62	30	Pass
2.462	12.40	30	Pass

802.11n(40)

LIMITS AND MEASUREMENT RESULT			
Frequency (GHz)	Result (dBm)	Applicable Limits (dBm)	Pass or Fail
2.422	12.97	30	Pass
2.442	12.67	30	Pass
2.452	12.76	30	Pass

6 6 DB BANDWIDTH

6.1 MEASUREMENT PROCEDURE

1. The EUT was placed on a turn table which is 0.8m above ground plane.
2. Connect EUT RF output port to the Spectrum Analyzer through an RF attenuator
3. Set the EUT Work on the top, the middle and the bottom operation frequency individually.
3. Set SPA Centre Frequency = Operation Frequency, RBW= 100 KHz, VBW= 100 KHz.
4. Set SPA Trace 1 Max hold, then View.

6.2 TEST SET-UP (BLOCK DIAGRAM OF CONFIGURATION)

The Same as described in Section 5.2

6.3 MEASUREMENT EQUIPMENT USED

The same as described in Section 5.3

6.4 LIMITS AND MEASUREMENT RESULTS

802.11n(20)

LIMITS AND MEASUREMENT RESULT			
Applicable Limits	Measurement Result		
	Test Data (MHz)		Criteria
>500KHZ	Low Channel	17.7	PASS
	Middle Channel	17.73	PASS
	High Channel	17.77	PASS

802.11n(40)

LIMITS AND MEASUREMENT RESULT			
Applicable Limits	Measurement Result		
	Test Data (MHz)		Criteria
>500KHZ	Low Channel	35.83	PASS
	Middle Channel	36.08	PASS
	High Channel	36.42	PASS

802.11n(20) TEST RESULT
TEST PLOT OF BANDWIDTH FOR LOW CHANNEL

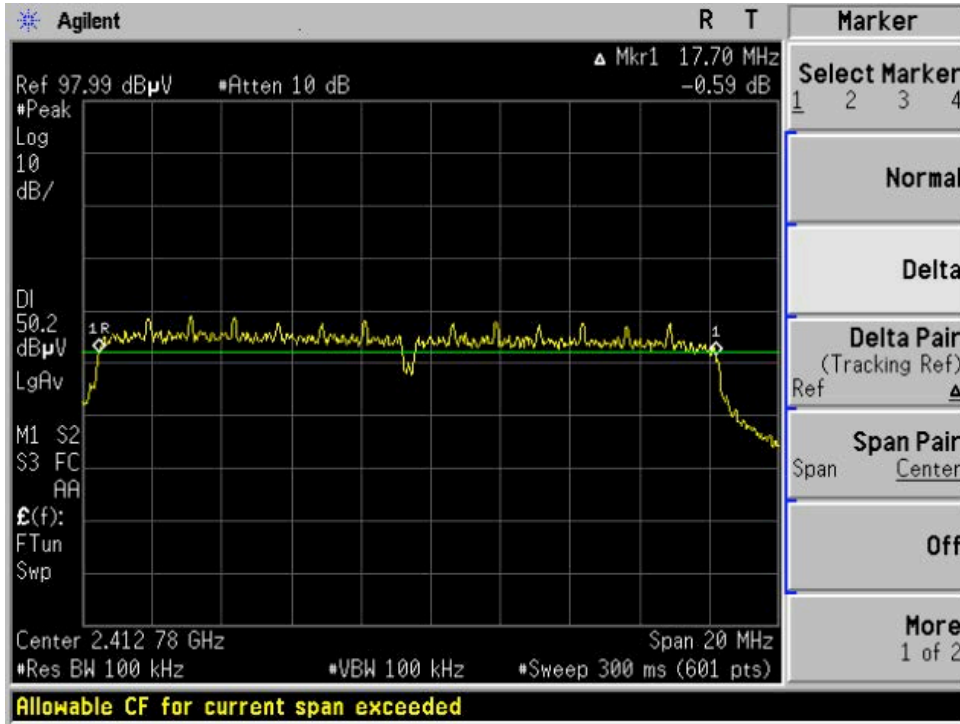

TEST PLOT OF BANDWIDTH FOR MIDDLE CHANNEL

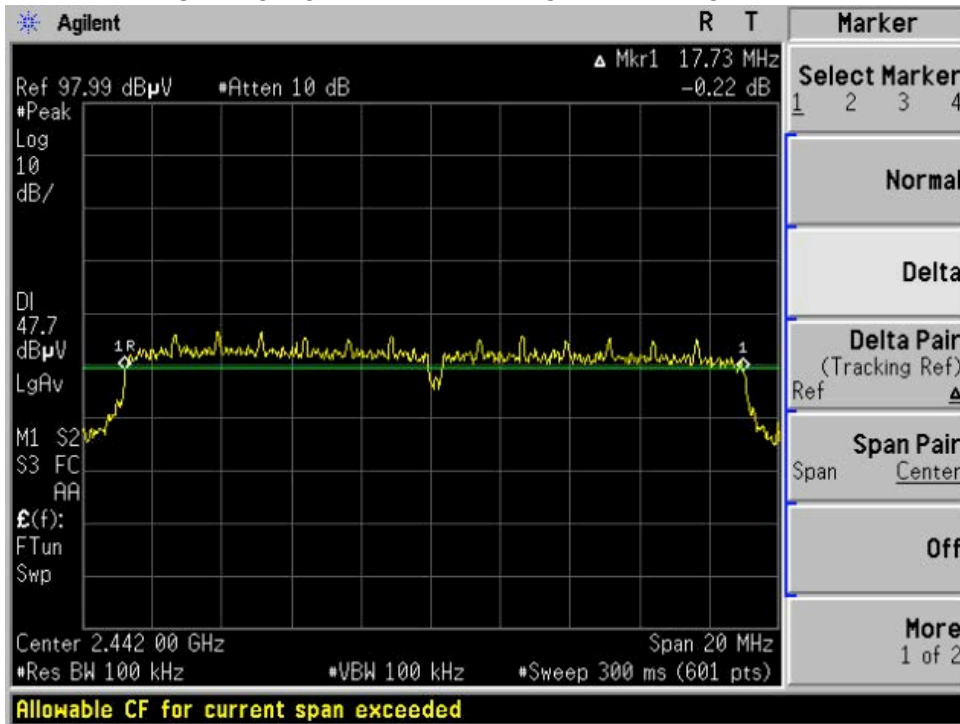

TEST PLOT OF BANDWIDTH FOR HIGH CHANNEL

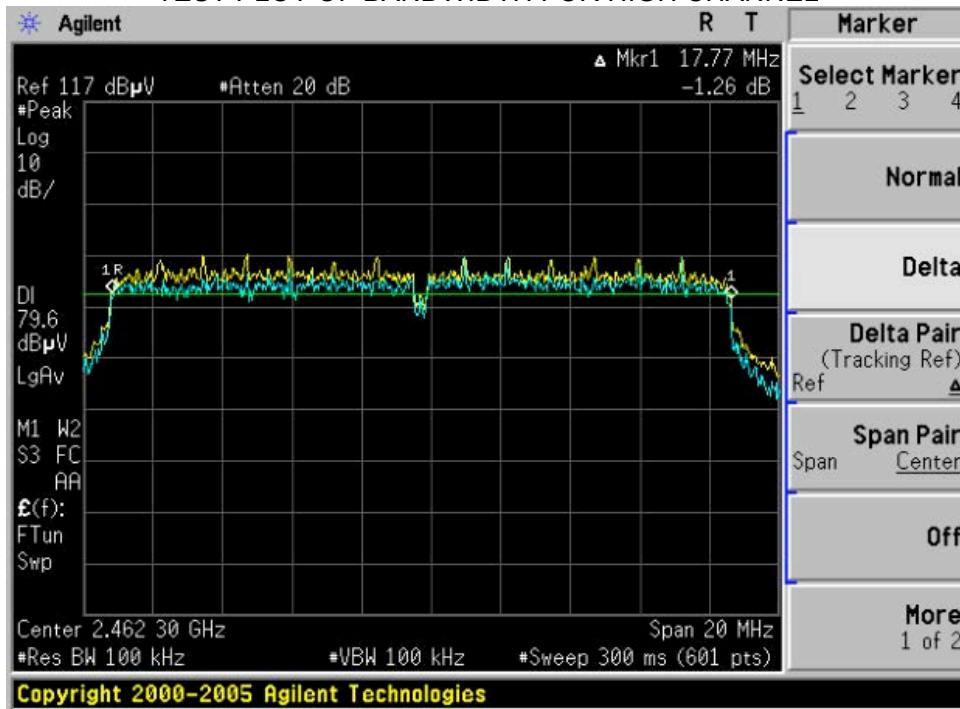

802.11n(40) TEST RESULT

TEST PLOT OF BANDWIDTH FOR LOW CHANNEL

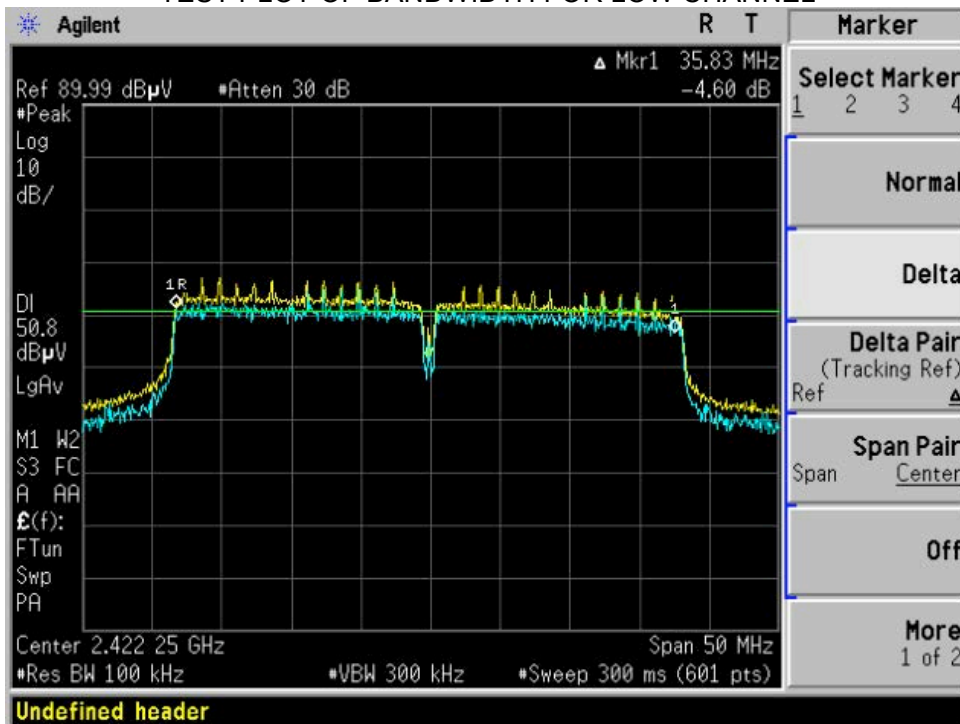

TEST PLOT OF BANDWIDTH FOR MIDDLE CHANNEL

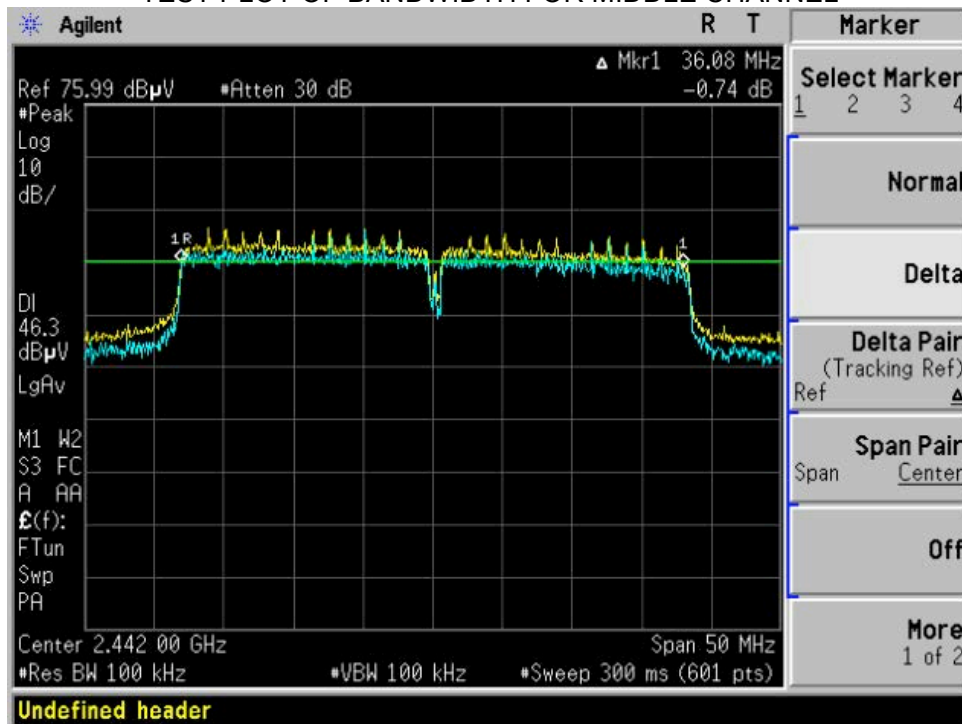

TEST PLOT OF BANDWIDTH FOR HIGH CHANNEL

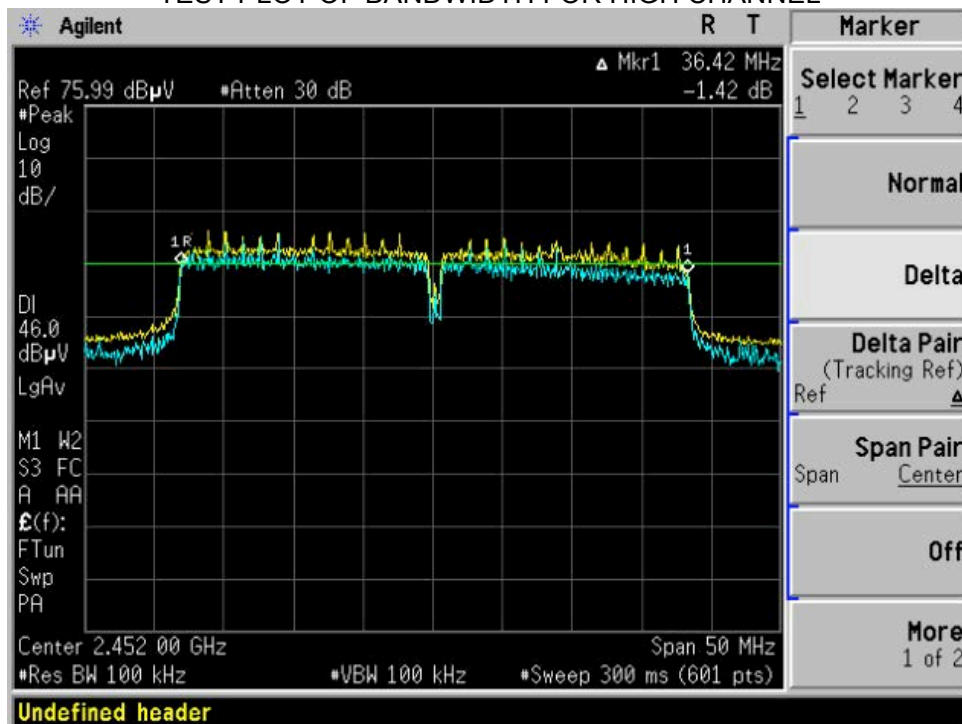

7. MAXIMUM CONDUCTED OUTPUT POWER SPECTRAL DENSITY

7.1 MEASUREMENT PROCEDURE

- (1). The EUT was placed on a turn table which is 0.8m above ground plane.
- (2). Connect EUT RF output port to the Spectrum Analyzer through an RF attenuator
- (3). Set the EUT Work on the top, the middle and the bottom operation frequency individually.
- (4). Set SPA Centre Frequency = Operation Frequency, RBW= 3 KHz, VBW= 30 KHz., Sweep time= Auto
- (5). Set SPA Trace 1 Max hold, then View.

7.2 TEST SET-UP (BLOCK DIAGRAM OF CONFIGURATION)

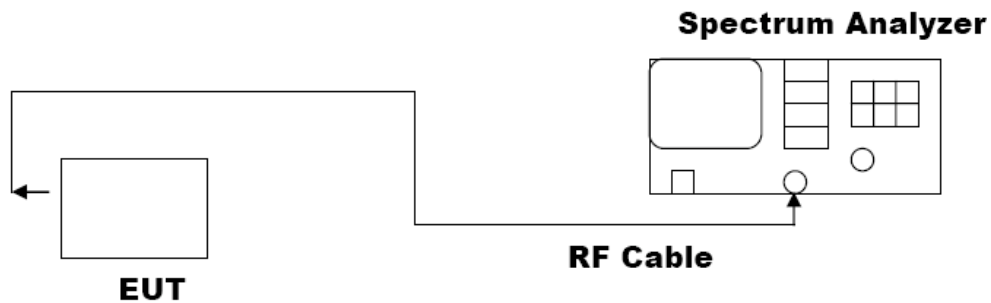

7.3 MEASUREMENT EQUIPMENT USED

SHIELDING ROOM					
EQUIPMENT TYPE	MFR	MODEL NUMBER	SERIAL NUMBER	LAST CAL.	CAL DUE.
Spectrum Analyzer	Agilent	E4440A	N/A	06/29/2010	06/28/2011

7.4 LIMITS AND MEASUREMENT RESULT

802.11n(20)

LIMITS AND MEASUREMENT RESULT			
Applicable Limits	Measurement Result		
	Test Data (dBm/3KHz)		Criteria
8 dBm / 3KHz	Low Channel	-20.34	Pass
	Middle Channel	-22.12	Pass
	High Channel	-17.62	Pass

802.11n(40)

LIMITS AND MEASUREMENT RESULT			
Applicable Limits	Measurement Result		
	Test Data (dBm/3KHz)		Criteria
8 dBm / 3KHz	Low Channel	-14.34	Pass
	Middle Channel	-15.01	Pass
	High Channel	-15.41	Pass

802.11n(20) TEST RESULT
TEST PLOT OF SPECTRAL DENSITY FOR LOW CHANNEL

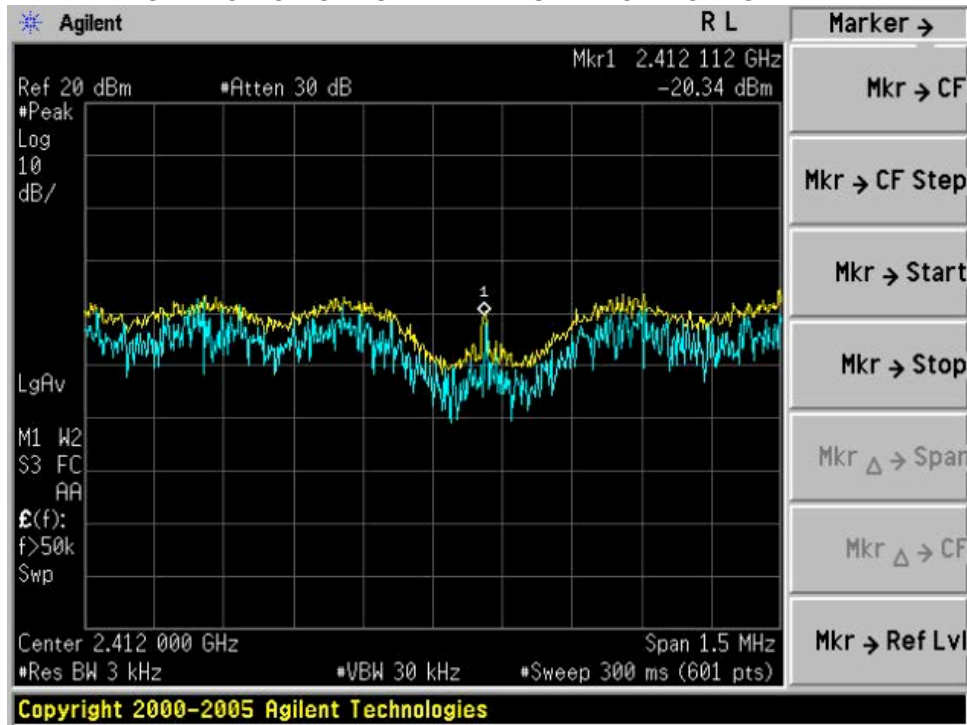

TEST PLOT OF SPECTRAL DENSITY FOR MIDDLE CHANNEL

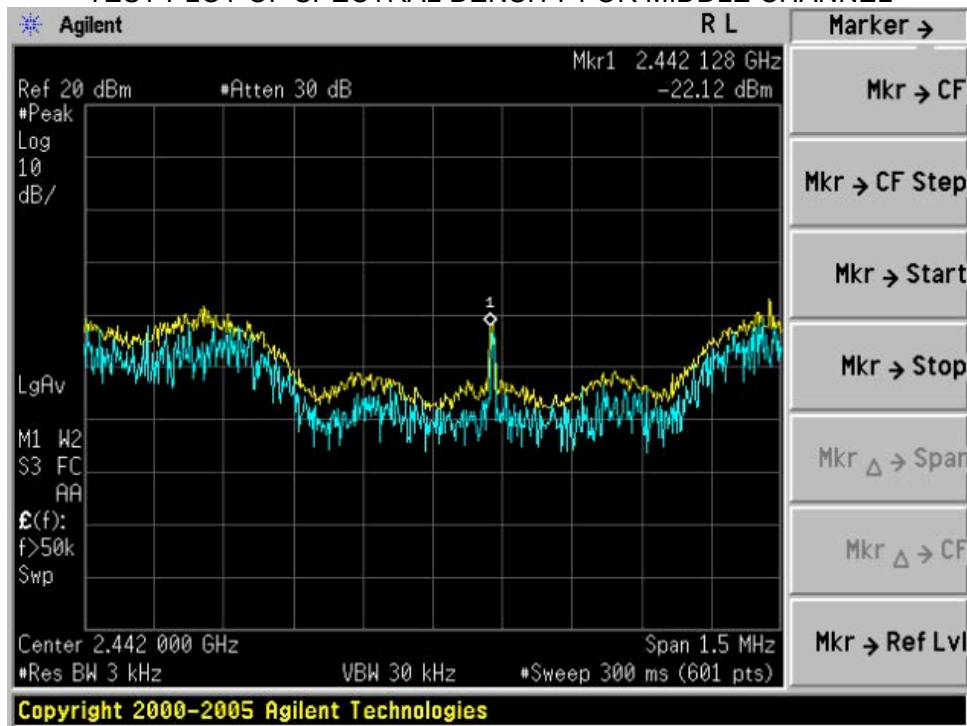

TEST PLOT OF SPECTRAL DENSITY FOR HIGH CHANNEL

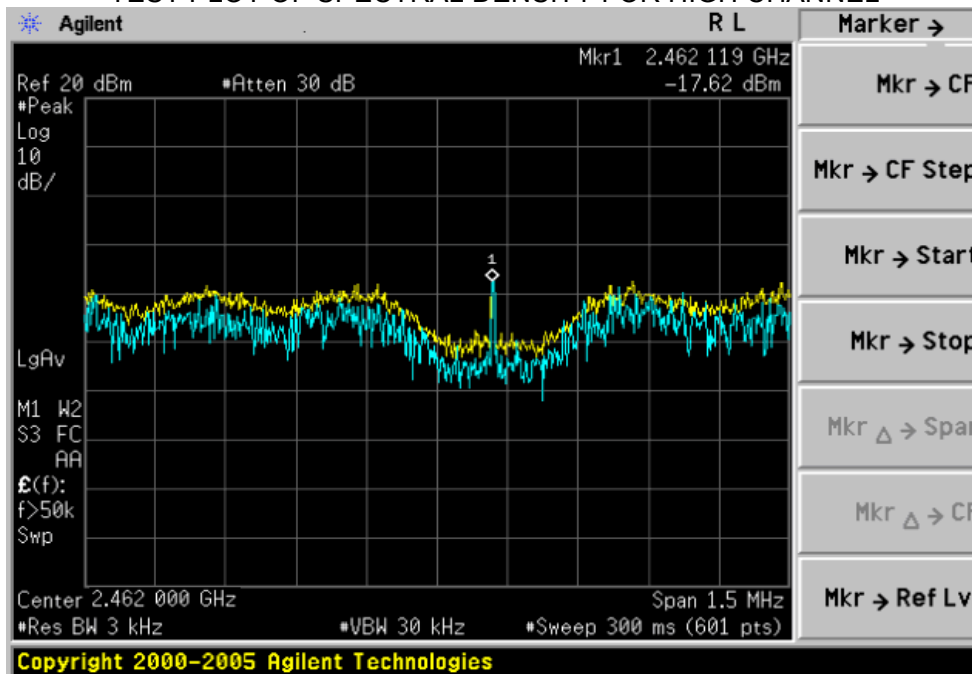

802.11n(40) TEST RESULT
TEST PLOT OF SPECTRAL DENSITY FOR LOW CHANNEL

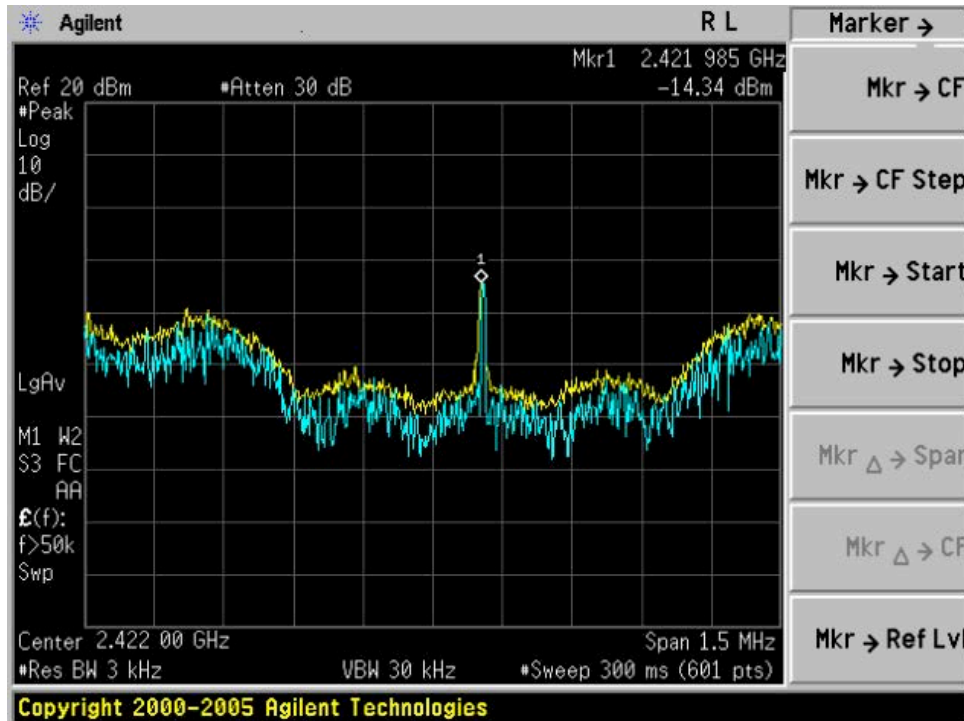

TEST PLOT OF SPECTRAL DENSITY FOR MIDDLE CHANNEL

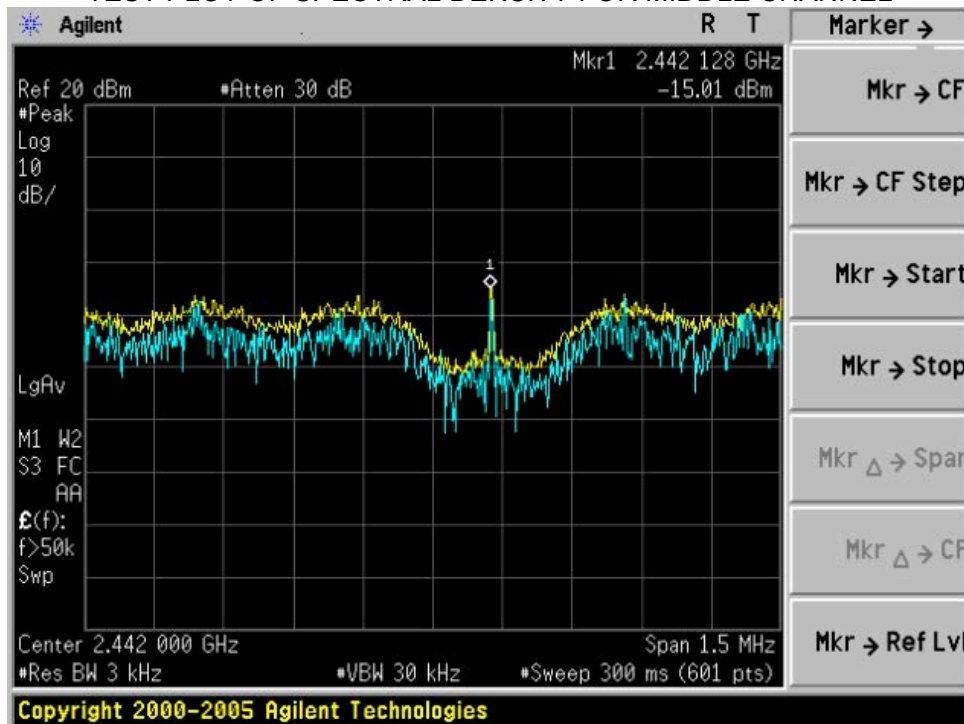

TEST PLOT OF SPECTRAL DENSITY FOR HIGH CHANNEL

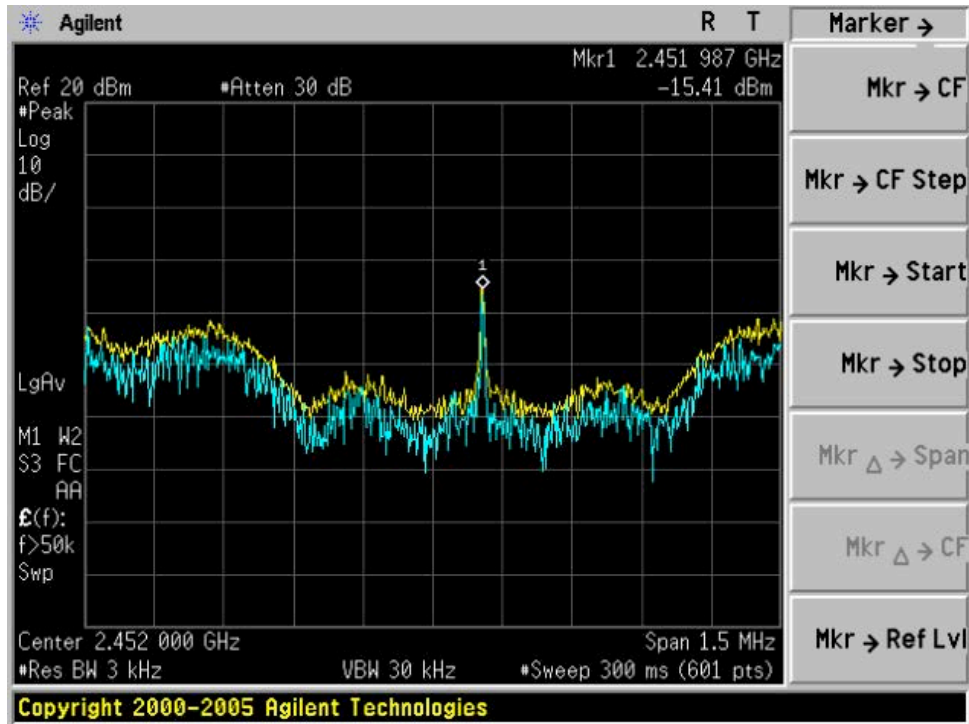

8. RADIATED EMISSION MEASUREMENT

8.1 MEASUREMENT PROCEDURE

- 1 Configure the EUT according to ANSI C63.4. The EUT was placed on the top of the turntable 0.8 Meter above ground. The phase center of the receiving antenna mounted on the top of a height-Variable antenna tower was placed 3 meters far away from the turntable.
- 2 Power on the EUT and all the supporting units. The turntable was rotated by 360 degrees to determine The position of the highest radiation.
- 3 The height of the broadband receiving antenna was varied between one meter and four meters above ground to find the maximum emissions field strength of both horizontal and vertical polarization.
- 4 For each suspected emissions, the antenna tower was scan (from 1M to 4M) and then the turntable was Rotated (from 0 degree to 360 degrees) to find the maximum reading.
- 5 Set the test-receiver system to Peak or CISPR quasi-peak Detect Function with specified bandwidth under Maximum Hold Mode
- 6 For emission above 1GHZ, use 1MHZ VBW and RBW for peak reading. Then 1MHZ RBW and 10Hz VBW For average reading in spectrum analyzer.
- 7 When the radiated emissions limits are expressed in terms of the average value of the emissions, and pulsed operation is employed, the measurement field strength shall be determined by averaging over one Complete pulse train, including blanking intervals, as long as the pulse train does not exceed 0.1 seconds. As an alternative (provided the transmitter operates for longer than 0.1 seconds) or in cases where the Pulse train exceeds 0.1 seconds, the measured field strength shall be determined from the average absolute voltage during a 0.1 seconds interval during which the field strength is at its maximum value.
- 8 If the emissions level of the EUT in peak mode was 3 dB lower than the average limit specified, then testing will be stopped and peak values of EUT will be reported, otherwise, the emissions which do not have 3dB margin will be repeated one by one using the quasi-peak method for below 1GHz.
- 9 For testing above 1GHZ, the emissions level of the EUT in peak mode was lower than average limit (that Means the emissions level in peak mode also complies with the limit in average mode) then testing will be Stopped and peak values of EUT will be reported, otherwise, the emissions will be measured in average Mode again and reported.
- 10 in case the emission is lower than 30MHz, loop antenna has to be used for measurement and the recorded Data should be QP measured by receiver. High-Low scan is not required in this case.

8.2 TEST SET-UP (BLOCK DIAGRAM OF CONFIGURATION)

RADIATED EMISSION TEST SETUP BELOW 30MHz

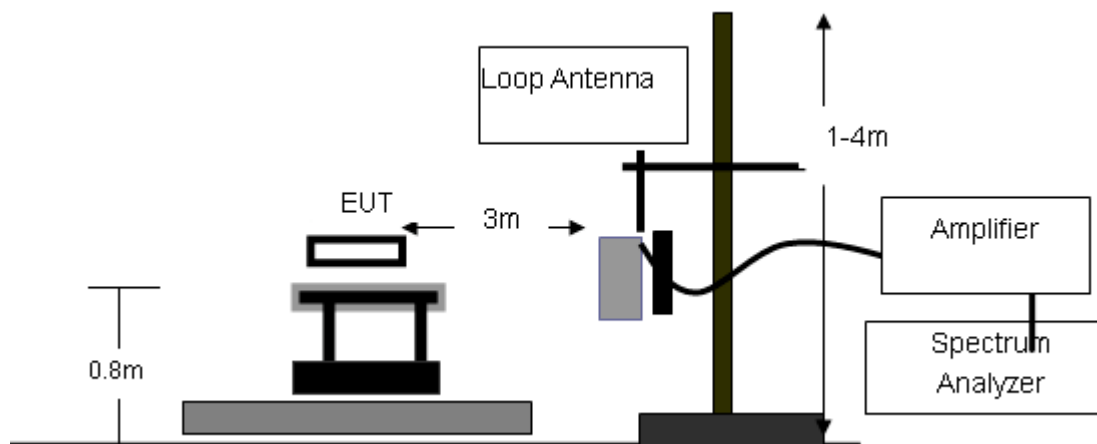

RADIATED MISSION TEST SETUP 30MHz-1000MHz

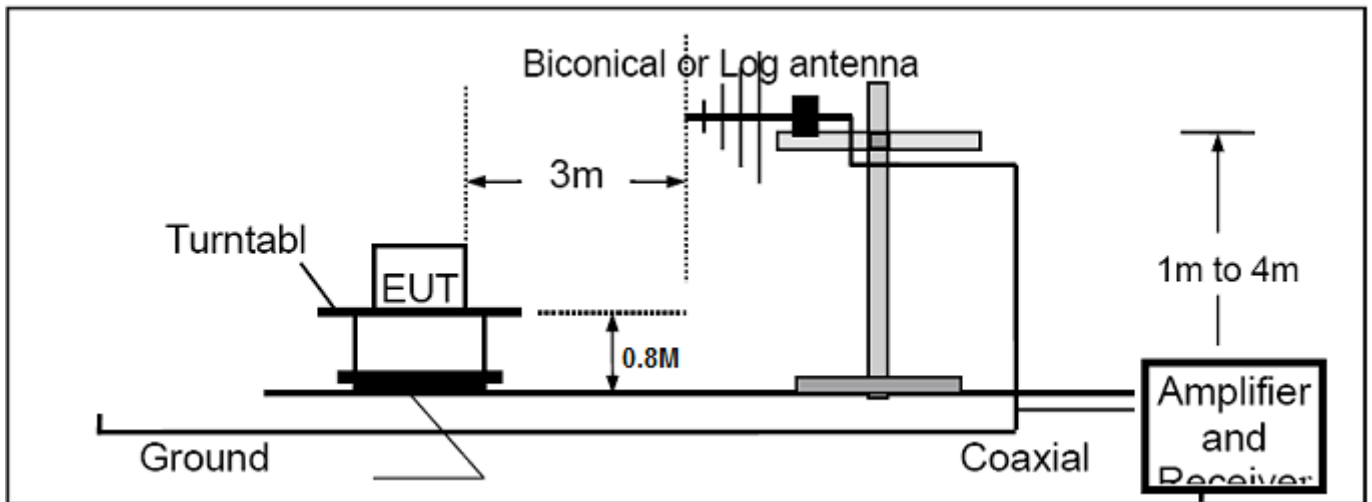

RADIATED MISSION TEST SETUP ABOVE 1000MHz

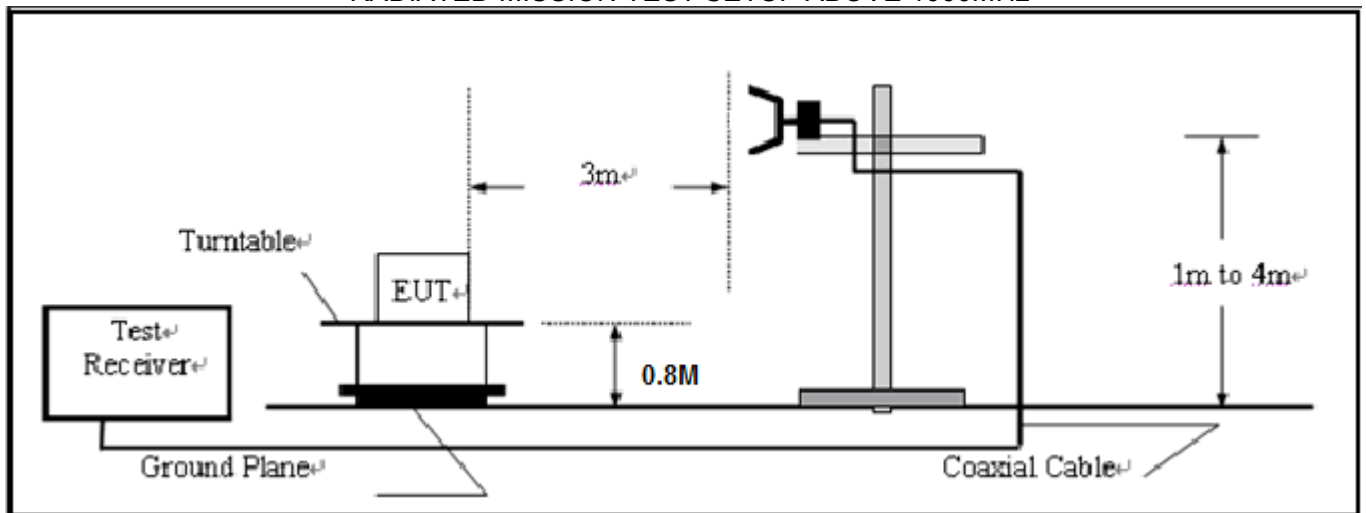

8.3 MEASUREMENT EQUIPMENT USED

The Same as described in section 6.3

8.4 LIMITS AND MEASUREMENT RESULT

LIMITS AND MEASUREMENT RESULT		
Applicable Limits	Measurement Result	
	Test Data	Criteria
<p>In any 100 KHz Bandwidth Outside the frequency band in which the spread spectrum intentional radiator is operating, the radio frequency power that is produce by the intentional radiator shall be at least 20 dB below that in 100KHz bandwidth within the band that contains the highest level of the desired power.</p> <p>In addition, radiation emissions which fall in the restricted bands, as defined in §15.205(a), must also comply with the radiated emission limits specified in§15.209(a))</p>	At least -20dBc than the limit Specified on the BOTTOM Channel	PASS
	At least -20dBc than the limit Specified on the TOP Channel	PASS

15.209(a) Limit in the below table has to be followed

Frequencies (MHz)	Field Strength (micorvolts/meter)	Measurement Distance (meters)
0.009~0.490	2400/F(KHz)	300
0.490~1.705	24000/F(KHz)	30
1.705~30.0	30	30
30~88	100	3
88~216	150	3
216~960	200	3
Above 960	500	3

RADIATED EMISSION BELOW 30MHZ

No emission found between lowest internal used/generated frequency to 30MHz.

RADIATED EMISSION BELOW 1GHZ

EUT	11N Wireless USB Dongle	Model Name	K2-544DW
Temperature	25° C	Relative Humidity	55.4%
Pressure	960hPa	Test Voltage	DC5V
Test Mode	2412MHZ	Modulation	802.11n(20)

Freq. (MHZ)	Ant.Pol. H/V	Detector (PK/QP)	Reading (dBuV)	Factor (dB)	Result (dBuV/m)	Limit (dBuV/m)	Margin (dB)
55.74	H	Peak	16.23	12.43	28.66	40	-11.34
135.68	H	Peak	13.54	13.22	26.76	43.5	-16.74
214.45	H	Peak	12.18	16.83	29.01	46	-16.99
467.68	H	Peak	8.87	16.24	25.11	46	-20.89
575.48	H	Peak	9.33	20.48	29.81	46	-16.19
923.25	H	Peak	5.89	24.27	30.16	46	-15.84
69.98	V	Peak	16.35	11.25	27.6	40	-12.4
88.56	V	Peak	12.65	9.46	22.11	40	-17.89
234.47	V	Peak	11.45	15.31	26.76	43.5	-16.74
278.39	V	Peak	8.13	17.65	25.78	43.5	-17.72
735.45	V	Peak	6.93	22.67	29.6	46	-16.4
928.38	V	Peak	8.45	23.39	31.84	46	-14.16

EUT	11N Wireless USB Dongle	Model Name	K2-544DW
	25° C	Relative Humidity	55.4%
Pressure	960hPa	Test Voltage	DC5V
Test Mode	2442MHZ	Modulation	802.11n(20)

Freq. (MHZ)	Ant.Pol. H/V	Detector (PK/QP)	Reading (dBuV)	Factor (dB)	Result (dBuV/m)	Limit (dBuV/m)	Margin (dB)
--	H	Peak	--	--	--	--	--
--	H	Peak	--	--	--	--	--
--	V	Peak	--	--	--	--	--
--	V	Peak	--	--	--	--	--

EUT	11N Wireless USB Dongle	Model Name	K2-544DW
Temperature	25° C	Relative Humidity	55.4%
Pressure	960hPa	Test Voltage	DC5V
Test Mode	2462MHZ	Modulation	802.11n(20)

Freq. (MHZ)	Ant.Pol. H/V	Detector (PK/QP)	Reading (dBuV)	Factor (dB)	Result (dBuV/m)	Limit (dBuV/m)	Margin (dB)
--	H	Peak	--	--	--	--	--
--	H	Peak	--	--	--	--	--
--	V	Peak	--	--	--	--	--
--	V	Peak	--	--	--	--	--

EUT	11N Wireless USB Dongle	Model Name	K2-544DW
Temperature	25° C	Relative Humidity	55.4%
Pressure	960hPa	Test Voltage	DC5V
Test Mode	2422/2442/2462MHZ	Modulation	802.11n(40)

Freq. (MHZ)	Ant.Pol. H/V	Detector (PK/QP)	Reading (dBuV)	Factor (dB)	Result (dBuV/m)	Limit (dBuV/m)	Margin (dB)
--	H	Peak	--	--	--	--	--
--	H	Peak	--	--	--	--	--
--	V	Peak	--	--	--	--	--
--	V	Peak	--	--	--	--	--

Note: "--" means the mode other frequencies at least have 20dB margin.

EUT	11N Wireless USB Dongle	Model Name	K2-544DW
Temperature	25° C	Relative Humidity	55.4%
Pressure	960hPa	Test Voltage	DC5V
Test Mode	2462MHZ	Modulation	802.11n(20)

Freq. (MHZ)	Ant.Pol. H/V	Peak Reading (dBuV)	AV Reading (dBuV)	Factor (dB)	Result		Peak Limit (dBuV/m)	AV Limit (dBuV/m)	Margin
					Peak (dBuV/m)	AV (dBuV/m)			
--	H	--	--	--	--	--	--	--	--
--	H	--	--	--	--	--	--	--	--
--	V	--	--	--	--	--	--	--	--
--	V	--	--	--	--	--	--	--	--

EUT	11N Wireless USB Dongle	Model Name	K2-544DW
Temperature	25° C	Relative Humidity	55.4%
Pressure	960hPa	Test Voltage	DC5V
Test Mode	2422/2442/2452MHZ	Modulation	802.11n(40)

Freq. (MHZ)	Ant.Pol. H/V	Peak Reading (dBuV)	AV Reading (dBuV)	Factor (dB)	Result		Peak Limit (dBuV/m)	AV Limit (dBuV/m)	Margin
					Peak (dBuV/m)	AV (dBuV/m)			
--	H	--	--	--	--	--	--	--	--
--	H	--	--	--	--	--	--	--	--
--	V	--	--	--	--	--	--	--	--
--	V	--	--	--	--	--	--	--	--

Note: This EUT was tested worst-case data was presented.
"--" means the mode at least have 20dB margin.

9 BAND EDGE EMISSION

9.1 MEASUREMENT PROCEDURE

1. Set the EUT Work on the top, the bottom operation frequency individually.
2. Set SPA Start or Stop Frequency = Operation Frequency, RBW= 1MHz, VBW= 1MHz.
3. The band edges was measured and recorded.

9.2 TEST SET-UP

The Same as described in section 6.2

9.3 TEST RESULT

802.11n(20) TEST PLOT OF BAND EDGE FOR LOW CHANNEL

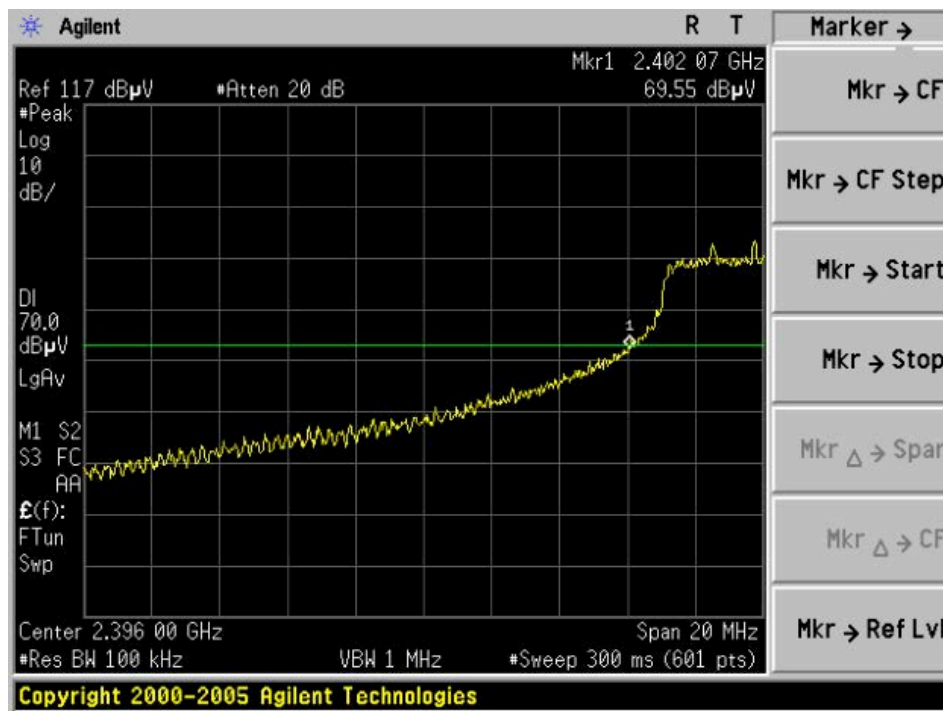

TEST PLOT OF BAND EDGE FOR HIGH CHANNEL

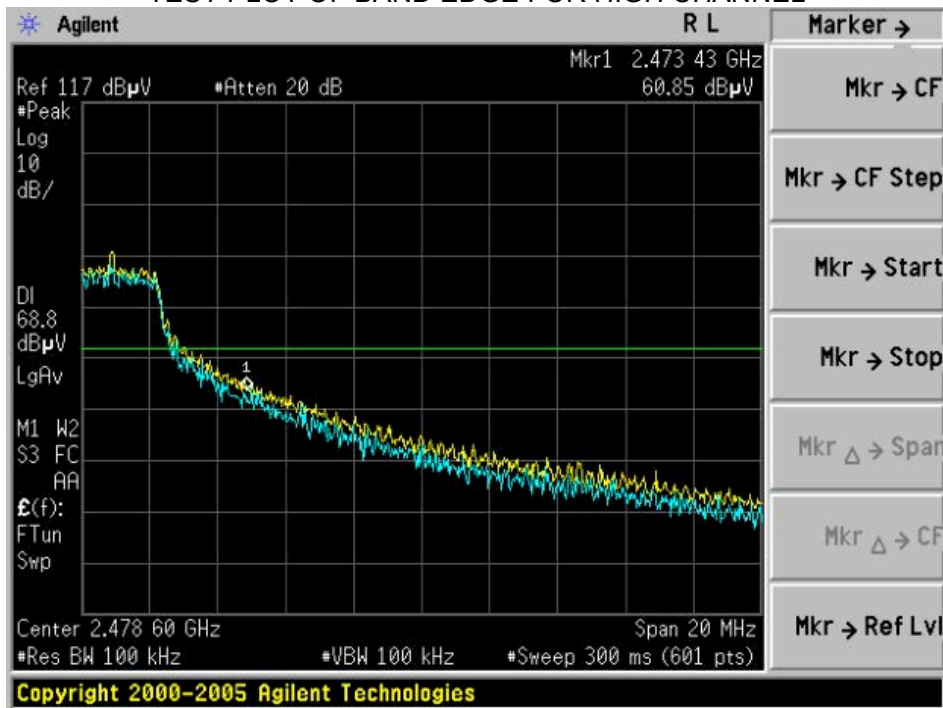

802.11n(40) TEST PLOT OF BAND EDGE FOR LOW CHANNEL

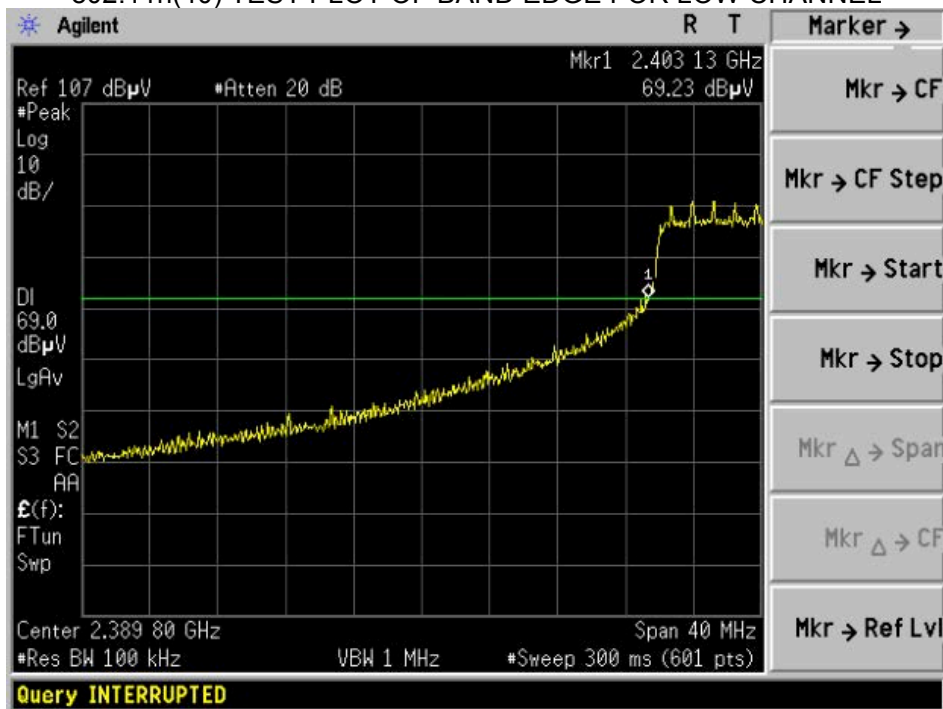

TEST PLOT OF BAND EDGE FOR HIGH CHANNEL

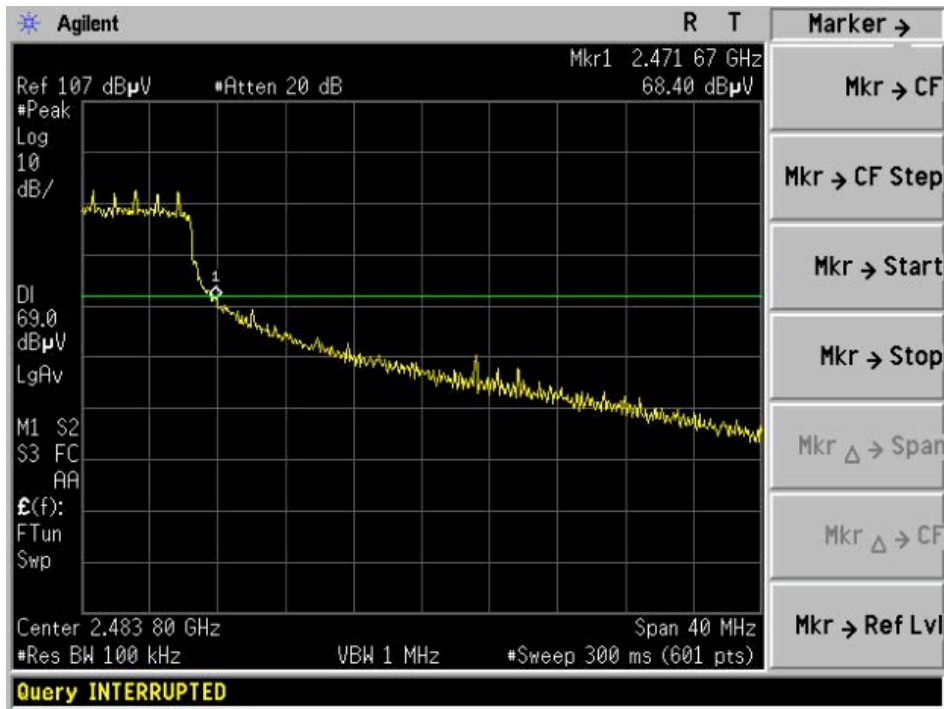

EUT	11 N Wireless USB Dongle	Model Name	K2-544DW
Temperature	25° C	Relative Humidity	55.4%
Pressure	960hPa	Test Voltage	DC5V
Test Mode	2412MHZ	Modulation	802.11n(20)

Freq. (MHZ)	Ant.Pol. H/V	Peak Reading (dBuV)	AV Reading (dBuV)	Factor (dB)	Result		Peak Limit (dBuV/m)	AV Limit (dBuV/m)	Margin
					Peak (dBuV/m)	AV (dBuV/m)			
2359.30	H	48.92	38.47	1.39	50.31	39.86	74	54	-14.14
--	H	--	--	--	--	--	--	--	--
2359.30	V	51.19	41.35	1.52	52.71	42.87	74	54	-11.33
--	V	--	--	--	--	--	--	--	--

EUT	11 N Wireless USB Dongle	Model Name	K2-544DW
Temperature	25° C	Relative Humidity	55.4%
Pressure	960hPa	Test Voltage	DC5V
Test Mode	2462MHZ	Modulation	802.11n(20)

Freq. (MHZ)	Ant.Pol. H/V	Peak Reading (dBuV)	AV Reading (dBuV)	Factor (dB)	Result		Peak Limit (dBuV/m)	AV Limit (dBuV/m)	Margin
					Peak (dBuV/m)	AV (dBuV/m)			
--	H	--	--	--	--	--	--	--	--
--	H	--	--	--	--	--	--	--	--
--	V	--	--	--	--	--	--	--	--
--	V	--	--	--	--	--	--	--	--

Note: "--" means other frequencies at least have 20dB margin.

EUT	11 N Wireless USB Dongle	Model Name	K2-544DW
Temperature	25° C	Relative Humidity	55.4%
Pressure	960hPa	Test Voltage	DC5V
Test Mode	2422MHZ	Modulation	802.11n(40)

Freq. (MHZ)	Ant.Pol. H/V	Peak Reading (dBuV)	AV Reading (dBuV)	Factor (dB)	Result		Peak Limit (dBuV/m)	AV Limit (dBuV/m)	Margin
					Peak (dBuV/m)	AV (dBuV/m)			
2388.16	H	48.32	35.02	1.27	49.59	36.29	74	54	-17.71
--	H	--	--	--	--	--	--	--	--
2389.84	V	47.29	34.17	1.65	48.94	35.82	74	54	-18.18
--	V	--	--	--	--	--	--	--	--

EUT	11 N Wireless USB Dongle	Model Name	K2-544DW
Temperature	25° C	Relative Humidity	55.4%
Pressure	960hPa	Test Voltage	DC5V
Test Mode	2452MHZ	Modulation	802.11n(40)

Freq. (MHZ)	Ant.Pol. H/V	Peak Reading (dBuV)	AV Reading (dBuV)	Factor (dB)	Result		Peak Limit (dBuV/m)	AV Limit (dBuV/m)	Margin
					Peak (dBuV/m)	AV (dBuV/m)			
--	H	--	--	--	--	--	--	--	--
--	H	--	--	--	--	--	--	--	--
--	V	--	--	--	--	--	--	--	--
--	V	--	--	--	--	--	--	--	--

Note: "--" means other frequencies at least have 20dB margin.

10 FCC LINE CONDUCTED EMISSION TEST

10.1 LIMITS OF LINE CONDUCTED EMISSION TEST

Frequency	Maximum RF Line Voltage	
	Q.P.(dBuV)	Average(dBuV)
150kHz~500kHz	66-56	56-46
500kHz~5MHz	56	46
5MHz~30MHz	60	50

**Note: 1. The lower limit shall apply at the transition frequency.
2. The limit decreases linearly with the logarithm of the frequency in the range 0.15 MHz to 0.50 MHz

10.2 BLOCK DIAGRAM OF LINE CONDUCTED EMISSION TEST

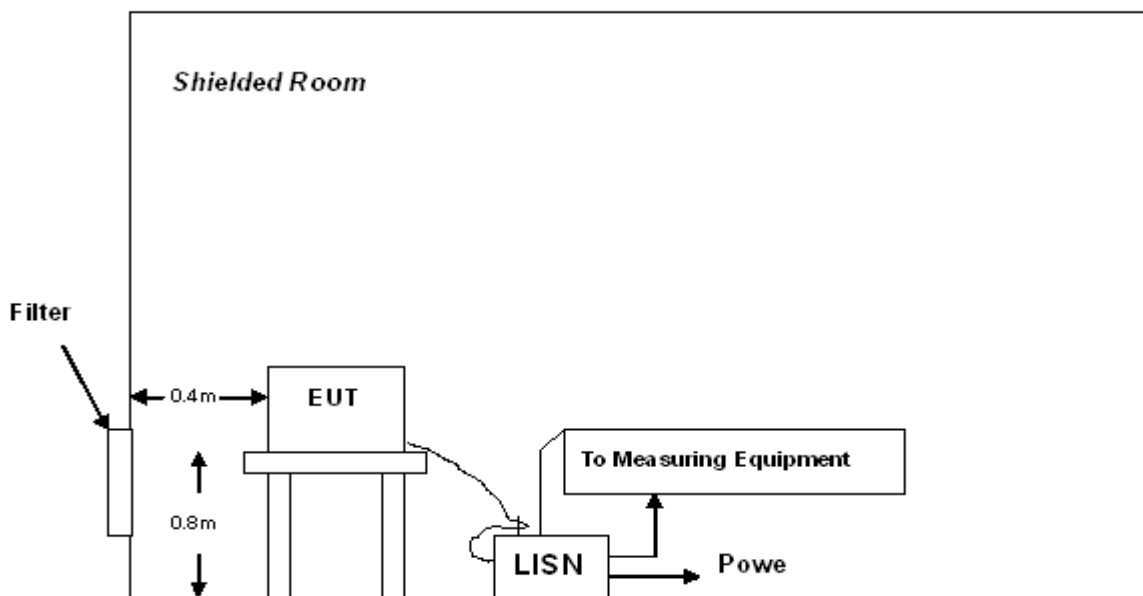

A: Powered through filter

10.3 PRELIMINARY PROCEDURE OF LINE CONDUCTED EMISSION TEST

- 1) The equipment was set up as per the test configuration to simulate typical actual usage per the user's manual. When the EUT is a tabletop system, a wooden table with a height of 0.8 meters is used and is placed on the ground plane as per ANSI C63.4 (see Test Facility for the dimensions of the ground plane used). When the EUT is a floor-standing equipment, it is placed on the ground plane which has a 3-12 mm non-conductive covering to insulate the EUT from the ground plane.
- 2) Support equipment, if needed, was placed as per ANSI C63.4.
- 3) All I/O cables were positioned to simulate typical actual usage as per ANSI C63.4.
- 4) All support equipments received AC120V power from a LISN, if any.
- 5) The EUT received power from support PC
- 6) The test program was started. Emissions were measured on each current carrying line of the EUT using a spectrum Analyzer / Receiver connected to the LISN powering the EUT. The LISN has two monitoring points: Line 1 (Hot Side) and Line 2 (Neutral Side). Two scans were taken: one with Line 1 connected to Analyzer / Receiver and Line 2 connected to a 50 ohm load; the second scan had Line 1 connected to a 50 ohm load and Line 2 connected to the Analyzer / Receiver.
- 7) Analyzer / Receiver scanned from 150 kHz to 30MHz for emissions in each of the test modes.
- 8) During the above scans, the emissions were maximized by cable manipulation.
- 9) The following test mode(s) were scanned during the preliminary test:

Preliminary Line Conducted Emission Test				
Frequency Range Investigated		150 KHz TO 30 MHz		
Mode of operation	Date	Report No.	Data#	Worst Mode
802.11b	02/21/2011	AGC00M110101-3	K2-544DW-0	<input checked="" type="checkbox"/>
802.11g	02/21/2011	AGC00M110101-3	K2-544DW-1	<input type="checkbox"/>
802.11n	02/21/2011	AGC00M110101-3	K2-544DW-2	<input type="checkbox"/>

Then, the EUT configuration and cable configuration of the above highest emission level were recorded for reference of final testing.

10.4 FINAL PROCEDURE OF LINE CONDUCTED EMISSION TEST

- 1) EUT and support equipment was set up on the test bench as per step 2 of the preliminary test.
- 2) A scan was taken on both power lines, Line 1 and Line 2, recording at least the six highest emissions. Emission frequency and amplitude were recorded into a computer in which correction factors were used to calculate the emission level and compare reading to the applicable limit. If EUT emission level was less -2dB to the A.V. limit in Peak mode, then the emission signal was re-checked using Q.P and Average detector.
- 3) The test data of the worst case condition(s) was reported on the Summary Data page.

10.5 TEST RESULT OF LINE CONDUCTED EMISSION TEST

TEST RESULT OF L LINE Conducted Emission Measurement

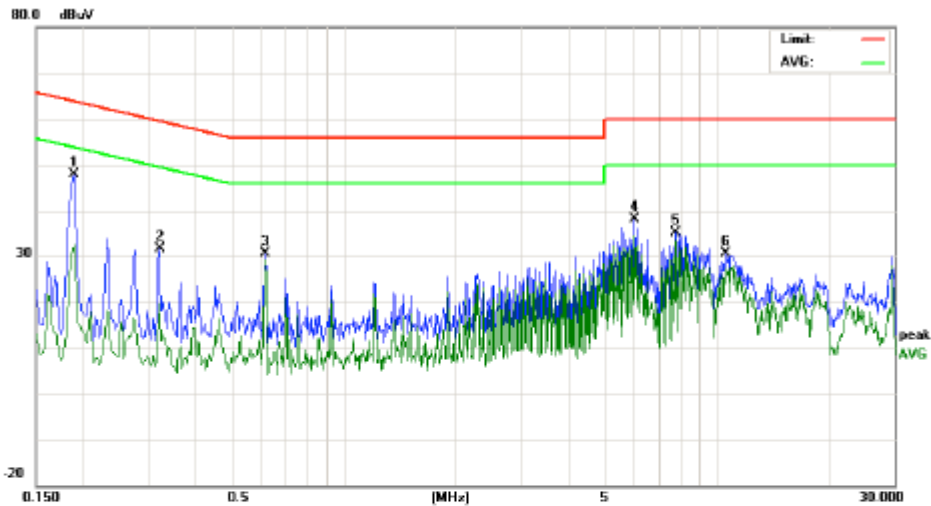

Site: Conduction Phase: **L7** Temperature: 26
 Limit: FCC Class B Conduction(QP) Power: Humidity: 60 %
 EUT: 11N Wireless USB Dongle
 MN: K2-544DW
 Mode:
 Note:

No.	Freq. (MHz)	Reading_Level (dBuV)			Correct Factor dB	Measurement (dBuV)			Limit (dBuV)		Margin (dB)		P/F	Comment
		Peak	QP	AVG		Peak	QP	AVG	QP	AVG	QP	AVG		
1	0.1900	37.63		22.39	10.20	47.83		32.59	64.03	54.03	-16.20	-21.44	P	
2	0.3220	21.30		9.33	10.30	31.60		19.63	59.65	49.65	-28.05	-30.02	P	
3	0.6180	20.38		19.07	10.32	30.70		29.39	56.00	46.00	-25.30	-16.61	P	
4	6.0180	27.84		24.36	10.28	38.12		34.64	60.00	50.00	-21.88	-15.36	P	
5	7.8020	24.88		23.07	10.34	35.22		33.41	60.00	50.00	-24.78	-16.59	P	
6	10.5780	20.62		17.28	10.10	30.72		27.38	60.00	50.00	-29.28	-22.62	P	

TEST RESULT OF N LINE
Conducted Emission Measurement

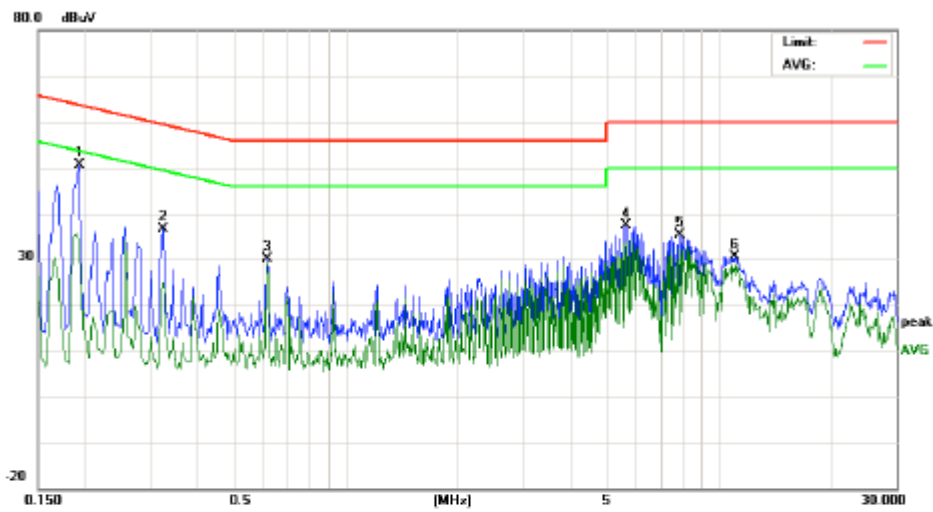

Site: Conduction Phase: *N* Temperature: 26
 Limit: FCC Class B Conduction(QP) Power: Humidity: 60 %
 EUT: 11N Wireless USB Dongle
 M/N: K2-544DW
 Mode:
 Note:

No.	Freq. (MHz)	Reading_Level (dBuV)			Correct Factor	Measurement (dBuV)			Limit (dBuV)		Margin (dB)		P/F	Comment
		Peak	QP	AVG		dB	Peak	QP	AVG	QP	AVG	QP		
1	0.1940	40.60		23.72	10.21	50.71		33.93	63.86	53.86	-13.15	-19.93	P	
2	0.3260	26.34		14.53	10.30	36.64		24.83	59.55	49.55	-22.91	-24.72	P	
3	0.6180	19.79		19.03	10.32	30.11		29.35	56.00	46.00	-25.89	-16.65	P	
4	5.6820	27.20		22.55	10.26	37.46		32.81	60.00	50.00	-22.54	-17.19	P	
5	7.8660	25.04		22.13	10.34	35.38		32.47	60.00	50.00	-24.62	-17.53	P	
6	11.0380	20.52		19.12	10.10	30.62		29.22	60.00	50.00	-29.38	-20.78	P	

APPENDIX I
PHOTOGRAPHS OF THE EUT

TOP VIEW OF EUT



BOTTOM VIEW OF EUT

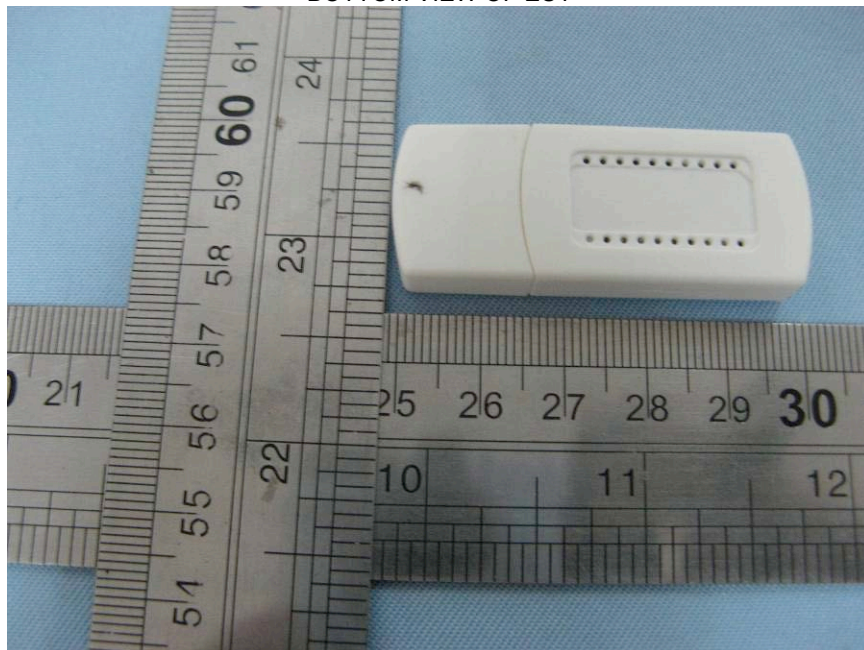

INTERNAL VIEW OF EUT-1

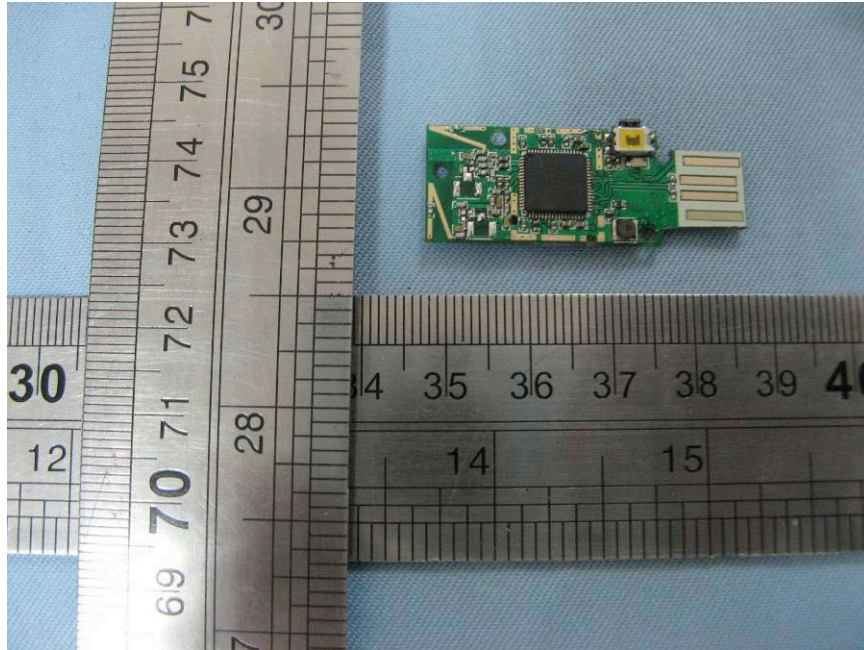

INTERNAL VIEW OF EUT-2

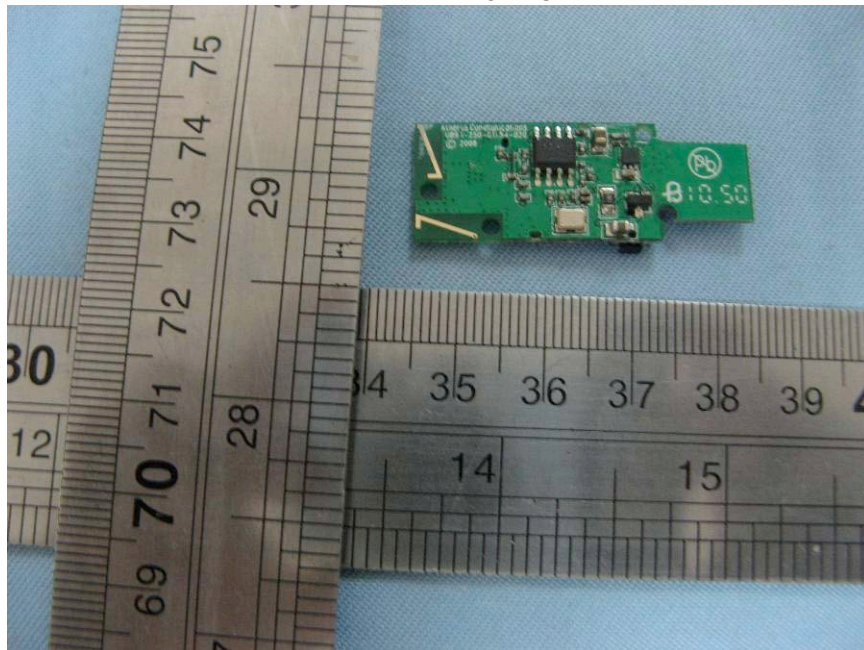

APPENDIX II
PHOTOGRAPHS OF THE TEST SETUP
RADIATED EMISSION TEST SETUP



CONDUCTED EMISSION TEST SETUP



----END OF REPORT----