

Quick Setup Guide

HD Wireless PTZ Dome IP Camera

Model: F19928P



To view this guide in other languages (e.g. Nederlands, Deutsch, Français, Español), and for detailed manuals, tools, etc., please visit <http://www.foscam.com> > Support > Download Center.

V1.0.1
EQ992801

Setting Up Your Foscam Security Camera

A Getting Started

Package Contents

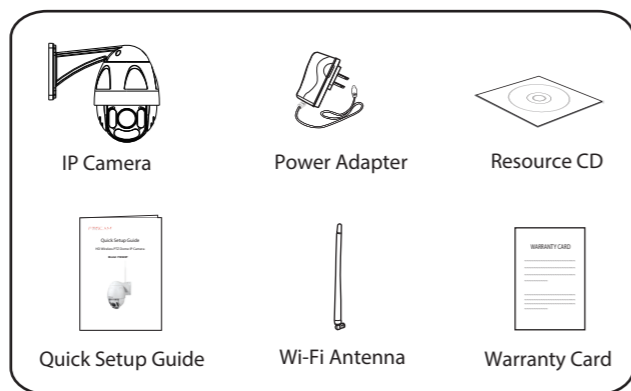

Security Tips

- Please change the password of your camera regularly, using a combination of numbers, letters and special characters.
- We recommend that you regularly update your camera to the latest available software and firmware versions to help ensure the best experience for your camera.

B Physical Description

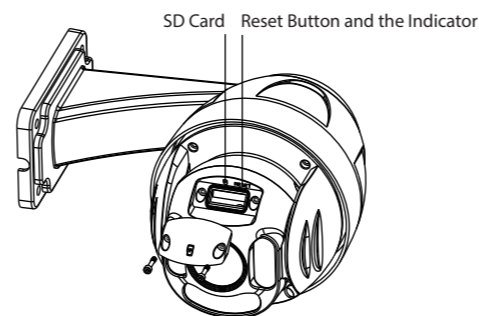
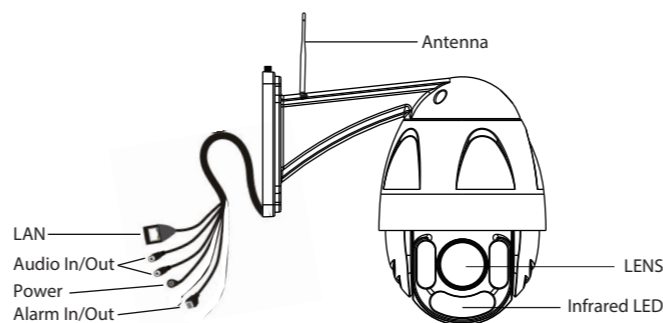

C Setting Up Your Camera: Wired Connection via Foscam App (Recommended)

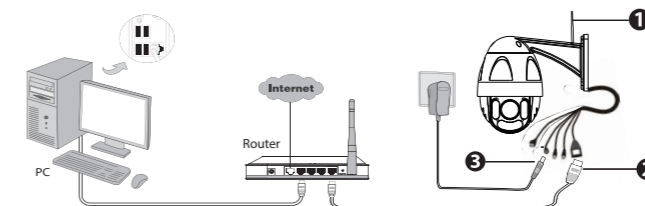

Note: We highly recommend that you first begin the setup process by connecting your camera to your Internet router with an Ethernet cable. After setup is successful, you'll be able to unplug the cable and login to your wireless network for WiFi operability.

Minimum Requirements:

To help ensure a smoother video experience on the smartphone, it's recommended that your smartphone has the following:

- IOS: version 8.1 or higher.
- Android: 4.1 or higher, using a device with a Graphics Processing Unit (GPU) function.

Camera Setup Steps:

1. Please mount the antenna and make sure it is in a vertical upright position.
2. Connect the camera to your Internet router using an Ethernet cable.
3. Connect the power adapter to the camera, and wait for a few moments until the camera alerts you that the "Wired connection succeeded" (if the device is connected with the audio output device).

4. From your smartphone, search for "Foscam" via the App Store or Google Play Store. Download, install and open the App to begin configuration.
5. Under "My Cameras," select "Tap + to add new camera" and then scan the QR code, which is located on your camera (see illustrations below).

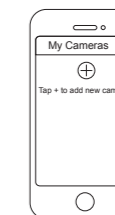

Tap + button



Scan the QR code which is located on your camera.

6. On the "Which way to choose" screen, confirm that "Wired" is selected (upper-left corner) and tap "Ready." Wait a few moments for a message confirming that the setup process has been completed (see illustrations below).

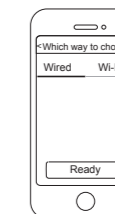

Confirm "Wired" and then tap "Ready"

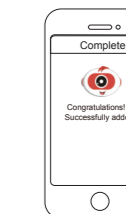

Connection succeeded!

D Connecting Your Camera Over WiFi

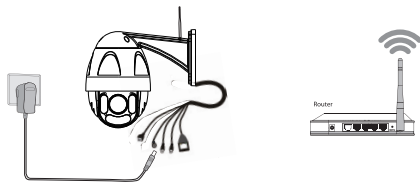

Once you've added your camera successfully using the wired connection method above, tap your live camera feed from the **My Cameras** screen > tap the gear in the upper-right > tap **Network** > tap the WiFi network you wish to connect to and enter your WiFi password.

Note: You'll need to connect to the 2.4 GHz network if your wireless router is dual-band—most newer models have 2.4 GHz and 5 GHz channels (see screenshot below).

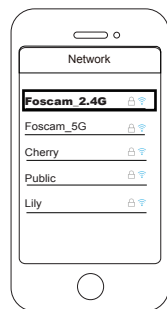

E Other Ways to Access Your Camera

■ Foscam Cloud Service

You can access the camera via the Foscam Cloud website:

<https://www.myfoscam.com>

Some of the benefits of viewing your camera in the cloud:

- It's simple and convenient to remotely access and manage all your WiFi security cameras.
- Enjoy the latest features first through Foscam Cloud including cloud storage, video sharing, and more.
- Getting started is fast—if you have already registered an account through Foscam App, you can directly use your login credentials for Foscam Cloud.

■ Web User Interface (Firefox and Internet Explorer)

If you would like to manage your camera more professionally, we suggest you access your camera via browser. You can download the "Equipment Search Tool" from

<http://foscam.com/downloadcenter/software-tools.html> to your computer, then access the camera directly via Firefox or Internet Explorer.

F Hardware Installation

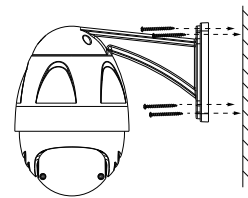

Fixate the camera on your preferred location and use the provided screws to mount it.

Please Note:

Ensure that the rain or water will not reach the connector ports at the end of the pig tail wiring. These connectors are not weather-resistant.

G Important Notice

■ Camera Username & Password

The camera username & password are used to access and manage your camera. Having a strong password can improve the security of your camera significantly.

If you have forgotten either of them, please press the "Reset" button and hold it for more than 15 seconds while the camera is powered on. After hearing the voice prompt (if the device is connected with the audio output device), release the button. The camera will automatically reboot and the default settings will be restored. The default username / password will then become admin / (blank), respectively.

After restoring to the factory default settings, please delete the camera from Foscam App, and then add it again.

■ Foscam Cloud Service Account Username & Password

Your Foscam Cloud service account and password may be used to access both Foscam App and the Foscam Cloud service website. Therefore, you may register the account username & password on either one.

■ Storage Media

Your camera supports cloud, NVR (Network Video Recorder), and Micro SD card storage formats. If you wish to record and playback large amounts of video, we recommend using a Foscam NVR device as well.

■ Firmware Upgrade

You can upgrade the firmware of your camera with Foscam App by using the new "One-key Online Upgrade" feature (Open Foscam APP, select **Settings** > **Firmware Upgrade**).

You also can download the latest version to upgrade your camera from our official website <http://www.foscam.com> (Select **Support** > **Download Center** > **Firmware Downloads**).

■ Safety Tips

- Please ensure that the proper power supply is used before using the camera.
- Please install the camera securely using the screws provided.
- To avoid the risk of fire or electric shock, please keep your camera in a cool, dry place.
- Please keep the camera out of reach of small children.
- Change your default port to a greater range to help ensure the safety of your connection.
- Check the logs of your Foscam cameras frequently. Foscam Cameras have embedded logs reminding you which IP addresses are accessing the camera.

FOSCAM[®]
— DIY Security —



CE Certificate Website:
<http://www.foscam.com/company/ce-certificate.html>

www.foscam.com

Questions? For any issues that occur during the setup process, please write to tech@foscam.com—we're here to help!

FCC Caution:

This device complies with FCC Rules Part 15. Operation is subject to the following two conditions.

- (1) This device may not cause harmful interference.
- (2) This device must accept any interference received, including interference that may cause undesired operation.

This equipment has been tested and found to comply with the limits for a Class A digital device, pursuant to Part 15 of the FCC Rules. These limits are designed to provide reasonable protection against harmful interference when the equipment is operated in a commercial environment. This equipment generates, uses, and can radiate radio frequency energy and, if not installed and used in accordance with the installation manual, may cause harmful interference to radio communications. Operation of this equipment in a residential area is likely to cause harmful interference, in which case the user will be required to correct the interference at his own expense.

FCC Radiation Exposure Statement:

This equipment complies with FCC radiation exposure limits set forth for uncontrolled environment. This equipment should be installed and operated with minimum distance 20cm between the radiator & your body. This transmitter must not be co-located or operating in conjunction with any other antenna or transmitter.

Radio Apparatus Containing Digital Circuits (ICES-003)

Radio apparatus containing digital circuitry which can function separately from the operation of a transmitter or an associated transmitter, shall comply with ICES-003. In such cases, the labeling requirements of the applicable RSS apply, rather than the labeling requirements in ICES-003.

User Manual Notice for Licence-Exempt Radio Apparatus

This device complies with Industry Canada licence-exempt RSS standard(s). Operation is subject to the following two conditions:

- (1) this device may not cause interference, and
- (2) this device must accept any interference, including interference that may cause undesired operation of the device.

Le présent appareil est conforme aux CNR d'Industrie Canada applicables aux appareils radio exempts de licence. L'exploitation est autorisée aux deux conditions suivantes :

- (1) l'appareil ne doit pas produire de brouillage, et*
- (2) l'utilisateur de l'appareil doit accepter tout brouillage radioélectrique subi, même si le brouillage est susceptible d'en compromettre le fonctionnement.*

This Class A digital apparatus complies with Canadian ICES-003.

Cet appareil numérique de la classe A est conforme à la norme NMB-003 du Canada.

The device is compliance with RF exposure guidelines, users can obtain Canadian information on RF exposure and compliance. The minimum distance from body to use the device is 20cm.

Le présent appareil est conforme

Après examen de ce matériel aux conformité ou aux limites d'intensité de champ RF, les utilisateurs peuvent sur l'exposition aux radiofréquences et la conformité and compliance d'acquérir les informations correspondantes. La distance minimale du corps à utiliser le dispositif est de 20cm.