

FCC PART 15.247

TEST REPORT

For

**ShenZhen Foscam Intelligent
Technology Co., Ltd**

5/F, Block 1, Vision Business Park, Nanshan District, Shenzhen, PRC

FCC ID: ZDEFI9900P

Report Type: Original Report	Product Type: Outdoor HD IP Camera
Test Engineer: <u>David Lee</u>	<i>David Lee</i>
Report Number: <u>RSZ150324008-00</u>	
Report Date: <u>2015-05-19</u>	
Reviewed By: <u>Jimmy Xiao</u>	<i>Jimmy Xiao</i>
Prepared By: RF Engineer	
Bay Area Compliance Laboratories Corp. (Shenzhen) 6/F, the 3rd Phase of WanLi Industrial Building ShiHua Road, FuTian Free Trade Zone Shenzhen, Guangdong, China Tel: +86-755-33320018 Fax: +86-755-33320008 www.baclcorp.com.cn	

Note: This test report is prepared for the customer shown above and for the equipment described herein. It may not be duplicated or used in part without prior written consent from Bay Area Compliance Laboratories Corp.

TABLE OF CONTENTS

GENERAL INFORMATION.....	4
OBJECTIVE	4
RELATED SUBMITTAL(S)/GRANT(S).....	4
TEST METHODOLOGY	4
TEST FACILITY	5
SYSTEM TEST CONFIGURATION.....	6
DESCRIPTION OF TEST CONFIGURATION	6
EQUIPMENT MODIFICATIONS	6
EUT EXERCISE SOFTWARE	6
SUPPORT EQUIPMENT LIST AND DETAILS	7
EXTERNAL I/O CABLE.....	7
BLOCK DIAGRAM OF TEST SETUP	8
SUMMARY OF TEST RESULTS	9
FCC §15.247 (i) & §1.1307 (b) (1) & §2.1091- MAXIMUM PERMISSIBLE EXPOSURE (MPE).....	10
APPLICABLE STANDARD	10
RESULT	10
FCC §15.203 - ANTENNA REQUIREMENT.....	11
APPLICABLE STANDARD	11
ANTENNA CONNECTOR CONSTRUCTION	11
FCC §15.207 (a) – AC LINE CONDUCTED EMISSIONS	12
APPLICABLE STANDARD	12
MEASUREMENT UNCERTAINTY.....	12
EUT SETUP.....	12
EMI TEST RECEIVER SETUP.....	13
TEST PROCEDURE	13
TEST EQUIPMENT LIST AND DETAILS.....	13
CORRECTED FACTOR & MARGIN CALCULATION	13
TEST RESULTS SUMMARY	14
TEST DATA	14
FCC §15.209, §15.205 & §15.247(d) - SPURIOUS EMISSIONS.....	17
APPLICABLE STANDARD	17
MEASUREMENT UNCERTAINTY.....	17
EUT SETUP	17
EMI TEST RECEIVER & SPECTRUM ANALYZER SETUP	18
TEST PROCEDURE	18
TEST EQUIPMENT LIST AND DETAILS.....	19
CORRECTED AMPLITUDE & MARGIN CALCULATION	19
TEST RESULTS SUMMARY	19
TEST DATA	20
FCC §15.247(a) (2) – 6 dB EMISSION BANDWIDTH.....	28
APPLICABLE STANDARD	28
TEST PROCEDURE	28
TEST EQUIPMENT LIST AND DETAILS.....	28
TEST DATA	28

FCC §15.247(b) (3) - MAXIMUM CONDUCTED OUTPUT POWER.....29
APPLICABLE STANDARD29
TEST PROCEDURE29
TEST EQUIPMENT LIST AND DETAILS.....29
TEST DATA29

FCC §15.247(d) – 100 kHz BANDWIDTH OF FREQUENCY BAND EDGE.....30
APPLICABLE STANDARD30
TEST PROCEDURE30
TEST EQUIPMENT LIST AND DETAILS.....30
TEST DATA30

FCC §15.247(e) - POWER SPECTRAL DENSITY31
APPLICABLE STANDARD31
TEST PROCEDURE31
TEST EQUIPMENT LIST AND DETAILS.....31
TEST DATA31

PRODUCT SIMILARITY DECLARATION LETTER.....32

GENERAL INFORMATION

The *ShenZhen Foscam Intelligent Technology Co., Ltd*'s product, model number: *FI9900P* (FCC ID: *ZDEFI9900P*) or the "EUT" in this report was a *Outdoor HD IP Camera*, which was measured approximately: 19.2 cm (L) x 6.6 cm (W) x 6.2 cm (H), rated with input voltage: DC 12V from the adapter.

Adapter Information:

Model: SAW-1201000

Input: AC 100-240V, 50/60 Hz, 0.5A

Output: DC 12V, 1000mA

Note: the product, series model FI9900EP, FI9901EP, FI9961EP, FI9962EP, FHD955W, EF9552, FC5618EP, FHD955E, EF9553, FC5618EP, FHD956E, EF9563, FC5718EP, FHD936E, EF9363, FC6618EP, FHD937E, EF9373 and FC6718EP are electrically identical schematics as model FI9900P, which was selected for fully testing. The only difference between them is the model number. The detailed information can be referred to the attached declaration which was stated and guaranteed by the applicant.

**All measurement and test data in this report was gathered from production sample serial number: 1503329 (Assigned by Shenzhen BACL). The EUT supplied by the applicant was received on 2015-03-24.*

Objective

This report is prepared on behalf of *ShenZhen Foscam Intelligent Technology Co., Ltd* in accordance with Part 2-Subpart J, Part 15-Subparts A, B and C of the Federal Communication Commissions rules.

The tests were performed in order to determine compliance with FCC Part 15, Subpart C, and section 15.203, 15.205, 15.207, 15.209 and 15.247 rules.

Related Submittal(s)/Grant(s)

N/A

Test Methodology

All measurements contained in this report were conducted with ANSI C63.4-2009, American National Standard for Methods of Measurement of Radio-Noise Emissions from Low-Voltage Electrical and Electronic Equipment in the range of 9 kHz to 40 GHz.

All emissions measurement was performed at Bay Area Compliance Laboratories Corp. (Shenzhen). The radiated testing was performed at an antenna-to-EUT distance of 3 meters.

Measurement uncertainty with RF radiated emission is 5.91 dB for 30MHz-1GHz.and 4.92 dB for above 1GHz, 1.95dB for conducted measurement.

Test Facility

The test site used by Bay Area Compliance Laboratories Corp. (Shenzhen) to collect test data is located on the 6/F, the 3rd Phase of WanLi Industrial Building, ShiHua Road, FuTian Free Trade Zone Shenzhen, Guangdong, China.

Test site at Bay Area Compliance Laboratories Corp. (Shenzhen) has been fully described in reports submitted to the Federal Communication Commission (FCC). The details of these reports have been found to be in compliance with the requirements of Section 2.948 of the FCC Rules on December 06, 2010. The facility also complies with the radiated and AC line conducted test site criteria set forth in ANSI C63.4-2009.

The Federal Communications Commission has the reports on file and is listed under FCC Registration No.: 382179. The test site has been approved by the FCC for public use and is listed in the FCC Public Access Link (PAL) database.

SYSTEM TEST CONFIGURATION

Description of Test Configuration

For 802.11b, 802.11g and 802.11n-HT20 mode, 13 channels are provided to testing:

Channel	Frequency(MHz)	Channel	Frequency(MHz)
1	2412	8	2447
2	2417	9	2452
3	2422	10	2457
4	2427	11	2462
5	2432	12	2467
6	2437	13	2472
7	2442	/	/

EUT was tested with Channel 1, 7 and 13.

For 802.11n-HT40 mode, 9 channels are provided to testing:

Channel	Frequency (MHz)	Channel	Frequency (MHz)
1	2422	6	2447
2	2427	7	2452
3	2432	8	2457
4	2437	9	2462
5	2442	/	/

EUT was tested with Channel 1, 5 and 9.

The worst-case data rates are determined to be as follows for each mode based upon investigation by measuring the average power and PSD across all data rates bandwidths, and modulations.

Equipment Modifications

No modification was made to the EUT tested.

EUT Exercise Software

Wifi test in the default power level.

Support Equipment List and Details

Manufacturer	Description	Model	Serial Number
N/A	Headset	N/A	1354677
BULL	Scoket	GN-415K	5503290068073
DELL	Monitor	E178FPc	070072
DELL	PC	Inspriion660	6104472
DELL	PC	DCSCSF	127BP2X
ECOM	Modem	56000bps	21654684
LISTED	EUT Adapter	TYP60-1207000Z	326703
DELL	Keyboard	SK-8115	CN-0DJ313-71616-0CE-0ATX
N/A	Mouse	N/A	1021501
N/A	Modem Adapter	N/A	2547812
Sagemcom	Router	N/A	32546

External I/O Cable

Cable Description	Length (m)	From Port	To
Shielding Un-detachable USB cable	1.5	PC	mouse
Shielding Un-detachable USB cable	1.5	PC	keyboard
Un-shielding Detachable RJ45 cable	1.2	PC	Router
Shielding Detachable VGA cable	1.5	PC	Monitor
Un-shielding Detachable RJ45 cable	1.6	EUT	Router
Un-shielding Un-detachable DC cable	1.6	Mains	Router
Un-shielding Un-detachable RS232 cable	1.5	PC	Modem
Shielding Detachable USB cable	1.5	EUT Adapter	EUT
Un-shielding Un-detachable AC cable	1.8	Scoket	mains
Un-shielding Detachable AC cable	1.5	Modem Adapter	mains
Un-shielding Un-detachable DC cable	1.5	Modem Adapter	Modem
Un-shielding Detachable AC cable	1.6	PC	Mains
Un-shielding Detachable AC cable	1.6	monitor	Mains
Un-shielding Detachable Headset cable	1.5	Headset	EUT

Block Diagram of Test Setup

For conducted emission

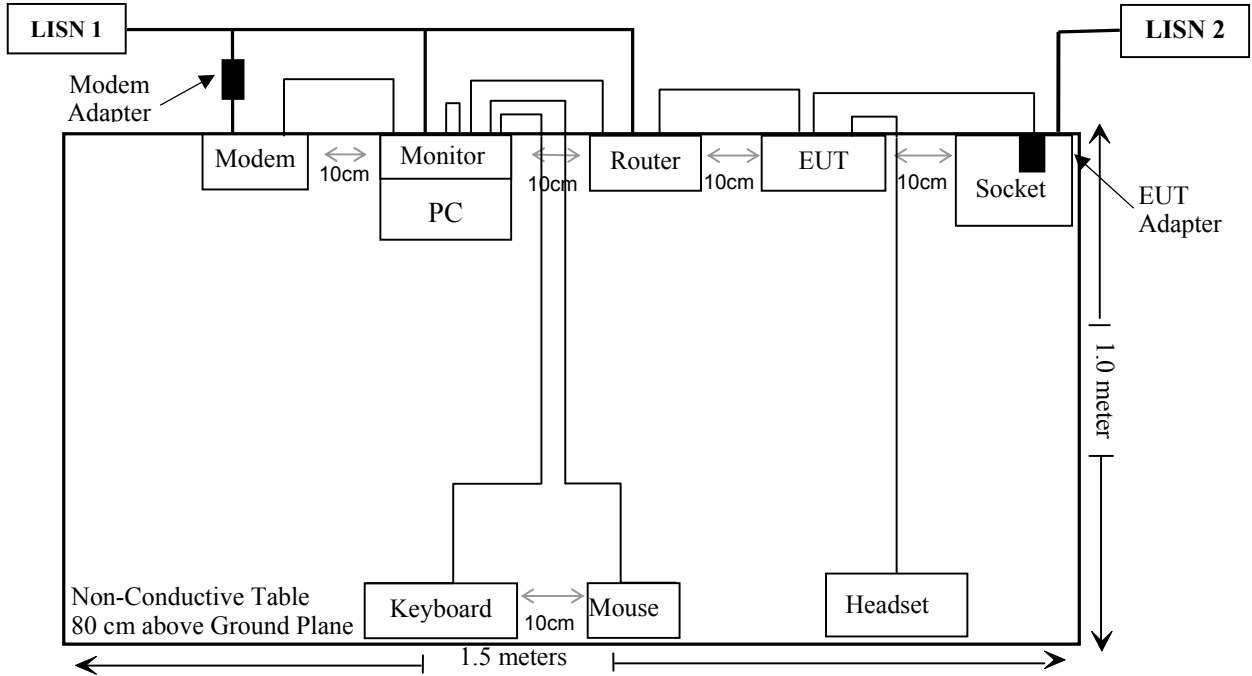

SUMMARY OF TEST RESULTS

FCC Rules	Description of Test	Result
§15.247 (i), §1.1307 (b) (1)& §2.1091	Maximum Permissible Exposure(MPE)	Compliance
§15.203	Antenna Requirement	Compliance
§15.207 (a)	AC Line Conducted Emissions	Compliance
§15.247(d)	Spurious Emissions at Antenna Port	Compliance*
§15.205, §15.209, §15.247(d)	Spurious Emissions	Compliance
§15.247 (a)(2)	6 dB Emission Bandwidth	Compliance*
§15.247(b)(3)	Maximum Conducted Output Power	Compliance*
§15.247(d)	100 kHz Bandwidth of Frequency Band Edge	Compliance*
§15.247(e)	Power Spectral Density	Compliance*

Compliance*: the EUT (Model: FI9900P, FCC ID: ZDEFI9900P) has used a certified module with model WUBB-743GN_WO PIN (FCC ID: ZQ6-WUBB743GN), the different test data between them are “§15.207 (a) AC Line Conducted Emissions” and “§15.205, §15.209, §15.247(d) Spurious Emissions”, so all the other test data are referred to the report FR540101 with model number WUBB-743GN_WO PIN (FCC ID: ZQ6-WUBB743GN), issued on 2015-04-20 by International Certification Corp.

FCC §15.247 (i) & §1.1307 (b) (1) & §2.1091- MAXIMUM PERMISSIBLE EXPOSURE (MPE)

Applicable Standard

According to subpart 15.247 (i) and subpart 1.1307 (b)(1), 2.1091 systems operating under the provisions of this section shall be operated in a manner that ensures the public is not exposed to RF energy level in excess of the communication guidelines.

Limits for General Population/Uncontrolled Exposure

Limits for General Population/Uncontrolled Exposure				
Frequency Range (MHz)	Electric Field Strength (V/m)	Magnetic Field Strength (A/m)	Power Density (mW/cm ²)	Averaging Time (Minutes)
0.3-1.34	614	1.63	*(100)	30
1.34-30	824/f	2.19/f	*(180/f ²)	30
30-300	27.5	0.073	0.2	30
300-1500	/	/	f/1500	30
1500-100,000	/	/	1.0	30

f = frequency in MHz

* = Plane-wave equivalent power density

Result

Calculated Formulary:

Predication of MPE limit at a given distance

$$S = \frac{PG}{4\pi R^2}$$

S = power density (in appropriate units, e.g. mW/cm²)

P = power input to the antenna (in appropriate units, e.g., mW).

G = power gain of the antenna in the direction of interest relative to an isotropic radiator, the power gain factor, is normally numeric gain.

R = distance to the center of radiation of the antenna (appropriate units, e.g., cm)

Frequency (MHz)	Antenna Gain		Conducted Power		Evaluation Distance (cm)	Power Density (mW/cm ²)	MPE Limit (mW/cm ²)
	(dBi)	(numeric)	(dBm)	(mW)			
2437	2	1.58	23.65	231.74	20	0.07	1

Note: To maintain compliance with the FCC’s RF exposure guidelines, place the equipment at least 20cm from nearby persons.

Result: Compliance

FCC §15.203 - ANTENNA REQUIREMENT

Applicable Standard

According to § 15.203, an intentional radiator shall be designed to ensure that no antenna other than that furnished by the responsible party shall be used with the device. The use of a permanently attached antenna or of an antenna that uses a unique coupling to the intentional radiator shall be considered sufficient to comply with the provisions of this section. The manufacturer may design the unit so that a broken antenna can be replaced by the user, but the user of a standard antenna jack or electrical connector is prohibited. The structure and application of the EUT were analyzed to determine compliance with section §15.203 of the rules. §15.203 state that the subject device must meet the following criteria:

- a. Antenna must be permanently attached to the unit.
- b. Antenna must use a unique type of connector to attach to the EUT.

Unit must be professionally installed, and installer shall be responsible for verifying that the correct antenna is employed with the unit.

And according to FCC 47 CFR section 15.247 (b), if the transmitting antennas of directional gain greater than 6dBi are used, the power shall be reduced by the amount in dB that the directional gain of the antenna exceeds 6 dBi.

Antenna Connector Construction

The EUT has one I-PEX antenna connector arrangement, which was permanently attached and the antenna gain is 2.0dBi, fulfill the requirement of this section. Please refer to the EUT photos.

Result: Compliance.

FCC §15.207 (a) – AC LINE CONDUCTED EMISSIONS

Applicable Standard

FCC§15.207

Measurement Uncertainty

Input quantities to be considered for conducted disturbance measurements may be receiver reading, attenuation of the connection between LISN and receiver, LISN voltage division factor, LISN VDF frequency interpolation and receiver related input quantities, etc.

Based on CISPR 16-4-2:2011, the expanded combined standard uncertainty of conducted disturbance test at Bay Area Compliance Laboratories Corp. (Shenzhen) is shown as below. And the uncertainty will not be taken into consideration for the test data recorded in the report.

Port	Expanded Measurement uncertainty
AC Mains	3.26 dB (k=2, 95% level of confidence)
CAT 3	3.70 dB (k=2, 95% level of confidence)
CAT 5	3.86 dB (k=2, 95% level of confidence)
CAT 6	4.64 dB (k=2, 95% level of confidence)

EUT Setup

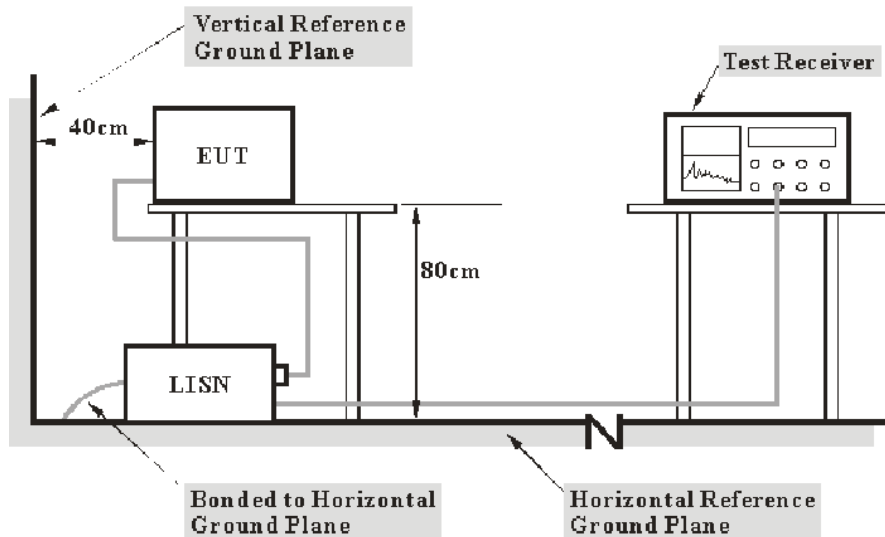

- Note: 1. Support units were connected to second LISN.
 2. Both of LISNs (AMN) 80 cm from EUT and at the least 80 cm from other units and other metal planes support units.

The setup of EUT is according with per ANSI C63.4-2009 measurement procedure. The specification used was with the FCC Part 15.207 limits.

The adapter was connected to a 120 VAC/60 Hz power source.

EMI Test Receiver Setup

The EMI test receiver was set to investigate the spectrum from 150 kHz to 30 MHz.

During the conducted emission test, the EMI test receiver was set with the following configurations:

Frequency Range	IF B/W
150 kHz – 30 MHz	9 kHz

Test Procedure

During the conducted emission test, the host PC was connected to the outlet of the LISN, the other related equipments were connected to the other LISN.

Maximizing procedure was performed on the six (6) highest emissions of the EUT.

All final data was recorded in the Quasi-peak and average detection mode.

Test Equipment List and Details

Manufacturer	Description	Model	Serial Number	Calibration Date	Calibration Due Date
Rohde & Schwarz	EMI Test Receiver	ESCS30	100176	2014-06-03	2015-06-03
Rohde & Schwarz	LISN	ESH2-Z5	892107/021	2014-08-22	2015-08-22
Rohde & Schwarz	LISN	ENV216	3560.6650.12-101613-Yb	2014-12-01	2015-12-01
Rohde & Schwarz	Transient Limiter	ESH3Z2	DE25985	2014-10-15	2015-10-15
Rohde & Schwarz	CE Test software	EMC 32	V8.53	NCR	NCR

* **Statement of Traceability:** Bay Area Compliance Laboratories Corp. (Shenzhen) attests that all calibrations have been performed in accordance to requirements that traceable to National Primary Standards and International System of Units (SI).

Corrected Factor & Margin Calculation

The Corrected factor is calculated by adding LISN VDF (Voltage Division Factor), Cable Loss and Transient Limiter Attenuation. The basic equation is as follows:

$$\text{Correction Factor} = \text{LISN VDF} + \text{Cable Loss} + \text{Transient Limiter Attenuation}$$

The “**Margin**” column of the following data tables indicates the degree of compliance with the applicable limit. For example, a margin of 7 dB means the emission is 7 dB below the limit. The equation for margin calculation is as follows:

$$\text{Margin} = \text{Limit} - \text{Corrected Amplitude}$$

Test Results Summary

According to the recorded data in following table, the EUT complied with the FCC Part 15.207, the worst margin reading as below:

10.1 dB at 0.549810 MHz in the conducted mode

Refer to CISPR16-4-2:2011 and CISPR 16-4-1:2009, the measured level complies with the limit if

$$L_m + U_{(L_m)} \leq L_{lim} + U_{cispr}$$

In BACL, $U_{(L_m)}$ is less than U_{cispr} , if L_m is less than L_{lim} , it implies that the EUT complies with the limit.

Test Data

Environmental Conditions

Temperature:	25 °C
Relative Humidity:	50 %
ATM Pressure:	101.0 kPa

The testing was performed by David Lee on 2015-05-06.

EUT operation mode: Transmitting

AC 120V/60 Hz, Line

EMI Auto Test L

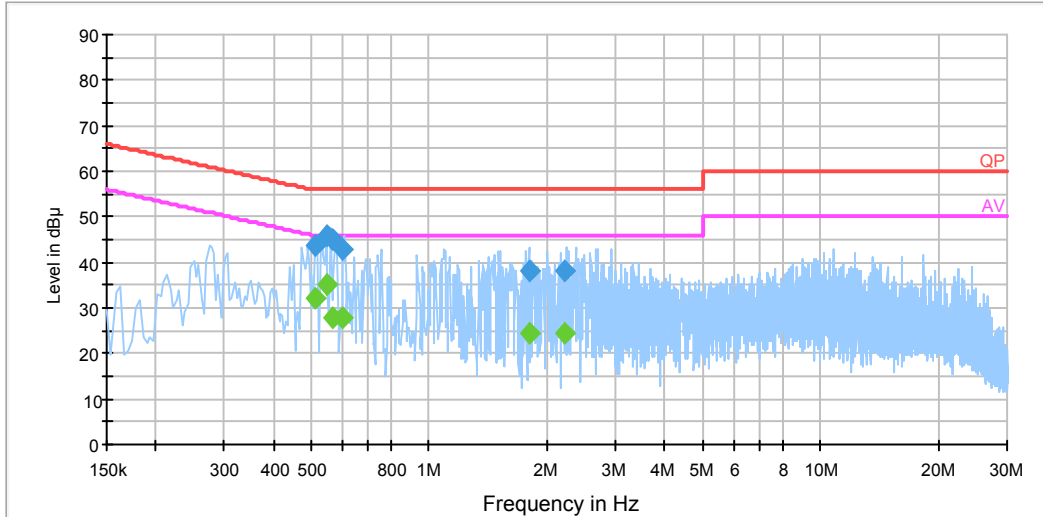

Frequency (MHz)	Corrected Amplitude (dBµV)	Correction Factor (dB)	Limit (dBµV)	Margin (dB)	Detector (PK/Ave./QP)
0.510350	43.7	19.3	56.0	12.3	QP
0.510350	32.3	19.3	46.0	13.7	Ave.
0.549810	45.9	19.3	56.0	10.1	QP
0.549810	35.2	19.3	46.0	10.8	Ave.
0.566370	44.9	19.3	56.0	11.1	QP
0.566370	28.0	19.3	46.0	18.0	Ave.
0.600850	42.7	19.3	56.0	13.3	QP
0.600850	27.7	19.3	46.0	18.3	Ave.
1.803030	38.0	19.4	56.0	18.0	QP
1.803030	24.5	19.4	46.0	21.5	Ave.
2.232190	38.1	19.4	56.0	17.9	QP
2.232190	24.5	19.4	46.0	21.5	Ave.

AC 120V/60 Hz, Neutral

EMI Auto Test N

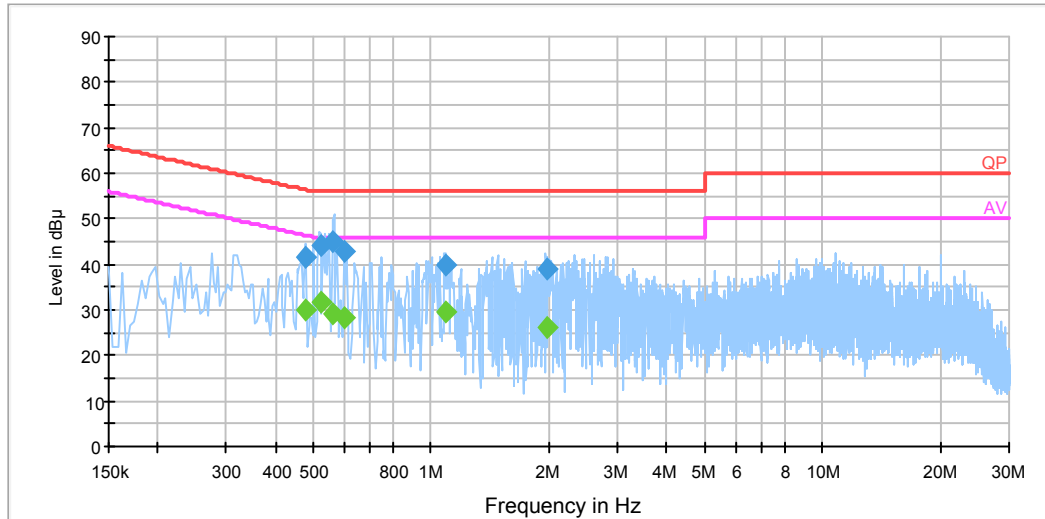

Frequency (MHz)	Corrected Amplitude (dBµV)	Correction Factor (dB)	Limit (dBµV)	Margin (dB)	Detector (PK/Ave./QP)
0.478830	41.7	19.2	56.4	14.7	QP
0.478830	30.2	19.2	46.4	16.2	Ave.
0.522230	44.1	19.2	56.0	11.9	QP
0.522230	31.7	19.2	46.0	14.3	Ave.
0.561510	45.0	19.3	56.0	11.0	QP
0.561510	29.0	19.3	46.0	17.0	Ave.
0.601030	42.7	19.3	56.0	13.3	QP
0.601030	28.3	19.3	46.0	17.7	Ave.
1.089710	39.8	19.4	56.0	16.2	QP
1.089710	29.5	19.4	46.0	16.5	Ave.
1.980510	39.1	19.4	56.0	16.9	QP
1.980510	26.4	19.4	46.0	19.6	Ave.

Note:

- 1) Correction Factor = LISN VDF (Voltage Division Factor) + Cable Loss + Transient Limiter Attenuation
- 2) Corrected Amplitude = Reading + Correction Factor
- 3) Margin = Limit - Corrected Amplitude

FCC §15.209, §15.205 & §15.247(d) - SPURIOUS EMISSIONS

Applicable Standard

FCC §15.247 (d); §15.209; §15.205;

Measurement Uncertainty

All measurements involve certain levels of uncertainties, especially in field of EMC. The factors contributing to uncertainties are spectrum analyzer, cable loss, antenna factor calibration, antenna directivity, antenna factor variation with height, antenna phase center variation, antenna factor frequency interpolation, measurement distance variation, site imperfections, mismatch (average), and system repeatability.

Based on CISPR 16-4-2:2011, the expanded combined standard uncertainty of radiation emissions at Bay Area Compliance Laboratories Corp. (Shenzhen) is 5.91 dB for 30MHz-1GHz and 4.92 dB for above 1GHz, 1.95dB for conducted measurement at antenna port. And the uncertainty will not be taken into consideration for the test data recorded in the report

EUT Setup

Below 1 GHz:

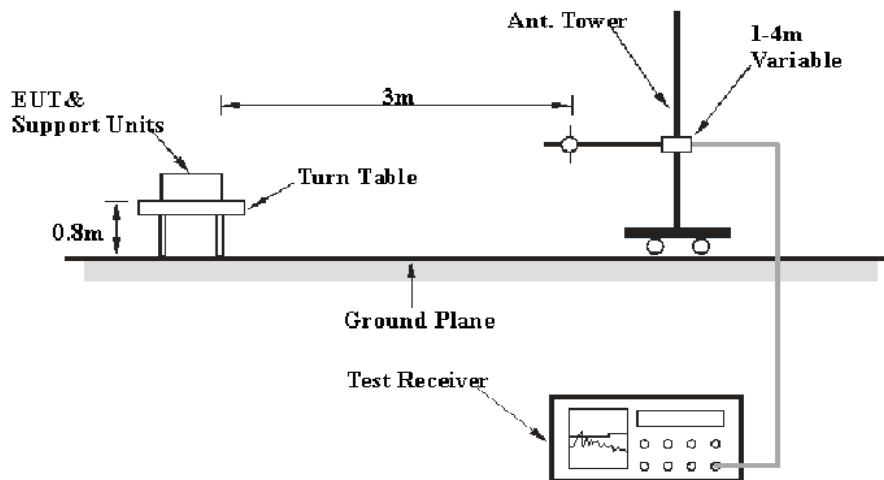

Above 1GHz:

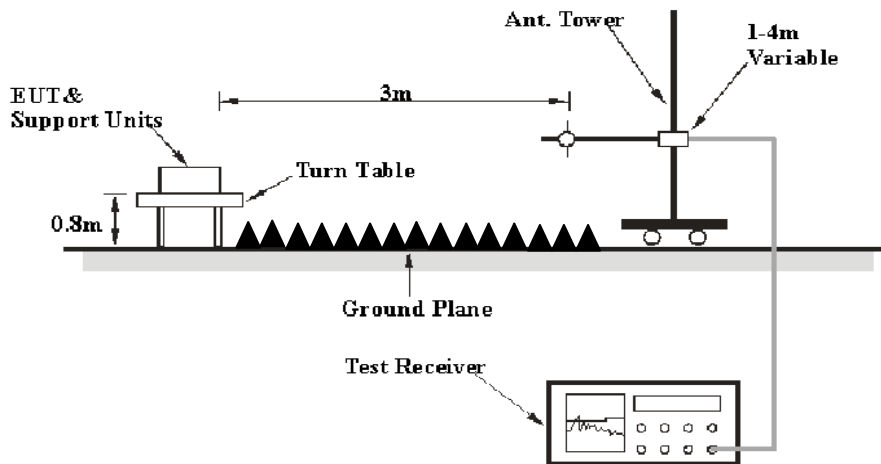

The radiated emission tests were performed in the 3 meters test site, using the setup accordance with the ANSI C63.4-2009. The specification used was the FCC 15.209, and FCC 15.247 limits.

The adapter was connected to a 120 VAC/60 Hz power source.

EMI Test Receiver & Spectrum Analyzer Setup

The system was investigated from 30 MHz to 25 GHz.

During the radiated emission test, the EMI test receiver & Spectrum Analyzer Setup were set with the following configurations:

Frequency Range	RBW	Video B/W	IF B/W	Detector
30 MHz – 1000 MHz	100 kHz	300 kHz	120 kHz	QP
Above 1 GHz	1MHz	3 MHz	/	PK
	1MHz	10 Hz	/	Ave.

Test Procedure

Maximizing procedure was performed on the highest emissions to ensure that the EUT complied with all installation combinations.

Data was recorded in Quasi-peak detection mode for frequency range of 30 MHz-1 GHz, peak and Average detection modes for frequencies above 1 GHz.

Test Equipment List and Details

Manufacturer	Description	Model	Serial Number	Calibration Date	Calibration Due Date
HP	Amplifier	HP8447E	1937A01046	2014-05-06	2015-05-06
Rohde & Schwarz	EMI Test Receiver	ESCI	101120	2014-11-03	2015-11-03
Sunol Sciences	Bi-log Antenna	JB1	A040904-2	2014-12-07	2017-12-06
Mini	Amplifier	ZVA-183-S+	5969001149	2015-04-23	2016-04-23
A.H. System	Horn Antenna	SAS-200/571	135	2015-02-10	2016-02-10
Rohde & Schwarz	Signal Analyzer	FSIQ26	8386001028	2014-12-11	2015-12-11
the electro-Mechanics Co.	Horn Antenna	3116	9510-2270	2013-10-14	2016-10-13
TDK	Chamber	Chamber A	2#	2012-10-15	2015-10-15
TDK	Chamber	Chamber B	1#	2014-07-22	2015-07-22
DUCOMMUN	Pre-amplifier	ALN-22093530-01	991373-01	2014-08-03	2015-08-03
R&S	Auto test Software	EMC32	V9.10	NCR	NCR

* **Statement of Traceability:** Bay Area Compliance Laboratories Corp. (Shenzhen) attests that all calibrations have been performed in accordance to requirements that traceable to National Primary Standards and International System of Units (SI).

Corrected Amplitude & Margin Calculation

The Corrected Amplitude is calculated by adding the Antenna Factor and Cable Loss, and subtracting the Amplifier Gain from the Meter Reading. The basic equation is as follows:

$$\text{Corrected Amplitude} = \text{Meter Reading} + \text{Antenna Factor} + \text{Cable Loss} - \text{Amplifier Gain}$$

The “**Margin**” column of the following data tables indicates the degree of compliance with the applicable limit. For example, a margin of 7dB means the emission is 7dB below the limit. The equation for margin calculation is as follows:

$$\text{Margin} = \text{Limit} - \text{Corrected Amplitude}$$

Test Results Summary

According to the recorded data in following table, the EUT complied with the FCC Title 47, Part 15, Subpart C, section 15.205, 15.209 and 15.247.

0.52 dB at 120.80 MHz in the **Vertical** polarization for **802.11n-HT40** mode Low channel

Refer to CISPR16-4-2:2011 and CISPR 16-4-1:2009, the measured level complies with the limit if

$$L_m + U_{(L_m)} \leq L_{lim} + U_{cispr}$$

In BACL, $U_{(L_m)}$ is less than U_{cispr} , if L_m is less than L_{lim} , it implies that the EUT complies with the limit.

Test Data**Environmental Conditions**

Temperature:	26 °C
Relative Humidity:	51 %
ATM Pressure:	101.0 kPa

The testing was performed by David Lee on 2015-05-04.

EUT operation mode: Transmitting

30 MHz-25 GHz:**802.11b Mode:**

Frequency (MHz)	Receiver		Turntable Degree	Rx Antenna		Corrected Factor (dB)	Corrected Amplitude (dB μ V/m)	FCC Part 15.247/205/209	
	Reading (dB μ V)	Detector (PK/QP/Ave.)		Height (m)	Polar (H/V)			Limit (dB μ V/m)	Margin (dB)
Low Channel (2412 MHz)									
120.80	52.25	QP	179	1.5	V	-10.70	41.55	43.5	1.95
2412.00	91.31	PK	78	1.0	H	4.27	95.58	/	/
2412.00	82.27	Ave.	78	1.0	H	4.27	86.54	/	/
2412.00	96.74	PK	226	1.3	V	4.17	100.91	/	/
2412.00	93.66	Ave.	226	1.3	V	4.17	97.83	/	/
2389.98	44.23	PK	237	1.7	H	4.27	48.50	74	25.50
2389.98	29.49	Ave.	237	1.7	H	4.27	33.76	54	20.24
2489.94	41.97	PK	254	1.5	H	7.99	49.96	74	24.04
2489.94	20.52	Ave.	254	1.5	H	7.99	28.51	54	25.49
2891.25	45.77	PK	350	1.1	H	8.96	54.73	74	19.27
2891.25	41.82	Ave.	350	1.1	H	8.96	50.78	54	3.22
4824.00	46.62	PK	65	1.4	H	18.31	66.93	74	9.07
4824.00	33.04	Ave.	65	1.4	H	18.31	51.35	54	2.65
7236.00	40.24	PK	19	1.2	H	22.28	62.52	74	11.48
7236.00	22.12	Ave.	19	1.2	H	22.28	44.40	54	9.60
9648.00	37.51	PK	341	1.4	H	25.02	62.53	74	11.47
9648.00	23.57	Ave.	341	1.4	H	25.02	48.59	54	5.41

Frequency (MHz)	Receiver		Turntable Degree	Rx Antenna		Corrected Factor (dB)	Corrected Amplitude (dBµV/m)	FCC Part 15.247/205/209	
	Reading (dBµV)	Detector (PK/QP/Ave.)		Height (m)	Polar (H/V)			Limit (dBµV/m)	Margin (dB)
Middle Channel (2437 MHz)									
120.80	53.62	QP	110	1.9	V	-10.70	42.92	43.5	0.58
2437.00	90.89	PK	119	2.1	H	4.27	95.16	/	/
2437.00	81.90	Ave.	119	2.1	H	4.27	86.17	/	/
2437.00	97.51	PK	274	2.1	V	4.17	101.68	/	/
2437.00	93.78	Ave.	274	2.1	V	4.17	97.95	/	/
2388.85	45.83	PK	345	2.0	H	4.27	50.10	74	23.90
2388.85	29.62	Ave.	345	2.0	H	4.27	33.89	54	20.11
2485.90	40.92	PK	123	1.4	H	7.99	48.91	74	25.09
2485.90	20.52	Ave.	123	1.4	H	7.99	28.51	54	25.49
2735.91	44.87	PK	304	1.5	H	8.31	53.18	74	20.82
2735.91	41.14	Ave.	304	1.5	H	8.31	49.45	54	4.55
4874.00	46.49	PK	357	1.8	V	19.41	67.90	74	8.10
4874.00	33.79	Ave.	357	1.8	V	19.41	53.20	54	0.80
7311.00	38.80	PK	89	1.8	V	22.60	61.40	74	12.60
7311.00	21.76	Ave.	89	1.8	V	22.60	44.36	54	9.64
9748.00	37.12	PK	57	2.4	V	25.22	62.34	74	11.66
9748.00	22.18	Ave.	57	2.4	V	25.22	47.40	54	6.60
High Channel (2462 MHz)									
120.80	53.43	QP	62	1.8	V	-10.70	42.73	43.5	0.77
2462.00	91.27	PK	331	1.8	H	7.99	99.26	/	/
2462.00	82.26	Ave.	331	1.8	H	7.99	90.25	/	/
2462.00	97.61	PK	53	1.6	V	7.59	105.20	/	/
2462.00	94.21	Ave.	53	1.6	V	7.59	101.80	/	/
2384.15	45.20	PK	294	2.1	H	4.27	49.47	74	24.53
2384.15	28.08	Ave.	294	2.1	H	4.27	32.35	54	21.65
2494.38	40.41	PK	63	2.0	H	7.99	48.40	74	25.60
2494.38	20.52	Ave.	63	2.0	H	7.99	28.51	54	25.49
2973.57	44.85	PK	270	1.1	V	11.08	55.93	74	18.07
2973.57	41.79	Ave.	270	1.1	V	11.08	52.87	54	1.13
4924.00	45.71	PK	264	2.2	H	19.21	66.92	74	9.08
4924.00	33.44	Ave.	264	2.2	H	19.21	52.65	54	1.35
7386.00	39.58	PK	257	1.5	H	21.54	61.12	74	12.88
7386.00	23.59	Ave.	257	1.5	H	21.54	45.13	54	8.87
9848.00	37.48	PK	52	2.4	V	26.29	63.77	74	10.23
9848.00	23.37	Ave.	52	2.4	V	26.29	49.66	54	4.34

802.11g Mode:

Frequency (MHz)	Receiver		Turntable Degree	Rx Antenna		Corrected Factor (dB)	Corrected Amplitude (dBµV/m)	FCC Part 15.247/205/209	
	Reading (dBµV)	Detector (PK/QP/Ave.)		Height (m)	Polar (H/V)			Limit (dBµV/m)	Margin (dB)
Low Channel (2412 MHz)									
120.80	53.07	QP	177	1.2	V	-10.70	42.37	43.5	1.13
2412.00	89.66	PK	20	1.9	H	4.27	93.93	/	/
2412.00	81.57	Ave.	20	1.9	H	4.27	85.84	/	/
2412.00	97.17	PK	190	1.4	V	4.17	101.34	/	/
2412.00	92.65	Ave.	190	1.4	V	4.17	96.82	/	/
2388.59	44.92	PK	162	2.0	H	4.27	49.19	74	24.81
2388.59	27.81	Ave.	162	2.0	H	4.27	32.08	54	21.92
2484.34	41.71	PK	84	1.2	H	7.99	49.70	74	24.30
2484.34	20.52	Ave.	84	1.2	H	7.99	28.51	54	25.49
2776.40	45.52	PK	300	2.1	H	8.41	53.93	74	20.07
2776.40	42.79	Ave.	300	2.1	H	8.41	51.20	54	2.80
4824.00	46.54	PK	97	1.7	V	18.51	67.05	74	8.95
4824.00	33.45	Ave.	97	1.7	V	18.51	51.96	54	2.04
7236.00	40.35	PK	359	1.1	H	22.28	62.63	74	11.37
7236.00	22.96	Ave.	359	1.1	H	22.28	45.24	54	8.76
9648.00	36.97	PK	321	1.0	H	25.02	61.99	74	12.01
9648.00	21.98	Ave.	321	1.0	H	25.02	47.00	54	7.00
Middle Channel (2437 MHz)									
120.80	53.03	QP	148	2.4	V	-10.70	42.33	43.5	1.17
2437.00	89.60	PK	255	2.3	H	4.27	93.87	/	/
2437.00	82.82	Ave.	255	2.3	H	4.27	87.09	/	/
2437.00	97.32	PK	182	2.4	V	4.17	101.49	/	/
2437.00	92.36	Ave.	182	2.4	V	4.17	96.53	/	/
2385.90	45.86	PK	319	2.4	H	4.27	50.13	74	23.87
2385.90	27.66	Ave.	319	2.4	H	4.27	31.93	54	22.07
2498.50	41.63	PK	113	1.9	H	7.99	49.62	74	24.38
2498.50	20.52	Ave.	113	1.9	H	7.99	28.51	54	25.49
2970.36	46.26	PK	160	2.1	H	11.28	57.54	74	16.46
2970.36	41.24	Ave.	160	2.1	H	11.28	52.52	54	1.48
4874.00	46.20	PK	203	1.4	H	19.21	66.41	74	8.59
4874.00	33.70	Ave.	203	1.4	H	19.21	52.91	54	1.09
7311.00	39.43	PK	26	2.4	V	22.60	62.03	74	11.97
7311.00	22.73	Ave.	26	2.4	V	22.60	45.33	54	8.67
9748.00	37.56	PK	111	1.5	V	25.22	62.78	74	11.22
9748.00	22.16	Ave.	111	1.5	V	25.22	47.38	54	6.62

Frequency (MHz)	Receiver		Turntable Degree	Rx Antenna		Corrected Factor (dB)	Corrected Amplitude (dBµV/m)	FCC Part 15.247/205/209	
	Reading (dBµV)	Detector (PK/QP/Ave.)		Height (m)	Polar (H/V)			Limit (dBµV/m)	Margin (dB)
High Channel (2462 MHz)									
120.80	53.40	QP	34	2.2	V	-10.70	42.70	43.5	0.80
2462.00	89.61	PK	31	2.4	H	7.99	97.60	/	/
2462.00	81.87	Ave.	31	2.4	H	7.99	89.86	/	/
2462.00	98.07	PK	305	1.5	V	7.59	105.66	/	/
2462.00	94.27	Ave.	305	1.5	V	7.59	101.86	/	/
2384.61	45.18	PK	49	1.7	H	4.27	49.45	74	24.55
2384.61	29.57	Ave.	49	1.7	H	4.27	33.84	54	20.16
2494.90	40.38	PK	214	1.6	H	7.99	48.37	74	25.63
2494.90	20.52	Ave.	214	1.6	H	7.99	28.51	54	25.49
2801.66	46.58	PK	195	1.2	V	8.01	54.59	74	19.41
2801.66	42.13	Ave.	195	1.2	V	8.01	50.14	54	3.86
4924.00	46.85	PK	355	2.4	H	19.21	67.06	74	7.94
4924.00	32.66	Ave.	355	2.4	H	19.21	51.87	54	2.13
7386.00	39.18	PK	107	1.7	V	21.54	60.72	74	13.28
7386.00	22.09	Ave.	107	1.7	V	21.54	43.63	54	10.37
9848.00	38.07	PK	326	1.7	H	26.09	64.16	74	9.84
9848.00	22.17	Ave.	326	1.7	H	26.09	48.26	54	5.74

802.11n-HT20 Mode:

Frequency (MHz)	Receiver		Turntable Degree	Rx Antenna		Corrected Factor (dB)	Corrected Amplitude (dBµV/m)	FCC Part 15.247/205/209	
	Reading (dBµV)	Detector (PK/QP/Ave.)		Height (m)	Polar (H/V)			Limit (dBµV/m)	Margin (dB)
Low Channel (2412 MHz)									
120.80	53.09	QP	347	2.0	V	-10.70	42.39	43.5	1.11
2412.00	91.22	PK	346	1.3	H	4.27	95.49	/	/
2412.00	83.05	Ave.	346	1.3	H	4.27	87.32	/	/
2412.00	98.13	PK	335	2.3	V	4.17	102.30	/	/
2412.00	92.47	Ave.	335	2.3	V	4.17	96.64	/	/
2389.14	44.15	PK	282	1.7	H	4.27	48.42	74	25.58
2389.14	28.50	Ave.	282	1.7	H	4.27	32.77	54	21.23
2499.13	41.19	PK	158	1.1	H	7.99	49.18	74	24.82
2499.13	20.52	Ave.	158	1.1	H	7.99	28.51	54	25.49
2860.03	46.29	PK	200	1.6	V	8.56	54.85	74	19.15
2860.03	42.65	Ave.	200	1.6	V	8.56	51.21	54	2.79
4824.00	46.82	PK	348	2.0	V	18.51	66.33	74	8.67
4824.00	32.55	Ave.	348	2.0	V	18.51	51.06	54	2.94
7236.00	39.19	PK	310	2.3	V	22.28	61.47	74	12.53
7236.00	22.89	Ave.	310	2.3	V	22.28	45.17	54	8.83
9648.00	37.79	PK	2	2.3	H	25.02	62.81	74	11.19
9648.00	23.12	Ave.	2	2.3	H	25.02	48.14	54	5.86
Middle Channel (2437 MHz)									
120.80	53.26	QP	41	2.4	V	-10.70	42.56	43.5	0.94
2437.00	89.57	PK	266	2.0	H	4.27	93.84	/	/
2437.00	83.11	Ave.	266	2.0	H	4.27	87.38	/	/
2437.00	97.72	PK	144	1.6	V	4.17	101.89	/	/
2437.00	93.81	Ave.	144	1.6	V	4.17	97.98	/	/
2386.93	45.80	PK	292	1.8	H	4.27	50.07	74	23.93
2386.93	28.73	Ave.	292	1.8	H	4.27	33.00	54	21.00
2493.58	41.58	PK	202	2.0	H	7.99	49.57	74	24.43
2493.58	20.52	Ave.	202	2.0	H	7.99	28.51	54	25.49
2839.89	45.16	PK	215	2.0	H	8.41	53.57	74	20.43
2839.89	41.28	Ave.	215	2.0	H	8.41	49.69	54	4.31
4874.00	46.20	PK	91	2.5	V	19.41	66.61	74	8.39
4874.00	32.63	Ave.	91	2.5	V	19.41	52.04	54	1.96
7311.00	38.55	PK	304	1.8	H	22.60	61.15	74	12.85
7311.00	22.06	Ave.	304	1.8	H	22.60	44.66	54	9.34
9748.00	38.61	PK	232	1.9	V	25.22	63.83	74	10.17
9748.00	23.44	Ave.	232	1.9	V	25.22	48.66	54	5.34

Frequency (MHz)	Receiver		Turntable Degree	Rx Antenna		Corrected Factor (dB)	Corrected Amplitude (dBµV/m)	FCC Part 15.247/205/209	
	Reading (dBµV)	Detector (PK/QP/Ave.)		Height (m)	Polar (H/V)			Limit (dBµV/m)	Margin (dB)
High Channel (2462 MHz)									
120.80	52.51	QP	116	1.7	V	-10.70	41.81	43.5	1.69
2462.00	90.31	PK	360	2.5	H	7.99	98.30	/	/
2462.00	81.71	Ave.	360	2.5	H	7.99	89.70	/	/
2462.00	97.58	PK	201	1.1	V	7.59	105.17	/	/
2462.00	93.36	Ave.	201	1.1	V	7.59	100.95	/	/
2383.26	44.93	PK	276	2.5	H	4.27	49.20	74	24.80
2383.26	27.65	Ave.	276	2.5	H	4.27	31.92	54	22.08
2494.83	41.80	PK	228	1.1	H	7.99	49.79	74	24.21
2494.83	20.52	Ave.	228	1.1	H	7.99	28.51	54	25.49
2926.44	46.02	PK	220	2.3	H	8.96	54.98	74	19.02
2926.44	41.59	Ave.	220	2.3	H	8.96	50.55	54	3.45
4924.00	45.93	PK	264	1.2	V	19.41	67.34	74	8.66
4924.00	32.58	Ave.	264	1.2	V	19.41	51.99	54	2.01
7386.00	40.21	PK	328	2.4	V	21.54	61.75	74	12.25
7386.00	23.24	Ave.	328	2.4	V	21.54	44.78	54	9.22
9848.00	36.87	PK	203	1.0	V	26.29	63.16	74	10.84
9848.00	22.63	Ave.	203	1.0	V	26.29	48.92	54	5.08

802.11n-HT40 Mode:

Frequency (MHz)	Receiver		Turntable Degree	Rx Antenna		Corrected Factor (dB)	Corrected Amplitude (dBµV/m)	FCC Part 15.247/205/209	
	Reading (dBµV)	Detector (PK/QP/Ave.)		Height (m)	Polar (H/V)			Limit (dBµV/m)	Margin (dB)
Low Channel (2412 MHz)									
120.80	53.68	QP	335	2.1	V	-10.70	42.98	43.5	0.52
2422.00	90.02	PK	288	2.3	H	4.27	94.29	/	/
2422.00	82.71	Ave.	288	2.3	H	4.27	86.98	/	/
2422.00	98.66	PK	259	2.4	V	4.17	102.83	/	/
2422.00	94.09	Ave.	259	2.4	V	4.17	98.26	/	/
2389.17	45.25	PK	92	1.2	H	4.27	49.52	74	24.48
2389.17	29.15	Ave.	92	1.2	H	4.27	33.42	54	20.58
2484.88	40.73	PK	330	2.4	H	7.99	48.72	74	25.28
2484.88	20.52	Ave.	330	2.4	H	7.99	28.51	54	25.49
2820.44	44.74	PK	306	1.2	H	8.41	53.15	74	20.85
2820.44	41.99	Ave.	306	1.2	H	8.41	50.40	54	3.60
4844.00	46.02	PK	64	1.3	V	18.51	66.53	74	9.47
4844.00	33.36	Ave.	64	1.3	V	18.51	51.87	54	2.13
7266.00	39.61	PK	159	1.4	V	22.60	62.21	74	11.79
7266.00	23.27	Ave.	159	1.4	V	22.60	45.87	54	8.13
9688.00	37.32	PK	60	1.5	H	25.02	62.34	74	11.66
9688.00	22.02	Ave.	60	1.5	H	25.02	47.04	54	6.96
Middle Channel (2437 MHz)									
120.80	52.27	QP	165	2.0	V	-10.70	41.57	43.5	1.93
2437.00	90.43	PK	145	1.1	H	4.27	94.70	/	/
2437.00	81.20	Ave.	145	1.1	H	4.27	85.47	/	/
2437.00	97.60	PK	32	1.8	V	4.17	101.77	/	/
2437.00	93.63	Ave.	32	1.8	V	4.17	97.80	/	/
2381.44	44.23	PK	189	2.4	H	4.27	48.50	74	25.50
2381.44	27.70	Ave.	189	2.4	H	4.27	31.97	54	22.03
2492.83	41.10	PK	222	2.1	H	7.99	49.09	74	24.91
2492.83	20.52	Ave.	222	2.1	H	7.99	28.51	54	25.49
2934.85	46.57	PK	101	1.6	V	8.56	55.13	74	18.87
2934.85	41.58	Ave.	101	1.6	V	8.56	50.14	54	3.86
4874.00	46.69	PK	323	2.1	V	19.41	67.10	74	7.90
4874.00	32.96	Ave.	323	2.1	V	19.41	52.37	54	1.63
7311.00	39.59	PK	16	1.5	H	22.60	62.19	74	11.81
7311.00	22.65	Ave.	16	1.5	H	22.60	45.25	54	8.75
9748.00	37.66	PK	351	1.4	V	25.22	62.88	74	11.12
9748.00	21.90	Ave.	351	1.4	V	25.22	47.12	54	6.88

Frequency (MHz)	Receiver		Turntable Degree	Rx Antenna		Corrected Factor (dB)	Corrected Amplitude (dBµV/m)	FCC Part 15.247/205/209	
	Reading (dBµV)	Detector (PK/QP/Ave.)		Height (m)	Polar (H/V)			Limit (dBµV/m)	Margin (dB)
High Channel (2462 MHz)									
120.80	52.30	QP	64	1.3	V	-10.70	41.60	43.5	1.90
2452.00	90.75	PK	69	2.3	H	7.99	98.74	/	/
2452.00	82.53	Ave.	69	2.3	H	7.99	90.52	/	/
2452.00	98.49	PK	315	2.1	V	7.59	106.08	/	/
2452.00	92.74	Ave.	315	2.1	V	7.59	100.33	/	/
2384.95	44.19	PK	129	2.2	H	4.27	48.46	74	25.54
2384.95	29.63	Ave.	129	2.2	H	4.27	33.90	54	20.10
2499.09	41.42	PK	36	2.0	H	7.99	49.41	74	24.59
2499.09	20.52	Ave.	36	2.0	H	7.99	28.51	54	25.49
2763.17	46.06	PK	265	1.2	V	8.01	54.07	74	19.93
2763.17	42.25	Ave.	265	1.2	V	8.01	50.26	54	3.74
4904.00	45.00	PK	44	1.6	V	19.41	66.41	74	9.59
4904.00	32.69	Ave.	44	1.6	V	19.41	52.10	54	1.90
7356.00	39.38	PK	161	2.4	V	21.54	60.92	74	13.08
7356.00	21.93	Ave.	161	2.4	V	21.54	43.47	54	10.53
9808.00	36.94	PK	180	2.3	H	26.09	63.03	74	10.97
9808.00	22.41	Ave.	180	2.3	H	26.09	48.50	54	5.50

Note:

Corrected Factor = Antenna factor (RX) + Cable Loss – Amplifier Factor

Corrected Amplitude = Corrected Factor + Reading

Margin = Limit - Corrected. Amplitude

FCC §15.247(a) (2) – 6 dB EMISSION BANDWIDTH

Applicable Standard

Systems using digital modulation techniques may operate in the 902–928 MHz, 2400–2483.5 MHz, and 5725–5850 MHz bands. The minimum 6 dB bandwidth shall be at least 500 kHz.

Test Procedure

1. Check the calibration of the measuring instrument using either an internal calibrator or a known signal from an external generator.
2. Position the EUT without connection to measurement instrument. Turn on the EUT and connect it to measurement instrument. Then set it to any one convenient frequency within its operating range. Set a reference level on the measuring instrument equal to the highest peak value.
3. Measure the frequency difference of two frequencies that were attenuated 6 dB from the reference level. Record the frequency difference as the emission bandwidth.
4. Repeat above procedures until all frequencies measured were complete.

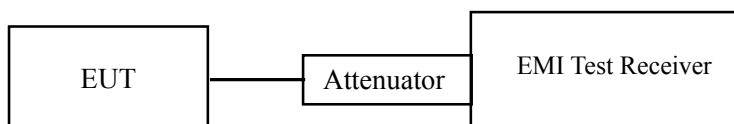

Test Equipment List and Details

Manufacturer	Description	Model	Serial Number	Calibration Date	Calibration Due Date
Rohde & Schwarz	EMI Test Receiver	ESR	1316.3003K03-101746-zn	2014-06-13	2015-06-13

* **Statement of Traceability:** Bay Area Compliance Laboratories Corp. (Shenzhen) attests that all calibrations have been performed in accordance to requirements that traceable to National Primary Standards and International System of Units (SI).

Test Data

The test data is referred to the report FR540101 with model number WUBB-743GN_WO PIN (FCC ID: ZQ6-WUBB743GN), issued on 2015-04-20 by International Certification Corp.

FCC §15.247(b) (3) - MAXIMUM CONDUCTED OUTPUT POWER

Applicable Standard

According to FCC §15.247(b) (3), for systems using digital modulation in the 902-928 MHz, 2400-2483.5 MHz, and 5725-5850 MHz bands: 1 Watt. As an alternative to a peak power measurement, compliance with the one Watt limit can be based on a measurement of the maximum conducted output power. Maximum Conducted Output Power is defined as the total transmit power delivered to all antennas and antenna elements averaged across all symbols in the signaling alphabet when the transmitter is operating at its maximum power control level. Power must be summed across all antennas and antenna elements. The average must not include any time intervals during which the transmitter is off or is transmitting at a reduced power level. If multiple modes of operation are possible (e.g., alternative modulation methods), the maximum conducted output power is the highest total transmit power occurring in any mode.

Test Procedure

1. Place the EUT on a bench and set it in transmitting mode.
2. Remove the antenna from the EUT and then connect a low loss RF cable from the antenna port to one test equipment.
3. Add a correction factor to the display.

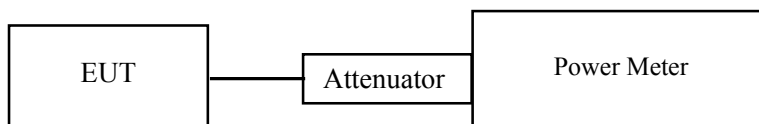

Test Equipment List and Details

Manufacturer	Description	Model	Serial Number	Calibration Date	Calibration Due Date
HP	Power Meter	N1912A	MY5000448	2014-11-03	2015-11-03
HP	Power Sensor	N1921A	MY54210016	2014-11-03	2015-11-03

* **Statement of Traceability:** Bay Area Compliance Laboratories Corp. (Shenzhen) attests that all calibrations have been performed in accordance to requirements that traceable to National Primary Standards and International System of Units (SI).

Test Data

The test data is referred to the report FR540101 with model number WUBB-743GN_WO PIN (FCC ID: ZQ6-WUBB743GN), issued on 2015-04-20 by International Certification Corp.

FCC §15.247(d) – 100 kHz BANDWIDTH OF FREQUENCY BAND EDGE

Applicable Standard

In any 100 kHz bandwidth outside the frequency band in which the spread spectrum or digitally modulated intentional radiator is operating, the radio frequency power that is produced by the intentional radiator shall be at least 20 dB below that in the 100 kHz bandwidth within the band that contains the highest level of the desired power, based on either an RF conducted or a radiated measurement, provided the transmitter demonstrates compliance with the peak conducted power limits. If the transmitter complies with the conducted power limits based on the use of RMS averaging over a time interval, as permitted under paragraph (b)(3) of this section, the attenuation required under this paragraph shall be 30 dB instead of 20 dB. Attenuation below the general limits specified in §15.209(a) is not required. In addition, radiated emissions which fall in the restricted bands, as defined in §15.205(a), must also comply with the radiated emission limits specified in §15.209(a) (see §15.205(c)).

Test Procedure

1. Check the calibration of the measuring instrument using either an internal calibrator or a known signal from an external generator.
2. Position the EUT without connection to measurement instrument. Turn on the EUT and connect its antenna terminal to measurement instrument via a low loss cable. Then set it to any one measured frequency within its operating range, and make sure the instrument is operated in its linear range.
3. Set RBW to 100 kHz and VBW of spectrum analyzer to 300 kHz with a convenient frequency span including 100 kHz bandwidth from band edge.
4. Measure the highest amplitude appearing on spectral display and set it as a reference level. Plot the graph with marking the highest point and edge frequency.
5. Repeat above procedures until all measured frequencies were complete.

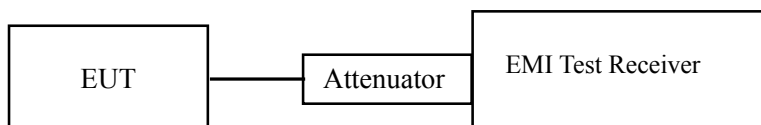

Test Equipment List and Details

Manufacturer	Description	Model	Serial Number	Calibration Date	Calibration Due Date
Rohde & Schwarz	EMI Test Receiver	ESR	1316.3003K03 -101746-zn	2014-06-13	2015-06-13

* **Statement of Traceability:** Bay Area Compliance Laboratories Corp. (Shenzhen) attests that all calibrations have been performed in accordance to requirements that traceable to National Primary Standards and International System of Units (SI).

Test Data

The test data is referred to the report FR540101 with model number WUBB-743GN_WO PIN (FCC ID: ZQ6-WUBB743GN), issued on 2015-04-20 by International Certification Corp.

FCC §15.247(e) - POWER SPECTRAL DENSITY

Applicable Standard

For digitally modulated systems, the power spectral density conducted from the intentional radiator to the antenna shall not be greater than 8 dBm in any 3 kHz band during any time interval of continuous transmission. This power spectral density shall be determined in accordance with the provisions of paragraph (b) of this section. The same method of determining the conducted output power shall be used to determine the power spectral density.

Test Procedure

According to KDB558074 D01 DTS Meas Guidance v03r02 sub-clause 10.2

1. Use this procedure when the maximum peak conducted output power in the fundamental emission is used to demonstrate compliance.
2. Set the RBW to: $3\text{kHz} \leq \text{RBW} \leq 100\text{ kHz}$.
3. Set the VBW $\geq 3 \times \text{RBW}$.
4. Set the span to 1.5 times the DTS bandwidth.
5. Detector = peak.
6. Sweep time = auto couple.
7. Trace mode = max hold.
8. Allow trace to fully stabilize.
9. Use the peak marker function to determine the maximum amplitude level within the RBW.
10. If measured value exceeds limit, reduce RBW (no less than 3 kHz) and repeat.

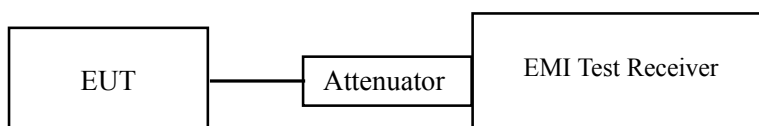

Test Equipment List and Details

Manufacturer	Description	Model	Serial Number	Calibration Date	Calibration Due Date
Rohde & Schwarz	EMI Test Receiver	ESR	1316.3003K03 -101746-zn	2014-06-13	2015-06-13

* **Statement of Traceability:** Bay Area Compliance Laboratories Corp. (Shenzhen) attests that all calibrations have been performed in accordance to requirements that traceable to National Primary Standards and International System of Units (SI).

Test Data

The test data is referred to the report FR540101 with model number WUBB-743GN_WO PIN (FCC ID: ZQ6-WUBB743GN), issued on 2015-04-20 by International Certification Corp.

PRODUCT SIMILARITY DECLARATION LETTER



ShenZhen Foscam Intelligent Technology Co.,Ltd.
5/F, Block 1, Vision Business Park, Nanshan District, Shenzhen, PRC
Tel: 86-0755-26720367-8306

2015-5-4

Product Similarity Declaration

To Whom It May Concern,

We, ShenZhen Foscam Intelligent Technology Co.,Ltd., hereby declare that we have a product named as Outdoor HD IP Camera (Model number: FI9900P) was tested by BACL, meanwhile, for our marketing purpose, we would like to list a series models (FI9900EP, FI9901EP, FI9961EP, FI9962EP, FHD955W, EF9552, FC5618EP, FHD955E, EF9553, FC5618EP, FHD956E, EF9563, FC5718EP, FHD936E, EF9363, FC6618EP, FHD937E, EF9373, FC6718EP) on reports and certificate, all the models are identical schematics, only named differently.
No other changes are made to them

We confirm that all information above is true, and we'll be responsible for all the consequences. Please contact me if you have any question.

Sincerely,

Signature

YIDONG XU

Manager

5/4.2015

***** END OF REPORT *****