

FCC PART 15.247

TEST REPORT

For

ShenZhen Foscam Intelligent Technology Co., Ltd.

5/F, Block 1, Vision Business Park, Nanshan District, Shenzhen, PRC

FCC ID: ZDEFI9828PV2

Report Type: Original Report	Product Type: HD Wireless PTZ Dome IP Camera
Test Engineer: <u>Xiangguang Kong</u>	<i>Xiangguang Kong</i>
Report Number: <u>RSZ150615013-00</u>	
Report Date: <u>2015-07-06</u>	
Reviewed By: <u>Jimmy Xiao</u> RF Engineer	<i>Jimmy Xiao</i>
Prepared By: Bay Area Compliance Laboratories Corp. (Shenzhen) 6/F, the 3rd Phase of WanLi Industrial Building ShiHua Road, FuTian Free Trade Zone Shenzhen, Guangdong, China Tel: +86-755-33320018 Fax: +86-755-33320008 www.baclcorp.com.cn	

Note: This test report is prepared for the customer shown above and for the equipment described herein. It may not be duplicated or used in part without prior written consent from Bay Area Compliance Laboratories Corp.

TABLE OF CONTENTS

GENERAL INFORMATION	3
OBJECTIVE	3
RELATED SUBMITTAL(S)/GRANT(S).....	3
TEST METHODOLOGY	3
TEST FACILITY	4
SYSTEM TEST CONFIGURATION	5
DESCRIPTION OF TEST CONFIGURATION	5
EQUIPMENT MODIFICATIONS	5
EUT EXERCISE SOFTWARE	5
SUPPORT EQUIPMENT LIST AND DETAILS	6
EXTERNAL I/O CABLE.....	6
BLOCK DIAGRAM OF TEST SETUP	7
SUMMARY OF TEST RESULTS	8
FCC §15.247 (i) & §1.1307 (b) (1) & §2.1091- MAXIMUM PERMISSIBLE EXPOSURE (MPE)	9
APPLICABLE STANDARD	9
RESULT	9
FCC §15.203 - ANTENNA REQUIREMENT	10
APPLICABLE STANDARD	10
ANTENNA CONNECTOR CONSTRUCTION	10
FCC §15.207 (a) – AC LINE CONDUCTED EMISSIONS	11
APPLICABLE STANDARD	11
MEASUREMENT UNCERTAINTY.....	11
EUT SETUP.....	11
EMI TEST RECEIVER SETUP.....	12
TEST PROCEDURE	12
TEST EQUIPMENT LIST AND DETAILS.....	12
CORRECTED FACTOR & MARGIN CALCULATION	12
TEST RESULTS SUMMARY	13
TEST DATA	13
FCC §15.209, §15.205 & §15.247(d) - SPURIOUS EMISSIONS	16
APPLICABLE STANDARD	16
MEASUREMENT UNCERTAINTY.....	16
EUT SETUP	16
EMI TEST RECEIVER & SPECTRUM ANALYZER SETUP	17
TEST PROCEDURE	17
TEST EQUIPMENT LIST AND DETAILS.....	18
CORRECTED AMPLITUDE & MARGIN CALCULATION	18
TEST RESULTS SUMMARY	18
TEST DATA	19
PRODUCT SIMILARITY DECLARATION LETTER	27

GENERAL INFORMATION

The *ShenZhen Foscam Intelligent Technology Co., Ltd*'s product, model number: *FI9828P V2 (FCC ID: ZDEFI9828PV2)* or the "EUT" in this report was a *HD Wireless PTZ Dome IP Camera*, which was measured approximately: 240 mm (L) x 140 mm (W) x 160 mm (H), rated with input voltage: DC 12V from the adapter.

Adapter Information:

Model: SAW24-120-2000

Input: 100~240V, 50~60Hz, 0.8A

Output: 12V, 2000mA

Note: This series products model: FI9828P, EH9632, HD963P, HD963P V2, HD963P V3, HD963W V2, FC8513PZ V2, FI9828P V3, HD963W V3, FC8513PZ V3, FI9828P V4, HD963W V4, FC8513PZ V4, FI9827P, HD962W, FC8413P, FI9928P, FI9928EP, FHD966P, FHD966EP, EF9661, EF9662, FC8718P, FC8718EP, FI9929P, FHD967P, EF9671, FI9929EP, FHD967EP, EF9672, FC8618P, FI9827P V2, HD962W V2, FC8413P V2, FI9928P V2, FI9928EP V2, FHD966P V2, FHD966EP V2, EF9663, EF9664, FC8718P V2, FC8718EP V2, FI9929P V2, FHD967P V2, EF9673, FC8618P V2, FI9929EP V2, FHD967EP V2, EF9674 and FI9828P V2 are identical schematics, the difference among them is just the model number due to marketing purpose, and model FI9828P V2 was selected for fully testing, the detailed information can be referred to the attached declaration letter that stated and guaranteed by the applicant.

** All measurement and test data in this report was gathered from production sample serial number: 1505421 (Assigned by BAACL, Shenzhen). The EUT supplied by the applicant was received on 2015-06-15.*

Objective

This report is prepared on behalf of *ShenZhen Foscam Intelligent Technology Co., Ltd* in accordance with Part 2-Subpart J, Part 15-Subparts A, B and C of the Federal Communication Commissions rules.

The tests were performed in order to determine compliance with FCC Part 15, Subpart C, and section 15.203, 15.205, 15.207, 15.209 and 15.247 rules.

Related Submittal(s)/Grant(s)

No related submittal(s)/grant(s)

Test Methodology

All measurements contained in this report were conducted with ANSI C63.4-2009, American National Standard for Methods of Measurement of Radio-Noise Emissions from Low-Voltage Electrical and Electronic Equipment in the range of 9 kHz to 40 GHz.

All emissions measurement was performed at Bay Area Compliance Laboratories Corp. (Shenzhen). The radiated testing was performed at an antenna-to-EUT distance of 3 meters.

Measurement uncertainty with RF radiated emission is 5.91 dB for 30MHz-1GHz and 4.92 dB for above 1GHz, 1.95dB for conducted measurement.

Test Facility

The test site used by Bay Area Compliance Laboratories Corp. (Shenzhen) to collect test data is located on the 6/F, the 3rd Phase of WanLi Industrial Building, ShiHua Road, FuTian Free Trade Zone Shenzhen, Guangdong, China.

Test site at Bay Area Compliance Laboratories Corp. (Shenzhen) has been fully described in reports submitted to the Federal Communication Commission (FCC). The details of these reports have been found to be in compliance with the requirements of Section 2.948 of the FCC Rules on December 06, 2010. The facility also complies with the radiated and AC line conducted test site criteria set forth in ANSI C63.4-2009.

The Federal Communications Commission has the reports on file and is listed under FCC Registration No.: 382179. The test site has been approved by the FCC for public use and is listed in the FCC Public Access Link (PAL) database.

SYSTEM TEST CONFIGURATION

Description of Test Configuration

For 802.11b, 802.11g and 802.11n-HT20 mode, 13 channels are provided to testing:

Channel	Frequency(MHz)	Channel	Frequency(MHz)
1	2412	8	2447
2	2417	9	2452
3	2422	10	2457
4	2427	11	2462
5	2432	12	/
6	2437	13	/
7	2442	/	/

EUT was tested with Channel 1, 6 and 11.

For 802.11n-HT40 mode, 7 channels are provided to testing:

Channel	Frequency (MHz)	Channel	Frequency (MHz)
1	2422	6	2447
2	2427	7	2452
3	2432	8	/
4	2437	9	/
5	2442	/	/

EUT was tested with Channel 1, 4 and 7.

The worst-case data rates are determined to be as follows for each mode based upon investigation by measuring the average power and PSD across all data rates bandwidths, and modulations.

Equipment Modifications

No modification was made to the EUT tested.

EUT Exercise Software

Wifi test in the default power level.

Support Equipment List and Details

Manufacturer	Description	Model	Serial Number
ECOM	Modem	56000bps	21654684
LISTED	Adapter	TYP60-1207000Z	326703
Microsoft	Keyboard	1406	0200706128743
Microsoft	Mouse	1405	0204608630856
DELL	PC	DCSCSF	127BP2X
DELL	Monitor	E178WFPC	CN-OWY564-64180-7C4-2SQH
N/A	Earphone	N/A	N/A
Kingston	USB Disk	N/A	N/A
Sagemcom	Router	N/A	N/A
Sagemcom	Router	N/A	32546

External I/O Cable

Cable Description	Length (m)	From Port	To
Un-shielded Detachable AC Cable	1.5	Monitor	Mains
Shielded Detachable VGA Cable	1.5	PC	Monitor
Un-shielded Detachable AC Cable	1.5	PC	Mains
Un-shielded Detachable RS232 Cable	1.8	PC	Modem
Un-shielded Un-detachable DC Cable	1.7	Modem	Adapter
Un-shielded Un-detachable DC Cable	1.2	Router	Adapter
Un-shielded Detachable AC Cable	1.6	Adapter	Mains
Shielded Un-detachable USB Cable	1.5	Keyboard	PC
Shielded Un-detachable USB Cable	1.5	Mouse	PC
Un-shielded Detachable RJ 45 Cable	0.5	EUT	CAT 5
Un-shielded Detachable RJ 45 Cable	1.5	Router	CAT 5
Un-shielded Detachable RJ 45 Cable	10.0	EUT	Router
Un-shielded Detachable RJ 45 Cable	1.5	Router	PC
Un-shielded Detachable RJ 45 Cable	10.0	EUT	PC
Shielded Un-detachable Audio Cable	0.5	EUT	Headphone

Block Diagram of Test Setup

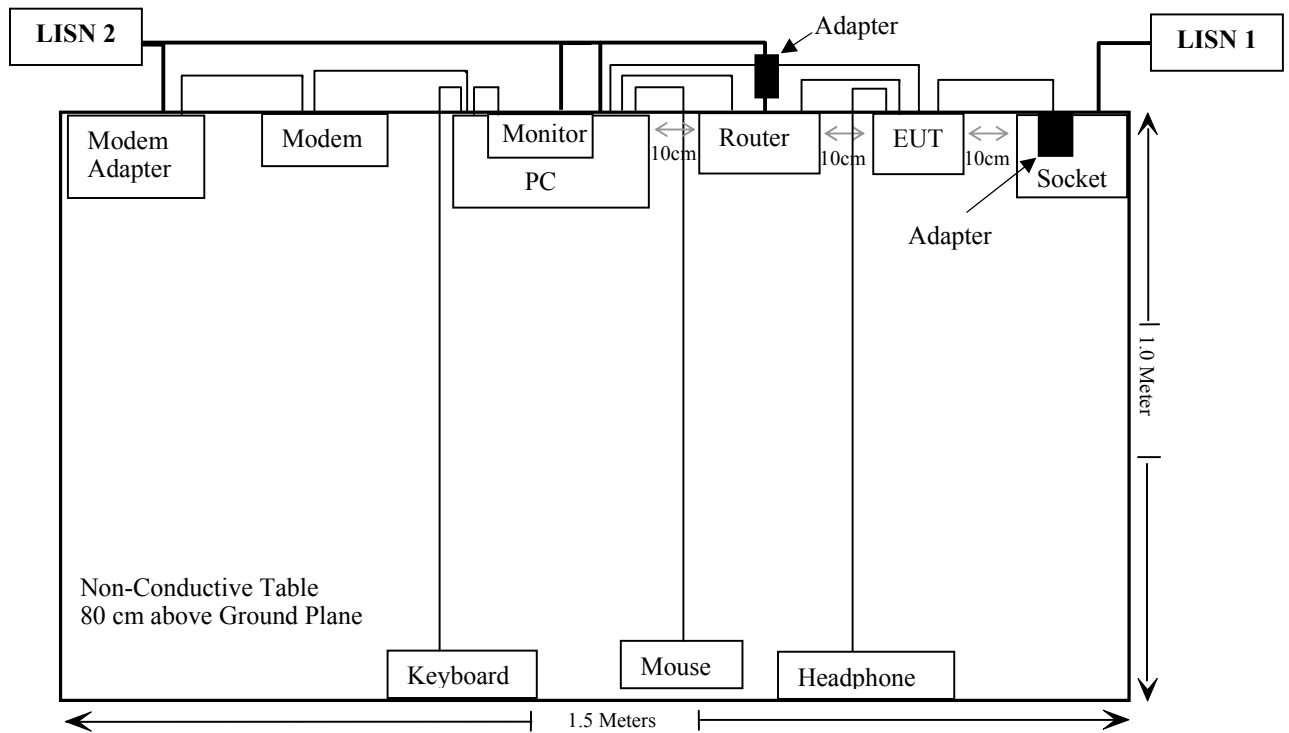

SUMMARY OF TEST RESULTS

FCC Rules	Description of Test	Result
§15.247 (i), §1.1307 (b) (1)& §2.1091	Maximum Permissible Exposure(MPE)	Compliance
§15.203	Antenna Requirement	Compliance
§15.207 (a)	AC Line Conducted Emissions	Compliance
§15.247(d)	Spurious Emissions at Antenna Port	Compliance*
§15.205, §15.209, §15.247(d)	Spurious Emissions	Compliance
§15.247 (a)(2)	6 dB Emission Bandwidth	Compliance*
§15.247(b)(3)	Maximum Conducted Output Power	Compliance*
§15.247(d)	100 kHz Bandwidth of Frequency Band Edge	Compliance*
§15.247(e)	Power Spectral Density	Compliance*

Compliance*: the EUT (Model: FI9828P V2, FCC ID: ZDEFI9828PV2) has used a certified module with model FR1213C3 (FCC ID: Q8Y-FR1213C3), the different test data between them are “§15.207 (a) AC Line Conducted Emissions” and “§15.205, §15.209, §15.247(d) Spurious Emissions”, so all the other test data are referred to the report KSZ2013053101J01 with model number FR1213C3 (FCC ID: Q8Y-FR1213C3), issued on 2013-08-19 by Ke Mei Ou Laboratory Co., Ltd.

FCC §15.247 (i) & §1.1307 (b) (1) & §2.1091- MAXIMUM PERMISSIBLE EXPOSURE (MPE)

Applicable Standard

According to subpart 15.247 (i) and subpart 1.1307 (b)(1), 2.1091 systems operating under the provisions of this section shall be operated in a manner that ensures the public is not exposed to RF energy level in excess of the communication guidelines.

Limits for General Population/Uncontrolled Exposure

Limits for General Population/Uncontrolled Exposure				
Frequency Range (MHz)	Electric Field Strength (V/m)	Magnetic Field Strength (A/m)	Power Density (mW/cm ²)	Averaging Time (Minutes)
0.3-1.34	614	1.63	*(100)	30
1.34-30	824/f	2.19/f	*(180/f ²)	30
30-300	27.5	0.073	0.2	30
300-1500	/	/	f/1500	30
1500-100,000	/	/	1.0	30

f = frequency in MHz

* = Plane-wave equivalent power density

Result

Calculated Formulary:

Predication of MPE limit at a given distance

$$S = \frac{PG}{4\pi R^2}$$

S = power density (in appropriate units, e.g. mW/cm²)

P = power input to the antenna (in appropriate units, e.g., mW).

G = power gain of the antenna in the direction of interest relative to an isotropic radiator, the power gain factor, is normally numeric gain.

R = distance to the center of radiation of the antenna (appropriate units, e.g., cm)

Frequency (MHz)	Antenna Gain		Conducted Power		Evaluation Distance (cm)	Power Density (mW/cm ²)	MPE Limit (mW/cm ²)
	(dBi)	(numeric)	(dBm)	(mW)			
2412	2	1.58	15.33	34.12	20	0.0107	1

Note: To maintain compliance with the FCC’s RF exposure guidelines, place the equipment at least 20cm from nearby persons.

Result: Compliance

FCC §15.203 - ANTENNA REQUIREMENT

Applicable Standard

According to § 15.203, an intentional radiator shall be designed to ensure that no antenna other than that furnished by the responsible party shall be used with the device. The use of a permanently attached antenna or of an antenna that uses a unique coupling to the intentional radiator shall be considered sufficient to comply with the provisions of this section. The manufacturer may design the unit so that a broken antenna can be replaced by the user, but the user of a standard antenna jack or electrical connector is prohibited. The structure and application of the EUT were analyzed to determine compliance with section §15.203 of the rules. §15.203 state that the subject device must meet the following criteria:

- a. Antenna must be permanently attached to the unit.
- b. Antenna must use a unique type of connector to attach to the EUT.

Unit must be professionally installed, and installer shall be responsible for verifying that the correct antenna is employed with the unit.

And according to FCC 47 CFR section 15.247 (b), if the transmitting antennas of directional gain greater than 6dBi are used, the power shall be reduced by the amount in dB that the directional gain of the antenna exceeds 6 dBi.

Antenna Connector Construction

The EUT has RP-SMA antenna connector arrangement for Wi-Fi which the gain was 2.0dBi, fulfill the requirement of this section. Please refer to the EUT photos.

Result: Compliance.

FCC §15.207 (a) – AC LINE CONDUCTED EMISSIONS

Applicable Standard

FCC§15.207

Measurement Uncertainty

Input quantities to be considered for conducted disturbance measurements may be receiver reading, attenuation of the connection between LISN and receiver, LISN voltage division factor, LISN VDF frequency interpolation and receiver related input quantities, etc.

Based on CISPR 16-4-2:2011, the expanded combined standard uncertainty of conducted disturbance test at Bay Area Compliance Laboratories Corp. (Shenzhen) is shown as below. And the uncertainty will not be taken into consideration for the test data recorded in the report.

Port	Expanded Measurement uncertainty
AC Mains	3.26 dB (k=2, 95% level of confidence)
CAT 3	3.70 dB (k=2, 95% level of confidence)
CAT 5	3.86 dB (k=2, 95% level of confidence)
CAT 6	4.64 dB (k=2, 95% level of confidence)

EUT Setup

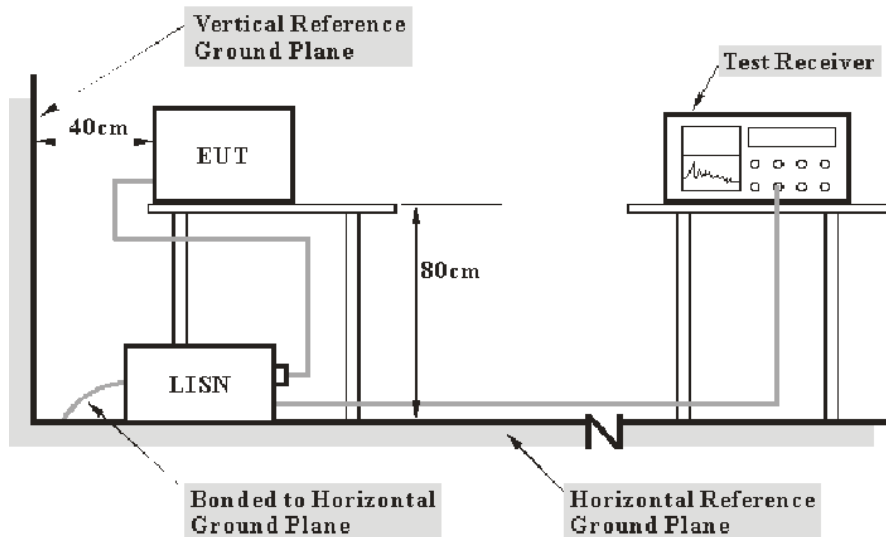

- Note: 1. Support units were connected to second LISN.
 2. Both of LISNs (AMN) 80 cm from EUT and at the least 80 cm from other units and other metal planes support units.

The setup of EUT is according with per ANSI C63.4-2009 measurement procedure. The specification used was with the FCC Part 15.207 limits.

The adapter was connected to a 120 VAC/60 Hz power source.

EMI Test Receiver Setup

The EMI test receiver was set to investigate the spectrum from 150 kHz to 30 MHz.

During the conducted emission test, the EMI test receiver was set with the following configurations:

Frequency Range	IF B/W
150 kHz – 30 MHz	9 kHz

Test Procedure

During the conducted emission test, the host PC was connected to the outlet of the LISN, the other related equipments were connected to the other LISN.

Maximizing procedure was performed on the six (6) highest emissions of the EUT.

All final data was recorded in the Quasi-peak and average detection mode.

Test Equipment List and Details

Manufacturer	Description	Model	Serial Number	Calibration Date	Calibration Due Date
Rohde & Schwarz	EMI Test Receiver	ESCS30	100176	2015-06-03	2016-06-03
Rohde & Schwarz	LISN	ESH2-Z5	892107/021	2014-08-22	2015-08-22
Rohde & Schwarz	LISN	ENV216	3560.6650.12-101613-Yb	2014-12-01	2015-12-01
Rohde & Schwarz	Transient Limiter	ESH3Z2	DE25985	2014-10-15	2015-10-15
Rohde & Schwarz	CE Test software	EMC 32	V8.53	NCR	NCR

* **Statement of Traceability:** Bay Area Compliance Laboratories Corp. (Shenzhen) attests that all calibrations have been performed in accordance to requirements that traceable to National Primary Standards and International System of Units (SI).

Corrected Factor & Margin Calculation

The Corrected factor is calculated by adding LISN VDF (Voltage Division Factor), Cable Loss and Transient Limiter Attenuation. The basic equation is as follows:

$$\text{Correction Factor} = \text{LISN VDF} + \text{Cable Loss} + \text{Transient Limiter Attenuation}$$

The “**Margin**” column of the following data tables indicates the degree of compliance with the applicable limit. For example, a margin of 7 dB means the emission is 7 dB below the limit. The equation for margin calculation is as follows:

$$\text{Margin} = \text{Limit} - \text{Corrected Amplitude}$$

Test Results Summary

According to the recorded data in following table, the EUT complied with the FCC Part 15.207, the worst margin reading as below:

9.0 dB at 0.154500 MHz in the Line conducted mode

Refer to CISPR16-4-2:2011 and CISPR 16-4-1:2009, the measured level complies with the limit if

$$L_m + U_{(L_m)} \leq L_{lim} + U_{cispr}$$

In BACL, $U_{(L_m)}$ is less than U_{cispr} , if L_m is less than L_{lim} , it implies that the EUT complies with the limit.

Test Data

Environmental Conditions

Temperature:	28 °C
Relative Humidity:	45 %
ATM Pressure:	101.0 kPa

The testing was performed by Xiangguang Kong on 2015-06-23.

EUT operation mode: Transmitting

AC 120V/60 Hz, Line

EMI Auto Test L

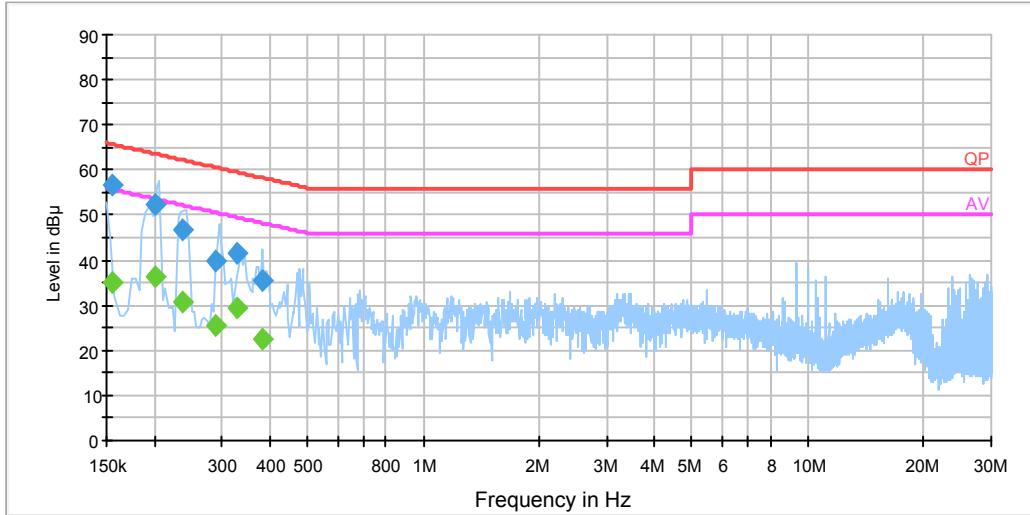

Frequency (MHz)	Corrected Amplitude (dBµV)	Correction Factor (dB)	Limit (dBµV)	Margin (dB)	Detector (PK/Ave./QP)
0.154500	56.8	20.0	65.8	9.0	QP
0.154500	35.2	20.0	55.8	20.6	Ave.
0.201500	52.3	20.0	63.5	11.2	QP
0.201500	36.4	20.0	53.5	17.1	Ave.
0.237500	46.6	20.0	62.2	15.6	QP
0.237500	30.9	20.0	52.2	21.3	Ave.
0.289500	39.8	19.9	60.5	20.7	QP
0.289500	25.5	19.9	50.5	25.0	Ave.
0.328990	41.7	19.9	59.5	17.8	QP
0.328990	29.6	19.9	49.5	19.9	Ave.
0.380270	35.5	19.9	58.3	22.8	QP
0.380270	22.7	19.9	48.3	25.6	Ave.

AC 120V/60 Hz, Neutral

EMI Auto Test N

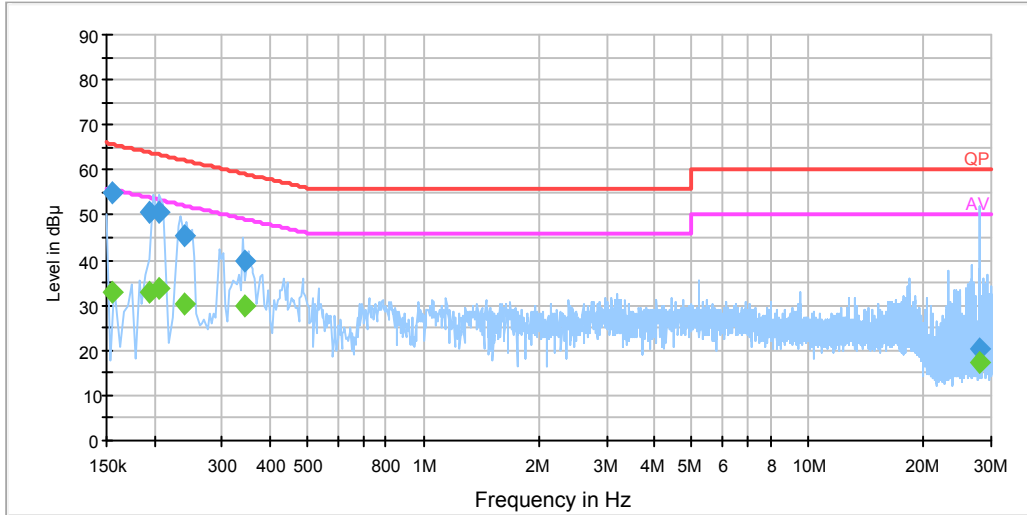

Frequency (MHz)	Corrected Amplitude (dBµV)	Correction Factor (dB)	Limit (dBµV)	Margin (dB)	Detector (PK/Ave./QP)
0.154500	55.0	20.0	65.8	10.8	QP
0.154500	33.1	20.0	55.8	22.7	Ave.
0.193500	50.7	20.0	63.9	13.2	QP
0.193500	32.8	20.0	53.9	21.1	Ave.
0.205500	50.6	20.0	63.4	12.8	QP
0.205500	33.8	20.0	53.4	19.6	Ave.
0.238500	45.5	20.0	62.1	16.6	QP
0.238500	30.1	20.0	52.1	22.0	Ave.
0.343070	40.0	19.9	59.1	19.1	QP
0.343070	29.8	19.9	49.1	19.3	Ave.
28.110390	20.5	20.2	60.0	39.5	QP
28.110390	17.2	20.2	50.0	32.8	Ave.

Note:

- 1) Correction Factor = LISN VDF (Voltage Division Factor) + Cable Loss + Transient Limiter Attenuation
- 2) Corrected Amplitude = Reading + Correction Factor
- 3) Margin = Limit - Corrected Amplitude

FCC §15.209, §15.205 & §15.247(d) - SPURIOUS EMISSIONS

Applicable Standard

FCC §15.247 (d); §15.209; §15.205;

Measurement Uncertainty

All measurements involve certain levels of uncertainties, especially in field of EMC. The factors contributing to uncertainties are spectrum analyzer, cable loss, antenna factor calibration, antenna directivity, antenna factor variation with height, antenna phase center variation, antenna factor frequency interpolation, measurement distance variation, site imperfections, mismatch (average), and system repeatability.

Based on CISPR 16-4-2:2011, the expanded combined standard uncertainty of radiation emissions at Bay Area Compliance Laboratories Corp. (Shenzhen) is 5.91 dB for 30MHz-1GHz and 4.92 dB for above 1GHz, 1.95dB for conducted measurement at antenna port. And the uncertainty will not be taken into consideration for the test data recorded in the report

EUT Setup

Below 1 GHz:

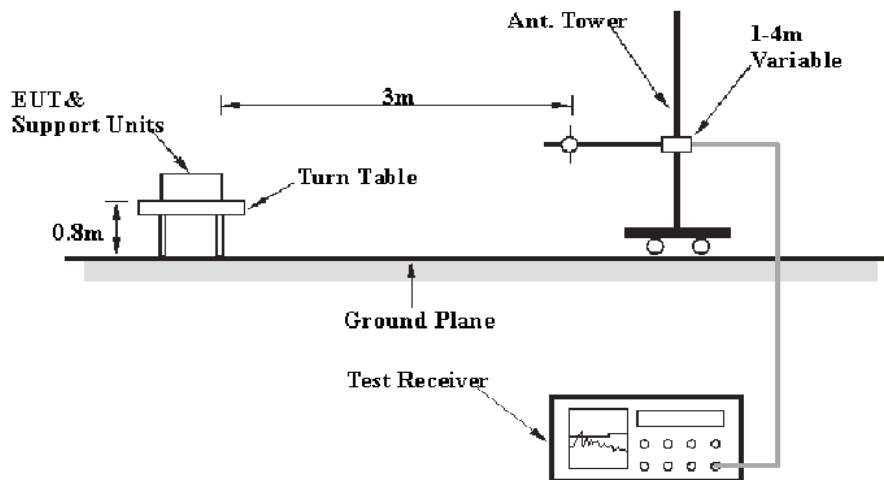

Above 1GHz:

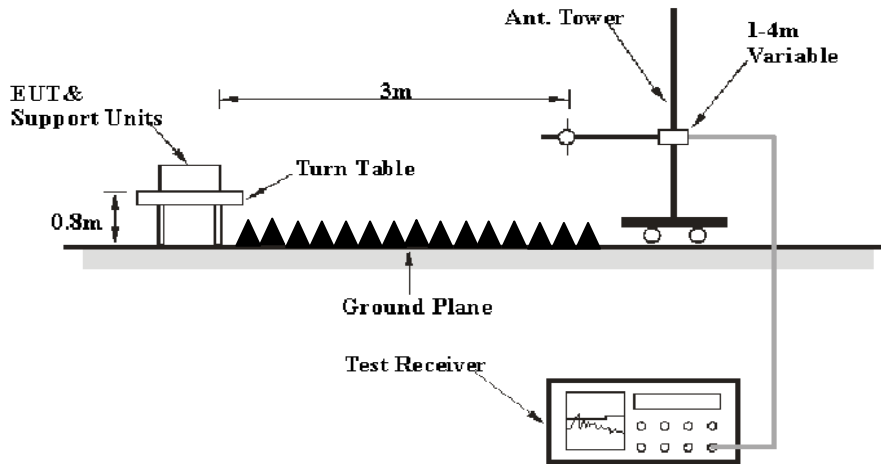

The radiated emission tests were performed in the 3 meters test site, using the setup accordance with the ANSI C63.4-2009. The specification used was the FCC 15.209, and FCC 15.247 limits.

The adapter was connected to a 120 VAC/60 Hz power source.

EMI Test Receiver & Spectrum Analyzer Setup

The system was investigated from 30 MHz to 25 GHz.

During the radiated emission test, the EMI test receiver & Spectrum Analyzer Setup were set with the following configurations:

Frequency Range	RBW	Video B/W	IF B/W	Detector
30 MHz – 1000 MHz	100 kHz	300 kHz	120 kHz	QP
Above 1 GHz	1MHz	3 MHz	/	PK
	1MHz	10 Hz	/	Ave.

Test Procedure

Maximizing procedure was performed on the highest emissions to ensure that the EUT complied with all installation combinations.

Data was recorded in Quasi-peak detection mode for frequency range of 30 MHz-1 GHz, peak and Average detection modes for frequencies above 1 GHz.

Test Equipment List and Details

Manufacturer	Description	Model	Serial Number	Calibration Date	Calibration Due Date
HP	Amplifier	HP8447E	1937A01046	2015-05-06	2016-05-06
Rohde & Schwarz	EMI Test Receiver	ESCI	101120	2014-11-03	2015-11-03
Sunol Sciences	Bi-log Antenna	JB1	A040904-2	2014-12-07	2017-12-06
Mini	Amplifier	ZVA-183-S+	5969001149	2015-04-23	2016-04-23
A.H. System	Horn Antenna	SAS-200/571	135	2015-02-10	2016-02-10
Rohde & Schwarz	Signal Analyzer	FSIQ26	8386001028	2014-12-11	2015-12-11
the electro-Mechanics Co.	Horn Antenna	3116	9510-2270	2013-10-14	2016-10-13
TDK	Chamber	Chamber A	2#	2012-10-15	2015-10-15
TDK	Chamber	Chamber B	1#	2014-07-22	2015-07-22
DUCOMMUN	Pre-amplifier	ALN-22093530-01	991373-01	2014-08-03	2015-08-03
R&S	Auto test Software	EMC32	V9.10	NCR	NCR

* **Statement of Traceability:** Bay Area Compliance Laboratories Corp. (Shenzhen) attests that all calibrations have been performed in accordance to requirements that traceable to National Primary Standards and International System of Units (SI).

Corrected Amplitude & Margin Calculation

The Corrected Amplitude is calculated by adding the Antenna Factor and Cable Loss, and subtracting the Amplifier Gain from the Meter Reading. The basic equation is as follows:

$$\text{Corrected Amplitude} = \text{Meter Reading} + \text{Antenna Factor} + \text{Cable Loss} - \text{Amplifier Gain}$$

The “**Margin**” column of the following data tables indicates the degree of compliance with the applicable limit. For example, a margin of 7dB means the emission is 7dB below the limit. The equation for margin calculation is as follows:

$$\text{Margin} = \text{Limit} - \text{Corrected Amplitude}$$

Test Results Summary

According to the recorded data in following table, the EUT complied with the FCC Title 47, Part 15, Subpart C, section 15.205, 15.209 and 15.247.

4.71 dB at 2390.00 MHz in the Vertical polarization for 802.11n-HT40 Mode Low channel

Refer to CISPR16-4-2:2011 and CISPR 16-4-1:2009, the measured level complies with the limit if

$$L_m + U_{(L_m)} \leq L_{lim} + U_{cispr}$$

In BACL, $U_{(L_m)}$ is less than U_{cispr} , if L_m is less than L_{lim} , it implies that the EUT complies with the limit.

Test Data**Environmental Conditions**

Temperature:	28 °C
Relative Humidity:	45 %
ATM Pressure:	101.0 kPa

The testing was performed by Xiangguang Kong on 2015-07-01.

EUT operation mode: Transmitting

30 MHz-25 GHz:**802.11b Mode:**

Frequency (MHz)	Receiver		Turntable Degree	Rx Antenna		Corrected Factor (dB)	Corrected Amplitude (dB μ V/m)	FCC Part 15.247/205/209	
	Reading (dB μ V)	Detector (PK/QP/Ave.)		Height (m)	Polar (H/V)			Limit (dB μ V/m)	Margin (dB)
Low Channel (2412 MHz)									
250.12	46.77	QP	126	1.2	H	-14.6	32.17	46	13.83
2412.00	100.18	PK	134	1.9	H	4.27	104.45	/	/
2412.00	89.93	Ave.	134	1.9	H	4.27	94.20	/	/
2412.00	101.22	PK	259	2.2	V	4.17	105.39	/	/
2412.00	91.08	Ave.	259	2.2	V	4.17	95.25	/	/
2386.15	54.92	PK	242	1.2	V	4.17	59.09	74	14.91
2386.15	35.52	Ave.	242	1.2	V	4.17	39.69	54	14.31
2390.00	54.96	PK	91	1.5	V	4.17	59.13	74	14.87
2390.00	36.43	Ave.	91	1.5	V	4.17	40.60	54	13.40
2484.16	50.17	PK	294	1.2	V	7.59	57.76	74	16.24
2484.16	30.41	Ave.	294	1.2	V	7.59	38.00	54	16.00
4824.00	39.76	PK	228	2.3	H	14.21	53.97	74	20.03
4824.00	25.16	Ave.	228	2.3	H	14.21	39.37	54	14.63
7236.00	38.17	PK	58	2.0	V	20.60	58.77	74	15.23
7236.00	23.10	Ave.	58	2.0	V	20.60	43.70	54	10.30
9648.00	34.38	PK	78	1.5	H	24.84	59.22	74	14.78
9648.00	19.74	Ave.	78	1.5	H	24.84	44.58	54	9.42

Frequency (MHz)	Receiver		Turntable Degree	Rx Antenna		Corrected Factor (dB)	Corrected Amplitude (dBµV/m)	FCC Part 15.247/205/209	
	Reading (dBµV)	Detector (PK/QP/Ave.)		Height (m)	Polar (H/V)			Limit (dBµV/m)	Margin (dB)
Middle Channel (2437 MHz)									
250.12	47.03	QP	165	2.4	H	-14.6	32.43	46	13.57
2437.00	99.85	PK	294	1.4	H	4.27	104.12	/	/
2437.00	89.92	Ave.	294	1.4	H	4.27	94.19	/	/
2437.00	100.51	PK	88	2.0	V	4.17	104.68	/	/
2437.00	90.12	Ave.	88	2.0	V	4.17	94.29	/	/
2387.75	51.73	PK	343	1.2	V	4.17	55.90	74	18.10
2387.75	32.00	Ave.	343	1.2	V	4.17	36.17	54	17.83
2381.18	51.78	PK	107	1.2	V	4.17	55.95	74	18.05
2381.18	32.00	Ave.	107	1.2	V	4.17	36.17	54	17.83
2483.50	49.11	PK	189	2.2	V	7.59	56.70	74	17.30
2483.50	30.41	Ave.	189	2.2	V	7.59	38.00	54	16.00
4874.00	39.27	PK	119	1.9	V	14.99	54.26	74	19.74
4874.00	25.44	Ave.	119	1.9	V	14.99	40.43	54	13.57
7311.00	37.39	PK	246	1.6	V	20.92	58.31	74	15.69
7311.00	22.74	Ave.	246	1.6	V	20.92	43.66	54	10.34
9748.00	34.98	PK	150	1.5	V	25.04	60.02	74	13.98
9748.00	19.97	Ave.	150	1.5	V	25.04	45.01	54	8.99
High Channel (2462 MHz)									
250.12	46.32	QP	83	1.2	H	-14.6	31.72	46	14.28
2462.00	98.61	PK	357	1.2	H	7.99	106.60	/	/
2462.00	88.56	Ave.	357	1.2	H	7.99	96.55	/	/
2462.00	99.57	PK	169	1.9	V	7.59	107.16	/	/
2462.00	89.67	Ave.	169	1.9	V	7.59	97.26	/	/
2386.79	51.93	PK	335	1.1	V	4.17	56.10	74	17.90
2386.79	32.00	Ave.	335	1.1	V	4.17	36.17	54	17.83
2488.06	52.35	PK	288	1.5	V	7.59	59.94	74	14.06
2488.06	32.00	Ave.	288	1.5	V	7.59	39.59	54	14.41
2492.19	51.94	PK	188	1.8	V	7.59	59.53	74	14.47
2492.19	30.41	Ave.	188	1.8	V	7.59	38.00	54	16.00
4924.00	39.58	PK	168	1.0	H	14.79	54.37	74	19.63
4924.00	25.79	Ave.	168	1.0	H	14.79	40.58	54	13.42
7386.00	38.03	PK	21	2.4	H	21.21	59.24	74	14.76
7386.00	22.06	Ave.	21	2.4	H	21.21	43.27	54	10.73
9848.00	34.42	PK	281	2.0	H	25.90	60.32	74	13.68
9848.00	19.51	Ave.	281	2.0	H	25.90	45.41	54	8.59

802.11g Mode:

Frequency (MHz)	Receiver		Turntable Degree	Rx Antenna		Corrected Factor (dB)	Corrected Amplitude (dBµV/m)	FCC Part 15.247/205/209	
	Reading (dBµV)	Detector (PK/QP/Ave.)		Height (m)	Polar (H/V)			Limit (dBµV/m)	Margin (dB)
Low Channel (2412 MHz)									
250.12	46.96	QP	69	2.2	H	-14.6	32.36	46	13.64
2412.00	98.02	PK	185	1.4	H	4.27	102.29	/	/
2412.00	81.06	Ave.	185	1.4	H	4.27	85.33	/	/
2412.00	98.33	PK	153	1.3	V	4.17	102.50	/	/
2412.00	81.28	Ave.	153	1.3	V	4.17	85.45	/	/
2390.00	59.32	PK	21	1.2	V	4.17	63.49	74	10.51
2390.00	36.43	Ave.	21	1.2	V	4.17	40.60	54	13.40
2385.51	53.88	PK	223	2.2	V	4.17	58.05	74	15.95
2385.51	32.00	Ave.	223	2.2	V	4.17	36.17	54	17.83
2485.18	51.39	PK	34	2.2	V	7.59	58.98	74	15.02
2485.18	30.41	Ave.	34	2.2	V	7.59	38.00	54	16.00
4824.00	38.93	PK	319	1.0	H	14.21	53.14	74	20.86
4824.00	23.22	Ave.	319	1.0	H	14.21	37.43	54	16.57
7236.00	36.34	PK	96	1.7	H	20.60	56.94	74	17.06
7236.00	21.68	Ave.	96	1.7	H	20.60	42.28	54	11.72
9648.00	33.70	PK	272	1.0	H	24.84	58.54	74	15.46
9648.00	19.44	Ave.	272	1.0	H	24.84	44.28	54	9.72
Middle Channel (2437 MHz)									
250.12	47.11	QP	32	2.5	H	-14.6	32.51	46	13.49
2437.00	96.32	PK	109	1.7	H	4.27	100.59	/	/
2437.00	79.66	Ave.	109	1.7	H	4.27	83.93	/	/
2437.00	96.77	PK	206	2.2	V	4.17	100.94	/	/
2437.00	79.92	Ave.	206	2.2	V	4.17	84.09	/	/
2390.00	50.84	PK	110	1.4	V	4.17	55.01	74	18.99
2390.00	32.00	Ave.	110	1.4	V	4.17	36.17	54	17.83
2378.13	51.28	PK	65	2.3	V	4.17	55.45	74	18.55
2378.13	30.41	Ave.	65	2.3	V	4.17	34.58	54	19.42
2499.27	50.73	PK	4	1.8	V	7.59	58.32	74	15.68
2499.27	30.41	Ave.	4	1.8	V	7.59	38.00	54	16.00
4874.00	38.08	PK	302	2.1	V	14.99	53.07	74	20.93
4874.00	24.36	Ave.	302	2.1	V	14.99	39.35	54	14.65
7311.00	37.10	PK	210	2.1	H	20.92	58.02	74	15.98
7311.00	21.79	Ave.	210	2.1	H	20.92	42.71	54	11.29
9748.00	33.29	PK	224	1.5	V	25.04	58.33	74	15.67
9748.00	18.29	Ave.	224	1.5	V	25.04	43.33	54	10.67

Frequency (MHz)	Receiver		Turntable Degree	Rx Antenna		Corrected Factor (dB)	Corrected Amplitude (dBµV/m)	FCC Part 15.247/205/209	
	Reading (dBµV)	Detector (PK/QP/Ave.)		Height (m)	Polar (H/V)			Limit (dBµV/m)	Margin (dB)
High Channel (2462 MHz)									
250.12	46.55	QP	179	2.3	H	-14.6	31.95	46	14.05
2462.00	95.27	PK	64	1.9	H	7.99	103.26	/	/
2462.00	79.22	Ave.	64	1.9	H	7.99	87.21	/	/
2462.00	95.82	PK	124	1.0	V	7.59	103.41	/	/
2462.00	79.32	Ave.	124	1.0	V	7.59	86.91	/	/
2373.48	50.69	PK	322	2.3	V	4.17	54.86	74	19.14
2373.48	30.41	Ave.	322	2.3	V	4.17	34.58	54	19.42
2484.06	55.75	PK	100	1.9	V	7.59	63.34	74	10.66
2484.06	32.00	Ave.	100	1.9	V	7.59	39.59	54	14.41
2488.09	51.64	PK	298	2.5	V	7.59	59.23	74	14.77
2488.09	30.41	Ave.	298	2.5	V	7.59	38.00	54	16.00
4924.00	38.73	PK	108	2.3	V	14.99	53.72	74	20.28
4924.00	25.29	Ave.	108	2.3	V	14.99	40.28	54	13.72
7386.00	36.89	PK	207	1.0	V	21.21	58.10	74	15.90
7386.00	22.39	Ave.	207	1.0	V	21.21	43.60	54	10.40
9848.00	33.13	PK	70	1.1	V	26.10	59.23	74	14.77
9848.00	18.60	Ave.	70	1.1	V	26.10	44.70	54	9.30

802.11n-HT20 Mode:

Frequency (MHz)	Receiver		Turntable Degree	Rx Antenna		Corrected Factor (dB)	Corrected Amplitude (dBµV/m)	FCC Part 15.247/205/209	
	Reading (dBµV)	Detector (PK/QP/Ave.)		Height (m)	Polar (H/V)			Limit (dBµV/m)	Margin (dB)
Low Channel (2412 MHz)									
250.12	46.17	QP	163	2.3	H	-14.6	31.57	46	14.43
2412.00	96.43	PK	333	2.3	H	4.27	100.70	/	/
2412.00	80.17	Ave.	333	2.3	H	4.27	84.44	/	/
2412.00	97.26	PK	67	1.2	V	4.17	101.43	/	/
2412.00	81.16	Ave.	67	1.2	V	4.17	85.33	/	/
2390.00	62.16	PK	198	2.0	V	4.17	66.33	74	7.67
2390.00	37.26	Ave.	198	2.0	V	4.17	41.43	54	12.57
2386.47	56.01	PK	235	1.9	V	4.17	60.18	74	13.82
2386.47	33.34	Ave.	235	1.9	V	4.17	37.51	54	16.49
2498.41	50.55	PK	78	2.0	V	7.59	58.14	74	15.86
2498.41	30.41	Ave.	78	2.0	V	7.59	38.00	54	16.00
4824.00	38.50	PK	318	1.2	V	14.21	52.71	74	21.29
4824.00	23.88	Ave.	318	1.2	V	14.21	38.09	54	15.91
7236.00	37.85	PK	331	1.8	V	20.60	58.45	74	15.55
7236.00	21.93	Ave.	331	1.8	V	20.60	42.53	54	11.47
9648.00	33.16	PK	264	2.3	V	24.84	58.00	74	16.00
9648.00	18.19	Ave.	264	2.3	V	24.84	43.03	54	10.97
Middle Channel (2437 MHz)									
250.12	46.32	QP	46	1.4	H	-14.6	31.72	46	14.28
2437.00	95.10	PK	152	1.2	H	4.27	99.37	/	/
2437.00	79.10	Ave.	152	1.2	H	4.27	83.37	/	/
2437.00	96.46	PK	237	1.7	V	4.17	100.63	/	/
2437.00	80.42	Ave.	237	1.7	V	4.17	84.59	/	/
2368.99	50.53	PK	276	1.5	V	4.17	54.70	74	19.30
2368.99	30.41	Ave.	276	1.5	V	4.17	34.58	54	19.42
2388.07	51.38	PK	322	1.1	V	4.17	55.55	74	18.45
2388.07	32.00	Ave.	322	1.1	V	4.17	36.17	54	17.83
2489.91	50.13	PK	61	1.2	V	7.59	57.72	74	16.28
2489.91	30.41	Ave.	61	1.2	V	7.59	38.00	54	16.00
4874.00	38.02	PK	140	1.8	H	14.79	52.81	74	21.19
4874.00	24.47	Ave.	140	1.8	H	14.79	39.26	54	14.74
7311.00	36.55	PK	15	1.1	V	20.92	57.47	74	16.53
7311.00	21.66	Ave.	15	1.1	V	20.92	42.58	54	11.42
9748.00	33.18	PK	60	1.2	V	25.04	58.22	74	15.78
9748.00	18.12	Ave.	60	1.2	V	25.04	43.16	54	10.84

Frequency (MHz)	Receiver		Turntable Degree	Rx Antenna		Corrected Factor (dB)	Corrected Amplitude (dBµV/m)	FCC Part 15.247/205/209	
	Reading (dBµV)	Detector (PK/QP/Ave.)		Height (m)	Polar (H/V)			Limit (dBµV/m)	Margin (dB)
High Channel (2462 MHz)									
250.12	46.47	QP	27	1.8	H	-14.6	31.87	46	14.13
2462.00	94.61	PK	68	1.7	H	7.99	102.60	/	/
2462.00	78.06	Ave.	68	1.7	H	7.99	86.05	/	/
2462.00	95.46	PK	179	1.0	V	7.59	103.05	/	/
2462.00	78.60	Ave.	179	1.0	V	7.59	86.19	/	/
2388.39	50.74	PK	56	2.3	V	4.17	54.91	74	19.09
2388.39	32.00	Ave.	56	2.3	V	4.17	36.17	54	17.83
2483.59	56.15	PK	327	1.1	V	7.59	63.74	74	10.26
2483.59	32.00	Ave.	327	1.1	V	7.59	39.59	54	14.41
2486.21	53.31	PK	214	1.9	V	7.59	60.90	74	13.10
2486.21	30.41	Ave.	214	1.9	V	7.59	38.00	54	16.00
4924.00	39.22	PK	67	2.4	H	14.79	54.01	74	19.99
4924.00	24.96	Ave.	67	2.4	H	14.79	39.75	54	14.25
7386.00	36.53	PK	116	2.3	V	21.21	57.74	74	16.26
7386.00	22.47	Ave.	116	2.3	V	21.21	43.68	54	10.32
9848.00	33.57	PK	43	1.6	V	26.10	59.67	74	14.33
9848.00	18.74	Ave.	43	1.6	V	26.10	44.84	54	9.16

802.11n-HT40 Mode:

Frequency (MHz)	Receiver		Turntable Degree	Rx Antenna		Corrected Factor (dB)	Corrected Amplitude (dBµV/m)	FCC Part 15.247/205/209	
	Reading (dBµV)	Detector (PK/QP/Ave.)		Height (m)	Polar (H/V)			Limit (dBµV/m)	Margin (dB)
Low Channel (2422 MHz)									
250.12	46.34	QP	134	2.4	H	-14.6	31.74	46	14.26
2422.00	93.35	PK	342	1.3	H	4.27	97.62	/	/
2422.00	75.83	Ave.	342	1.3	H	4.27	80.10	/	/
2422.00	93.98	PK	36	2.1	V	4.17	98.15	/	/
2422.00	76.70	Ave.	36	2.1	V	4.17	80.87	/	/
2390.00	65.12	PK	2	1.2	V	4.17	69.29	74	4.71
2390.00	39.96	Ave.	2	1.2	V	4.17	44.13	54	9.87
2382.94	64.33	PK	158	1.3	V	4.17	68.50	74	5.50
2382.94	37.26	Ave.	158	1.3	V	4.17	41.43	54	12.57
2487.73	50.79	PK	131	2.1	V	7.59	58.38	74	15.62
2487.73	30.41	Ave.	131	2.1	V	7.59	38.00	54	16.00
4844.00	38.41	PK	244	1.9	V	14.41	52.82	74	21.18
4844.00	24.26	Ave.	244	1.9	V	14.41	38.67	54	15.33
7266.00	37.02	PK	7	1.5	H	20.92	57.94	74	16.06
7266.00	22.11	Ave.	7	1.5	H	20.92	43.03	54	10.97
9688.00	33.04	PK	298	2.4	V	25.04	58.08	74	15.92
9688.00	18.97	Ave.	298	2.4	V	25.04	44.01	54	9.99
Middle Channel (2437 MHz)									
250.12	46.59	QP	185	2.0	H	-14.6	31.99	46	14.01
2437.00	92.54	PK	100	1.8	H	4.27	96.81	/	/
2437.00	75.39	Ave.	100	1.8	H	4.27	79.66	/	/
2437.00	93.81	PK	66	1.6	V	4.17	97.98	/	/
2437.00	76.25	Ave.	66	1.6	V	4.17	80.42	/	/
2389.51	57.11	PK	239	1.5	V	4.17	61.28	74	12.72
2389.51	34.50	Ave.	239	1.5	V	4.17	38.67	54	15.33
2384.06	52.02	PK	95	1.1	V	4.17	56.19	74	17.81
2384.06	32.00	Ave.	95	1.1	V	4.17	36.17	54	17.83
2484.12	51.83	PK	180	2.1	V	7.59	59.42	74	14.58
2484.12	30.41	Ave.	180	2.1	V	7.59	38.00	54	16.00
4874.00	38.40	PK	309	1.6	H	14.79	53.19	74	20.81
4874.00	24.25	Ave.	309	1.6	H	14.79	39.04	54	14.96
7311.00	36.64	PK	24	1.9	H	20.92	57.56	74	16.44
7311.00	21.91	Ave.	24	1.9	H	20.92	42.83	54	11.17
9748.00	33.74	PK	261	1.6	H	24.84	58.58	74	15.42
9748.00	18.96	Ave.	261	1.6	H	24.84	43.80	54	10.20

Frequency (MHz)	Receiver		Turntable Degree	Rx Antenna		Corrected Factor (dB)	Corrected Amplitude (dBµV/m)	FCC Part 15.247/205/209	
	Reading (dBµV)	Detector (PK/QP/Ave.)		Height (m)	Polar (H/V)			Limit (dBµV/m)	Margin (dB)
High Channel (2452 MHz)									
250.12	47.16	QP	313	1.9	H	-14.6	32.56	46	13.44
2452.00	92.26	PK	152	1.7	H	7.99	100.25	/	/
2452.00	74.63	Ave.	152	1.7	H	7.99	82.62	/	/
2452.00	92.93	PK	255	1.7	V	7.59	100.52	/	/
2452.00	75.47	Ave.	255	1.7	V	7.59	83.06	/	/
2370.76	51.79	PK	183	1.1	V	4.17	55.96	74	18.04
2370.76	30.41	Ave.	183	1.1	V	4.17	34.58	54	19.42
2483.96	58.75	PK	25	1.3	V	7.59	66.34	74	7.66
2483.96	32.00	Ave.	25	1.3	V	7.59	39.59	54	14.41
2484.12	57.46	PK	213	1.1	V	7.59	65.05	74	8.95
2487.26	33.34	Ave.	213	1.1	V	7.59	40.93	54	13.07
4904.00	38.88	PK	133	1.6	V	14.99	53.87	74	20.13
4904.00	24.71	Ave.	133	1.6	V	14.99	39.70	54	14.30
7356.00	37.01	PK	332	2.2	H	21.21	58.22	74	15.78
7356.00	21.93	Ave.	332	2.2	H	21.21	43.14	54	10.86
9808.00	33.76	PK	17	1.5	V	26.10	59.86	74	14.14
9808.00	18.12	Ave.	17	1.5	V	26.10	44.22	54	9.78

Note:

Corrected Factor = Antenna factor (RX) + Cable Loss – Amplifier Factor

Corrected Amplitude = Corrected Factor + Reading

Margin = Limit - Corrected. Amplitude

PRODUCT SIMILARITY DECLARATION LETTER

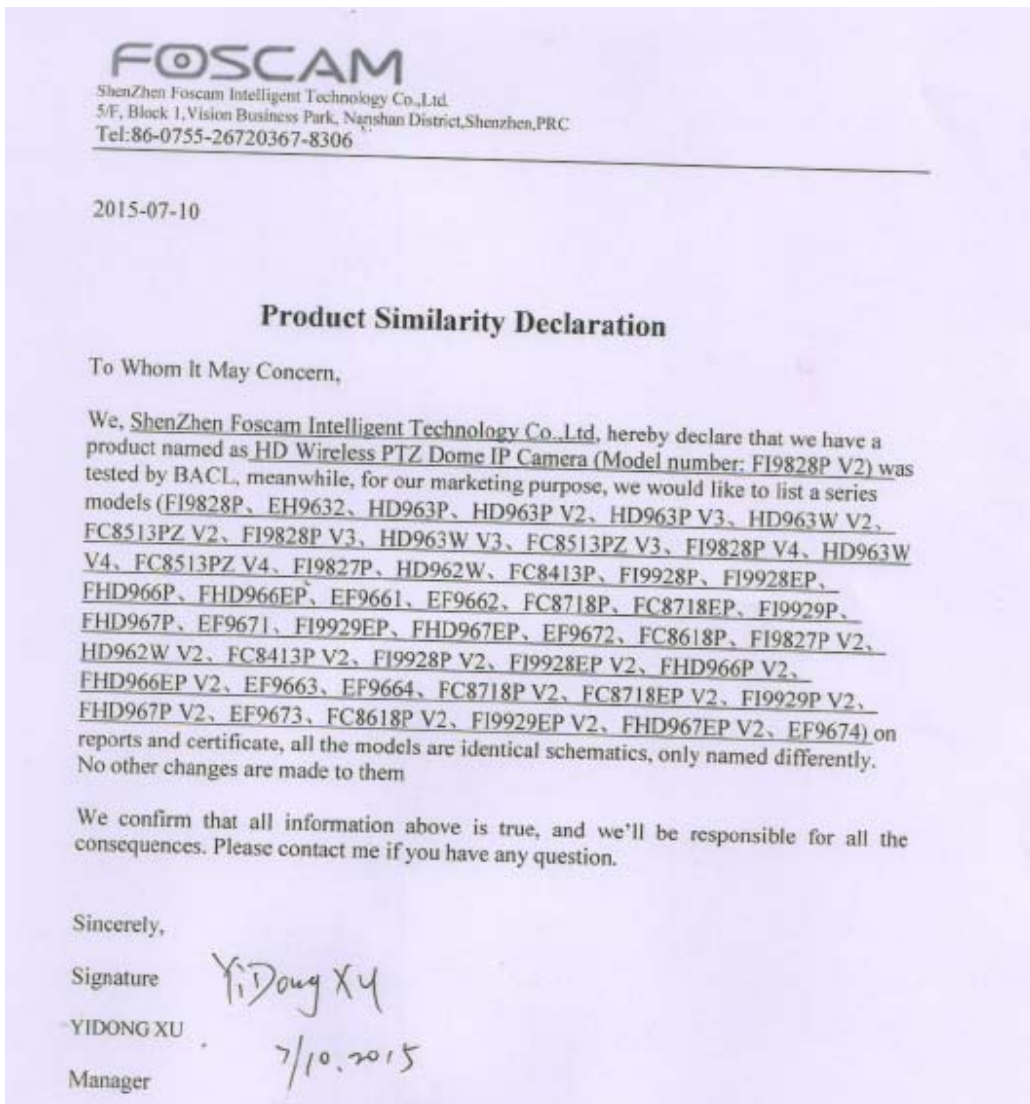

***** END OF REPORT *****