

Ke Mei Ou Laboratory Co., Ltd.

E506, 5th Floor, No.39 Keji Middle 2nd Rd, Science & Technology
Park, Nanshan District, Shenzhen, P. R. China
Tel: + 86 755 83642690 Fax: + 86 755 83297077
www.kmolab.com

FCC TEST REPORT

Under
FCC 15 Subpart C, Paragraph 15.247

Operating in 2400 ~ 2483.5 MHz Band

Prepared For :

ShenZhen Foscam Intelligent Technology Co.,Ltd

5/F, Block 1, Vision Business Park, Nanshan District, Shenzhen, China

FCC ID: ZDEFI9821W
EUT: Indoor HD Pan/Tilt Wireless IP Camera
Model: FI9821W

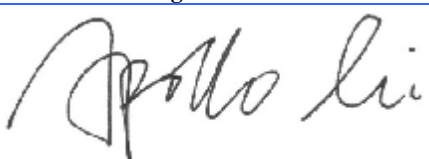
July 25, 2013 Issue Date:
Original Report Report Type:
<i>Eric Guo</i> Test Engineer: Eric Guo
 Review By: Apollo Liu / Manager

The test report consists 56 pages in total. It may be duplicated completely for legal use with the allowance of the applicant. It shall not be reproduced except in full, without the written approval of Ke Mei Ou Laboratory Corporation. The test result in the report only applied to the tested sample.

TABLE OF CONTENTS

- 1. General Information 3**
 - 1. 1 Notes 3
 - 1. 2 Testing Laboratory 3
 - 1. 3 Details of Applicant 3
 - 1. 4 Application Details 3
 - 1. 5 Test Item 3
 - 1. 6 Test Standards 3
- 2. Technical Test 4**
 - 2. 1 Summary of Test Results 4
 - 2. 2 Antenna Requirement 4
- 3. EUT Modifications 4**
- 4. Conducted Power Line Test 5**
 - 4. 1 Test Equipment 5
 - 4. 2 Test Procedure 5
 - 4. 3 Test Setup 5
 - 4. 4 Configuration of the EUT 6
 - 4. 5 EUT Operating Condition 8
 - 4. 6 Conducted Power Line Emission Limits 8
 - 4. 7 Conducted Power Line Test Result 9
- 5. FCC Part 15.247 Requirements for 802.11b/g/n Systems 11**
 - 5. 1 Test Equipment 11
 - 5. 2 Test Procedure 11
 - 5. 3 Test Setup 11
 - 5. 4 Configuration of the EUT 11
 - 5. 5 EUT Operating Condition 11
 - 5. 6 Limit 12
 - 5. 7 Test Result 13
- 6. Transmitter Spurious Radiated Emission at 3 Meters 34**
 - 6. 1 Test Equipment 34
 - 6. 2 Test Procedure 34
 - 6. 3 Test Setup 34
 - 6. 4 Configuration of the EUT 35
 - 6. 5 EUT Operating Condition 35
 - 6. 6 Limit 36
 - 6. 7 Test Result 37
- 7. RF Exposure Requirements 42**
 - 7. 1 Test Equipment 42
 - 7. 2 Limit 42
 - 7. 3 Test Result 42
- 8. Photos of Testing 43**
 - 8. 1 EUT Test Photographs 43
 - 8. 2 EUT Detailed Photographs 45
- 9. FCC ID Label 55**
- 10. Test Equipment 56**

1. General Information

1.1 Notes

The test results of this report relate exclusively to the test item specified in 1.5. The KMO Lab does not assume responsibility for any conclusions and generalizations drawn from the test results with regard to other specimens or samples of the type of the equipment represented by the test item. The test report may only be reproduced or published in full. Reproduction or publication of extracts from the report requires the prior written approval of the KMO Lab.

1.2 Testing Laboratory

Sintek Laboratory Co., Ltd.

Site on File with the Federal Communications Commission – United States

Registration Number: 963441

1.3 Details of Applicant

Name : ShenZhen Foscam Intelligent Technology Co.,Ltd
Address : 5/F, Block 1, Vision Business Park, Nanshan District, Shenzhen, China
Contact : Tank Fang
Tel : 86-755-26720367-8306
Fax : 86-755-2616 2423

1.4 Application Details

Date of Receipt of Application : July 2, 2013
Date of Receipt of Test Item : July 2, 2013
Date of Test : July 3, 2013~July 25, 2013

1.5 Test Item

Manufacturer : Shenzhen Foscada Electronics Co.,Ltd
Address : 4F,9th,building,JiaTeLiHigh-tech industrial park,Tangtou community,Shiyan town,Baoan,ShenZhen
Trade Name : Foscam
Model No.(Base) : FI9821W
Model No.(Extension) : FI9821P/HD816W/HD816P/FI9831W/FI9831P/HD817W/HD817P
Description : Indoor HD Pan/Tilt Wireless IP Camera

Additional Information

Product Type : WLAN (1TX, 1RX)
Radio Type : Intentional Transceiver
Power Type : DC5V/200mA(Adapter model: SAW-0502000)
Modulation : see the below tables
Data Modulation : IEEE 802.11b: DQPSK, DBPSK, DSSS, and CCK
IEEE 802.11g: BPSK, QPSK, 16QAM, 64QAM
IEEE 802.11n: HT20/HT40: OFDM (64QAM,16QAM, QPSK, BPSK)
Date Rate (Mbps) : see the below table
Frequency Range : 2412~2462MHz, 2422~2452MHz
Channel Number : 11 for 20MHz bandwidth(2412~2462MHz); 7 for 40MHz bandwidth (2422~2452MHz)
Antenna : Dipole (2.0dBi)

Antenna & Band Width

Antenna	Single (TX)		Two (TX)	
	20 MHz	40 MHz	20 MHz	40 MHz
Band width Mode	20 MHz	40 MHz	20 MHz	40 MHz
802.11a	X	X	X	X
802.11b / 11,5.5,2 and 1 Mbps with auto-rate fall back	√	X	X	X
802.11g / 54,48,36,24,18,12,9&6 Mbps	√	X	X	X
Draft n / up to 72Mbps	√	√	X	X

1.6 Test Standards

FCC 15 Subpart C, Paragraph 15.247

Note: All radiated measurements were made in all three orthogonal planes. The values reported are the maximum values.

2. Technical Test

2.1 Summary of Test Results

The EUT has been tested according to the following specifications:

FCC Rule	Test Type	Limit	Result	Notes
FCC 15.247(a)(2)	6dB Bandwidth	$\geq 0.5\text{MHz}$	PASS	Complies
FCC 15.247(b)(1)	Peak Output Power	$\leq 30\text{dBm}$	PASS	Complies
FCC 15.247(e)	Power Spectral Density	$\leq 8\text{dBm}$	PASS	Complies
FCC 15.247(d)	Conducted Band Edges and Spurious Emission	$\leq 20\text{dBc}$	PASS	Complies.
FCC 15.247(d)	Radiated Band Edges and Spurious Emission	FCC 15.209(a) & 15.247(d)	PASS	Complies.
FCC 15.207	AC Conducted Emission	FCC15.207(a)	PASS	Complies.
FCC 15.203 & 15.247(b)	Antenna Requirement	N/A	PASS	Complies

* The digital circuit porting of the EUT has been tested and verified to comply with FCC Part 15, Subpart B., Class B Digital Devices and the associated Radio Receiver has also been tested and found to comply with FCC Part 15, Subpart B – Radio Receivers.

2.2 Antenna Requirement

A. Regulation

FCC section 15.203, An intentional radiator shall be designed to ensure that no antenna other than that furnished by the responsible party shall be used with the device. The use of a permanently attached antenna or of an antenna that uses a unique coupling to the intentional radiator shall be considered sufficient to comply with the provisions of Part 15C. The manufacturer may design the unit so that the user can replace a broken antenna, but the use of a standard antenna jack or electrical connector is prohibited. This requirement does not apply to carrier current devices or to devices operated under the provisions of Sections 15.211, 15.213, 15.217, 15.219, or 15.221. Further, this requirement does not apply to intentional radiators that must be professionally installed, such as perimeter protection systems and some field disturbance sensors, or to other intentional radiators which, in accordance with Section 15.31(d), must be measured at the installation site. However, the installer shall be responsible for ensuring that the proper antenna is employed so that the limits in this Part are not exceeded.

B. Result

The antenna type used in this product is Dipole Antenna with SMA antenna connector. and it is considered to meet antenna requirement of FCC.

3. EUT Modifications

No modification by test lab.

4. Conducted Power Line Test

4.1 Test Equipment

Please refer to Section 10 this report.

4.2 Test Procedure

The EUT and simulators are connected to the main power through a line impedance stabilization network (L.I.S.N.). This provides a 50 ohm/50uH coupling impedance for the measuring equipment. The peripheral devices are also connected to the main power through a LISN that provides a 50ohm/50uH coupling impedance with 50ohm termination.

Both sides of A.C. line are checked for maximum conducted interference. In order to find the maximum emission., the relative positions of equipment and all of the interface cables must be changed according to ANSI C63.4:2003 on conducted measurement. Conducted emissions were invested over the frequency range from 0.15MHz to 30MHz using a receiver bandwidth of 9kHz.

4.3 Test Setup

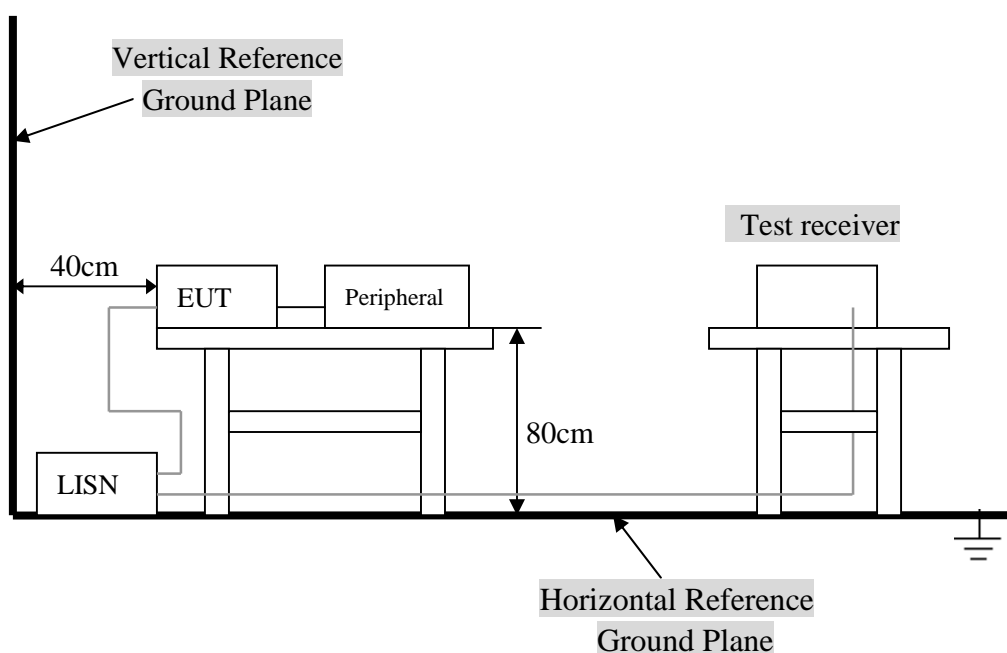

For the actual test configuration, Please refer to the related items – Photos of Testing.

4. 4 Configuration of the EUT

The EUT was configured according to ANSI C63.4-2003. EUT was used DC5V. The operation frequency is from 2400MHz~2483.5MHz. Enable the signal transmitted from the EUT to Notebook PC. All interface ports were connected to the appropriate peripherals. All peripherals and cables are listed below.

Note:

- 1) Operating Modes: Each of lowest, middle and highest channel frequencies transmits continuously for emissions measurements. The EUT operates in normal 802.11b/g/n for occupancy duration and frequency separation.
- 2) Special Test Software & Hardware: Special firmware and hardware provided by the Applicant are installed to allow the EUT to operate in 802.11b/g/n or at each channel frequency continuously. For example, the transmitter will be operated at each of lowest, middle and highest frequencies individually continuously during testing.
- 3) Transmitter Test Antenna: The EUT is tested with the antenna fitted in a manner typical of normal intended use as an integral / non-integral antenna equipment as describe with the test results.
- 4) Frequency(ies) Tested: 2412MHz, 2437MHz and 2462MHz were pre-tested, The worst case one, was chosen for conducted emission test.
- 5) Above 1GHz, the 2412MHz, 2437MHz and 2462MHz were tested individually.
- 6) Normal Test Modulation: 802.11b/g/n
- 7) Modulating Signal Source: Internal

* Associated Antenna Descriptions: The antenna used in this product is dipole antenna.

A. EUT

Device	Manufacturer	Model #	FCC ID
Indoor HD Pan/Tilt Wireless IP Camera	Shenzhen Foscada Electronics Co.,Ltd	FI9821W	ZDEFI9821W

Field Antenna For 2.4GHz Band

Ant.	Brand	Model Name	Antenna Type	Connector	Gain (dBi)	Remark
0	B&T	2.4GHz Dipole Antenna AG-011318-0346-A0-0000	Dipole	N/A	2.00	TX/RX

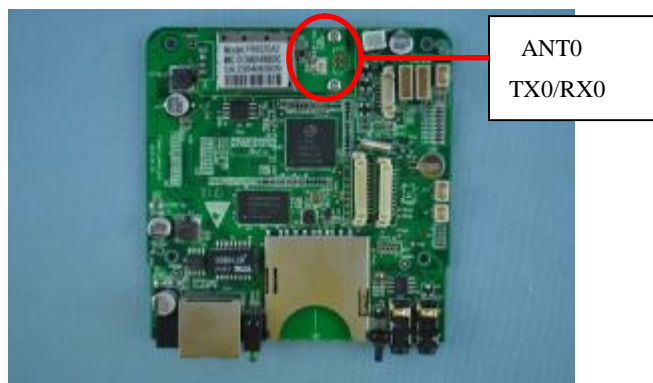

Note:

The EUT incorporates a WiFi function with 802.11b, 802.11g, 802.11n. Physically, the EUT provides one completed transmit and receiver.

Carrier Frequencies For 2.4GHz Band

Frequency Band	Channel No.	Frequency	Channel No.	Frquency
2400~2483.5Mhz	1	2412MHz	7	2442MHz
	2	2417MHz	8	2447MHz
	3	2422MHz	9	2452MHz
	4	2427MHz	10	2457MHz
	5	2432MHz	11	2462MHz
	6	2437MHz		

Test Modes For 2.4GHz Band

Test Items	Mode	Data Rate	Channel	Antenna
AC Power Line Conducted Emissions	Normal Link	Auto	-	-
Maximum Peak Conducted Output Power Power Spectral Density 6dB Spectrum Bandwidth	MCS0/20MHz	7.2 Mbps	1/6/11	0
	MCS0/40MHz	15 Mbps	3/6/9	0
	11b/BPSK	1 Mbps	1/6/11	0
	11g/BPSK	6 Mbps	1/6/11	0
Radiated Emissions 9kHz~1GHz	Normal Link	Auto	-	-
Radiated Emissions 1GHz~10 th Harmonic	MCS0/20MHz	7.2 Mbps	1/6/11	0
	MCS0/40MHz	15 Mbps	3/6/9	0
	11b/BPSK	1 Mbps	1/6/11	0
	11g/BPSK	6 Mbps	1/6/11	0
Band Edge Emissions	MCS0/20MHz	7.2 Mbps	1/11	0
	MCS0/40MHz	15 Mbps	3/9	0
	11b/BPSK	1 Mbps	1/11	0
	11g/BPSK	6 Mbps	1/11	0

Note: Preliminary tests were performed in different data rate to find the worst radiated emission. The data rate show in the table above is the worst-case rate with respect to the specific test item. Investigation has been done on all the possible configurations for searching the worst cases. During testing, Channel & Power Controlling Software provided by the customer was used to control the operating channel as well as the output power level, The RF output power selection is for the setting of RF output power expected by the customer and is going to be fixed on the firmware of the find end product.

B. Internal Devices

Device	Manufacturer	Model #	FCC ID
N/A			

C. Peripherals

Device	Manufacturer	Model # Serial #	FCC ID/ DoC	Cable
Printer	HP	HP930C	DoC	1.5m unshielded power cord 1.2m unshielded data cable.
Modem	GVC	N/A	DoC	1.5m unshielded power cord 1.2m unshielded data cable.
Notebook	DELL	PP10L	DoC	1.5m unshielded power cord
PC	Dell	2400n	DoC	1.5m unshielded power cord

4. 5 EUT Operating Condition

Operating condition is according to ANSI C63.4 - 2003.

- A. Setup the EUT and simulators as shown on follow.
- B. Enable RF signal and confirm EUT active.
- C. Modulate output capacity of EUT up to specification.

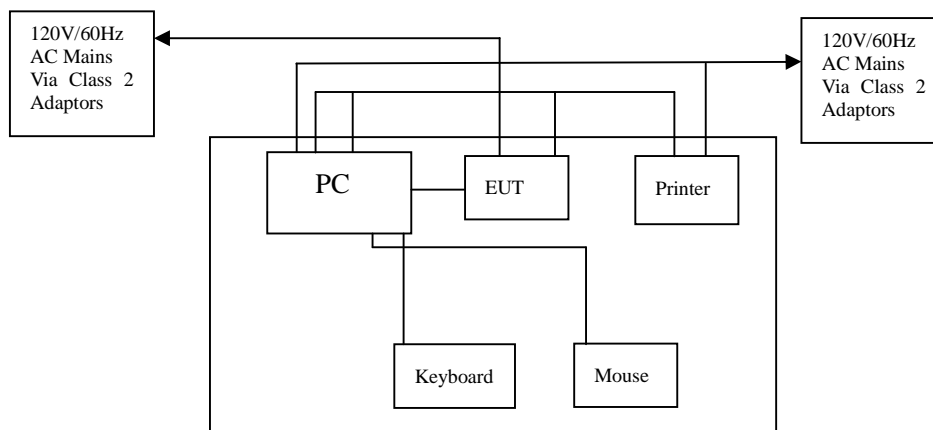

4. 6 Conducted Power Line Emission Limits

FCC Part 15 Paragraph 15.207 (dBuV)		
Frequency Range (MHz)	Class A QP/AV	Class B QP/AV
0.15 – 0.5	79/66	66-56/56-46
0.5 – 5.0	73/60	56/46
5.0 - 30	73/60	60/50

NOTE : In the above table, the tighter limit applies at the band edges.

4.7 Conducted Power Line Test Result

Product	: Indoor HD Pan/Tilt Wireless IP Camera	Test Mode	: Normal Link / Auto
Test Item	: Conducted Emission Data	Temperature	: 25 °C
Test Voltage	: DC 5V	Humidity	: 56%RH
Test Result	: PASS	Adapter Model	:

The frequency spectrum from 0.15 MHz to 30 MHz was investigated. All readings are quasi -peak values with a resolution bandwidth of 9 KHz.

- Temperature : 26 °C
- Humidity : 53 % RH

Adapter model: SAW-0502000

FCC Part 15 Paragraph 15.207							
Frequency (MHz)	Emission (dBuV)		LINE/NEUTRAL	Limit (dBuV)		Margin (dB)	
	QP	AV		QP	AV	QP	AV
0.330	52.58	44.39	Line	59.45	49.45	-6.87	-5.06
0.162	44.65	33.01	Neutral	65.36	55.36	-20.71	-22.35
0.682	45.26	36.51	Line	56.00	46.00	-10.74	-9.49
0.326	45.73	35.78	Neutral	59.55	49.55	-13.82	-13.77
0.814	45.29	38.29	Line	56.00	46.00	-10.71	-7.71
0.738	38.38	29.57	Neutral	56.00	46.00	-17.62	-16.43

Note: NF = No Significant Peak was Found.

Note:

- 1.Uncertainty in conducted emission measured is <+/- 2dB.
- 2.The emission levels of other frequencies were very low against the limit.
- 3.All Reading Levels are Quasi-Peak and Average value.
- 4.Emission = Meter Reading + Factor; Factor = Insertion Loss + Cable Loss.
- 5.Margin Value = Emission Level - Limit Value.

Conducted Emission

EN55022

EUT: Indoor HD Pan/Tilt Wireless IP Camera

M/N: FI9821W

Manufacturer: Shenzhen Foscada Electronics Co.,Ltd

Operating Condition: Transmitter

Test Site: Normal

Operator: KMO Tester

Test Specification: LINE&NEUTRAL

Comment:

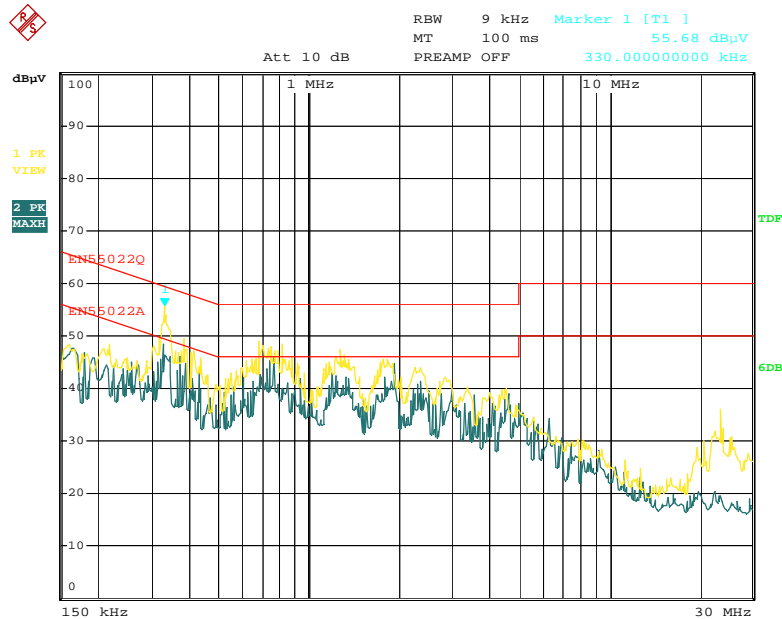

Date: 3.JUL.2013 14:30:29

5. FCC Part 15.247 Requirements for 802.11b/g/n Systems

5.1 Test Equipment

Please refer to Section 10 this report.

5.2 Test Procedure

Refer to FCC 15.247(a)(2), ANSI C63.4: 2003

6 dB Bandwidth:

1. Set resolution bandwidth (RBW) = 100 kHz.
2. Set the video bandwidth (VBW) $\geq 3 \times$ RBW.
3. Detector = Peak.
4. Trace mode = max hold.
5. Sweep = auto couple.
6. Allow the trace to stabilize.
7. Measure the maximum width of the emission that is constrained by the frequencies associated with the two outermost amplitude points (upper and lower) that are attenuated by 6 dB relative to the maximum level measured in the fundamental emission.

Peak Power:

1. Set the RBW = 1 MHz.
2. Set the VBW ≥ 3 RBW
3. Set the span $\geq 1.5 \times$ DTS bandwidth.
4. Detector = peak.
5. Sweep time = auto couple.
6. Trace mode = max hold.
7. Allow trace to fully stabilize.

Band Edges Measurement:

- a. The transmitter output was connected to the spectrum analyzer via a low lose cable.
- b. Set both RBW and VBW of spectrum analyzer to 100kHz with suitable frequency span including 100kHz bandwidth from band edge.
- c. The band edges was measured and recorded.

Peak Power Spectral Density:

- a. The testing follows Measurement Procedure 5.3.1 (Peak PSD) of FCC KDB Publication No. 558074 D01 DTS Meas Guidance v03r01.
- b. The RF output of EUT was connected to the spectrum analyzer by a low loss cable. The path loss was compensated to the results for each measurement.
- c. Record the measurement data derived from the spectrum analyzer.
- d. Make the measurement with the spectrum analyzer's resolution bandwidth(RBW)=100kHz. Video bandwidth(VBW) ≥ 300 KHz. In order to make an accurate measurement, set the span to 5-30% greater than Emission Bandwidth(EBW).
- e. Detector = peak, Sweep time = auto couple, Trace mode = max hold. Allow trace to fully stabilize. Use the peak marker function to determine the maximum power level in any 100 kHz band segment within the fundamental EBW.
- f. Scale the observed power level to an equivalent value in 3 kHz by adjusting (reducing) the measured power by a bandwidth correction factor (BWCF) where $BWCF = 10\log(3\text{kHz}/100\text{kHz} = -15.2\text{dB})$.

5.3 Test Setup

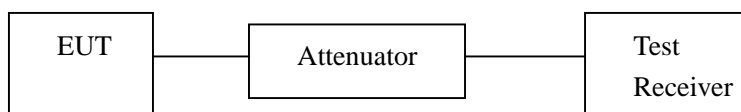

5.4 Configuration of the EUT

Same as section 4.4 of this report

5.5 EUT Operating Condition

Same as section 4.5 of this report.

5.6 Limit

According to §15.247(a)(2), systems using digital modulation techniques may operate in the 902 ~ 928 MHz, 2400 ~ 2483.5 MHz, and 5725 ~ 5850 MHz bands. The minimum 6dB bandwidth shall be at least 500 kHz.

According to §15.247(b)(3), for systems using digital modulation in the bands of 902-928 MHz, 2400-2483.5 MHz, and 5725-5850 MHz: 1 Watt.

According to §15.247(b)(4), the conducted output power limit specified in paragraph (b) of this section is based on the use of antennas with directional gains that do not exceed 6 dBi. Except as shown in paragraph (c) of this section, if transmitting antennas of directional gain greater than 6 dBi are used, the conducted output power from the intentional radiator shall be reduced below the stated values in paragraphs (b)(1), (b)(2), and (b)(3) of this section, as appropriate, by the amount in dB that the directional gain of the antenna exceeds 6 dBi.

According to §15.247(d), in any 100 kHz bandwidth outside the frequency bands in which the spread spectrum intentional radiator is operating, the radio frequency power that is produced by the intentional radiator shall be at least 20 dB below that in the 100 kHz bandwidth within the band that contains the highest level of the desired power, based on either an RF conducted or a radiated measurement, provided the transmitter demonstrates compliance with the peak conducted power limits. In addition, radiated emissions which fall in the restricted bands, as defined in §15.205(a), must also comply with the radiated emission limits specified in 15.209(a) (see Section 15.205(c)).

According to §15.247(e), for digitally modulated systems, the power spectral density conducted from the intentional radiator to the antenna shall not be greater than 8 dBm in any 3 kHz band during any time interval of continuous transmission.

According to §15.247(f), the digital modulation operation of the hybrid system, with the frequency hopping turned off, shall comply with the power density requirements of paragraph (d) of this section.

5.7 Test Result

A. 6 dB Bandwidth

Product : Indoor HD Pan/Tilt Wireless IP Camera Test Mode : IEEE 802.11b/g/Draft n
 Test Item : 6 dB BW Temperature : 25 °C
 Test Voltage : DC 5V (Power by Adapter Supply) Humidity : 56%RH
 Test Result : **PASS**

IEEE 802.11b

Channel	Frequency (MHz)	Bandwidth (MHz)	FCC Limit (kHz)	Result
Low	2412	10.20	>500 kHz	PASS
Mid	2437	10.20		PASS
High	2462	10.20		PASS

IEEE 802.11g

Channel	Frequency (MHz)	Bandwidth (MHz)	FCC Limit (kHz)	Result
Low	2412	16.40	>500 kHz	PASS
Mid	2437	16.40		PASS
High	2462	16.40		PASS

Draft n MCS0 20MHz Ant.0

Channel	Frequency (MHz)	Bandwidth (MHz)	FCC Limit (kHz)	Result
Low	2412	17.12	>500 kHz	PASS
Mid	2437	17.12		PASS
High	2462	17.12		PASS

Draft n MCS0 40MHz Ant.0

Channel	Frequency (MHz)	Bandwidth (MHz)	FCC Limit (kHz)	Result
Low	2422	35.20	>500 kHz	PASS
Mid	2437	35.16		PASS
High	2452	35.20		PASS

IEEE 802.11b

6dB Bandwidth (CH Low)

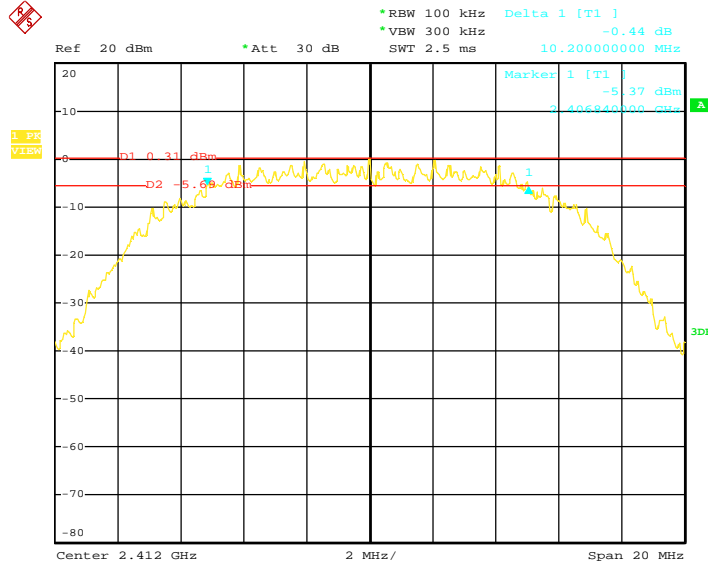

Date: 25.JUL.2013 13:56:06

6dB Bandwidth (CH Mid)

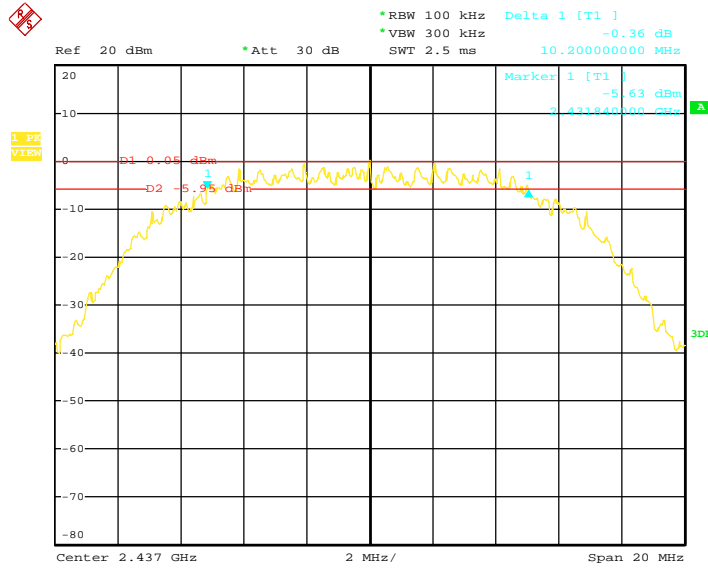

Date: 25.JUL.2013 13:58:32

6dB Bandwidth (CH High)

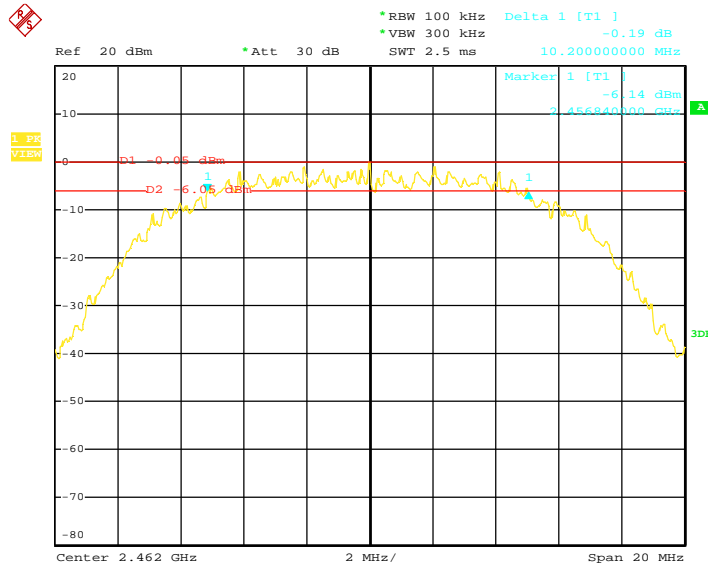

Date: 25.JUL.2013 13:59:52

IEEE 802.11g

6dB Bandwidth (CH Low)

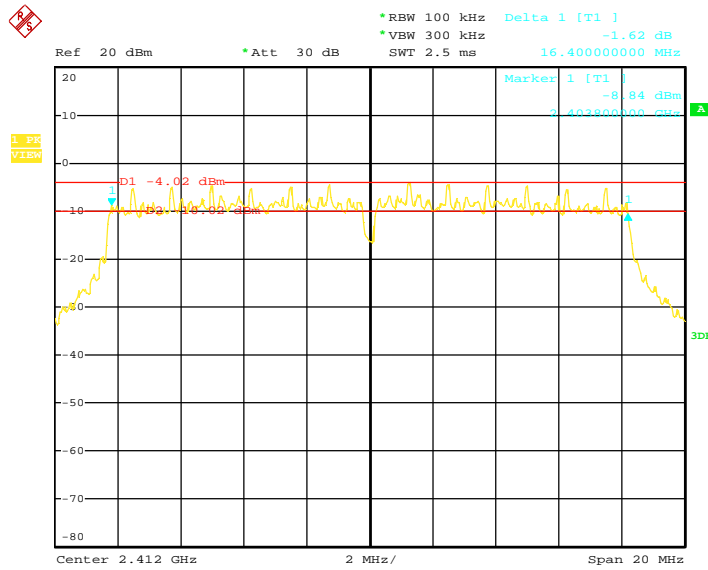

Date: 25.JUL.2013 14:01:49

6dB Bandwidth (CH Mid)

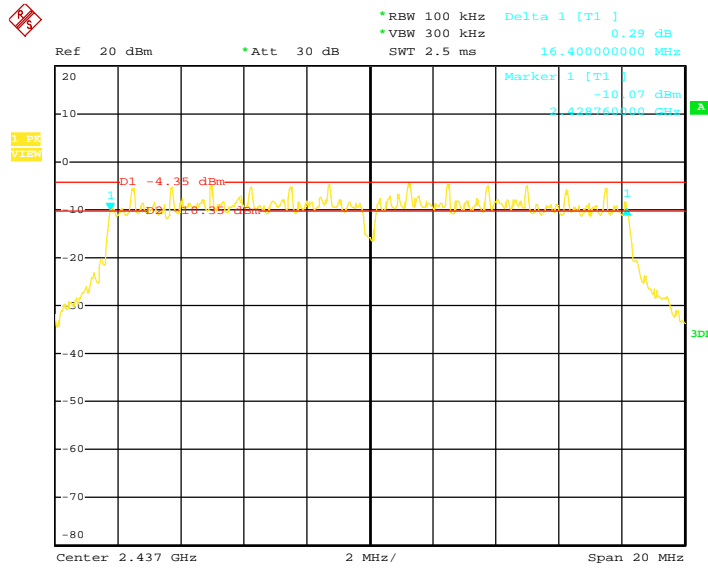

Date: 25.JUL.2013 14:03:12

6dB Bandwidth (CH High)

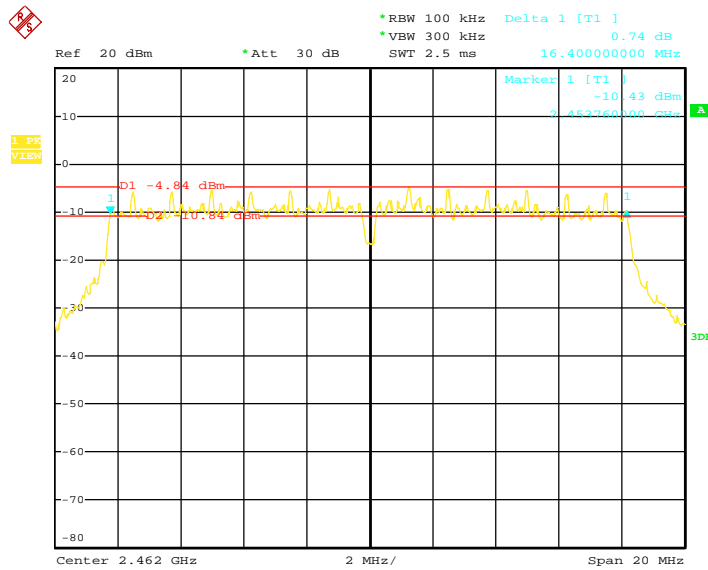

Date: 25.JUL.2013 14:04:29

Draft n MCS0 20MHz Ant.0

6dB Bandwidth (CH Low)

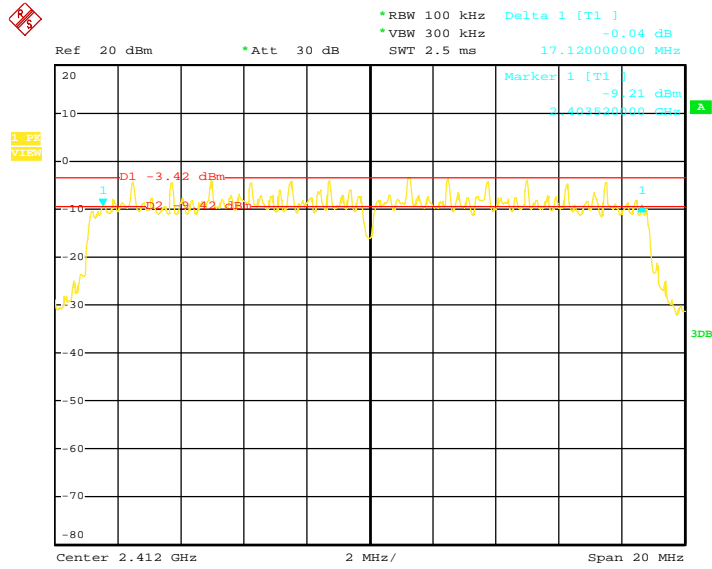

Date: 25.JUL.2013 14:06:57

6dB Bandwidth (CH Mid)

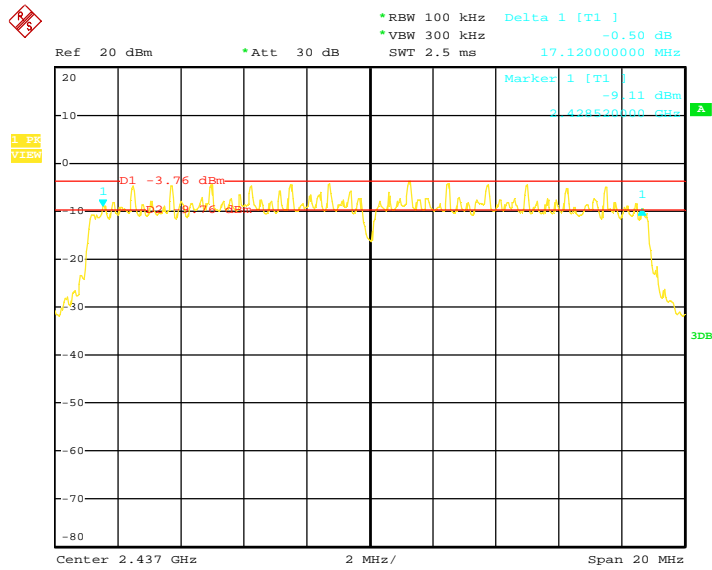

Date: 25.JUL.2013 14:08:21

6dB Bandwidth (CH High)

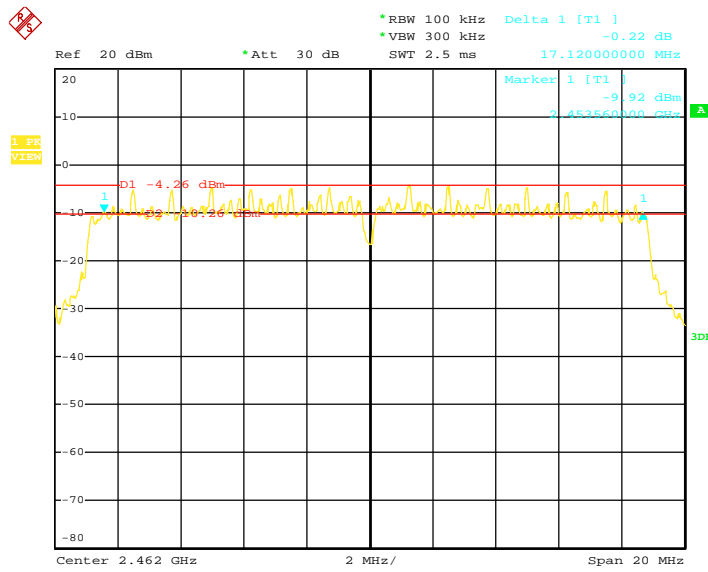

Date: 25.JUL.2013 14:19:42

Draft n MCS0 40MHz Ant.0

6dB Bandwidth (CH Low)

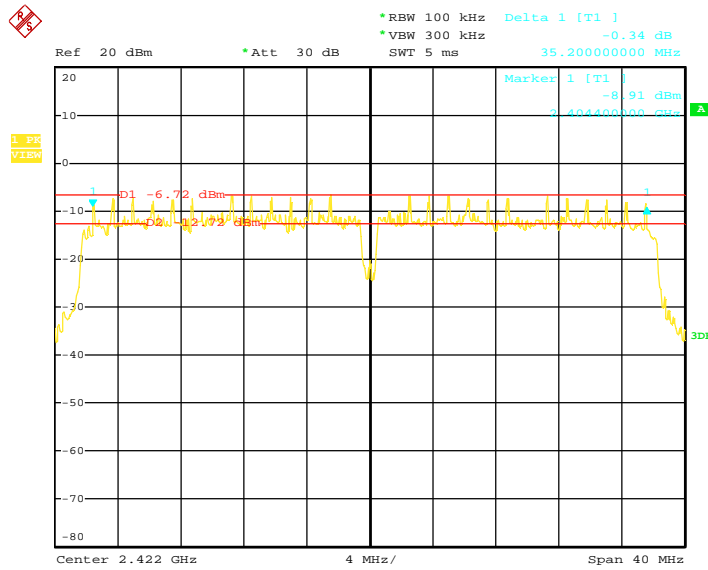

Date: 25.JUL.2013 14:21:30

6dB Bandwidth (CH Mid)

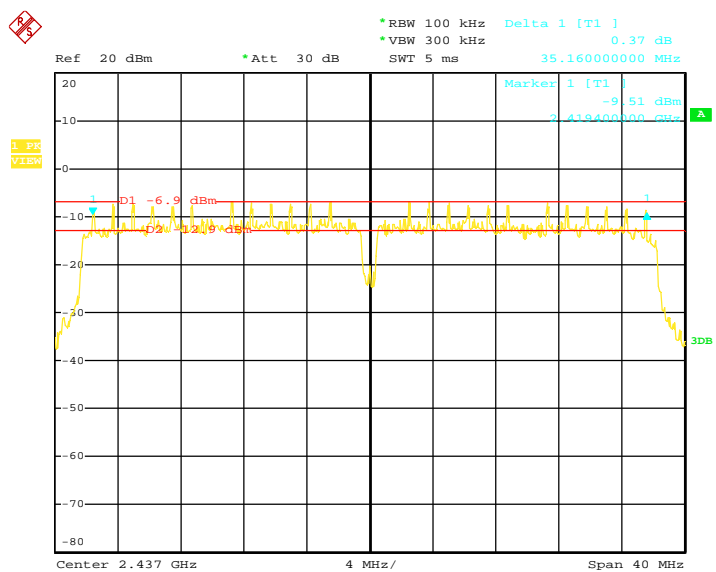

Date: 25.JUL.2013 14:24:34

6dB Bandwidth (CH High)

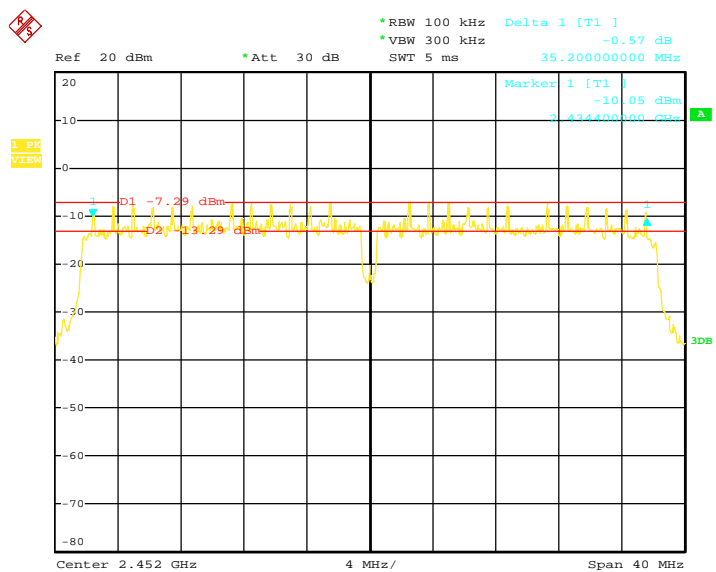

Date: 25.JUL.2013 14:26:41

B. Peak Power

Product : Indoor HD Pan/Tilt Wireless IP Camera Test Mode : IEEE 802.11b/g/Draft n
 Test Item : Peak Power Temperature : 25 °C
 Test Voltage : DC 5V (Power by Adapter Supply) Humidity : 56%RH
 Test Result : **PASS**

IEEE 802.11b

Channel	Frequency (MHz)	Output Power (dBm)	FCC Limit (W/dBm)	Result
Low	2412	7.16	1.00/30.00	PASS
Mid	2437	6.28		PASS
High	2462	5.67		PASS

IEEE 802.11g

Channel	Frequency (MHz)	Output Power (dBm)	FCC Limit (W/dBm)	Result
Low	2412	6.23	1.00/30.00	PASS
Mid	2437	5.12		PASS
High	2462	4.98		PASS

Draft n MCS8 20MHz Ant.0

Channel	Frequency (MHz)	Output Power (dBm)	FCC Limit (W/dBm)	Result
Low	2412	4.61	1.00/30.00	PASS
Mid	2437	4.68		PASS
High	2462	4.79		PASS

Draft n MCS8 40MHz Ant.0

Channel	Frequency (MHz)	Output Power (dBm)	FCC Limit (W/dBm)	Result
Low	2422	2.03	1.00/30.00	PASS
Mid	2437	2.24		PASS
High	2452	2.05		PASS

C. Band Edges Measurement

Product : Indoor HD Pan/Tilt Wireless IP Camera Test Mode : IEEE 802.11b/g/n
 Test Item : Band Edges Measurement Temperature : 25 °C
 Test Voltage : DC 5V (Power by Adapter Supply) Humidity : 56%RH
 Test Result : PASS

IEEE 802.11b-low

Freq. (MHz)	Emission (dBuV/m)		HORIZ / VERT	Limits (dBuV/m)		Margin (dB)	
	Peak	Average		Peak	Average		
2350.040	53.44	47.38	HORZ	74	54	-20.56	-6.62
2384.280	55.86	47.23	VERT	74	54	-18.14	-6.77
2390.460	55.12	47.55	HORZ	74	54	-18.88	-6.45
2390.640	55.16	47.67	VERT	74	54	-18.84	-6.33

IEEE 802.11b-High

Freq. (MHz)	Emission (dBuV/m)		HORIZ / VERT	Limits (dBuV/m)		Margin (dB)	
	Peak	Average		Peak	Average		
2483.540	56.68	46.85	HORZ	74	54	-17.32	-7.15
2484.460	57.75	47.02	VERT	74	54	-16.25	-6.98
2485.520	57.22	47.13	HORZ	74	54	-16.78	-6.87
2486.640	56.32	46.89	VERT	74	54	-17.68	-7.11

IEEE 802.11g-Low

Freq. (MHz)	Emission (dBuV/m)		HORIZ / VERT	Limits (dBuV/m)		Margin (dB)	
	Peak	Average		Peak	Average		
2352.140	56.20	47.01	HORZ	74	54	-17.80	-6.99
2385.260	58.17	47.06	VERT	74	54	-15.83	-6.94
2390.780	61.57	48.79	HORZ	74	54	-12.43	-5.21
2390.840	61.57	48.79	VERT	74	54	-12.43	-5.21

IEEE 802.11g-High

Freq. (MHz)	Emission (dBuV/m)		HORIZ / VERT	Limits (dBuV/m)		Margin (dB)	
	Peak	Average		Peak	Average		
2483.640	58.70	48.04	HORZ	74	54	-15.30	-5.96
2483.720	58.70	48.01	VERT	74	54	-15.30	-5.99
2485.420	56.35	47.11	HORZ	74	54	-17.65	-6.89
2486.560	57.50	46.61	VERT	74	54	-16.50	-7.39

IEEE 802.11n MCS8 20MHz Ant.0-Low

Freq. (MHz)	Emission (dBuV/m)		HORIZ / VERT	Limits (dBuV/m)		Margin (dB)	
	Peak	Average		Peak	Average		
2351.040	56.58	46.98	HORZ	74	54	-17.42	-7.02
2385.260	57.36	47.28	VERT	74	54	-16.64	-6.72
2390.540	61.48	49.65	HORZ	74	54	-12.52	-4.35
2390.720	63.84	50.39	VERT	74	54	-10.16	-3.61

IEEE 802.11n MCS8 20MHz Ant.0-High

Freq. (MHz)	Emission (dBuV/m)		HORIZ / VERT	Limits (dBuV/m)		Margin (dB)	
	Peak	Average		Peak	Average		
2484.840	60.70	48.32	HORZ	74	54	-13.30	-5.68
2485.144	59.51	47.87	VERT	74	54	-14.49	-6.13
2485.420	59.58	48.13	HORZ	74	54	-14.42	-5.87
2487.140	56.54	47.24	VERT	74	54	-17.46	-6.76

IEEE 802.11n MCS8 40MHz Ant.0-Low

Freq. (MHz)	Emission (dBuV/m)		HORIZ / VERT	Limits (dBuV/m)		Margin (dB)	
	Peak	Average		Peak	Average		
2351.340	55.63	46.49	HORZ	74	54	-18.37	-7.51
2384.120	64.61	49.52	VERT	74	54	-9.39	-4.48
2390.440	66.31	51.08	HORZ	74	54	-7.69	-2.92
2390.540	66.31	51.08	VERT	74	54	-7.69	-2.92

IEEE 802.11n MCS8 40MHz Ant.0-High

Freq. (MHz)	Emission (dBuV/m)		HORIZ / VERT	Limits (dBuV/m)		Margin (dB)	
	Peak	Average		Peak	Average		
2483.640	66.65	51.35	HORZ	74	54	-7.35	-2.65
2484.420	67.46	51.33	VERT	74	54	-6.54	-2.67
2485.260	66.63	51.26	HORZ	74	54	-7.37	-2.74
2485.640	67.02	51.44	VERT	74	54	-6.98	-2.56

IEEE 802.11b Channel: Low

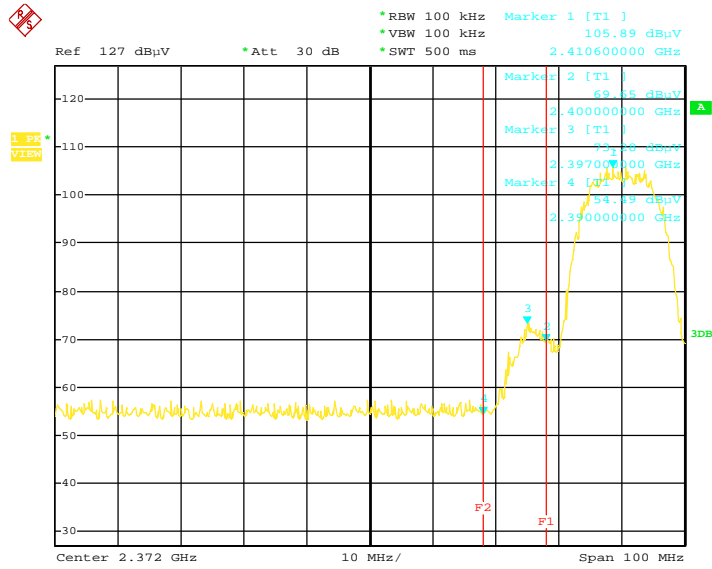

Date: 1.JAN.14502 02:06:48

IEEE 802.11b Channel: High

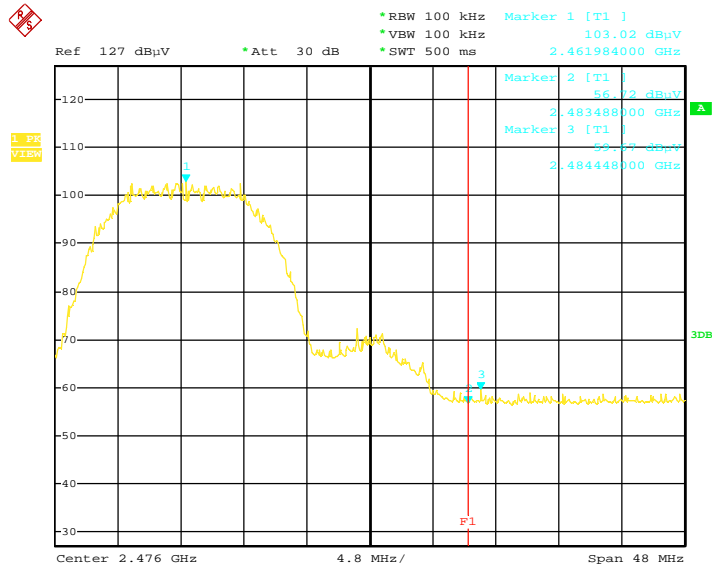

Date: 25.JUL.2013 11:19:20

IEEE 802.11n MCS8 20MHz Ant.0
Channel: Low

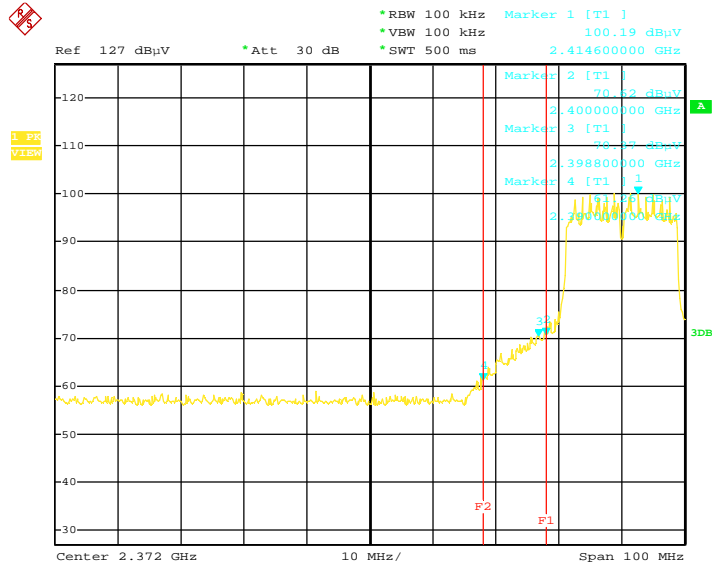

Date: 25.JUL.2013 11:27:08

IEEE 802.11n MCS8 20MHz Ant.0
Channel: High

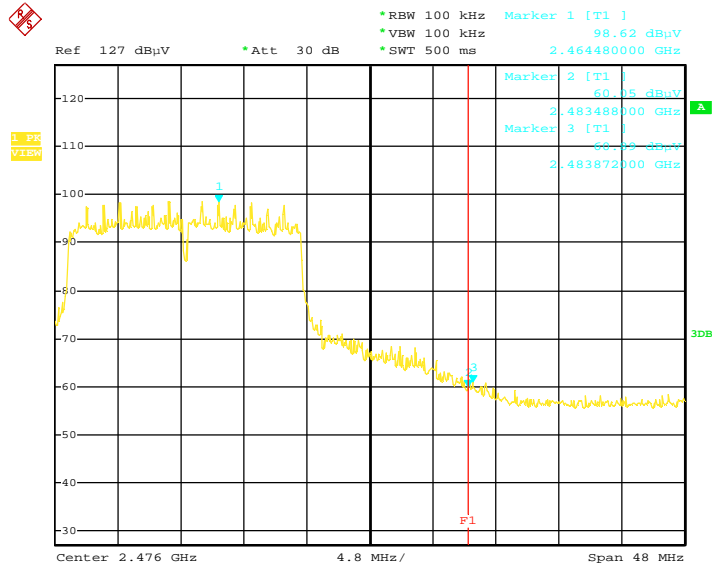

Date: 25.JUL.2013 11:30:23

IEEE 802.11n MCS8 40MHz Ant.0 Channel: Low

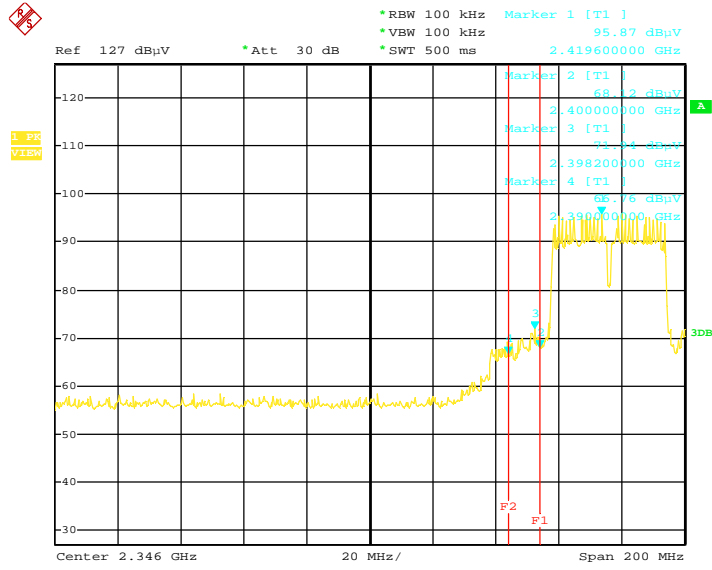

Date: 25.JUL.2013 11:34:16

IEEE 802.11n MCS8 40MHz Ant.0 Channel: High

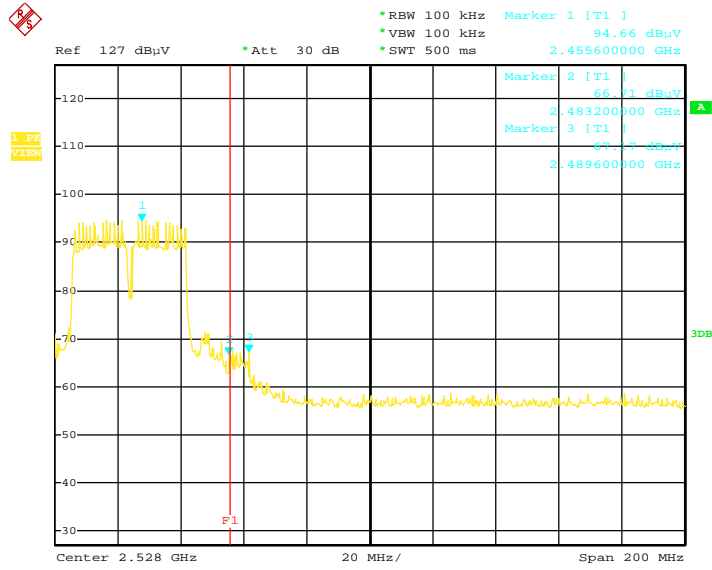

Date: 25.JUL.2013 11:37:32

D. Peak Power Spectral Density

Product : Indoor HD Pan/Tilt Wireless IP Camera Test Mode : IEEE 802.11b/g/Draft n
 Test Item : Peak Power Spectral Density Temperature : 25 °C
 Test Voltage : DC 5V (Power by Adapter Supply) Humidity : 56%RH
 Test Result : **PASS**

IEEE 802.11b

Channel	Frequency (MHz)	100kHz PPSD (dBm)	BWCF Factor 100kHz to 3kHz	FCC Limit (dBm)	Result
Low	2412	-1.38	-15.23	8.00	PASS
Mid	2437	0.19	-15.23		PASS
High	2462	-0.20	-15.23		PASS

IEEE 802.11g

Channel	Frequency (MHz)	100kHz PPSD (dBm)	BWCF Factor 100kHz to 3kHz	FCC Limit (dBm)	Result
Low	2412	-6.66	-15.23	8.00	PASS
Mid	2437	-6.31	-15.23		PASS
High	2462	-7.07	-15.23		PASS

Draft n MCS0 20MHz Ant.0

Channel	Frequency (MHz)	100kHz PPSD (dBm)	BWCF Factor 100kHz to 3kHz	FCC Limit (dBm)	Result
Low	2412	-6.23	-15.23	8.00	PASS
Mid	2437	-6.33	-15.23		PASS
High	2462	-6.95	-15.23		PASS

Draft n MCS0 40MHz Ant.0

Channel	Frequency (MHz)	100kHz PPSD (dBm)	BWCF Factor 100kHz to 3kHz	FCC Limit (dBm)	Result
Low	2422	-10.45	-15.23	8.00	PASS
Mid	2437	-10.51	-15.23		PASS
High	2452	-11.10	-15.23		PASS

IEEE 802.11b Channel: Low

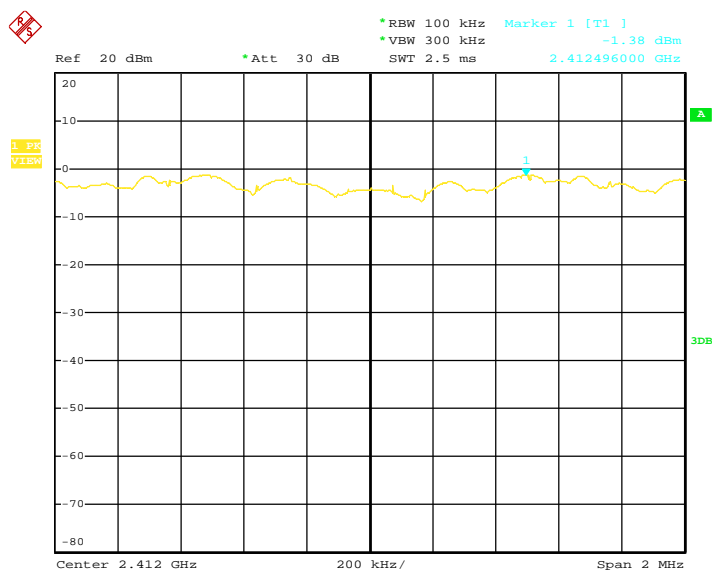

Date: 25.JUL.2013 14:32:48

IEEE 802.11b Channel: Mid

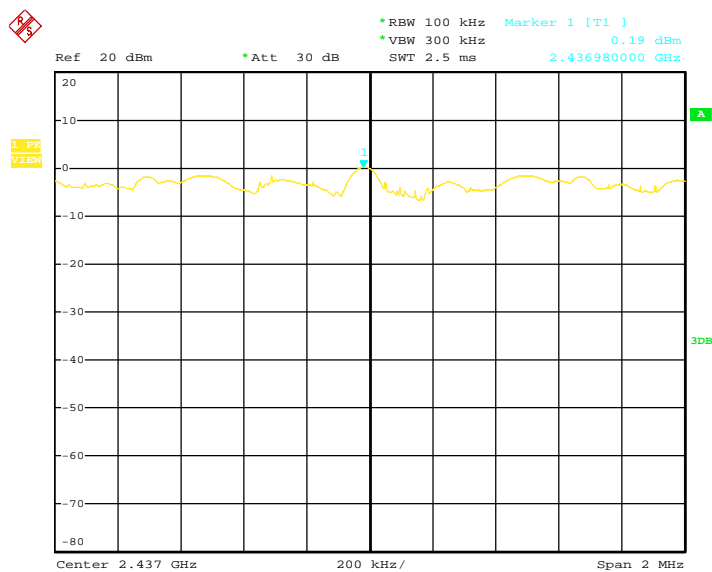

Date: 25.JUL.2013 14:33:51

IEEE 802.11b Channel: High

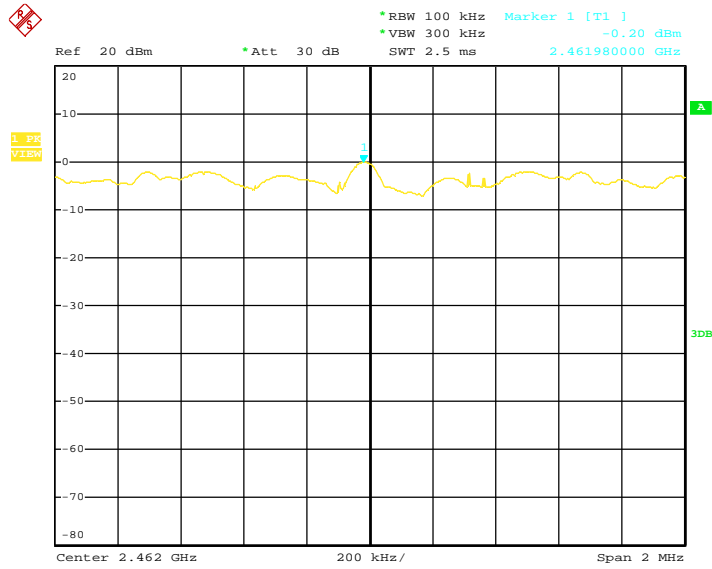

Date: 25.JUL.2013 14:34:37

IEEE 802.11g Channel: Low

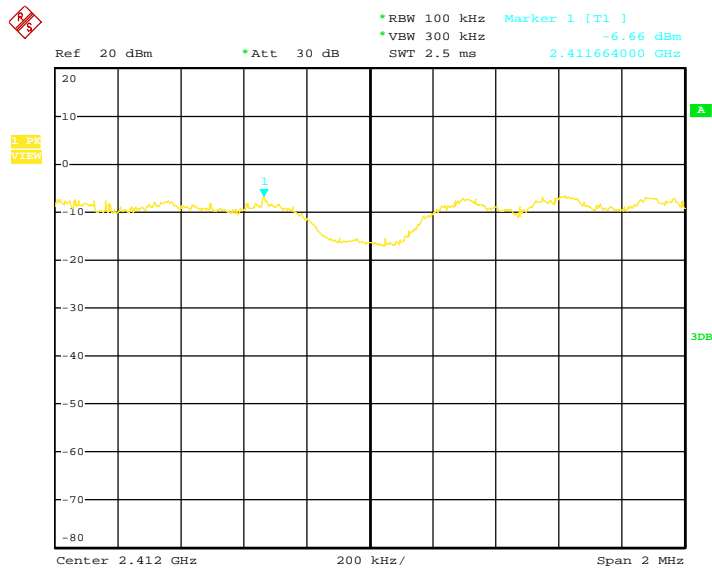

Date: 25.JUL.2013 14:35:29

IEEE 802.11g Channel: Mid

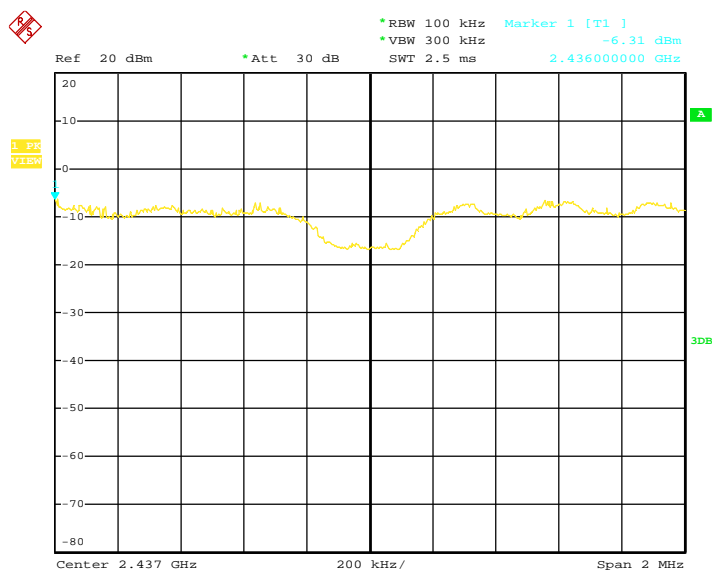

Date: 25.JUL.2013 14:36:33

IEEE 802.11g Channel: High

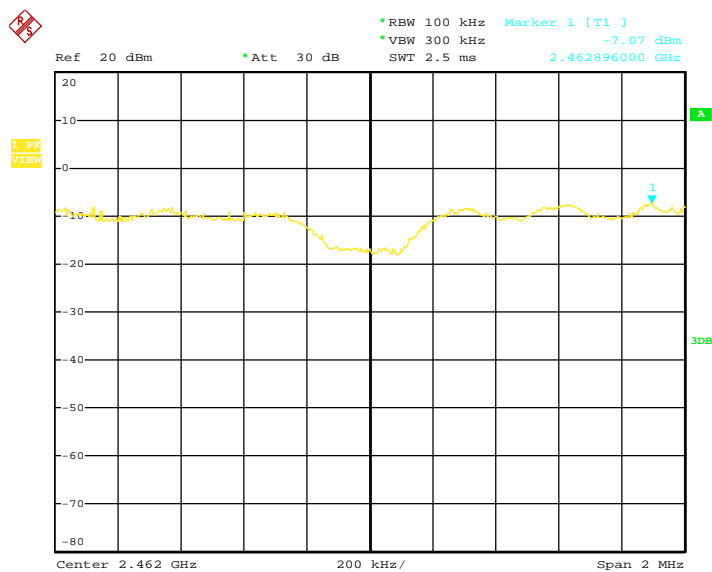

Date: 25.JUL.2013 14:37:47

Draft n MCS0 20MHz Ant.0/2412MHZ (Channel: Low)

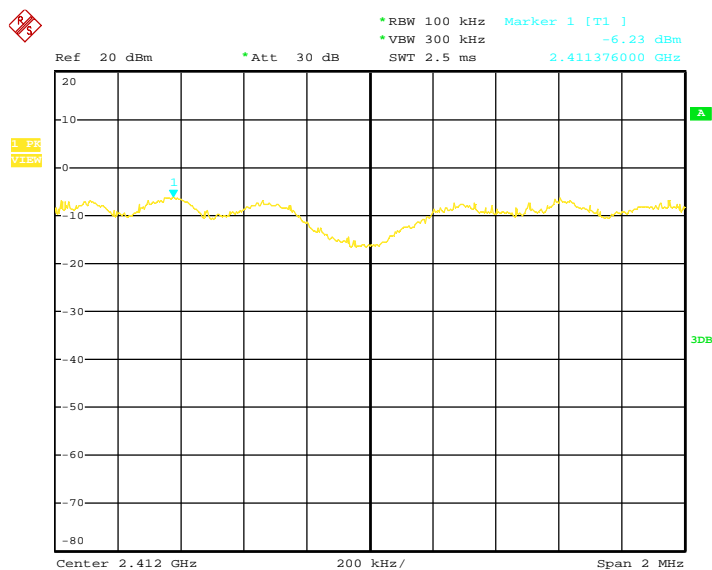

Date: 25.JUL.2013 14:38:52

Draft n MCS0 20MHz Ant.0/2437MHZ (Channel: Mid)

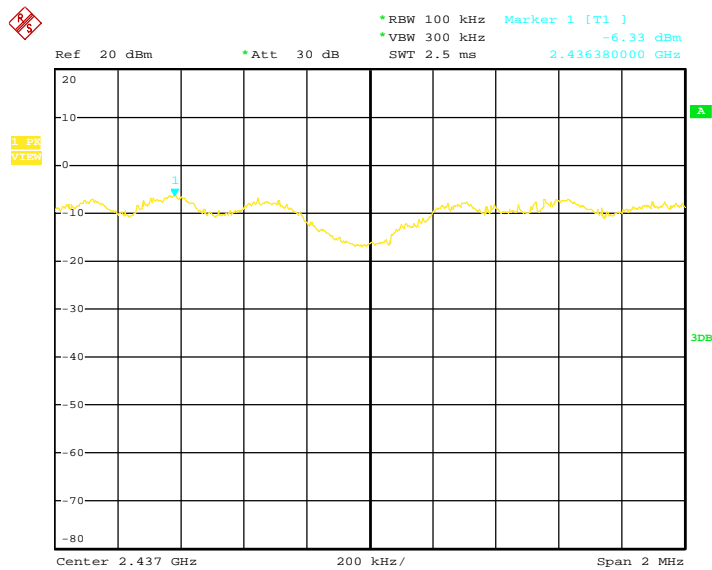

Date: 25.JUL.2013 14:39:46

**Draft n MCS0 20MHz Ant.0/2462MHZ
(Channel: High)**

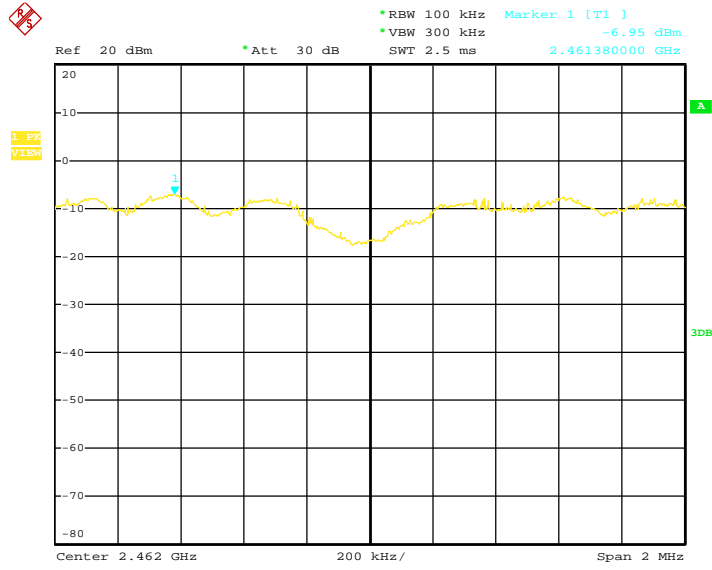

Date: 25.JUL.2013 14:40:28

**Draft n MCS0 40MHz Ant.0/2422MHZ
(Channel: Low)**

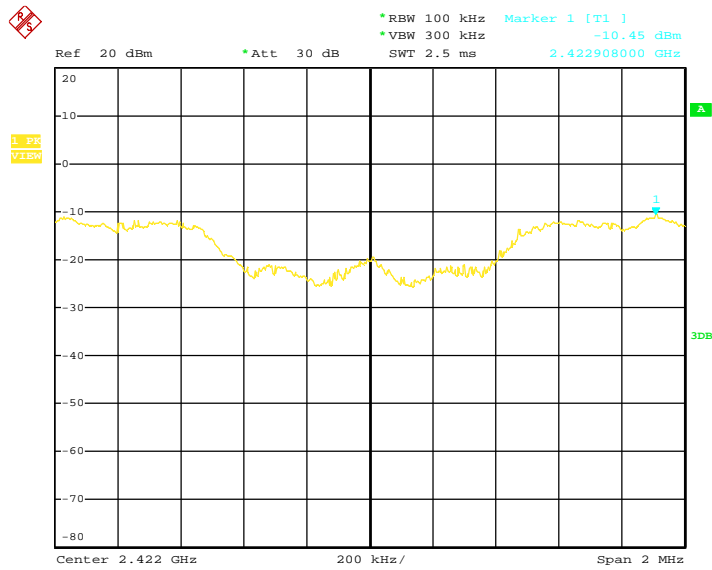

Date: 25.JUL.2013 14:42:39

**Draft n MCS0 40MHz Ant.0/2437MHZ
(Channel: Mid)**

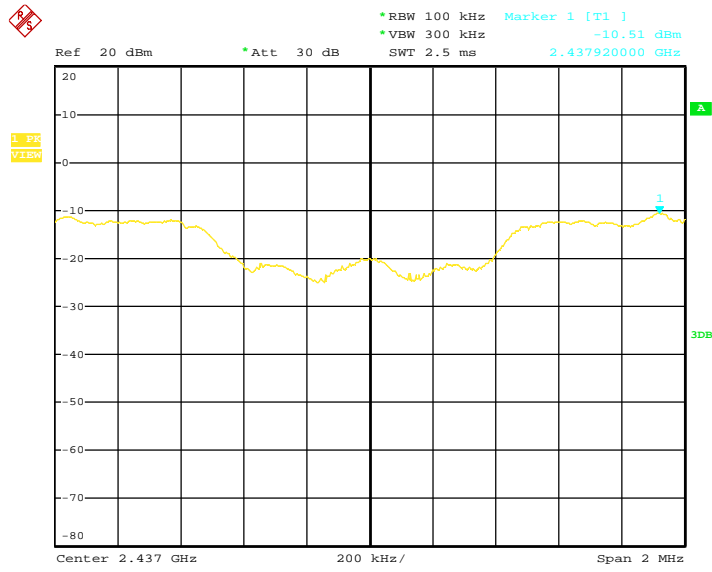

Date: 25.JUL.2013 14:47:20

**Draft n MCS0 40MHz Ant.0/2452MHZ
(Channel: High)**

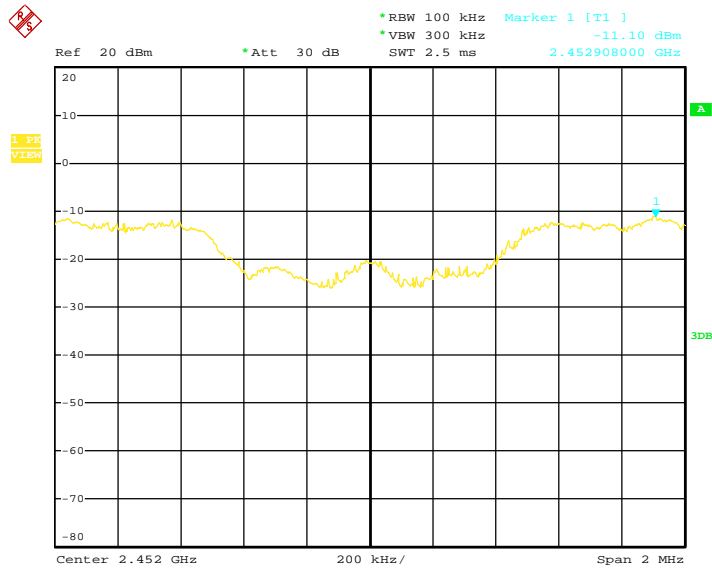

Date: 25.JUL.2013 14:48:17

6. Transmitter Spurious Radiated Emission at 3 Meters

6.1 Test Equipment

Please refer to Section 10 this report.

6.2 Test Procedure

1. The EUT was tested according to ANSI C63.4 - 2003.
2. The EUT, peripherals were put on the turntable which table size is 1m x 1.5 m, table high 0.8 m. All set up is according to ANSI C63.4-2003.
3. The frequency spectrum from 9 kHz to 25 GHz was investigated. All readings from 9 kHz to 150 kHz are quasi-peak values with a resolution bandwidth of 200 Hz. All readings from 150 kHz to 30 MHz are quasi-peak values with a resolution bandwidth of 9 KHz. All readings from 30 MHz to 1 GHz are quasi-peak values with a resolution bandwidth of 120 KHz. All readings are above 1 GHz , peak values with a resolution bandwidth of 1 MHz . Measurements were made at 3 meters.
4. The emissions from the EUT were measured continuously at every azimuth by rotating the turntable. The Receiving antenna high is varied from 1 m to 4 m high to find the maximum emission for each frequency. Emissions below 30MHz were measured with a loop antenna while emission above 30MHz were measured using a broadband E-field antenna.
5. Maximizing procedure was performed on the six (6) highest emissions to ensure EUT compliance is with all installation combinations. All data was recorded in the peak detection mode. Quasi-peak readings was performed only when an emission was found to be marginal (within -4 dB of specification limit), and are distinguished with a "QP" in the data table.
6. Each emission was to be maximized by changing the polarization of receiving antenna both horizontal and vertical. In order to find out the max. emission, the relative positions of this transmitter(EUT) was rotated through three orthogonal axes according to the requirements in Section 8 and 13 of ANSI C63.4 - 2003.

6.3 Test Setup

For Frequencies below 30 MHz

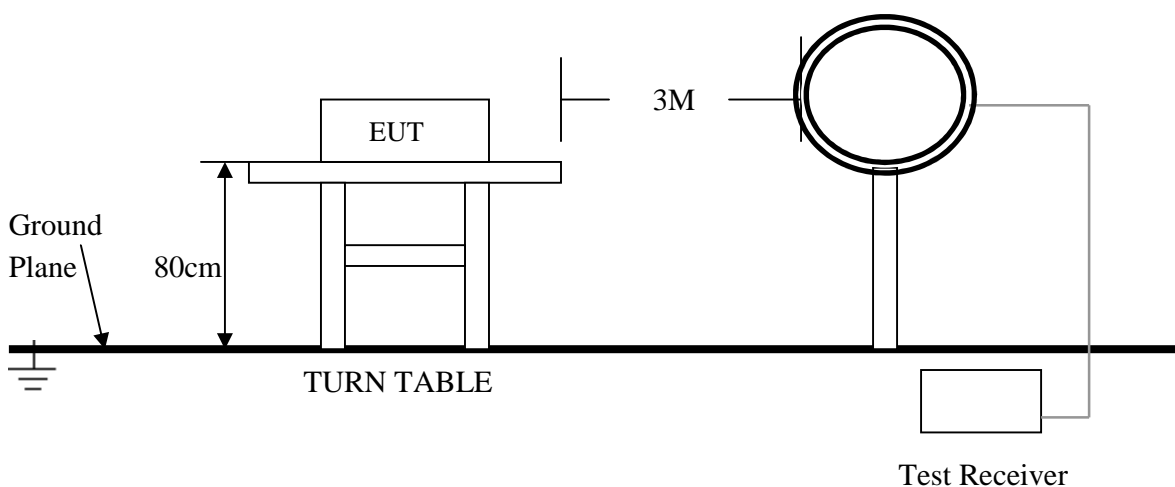

For the actual test configuration , please refer to the related items – Photos of Testing

For Frequencies above 30 MHz

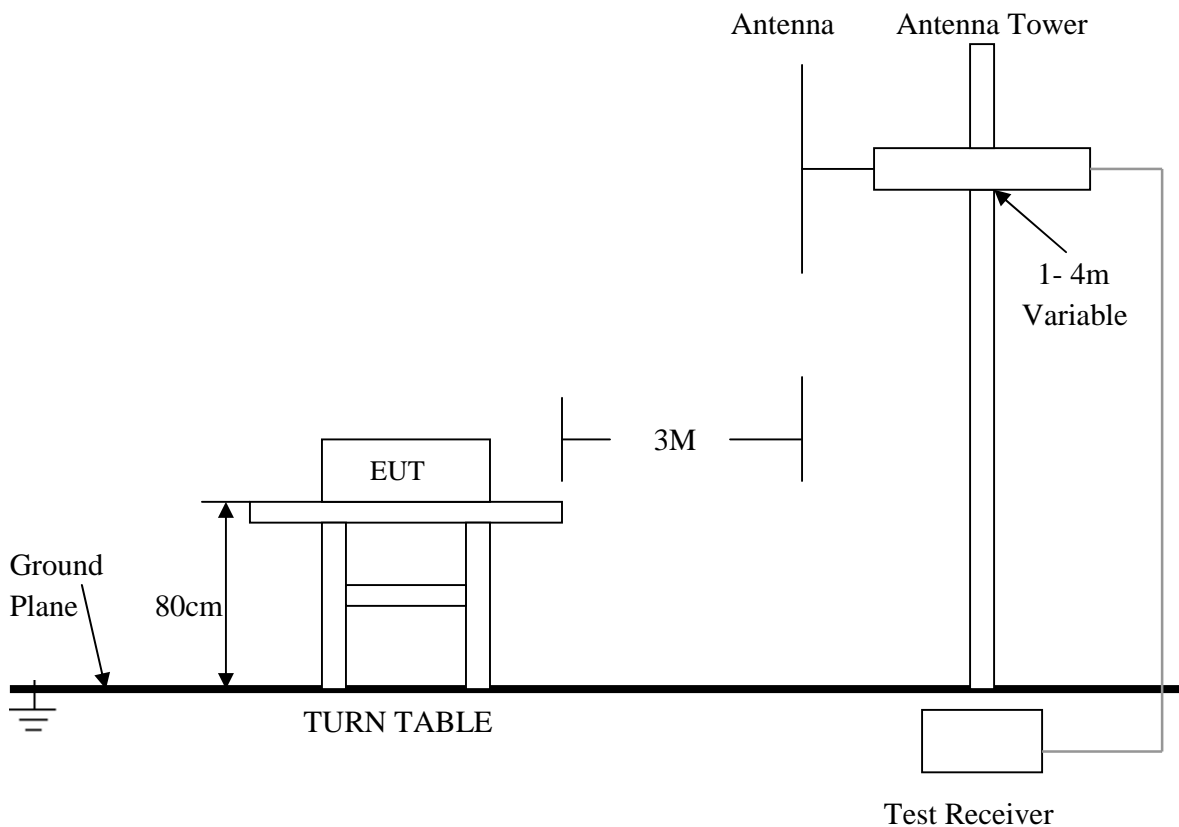

For the actual test configuration , please refer to the related items – Photos of Testing

6. 4 Configuration of the EUT

Same as section 4.4 of this report

6. 5 EUT Operating Condition

Same as section 4.5 of this report.

6.6 Limit

In any 100 KHz bandwidth outside the operating frequency band, the radio frequency power that is produced by modulation products of the spreading sequence, the information sequence and the carrier frequency shall be either at least 20 dB below that in any 100 KHz bandwidth within the band that contains the highest level of the desired power or shall not exceed the general levels specified in section 15.209(a), which lesser attenuation.

All other emissions inside restricted bands specified in section 15.205(a) shall not exceed the general radiated emission limits specified in section 15.209(a)

Note:

Applies to harmonics/spurious emissions that fall in the restricted bands listed in section 15.205. The maximum permitted average field strength is listed in section 15.209.

47 CFR § 15.237(c): The emission limits as specified above are based on measurement instrument employing an average detector. The provisions in section 15.35 for limiting peak emissions apply.

FCC CFR 47, Part 15, Subpart C, Para, 15.205(a) – Restricted Frequency Bands

MHz	MHz	MHz	GHz
0.090–0.110	16.42–16.423	399.9–410	4.5–5.15
10.495–0.505	16.69475–16.69525	608–614	5.35–5.46
2.1735–2.1905	16.80425–16.80475	960–1240	7.25–7.75
4.125–4.128	25.5–25.67	1300–1427	8.025–8.5
4.17725–4.17775	37.5–38.25	1435–1626.5	9.0–9.2
4.20725–4.20775	73–74.6	1645.5–1646.5	9.3–9.5
6.215–6.218	74.8–75.2	1660–1710	10.6–12.7
6.26775–6.26825	108–121.94	1718.8–1722.2	13.25–13.4
6.31175–6.31225	123–138	2200–2300	14.47–14.5
8.291–8.294	149.9–150.05	2310–2390	15.35–16.2
8.362–8.366	156.52475–156.52525	2483.5–2500	17.7–21.4
8.37625–8.38675	156.7–156.9	2655–2900	22.01–23.12
8.41425–8.41475	162.0125–167.17	3260–3267	23.6–24.0
12.29–12.293	167.72–173.2	3332–3339	31.2–31.8
12.51975–12.52025	240–285	3345.8–3358	36.43–36.5
12.57675–12.57725	322–335.4	3600–4400	(2)
13.36–13.41.			

¹ Until February 1, 1999, this restricted band shall be 0.490–0.510 MHz.

² Above 38.6

FCC 47 CFR, Part 15.209(a) – Field Strength Limits within Restricted Frequency Bands

Frequency (MHz)	Field strength (microvolts/meter)	Measurement distance (meters)
0.009–0.490	2400/F(kHz)	300
0.490–1.705	24000/F(kHz)	30
1.705–30.0	30	30
30–88	100**	3
88–216	150**	3
216–960	200**	3
Above 960	500	3

6.7 Test Result

Product : Indoor HD Pan/Tilt Wireless IP Camera Test Mode : IEEE 802.11b/g/Draftn
 Test Item : Spurious Radiated Emissions Temperature : 25 °C
 Test Voltage : DC 5V (Power by Adapter Supply) Humidity : 56%RH
 Test Result : **PASS**

IEEE 802.11b Channel: Low

Freq. (MHz)	Emission (dBuV/m) Peak Detector	HORIZ / VERT	Limits (dBuV/m) Peak / Average	Margin (dB)
4824.00	49.11	HORZ	74.0 / 54.0	-24.89
4824.00	48.34	VERT	74.0 / 54.0	-25.66
7236.00	49.25	HORZ	74.0 / 54.0	-24.75
7236.08	48.78	VERT	74.0 / 54.0	-25.22
9648.02	48.63	HORZ	74.0 / 54.0	-25.37
9648.10	47.39	VERT	74.0 / 54.0	-26.61
24120.04	-	HORZ	74.0 / 54.0	-
24120.20	-	VERT	74.0 / 54.0	-

IEEE 802.11b Channel: Mid

Freq. (MHz)	Emission (dBuV/m) Peak Detector	HORIZ / VERT	Limits (dBuV/m) Peak / Average	Margin (dB)
4874.00	49.61	HORZ	74.0 / 54.0	-24.39
4874.00	48.47	VERT	74.0 / 54.0	-25.53
7311.00	48.98	HORZ	74.0 / 54.0	-25.02
7311.02	47.45	VERT	74.0 / 54.0	-26.55
9748.10	48.36	HORZ	74.0 / 54.0	-25.64
9748.00	47.29	VERT	74.0 / 54.0	-26.71
24370.10	-	HORZ	74.0 / 54.0	-
24370.00	-	VERT	74.0 / 54.0	-

IEEE 802.11b Channel: High

Freq. (MHz)	Emission (dBuV/m) Peak Detector	HORIZ / VERT	Limits (dBuV/m) Peak / Average	Margin (dB)
4924.00	49.34	HORZ	74.0 / 54.0	-24.66
4924.00	48.29	VERT	74.0 / 54.0	-25.71
7386.12	48.71	HORZ	74.0 / 54.0	-25.29
7368.00	48.13	VERT	74.0 / 54.0	-25.87
9848.00	48.69	HORZ	74.0 / 54.0	-25.31
9848.00	48.43	VERT	74.0 / 54.0	-25.57
24620.11	-	HORZ	74.0 / 54.0	-
24620.00	-	VERT	74.0 / 54.0	-

- Note:**
- (1) All Reading Levels below 1GHz are Quasi-Peak, above are peak and average value.
 - (2) Emission Level = Reading Level + Probe Factor + Cable Loss.
 - (3) Receiver setting (Peak Detector) : RBW=1MHz; VBW=1MHz; Span=100MHz
 - (4) Receiver setting (AVG Detector): RBW=1MHz; VBW=30Hz; Span=20MHz
 - (5) The average measurement was not performed when the peak measured data under the limit of average detection. If the readings given are average, peak measurement should also be supplied.
 - (6) Where an emission level is indicated by a -, levels had a margin greater than 20 dB when compared to the limit.

IEEE 802.11g Channel: Low

Freq. (MHz)	Emission (dBuV/m) Peak	HORIZ / VERT	Limits (dBuV/m) Peak / Average	Margin (dB)
4824.00	49.35	HORZ	74.0 / 54.0	-24.65
4824.00	48.23	VERT	74.0 / 54.0	-25.77
7236.00	48.47	HORZ	74.0 / 54.0	-25.53
7236.08	47.39	VERT	74.0 / 54.0	-26.61
9648.02	48.78	HORZ	74.0 / 54.0	-25.22
9648.10	47.45	VERT	74.0 / 54.0	-26.55
24120.04	-	HORZ	74.0 / 54.0	-
24120.20	-	VERT	74.0 / 54.0	-

IEEE 802.11g Channel: Mid

Freq. (MHz)	Emission (dBuV/m) Peak	HORIZ / VERT	Limits (dBuV/m) Peak / Average	Margin (dB)
4874.00	49.99	HORZ	74.0 / 54.0	-24.01
4874.00	48.47	VERT	74.0 / 54.0	-25.53
7311.00	48.38	HORZ	74.0 / 54.0	-25.62
7311.02	47.29	VERT	74.0 / 54.0	-26.71
9748.10	48.78	HORZ	74.0 / 54.0	-25.22
9748.00	47.41	VERT	74.0 / 54.0	-26.59
24370.10	-	HORZ	74.0 / 54.0	-
24370.00	-	VERT	74.0 / 54.0	-

IEEE 802.11g Channel: High

Freq. (MHz)	Emission (dBuV/m) Peak	HORIZ / VERT	Limits (dBuV/m) Peak / Average	Margin (dB)
4924.00	48.63	HORZ	74.0 / 54.0	-25.37
4924.00	47.59	VERT	74.0 / 54.0	-26.41
7386.12	48.87	HORZ	74.0 / 54.0	-25.13
7368.00	48.26	VERT	74.0 / 54.0	-25.74
9848.00	48.19	HORZ	74.0 / 54.0	-25.81
9848.00	48.38	VERT	74.0 / 54.0	-25.62
24620.11	-	HORZ	74.0 / 54.0	-
24620.00	-	VERT	74.0 / 54.0	-

- Note:**
- (1) All Reading Levels below 1GHz are Quasi-Peak, above are peak and average value.
 - (2) Emission Level = Reading Level + Probe Factor + Cable Loss.
 - (3) Receiver setting (Peak Detector) : RBW=1MHz; VBW=1MHz; Span=100MHz
 - (4) Receiver setting (AVG Detector): RBW=1MHz; VBW=30Hz; Span=20MHz
 - (5) The average measurement was not performed when the peak measured data under the limit of average detection. If the readings given are average, peak measurement should also be supplied.
 - (6) Where an emission level is indicated by a -, levels had a margin greater than 20 dB when compared to the limit.

Draft n MCS8 20MHz Ant.0 Channel: Low

Freq. (MHz)	Emission (dBuV/m) Peak /Av	HORIZ / VERT	Limits (dBuV/m) Peak / Average	Margin (dB)
4824.00	49.24	HORZ	74.0 / 54.0	-24.76
4824.00	48.39	VERT	74.0 / 54.0	-25.61
7236.00	49.86	HORZ	74.0 / 54.0	-24.14
7236.08	49.55	VERT	74.0 / 54.0	-24.45
9648.02	49.31	HORZ	74.0 / 54.0	-24.69
9648.10	48.29	VERT	74.0 / 54.0	-25.71
24120.04	-	HORZ	74.0 / 54.0	-
24120.20	-	VERT	74.0 / 54.0	-

Draft n MCS8 20MHz Ant.0 Channel: Mid

Freq. (MHz)	Emission (dBuV/m) Peak	HORIZ / VERT	Limits (dBuV/m) Peak / Average	Margin (dB)
4874.00	49.45	HORZ	74.0 / 54.0	-24.55
4874.00	48.14	VERT	74.0 / 54.0	-25.86
7311.00	49.76	HORZ	74.0 / 54.0	-24.24
7311.02	48.43	VERT	74.0 / 54.0	-25.57
9748.10	49.29	HORZ	74.0 / 54.0	-24.71
9748.00	48.43	VERT	74.0 / 54.0	-25.57
24370.10	-	HORZ	74.0 / 54.0	-
24370.00	-	VERT	74.0 / 54.0	-

Draft n MCS8 20MHz Ant.0 Channel: High

Freq. (MHz)	Emission (dBuV/m) Peak /Av	HORIZ / VERT	Limits (dBuV/m) Peak / Average	Margin (dB)
4924.00	49.73	HORZ	74.0 / 54.0	-24.27
4924.00	48.22	VERT	74.0 / 54.0	-25.78
7386.12	49.35	HORZ	74.0 / 54.0	-24.65
7368.00	47.74	VERT	74.0 / 54.0	-26.26
9848.00	49.59	HORZ	74.0 / 54.0	-24.41
9848.00	48.29	VERT	74.0 / 54.0	-25.71
24620.11	-	HORZ	74.0 / 54.0	-
24620.00	-	VERT	74.0 / 54.0	-

- Note:**
- (1) All Reading Levels below 1GHz are Quasi-Peak, above are peak and average value.
 - (2) Emission Level = Reading Level + Probe Factor + Cable Loss.
 - (3) Receiver setting (Peak Detector) : RBW=1MHz; VBW=1MHz; Span=100MHz
 - (4) Receiver setting (AVG Detector): RBW=1MHz; VBW=30Hz; Span=20MHz
 - (5) The average measurement was not performed when the peak measured data under the limit of average detection. If the readings given are average, peak measurement should also be supplied.
 - (6) Where an emission level is indicated by a -, levels had a margin greater than 20 dB when compared to the limit.

Draft n MCS8 40MHz Ant.0 Channel: Low

Freq. (MHz)	Emission (dBuV/m) Peak /Av	HORIZ / VERT	Limits (dBuV/m) Peak / Average	Margin (dB)
4844.00	48.25	HORZ	74.0 / 54.0	-25.75
4844.00	47.31	VERT	74.0 / 54.0	-26.69
7266.00	49.93	HORZ	74.0 / 54.0	-24.07
7266.08	48.28	VERT	74.0 / 54.0	-25.72
9688.02	49.47	HORZ	74.0 / 54.0	-24.53
9688.10	48.33	VERT	74.0 / 54.0	-25.67
24220.04	-	HORZ	74.0 / 54.0	-
24220.20	-	VERT	74.0 / 54.0	-

Draft n MCS8 40MHz Ant.0 Channel: Mid

Freq. (MHz)	Emission (dBuV/m) Peak	HORIZ / VERT	Limits (dBuV/m) Peak / Average	Margin (dB)
4874.00	49.65	HORZ	74.0 / 54.0	-24.35
4874.00	48.44	VERT	74.0 / 54.0	-25.56
7311.00	49.19	HORZ	74.0 / 54.0	-24.81
7311.02	48.28	VERT	74.0 / 54.0	-25.72
9748.10	49.41	HORZ	74.0 / 54.0	-24.59
9748.00	48.63	VERT	74.0 / 54.0	-25.37
24370.10	-	HORZ	74.0 / 54.0	-
24370.00	-	VERT	74.0 / 54.0	-

Draft n MCS8 40MHz Ant.0 Channel: High

Freq. (MHz)	Emission (dBuV/m) Peak /Av	HORIZ / VERT	Limits (dBuV/m) Peak / Average	Margin (dB)
4904.00	49.38	HORZ	74.0 / 54.0	-24.62
4904.00	48.22	VERT	74.0 / 54.0	-25.78
7356.12	49.58	HORZ	74.0 / 54.0	-24.42
7356.00	48.41	VERT	74.0 / 54.0	-25.59
9808.00	49.67	HORZ	74.0 / 54.0	-24.33
9808.00	48.86	VERT	74.0 / 54.0	-25.14
24520.11	-	HORZ	74.0 / 54.0	-
24520.00	-	VERT	74.0 / 54.0	-

- Note:**
- (1) All Reading Levels below 1GHz are Quasi-Peak, above are peak and average value.
 - (2) Emission Level = Reading Level + Probe Factor + Cable Loss.
 - (3) Receiver setting (Peak Detector) : RBW=1MHz; VBW=1MHz; Span=100MHz
 - (4) Receiver setting (AVG Detector): RBW=1MHz; VBW=30Hz; Span=20MHz
 - (5) The average measurement was not performed when the peak measured data under the limit of average detection. If the readings given are average, peak measurement should also be supplied.
 - (6) Where an emission level is indicated by a -, levels had a margin greater than 20 dB when compared to the limit.

General Radiated Emission Data

Product : Indoor HD Pan/Tilt Wireless IP Camera Test Mode : 802.11b_CH Mid
 Test Item : Fundamental Radiated Emission Data Temperature : 25 °C
 Test Voltage : DC 5V(by DC Adapter) Humidity : 56%RH
 Test Result : **PASS** Model :

For Frequency Below 30MHz

Freq. (MHz)	Emission (dBuV/m) QP Detector	HORIZ / VERT	Limits (dBuV/m)	Margin (dB)
N/A	N/A	N/A	N/A	N/A

- Note:**
- (1) All Readings below 1GHz are Quasi-Peak, above are performed with peak and/or average measurements as necessary.
 - (2) "N/A" remark, if no specific emissions from the EUT are recorded (ie: margin>20dB from the applicable limit) and considered that's already beyond the background noise floor.
 - (3) Emission Level = Reading Level + Probe Factor + Cable Loss.

For Frequency Above 30MHz

Adapter Model: SAW-0502000

Freq. (MHz)	Emission (dBuV/m) QP Detector	HORIZ / VERT	Limits (dBuV/m)	Margin (dB)
127.200	29.53	HORZ	43.5	-13.97
30.960	34.22	VERT	40.0	-5.78
156.040	32.23	HORZ	43.5	-11.27
39.520	33.94	VERT	40.0	-6.06
245.360	39.52	HORZ	46.0	-6.48
245.320	41.02	VERT	46.0	-4.98

- Note:**
- (1) All Readings below 1GHz are Quasi-Peak, above are performed with peak and/or average measurements as necessary.
 - (2) "N/A" remark, if no specific emissions from the EUT are recorded (ie: margin>20dB from the applicable limit) and considered that's already beyond the background noise floor.
 - (3) Emission Level = Reading Level + Probe Factor + Cable Loss.

7. RF Exposure Requirements

7.1 Test Equipment

Please refer to Section 10 this report.

7.2 Limit

According to FCC 15.247(i), Systems operating under provisions of this section shall be operated in a manner that ensures that the public is not exposed to radio frequency energy levels in excess of the Commissions guidelines.

FCC 1.1310: The criteria listed in the following table shall be used to evaluate the environmental impact of human exposure to radio-frequency (RF) radiation as specified in 1.1307(b)(1) of this chapter.

TABLE 1—LIMITS FOR MAXIMUM PERMISSIBLE EXPOSURE (MPE)

Frequency range (MHz)	Electric field strength (V/m)	Magnetic field strength (A/m)	Power density (mW/cm ²)	Averaging time (minutes)
(A) Limits for Occupational/Controlled Exposures				
0.3–3.0	614	1.63	*(100)	6
3.0–30	1842/f	4.89/f	*(900/f ²)	6
30–300	61.4	0.163	1.0	6
300–1500			f/300	6
1500–100,000			5	6
(B) Limits for General Population/Uncontrolled Exposure				
0.3–1.34	614	1.63	*(100)	30
1.34–30	824/f	2.19/f	*(180/f ²)	30
30–300	27.5	0.073	0.2	30
300–1500			f/1500	30
1500–100,000			1.0	30

f = frequency in MHz

* = Plane-wave equivalent power density

NOTE 1 TO TABLE 1: Occupational/controlled limits apply in situations in which persons are exposed as a consequence of their employment provided those persons are fully aware of the potential for exposure and can exercise control over their exposure. Limits for occupational/controlled exposure also apply in situations when an individual is transient through a location where occupational/controlled limits apply provided he or she is made aware of the potential for exposure.

NOTE 2 TO TABLE 1: General population/uncontrolled exposures apply in situations in which the general public may be exposed, or in which persons that are exposed as a consequence of their employment may not be fully aware of the potential for exposure or can not exercise control over their exposure.

7.3 Test Result

Product	: Indoor HD Pan/Tilt Wireless IP Camera	Test Mode	: IEEE 802.11b/g/n
Test Item	: RF Exposure	Temperature	: 25 °C
Test Voltage	: DC 5V (Power by DC Power Supply)	Humidity	: 56%RH
Test Result	: PASS		

Evaluation of RF Exposure Compliance Requirements	
MPE Prediction of MPE according to equation from page 19 of OET Bulletin 65, Edition 97-01	
RF Exposure Requirements	Compliance with FCC Rules
S=PG/4πR ² Where: S=Power density P=Power input to antenna G=Power gain of the antenna relative to an isotropic radiator R=Distance to the center of radiation of the antenna	Maximum output power at antenna input terminal: 7.16 dBm = 5.20 mW (802.11b/g, 2412MHz) 2.24 dBm = 1.67 mW (802.11n, 2437MHz) Prediction distance: 20 cm Antenna gain : 2.00 dBi MPE limit for uncontrolled exposure at prediction frequency: 10 W/m ² Power density at 20 cm: 802.11b/g: 0.00164 mW/cm ² 802.11n : 0.00051mW/cm ²

8. Photos of Testing

8.1 EUT Test Photographs

Conducted emission test view



Radiated emission test view



8. 2 EUT Detailed Photographs

FI9821W

EUT top view





EUT bottom view





EUT inside whole view



Main & RF board component side

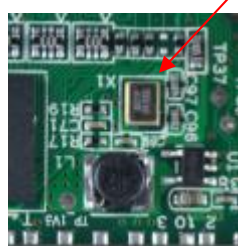

Crystal 1



Crystal 2

RF Module

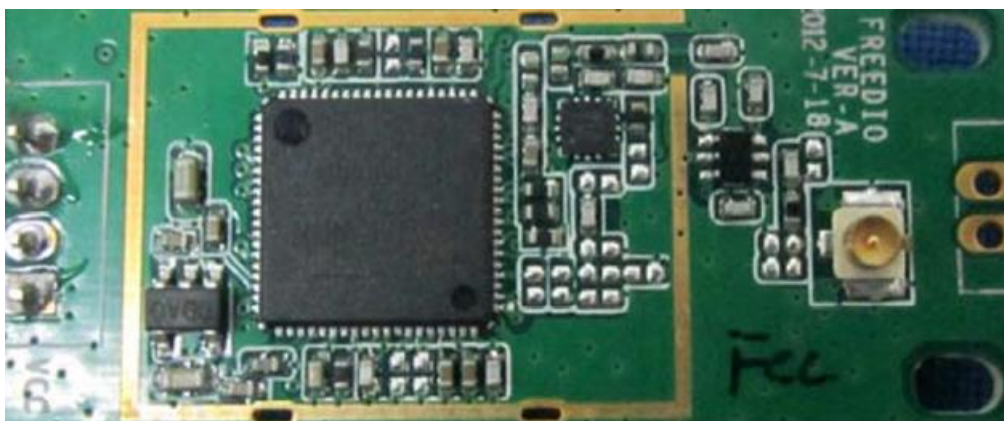

Main & RF board solder side



Crystal 3

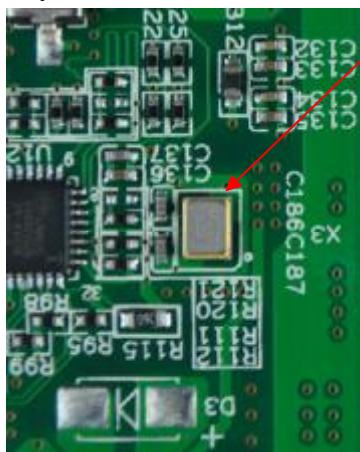

Adapter top view



Adapter side view



Adapter inside whole view

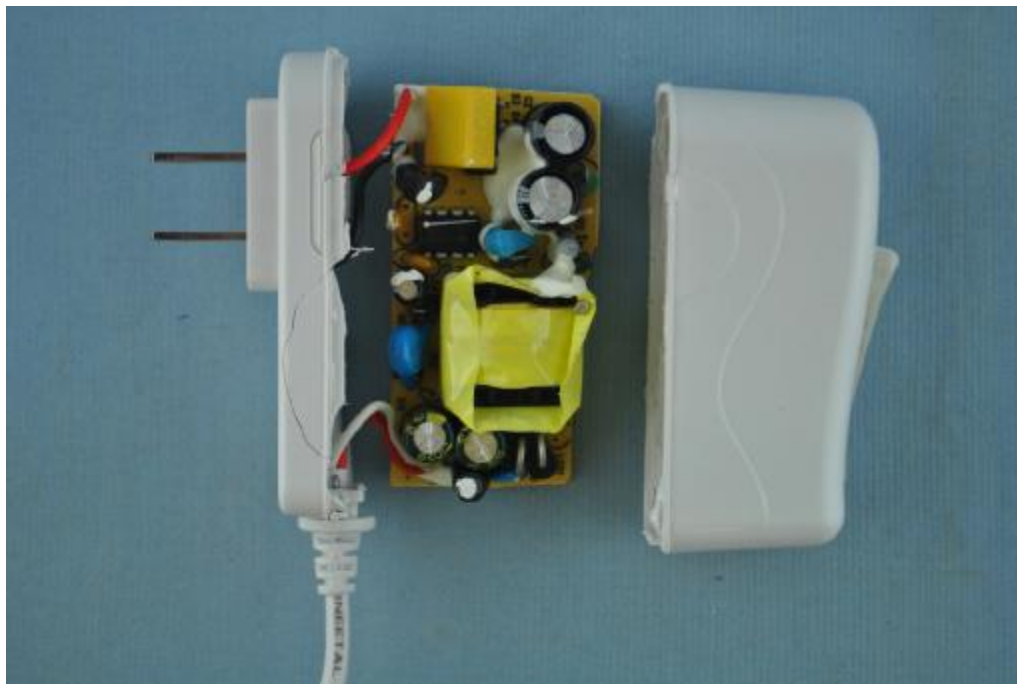

Adapter PCB rear view

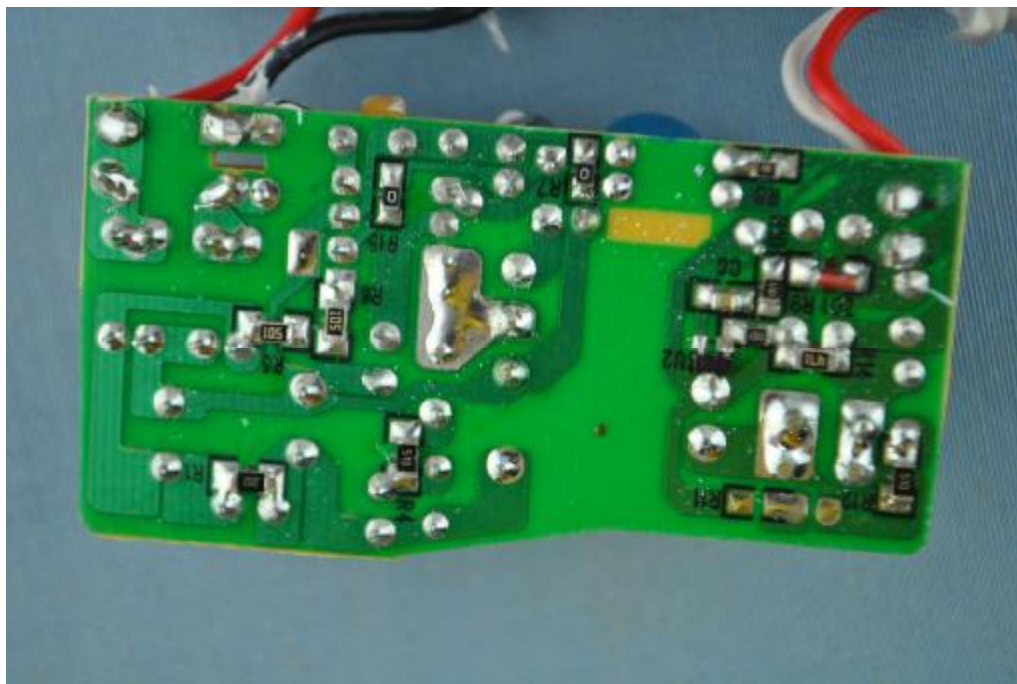

FI9831W

EUT top view



EUT bottom view



Adapter top view



Adapter side view



9. FCC ID Label

FCC ID: ZDEFI9821W

This device complies with Part 15 of the FCC Rules. Operation is subject to the following two conditions: (1) this device may not cause harmful interference, and (2) this device must accept any interference received, including interference that may cause undesired operation.

The Label must not be a stick-on paper label. The Label on these products must be permanently affixed to the product and readily visible at the time of purchase and must last the expected lifetime of the equipment not be readily detachable.

Proposed Label Location on EUT

EUT Bottom View/Proposed FCC ID Label Location



10. Test Equipment

The following test equipments were used during the radiated & conducted emission test:

Equipment/ Facilities	Manufacturer	Model #	Serial No.	Due Date
Turntable	SinTek	N/A	N/A	NCR
Antenna Tower	SinTek	N/A	N/A	NCR
OATS	SinTek	N/A	N/A	Sep.28, 2013
Pre-Amplifier	Agilent	87405C	KMO-SZ155	Dec.6, 2013
Pre-Amplifier	Com-Power	PAM-840	KMO-SZ156	Dec.6, 2013
Horn Antenna	Com-Power	AH-840	KMO-SZ157	Dec.6, 2013
EMI Test Receiver	Rohde & Schwarz	ESPI7	KMO-SZ002	June 27, 2014
Spectrum Analyzer	Rohde & Schwarz	FSP40	KMO-SZ003	June 27, 2014
Loop Antenna	Rohde & Schwarz	HFH2-Z2	KMO-SZ004	Jan. 30, 2014
Trilog-Super Broadband Antenna	SCHWARZBECK	VULB9161	KMO-SZ005	Sep.18, 2013
Trilog-Super Broadband Antenna	SCHWARZBECK	VULB9161	KMO-SZ006	Sep.18, 2013
Broad-Band Horn Antenna	SCHWARZBECK	BBHA 9120D	KMO-SZ007	Sep.18, 2013
Broad-Band Horn Antenna	SCHWARZBECK	BBHA 9120D	KMO-SZ008	Sep.18, 2013
AMN	Rohde & Schwarz	ESH3-Z5	KMO-SZ009	June 27, 2014
Pulse Limiter	SCHWARZBECK	VTSD 9561-F	KMO-SZ077	June 27, 2014
ISN	SCHWARZBECK	NTFM 8158 CAT3	KMO-SZ070	Nov.19, 2013
ISN	SCHWARZBECK	NTFM 8158 CAT5	KMO-SZ071	Nov.19, 2013
ISN	SCHWARZBECK	NTFM 8158 CAT6	KMO-SZ072	Nov.19, 2013
KMO Shielded Room	KMO	KMO-001	N/A	N/A
Coaxial Cable with N-Connectors	SCHWARZBECK	AK9515H	KMO-SZ037	Sep.18, 2013
SOHO Telephone Switching System	IKE	2000-108C	N/A	NCR
3m Anechoic Chamber	KMO	KMO-3AC	KMO-3AC-1	May 29, 2014