

FOSCAM

User Manual

Model: FI9818W V2

Indoor HD Pan/Tilt Wireless IP Camera



Black



White

Table of Contents

1 Overview.....	1
1.1 Key Features	1
1.2 Read Before Use	2
1.3 Package Contents	2
1.4 Physical Description	2
2 Access the IP Camera	3
2.1 Access the Camera in LAN.....	3
2.2 Access the Camera in WAN.....	7
2.3 Using the VLC player.....	12
2.4 IP camera connection to the server.....	14
3 Surveillance Software GUI.....	15
3.1 Login Window	15
3.2 Surveillance Window	16
4 Advanced Camera Settings	22
4.1 Status.....	22
4.2 Basic Settings.....	25
4.3 Network.....	33
4.4 Video.....	54
4.5 Alarm.....	57
4.6 Record	60
4.7 PTZ.....	62
4.8 Firewall	66
4.9 System.....	67
5 APPENDIX.....	69
5.1 Frequently Asked Questions.....	69
5.2 Default Parameters.....	75
5.3 Specifications.....	75
5.4 CE & FCC	76
5.5 WARRANTY	77
6 OBTAINING TECHNICAL SUPPORT.....	80

1 Overview

FOSCAM FI9818W V2 is an integrated wireless IP Camera with a color CMOS sensor enabling viewing resolution 1280*720. It combines a high quality digital video camera, with a powerful web server, to bring clear video to your desktop from anywhere on your local network or over the Internet.

With flexible 300-degree pan and 120-degree tilt, FI9818W V2 gives users more comprehensive control over a monitored site. The FI9818W V2 supports the industry-standard H.264 compression technology, drastically reducing file sizes and conserving valuable network bandwidth.

The IPCAM is based on the TCP/IP standard. There is a WEB server inside which could support Internet Explore. Therefore the management and maintenance of your device is simplified by using the network to achieve the remote configuration and start-up.

The camera is designed for indoor surveillance applications such as retail stores, offices or banks. Controlling the IPCAM and managing images are simplified by using the provided web interface across the network utilizing wireless connectivity.

FOSCAM provides Smart Phone APP for Android and iPhone users, please search and install Foscam Viewer on on APP Store or Google Play for iOS or Android devices, then you can view your camera anywhere, anytime on your smart mobile devices.

1.1 Key Features

- Standard H.264 video compression algorithm to satisfy the transmission of high definition video in narrow bandwidth network
- Megapixel HD video
- Pan 300 degree, tilt 120 degree
- Support IE/Firefox/Google/Safari browser
- Support WEP,WPA-PSK and WPA2-PSK Encryption
- Wireless connection is compliant with IEEE 802.11b/g/n WI-FI, up to 150Mbps
- IR night vision (Range: 8m)
- Support image snapshot
- Support dual-stream
- Support IR-Cut auto switch
- Embedded free FOSCAM DDNS(dynamic domain name service) Service
- Supporting the Third Party Domain Name Service
- Support two-way audio
- Support ONVIF protocols
- Multi-level users management with password protection
- Motion detection alert via email or upload image to FTP
- Providing free Android and iPhone APP for viewing live video Providing free Central Management Software

to manage and monitor multiple cameras

- Support record schedule

1.2 Read Before Use

Please first verify that all contents received are complete according to the Package Contents listed below. Before the IP Camera is installed, please carefully read and follow the instructions in the Quick Installation Guide to avoid damage due to faulty assembly and installation. This also ensures the product is used properly as intended.

1.3 Package Contents

● IP Camera × 1	● DC Power Adapter × 1
● WI-FI Antenna × 1	● Mounting bracket × 1
● Ethernet Cable × 1	● CD×1
● Quick Installation Guide × 1	● Warranty Card × 1

1.4 Physical Description

Front Panel

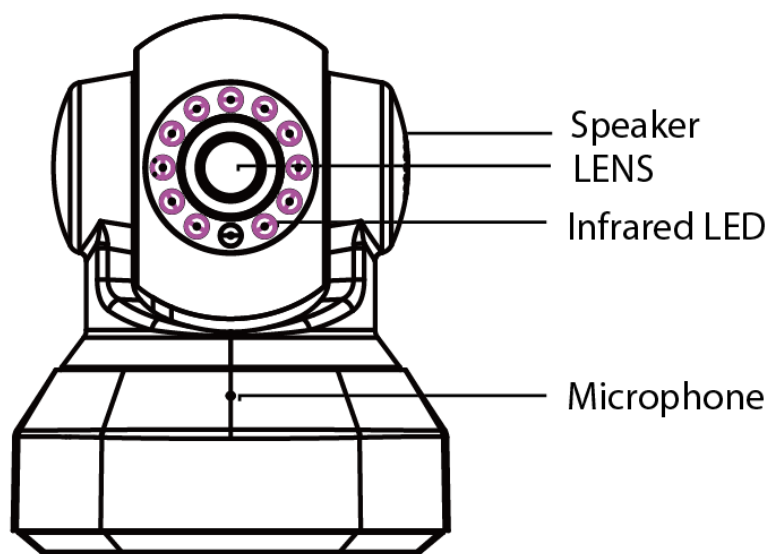

Figure 1.1

- 1.Speaker:** Built-in speaker
- 2.LENS:** Fixed focus lens
- 3.Infrared LED:** Infrared LEDs for night vision
- 4.Microphone:** Built-in microphone

LAN: RJ-45/10-100 Base T

Power: DC 5V/2A Power supply

Power Light: If the power adapter works well, the light will turn on.

Network Light: The LED will blink when power and network cable are plugged in

Audio Input: This jack is used to plug an external microphone

Audio Output: This jack is used to plug an external speaker

Bottom View

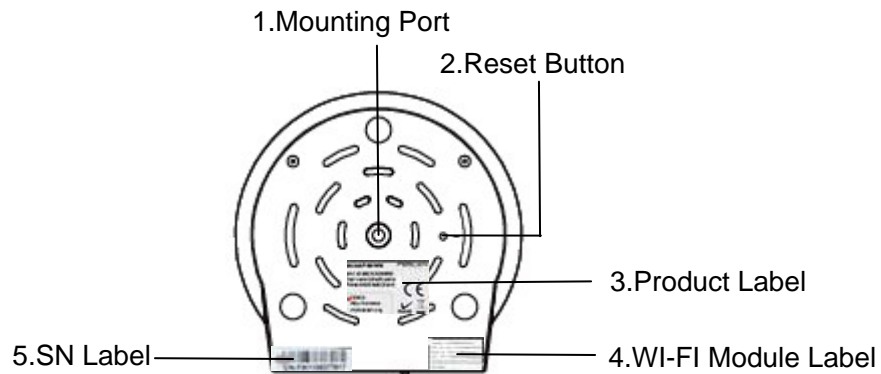

Figure 1.3

1. Mounting Port: Port for mounting bracket

2. Reset Button: Push and hold for more than 5 seconds to set the camera to factory default

3. Product Label: There are MAC address, DDNS URL, default username and password on the label

4. WI-FI Module Label: There is WI-FI MAC address and serial number of the WI-FI module on the label

5. SN Label: There is serial number of the camera on the label

2 Access the IP Camera

This chapter explains how to access the camera through browser and RTSP player.

2.1 Access the Camera in LAN

This camera supports HTTP and HTTPS protocols, you can access the camera by two ways.

(1) **http:// LAN IP + HTTP Port NO.**

The default HTTP port no is 88. Double click the IP Camera Tool icon to run, and it should find the camera's IP address automatically after you plug in the network cable.



Camera name	IP Address	Device ID	Device type
IPCAM	Http://192.168.11.220:88	00626E4D8A55	H

Figure 2.1

Double click the IP address of the camera; your default browser will open to the camera login page.

(2) https:// LAN IP + HTTPS Port NO.

The default Https port no. is 443. You can use the url to access the camera: https:// LAN IP + HTTPS port. Go to **Settings - Network - Port** panel , you can see and change the http and https port no.



	Port
HTTP Port	88
HTTPS Port	443
ONVIF Port	65533

Figure 2.2

HTTPS(Hypertext Transfer Protocol over Secure Socket Layer) is a safe way to access your camera, the data transferred on the Internet will be encrypted. Since we can not apply license for every LAN or DDNS URL, the webpage may pop up a warning like the following picture, you just need to click “Continue to this website (not recommended).”

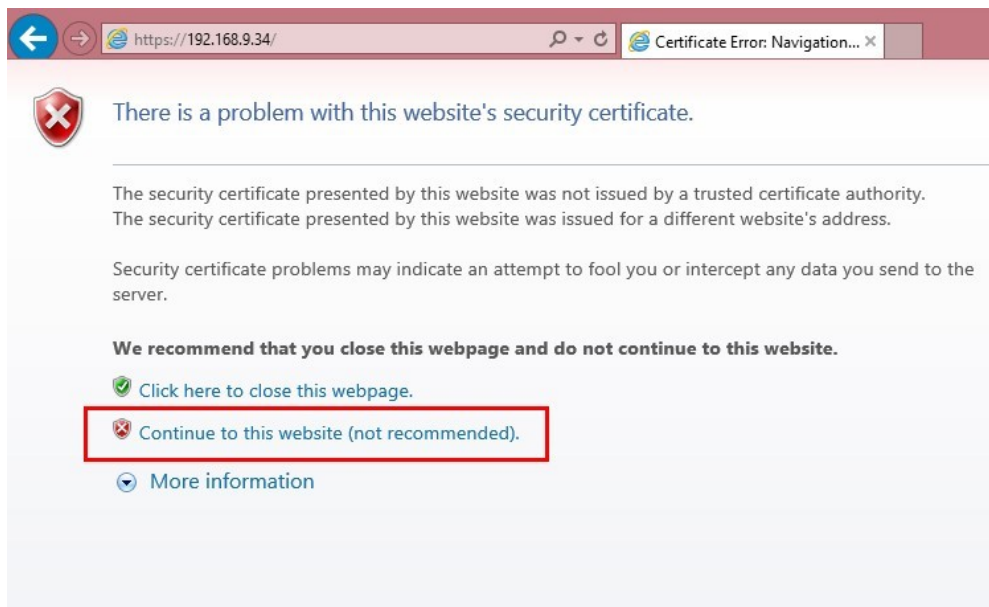

Figure 2.3

Open **Internet Explorer** if it is not already opened. Click on **Tools**, then click Internet Options. Next, click the **Security** tab, then click the **Trusted sites** button. Finally ,click the **Confirm** button.

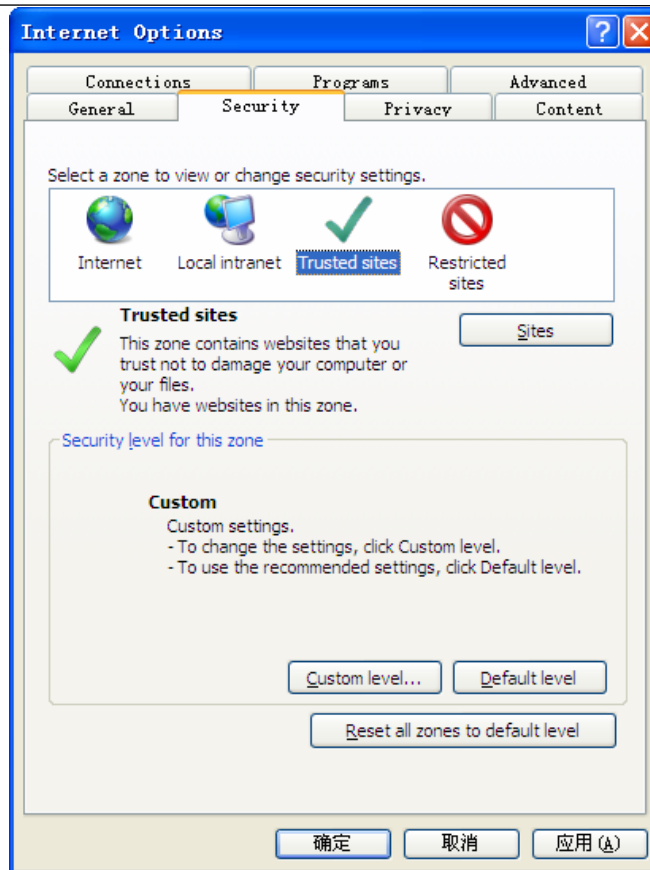

Figure 2.4

For **Firefox**, you can add the trusted as the following way:

Tools --Options -- Advanced -- View Certificates -- Servers

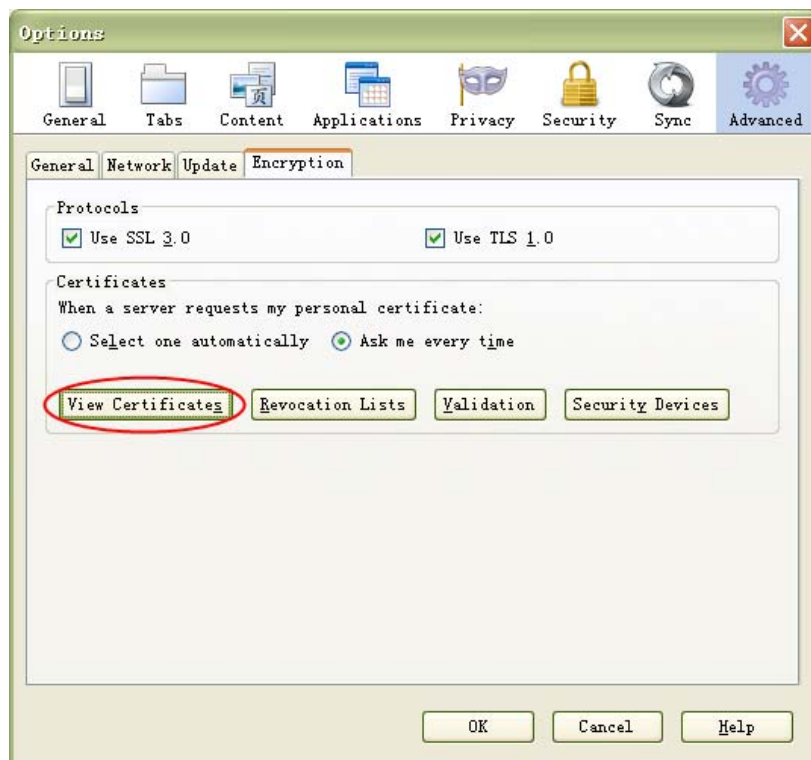

Figure 2.5

Click **View Certificates**, and go to **Servers** option.

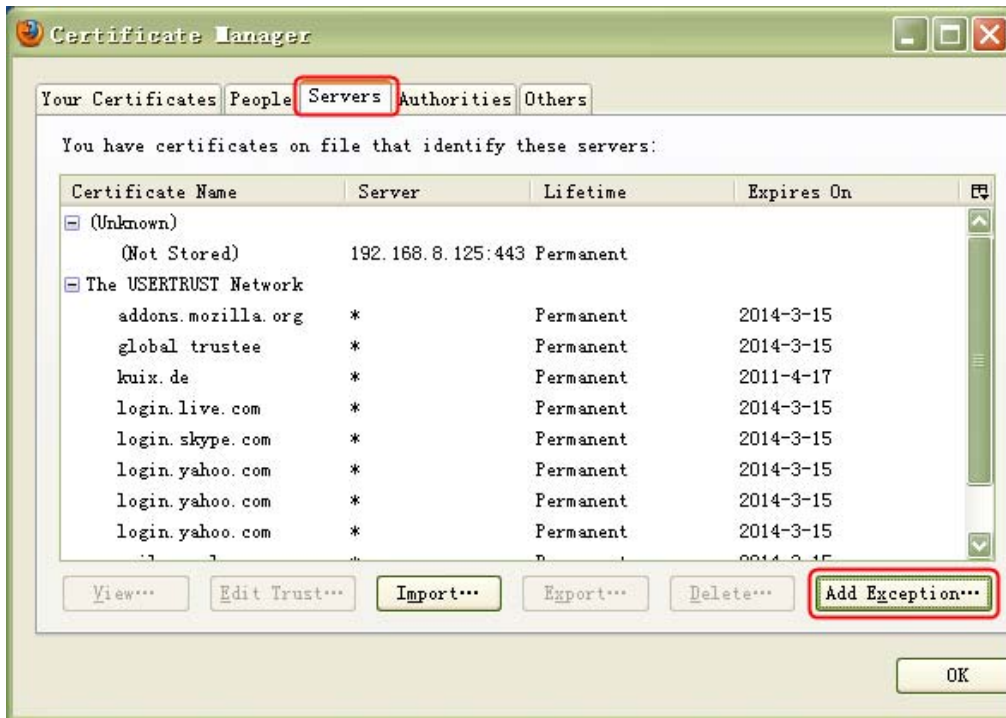

Figure 2.6

Go to **Add Exception** panel.

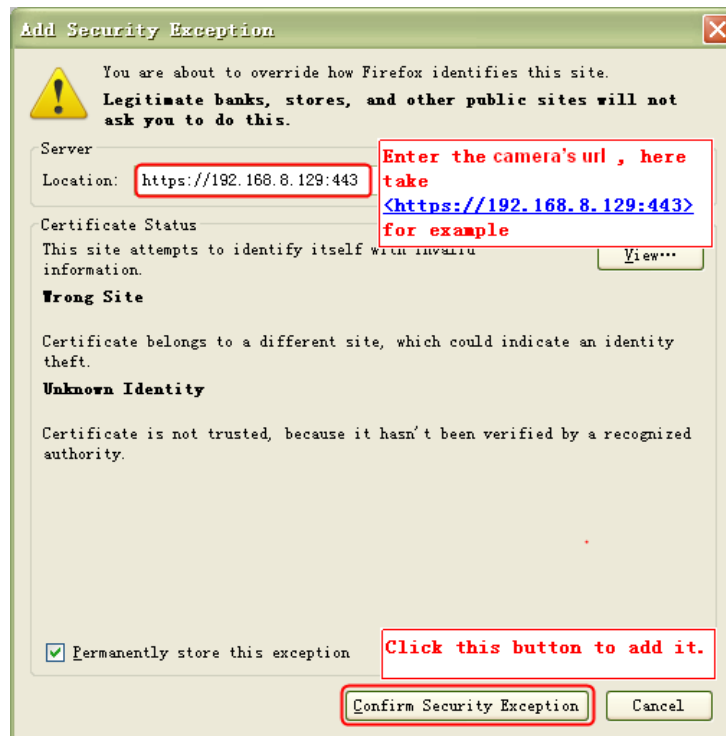

Figure 2.7

2.2 Access the Camera in WAN

2.2.1 Static IP Addresses

Users who have static IP addresses do not need to set DDNS service settings for remote access. When you have finished connecting the camera using the LAN IP address and port forwarding, you can access the camera directly from the Internet using the WAN IP address and port number.

How to Obtain the WAN IP address from a public website ?

To obtain your WAN IP address, enter the following URL in your browser: <http://www.whatismyip.com>. The webpage at this address will show you the current WAN IP.



Figure 2.8

Access your IP Camera from the Internet

You can access the IP Camera from the Internet (remote access). Enter the WAN IP address and port number in your standard browser. For example, you would enter `http:// 183.37.28.254:85`

NOTE :

Make sure port forwarding is successful. You can do port forwarding two ways.

Shenzhen Foscam Intelligent Technology Co., Limited

Tel: 86 755 2674 5668 Fax: 86 755 2674 5168

Login to your router to enable the “UPnP” function. You can then login to the camera as administrator, choose Network, and then choose UPnP to enable UPnP. Make sure that the status of UPnP reads “UPnP Successful” on the Status page.

Do port (HTTP port and Media port) forwarding manually.

If your router has a Virtual Server, it can do port forwarding. Add the camera’s LAN IP and port which you had set earlier to your router’s port forwarding settings.

Note: If you plug the camera into a router, it will have a dynamic IP address and you need to set DDNS service settings to view it remotely.

2.2.2 Dynamic IP Addresses

DDNS is a service that allows your IP Camera, especially when assigned with a dynamic IP address, to have a fixed host and domain name. This means that even though your WAN IP address is constantly changing, you will have a fixed hostname you can use to access your cameras at all times. You can access the camera directly from the Internet using the hostname and port number.

What is the HTTP Port NO.?

Default HTTP Port is 88

All cameras have the default HTTP port of 88. For example, if the LAN IP link of the camera is `http://192.168.8.102:88`, this means that the camera’s HTTP port is 88. You can change port 88 to another port if you’d like such as 2000 or 8090, which will not be conflict with other existing ports like 25, 21,10000. Here you can set the port no. between 1 and 65535.

Change the default http no.88 to another one.

How to assign a different HTTP Port No. and fixed the LAN IP of the camera by the IP Camera Tool?

Step 1: Open the IP Camera Tool, select the camera you would like to change the port of, right click on the IP address, and click on ”Network Configuration”, this brings up the network configuration box as shown in Figure 2.9 and 2.10.

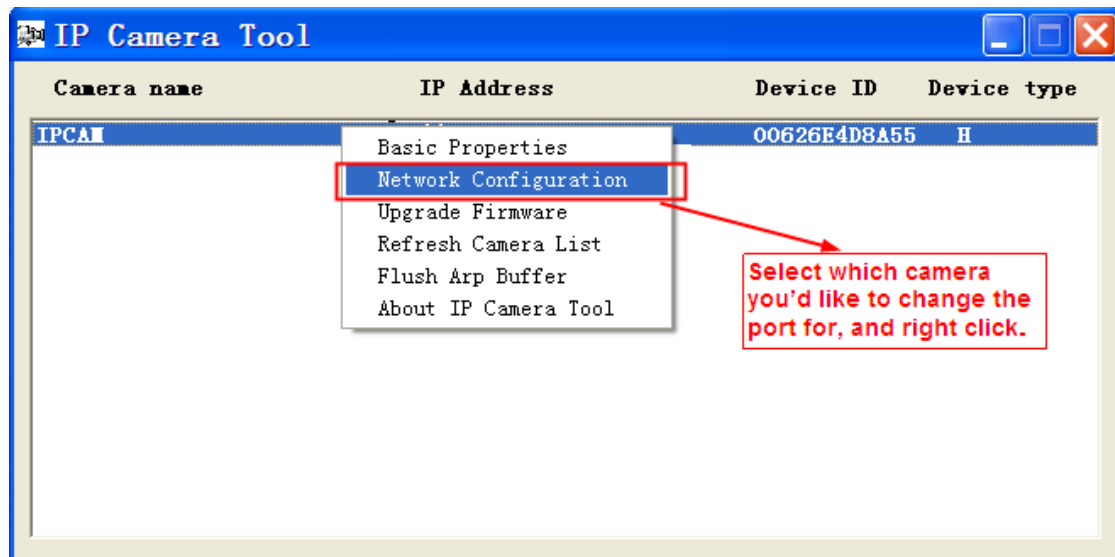

Figure 2.9

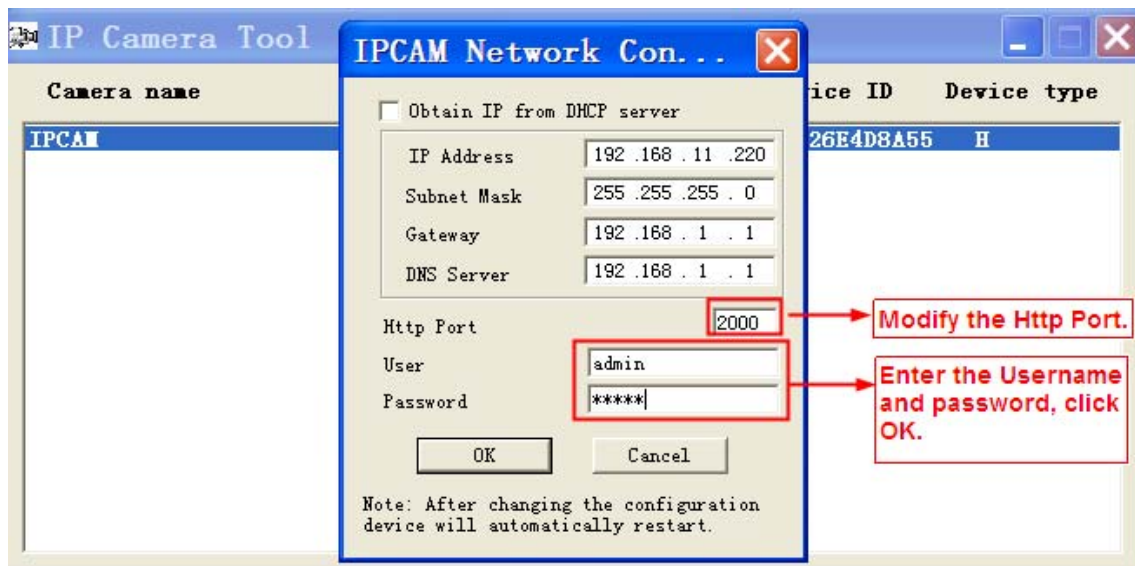

Figure 2.10

Step 2: Enter the username and password of the Administrator (default username is admin with a blank password), and click “OK” to apply changes.

Step 3: Wait around 10 seconds, you’ll see that the camera’s LAN IP address has changed. In our example it was changed to 2000, so we see http://192.168.8.102:2000 in IP Camera Tool. Also, the LAN IP address is now fixed at a static IP address of http://192.168.8.102:2000. This IP address will not change even if the camera is powered off and back on, the camera will remain on this LAN IP address. This is very important that a static LAN IP address is set, or you may have problems later with remote access and seeing the camera remotely if the camera loses power and reconnects on a different LAN IP address. Make sure you set a static LAN IP address!

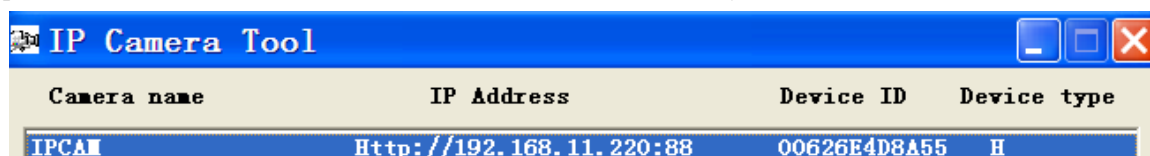

Figure 2.11

What is Port forwarding?

If you have never done port forwarding before, you can open and view the following link to understand the basic concept. Port forwarding allows for outside connections to access a specific device on your network from anywhere in the world. Every router automatically blocks any incoming connections for safety purposes. Using port forwarding, you are telling your router to allow a connection through a certain port (you can think of it as a gateway) into your router. You set this port to a specific device, in our case an IP Camera, so it can be accessed from anywhere in the world.

Click this link to learn more about port forwarding: <http://portforward.com/help/portforwarding.htm>

How do we configure Port Forwarding?

For this section, we will be using an example:

Let's say the camera's LAN IP address is <http://192.168.8.100:2000>

Step 1: Login to the router, and go to your router's port forwarding or port triggering menu. Sometimes this is also under the name of Virtual Server or NAT.

Using the Linksys brand router as an example, we would log into the router, and go to the Applications & Gaming menu. We would then click on the "Single Port Forwarding" sub-menu.

Step 2: Create a new column using the LAN IP address & HTTP Port of the camera within the router as shown below, then push OK or Submit to save your settings:

Wireless-N Home Router WRT120N

Applications & Gaming

Setup Wireless Security Access Restrictions Applications & Gaming Administration Status

Single Port Forwarding Port Range Forwarding Port Range Triggering DMZ QoS

Single Port Forwarding

Application Name

None

None

None

None

None

Foscam Cam

External Port	Internal Port	Protocol	To IP Address	Enabled
192.168.8.				<input type="checkbox"/>
192.168.8.				<input type="checkbox"/>
192.168.8.				<input type="checkbox"/>
192.168.8.				<input type="checkbox"/>
---	---	---	192.168.8.	
2000	2000	Both	192.168.8.100	<input checked="" type="checkbox"/>
		Both	192.168.8.	<input checked="" type="checkbox"/>
		Both	192.168.8.	<input type="checkbox"/>

Help...

Fill the HTTP Port of the camera in the columns of External Port and Internal Port. Example: 2000

Fill in this section with the LAN IP of the camera; we would enter "100" for our example.

Assign a name for the port forward setting here .

Figure 2.12

First method :

Use the embedded DDNS to access the camera via the Internet

Shenzhen Foscam Intelligent Technology Co., Limited

Tel: 86 755 2674 5668 Fax: 86 755 2674 5168

Each Foscam camera has an embedded unique DDNS domain name, the format of this domain name is xxxxxx.myfoscam.org. On the bottom of the camera, you can see the domain name sticker with this information on it.

For example, we can use test09.myfoscam.org. In the camera, click Settings at the top, click “Network” on the left, then click “DDNS” to get to the DDNS settings page. Here you can see the unique domain name of your camera.

Figure 2.13

Now you can use “http://Domain name + HTTP Port” to access the camera via the Internet.

Take hostname test09.myfoscam.org and HTTP Port of 2000 for example, the URL link to access the camera via the Internet would be http:// test09.myfoscam.org:2000.

Second method :

Use the Third party DDNS to access the camera via the Internet

Step 1 Please go to the third party DDNS website(such as www.no-ip.com) to create a free hostname.

Step 2 DO DDNS Service Settings within the Camera

Please set DDNS Settings within the camera by hostname, a user name and password you’ve got from www.no-ip.com

Take hostname ycxgwp.no-ip.info, user name foscam, password foscam2012 for example.

Firstly, goes to option of DDNS Settings on the administrator panel.

Secondly, select No-IP as a server.

Thirdly, fill foscam as DDNS user, fill password foscam2012 as DDNS password, fill ycxgwp.no-ip.info as DDNS domain and server URL, Then click save to make effect. The camera will restart and to take the DDNS settings effective.

Fourthly, after the restart, login the camera, and go to option of Device Status on the administrator panel, and check if the DDNS status is successful.

If failed, please double check if you have input the correct hostname, user name, and password, and try to redo the settings.

NOTE :

If you have set Third Party DDNS successfully ,the Foscam Domain Name will be invalid. The Third Party DDNS Shenzhen Foscam Intelligent Technology Co., Limited

and the Foscam Domain Name cannot work at the same time, the last time you configured will take effect.

2.3 Using the VLC player

This camera supports RTSP streaming, here you can view the camera using VLC player.

RTSP URL [rtsp:// \[user name\]\[:password\]@IP:HTTP port number/videosream](rtsp://[user name][:password]@IP:HTTP port number/videosream)

The part in the square brackets may be omitted.

user name & password:

The user name and password to access the camera. This part can be omitted.

IP: WAN or LAN IP address.

Videostream: Here support three mode: videoMain, videoSub and audio. When the network speed is bad, here you had better select videoSub. If you select audio, you can only hear the sound but cannot see the video.

For example:

IP: 192.168.1.11

HTTP Port number: 88

User name: admin

Password: 123

Here I can enter one of the following URLs in the VLC.

1. rtsp://admin:123@192.168.1.11:88/videoMain
2. rtsp:// @192.168.1.11:88/videoMain
3. rtsp://:123@192.168.1.11:88/videoMain
4. rtsp://admin@192.168.1.11:88/videoMain

Open the VLC, and go to Media Open Network Stream option, then enter the URL into VLC.

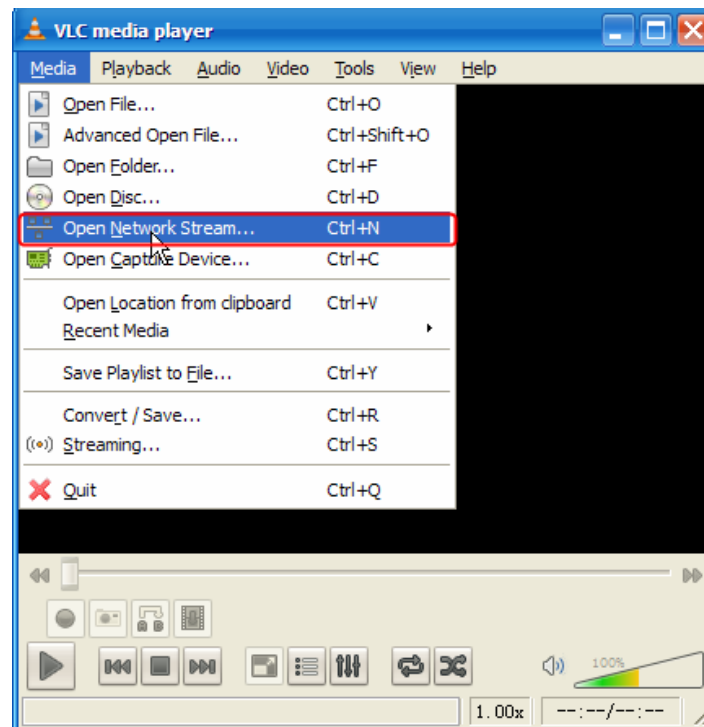

Figure 2.14

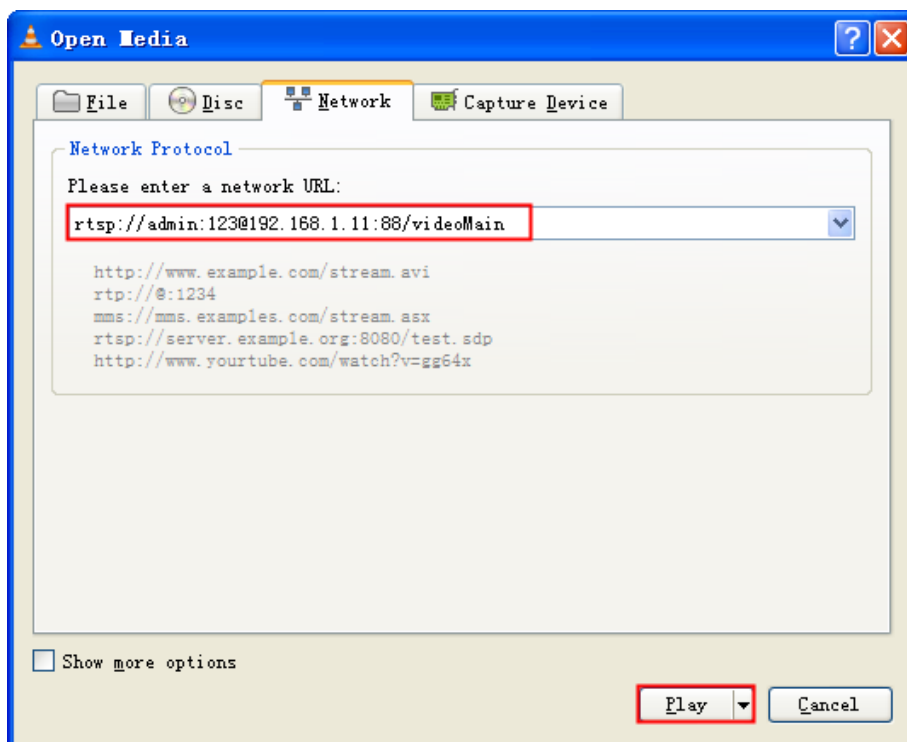

Figure 2.15

Sometimes you may need to enter the user name and password again. Click OK and you can see the real-time preview.

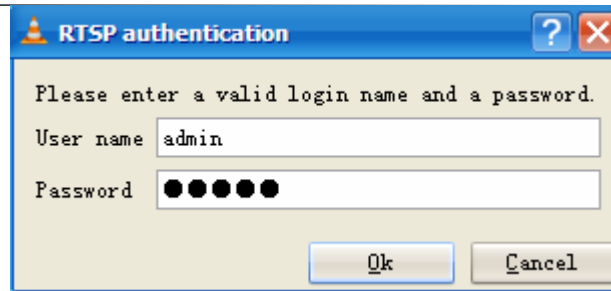

Figure 2.16

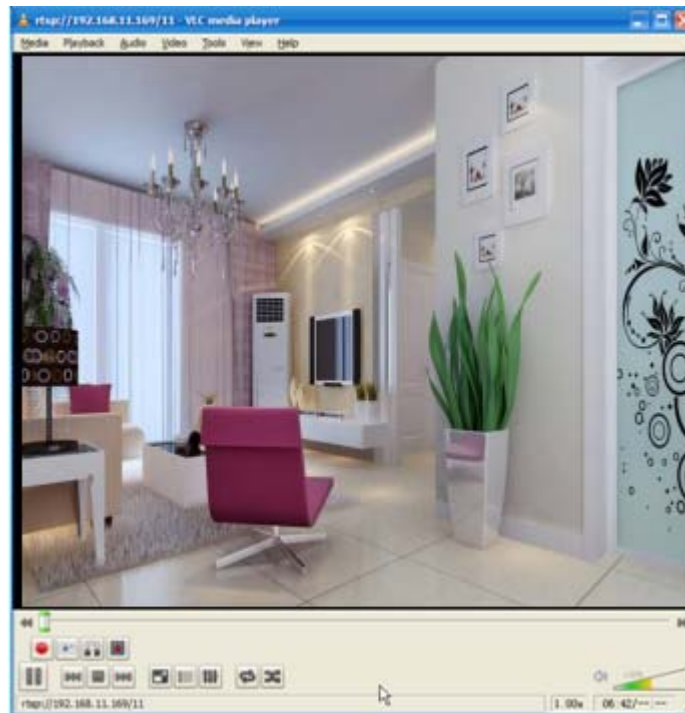

Figure 2.17

If you cannot play the video in the VLC player, please check the port mapping. You can read Quick Installation Guide about How to configure port forwarding.

NOTE:

If you modify the camera's username or password, you had better reboot the camera, or else the new username and password cannot take effect when you enter the authentication in the VLC.

2.4 IP camera connection to the server

Device supports ONVIF 2.2.1 protocol, You can easily access the NVR with ONVIF or server with ONVIF.

3 Surveillance Software GUI

Please refer to the Quick Installation Guide if you install the camera at first time. After finishing quick installation, you can take time to learn the operation of the software.

3.1 Login Window

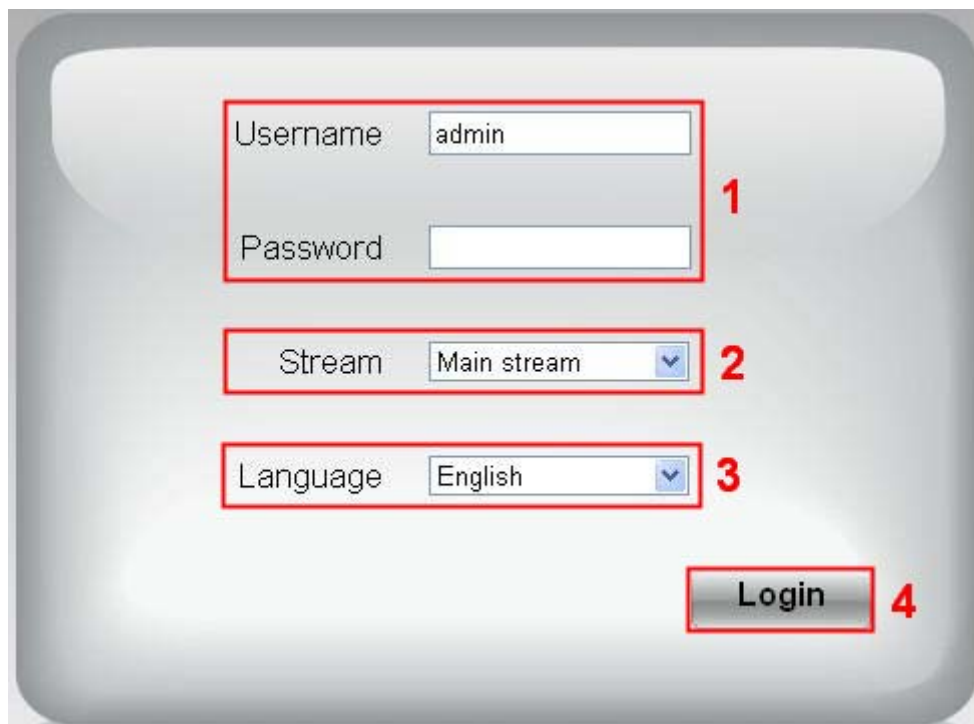

The image shows a login window with four distinct sections highlighted by red boxes and numbered 1 through 4. Section 1 contains the Username field (with 'admin' entered) and the Password field. Section 2 is a dropdown menu for Stream, currently set to 'Main stream'. Section 3 is a dropdown menu for Language, currently set to 'English'. Section 4 is the 'Login' button.

Figure 3.1

Please check the login window above, it was divided to 4 sections from no. 1 to 4.

Section1 Enter the Username and password

The default administrator username is admin with no password, please reset the password at first using and prevent unauthorized users login the camera.

Section2 Stream

The camera supports two stream modes: Main stream and sub stream. If you want to access the camera form LAN, here you can select Main stream. If you want to access the camera from Internet, here we recommend sub stream.

Note: When the network bandwidth is badly you'd better select Sub Stream and the video will be more fluency.

Section3 Select the language

You can select the language you need via click on the language dropdown list to switch.

Section4 Login the camera

Click Login button and you will see the surveillance windows.

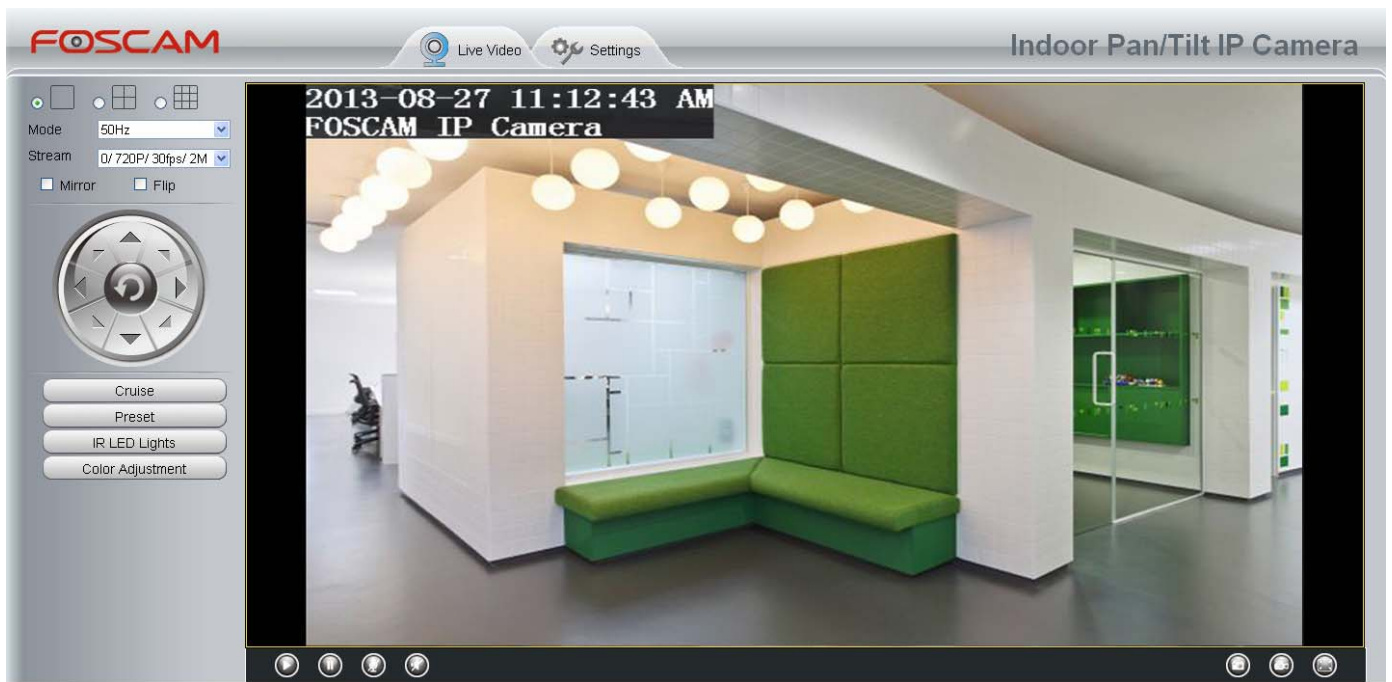

Figure 3.2

3.2 Surveillance Window

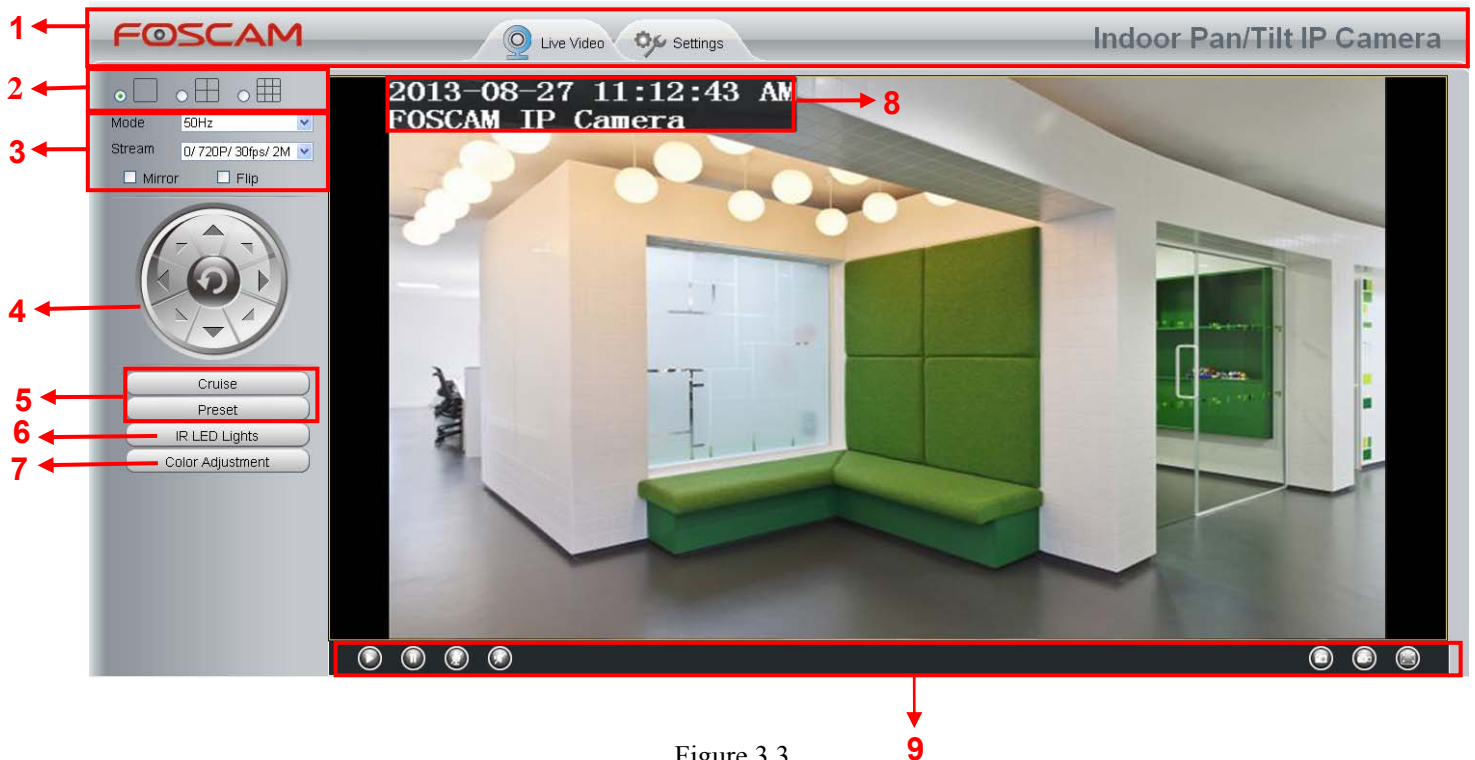



Figure 3.3

Section 1 FOSCAM Logo/ Live Video / Settings/Playback buttons

FOSCAM : FOSCAM LOGO

 : Path to surveillance window. Click this button and back to the surveillance window

 : Path to Administrator Control Panel, Click it, and it will lead to Administrator Control Panel and do advanced settings.

Section 2 Multi-Device Window



The firmware inside the camera supports up to maximum of 9 cameras being monitoring at the same time. You can add other cameras in multi-device setting.

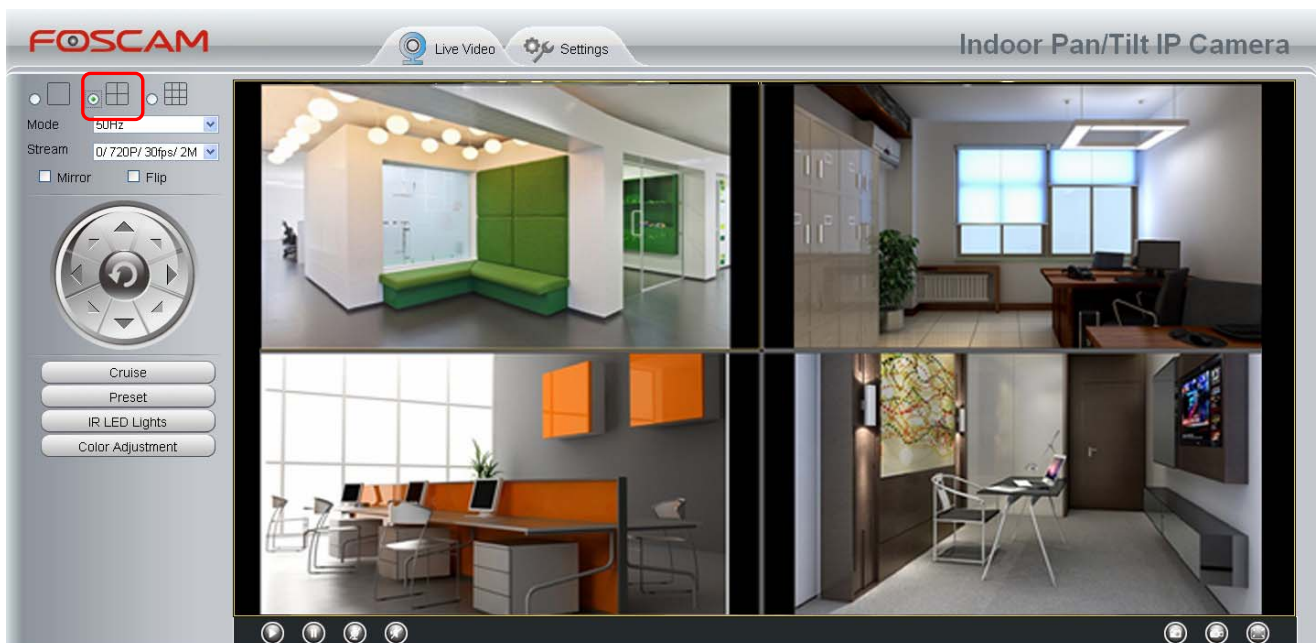

Figure 3.4

Section 3 Mode/ Stream / Mirror/ Flip buttons

Mode

- 1) 50HZ -----Indoor surveillance (Region: Europe, China)
- 2) 60HZ -----Indoor surveillance (Region: USA, Canada)
- 3) Outdoor Mode-----Outdoor surveillance

Stream

The default Stream supports four modes: 0/720P/30fps/4M, 1/VGA/25fps/2M, 2/VGA/ 15fps/ 1M and 3/VGA/10fps/200K. The format of the stream type is **Stream type no. / Resolution / Maximum frame rate/ Bit rate**.

1) **Stream type NO.** : The number is used to identify the stream type.

2) **720P/ VGA**

Shenzhen Foscam Intelligent Technology Co., Limited

Tel: 86 755 2674 5668 Fax: 86 755 2674 5168

There are two resolutions, the bigger one is 720P, and the smaller one (VGA) is 640x480 pixels. The bigger the resolution is, the better of the image quality is. If you are accessing the camera via internet and want to get more fluent video streaming, please select resolution VGA.

3) Maximum frame rate

When the video format is 50Hz, the maximum frame rate is 25 fps. When the video format is 60Hz, the maximum frame rate is 30 fps. You should lower frame rate when the bandwidth is limited. Normally, when the frame rate above 15, you can achieve fluently video.

4) Bit rate

Generally speaking, the larger the bit rate is, the clearer video will become. But the bit rate configuration should combine well with the network bandwidth. When the bandwidth is very narrow, and bit rate is large, that will lead to video can not play well.

You can reset the stream type on “**Settings-> Video-> Video Settings**” panel.

Save Refresh	
Stream Type	0
Resolution	720P
Bit Rate	2M
Frame Rate	30
Key Frame Interval	30

Figure 3.5

After changing, please re-login the camera and you can see the modification.

Section 4 Pan/Tilt Control



- 1-----Up control button,
- 2-----Down control button,
- 3-----Left control button,
- 4-----Right control button,

- 5----- Up-Left control button
- 6----- Up-Right control button
- 7----- Down-Left control button
- 8----- Down-Right control button



Click this button and go to center

Section 5 Cruise / Preset settings

Cruise Settings

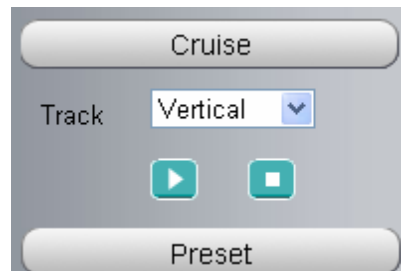

The default cruise tracks have two types: Vertical and Horizontal.

Vertical: The camera will rotate from up to down.

Horizontal: The camera will rotate from left to right.



: Start cruise.



: Stop cruise.

If you want to define or change the cruise trace, please go to **Settings** → **PTZ** → **Preset Settings** panel.

How to do cruise?

Firstly: Select one track in the track dropdown list



Secondly: Click Start cruise button, the camera will cruise following the predefined path.

Thirdly: Click stop button and finish cruising.

Preset settings

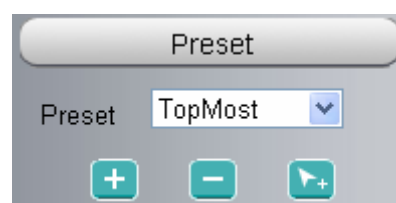

IPCAM supports 16 preset positions, which is considered enough for DIY home & small business surveillance market. The default preset position is Topmost, Bottom most, Left most, right most, you can add other preset positions.



Add Click this icon to save the position you need the camera to remember



Delete Select one preset position and click this button to delete it.



GO Select one preset position in the preset dropdown list and click Go to make the camera move the preset position

How to do preset position?

Firstly, move the camera and stop at a desired place where you want make preset position.

Secondly, click  button and enter a descriptive name for the preset position. The preset position cannot contain special characters. Then click OK to save it. If you want to reset the preset position, click Cancel.

After that, you can move the camera and stop at another place, and set another preset position. You can do all the 16 preset positions with this method.

If you want to see one preset position you have set, only select the preset position name from the preset dropdown list, and click go  button, the camera will go to the preset position.

Section 6 IR LED Lights

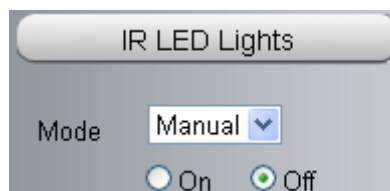

Click Infra led and there are two modes to adjust the infrared led: Auto and Manual.

Auto: Select it and the camera will adjust the infra led (on or off) automatically.

Manual: Select it and you can turn on or turn off the infra led manually.

Section 7 Image quality settings

In this page, you can tune Hue, Brightness, Contrast, Saturation, and Sharpness to get higher quality.

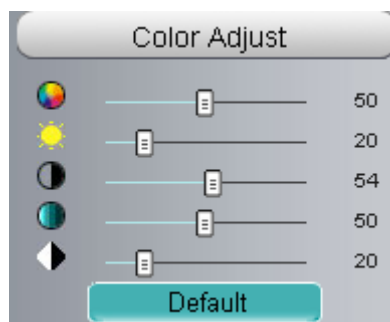

Section 8 OSD

If you have added time and camera name in the video, you can see it in the live window.

Go to **Settings ---Basic settings---Camera name** panel, and you can change another device name. The default device name is anonymous.

Go to **Settings ---Basic settings---Camera time** panel and adjust the device time.

Go to **Settings ---Video---On Screen Display** panel, you can add or no add OSD.

Section 9 Play/Stop/ Talk/Audio/ Snap/ Record/ Full screen button



1-----Play Click it to play the video of the camera

2-----Stop Click it to stop the video of the camera

3----- Talk Click the button and the icon will become to , then talk to the microphone that connected with PC, people around the camera can here your voice. Click the icon again and stop talking.

4----- Audio Click this icon, the icon will become to  you can hear the sound around the camera by the earphone or speakers that connected with PC.

5----- Snapshot Click it to make snapshot and it pop-up a window which picture you snapshot, right click in the window and save the picture to anywhere you want.

6----- Record Click the icon  and the camera start recording, you can see a green dot in the live window. Click again and stop recording. The default storage path is C:\PCamRecord. You can change the storage path: Go to Settings->Record->Storage Location panel.

7-----Full Screen Click it to make full-screen, or you can double click the surveillance screen to make full-screen. Double click again and exit full-screen.

Onscreen Mouse Control

Right click the mouse and you can adjust the screen ration, full screen and Zoom up.

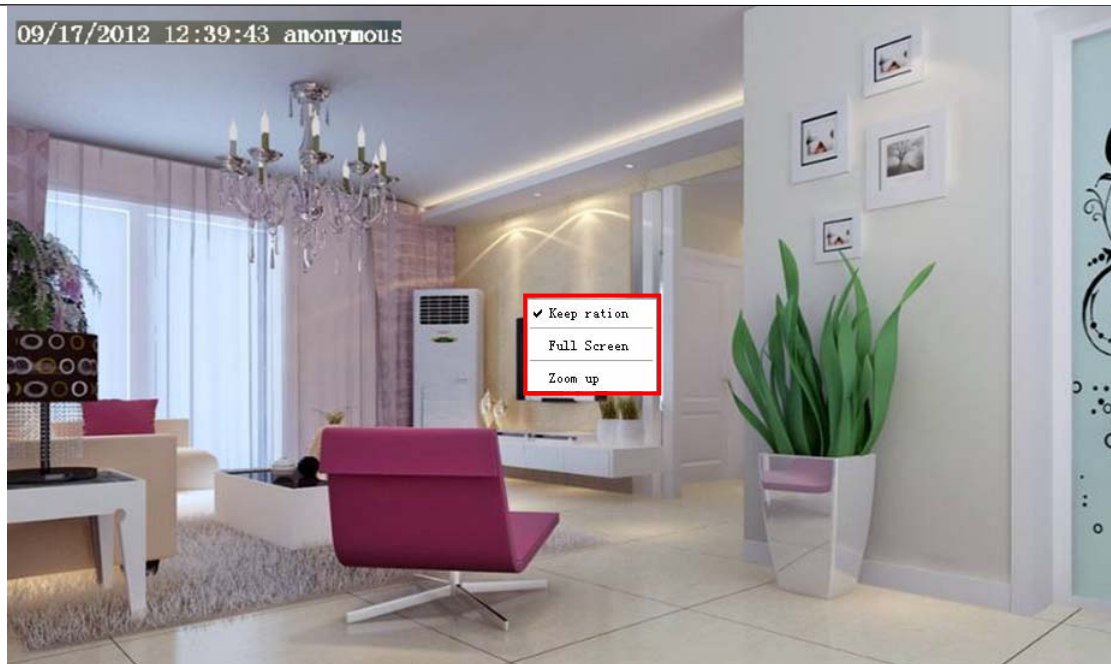

Figure 3.6

Keep ration: Select it and the camera will adjust the size of live window based on the the computer monitor automatically. Sometimes there is a black border around the video, please select Keep ration to get a better visual quality .

Full Screen: Select it and Click it to make full-screen, press ESC and exit full-screen.

Zoom up: Select it and you can see a bigger screen than before.

4 Advanced Camera Settings

Click the button “**Settings**”, goes to Administrator Control Panel to make advanced camera settings.

4.1 Status

Status contains four columns: Device Information, Device Status, Session Status and Log, it will show you various information about your camera.

4.1.1 Device Information

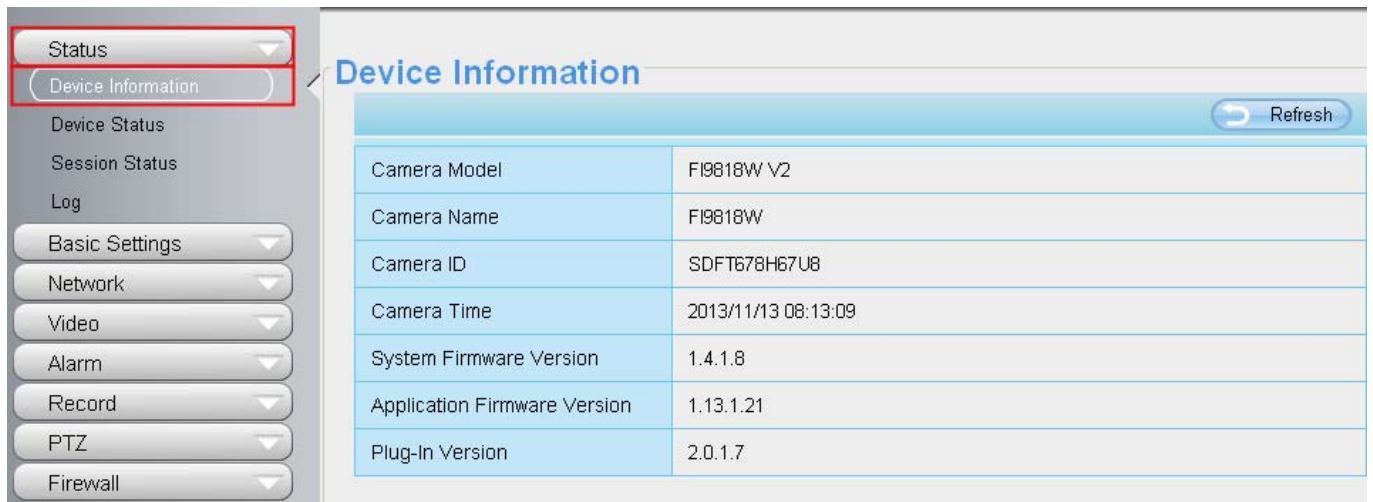

The screenshot shows the 'Device Information' page in the Foscam web interface. On the left, a sidebar menu includes 'Status' (highlighted with a red box), 'Device Information' (also highlighted with a red box), 'Device Status', 'Session Status', 'Log', 'Basic Settings', 'Network', 'Video', 'Alarm', 'Record', 'PTZ', and 'Firewall'. The main content area is titled 'Device Information' and features a 'Refresh' button. Below the title is a table with the following data:

Camera Model	F19818W V2
Camera Name	F19818W
Camera ID	SDFT678H67U8
Camera Time	2013/11/13 08:13:09
System Firmware Version	1.4.1.8
Application Firmware Version	1.13.1.21
Plug-In Version	2.0.1.7

Figure 4.1

Camera Model: The camera model NO.

Camera Name: The Device Name is a unique name that you can give to your device to help you identify it. Click **Basic Settings** and go to **Camera name** panel where you can change your camera name. The default device name is anonymous.

Camera ID: Display the wired MAC address of your camera. For example Device ID is 000C5D00008, the same MAC ID sticker is found at the bottom of the camera.

Camera Time: The system time of the device. Click **Basic Settings** and go to **Camera time** panel and adjust the time.

System Firmware Version: Display the System Firmware version of your camera.

App Firmware Version: Display the application firmware version of your camera.

Plug-In Version: Display the plug-in version of your camera

4.1.2 Device Status

On this page you can see device status such as Alarm status/ Record Status ,DDNS status ,WIFI status and so on.

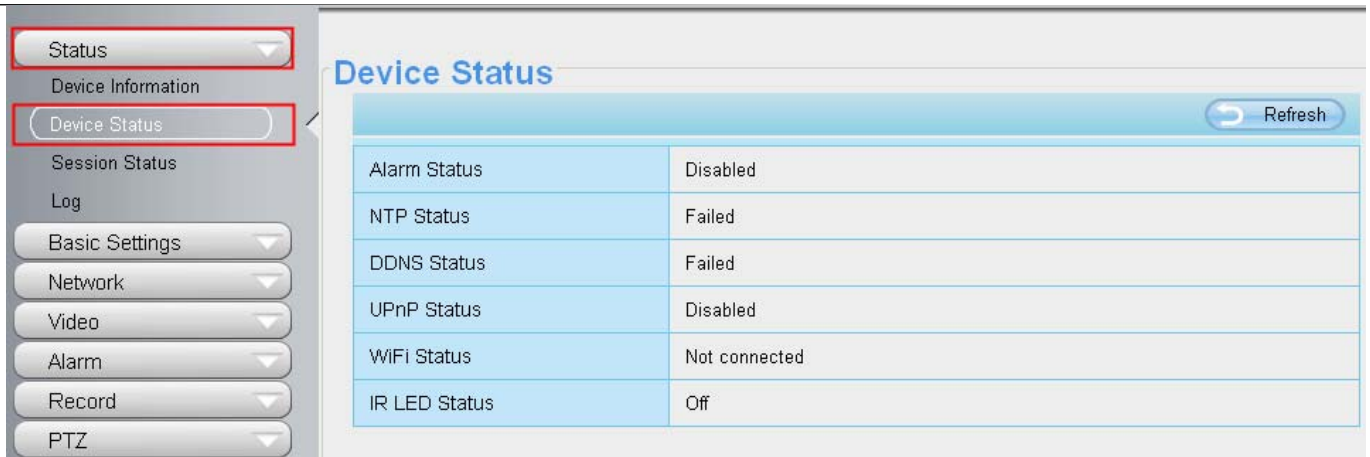

Figure 4.2

4.1.3 Session Status

Session status will display who and which IP is visiting the camera now.

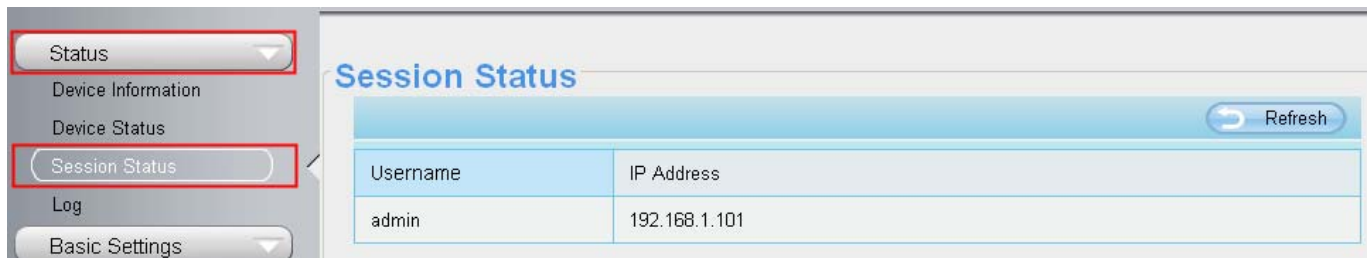

Figure 4.3

4.1.4 Log

The log record shows who and which IP address accessed or logout the camera and when.

Log

Pages:83

<<1 2 3>> Go

NO.	Time	User	IP	Log
1				line
2				
3	2012-09-18 01:29:51	admin	192.168.1.102	Log out
4	2012-09-18 01:27:54	admin	218.17.160.187	Log out
5	2012-09-18 01:26:21	admin	192	
6	2012-09-18 01:25:42	admin	218	
7	2012-09-18 01:25:15	admin	192.168.1.102	Login
8	2012-09-18 01:25:13	admin	192.168.1.102	Log out
9	2012-09-18 01:24:46	admin	192.168.1.100	Login
10	2012-09-18 01:21:44	admin	192.168.1.102	Login

Click the page number and go to the corresponding page to see more logs.

Fill in one page number, click Go button and go to the corresponding page.

Figure 4.4

Reboot the camera and clear the log records.

4.2 Basic Settings

This section allows you to configure your camera's Name, Time, Mail, User account and Multi-Device.

4.2.1 Camera Name

You can define a name for your camera here such as apple. Click Save to save your changes. The alias name cannot contain special characters.

Status

Basic Settings

Camera Name

Camera Time

User Accounts

Multi-Camera

Network

Camera Name

Save Refresh

Camera Name

F19818W

The maximum Device Name length is 20, support English, numbers, letters and symbols

Figure 4.5

4.2.2 Camera Time

This section allows you to configure the settings of the internal system clocks for your camera.

Figure 4.6

Time Zone: Select the time zone for your region from the dropdown menu.

Sync with NTP server: Network Time Protocol will synchronize your camera with an Internet time server. Choose the one that is closest to your camera.

Sync with PC: Select this option to synchronize the date and time of the Network Camera with your computer.

Manually: The administrator can enter the date and time manually. Note select the date and time format.

use DST: Select the daylight saving time from the dropdown list.

Click **Save** button and submit your settings.

4.2.3 User Accounts

Here you can create users and set privilege, **visitor**, **operator** or **administrator**. The default user account is admin, with a blank password. You can enter the users accounts of visitor、operator and administrator Manually.

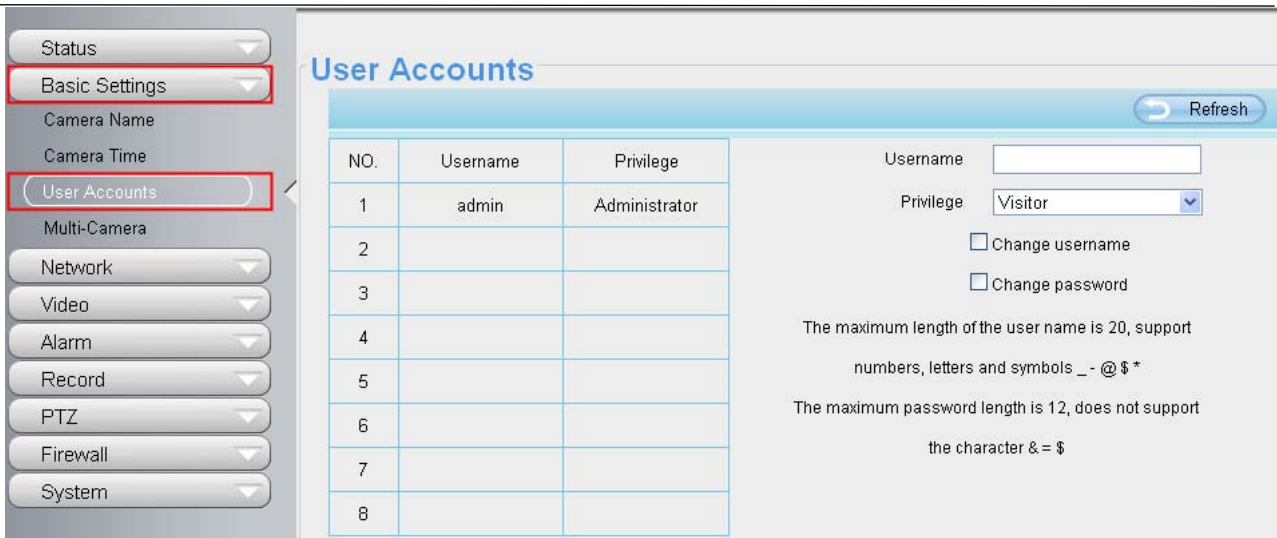

Figure 4.7

How to change the password?

Firstly, select the account which you want to change the password, then select “Change password”, enter the old password and the new password, lastly click modify to take effect.

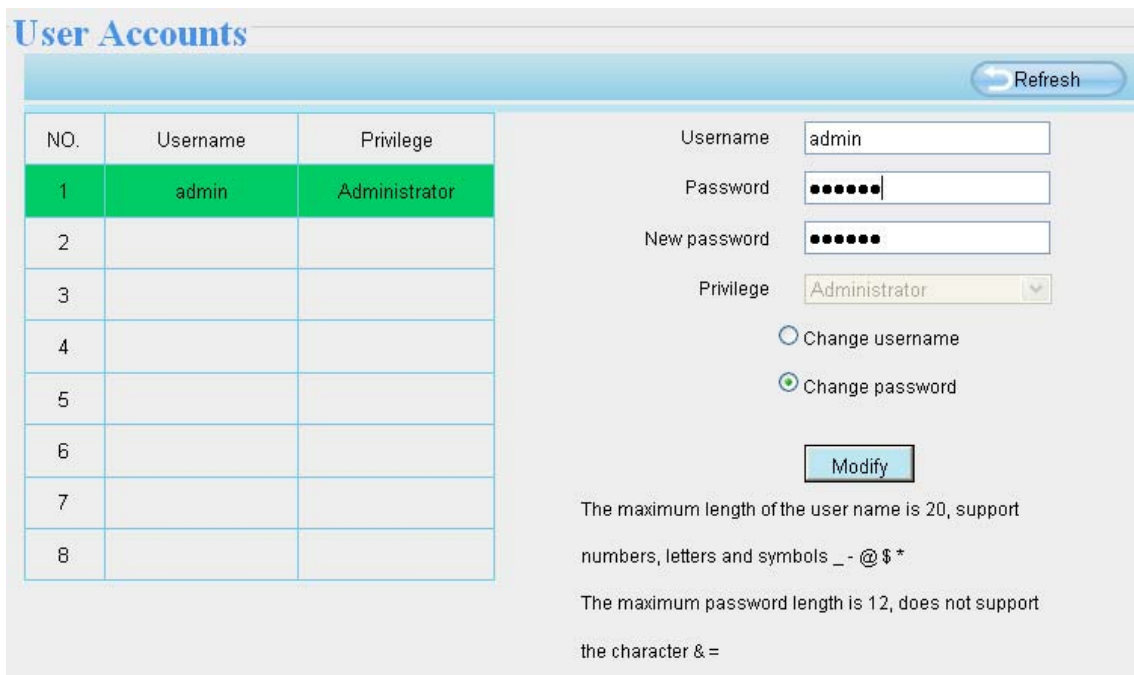

Figure 4.8

How to add account ?

Select one blank column, then enter the new user name, password and privilege, last click Add to take effect. You can see the new added account on the Account list.

User Accounts Refresh

NO.	Username	Privilege
1	admin	Administrator
2		
3		
4		
5		
6		
7		
8		

Username:

Password:

Privilege:

Change username

Change password

The maximum length of the user name is 20, support numbers, letters and symbols _ - @\$*

The maximum password length is 12, does not support the character & =

Figure 4.9

User Accounts Refresh

NO.	Username	Privilege
1	admin	Administrator
2	operator	Operator
3		
4		
5		
6		
7		
8		

Username:

Privilege:

Change username

Change password

The maximum length of the user name is 20, support numbers, letters and symbols _ - @\$*

The maximum password length is 12, does not support the character & =

Figure 4.10

Delete : Select the account which you want to delete, then click Delete button to take effect.

NOTE: The default admin account cannot be deleted, but you can add other administrator users.

How to change the username ?

Firstly, select the account which you want to change the username, then select “Change username”, enter the new password, lastly click modify to take effect.

User Accounts Refresh

NO.	Username	Privilege
1	admin	Administrator
2	operator	Operator
3		
4		
5		
6		
7		
8		

Username:
 New username:
 Privilege:

Change username
 Change password

The maximum length of the user name is 20, support numbers, letters and symbols _ - @\$*

The maximum password length is 12, does not support the character & =

Figure 4.11

4.2.4 Multi-Camera

If you want to view multi-surveillance screens on one window, you need to login one camera, and set it as the main device, and do Multi-Device Settings, add other cameras to the first one camera. Before you do multi-cams settings, you need to assign different port such as 81, 82, 83, 84, 85, 86, 87, 88 to the cameras if there is 8 cams installed.

The firmware within the camera can support a maximum of 9 devices monitoring all at the same time. This page you can both add FOSCAM MJPEG and H.264 series cameras to the first camera and view multi-surveillance screen on one window.

Add cameras in LAN

In Multi-Device Settings page, you can see all devices searched in LAN. The 1st Device is the default one. You can add more cameras in the list in LAN for monitoring. The camera's software supports up to 9 IP Cameras online simultaneously. Click The 2nd Device and click the item in the Device List in LAN, the Alias, Host and Http Port will be filled in the boxes below automatically. Enter the correct username and password then click Add. Add more cameras in the same way.

Cameras On LAN	FC2401P(172.16.0.195) F19821W(172.16.0.47) EH8155fx(172.16.2.136) Foscam NVR(172.16.1.67) Foscam NVR(172.16.1.71) Foscam NVR(172.16.1.59)	1. Click it, camera model, alias, host and HTTP Port will be filled in the following boxes automatically.
	Refresh	
The 1st Camera	This Camera	
The 2nd Camera	None	
Camera Model	H264	
Camera Name	F19821W	
Host	172.16.0.47	
HTTP Port	88	
Media Port	88	2 Enter the User name and password of the 2nd camera.
Username		
Password		
3. Click Add to take effect.		
	Add	Delete

Figure 4.12

Camera Model: Our Company produces two series cameras: MJPEG and H.264. Here will show you which series the camera belongs to.

Cameras On LAN	anonymous(192.168.11.193) F19821W for ebuyer (192.168.11.241) anonymous(192.168.11.203) anonymous(192.168.11.243)	Refresh
		Refresh
The 1st Camera	This Camera	
The 2nd Camera	F19821W(172.16.0.47)	
The 3rd Camera	F19821W for ebuyer (192.168.11.241)	
The 4th Camera	anonymous(192.168.11.203)	
The 5th Camera	None	
The 6th Camera	None	
The 7th Camera	None	
The 8th Camera	None	
The 9th Camera	None	

Note: If you want to access your camera remotely, make sure you are able to access it separately through a browser.

Figure 4.13

Back to **Surveillance Windows**, and click Four Windows option, you will see four cameras you added.

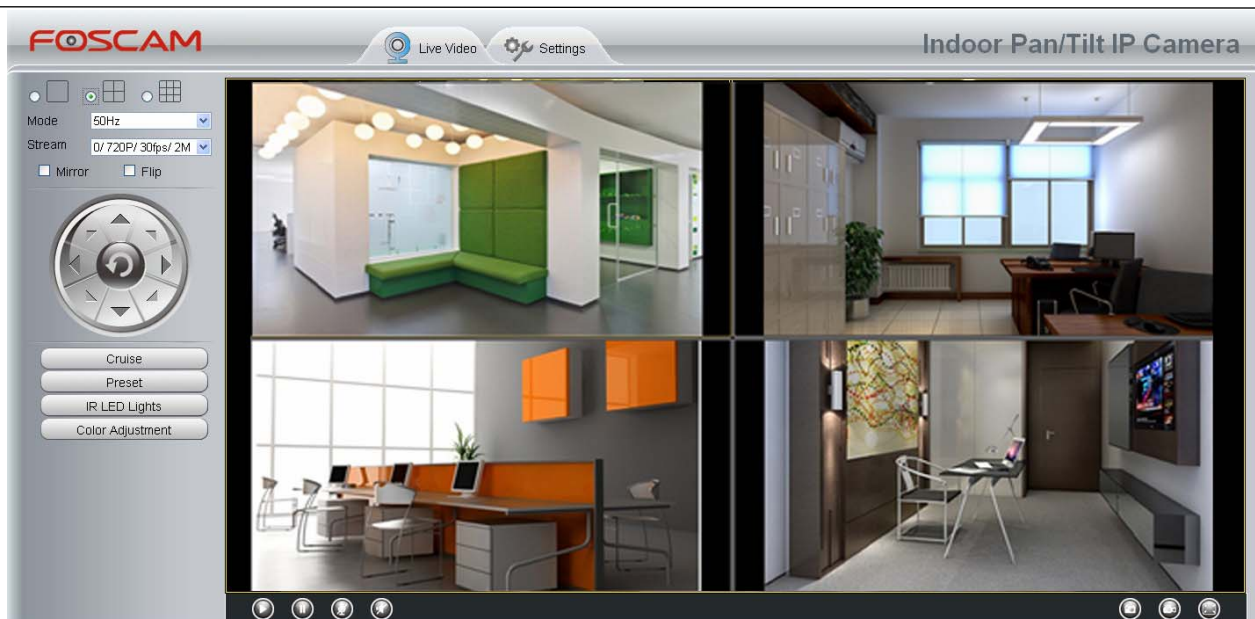

Figure 4.14

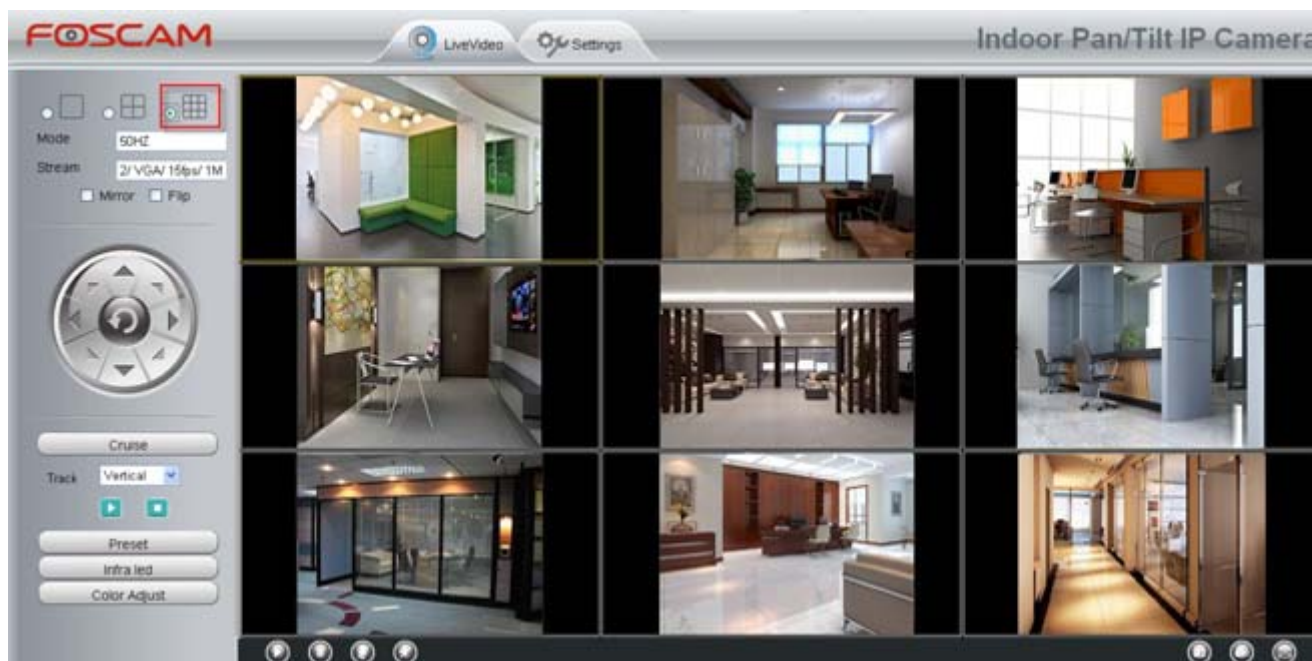

Figure 4.15

Add cameras in WAN

If you want to view all cameras via the internet(remote computer), you will need to add them using DDNS domain name. Firstly, make sure all of the cameras you added can be accessed through the internet. **(Read How to configure DDNS settings in chapter 4.3.4)**

Login to the first camera using a DDNS domain name and port.

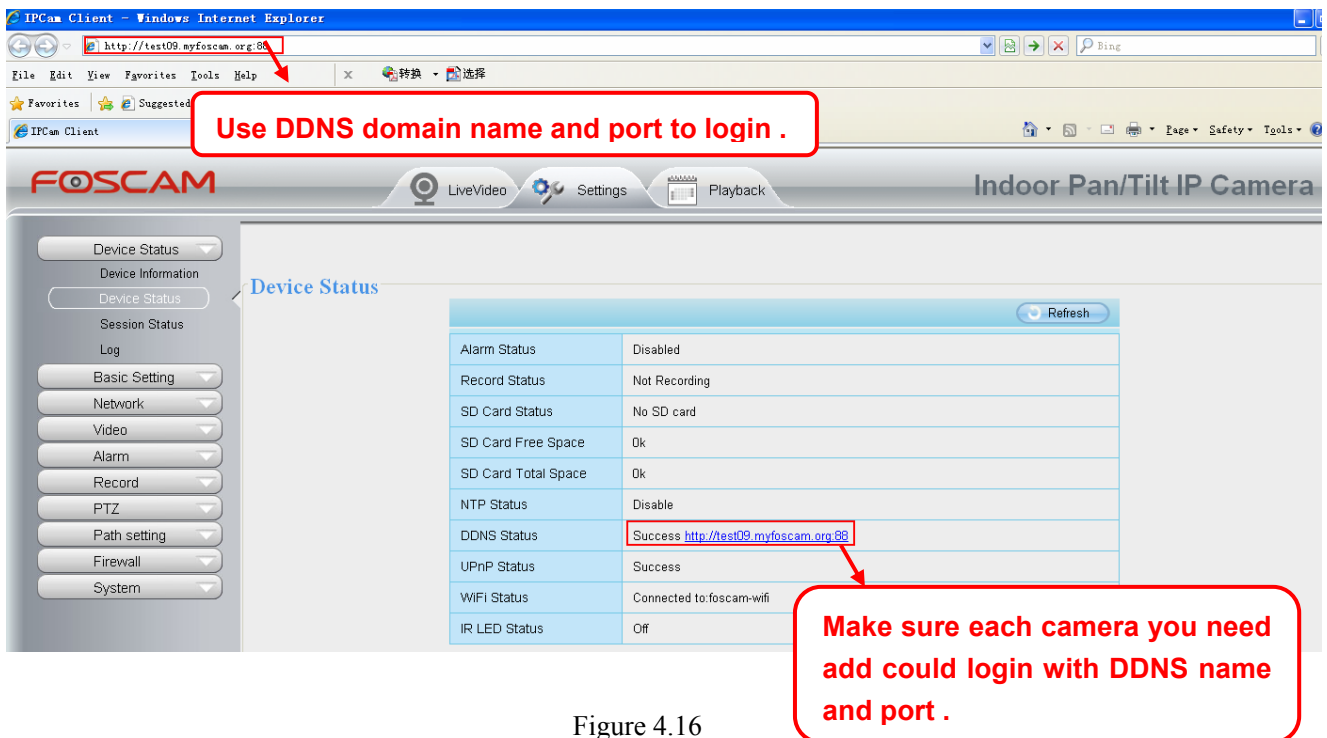

Figure 4.16

Click **Multi-Device Settings**. Choose **The 2nd Device**. Fill in the 2nd camera's name, DDNS domain name, port number. Enter user name and password and then choose Add. (Figure 4.16)

The 1st Camera	This Camera
The 2nd Camera	F19821W(172.16.0.47)
Camera Model	H264 1
Camera Name	F19821W 2
Host	172.16.0.47
HTTP Port	88 3
Media Port	88
Username	admin 4
Password	
	5 Add Delete

Figure 4.17

- 1----- The camera model: MJ or H264.
- 2----- The 2nd camera's name
- 3----- Fill in the 2nd camera's DDNS host not LAN IP
- 4 ---- Enter the 2nd camera's user name and password
- 5---- Click Add button and to take effect

NOTE: Here the Host must be entered as the second camera's DDNS domain name, not its LAN IP.

Cameras On LAN	
	anonymous(192.168.11.193) F19821W for ebuyer (192.168.11.241) anonymous(192.168.11.203) anonymous(192.168.11.243)
The 1st Camera	This Camera
The 2nd Camera	F19821W(172.16.0.47)
The 3rd Camera	F19821W for ebuyer (192.168.11.241)
The 4th Camera	anonymous(192.168.11.203)
The 5th Camera	None
The 6th Camera	None
The 7th Camera	None
The 8th Camera	None
The 9th Camera	None

Note: If you want to access your camera remotely, make sure you are able to access it separately through a browser.

Figure 4.18

Return to video window. You will see all of the cameras accessible through the internet.

When you are away from home, you can use the first camera's DDNS domain name and port to view all the cameras via internet.

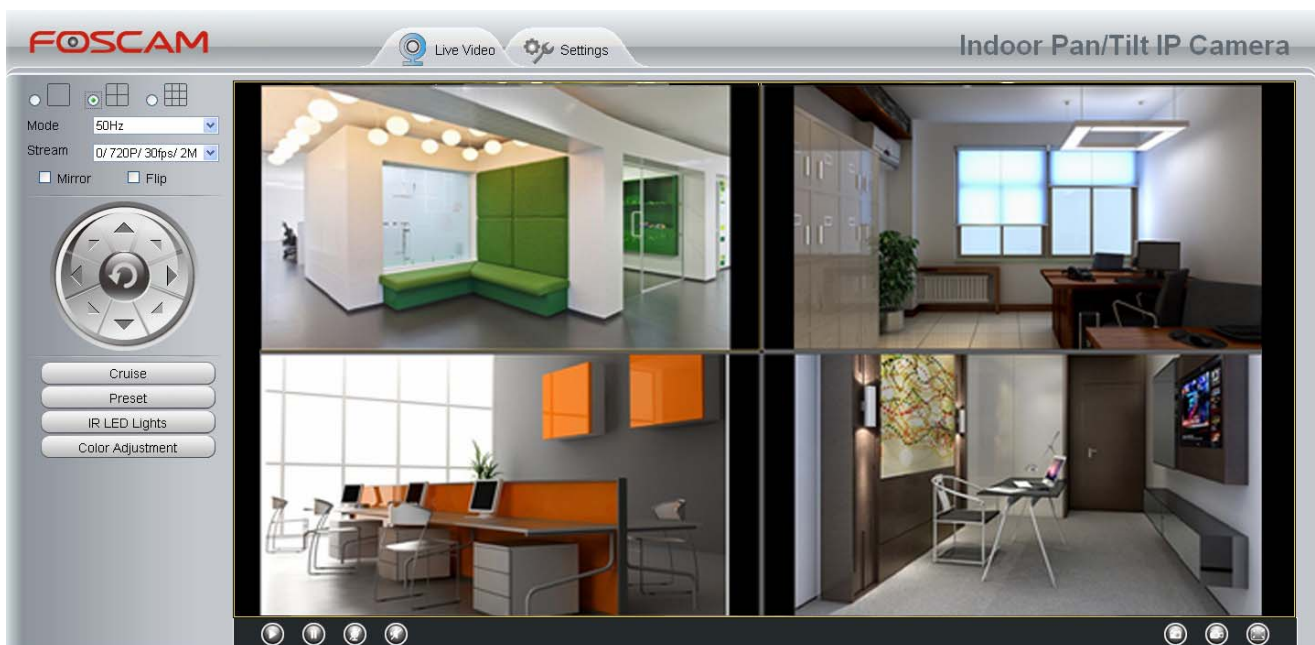

Figure 4.19

4.3 Network

This section will allow you to configure your camera's IP, PPPoE, DDNS, Wireless Settings, UPnP and Port.

4.3.1 IP Configuration

If you want to set a static IP for the camera, please go to **IP Configuration** page. Keep the camera in the same subnet of your router or computer.



Obtain IP From DHCP <input type="checkbox"/>	
IP Address	192.168.0.109
Subnet Mask	255.255.255.0
Gateway	192.168.0.1
Primary DNS Server	192.168.0.1
Secondary DNS Server	202.96.134.133

Note: Once you save your settings, the camera will restart.

Figure 4.20

Changing settings here is the same as using the IP Camera Tool.

It is recommended that you use the subnet mask, gateway and DNS server from your locally attached PC. If you don't know the subnet mask, gateway and DNS server, you can check your computer's local area connection as follows:

Control Panel → Network Connections → Local Area Connections → Choose Support → Details

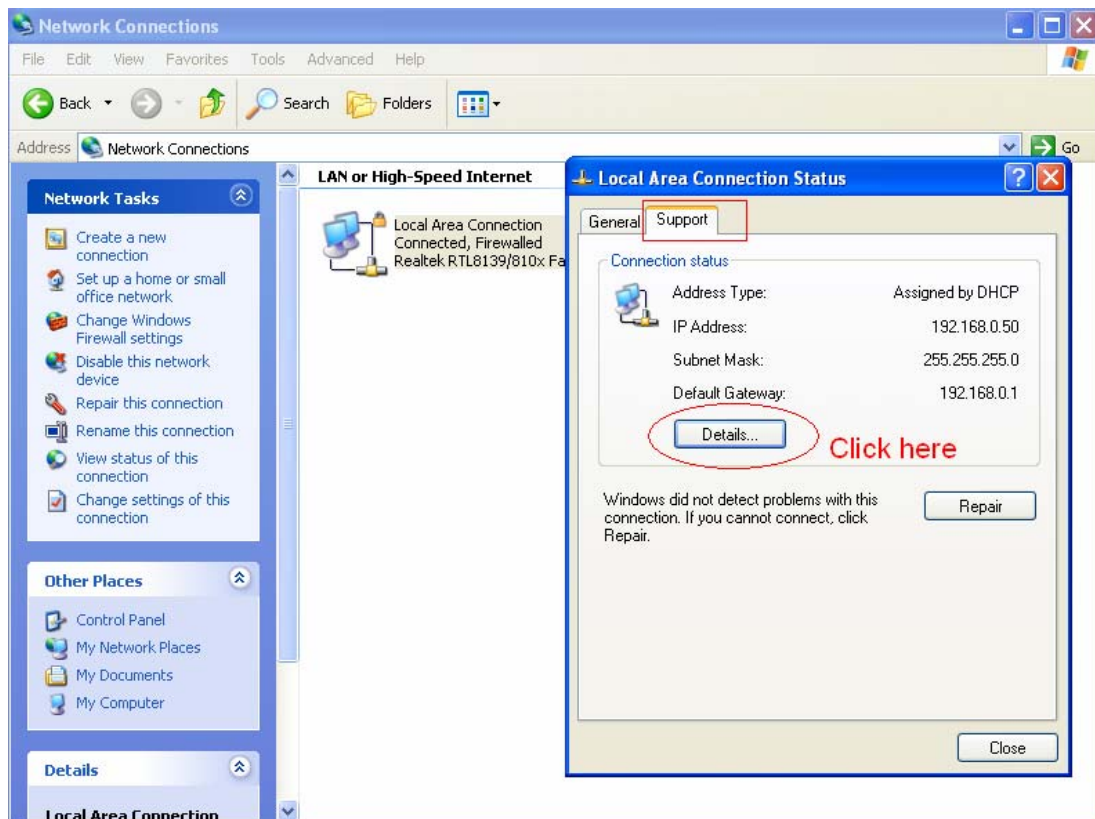

Figure 4.21

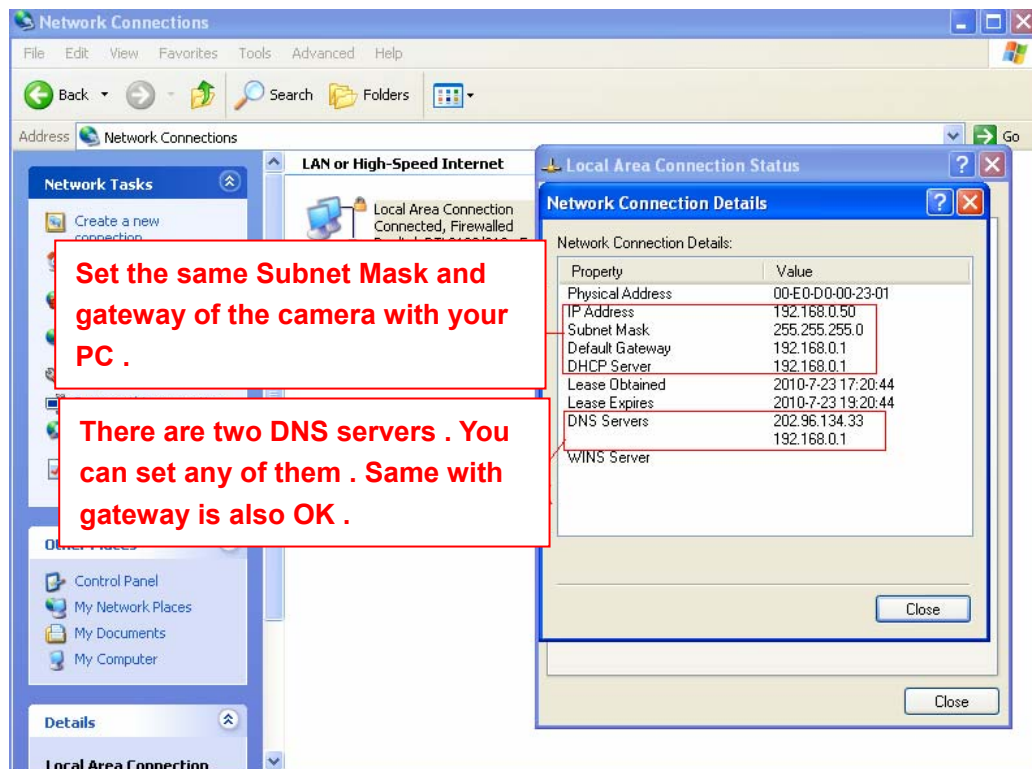

Figure 4.22

If you don't know the DNS server, you can use the same settings as the Default Gateway.

4.3.2 Wireless Settings

Step 1: Choose "Settings" on the top of the camera interface, and go to the "Network" panel on the left side of the screen, then click "Wireless Settings."

Click the **Scan** button and the camera will detect all wireless networks around the area. It should also display your router in the list.

The screenshot shows a web interface for scanning wireless networks. At the top right, there are 'Save' and 'Refresh' buttons. Below them is a 'Scan' button, which is highlighted with a red box and an arrow pointing to a callout box that says 'Click the Scan button to search for wireless networks.' To the right of the 'Scan' button is a form with 'SSID' and 'Encryption' fields. Below the 'Scan' button is a table titled 'Wireless Network List' with columns for 'SSID(Network Name)', 'Encryption', and 'Quality'. The table contains 11 rows of network information. At the bottom left of the table, there is a 'Pages:2 1 2' indicator, which is highlighted with a red box and an arrow pointing to a callout box that says 'Click the Page number to see other wireless networks devices if there are more than 10.'

SSID(Network Name)	Encryption	Quality
Net-HkWc	WPA	📶
airNET-free	Unencrypt	📶
wingate	WPA2	📶
V_CPA1	WPA	📶
MERCURY_MW150R	WPA2	📶
V_CPA2	WPA	📶
foscam	WEP	📶
uniQtab	WPA2	📶
foscam-wifi	WPA2	📶
cisco		

Figure 4.23

Step 2: Click the SSID (name of your router) in the list, the corresponding information related to your network, such as the name and the encryption, will be filled into the relevant fields automatically.

You will only need to fill in the password of your network. Make sure that the SSID, Encryption and the password you filled in are exactly the same for your router.

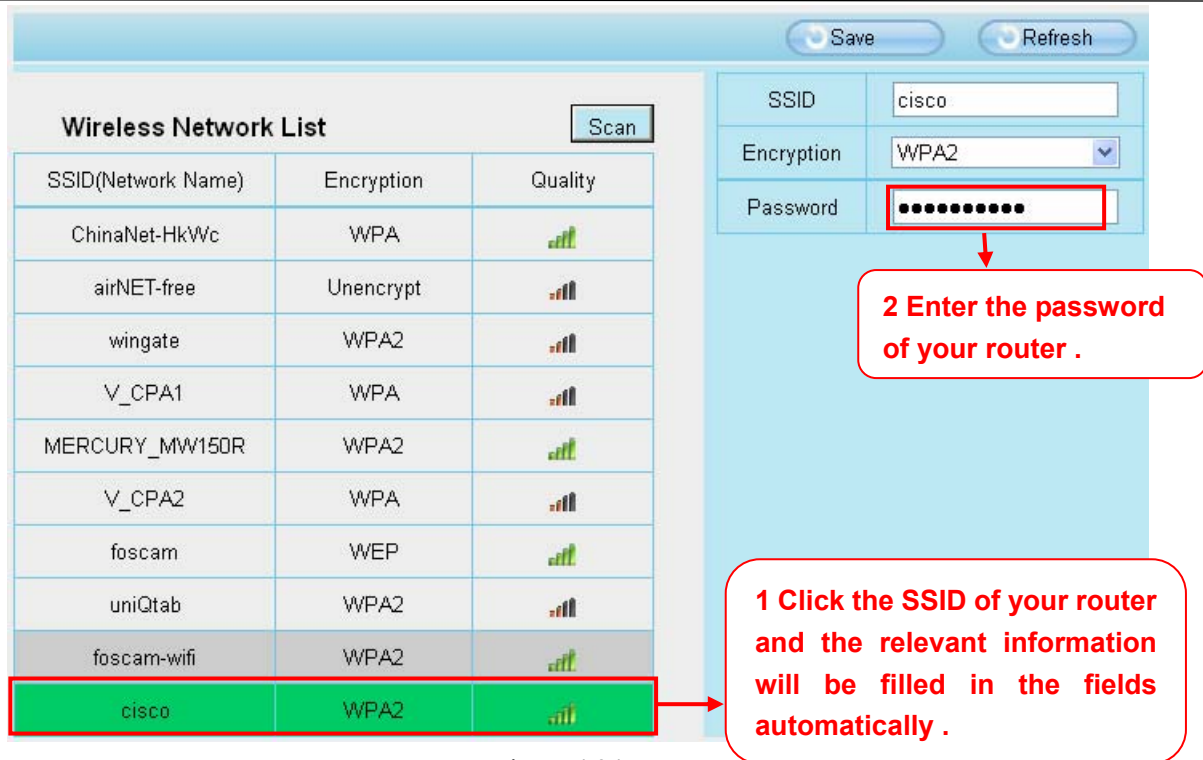

Figure 4.24

Step 3: Please click on the **Save** button after all settings have been entered and disconnect the network cable. Never shut down the power of the camera until the IP camera is able to connect to the wireless network.

The LAN IP address will disappear on the window of IP Camera Tool when the camera is configuring a wireless connection. Wait about 1 minute, the camera should obtain a wireless connection, and the LAN IP of the camera will show again on the window of the IP Camera Tool. The IP address may have changed after the camera receives a wireless connection; we recommend setting a static local IP address if this IP address changes by right clicking the camera in IP Camera Tools, setting a static IP, and pushing OK.

Congratulations! You have set up the wireless connection of the camera successfully.

WPS (WI-FI Protected Set-up)

Step 1) Press and hold the **WPS** button for **two seconds**.

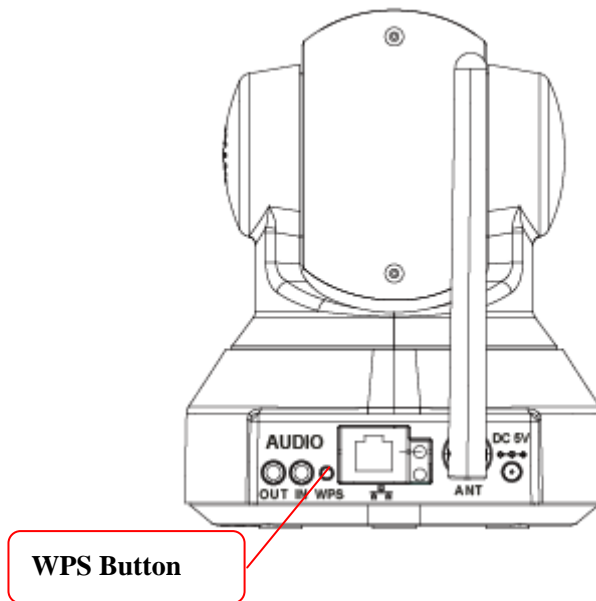

Figure 4.25

Step 2) Press the WPS button on your router **within 60 seconds**. The WPS button is usually on the back or side of your router. On some routers, you may need to log in to the web interface and click on an on-screen button to activate the WPS feature. If you are not sure where the WPS buttons is on your router, please refer to your router's User Manual.

The camera will automatically create a secure wireless connection to your router. If you have plugged in the network cable, please plug it out. The IP Camera Tool will search the camera's LAN IP. Make sure the PC and the camera share the same subnet.

NOTE :

The security mode of router cannot be WEP, or else the WPS settings may be failed.

4.3.3 PPPoE

If you are using a PPPoE connection, enable it and enter the User Name and Password for your PPPoE account.

Save Refresh	
Use PPPoE <input checked="" type="checkbox"/>	
PPPoE account	<input type="text" value="sz1025441266512"/> The maximum length of the user name is 20, support numbers, letters and symbols @ . \$ * - _
PPPoE password	<input type="password" value="....."/> The maximum password length is 12, does not support the character & =
Note: Once you save your settings, the camera will restart.	

Figure 4.26

4.3.4 DDNS

FOSCAM camera has embedded a unique DDNS domain name when producing, and you can directly use the domain name, you can also use the third party domain name.

FOSCAM domain name

Here take **test09.myfoscam.org** for example. Go to option of DDNS on the **Settings->Network** panel, you can see the domain name.

The screenshot shows the DDNS configuration page. At the top right, there are 'Save' and 'Refresh' buttons. The 'Enable DDNS' checkbox is checked. Under the 'Manufacturer's DDNS' section, the text box contains 'test09.myfoscam.org' and there is a 'Restore DDNS to factory' button. Under the 'Third Party DDNS' section, the 'DDNS Server' dropdown menu is set to 'None' and the 'Domain' text box is empty.

Figure 4.27

Now you can use **http:// Domain name + HTTP Port** to access the camera via internet.

Take hostname **test09.myfoscam.org** and HTTP Port no. 800 for example, the accessing link of the camera via internet would be **http:// test09.myfoscam.org:800**

Restore DDNS to factory: If you have configured Third Party DDNS successfully, but you want to use Manufacturer's DDNS again , here click this button and start Manufacturer's DDNS Service.

Third Party Domain Name Settings

User can also use third part DDNS, such as **www.no-ip.com. ,www. 3322.com**

Here take **www.no-ip.com** for example:

① **Step 1, Go to the website www.no-ip.com to create a free hostname**

Firstly: Login on www.no-ip.com and click No-IP Free to register.

Managed DNS Provider [Sign Up](#) [Home](#) [Blog](#) [Support](#) [Contact Us](#) [Sign In](#)

no-ip

[Services](#) [Why No-IP?](#) [Download](#) [Support](#)

Enhanced Dynamic DNS

more features, flexibility & control

Connect remotely to your computer, DVR, webcam or run your own web server or website on a dynamic IP address.
[What is Dynamic DNS?](#)

Sign Up Now Up to 25 Hostnames

Personal Use

Dynamic DNS allows you to monitor your home remotely via webcam, access your computer remotely, or even run your own server all on a dynamic IP address.

- ✔ Remote Access
- ✔ Webcam Monitoring
- ✔ Quick Installation
- ✔ Simple Domain Name

Get Started

Business Use

Trust our DNS experts with your web domains DNS management. Our Managed DNS will ensure your website is fast, reliable and always available.

- ✔ 100% Uptime Guaranteed
- ✔ Fast Redundant Websites
- ✔ Trusted Anycast Network
- ✔ 11 Points of Presence

Get Started

Figure 4.28

No-IP Free

No-IP Free is our entry level service. Use yourname.no-ip.org instead of a hard to remember IP address or URL. With No-IP Dynamic DNS, our free Dynamic Update Client keeps track of your changing IP address and updates your hostname, keeping your connection active.

Sign Up Now [More](#)

Click here to register.



Domain Registration

Fast, simple and affordable Domain Registrations. 100% Uptime Guaranteed!

[Learn More](#)



POP3 / IMAP Email

Easily manage email accounts for your own domain and access your email from anywhere.

[Learn More](#)



SSL Certificates

Ensure your website visitors are safe and secure by purchasing an SSL Certificate.

[Learn More](#)

Figure 4.29

Please register an account step by step according to instructions on www.no-ip.com

After registration, please login your email which used to register. You will receive an email from website, please click the link to activate your ACCOUNT as indicated in email.

Shenzhen Foscam Intelligent Technology Co., Limited

Tel: 86 755 2674 5668 Fax: 86 755 2674 5168

Secondly: Login the link with the registered username and password to create your domain name.

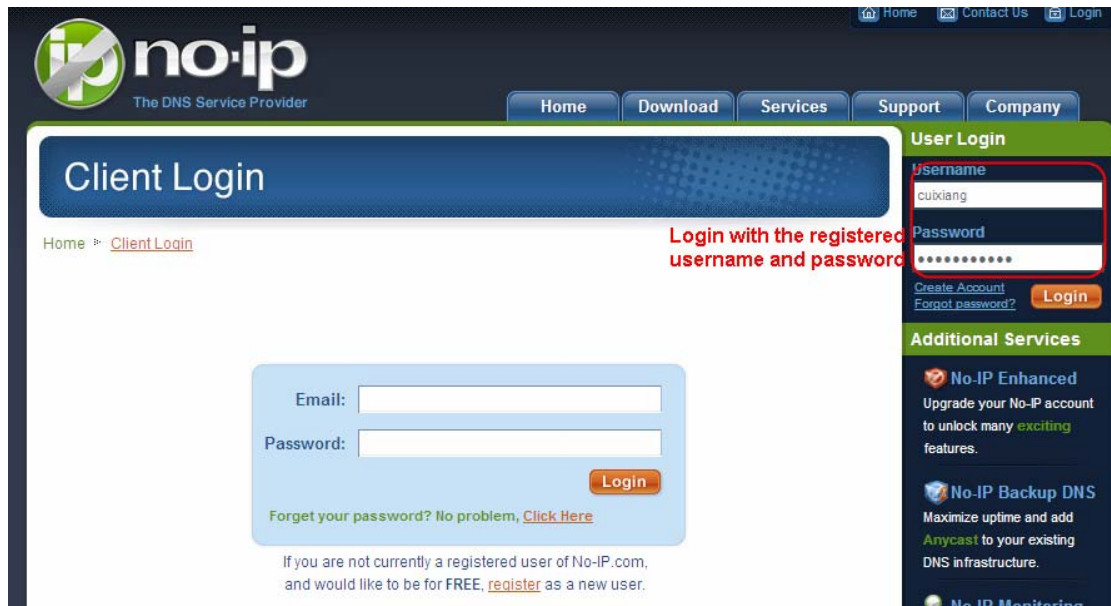

Figure 4.30

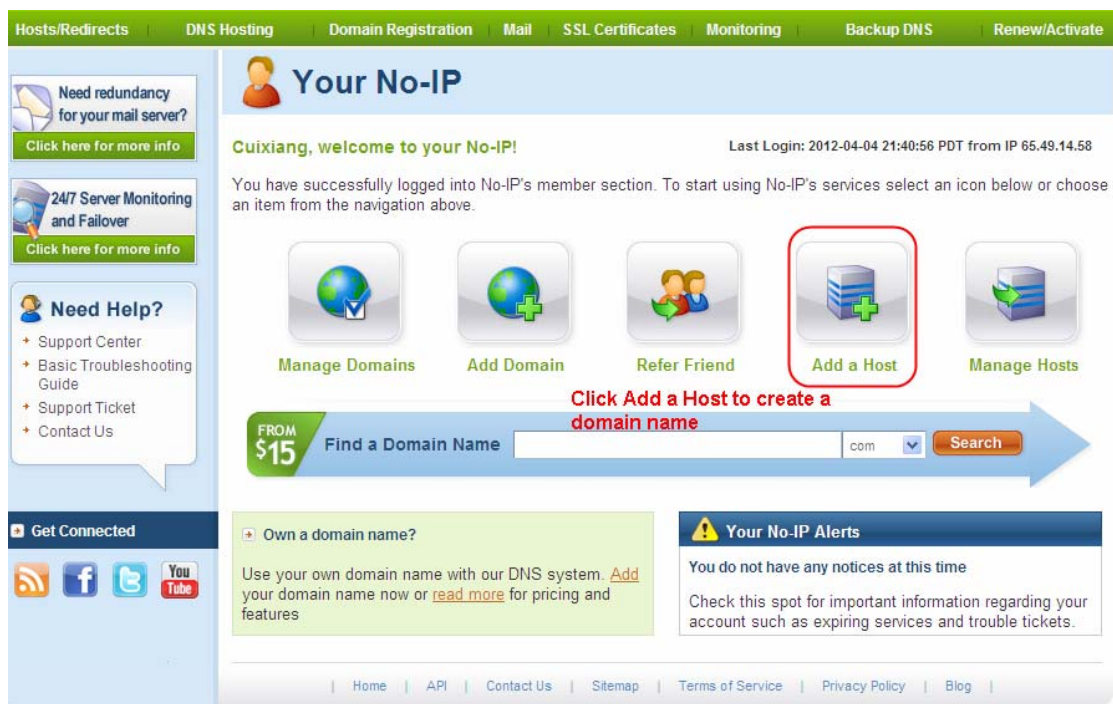

Figure 4.31

Please create the domain name step by step according to instructions on www.no-ip.com

Step 2, DO DDNS Service Settings within the Camera

Please set DDNS Settings within the camera by hostname, a user name and password you've got from www.no-ip.com

Take hostname `ycxgwp.no-ip.info`, user name **foscam**, password **foscam2012** for example.

Firstly, goes to option of DDNS Settings on the administrator panel.

Secondly, select No-IP as a server..

Shenzhen Foscam Intelligent Technology Co., Limited

Tel: 86 755 2674 5668 Fax: 86 755 2674 5168

Thirdly, fill **foscam** as DDNS user, fill password **foscam2012** as DDNS password, fill **ycxgwp.no-ip.info** as DDNS domain and server URL, Then click save to make effect. The camera will restart and to take the DDNS settings effective. Fourthly, after the restart, login the camera, and go to option of Device Status on the administrator panel, and check if the DDNS status is successful.

If failed, please double check if you have input the correct hostname, user name, and password, and try to redo the settings.

NOTE :

If you have set Third Party DDNS successfully ,the Foscam Domain Name will be invalid. The Third Party DDNS and the Foscam Domain Name cannot work at the same time, the last time you configured will take effect.

② Do port forwarding within the router

Example: The camera's LAN IP address is http://192.168.8.100:2000 , Media port no. is 9200.

Firstly, login the router, goes to the menu of **Port Forwarding or Port Trigger** (or named Virtue Server on some brands of router). **Take Linksys brand router as an example, Login the router, and goes to Applications & Gaming->Single Port Forwarding.**

Secondly, Create a new column by LAN IP address & HTTP Port No. of the camera within the router showed as below.

The screenshot shows the 'Single Port Forwarding' configuration page on a Linksys router. The table below represents the data shown in the screenshot:

Application Name	External Port	Internal Port	Protocol	To IP Address	Enabled
None	---	---	---	192.168.8. []	<input type="checkbox"/>
None	---	---	---	192.168.8. []	<input type="checkbox"/>
None	---	---	---	192.168.8. []	<input type="checkbox"/>
None	---	---	---	192.168.8. []	<input type="checkbox"/>
Http	2000	2000	Both	192.168.8.100	<input checked="" type="checkbox"/>
Media	9200	9200	Both	192.168.8.100	<input checked="" type="checkbox"/>
	---	---	---	192.168.8. []	<input type="checkbox"/>

Annotations in the image:

- Assign a name as you like here . (points to the Application Name dropdown)
- Fill the HTTP Port no. of the camera on the column of External Port and Internal Port (points to the 2000 ports)
- Fill the Media Port no. of the camera on the column of External Port and Internal Port . (points to the 9200 ports)
- Fill the LAN IP of the camera here, just input the last section (points to the IP address field)

Figure 4.32

③ Use domain name to access the camera via internet

After the port forwarding is finished, you can use the **domain name+ http no.** to access the camera via internet. Take hostname **ycxgwp.no-ip.info** and **http no. 2000** for example, the accessing link of the camera via internet would be **http:// ycxgwp.no-ip.info:2000**

4.3.5 UPnP



Figure 4.33

The default UPnP status is closed. You can enable UPnP, then the camera's software will be configured for port forwarding. Back to the **“Device Status”** panel, you can see the UPnP status:



Device Status	
Alarm Status	Disabled
Record Status	Not Recording
NTP Status	Disable
DDNS Status	Success http://aa2022.myfoscam.org:8000
UPnP Status	Success
WiFi Status	Not connected
IR LED Status	Off

Figure 4.34

The camera's software will be configured for port forwarding. There may be issues with your routers security settings, and sometimes may error. We recommend you configure port forwarding manually on your router .

4.3.6 Port

This camera supports HTTP Port. HTTP Port is used to access the camera remotely. If you want to access the camera and view the video, the HTTP Port must both be configured correctly.

HTTP port: By default, the HTTP is set to 88. Also, they can be assigned with another port number between 1 and 65535. But make sure they can not be conflict with other existing ports like 25, 21.



HTTP Port	88
HTTPS Port	443
ONVIF Port	888

Figure 4.35

Another way to change the HTTP port NO.

Step 1: Open the IP Camera Tool, select the camera you would like to change the port of, right click on the IP address, and click on "Network Configuration", this brings up the network configuration box as shown in Figure 4.36 and 4.37.

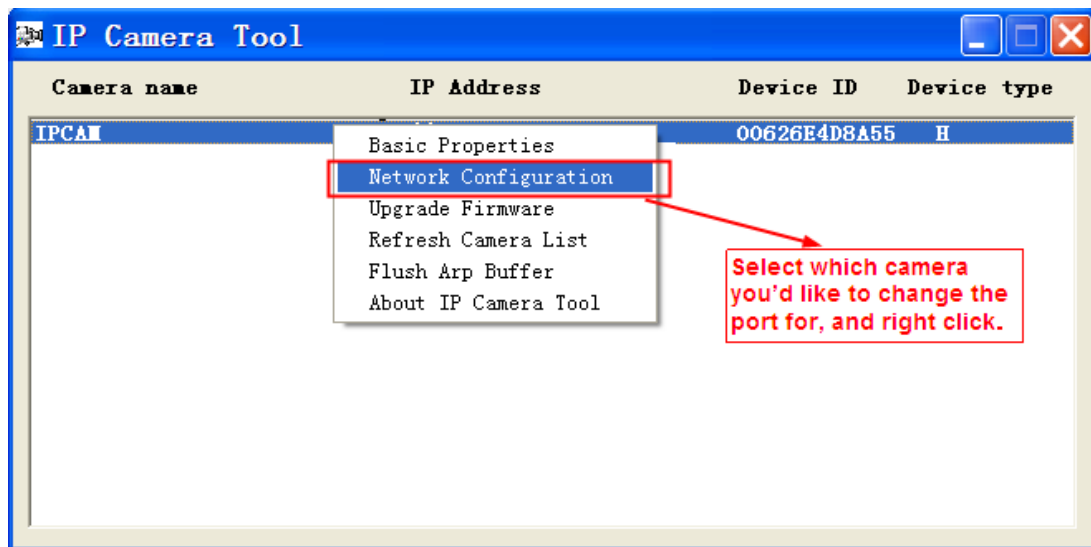

Figure 4.36

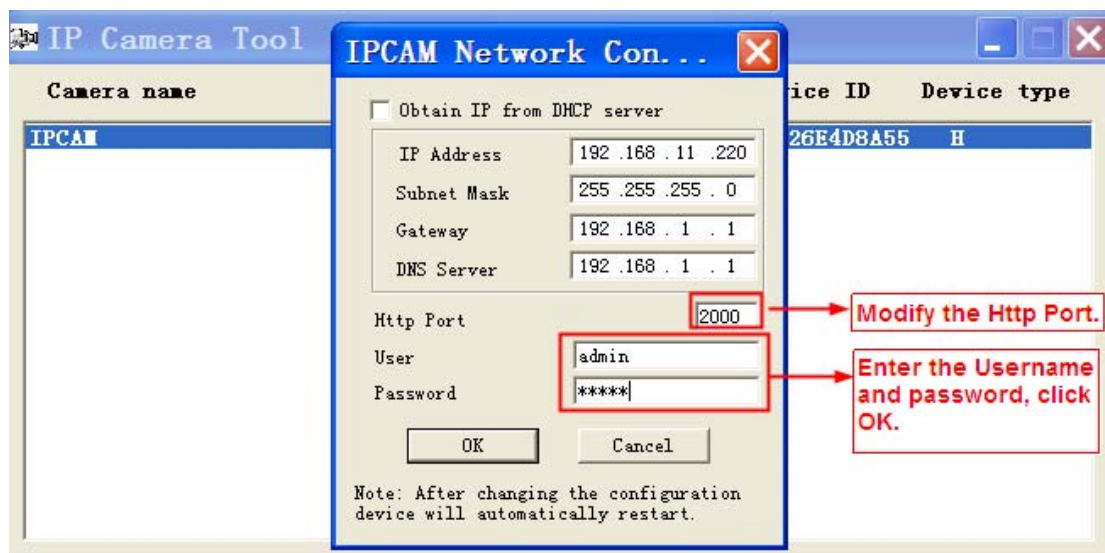

Figure 4.37

Step 2: Enter the username and password of the Administrator (default username is admin with a blank password), and click "OK" to apply changes.

Step 3: Wait around 10 seconds, you'll see that the camera's LAN IP address has changed. In our example it was changed to 2000, so we see http://192.168.8.102:2000 in IP Camera Tool. Also, the LAN IP address is now fixed at a static IP address of http://192.168.8.102:2000. This IP address will not change even if the camera is powered off and back on, the camera will remain on this LAN IP address. This is very important that a static LAN IP address is set, or you may have problems later with remote access and seeing the camera remotely if the camera loses power and reconnects on a different LAN IP address. Make sure you set a static LAN IP address!

Camera name	IP Address	Device ID	Device type
IPCAM	Http://192.168.11.220:88	00626E4D8A55	H

Figure 4.38

Note: Http port and Media port must be different.

If the camera cannot be accessed, please make sure the port forwarding is succeed.

HTTPS port: The default port is 443. You can use the url to access the camera: **https:// IP + HTTPS port.**

Sometimes you need to add the url to the Trusted Sites.

Open Internet Explorer if it is not already opened. Click on **Tools**, then click **Internet Options**.

Next, click the **Security** tab, then click the **Trusted sites** button.

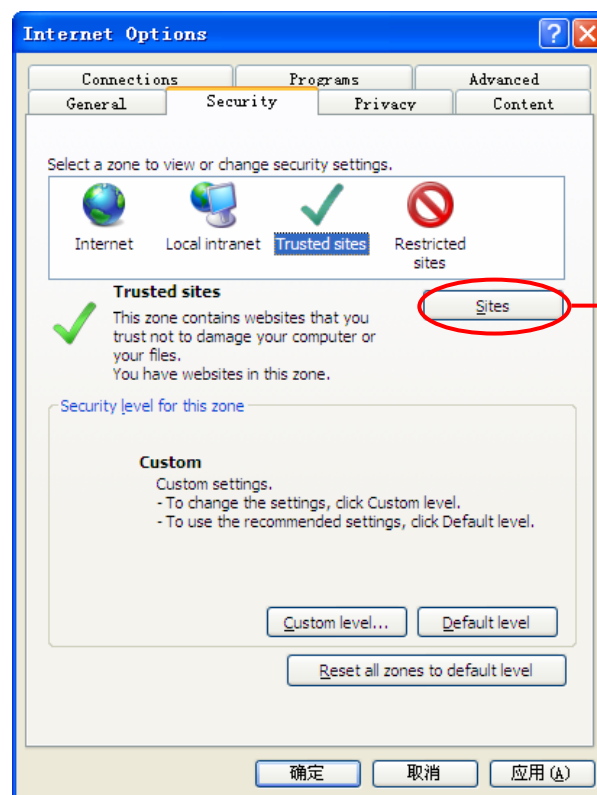

Figure 4.39

Click **Sites** then you can add the camera's https web site to the internet explorer.

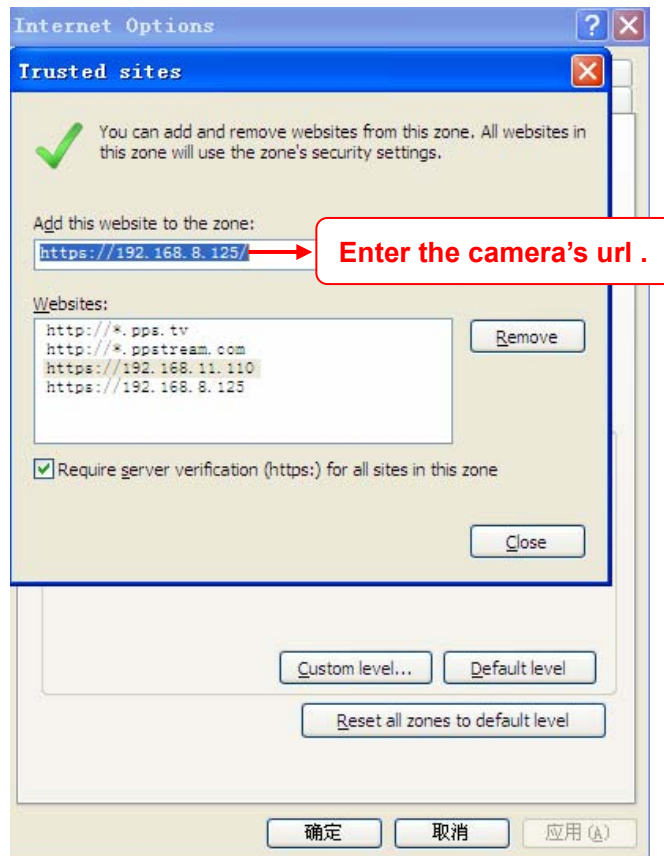

Figure 4.40

For **Firefox**, you can add the trusted as the following way:

Tools ---- Options ---- Advanced --- View Certificates --- Servers

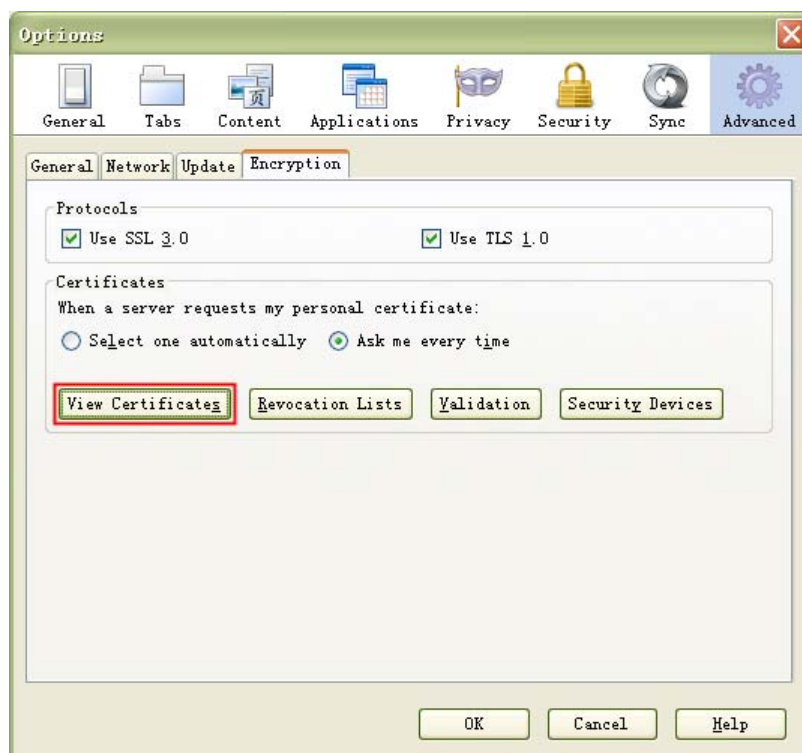

Figure 4.41

Click **View Certificates**, and go to **Servers** option.

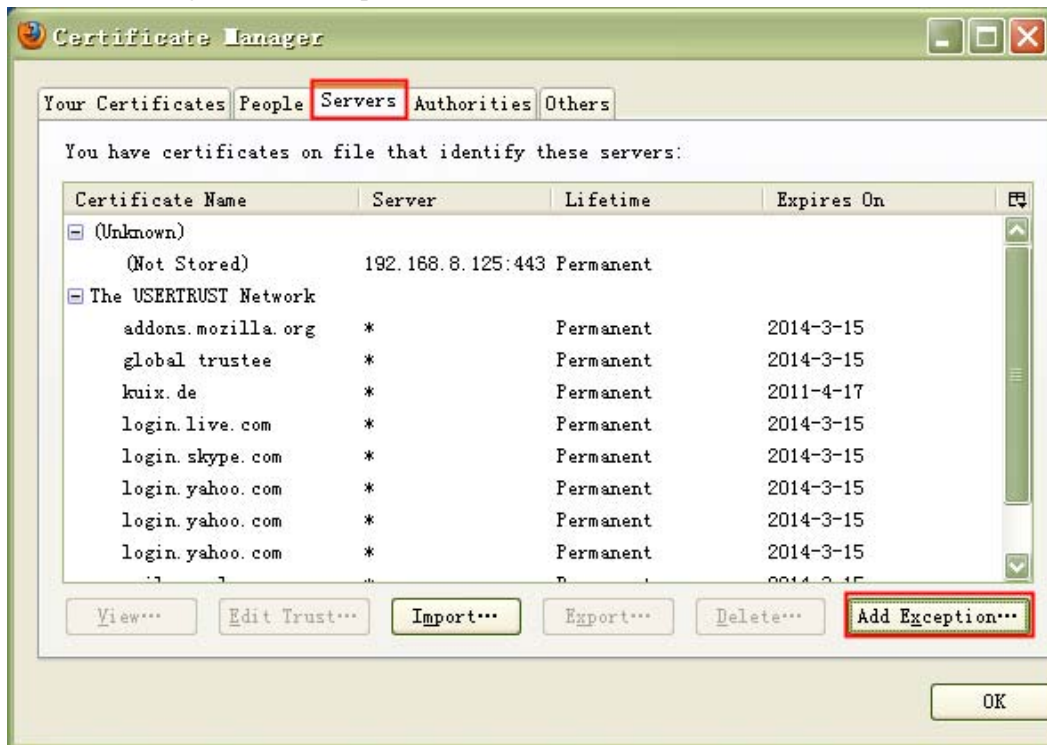

Figure 4.42

Go to **Add Exception** panel.

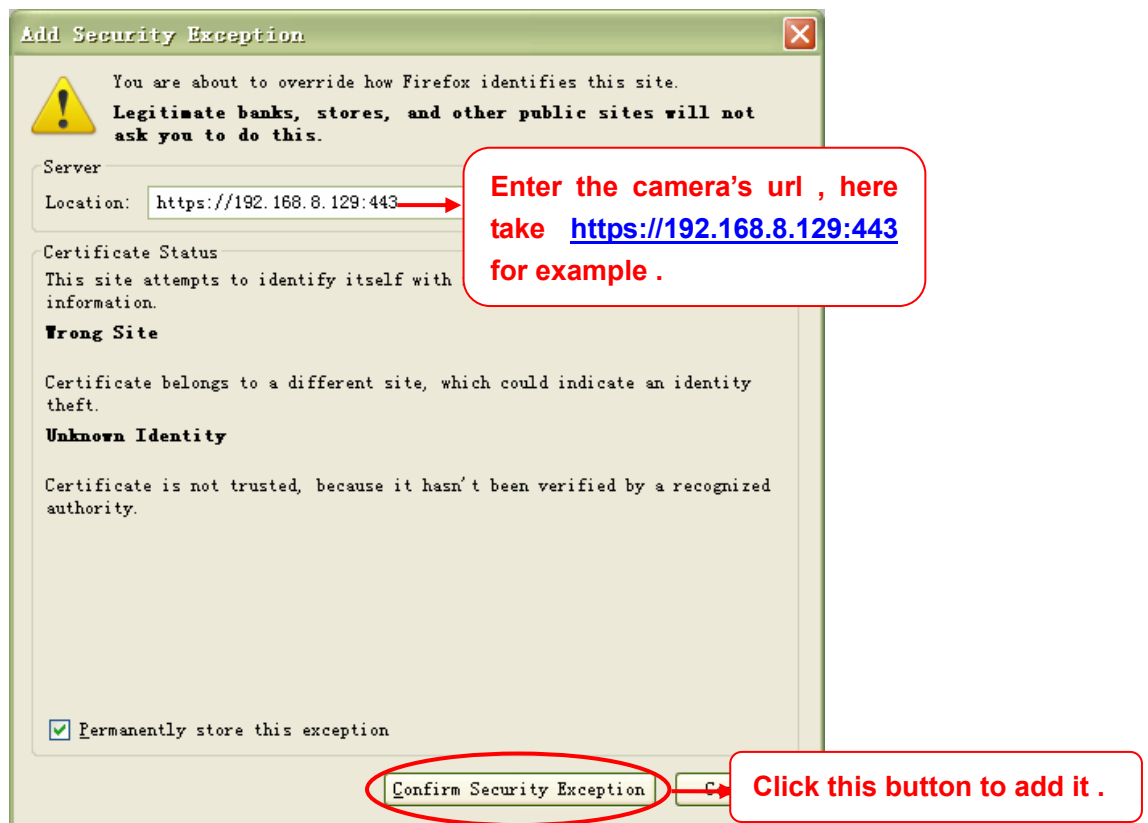

Figure 4.43

ONVIF port: By default, the ONVIF port is set to 888. Also, they can be assigned with another port number between 1 and 65535(except 0 and 65534). But make sure they can not be conflict with other existing ports.

RTSP function

RTSP URL `rtsp:// [user name][:password]@IP:HTTP port number/videosream`

The part in the square brackets may be omitted.

user name & password:

The user name and password to access the camera. This part can be omitted.

IP: WAN or LAN IP address.

Videostream:Here support three mode: videoMain, videoSub and audio. When the network speed is bad, here you had better select videoSub. If you select audio, you can only hear the sound but cannot see the video.

For example:

IP: 192.168.1.11

HTTP Port number: 88

User name: admin

Password: 123

Here I can enter one of the following URLs in the VLC.

1. `rtsp://admin:123@192.168.1.11:88/videoMain`
2. `rtsp:// @192.168.1.11:88/videoMain`
3. `rtsp://:123@192.168.1.11:88/videoMain`
4. `rtsp://admin@192.168.1.11:88/videoMain`

Open the VLC, and go to Media Open Network Stream option, then enter the URL into VLC.

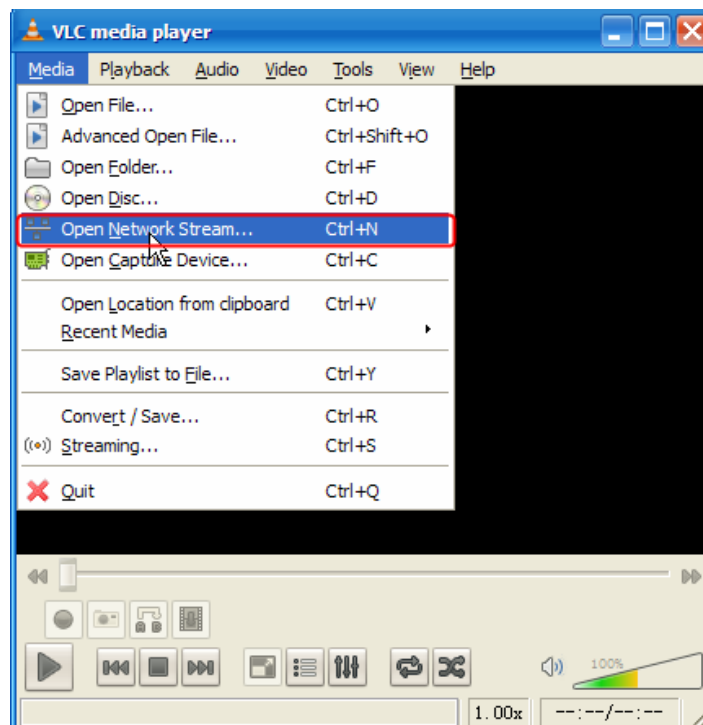

Figure 4.44

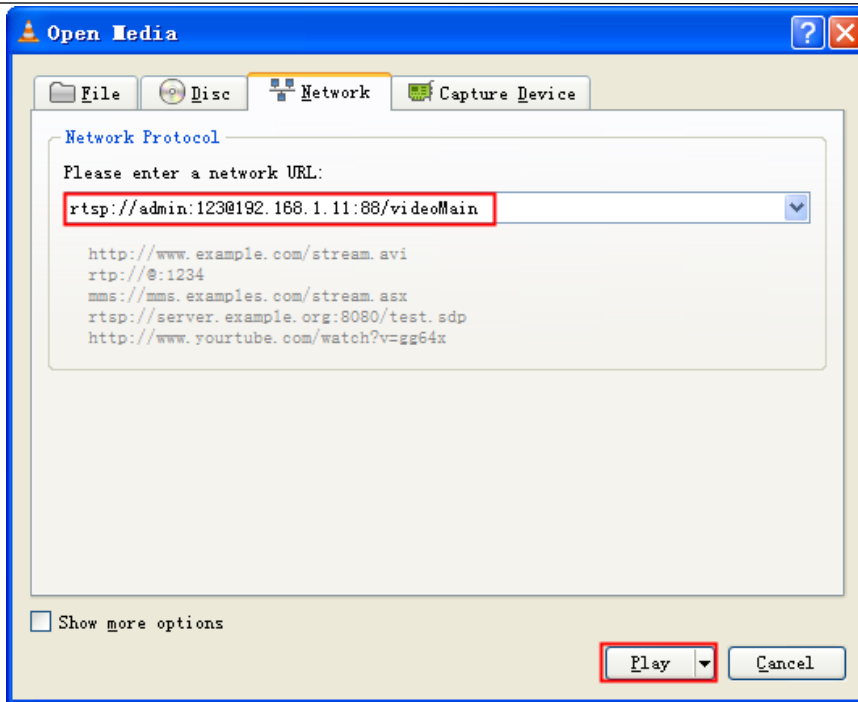

Figure 4.45

Sometimes you may need to enter the user name and password again. Click OK and you can see the real-time preview.

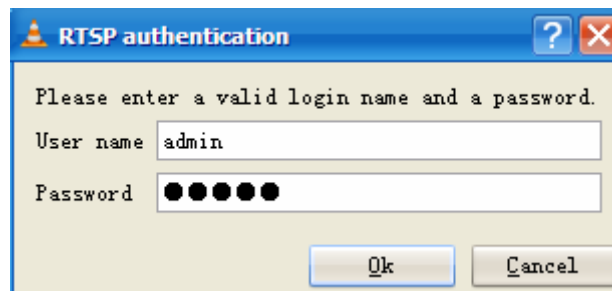

Figure 4.46

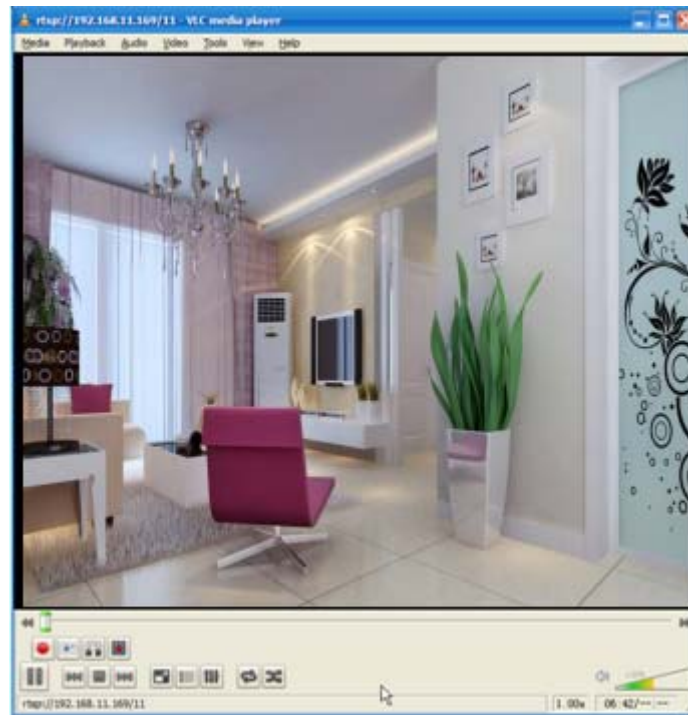

Figure 4.47

If you cannot play the video in the VLC player, please check the port mapping. You can read Quick Installation Guide about How to configure port forwarding.

NOTE:

If you modify the camera's username or password, you had better reboot the camera, or else the new username and password cannot take effect when you enter the authentication in the VLC.

4.3.7 Mail Settings

If you want the camera to send emails when motion has been detected, here Mail will need to be configured.

The screenshot shows an SMTP configuration form with the following fields and callouts:

- 5**: Save button
- 1**: SMTP Port (25)
- 2**: SMTP Username (test123@gmai.com)
- 3**: Sender E-mail (test123@gmai.com)
- 6**: Test button
- 4**: First Receiver (tset@hotmail.com)

Figure 4.48

1----- SMTP Server/ Port /Transport Layer Security Enter SMTP server for sender. **SMTP** port is usually set as 25. Some SMTP servers have their own port, such as 587 or 465, and Transport Layer Security usually is None. If you use Gmail, Transport Layer Security must be set to TLS or STARTTLS and SMTP Port must be set to 465 or 25 or 587, which port you choose should be decided by which Transport Layer Security you select.

2-----SMTP Username/ password ID account and password of the sender email address

3----- Sender E-mail Mailbox for sender must support SMTP

4----- Receiver Mailbox for receiver need not support SMTP,you can set 4 receivers

5----Save Click Save to take effect

6----Test Click Test to see if Mail has been successfully configured.

Click **Test** to see if Mail has been successfully configured.

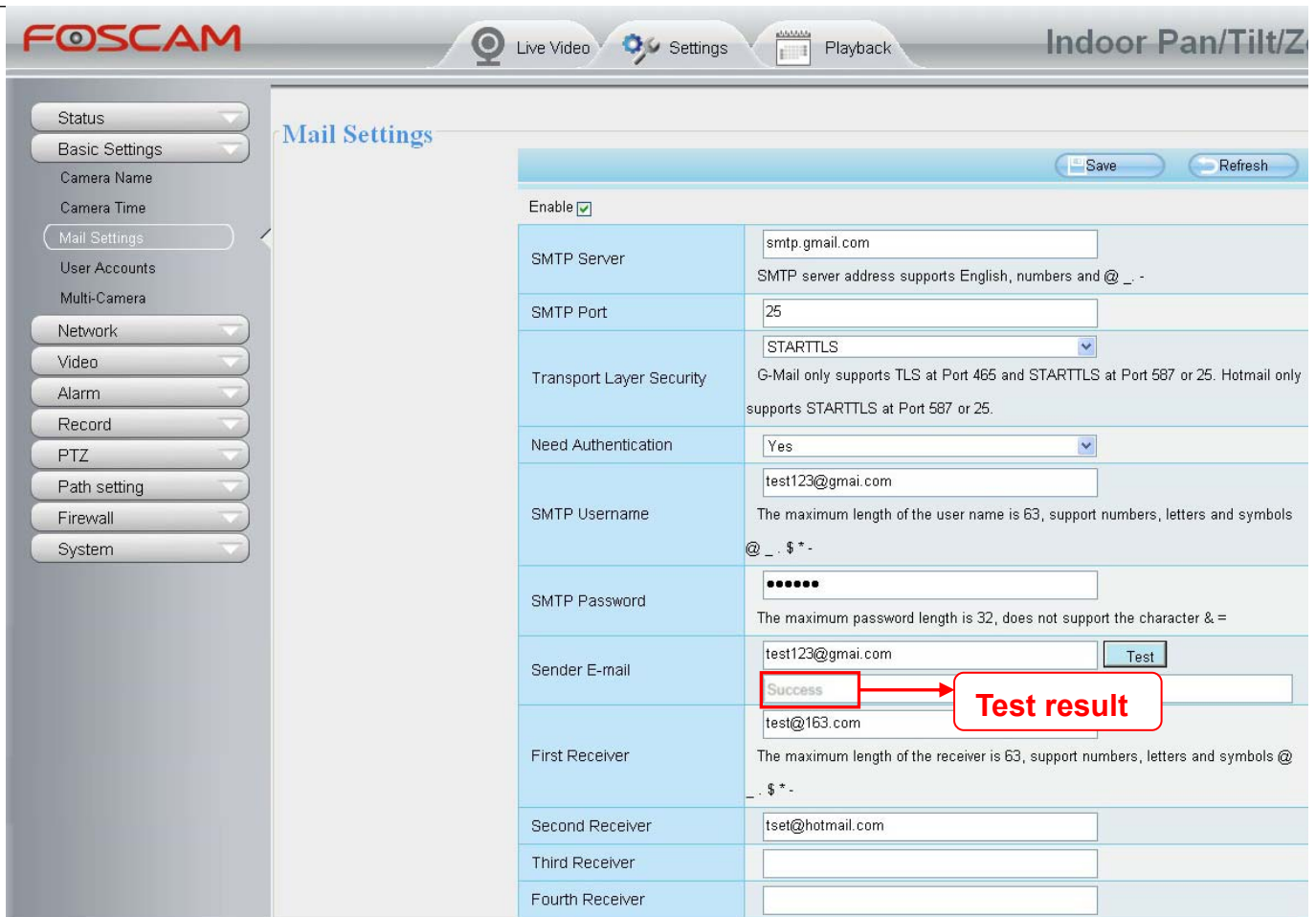

Figure 4.49

If the test success, you can see the Success behind the Test, at the same time the receivers will receive a test mail.



Figure 4.50

If the test fails with one of the following errors after clicking **Test**, verify that the information you entered is correct and again select Test .

1) Cannot connect to the server

Shenzhen Foscam Intelligent Technology Co., Limited

Tel: 86 755 2674 5668 Fax: 86 755 2674 5168

- 2) Network Error. Please try later
- 3) Server Error
- 4) Incorrect user or password
- 5) The sender is denied by the server. Maybe the server need to authenticate the user, please check it and try again
- 6) The receiver is denied by the server. Maybe because of the anti-spam privacy of the server
- 7) The message is denied by the server. Maybe because of the anti-spam privacy of the server
- 8) The server does not support the authentication mode used by the device

4.3.8 FTP Settings

If you want to upload record files and images to your FTP server, you can set **FTP Settings**.

<input type="button" value="Save"/> <input type="button" value="Refresh"/>	
FTP Server	<input type="text" value="ftp://192.168.8.150"/> <small>Example:ftp://192.168.1.103/dir The maximum length of the address is 127, does not support the character & =</small>
Port	<input type="text" value="21"/>
FTP Mode	<input type="text" value="PORT"/>
Username	<input type="text" value="yaocuixiang"/> <small>The maximum length of the user name is 63, support numbers, letters and symbols _ @ \$ * - . # !</small>
Password	<input type="password" value="....."/> <small>The maximum password length is 63, does not support the character & =</small>
<input type="button" value="Test"/>	<input type="text" value="Success"/>

Figure 4.51

<input type="button" value="Save"/> <input type="button" value="Refresh"/>	
FTP server	<input type="text" value="ftp://ftp.mgenseal.com"/> <small>example:ftp://192.168.1.103</small>
Port	<input type="text" value="21"/>
FTP Mode	<input type="text" value="PORT"/>
User name	<input type="text" value="deotestge"/>
Password	<input type="password" value="....."/>
<input type="button" value="Test"/>	<input type="text" value="Success"/>

Figure 4.52

FTP server: If your FTP server is located on the LAN, you can set as Figure 3.54.

Shenzhen Foscam Intelligent Technology Co., Limited

Tel: 86 755 2674 5668 Fax: 86 755 2674 5168

If you have an FTP server which you can access on the internet.

Port: Default is port 21. If changed, external FTP client program must change the server connection port accordingly.

FTP Mode: Here supports two modes: PORT and PASV.

Username/password: The FTP account and password.

Click **Save** to take effect.

Click **Test** to see if FTP has been successfully configured.

4.4 Video

This section allows you to configure Video stream settings, On screen display and Snapshot settings.

4.4.1 Video Settings

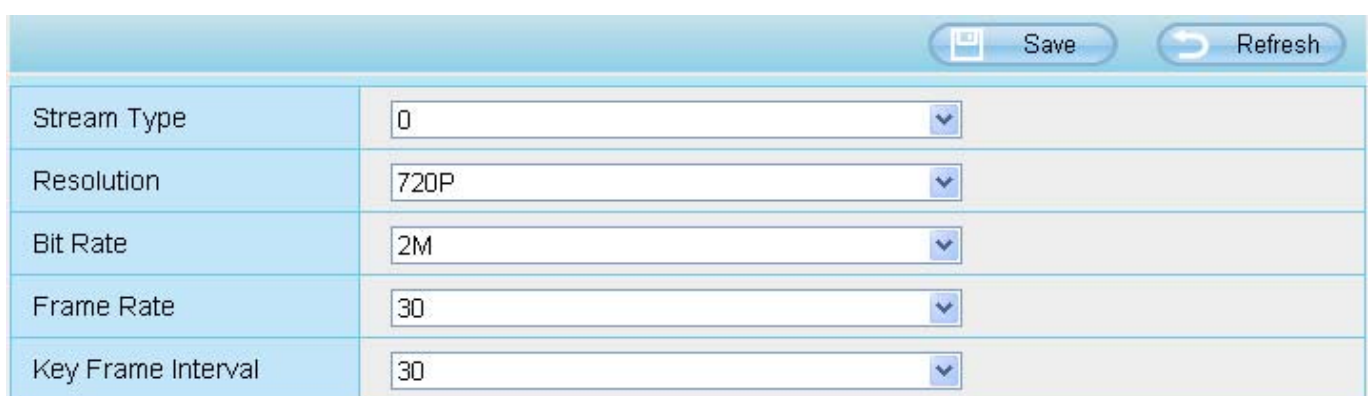

Save Refresh	
Stream Type	0
Resolution	720P
Bit Rate	2M
Frame Rate	30
Key Frame Interval	30

Figure 4.53

Stream type: There are four types to identify different streams you have set.

Resolution: The camera supports two types: 720P, VGA. The higher the resolution is, the clearer video will become. But the code flux will become larger too, and it will take up more bandwidth.

Bit Rate: Generally speaking, the larger the bit rate is, the clearer video will become. But the bit rate configuration should combine well with the network bandwidth. When the bandwidth is very narrow, and bit rate is large, that will lead to video can not play well.

Frame Rate: Note that a larger frame size takes up more bandwidth. When the video format is 50Hz, the maximum frame rate is 25 fps. When the video format is 60Hz, the maximum frame rate is 30 fps. You should lower frame rate when the bandwidth is limited. Normally, when the frame rate above 15, you can achieve fluently video.

Key Frame Interval: The time between last key frame and next key frame. The shorter the duration, the more likely you will get a better video quality, but at the cost of higher network bandwidth consumption.

4.4.2 On Screen Display

This page is used to add timestamp and device name on the video.

OSD	
<input type="button" value="Save"/> <input type="button" value="Refresh"/>	
Display Timestamp	Yes
Display Camera Name	Yes

Figure 4.54

Display Timestamp: There are two options: Yes or NO. Select Yes and you can see the system date on the video,

Display Camera Name: There are two options: Yes or NO. Select Yes and you can see the device name on the video.

4.4.3 Privacy Zone

This page is used to set some mask as privacy zone on the video.

Privacy Zone	
Allow Privacy Zone	Yes
<input type="button" value="Set Privacy Zone"/>	

Figure 4.55

Allow On Screen Display Mask: There are two options: Yes or NO. Select yes and draw a mask area on the video, the mask area will be black on the video.

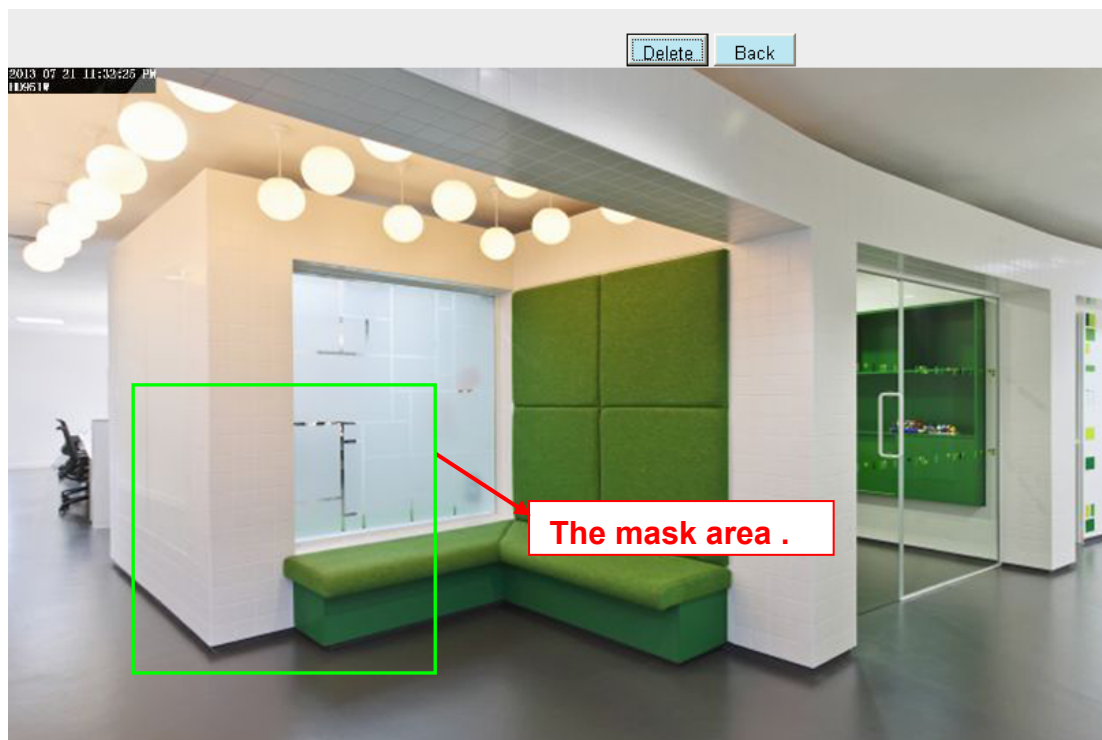

Figure 4.56

Click **Back** button and return to the OSD page, click Save to take effect.

Back to the surveillance window, you can see the mask area as the following picture:

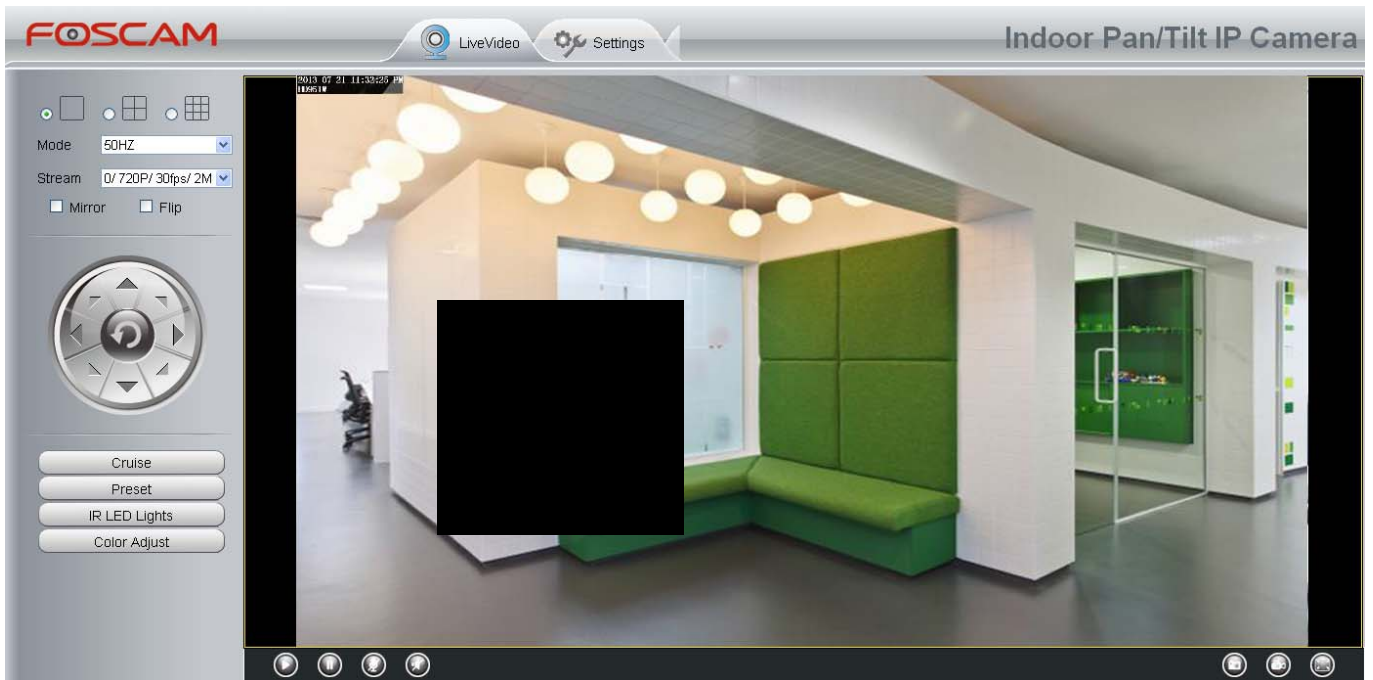

Figure 4.57

4.4.4 Snapshot Settings

On this page you can set the snapshot pictures' image quality and the storage path.

Save Refresh

Image Quality	Medium
Alarm Pictures Save To	FTP

Enable timing to capture

Capture interval	2	(1-65535s)
------------------	---	------------

Schedule

	00	01	02	03	04	05	06	07	08	09	10	11	12	13	14	15	16	17	18	19	20	21	22	23
MON																								
TUE																								
WED																								
THU																								
FRI																								
SAT																								
SUN																								

Figure 4.58

Image Quality: Low, Middle and High. The higher the quality, the picture will be clearer.

Save Path: FTP. If you have done FTP and Alarm settings, when alarming, the camera will snap pictures to the FTP automatically.

Enable timing to capture

To enable capture interval, follow the steps below:

1 Select **Enable Motion detection**

2 **Capture interval:**The interval time between two captures.

3 Select the capture time

- Capture anytime

Click the black button up the MON, you will see all time range turn red. When something moving in the detection area at anytime, the camera will capture.

- Specify an capture schedule

Click the week day words, the corresponding column will be selected. For example, click TUE, the all column of TUE turns to red, that means during Tuesday whole day, the camera will capture.

- Press the left mouse and drag it on the time boxes, you can select the serial area,

4 Click **Save button** to take effect.

4.5 Alarm

IP Camera supports **Motion Detection Alarm**, when the motion has been detected, it will send emails or upload images to FTP.

Save 7 Refresh

Enable 1

Sensitivity Medium 2

Triggered Interval 10s 3

Action

Ring

Send E-mail

Take Snapshot Time Interval 2s 4

Set Detection Area 5

Schedule 6

	00	01	02	03	04	05	06	07	08	09	10	11	12	13	14	15	16	17	18	19	20	21	22	23
MON																								
TUE																								
WED																								
THU																								
FRI																								
SAT																								
SUN																								

The schedule recording will stop while alarm recording is beginning, and will continue automatically after alarm recording end

Figure 4.59

To enable motion detection, follow the steps below:

To enable motion detection, follow the steps below:

1 Enable Motion detection

2 Sensitivity--- It supports three modes: Low, Middle and High. The higher the sensitivity, the camera will be more easily alarmed. Select one motion sensitivity.

3 Trigger interval--- The interval time between two motion detections. Here supports 5s/6s/7s/8s/9s/10s/11s/12s/13s/14s/15s. Select one interval time.

4 Select the alarm indicators

There are three alarm indicators:

A Ring

There is an embedded speaker inside the camera, so if you select Ring, when the motion has been detected, the people around the camera will hear beep alarm sound.

B Send E-mail

If you want to receive alarm emails when motion is detected, you must select Send E-mail and set Mail Settings first. The alarm email cannot contain the alarm picture if you have not selected Take Snapshot.

C Take Snapshot

If you select this checkbox, when the motion has been detected, the camera will snap the live view window as a still picture and load it to the FTP. Make sure you have set FTP and set FTP as the storage path in Video->Snapshot settings panel.

If you select Send Email, at the same time the picture will be send to you as an attachment.

Capture interval: The interval time between two pictures.

Step 05: Set detect area

Click set detect area and it pop up a window, then you can draw the detection area. Click Back button after settings. When something moving in the detection area, the camera will alarm.



Figure 4.60

Step 06: Alarm Schedule

① Alarm anytime when motion is detected

Click the black button up the MON, you will see all time range turn red. When something moving in the detection area at anytime, the camera will alarm.

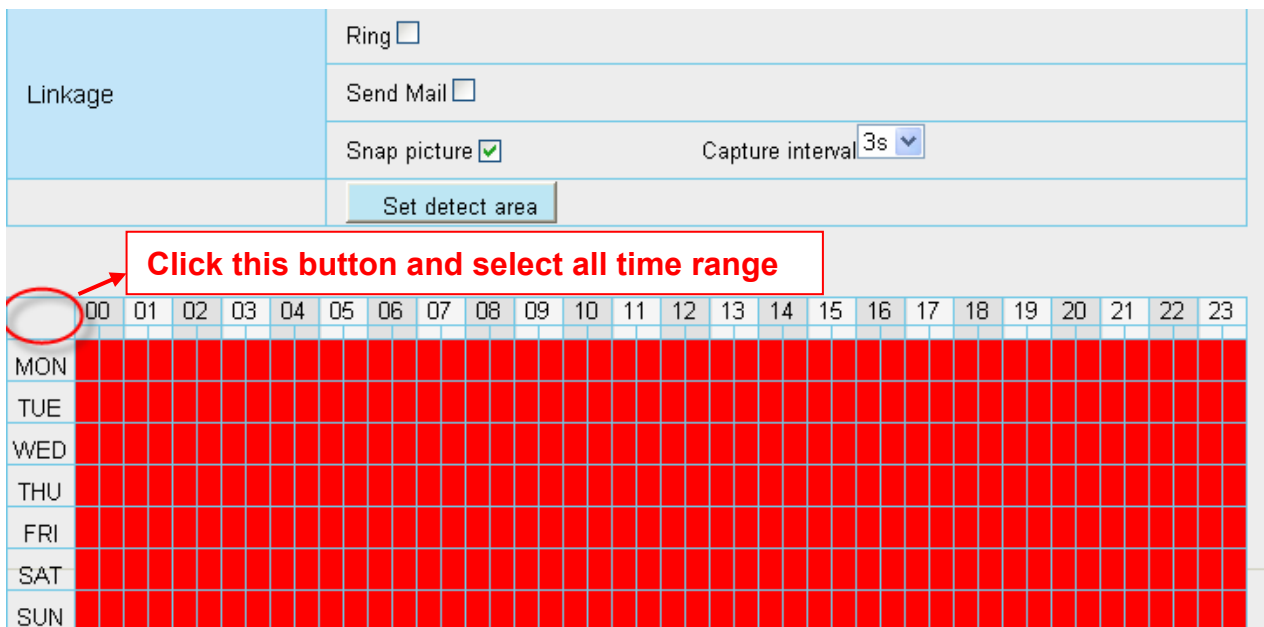

Figure 4.61

② Specify an alarm schedule

Click the week day words, the corresponding column will be selected. For example, click TUE, the all column of TUE

turns to red, that means during Tuesday whole day, when something moving in the detection area, the camera will alarm.

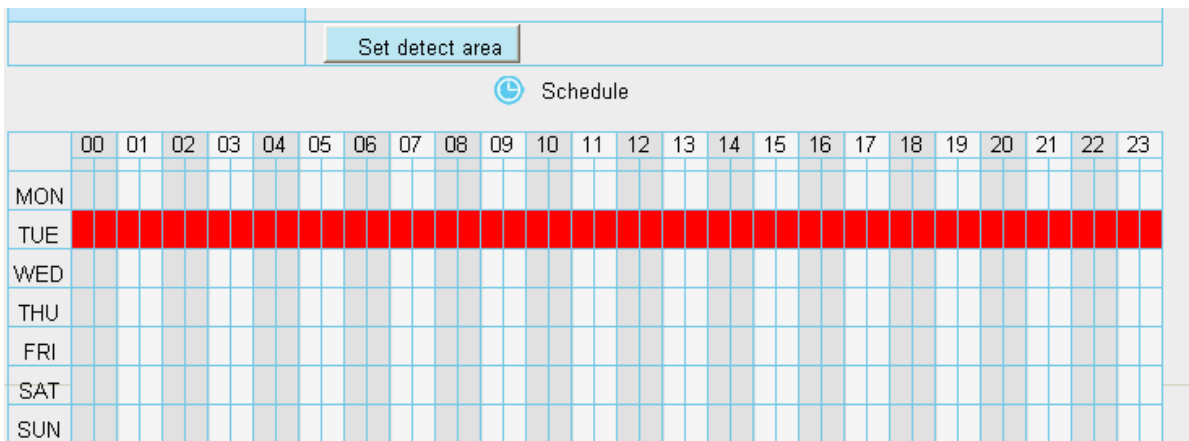

Figure 4.62

③ Press the left mouse and drag it on the time boxes, you can select the serial area.

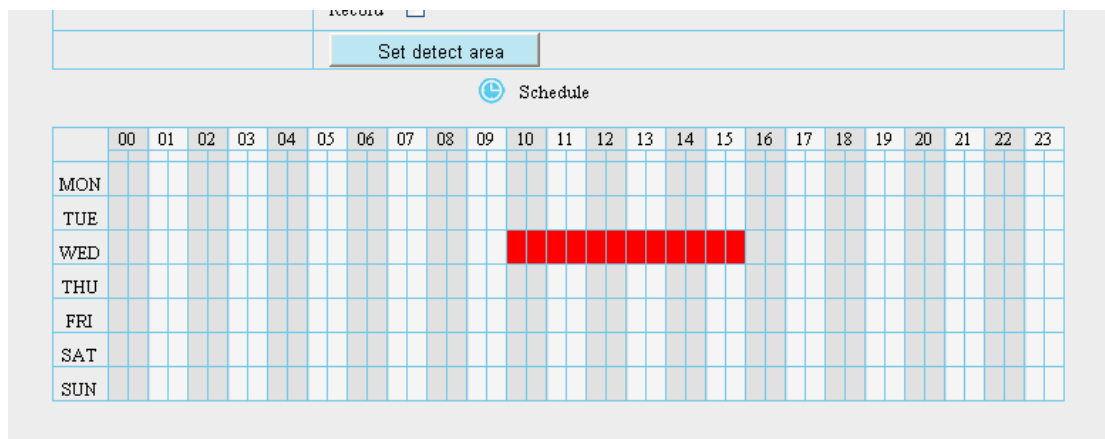

Figure 4.63

Step 07: Click Save button to take effect.

When the motion has been detected during the detection time in the detection area, the camera will alarm and adopt the corresponding alarm indicators.

NOTE: You must set the detection area and detection schedule, or else there is no alarm anywhere and anytime.

4.6 Record

This section will allow you to change the record files storage path and the record time.

4.6.1 Storage Location

On this page you can change the alarm and manually recording storage path..

Storage Location

Save Refresh

Recording Location	FTP
Local Recording Location	c:\IPCamRecord <input type="button" value="Browse"/>

Recording Location is used for alarm recordings and schedule recordings.

The local recording must be stored in local storage. The default Windows storage location is "c:\IPCamRecord". The default Mac OS storage location is "/IPCamRecord". If you modify the path on other Foscam cameras, this default storage location will be modified accordingly.

Figure 4.64

Recording Location : FTP. When the camera alarmed, it will store the alarm files to FTP.

Local Recording Location: For Windows OS, the manual recording path is C:/ IPCamRecord, you can change another one. For MAC OS, the manual recording path is: / IPCamRecord.

4.6.2 Local Alarm Record

This page you can enable the local alarm record and Local Alarm record time.

Save Refresh

Whether to open the PC sound alarm	No
Enable Local Alarm Record	<input checked="" type="checkbox"/>
Local Alarm Record Time	30s

When the PC sound alarm is enabled, the PC will make a sound only in Live Video page while the IPC detected an alarm

Figure 4.65

4.6.3 Record Schedule

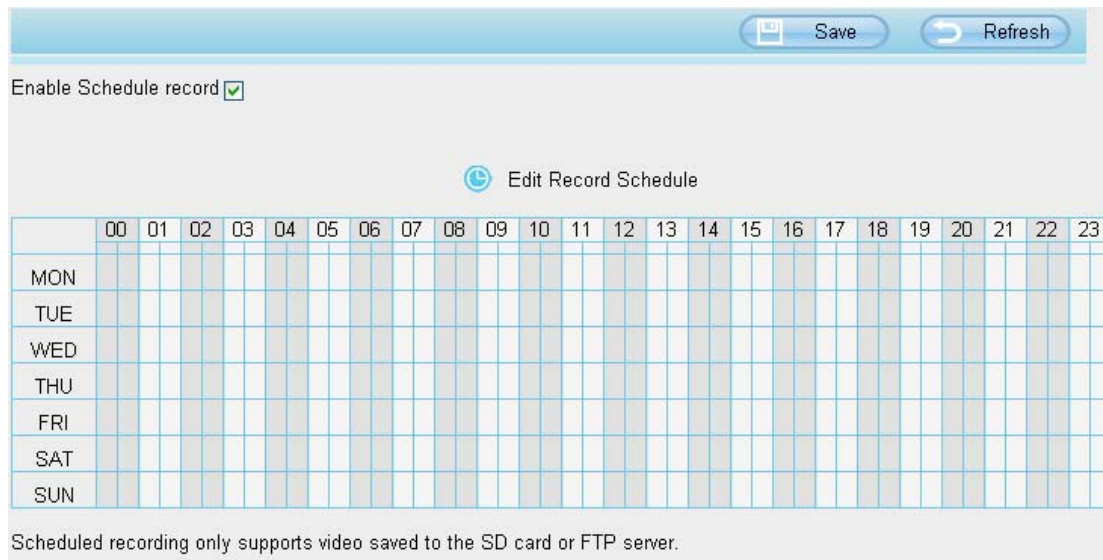

Enable Schedule record

Edit Record Schedule

	00	01	02	03	04	05	06	07	08	09	10	11	12	13	14	15	16	17	18	19	20	21	22	23
MON																								
TUE																								
WED																								
THU																								
FRI																								
SAT																								
SUN																								

Scheduled recording only supports video saved to the SD card or FTP server.

Figure 4.66

- Scheduled recording only supports video saved to FTP server.
- You can refer to "alarm schedule." in "4.5 Alarm" about editing the time of recording Schedule.

4.7 PTZ

This page will allow you to change the pan/tilt speed and do cruise tracks settings.

4.7.1 Pan & Tilt Speed

There are five Pt speed types: very fast, fast, normal, slow and very slowly. Select the desired PTZ speed type and click save button .



Save Refresh

PTZ speed Normal

Figure 4.67

4.7.2 Cruise Settings

This section explains how to add/ delete/ alter one cruise track.

There are two default cruise tracks: Vertical and Horizontal.

Vertical: The camera will rotate from up to down

Horizontal: The camera will rotate form left to right.

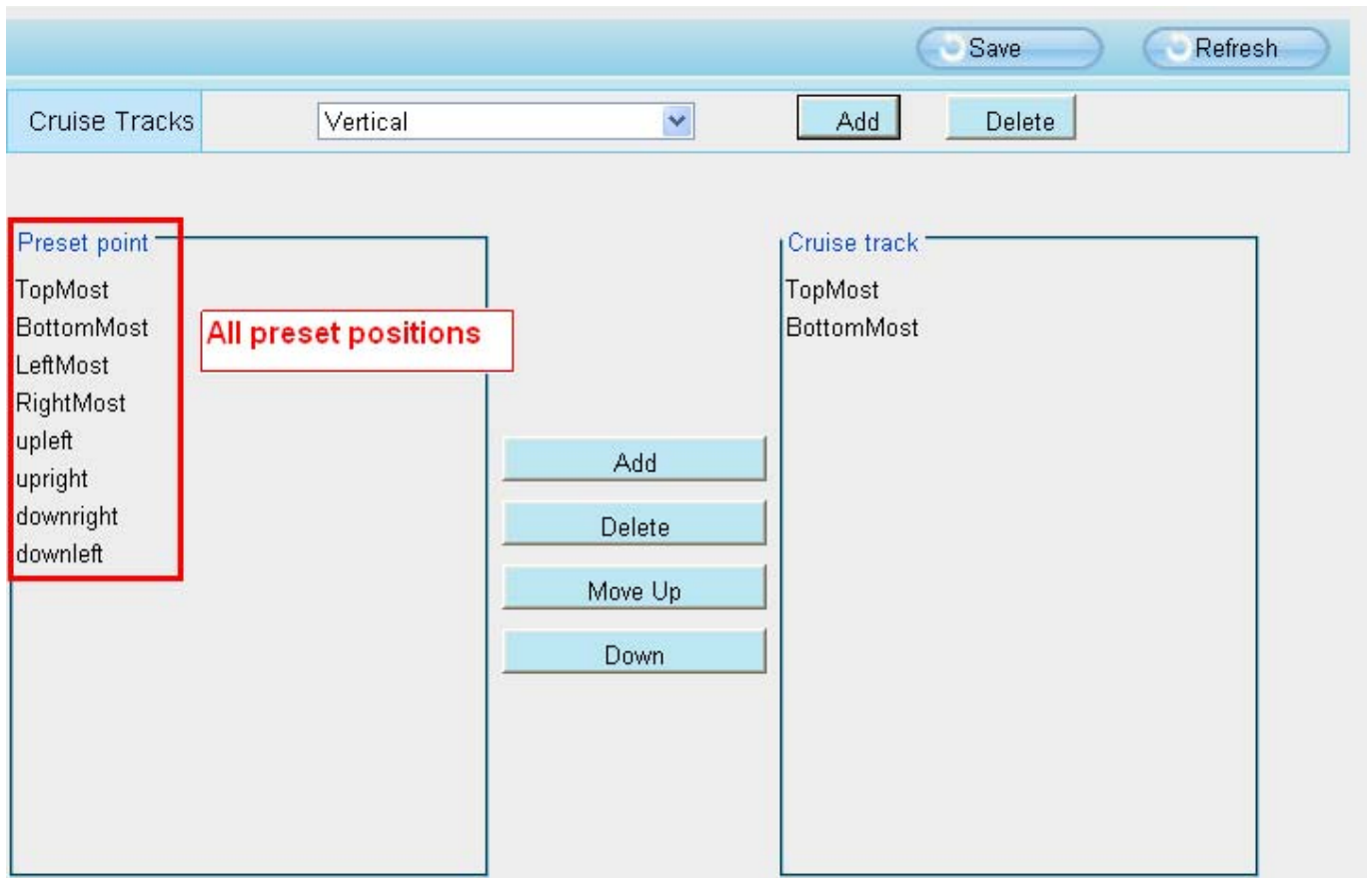

Figure 4.68



Figure 4.69

Add: Add one cruise track.

Delete: Select one cruise track and delete it.

How to do add cruise tracks ?

Firstly, Click Add button and enter a descriptive name to identify the cruise track

Secondly: On the lower left of the page, you can see all preset points you have added. Select one preset point and click Add button, you can see the preset point has been added to the cruise track on the cruise track page. You need to add two or more preset points to the cruise track.

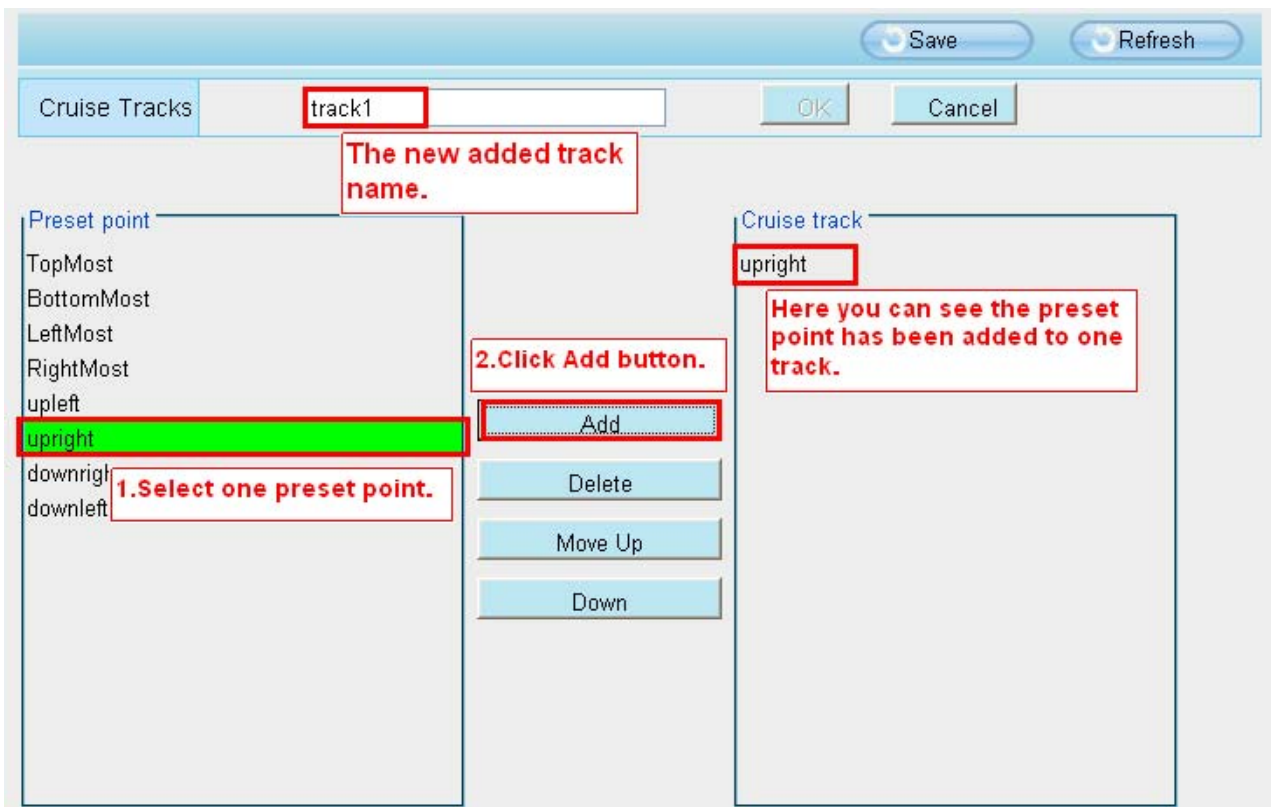

Figure 4.70

Thirdly: Click **OK** button and the cruise track will take effect.

You can add other cruise track as the same method.

For example: I have added three preset points to the “track 1”, that means : When I select the “track 1” on the surveillance window, the camera moves as the following track: upright then Right Most last downleft.

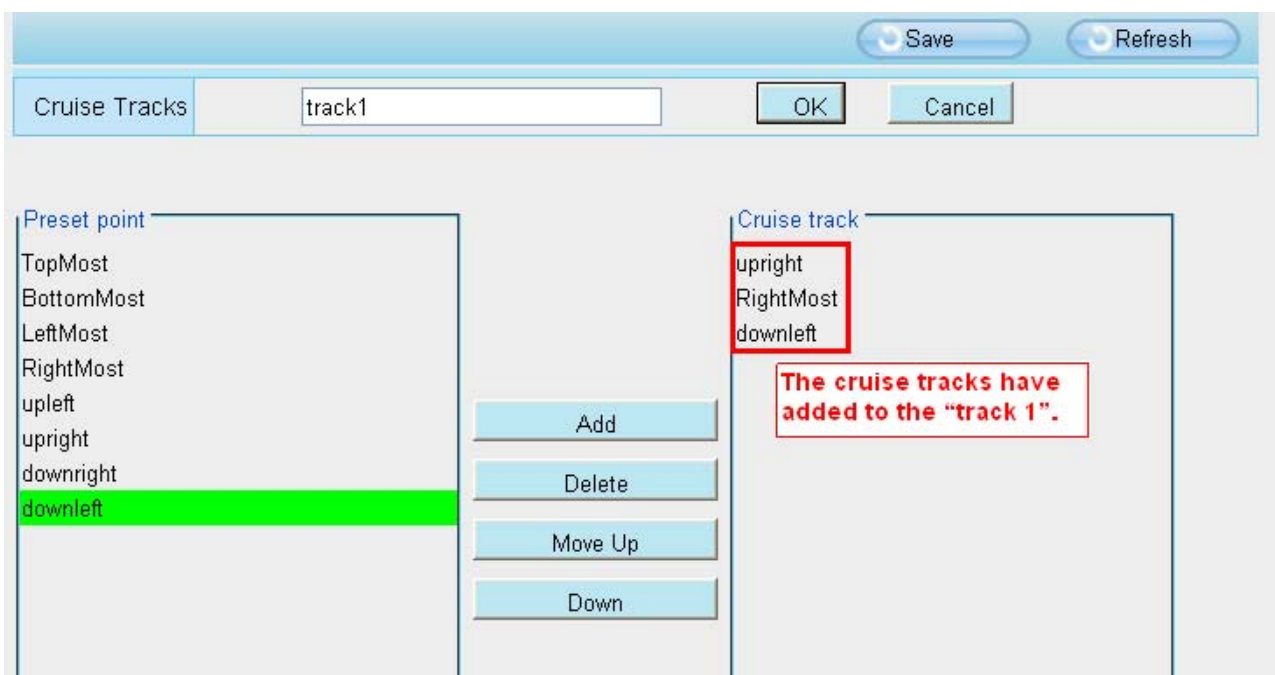

Figure 4.71

After add the cruise track, back to the surveillance window, click Cruise, here you can see all cruise tracks you have added.

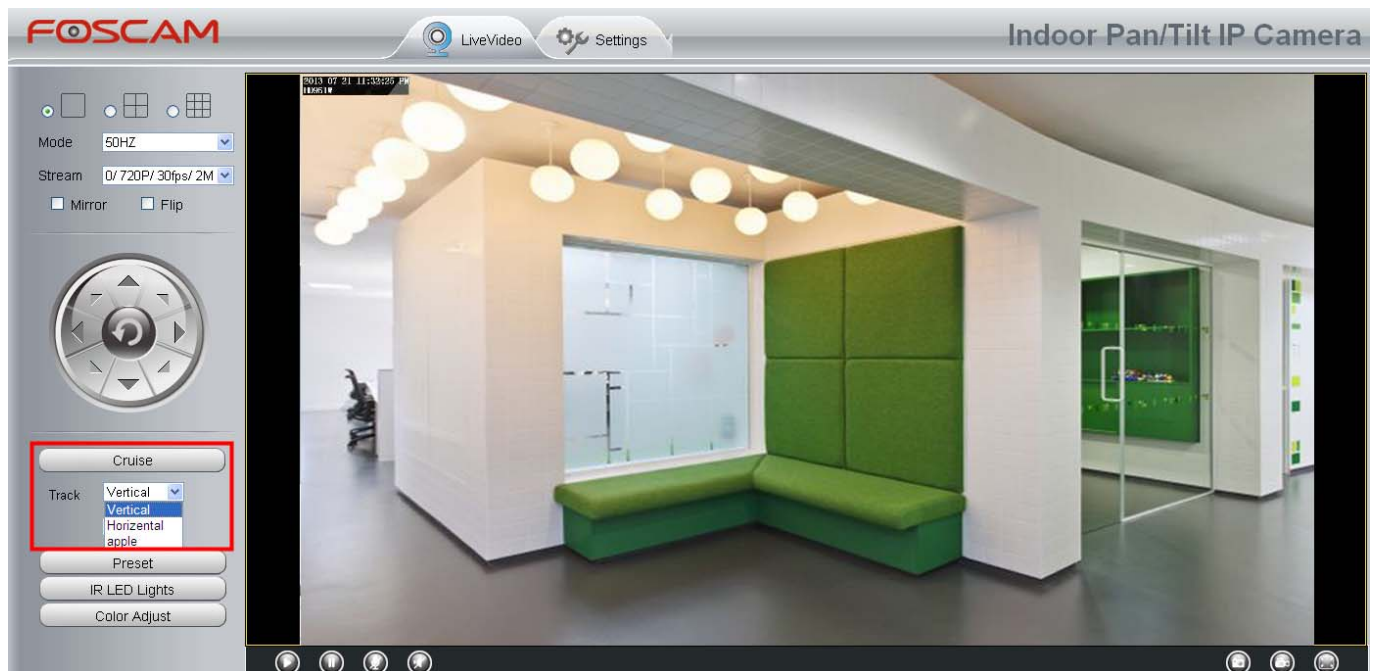

Figure 4.72

There are other buttons between the Preset points and Cruise track, you can use these buttons to adjust the order of preset points or add/delete one preset points in one cruise track,

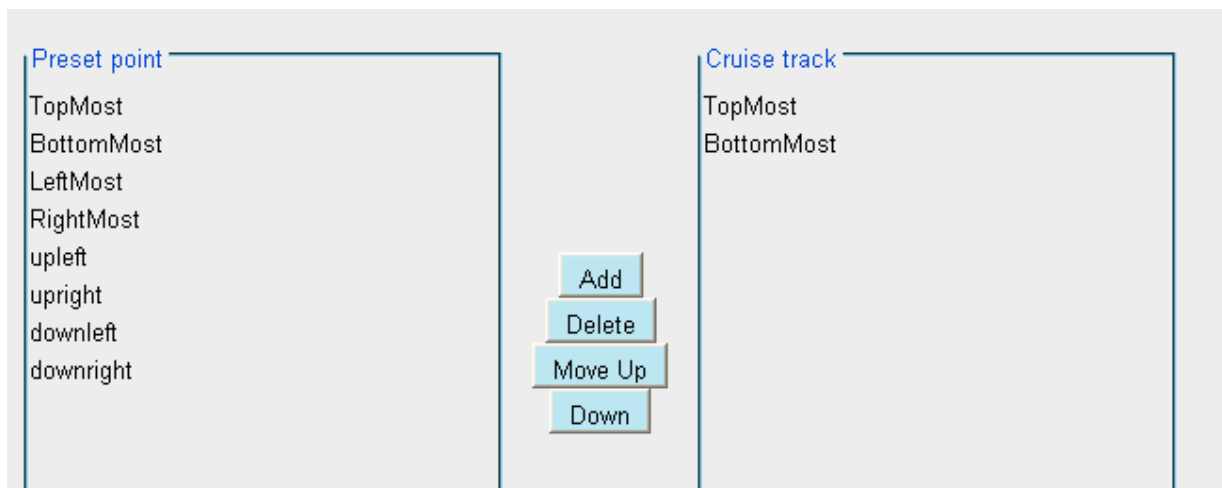

Figure 4.73

Add: Select one preset points and add it to the selected cruise track.

Delete: Select one preset points you have added to one cruise track, click delete.

Move up/ down: Select one cruise track, adjust the order of preset points in one cruise track.

Attention:

Considering the life time and thermal issue of the motor, it's not recommend to do long-time cruise.

4.7.3 Start-Up Options

Here section will allow you to set the stop position after the camera reboots.

It supports three modes: No self test, Goto home position and Goto preset point.

No self test: When rebooting, the camera will not pan / tilt.

Goto home position: When rebooting, the camera will pa Providing Central Management Software to manage or monitor multi-cameras n / tilt and stops at center.

Goto Preset point: Select one preset position and save it. When rebooting, the camera will pan/ tilt and stops at the preset position you have set.

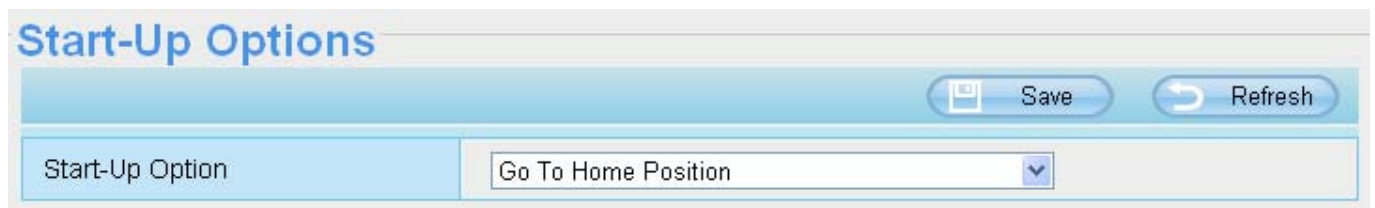

Figure 4.74

4.8 Firewall

This section explains how to control the access permission by checking the client PC's IP addresses. It is composed of the following columns: **Block access from these IP addresses** and **Only allow access from these IP addresses**.

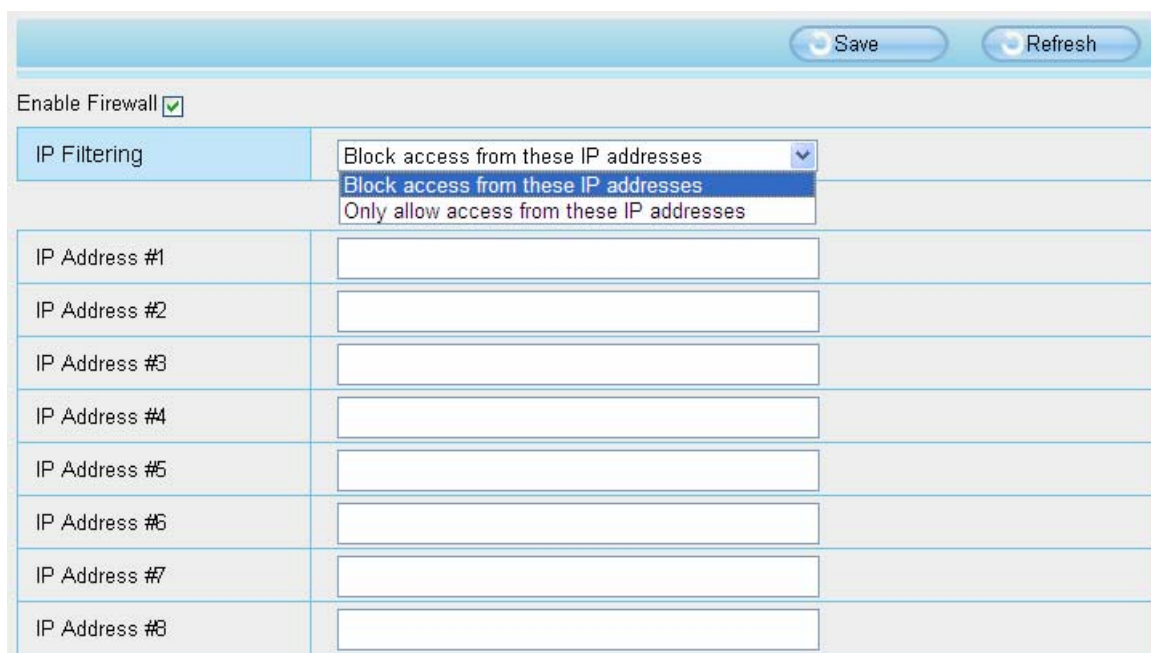

Figure 4.75

Enable firewall, If you select Only allow access from these IP addresses and fill in 8 IP addresses at most, only those clients whose IP addresses listed in the **Only allow access from these IP addresses** can access the Network Camera. If you select **Block access from these IP addresses**, only those clients whose IP addresses are in the IP list cannot access the Network Camera.

Click **Save** to take effect.

4.9 System

In this panel, you can backup/restore your camera settings, upgrade the firmware to the latest version, restore the camera to default settings and reboot the device.

4.9.1 Back-up& Restore

Click **Backup** to save all the parameters you have set. These parameters will be stored in a bin file for future use. Click Browse and select the parameters file you have stored, then click Submit to restore the restore the parameters.

Backup is used to save your current settings. It is recommended to backup your configuration before modifying or upgrading firmware.

Settings can be restored by uploading the backup file.

Path:

Note:

1. All current settings will be lost when importing a configuration file. If an incorrect file is loaded, the camera may stop working correctly.
2. Keep the power on during this process, or you may damage your camera. Your camera will reboot automatically once restoration is completed.

Figure 4.76

4.9.2 System Upgrade

Your current firmware version will be displayed on your screen. You may go to the **Status**→ **Device Information** Page to check for the latest firmware versions available.

Click **Browse**, choose the correct bin file and then click **System upgrade**.

Don't shut down the power during upgrade. After upgrading, you can see the upgrade result.

Upgrade Result

Figure 4.77

Upgrade Firmware by IP Camera Tool



Double click the IP Camera Tool shot icon, select the Camera IP that you want to upgrade the firmware. Then select Upgrade Firmware and enter the username and password, choose the firmware file, and upgrade.

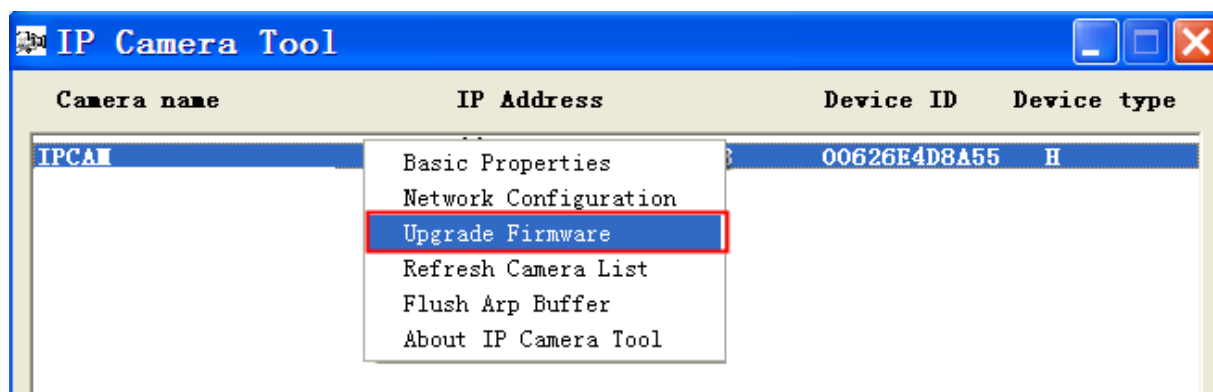

Figure 4.78

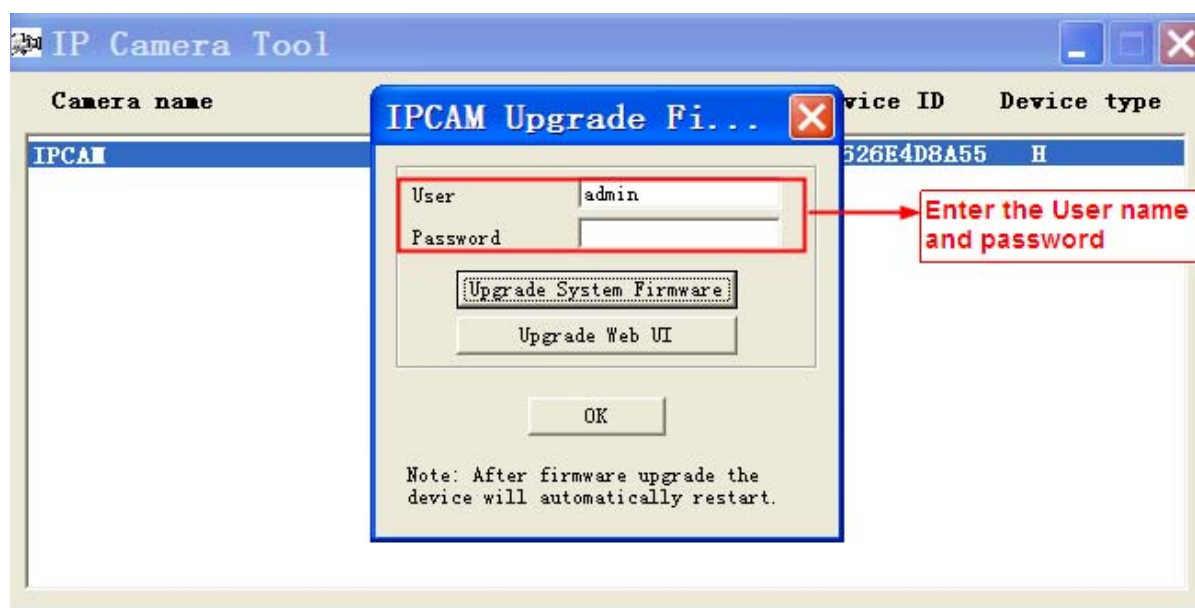

Figure 4.79

CAUTION: If your camera works well with the current firmware, we recommend not upgrading. Please don't upgrade the firmware unnecessarily. Your camera may be damaged if misconfigured during an upgrade.

NOTE:

Before upgrade the firmware, don't upgrade the firmware in WAN through the web UI, or else the upgrade process may be failed.

Please ensure you have download the correct firmware package for your camera before upgrading. Read the upgrade documentation (readme.txt file) in the upgrade package before you upgrade.

Upon downloading the firmware check the sizes of the .bin files. They must match the size in the readme.txt file. If not, please download the firmware again until the sizes are the same. Your camera will not function correctly if a corrupt .bin file is used.

Normally, only Device WEB UI need to be upgrade, please do not try to upgrade the Device System Firmware.

- 1) Never shut down the power of the camera during upgrade until the IP camera restart and get connected.
- 2) After upgrade successfully, please uninstall the old plugin and re-install it, then reset the camera to the default factory settings before using the camera.

Shenzhen Foscam Intelligent Technology Co., Limited

Tel: 86 755 2674 5668 Fax: 86 755 2674 5168

4.9.3 Factory Reset

Click All reset and all parameters will return to factory settings if selected. This is similar to press the Reset button on the bottom of the camera.

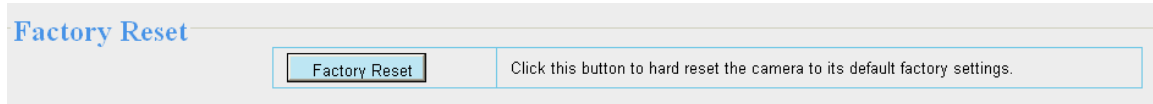

Figure 4.80

4.9.4 Reboot

Click Reboot System to reboot the camera. This is similar to unplugging the power to the camera.

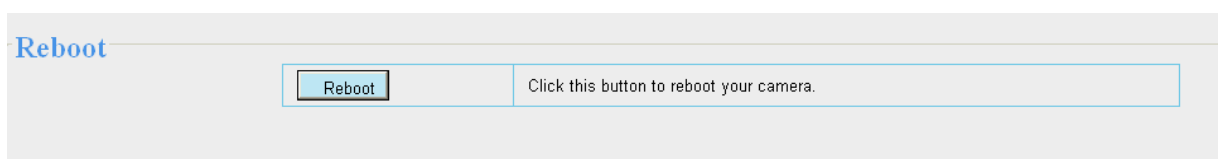

Figure 4.81

5 APPENDIX

5.1 Frequently Asked Questions

NOTE: Any questions you would meet, please check Network connections firstly. Check the working status revealed by the indicators on the network server, hub, exchange and network card. If abnormal, check the network connections.

5.1.1 How to download and install the ActiveX for Firefox users

For the first time login the camera, it may prompt you to download plugin.

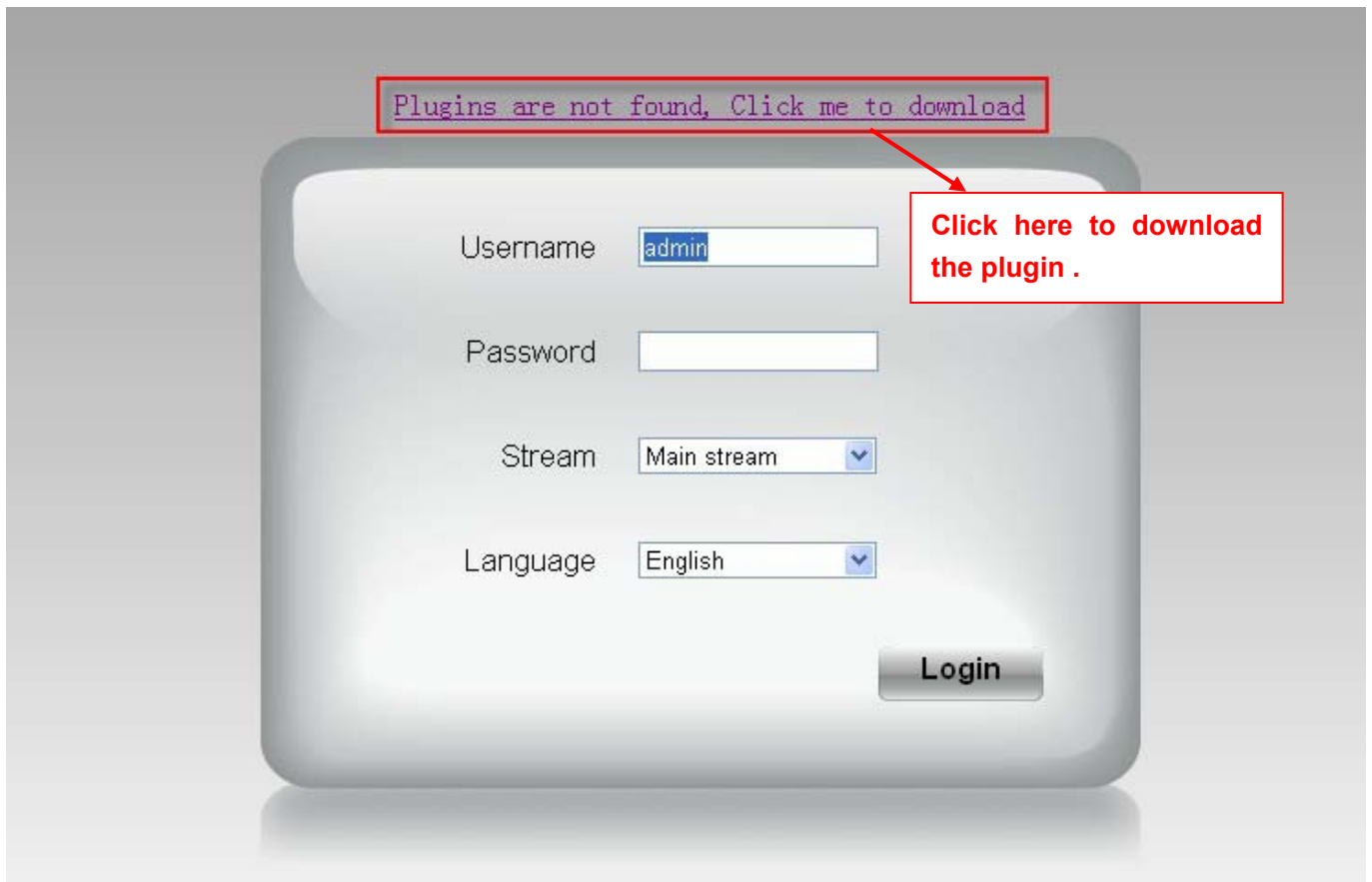

Figure 5.1

Drag the download file to Firefox web page and it will prompt you to Install it.

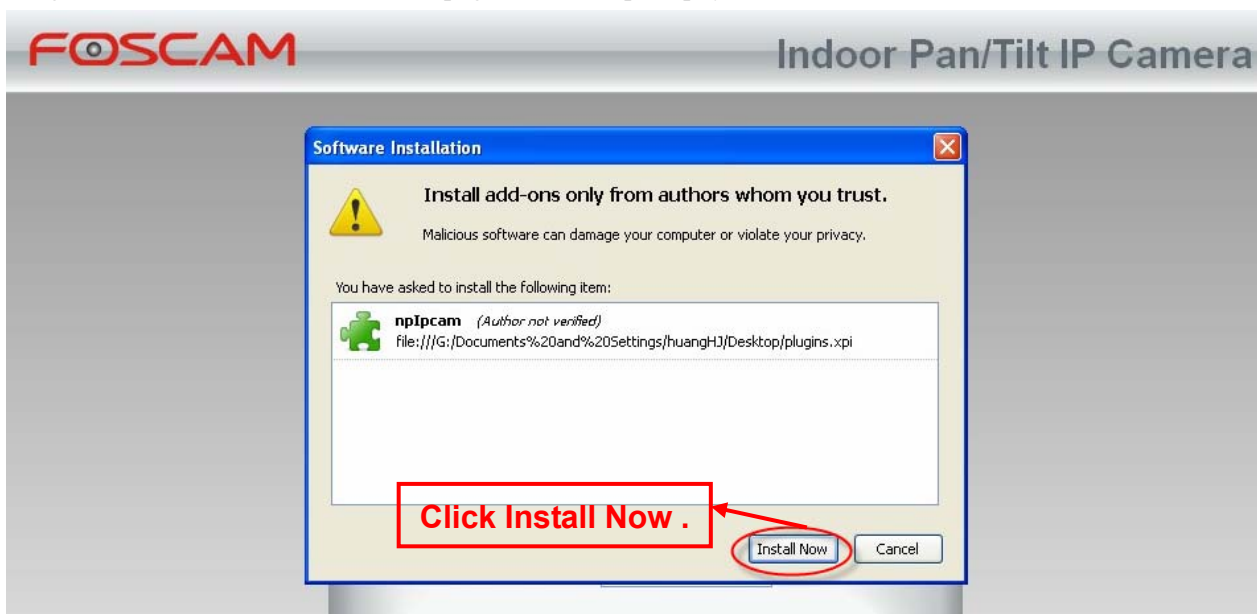

Figure 5.2

Reboot the Firefox after the plugin installation is successfully completely, then relogin the camera again, you can see the surveillance window



NOTE: If you could not view living video after running the ActiveX, only a red cross in the center of the video or just a black screen. Please change another port number to try.

Make sure all firewall or antivirus software on your computer does not block the active download and installation. If you are unable to run the ActiveX control, try shutting down the firewall or antivirus program.

5.1.2 How to download and install the ActiveX for Google Chrome users ?

For the first time login the camera, it will prompt you to download the ActiveX..



Figure 5.3

Download the plugin and drag it to the Extensions page of Google Chrome.

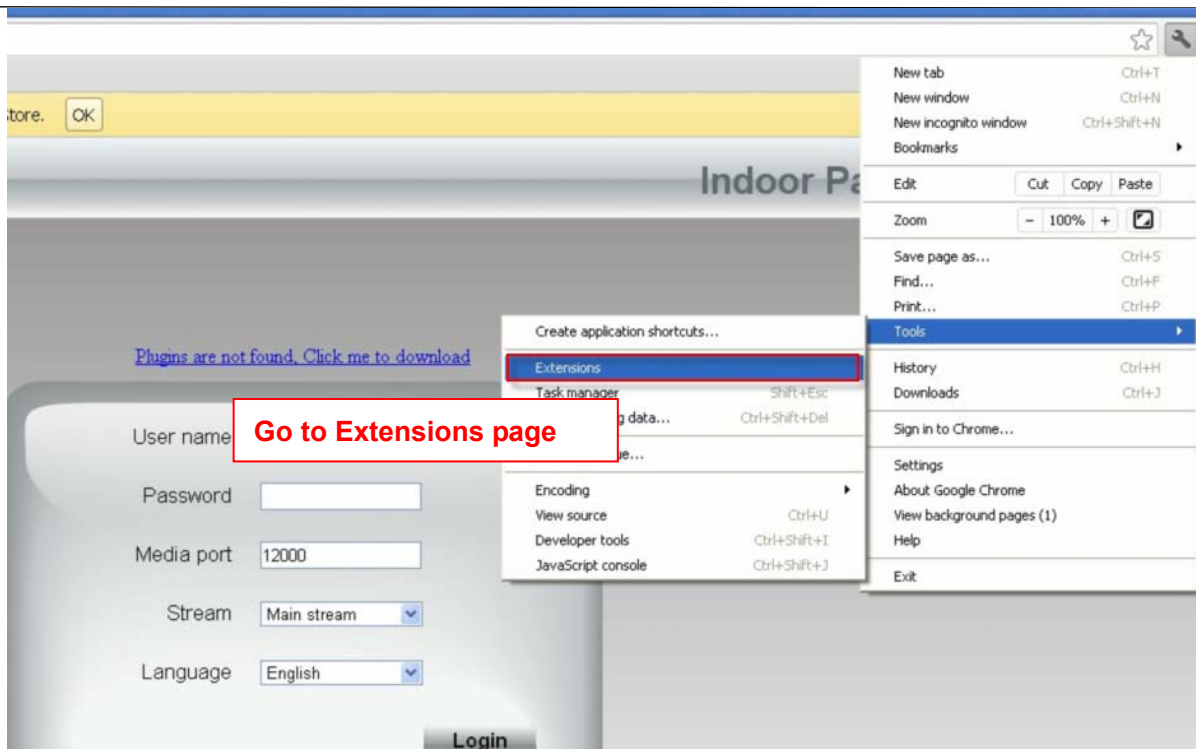

Figure 5.4

Click Add button to install the Plugins.

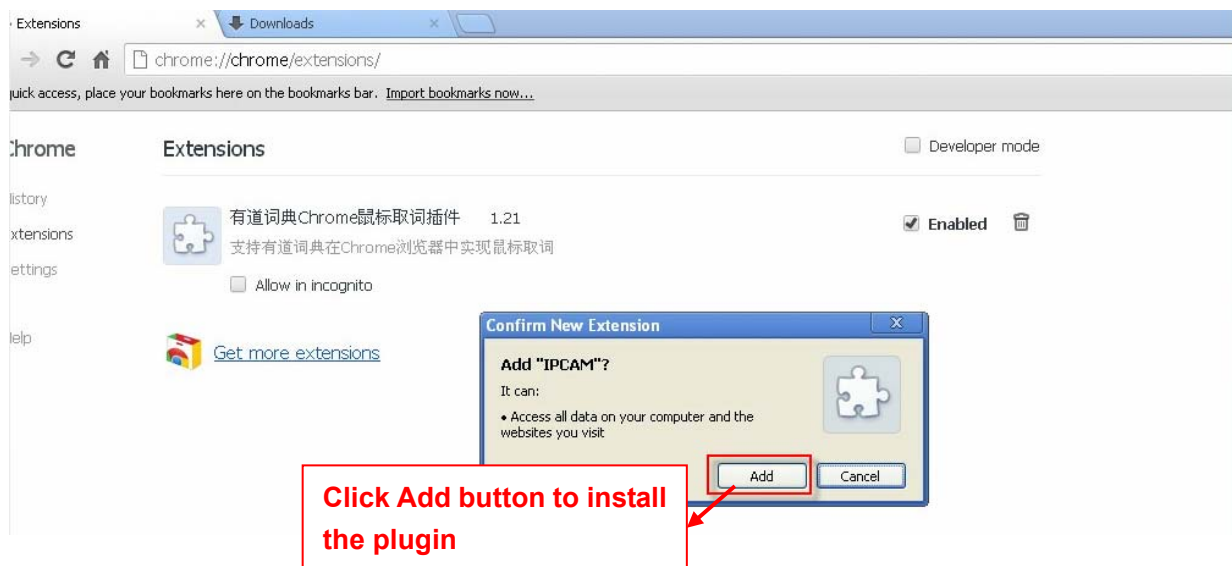

Figure 5.5

Reboot the browser and relogin the camera, you will see the surveillance window.

5.1.3 I have forgotten the administrator password

To reset the administrator username and password, press and hold down the RESET BUTTON for 5 seconds. Upon releasing the reset button, wait for 20 seconds, the camera will reboot and the username and password will return to the

Shenzhen Foscam Intelligent Technology Co., Limited

Tel: 86 755 2674 5668 Fax: 86 755 2674 5168

factory default administrator username and password. Please power on the camera before reset

Default administrator username: admin

Default administrator password: No password

5.1.4 Camera can not record when I click Record button or I can't change the manually record path

When you use Windows7 or Vista, you may be not able to do manually record or change the record path because of the security settings of computer.

There are two ways to resolve this problem:

Please add the camera as a trusted site to resolve this issue. The steps are :

IE browser→Tool→Internet Properties→Security→Trusted sites→Sites→Add

Open IE browser, then right click, select “Run as administrator”

5.1.5 Subnet doesn't match

Check whether your ipcamera in the same subnet of your computer. The step is **Control Panel→Network Connections→Dbclick Local Area Connections → Choose General→Properties**. Check subnet mask, IP address and gateways. When you set IP address please make sure they are in the same subnet. Otherwise you can't access camera.

5.1.6 No Pictures Problems

The video streaming is transmitted by the ActiveX controller. If ActiveX controller isn't installed correctly you will see no video image. You can resolve this problem by this way:

Download ActiveX controller and set the safety property of IE in the PC when you view it first time: IE browser→Tool→Internet Proper→Security→Custom Level→ActiveX control and Plug-ins. Three options of front should be set to be “Enable”, The ActiveX programs read by the computer will be stored. As follows:

Enable: Download unsigned ActiveX controls

Enable: Initialize and script ActiveX controls not marked as safe

Enable: Run ActiveX controls and plug-ins

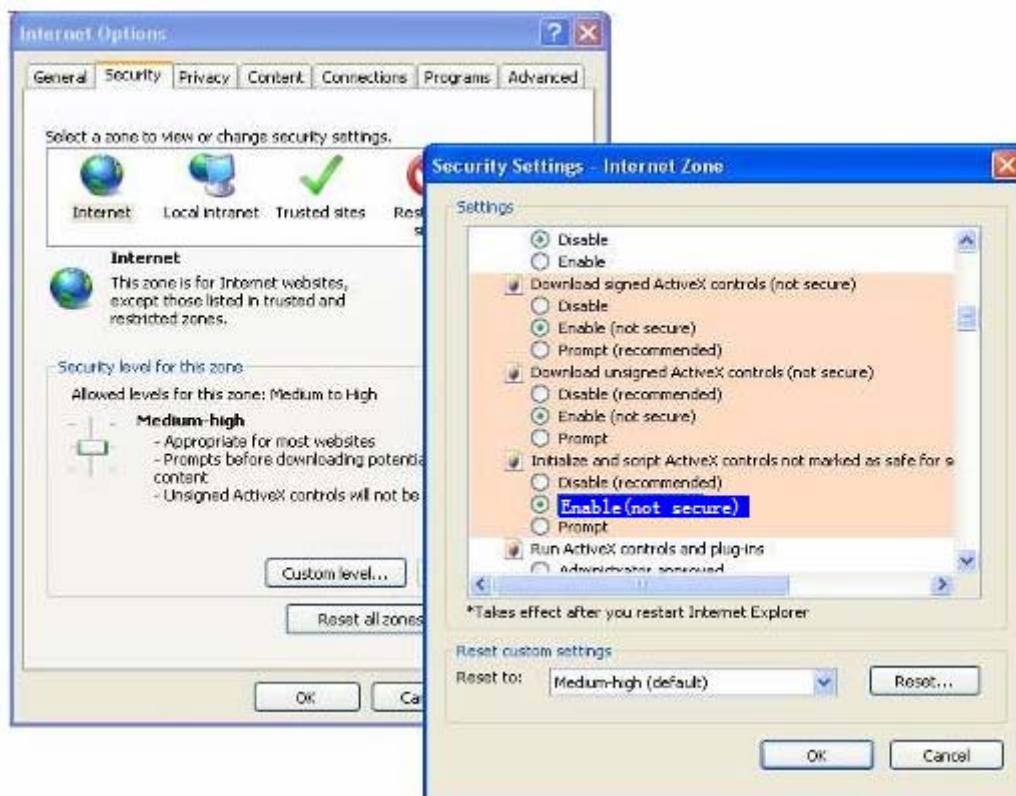

Figure 5.6

If you allow the ActiveX running, but still could not see living video. Please change another port number to try. Don't use port 88.

Save Refresh	
HTTP Port	88
HTTPS Port	443
ONVIF Port	888

Figure 5.7

NOTE: Make sure that your firewall or anti-virus software does not block the camera or ActiveX. If you could not see video, please shut down firewall or anti-virus software to try again.

5.1.7 Can't access IP camera in internet

There are some reasons:

- 1、ActiveX controller is not installed correctly
- 2、The port which camera used is blocked by Firewall or Anti-virus software. Please change another port number and try again. (Figure6.7)
- 3、Port forwarding is not successful (Figure4.30)

Check these settings and make sure they are correct.

5.1.8 UPnP always failed

UPnP only contains port forwarding in our recent software. Sometimes, it may be failed to do port forwarding automatically because of firewall or anti-virus software. It also has much relation with router's security settings. So we recommend you do port forwarding manually. You can view your camera in internet successfully after you do port forwarding manually in your router (Figure 4.30).

5.1.9 Camera can not connect wireless

If your camera could not connect wireless after you set wireless settings and plug out the cable. Please check whether your settings are correct or not.

Normally, camera can't connect wireless mainly because of wrong settings.

Make sure broadcast your SSID; use the same encryption for router and camera.

5.1.10 Can't see other cameras listed in multi-device when using remote access

If you want to view all the cameras via the WAN, verify that each camera added in the multi-device settings can be accessed by using the DDNS name and port number. Use the DDNS domain name not the camera's LAN IP. (For more details see: How to add cameras in WAN)

5.2 Default Parameters

Default network Parameters

IP address: obtain dynamically

Subnet mask: obtain dynamically

Gateway: obtain dynamically

DDNS: Embedded FOSCAM domain name

Username and password

Default admin username: admin with a blank password

5.3 Specifications

ITEMS		FI9818W V2
Image Sensor	Image Sensor	High Definition Color CMOS Sensor
	Display Resolution	1280 x 720 Pixels
	Lens	f: 2.8mm
	Mini. Illumination	0Lux
Lens	Lens Type	Glass Lens
	IR CUT	Filter will change automatically
	Image Compression	H.264
	Resolution	720p (1280 x 720), VGA (640 x 480)

Shenzhen Foscam Intelligent Technology Co., Limited

Tel: 86 755 2674 5668 Fax: 86 755 2674 5168

Video	Flip Mirror Images	Vertical / Horizontal
	Light Frequency	50Hz, 60Hz
	Video Parameters	Brightness, Contrast
Audio	Input	Built-in Microphone
	Output	Built-in Speaker, with a audio jack
	Audio Compression	H.264
Communication	Ethernet	One 10/100Mbps RJ-45
	Supported Protocol	HTTP,FTP,TCP/IP,UDP,SMTP,DHCP,PPPoE,DDNS,UPnP,GPRS,ON VIF
	Wireless Standard	IEEE 802.11b/g/n
	Data Rate	802.11b: 11Mbps(Max.) 802.11g: 54Mbps(Max.) 802.11n: 150Mbps(Max.)
	Wireless Security	WEP & WPA & WPA2 Encryption
	Infrared Light	11 IR LEDs, Night visibility up to 8 meters
	Dimension	110(L) *103(W) *126(H)mm
	Gross Weight	680g
	Net Weight	320g
Power	Power Supply	DC 5V/2.0A (EU,US,AU adapter or other types optional)
	Power Consumption	5Watts (Max.)
Environment	Operate Temper.	0° ~ 40°C (32°F ~ 104°F)
	Operating Humidity	20% ~ 85% non-condensing
	Storage Temper.	-10°C ~ 60° (14°F ~ 140°F)
	Storage Humidity	0% ~ 90% non-condensing
PC Requirements	CPU	2.0GHZ or above
	Memory Size	256MB or above
	Display Card	64M or above
	Supported OS	Microsoft Windows 2000/XP/Vista/Windows7-32bit/Windows7-64bit/Windows8- 32 bit/ Windows8-64bit/ mac
	Browser	IE 6.0, IE7.0, IE8.0,IE9.0, Firefox2.0,Firefox3.0, Google Chrome, Safari or other standard browsers
Certification	CE, FCC, RoHS	
Warranty	Limited 2-year warranty	

Attention: Power adapter should be used between 0°C-40°C, and 5%-90% relative humidity.

5.4 CE & FCC

Electromagnetic Compatibility (EMC)

FCC Statement

Any Changes or modifications not expressly approved by the party responsible for compliance could void the user's authority to operate the equipment.

This device complies with part 15 of the FCC Rules. Operation is subject to the following two conditions: (1) This device may not cause harmful interference, and (2) this device must accept any interference received, including interference that may cause undesired operation.

IMPORTANT NOTE:

Note: This equipment has been tested and found to comply with the limits for a Class B digital device, pursuant to part 15 of the FCC Rules. These limits are designed to provide reasonable protection against harmful interference in a residential installation. This equipment generates, uses and can radiate radio frequency energy and, if not installed and used in accordance with the instructions, may cause harmful interference to radio communications. However, there is no guarantee that interference will not occur in a particular installation. If this equipment does cause harmful interference to radio or television reception, which can be determined by turning the equipment off and on, the user is encouraged to try to correct the interference by one or more of the following measures:

- Reorient or relocate the receiving antenna.
- Increase the separation between the equipment and receiver.
- Connect the equipment into an outlet on a circuit different from that to which the receiver is connected.
- Consult the dealer or an experienced radio/TV technician for help.

FCC Radiation Exposure Statement:

This equipment complies with FCC radiation exposure limits set forth for an uncontrolled environment. This equipment should be installed and operated with minimum distance 20cm between the radiator & your body. This transmitter must not be co-located or operating in conjunction with any other antenna or transmitter.

CE Mark Warning



This is a Class B product. In a domestic environment, this product may cause radio interference, in which case the user may be required to take adequate measures.

5.5 WARRANTY

ShenZhen FOSCAM Intelligent Technology Limited. ("FOSCAM") values your business and always attempts to provide you the very best of service.

No limited hardware warranty is provided by FOSCAM unless your FOSCAM product ("product") was purchased from an authorized distributor or authorized reseller. Distributors may sell products to resellers who then sell products to end users. No warranty service is provided unless the product is returned to an authorized return center in the region where the product was first shipped by FOSCAM or to the point-of-purchase, which may have regional specific warranty implications.

If you purchase your FOSCAM product from online store, please contact the point-of-purchase and ask for return/replacement/repair service.

Hardware Warranty Information

FOSCAM provide 2-year limited warranty for naked product and 6-month limited warranty for accessories.

Limited Hardware Warranty

- FOSCAM products are warranted to be free from manufacturing defects in materials and workmanship starting from the shipping date of FOSCAM.

This limited hardware warranty does not cover:

- Software, including the software added to the products through our factory-integration system, software that included in the CD,etc.
- Usage that is not in accordance with product instructions.
- Failure to follow the product instructions.
- **Abuse firmware upgrade without the authorized technician's guidance.**
- **Normal wear and tear.**

Return Procedures

- Please read FOSCAM warranty policy & policy of your reseller first before sending items back to point-of-purchase.
- Customer must first contact point-of-purchase to obtain a Return Merchandise Authorization (RMA) number before returning the product. If the product you received is suspected to be defective and the product warranty has not expired, The RMA number will allow your reseller to track your return much easier and help them expedite processing your request.
- After receiving your RMA case number, pack the item(s) very well with the original box and all the original accessories included such as power adapters, brackets, cables, manuals, and driver CD disks.
- Write your RMA number and the return reason (the problem of the product) on the warranty card along with the complete package to send them back.

Replacement Services

- **If customers ask for replacement service, please contact point-of-purchase and follow their policy.**
- Our technicians will inspect all items returned for replacement requests. If the returned product is found in working order, we will return the same item received. However customers shall be responsible for all shipping & handling charges incurred for getting the units back to customers.
- If returned products are found defective, we will replace the product and assume the shipping cost for sending back the replacement unit to customers.
- If for any reason, we are unable to provide a replacement of the original returned item(s). You will have a choice for a "Substitute" item at the same equal value.
- We do not provide exchange and replacement due to normal hardware upgrade according the market after 14 days after the product is delivered.
- Our technicians will test the product before send out the replacement, any other demand for more than two times replacement for the same product during replacement limit will be rejected.
- **Replaced products are warranted from the balance of the former warranty period.**

Warranty Forfeiture

-
- Warranty is void if purchase from unauthorized distributor or reseller.
 - Warranty is void if trade-mark, serial tags, product stickers have been removed, altered or tampered with.
 - Warranty is void for mishandling, improper use, or defacing the product.
 - **Abuse firmware upgrade without the authorized technician's guidance.**
 - Warranty is void for physical damage, altered, either internally or externally, improper or inadequate packaging when returned for RMA purposes.
 - Warranty is void if damage has resulted from accident, dismantle, abuse, or service or modification by someone other than the appointed vendor, source, fission or the spare part has been over the period of warranty.
 - Warranty is void if product is damaged due to improper working environment or operation. (For example, improper temperature, humidity, unusual physical or electrical stress or interference, failure or fluctuation of electrical power, static electricity, using wrong power adapter, etc.)
 - Warranty is void if damaged by the use of parts not manufactured or sold by FOSCAM.
 - Damage caused by improper installation of third-party products.
 - Warranty is void if damaged for irresistible cause, such as earthquake, fire, lightning, flood, etc.
 - Product beyond limited warranty.

Shipping Fee

- If products are defective or damaged under normal use or operation in the replacement limit, distributors or resellers are responsible for the shipping cost the product back to customers, customers should assume the shipping cost send the product to the point-of-purchase.
- During replacement limit, if customers ask for replacement due to the product does not fit for customer's personal expectation, customers should responsible for both shipping fee.
- Customers shall be responsible for both shipping fee if their product beyond the replacement limit but still in warranty limit.

Repair Service Out Of Warranty

- FOSCAM provide extra repair service for product that out of warranty, it is chargeable. The total fee contains device cost and service fee. Device cost (including accessories) is the standard uniform price provide by FOSCAM.
- Different region may have different service fee, please contact the point-of-purchase to confirm that before you ask for this service.
- Our technicians will quote the total price after detect the product, If customers refused to repair after the quotation, customers need pay for the test fee, \$3.5/hour. If agree with the quotation, test will be free.
- Repaired product out of warranty will obtains 3-month warranty from the date of the product back to customers.

Limitation of Liability

- FOSCAM is not responsible for other extra warranty or commitment promised by resellers, if your reseller promised some extra commitment or warranty; please ask for written documents to protect your rights and interests.
- FOSCAM does not offer refunds under any circumstances. Please contact the point-of-purchase and follow their refund/return policy.
- FOSCAM shall not be liable under any circumstances for any consequential, incidental, special or exemplary damages arising out of or in any connection with this agreement or the products, including but not limited to lost profits, or any claim based on indemnity or contribution, or the failure of any limited or exclusive remedy to

achieve its essential purpose or otherwise. Purchaser's exclusive remedy, as against FOSCAM, shall be the repair or replacement of defective parts. If FOSCAM lists a product on its website specification in error or that is no longer available for any reason, FOSCAM reserves the right to explain it without incurring any liability.

All rights reserved. FOSCAM and the FOSCAM logo are trademarks of ShenZhen FOSCAM Intelligent Technology Limited., registered in the U.S. and other countries.

6 OBTAINING TECHNICAL SUPPORT

While we hope your experience with the IPCAM network camera is enjoyable and easy to use, you may experience some issues or have questions that this User's Guide has not answered.

If you have problem with FOSCAM IP camera, please first contact FOSCAM reseller for solving the problems. If our reseller cannot provide service, please contact our service department: tech@foscam.com