

# FCC Part 15C

## Measurement And Test Report For

### Shenzhen Smart-eye Digital Electronics Co., Ltd

#6 Northern Zone, Shangxue S&T City, Bantian, Longgang District, Shenzhen, China

**FCC ID: ZCBHYIPC-551MW**

July 26, 2013

<b>This Report Concerns:</b> <input checked="" type="checkbox"/> Original Report	<b>Equipment Type:</b> IP CAMERA
<b>Report Number:</b>	MTI130702001RF
<b>Test Engineer:</b>	Bill Chen <i>Bill Chen</i>
<b>Reviewed By:</b>	Jason Zheng <i>Jason zheng</i>
<b>Approved &amp; Authorized By:</b>	Hebe Lee <i>Hebe Lee</i>
<b>Test Date:</b>	July 15- July 25,2013
<b>Prepared By:</b>	<b>Shenzhen Microtest Technology Co.,Ltd</b> 6F, Zhongbao Building, Gushu, Bao' an District, Shenzhen, P.R.China Tel: +86-755-8885 0135 Fax: +86-755-8885 0136



**Note:** This test report is limited to the above client company and the product model only. It may not be duplicated without prior written consent of Shenzhen Microtest Technology Co.,Ltd.

# TABLE OF CONTENTS

<b>1. GENERAL INFORMATION.....</b>	<b>4</b>
1.1 PRODUCT DESCRIPTION FOR EQUIPMENT UNDER TEST (EUT) .....	4
1.2 RELATED SUBMITTAL(S) / GRANT (S).....	5
1.3 TEST METHODOLOGY .....	5
1.4 TEST FACILITY .....	5
1.5 TEST FACILITY .....	5
<b>2. SYSTEM TEST CONFIGURATION .....</b>	<b>6</b>
2.1 EUT CONFIGURATION .....	6
2.2 EUT EXERCISE.....	6
2.3 GENERAL TEST PROCEDURES.....	6
2.4 LIST OF MEASURING EQUIPMENTS USED .....	7
2.5 TEST CONDUCTION .....	7
2.6 TEST PERIPHERAL INFORMATION .....	8
<b>3. SUMMARY OF TEST RESULTS .....</b>	<b>8</b>
<b>4. ANTENNA REQUIREMENT .....</b>	<b>9</b>
4.1 STANDARD APPLICABLE .....	9
4.2 ANTENNA CONNECTED CONSTRUCTION.....	9
<b>5. CONDUCTED EMISSION MEASUREMENT.....</b>	<b>10</b>
5.1 LIMITS OF CONDUCTED EMISSION .....	10
5.2 TEST SETUP DIAGRAM.....	10
5.3 INSTRUMENT SETTING .....	10
5.4 TEST EQUIPMENT LIST AND DETAILS .....	11
5.5 TEST PROCEDURE .....	11
5.6 TEST RESULT .....	11
<b>6. 6DB BANDWIDTH MEASUREMENT.....</b>	<b>14</b>
6.1 LIMITS OF 6dB BANDWIDTH MEASUREMENT .....	14
6.2 EUT SETUP .....	14
6.3 TEST EQUIPMENT LIST AND DETAILS .....	14
6.4 TEST PROCEDURE .....	14
6.5 TEST RESULT .....	14
<b>7. MAXIMUM PEAK OUTPUT POWER.....</b>	<b>21</b>
7.1 LIMITS OF MAXIMUM PEAK OUTPUT POWER MEASUREMENT .....	21
7.2 EUT SETUP .....	21
7.3 TEST EQUIPMENT LIST AND DETAILS .....	21
7.4 TEST PROCEDURE .....	21
7.5 TEST RESULT .....	21
<b>8. POWER SPECTRAL DENSITY MEASUREMENT.....</b>	<b>23</b>
8.1 LIMITS OF POWER SPECTRAL DENSITY MEASUREMENT .....	23
8.2 EUT SETUP .....	23
8.3 TEST EQUIPMENT LIST AND DETAILS .....	23
8.4 TEST PROCEDURE .....	23
8.5 TEST RESULT .....	23
<b>HIGH CHANNEL .....</b>	<b>27</b>
<b>9. BAND EDGES MEASUREMENT .....</b>	<b>31</b>
9.1 LIMITS OF BAND EDGES MEASUREMENT .....	31
9.2 TEST EQUIPMENT LIST AND DETAILS .....	31
9.3 TEST PROCEDURE .....	31
9.4 TEST RESULT .....	31
<b>10. RADIATED EMISSION MEASUREMENT .....</b>	<b>48</b>
10.1 LIMITS OF RADIATED EMISSION MEASUREMENT .....	48

10.2 EUT SETUP .....	48
10.3 TEST EQUIPMENT LIST AND DETAILS .....	48
10.4 TEST PROCEDURE .....	49
10.5 TEST RESULT .....	49

# 1. GENERAL INFORMATION

## 1.1 Product Description for Equipment Under Test (EUT)

Applicant:	Shenzhen Smart-eye Digital Electronics Co., Ltd
Address of applicant:	#6 Northern Zone, Shangxue S&T City, Bantian, Longgang District, Shenzhen, China
Manufacturer:	Shenzhen Smart-eye Digital Electronics Co., Ltd
Address of manufacturer:	#6 Northern Zone, Shangxue S&T City, Bantian, Longgang District, Shenzhen, China
Equipment Under Test:	IP CAMERA
Tested Model No.:	551MW
Supplementary Models No.:	HD2, 8551MW, 6621W, 551MD01, 621W, 621KW, 621KD01 Remark: supplementary models are only different in exterior with tested Model and with the same circuit construction
Trade Name:	N/A
Type of Modulation:	IEEE 802.11b: DSSS(CCK,DQPSK,DBPSK) IEEE 802.11g: OFDM(64QAM, 16QAM, QPSK, BPSK) IEEE 802.11n :OFDM(64QAM, 16QAM, QPSK, BPSK)
Frequency Band:	2412~2462 MHz for 802.11b/g, 802.11n/HT20; 2422-2452MHz for 802.11n/HT40
Number of Channels:	11 for 802.11b/g, 802.11n/HT20; 7 for 802.11n/HT40
Channel Separation:	5MHz
Peak Output Power:	7.94 dBm For IEEE 802.11 b,g,n/HT20 6.35 dBm For IEEE 802.11 n/HT40
Tune-up info:	7±2 dBm For IEEE 802.11 b,g,n/HT20 7±1 dBm For IEEE 802.11 n/HT40
Power Supply:	DC 5V Form adapter with 120V/60Hz
Adapter:	Manufacturer: shenzhen jiyuanxing electronics co.,ltd Model: SW-050150

Remark: \* *The test data gathered are from the production sample provided by the manufacturer.*

## **1.2 Related Submittal(s) / Grant (s)**

This submittal(s) is a test report based on the Electromagnetic Interference (EMI) tests performed on the EUT. The EMI measurements were performed according to the measurement procedure described in ANSI C63.4 - 2003.

The tests were performed in order to determine compliance with FCC Part 15, Subpart C, and section 15.203, 15.207, and 15.247 rules.

## **1.3 Test Methodology**

Both conducted and radiated testing were performed according to the procedures in ANSI C63.4 - 2003, American National Standard for Methods of Measurement of Radio-Noise Emissions from Low-Voltage Electrical and Electronic Equipment in the range of 9 kHz to 40 GHz. Radiated testing was performed at an antenna to EUT distance 3 meters.

## **1.4 Test Facility**

All measurement required was performed at laboratory of NTEK Testing Technology Co., Ltd., at 1/F, Building E, Fenda Science Park Sanwei Community, Xixiang Street, Baoan District , Shenzhen,Guangdong

## **1.5 Test Facility**

The test facility is recognized, certified, or accredited by the following organizations:

### **FCC – Registration No.: 238937**

NTEK Testing Technology Co., Ltd. EMC Laboratory has been registered and fully described in a report filed with the (FCC) Federal Communications Commission. The acceptance letter from the FCC is maintained in our files. Registration 238937.

The facility also complies with the radiated and AC line conducted test site criteria set forth in CISPR 16-1: 2002, CISPR16-2: 2002.

## **2. SYSTEM TEST CONFIGURATION**

The tests documented in this report were performed in accordance with ANSI C63.4-2003 and FCC CFR 47 Part 15 Subpart C.

### **2.1 EUT Configuration**

The EUT configuration for testing is installed on RF field strength measurement to meet the Commissions requirement and operating in a manner that intends to maximize its emission characteristics in a continuous normal application.

### **2.2 EUT Exercise**

The calibrated antennas used to sample the radiated field strength are mounted on a non-conductive, motorized antenna mast 3 or 10 meters from the leading edge of the turntable.

### **2.3 General Test Procedures**

**Conducted Emissions** The EUT is placed on the turntable, which is 0.8 m above ground plane. According to the requirements in Section 7.1 of ANSI C63.4-2003. Conducted emissions from the EUT measured in the frequency range between 0.15 MHz and 30MHz using CISPR Quasi-Peak detector mode.

**Radiated Emissions** The EUT is a placed on as turntable, which is 0.8 m above ground plane. The turntable shall rotate 360 degrees to determine the position of maximum emission level. EUT is set 3m away from the receiving antenna, which varied from 1m to 4m to find out the highest emission. And also, each emission was to be maximized by changing the polarization of receiving antenna both horizontal and vertical. In order to find out the maximum emissions, exploratory radiated emission measurements were made according to the requirements in Section 13.1.4.1 of ANSI C63.4-2003.

Test Procedure with KDB558074 v03 for DTS submission.

## 2.4 List of Measuring Equipments Used

Items	Equipment	Manufacturer	Model No.	Serial No.	Last Cal	Calibration Period
1	EMI Test Receiver	ROHDE & SCHWARZ	ESI 26	100079	2012/11/18	1 year
2	Horn Antenna	TESEQ	BHA 9118	9118698	2013/02/11	1 year
3	Loop Antenna	COM Power	AL-130	UBTL0031	2013/02/11	1 year
4	3m Semi- Anechoic Chamber	ETS	N/A	N/A	2012/09/05	1 year
5	EMI Test Receiver	ROHDE & SCHWARZ	ESCS30	100038	2012/11/18	1 year
6	EMI Test Receiver	ROHDE & SCHWARZ	ESI 26	100009	2012/11/18	1 year
7	Receiver/ Spectrum Analyzer	ROHDE & SCHWARZ	ESCI	100106	2013/02/07	1 year
8	Spectrum Analyzer	Agilent	E7405A	US41160415	2012/11/18	1 year
9	Artificial Mains	ROHDE & SCHWARZ	ESH2-Z5	100028	2012/11/18	1 year
10	Pulse Limiter	ROHDE & SCHWARZ	ESHSZ2	100044	2012/11/18	1 year
11	LISN	COM Power	LI-200	12212	2012/11/18	1 year
12	LISN	COM Power	LI-200	12019	2012/11/18	1 year
13	3m/5m Semi- Anechoic Chamber	ETS	N/A	N/A	2012/09/05	1 year
14	Ultra-Broadband Antenna	R/S	HL562	100015	2013/02/11	1 year
15	Horn Antenna	OCEAN MICROWAVE	OBH20265	OC134039	2013/02/11	1 year
16	RF Test Panel	R/S	TS / RSP	335015/ 0017	N/A	N/A
17	Turntable	ETS	2088	2149	N/A	N/A
18	Antenna Mast	ETS	2075	2346	N/A	N/A
19	Power Meter	R&S	NRVS	100696	2012/11/18	1 year
20	Power Sensor (Peak)	R&S	NRV-Z31	0396.0101.19	2012/11/18	1 year

## 2.5 Test conduction

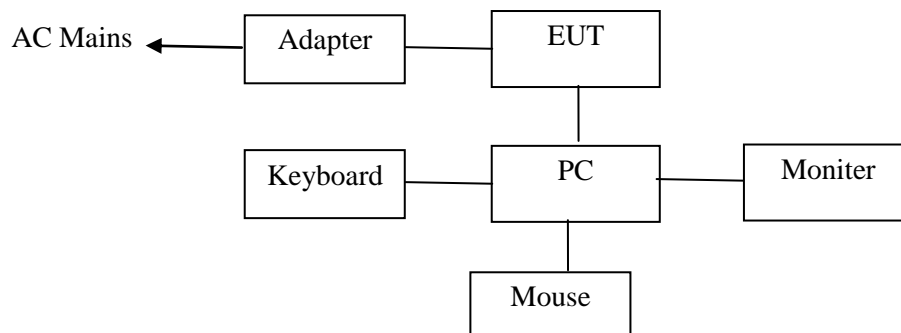

### 2.6 Test Peripheral Information

Items	Equipment	Manufacturer	Model No.
1	PC	Dell	ASPIRE M1830
2	Monitor	Dell	G205HV
3	USB Keyboard	Dell	SK-9625
4	USB Mouse	Dell	MS.11200.014
5	/	/	/
6	/	/	/

### 3. SUMMARY OF TEST RESULTS

FCC Rules	Description of Test	Result
15.203/15.247(b)/(c)	Antenna Requirement	Pass
15.207	AC Power Line Conducted Emission	Pass
15.247(a)(2)	Spectrum Bandwidth of a Direct Sequence Spread Spectrum System	Pass
15.247(e)	Power Spectral Density	Pass
15.247(b)(1)	Maximum Peak Output Power	Pass
15.247(d)	Band Edges Emission	Pass
15.247(d)	Radiated Emission	Pass

Note: The EUT has been tested as an independent unit. And Continual, Transmitting in maximum power (The adapter be used during Test )



## **4. ANTENNA REQUIREMENT**

### **4.1 Standard Applicable**

Section 15.203:

An intentional radiator shall be designed to ensure that no antenna other than that furnished by the responsible party shall be used with the device. The use of a permanently attached antenna or of an antenna that uses a unique coupling to the intentional radiator shall be considered sufficient to comply with the provisions of this Section. The manufacturer may design the unit so that a broken antenna can be replaced by the user, but the use of a standard antenna jack or electrical connector is prohibited.

Section 15.247(b)/(c):

If transmitting antennas of directional gain greater than 6 dBi are used, the peak output power from the intentional radiator shall be reduced by the amount in dB that the directional gain of the antenna exceeds 6 dBi.

If the intentional radiator is used exclusively for fixed, point-to-point operations may employ transmitting antennas with directional gain greater than 6 dBi provided the maximum peak output power of the intentional radiator is reduced by 1 dB for every 3 dB that the directional gain of the antenna exceeds 6 dBi.

### **4.2 Antenna Connected Construction**

This product has a integral antenna, The maximum Gain of the antenna is 2dBi.  
fulfill the requirement of this section.

## 5. CONDUCTED EMISSION Measurement

### 5.1 Limits of Conducted Emission

Section 15.207: For a Low-power Radio-frequency Device is designed to be connected to the AC power line, the radio frequency voltage that is conducted back onto the AC power line on any frequency or frequencies within the band 150 kHz to 30 MHz shall not exceed below limits table.

Frequency Range (MHz)	Limits ( dBuV)	
	Quasi-Peak	Average
0.150~0.500	66~56	56~46
0.500~5.000	56	46
5.000~30.00	60	50

### 5.2 Test Setup Diagram

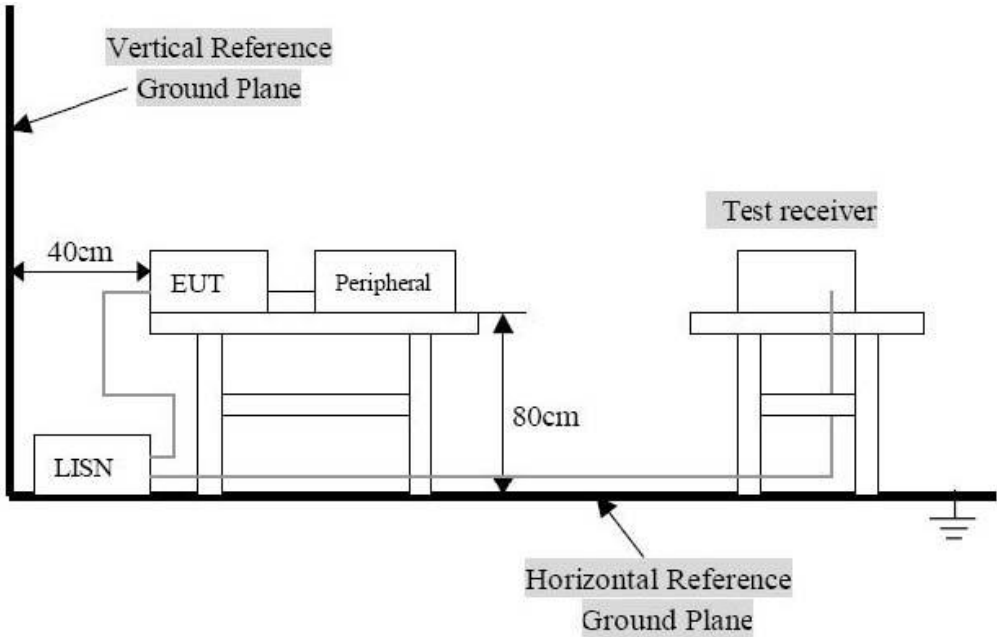

### 5.3 Instrument Setting

The test receiver was set with the following configurations:

Test Receiver Setting:

Frequency Range.....150 KHz to 30 MHz  
 Detector.....Peak & Quasi-Peak & Average  
 Sweep Speed.....Auto  
 IF Band Width.....9 KHz

## 5.4 Test Equipment List and Details

See section 2.4 of this report.

## 5.5 Test Procedure

1. Configure the EUT according to ANSI C63.4.
2. The EUT has to be placed 0.4 meter far from the conducting wall of the shielding room and at least 80 centimeters from any other grounded conducting surface.
3. Connect EUT to the power mains through a line impedance stabilization network (LISN)
4. All the support units are connected to the other LISN. The LISN should provide 50uH/50ohms coupling impedance.
5. The frequency range from 150 KHz to 30 MHz was searched.
6. Use the Channel & Power Controlling software to make the EUT working on selected channel and expected output power, then use the "H" Patter Generator software to make the supporting equipments stay on working condition.
7. Set the test-receiver system to Peak Detect Function and Specified Bandwidth with Maximum Hold Mode.
8. The measurement has to be done between each power line and ground at the power terminal for each RF channel. Only one RF channel has to be investigated since this test is independent with the RF channel selection.

## 5.6 Test Result

**Pass.**

Detailed information please refers to the following page.

EUT: IP CAMERA  
M/N: 553MW  
Operator: Amy  
Test Specification: L  
Test Mode: Link mode

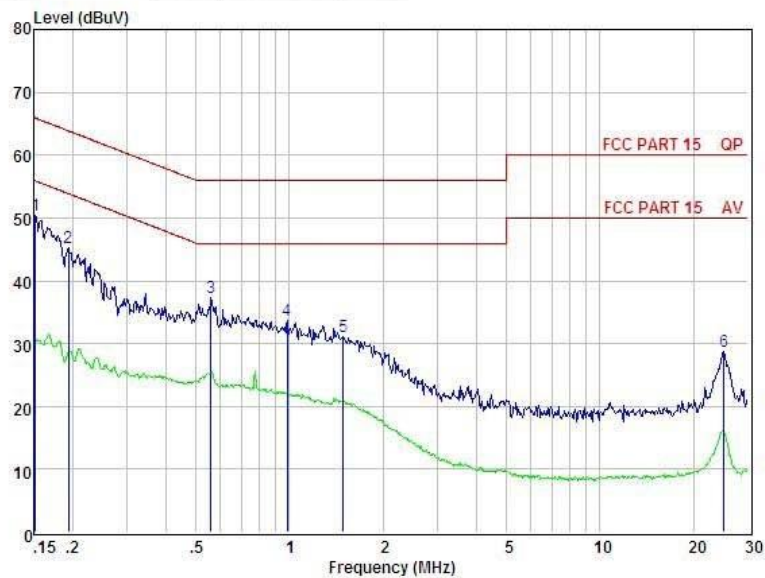

Condition : FCC PART 15 QP POL: LINE Temp:24 °C Hum:56 %

Item	Freq MHz	Read dBuV	LISN Factor dB	Preamp Factor dB	Cable Loss dB	Level dBuV	Limit dBuV	Margin dBuV	Remark
1	0.152	40.60	0.03	-9.72	0.10	50.45	65.91	-15.46	QP
2	0.194	35.33	0.03	-9.72	0.10	45.18	63.84	-18.66	QP
3	0.558	27.50	0.03	-9.72	0.10	37.35	56.00	-18.65	QP
4	0.984	23.84	0.04	-9.71	0.10	33.69	56.00	-22.31	QP
5	1.487	21.20	0.05	-9.71	0.10	31.06	56.00	-24.94	QP
6	25.055	18.31	0.46	-9.59	0.48	28.84	60.00	-31.16	QP

Remarks: Level = Read + LISN Factor - Preamp Factor + Cable loss

EUT: IP CAMERA  
M/N: 553MW  
Operator: Amy  
Test Specification: N  
Test Mode: Link mode

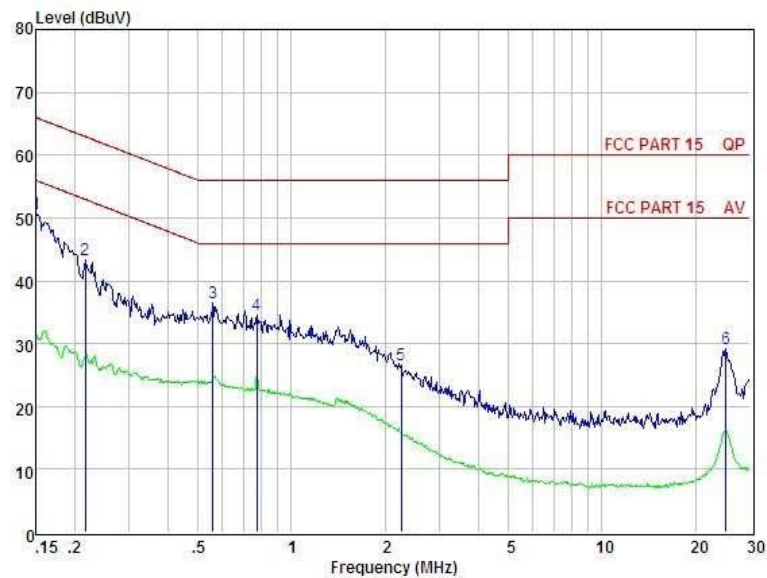

Condition : FCC PART 15 QP POL: NEUTRAL Temp:24 °C Hum:56 %

Item	Freq MHz	Read dBuV	LISN Factor dB	Preamp Factor dB	Cable Loss dB	Level dBuV	Limit dBuV	Margin dBuV	Remark
1	0.150	40.80	0.03	-9.72	0.10	50.65	66.00	-15.35	QP
2	0.216	33.56	0.03	-9.72	0.10	43.41	62.96	-19.55	QP
3	0.558	26.63	0.03	-9.72	0.10	36.48	56.00	-19.52	QP
4	0.775	24.83	0.00	-9.71	0.10	34.64	56.00	-21.36	QP
5	2.261	16.81	0.06	-9.70	0.11	26.68	56.00	-29.32	QP
6	25.055	18.62	0.46	-9.59	0.48	29.15	60.00	-30.85	QP

Remarks: Level = Read + LISN Factor - Preamp Factor + Cable loss

## 6. 6dB Bandwidth Measurement

### 6.1 Limits of 6dB Bandwidth Measurement

According to 15.247(a)(2). Systems using digital modulation techniques may operate in the 902–928 MHz, 2400–2483.5 MHz, and 5725–5850 MHz bands. The minimum 6 dB bandwidth shall be at least 500 kHz.

### 6.2 EUT Setup

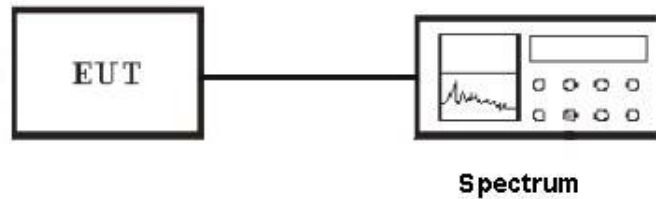

### 6.3 Test Equipment List and Details

See section 2.4.

### 6.4 Test Procedure

1. Remove the antenna from the EUT and then connect a low loss RF cable from the antenna port to the spectrum analyzer.
2. Set center frequency of spectrum analyzer = operating frequency.
3. The spectrum analyzer as  $RBW = 1-5 \% EBW$ ,  $VBW \geq 3RBW$ , Sweep=auto
4. Mark the peak frequency and  $-6dB$  (upper and lower) frequency.

### 6.5 Test Result

PASS

Detailed information, Please refer to the following pages.

**For 802.11b**  
Low Channel

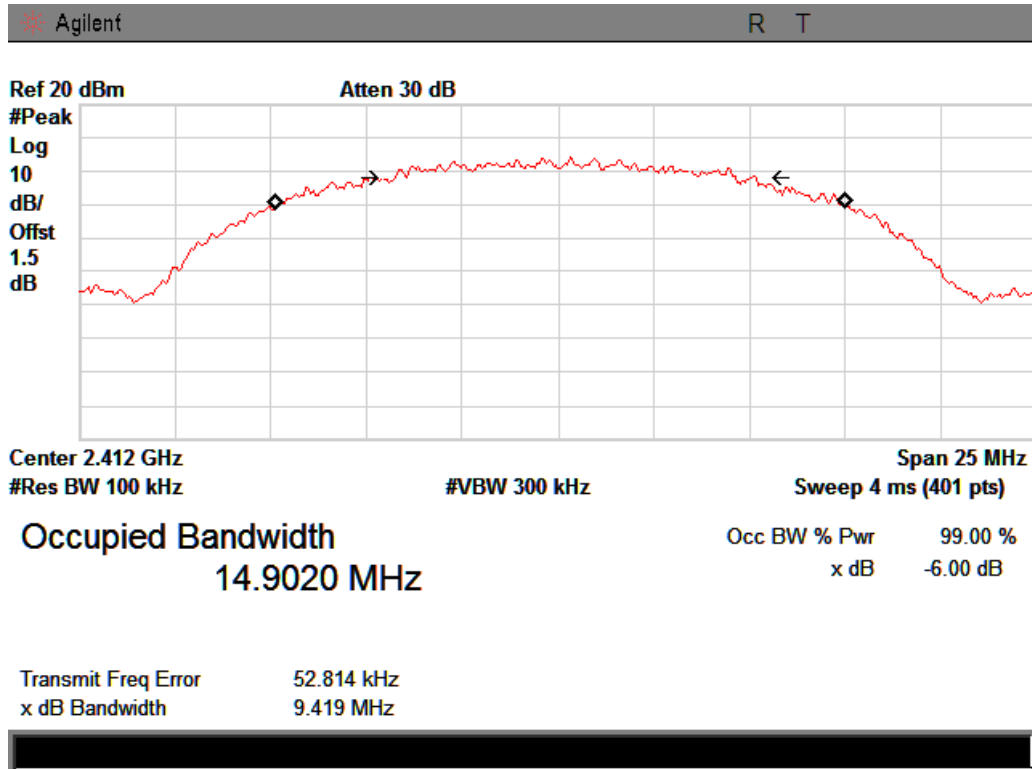

Middle Channel

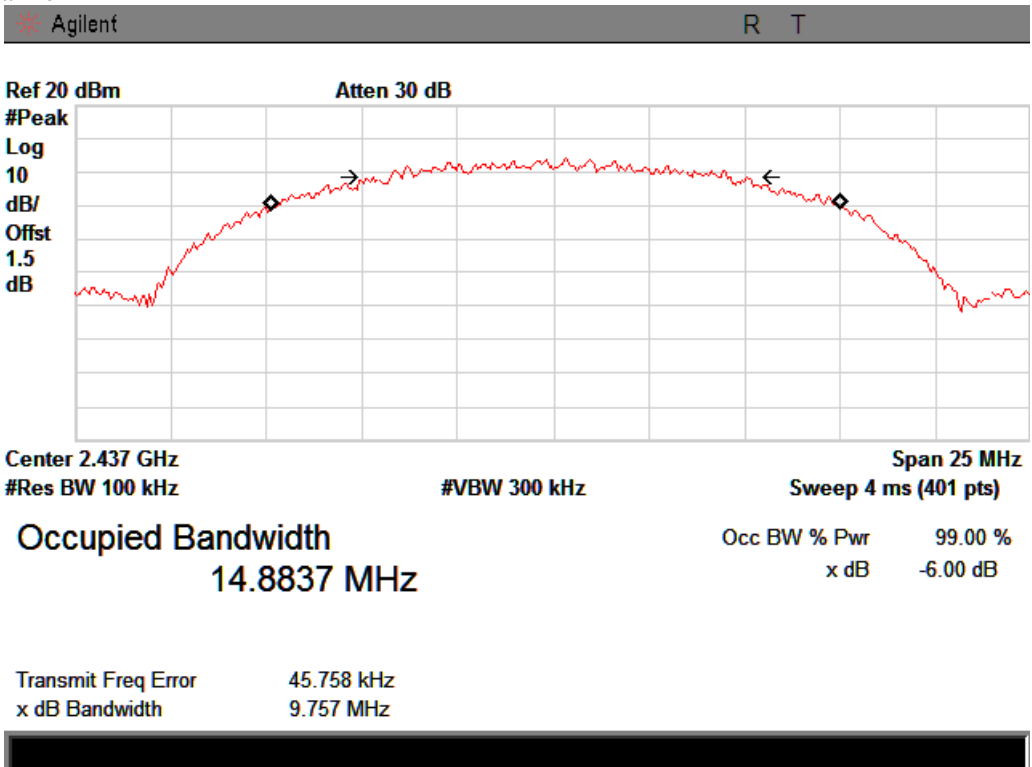

High Channel

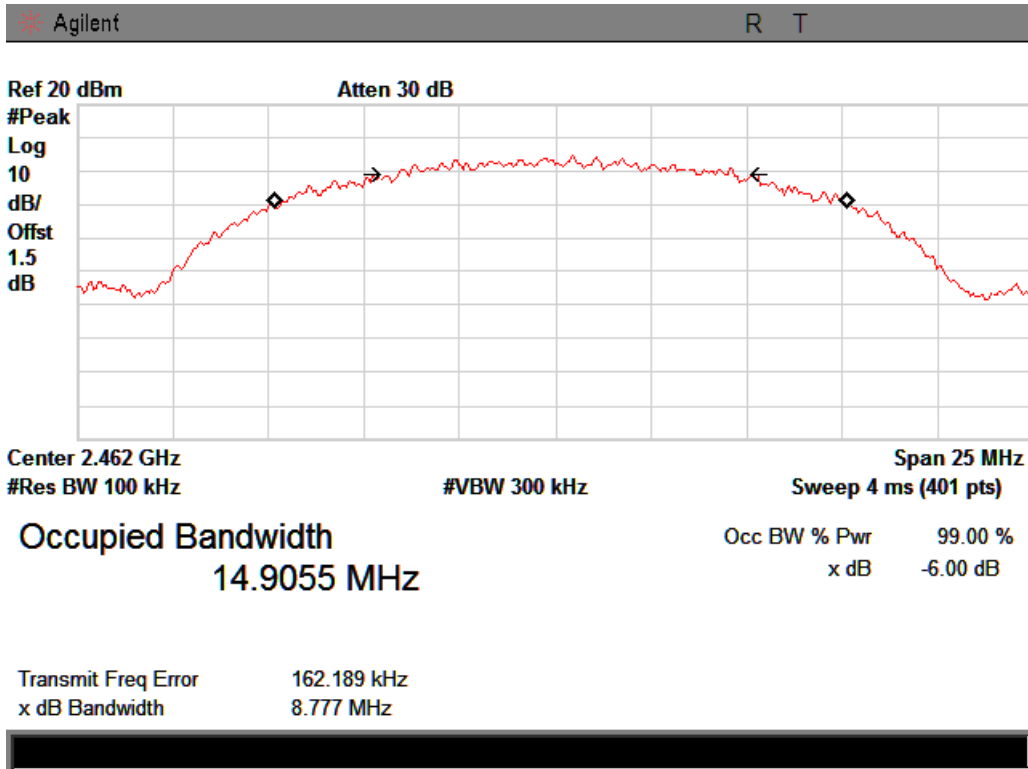

For 802.11g  
Low Channel

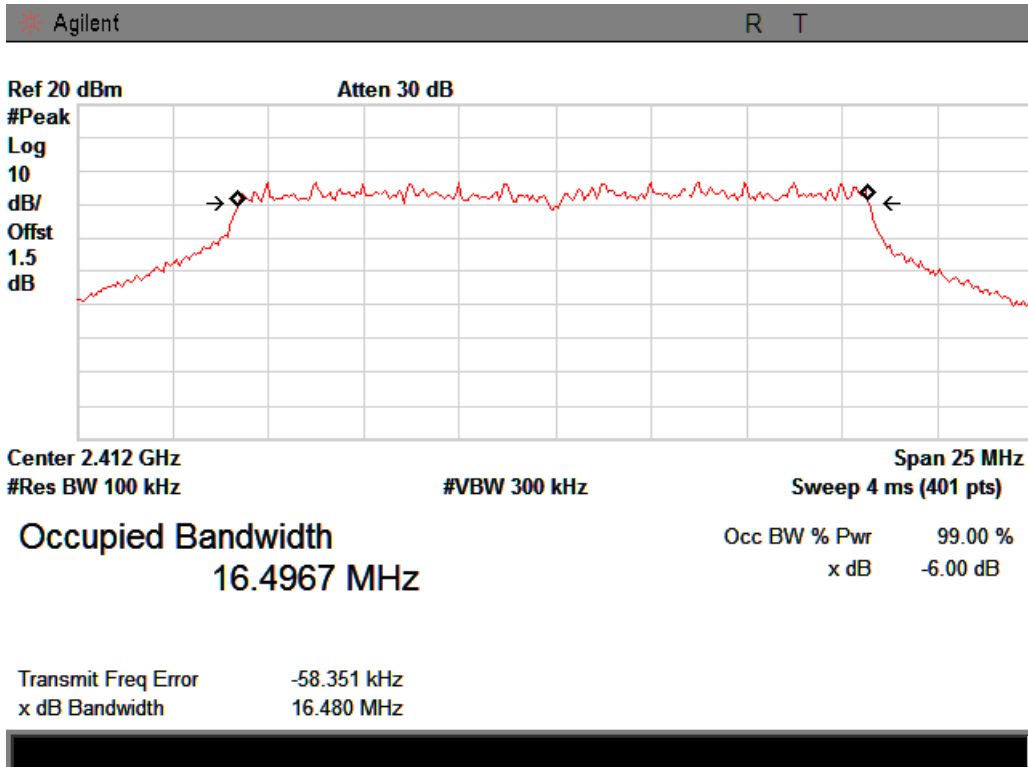



Middle Channel

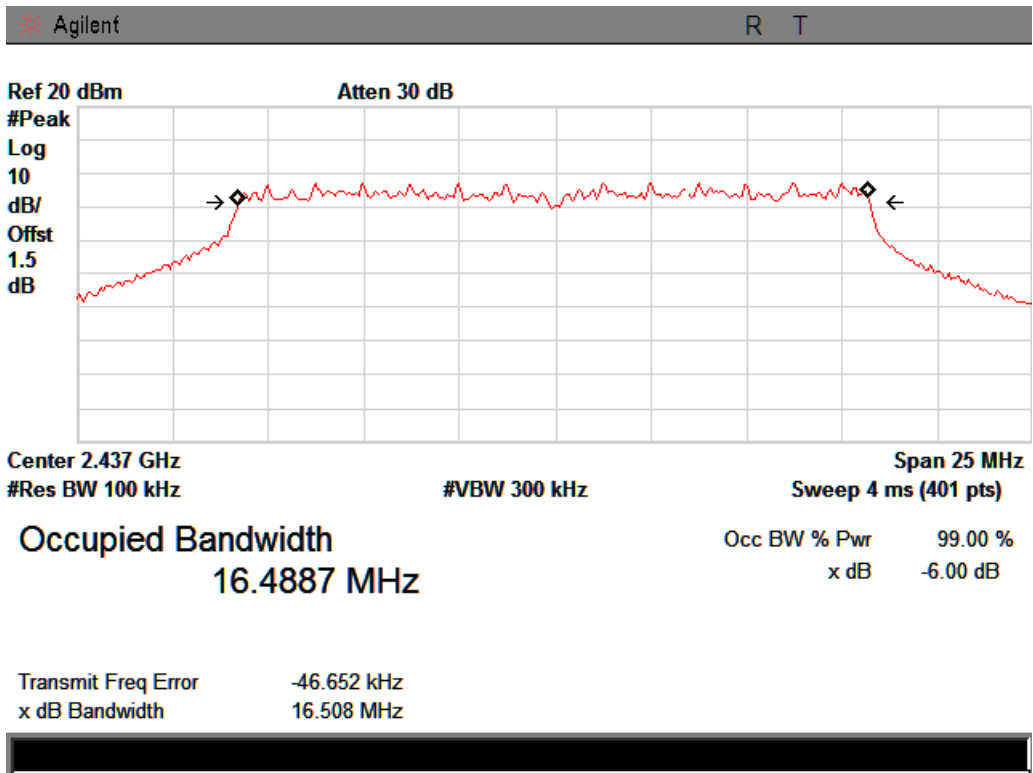

High Channel

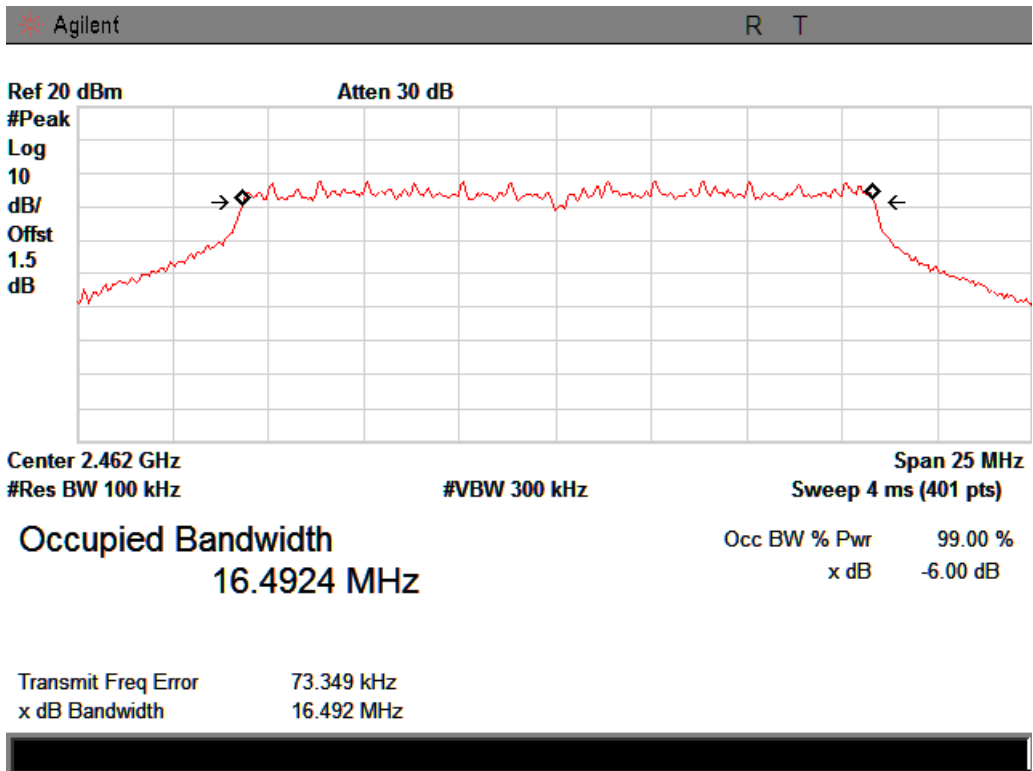

**For 802.11n/HT20**  
 Low Channel

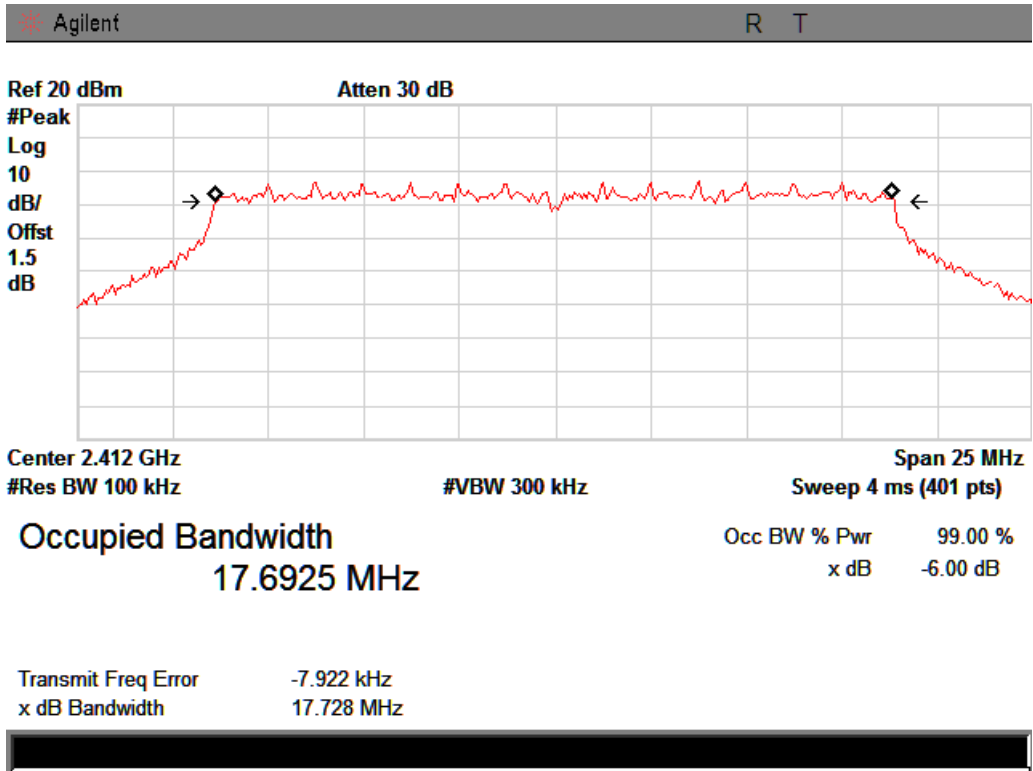

Middle Channel

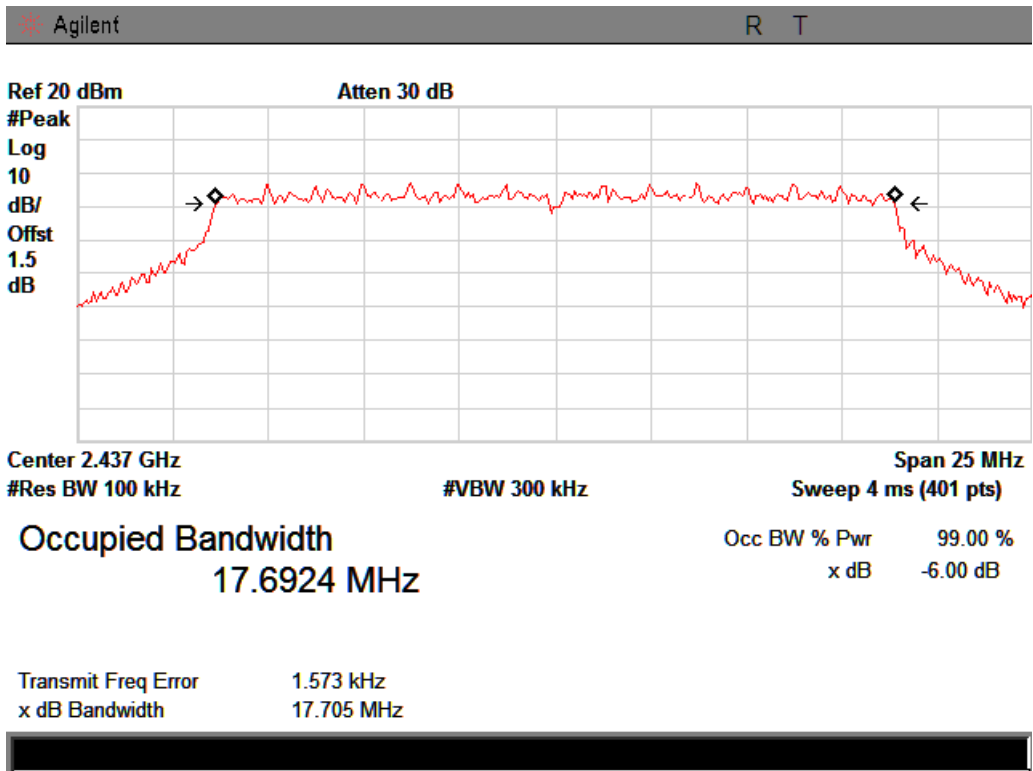

High Channel:

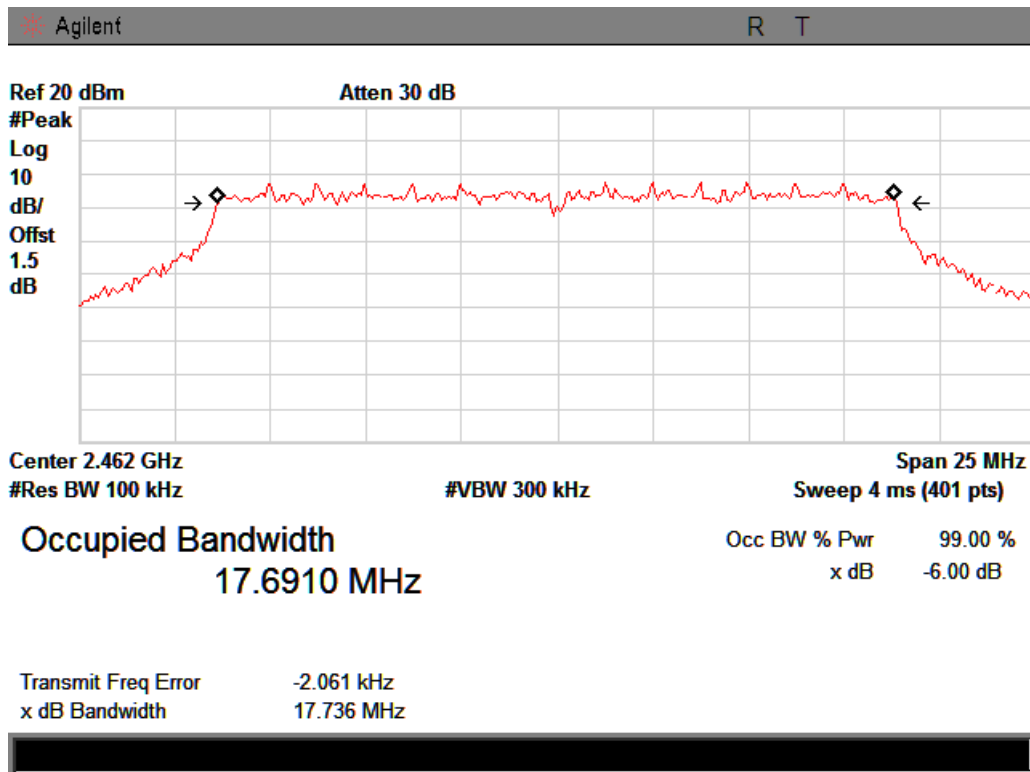

For 802.11n/HT40

Low Channel

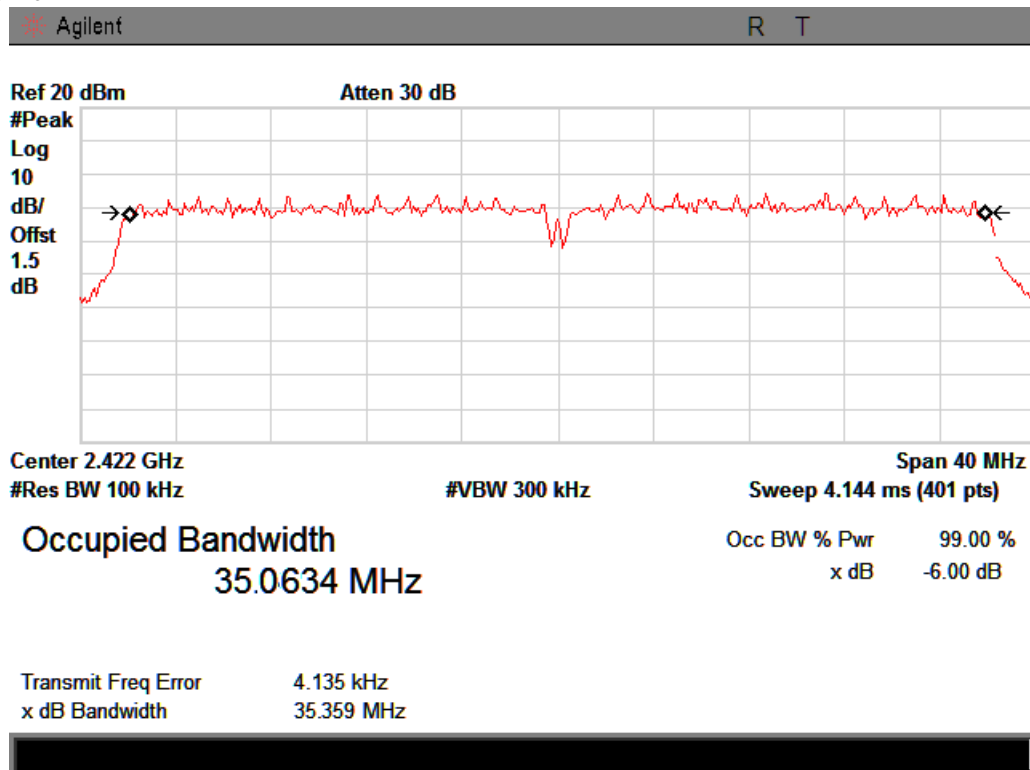

Middle Channel

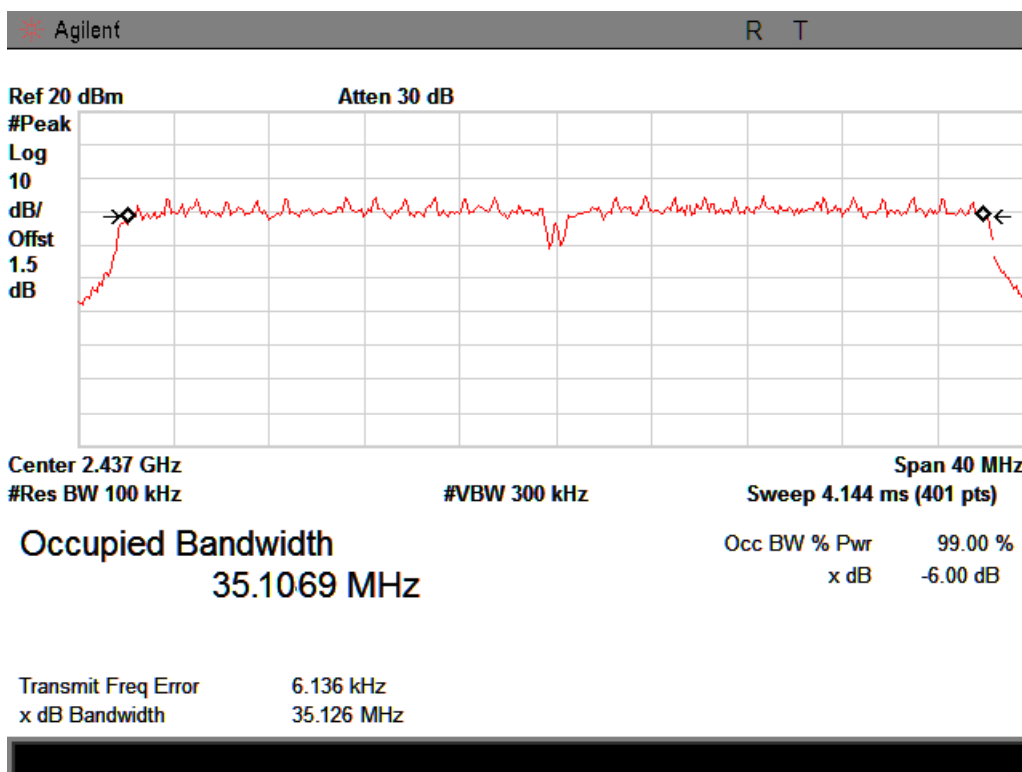

High Channel:

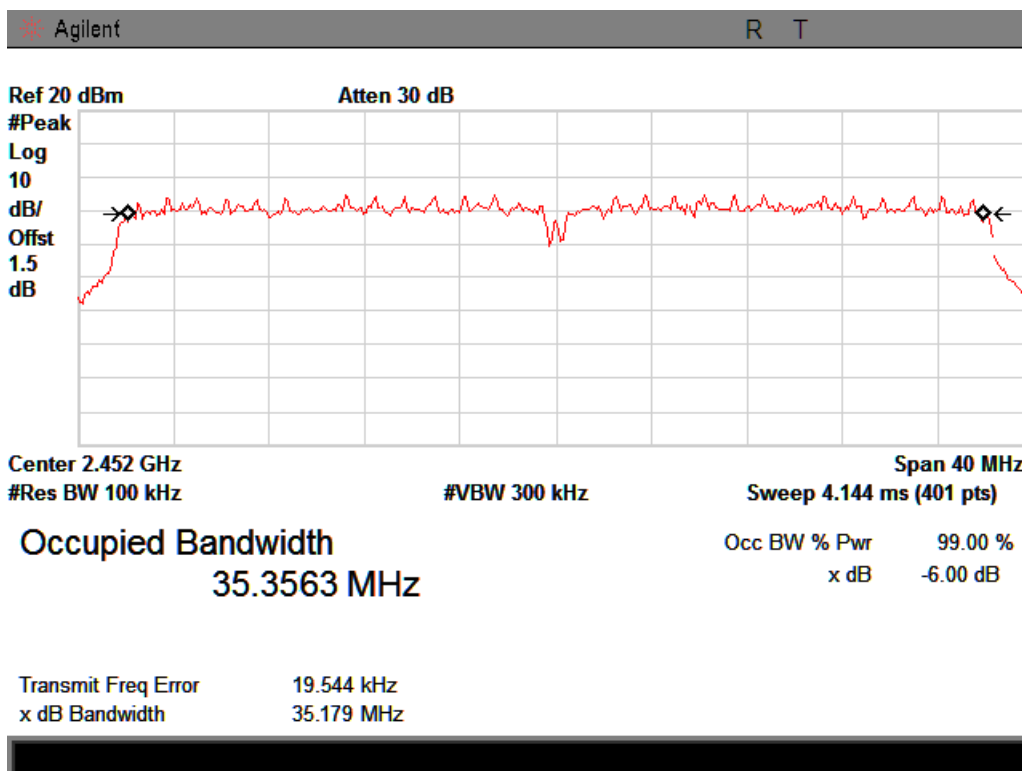

## 7. Maximum Peak Output Power

### 7.1 Limits of Maximum Peak Output Power Measurement

According to 15.247(b)(3). For systems using digital modulation in the 902–928 MHz, 2400–2483.5 MHz, and 5725–5850 MHz bands: 1 Watt.

### 7.2 EUT Setup



### 7.3 Test Equipment List and Details

See section 2.4.

### 7.4 Test Procedure

The transmitter output is connected to the RF Power Meter. The RF Power Meter is set to the peak power detection.

### 7.5 Test Result

PASS

802.11b:

Channel No.	Frequency (MHz)	PEAK POWEROUTPUT (dBm)	PEAK POWEROUTPUT (W)	PEAK POWER LIMIT (W)	PASS/FAIL
LOW	2412	7.94	0.00622	1	PASS
Mid	2437	7.92	0.00619	1	PASS
High	2462	7.85	0.00609	1	PASS

802.11g:

Channel No.	Frequency (MHz)	PEAK POWEROUTPUT ( dBm )	PEAK POWEROUTPUT (W)	PEAK POWER LIMIT (W)	PASS/FAIL
LOW	2412	7.13	0.00516	1	PASS
Mid	2437	7.16	0.00519	1	PASS
High	2462	7.11	0.00514	1	PASS

802.11n/HT20:

Channel No.	Frequency (MHz)	PEAK POWEROUTPUT (dBm)	PEAK POWEROUTPUT (W)	PEAK POWER LIMIT (W)	PASS/FAIL
LOW	2412	7.09	0.00511	1	PASS
Mid	2437	7.05	0.00506	1	PASS
High	2462	7.03	0.00504	1	PASS

802.11n/HT40:

Channel No.	Frequency (MHz)	PEAK POWEROUTPUT (dBm)	PEAK POWEROUTPUT (W)	PEAK POWER LIMIT (W)	PASS/FAIL
LOW	2422	6.21	0.00417	1	PASS
Mid	2437	6.35	0.00431	1	PASS
High	2452	6.18	0.00414	1	PASS

## 8. Power Spectral Density Measurement

### 8.1 Limits of Power Spectral Density Measurement

According to 15.247(a)(1)(iii), For digitally modulated systems, the power spectral density conducted from the intentional radiator to the antenna shall not be greater than 8 dBm in any 3 kHz band during any time interval of continuous transmission.

### 8.2 EUT Setup

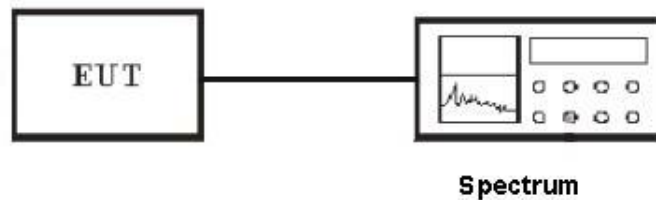

### 8.3 Test Equipment List and Details

See section 2.4.

### 8.4 Test Procedure

1. Set analyzer center frequency to DTS channel center frequency.
2. Set the span to 1.5 times the DTS channel bandwidth.
3. Set the RBW  $\geq$  3 kHz.
4. Set the VBW  $\geq$  3 x RBW.
5. Detector = peak.
6. Sweep time = auto couple.
7. Trace mode = max hold.
8. Allow trace to fully stabilize.
9. Use the peak marker function to determine the maximum amplitude level.
10. If measured value exceeds limit, reduce RBW (no less than 3 kHz) and repeat.

### 8.5 Test Result

PASS

Detailed information test plot, Please refer to the following pages.

Channel	Frequency (MHz)	Power Spectral Density (dBm)	Limit (dBm)	Result
IEEE 802.11 b				
Low	2412	-12.78	8	PASS
Mid	2437	-13.69	8	PASS
High	2462	-13.73	8	PASS
IEEE 802.11 g				
Low	2412	-11.55	8	PASS
Mid	2437	-11.73	8	PASS
High	2462	-12.54	8	PASS
IEEE 802.11 n/HT20				
Low	2412	-12.12	8	PASS
Mid	2437	-11.66	8	PASS
High	2462	-12.10	8	PASS
IEEE 802.11 n/HT40				
Low	2422	-12.20	8	PASS
Mid	2437	-11.13	8	PASS
High	2452	-12.95	8	PASS



IEEE 802.11b  
Low Channel:

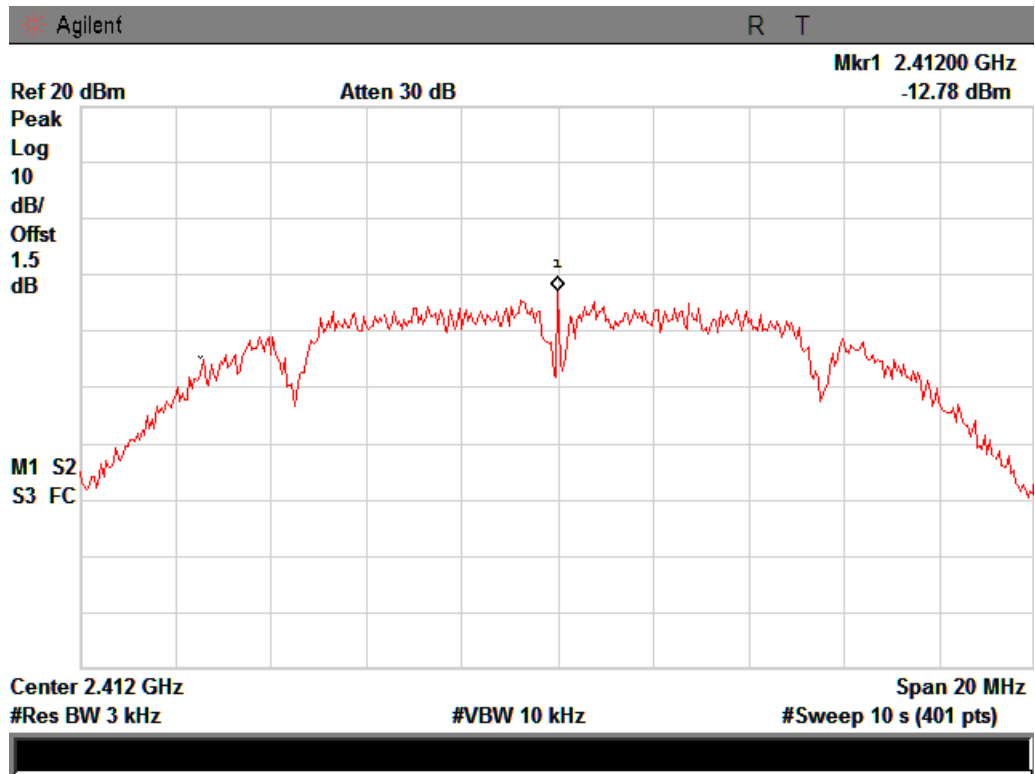

Middle Channel

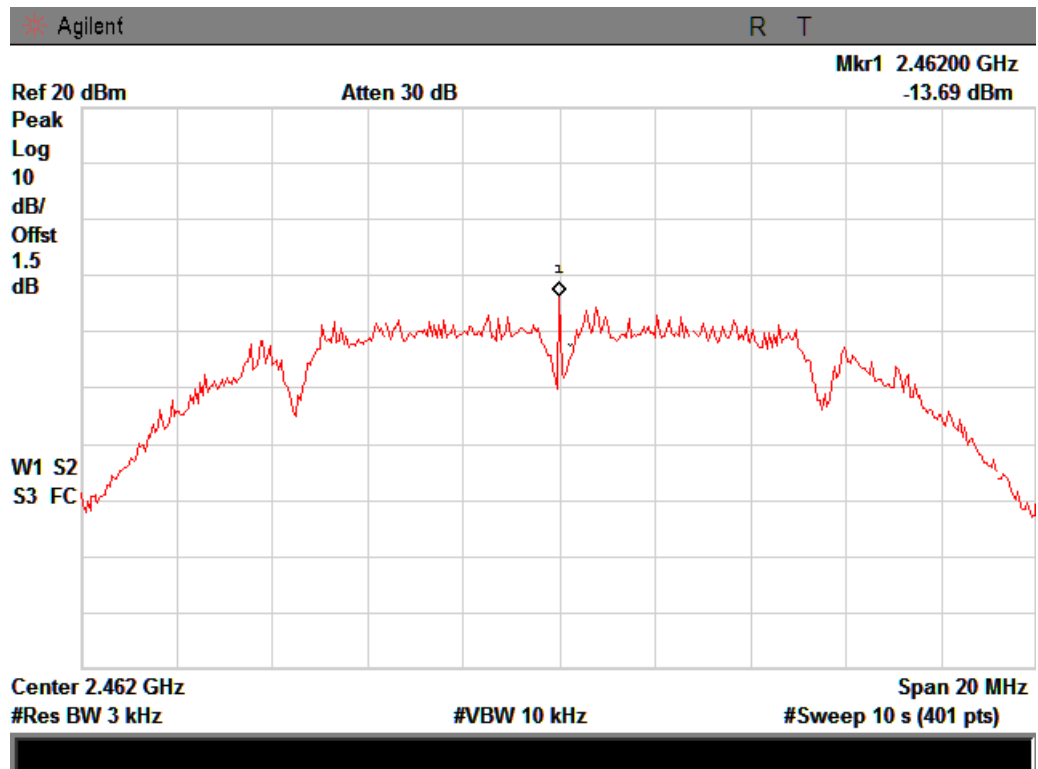

High Channel

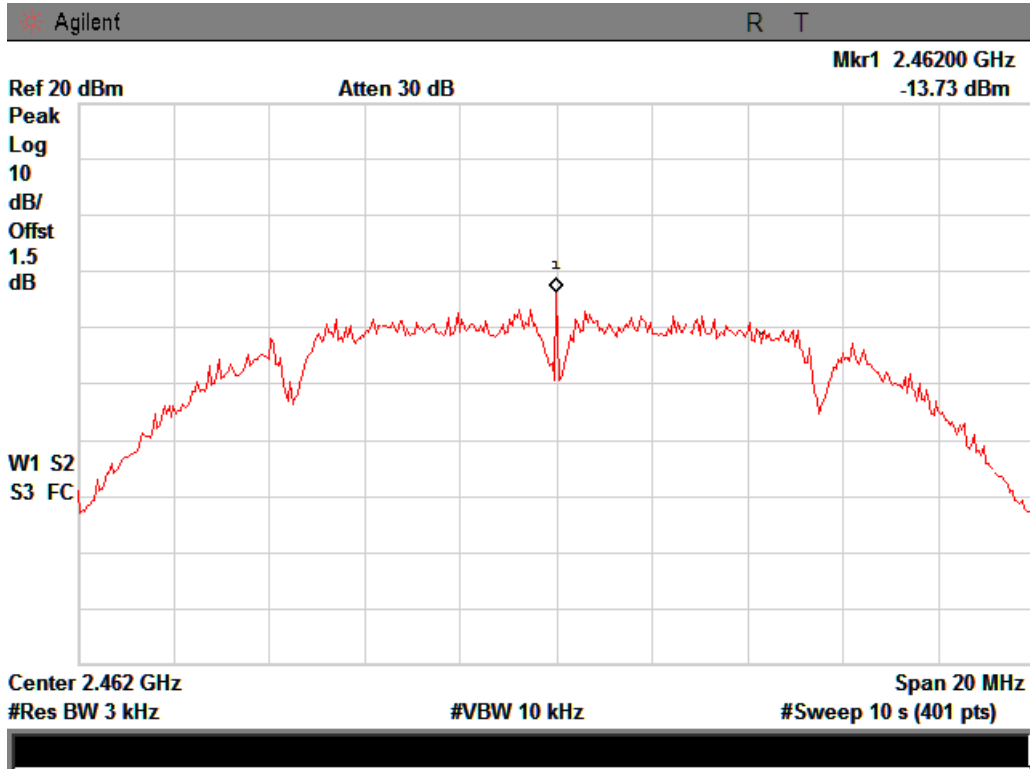

For 802.11g  
Low Channel

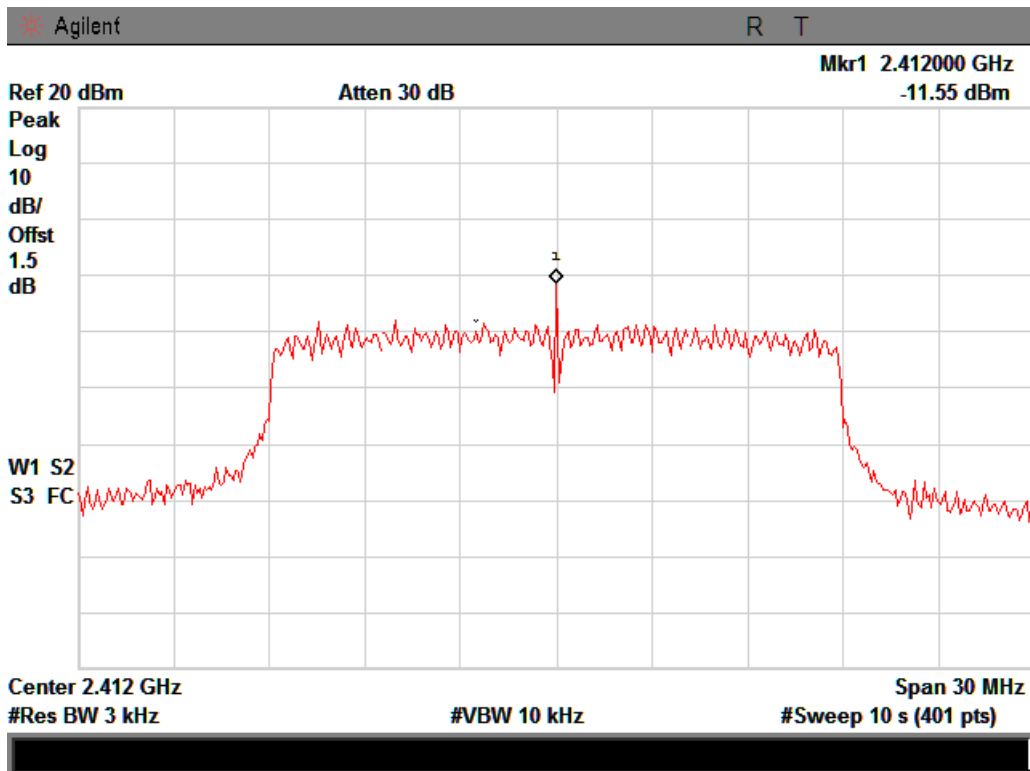

Middle Channel

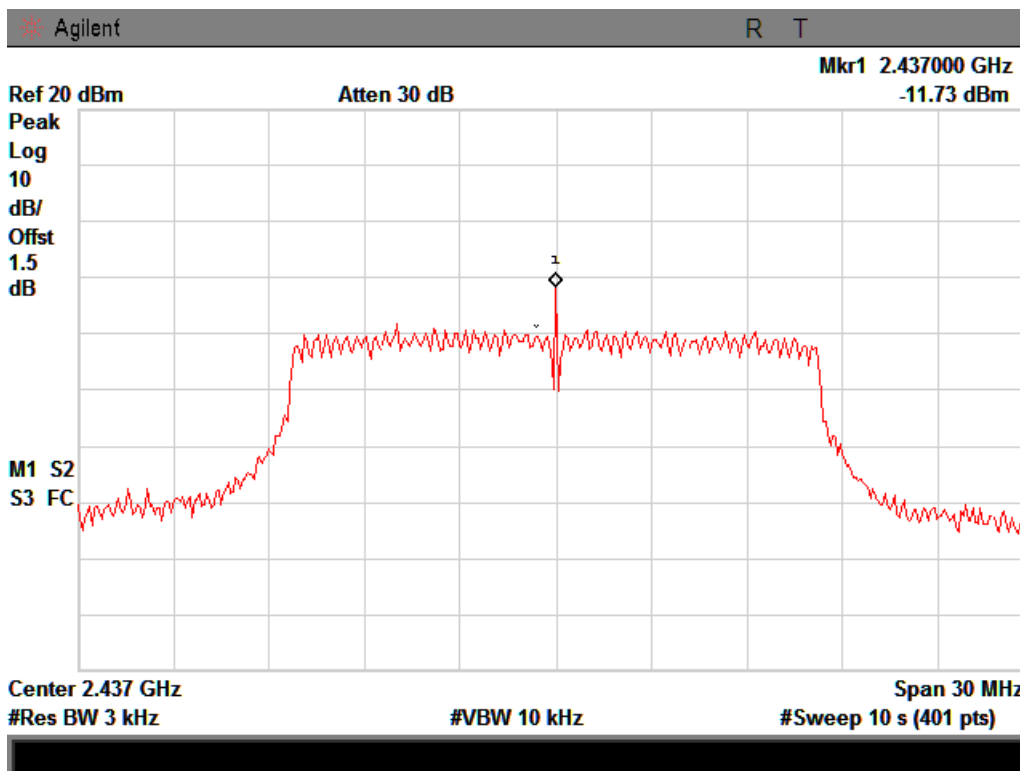

High Channel

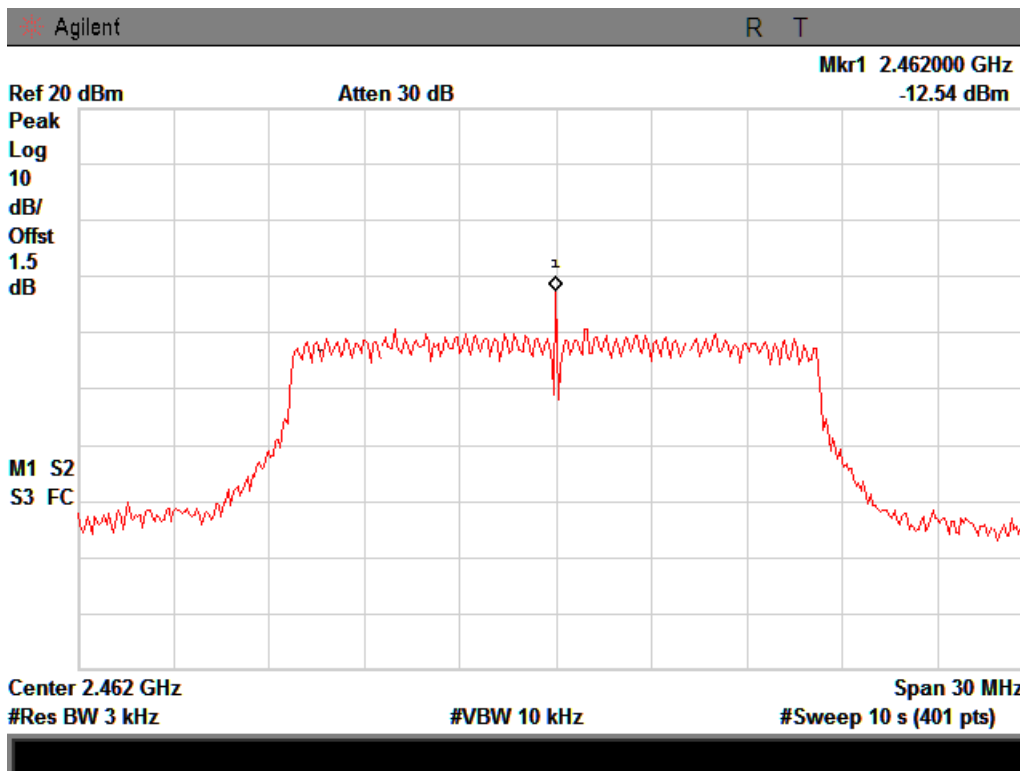

For 802.11n/HT20  
Low Channel

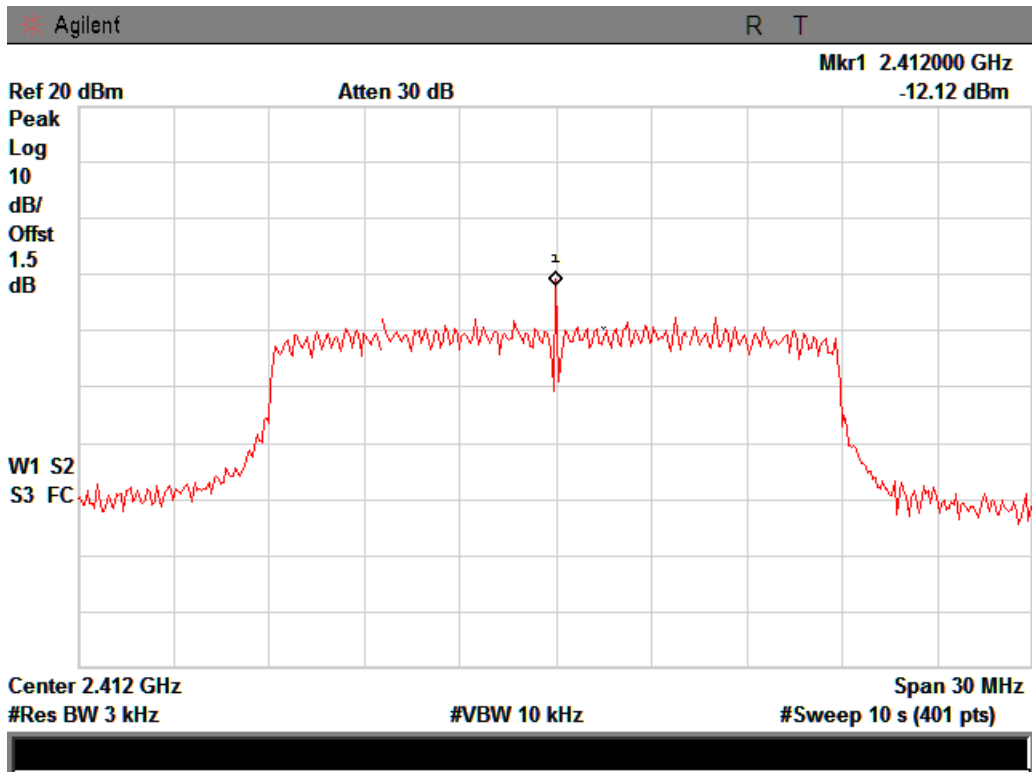

Middle Channel

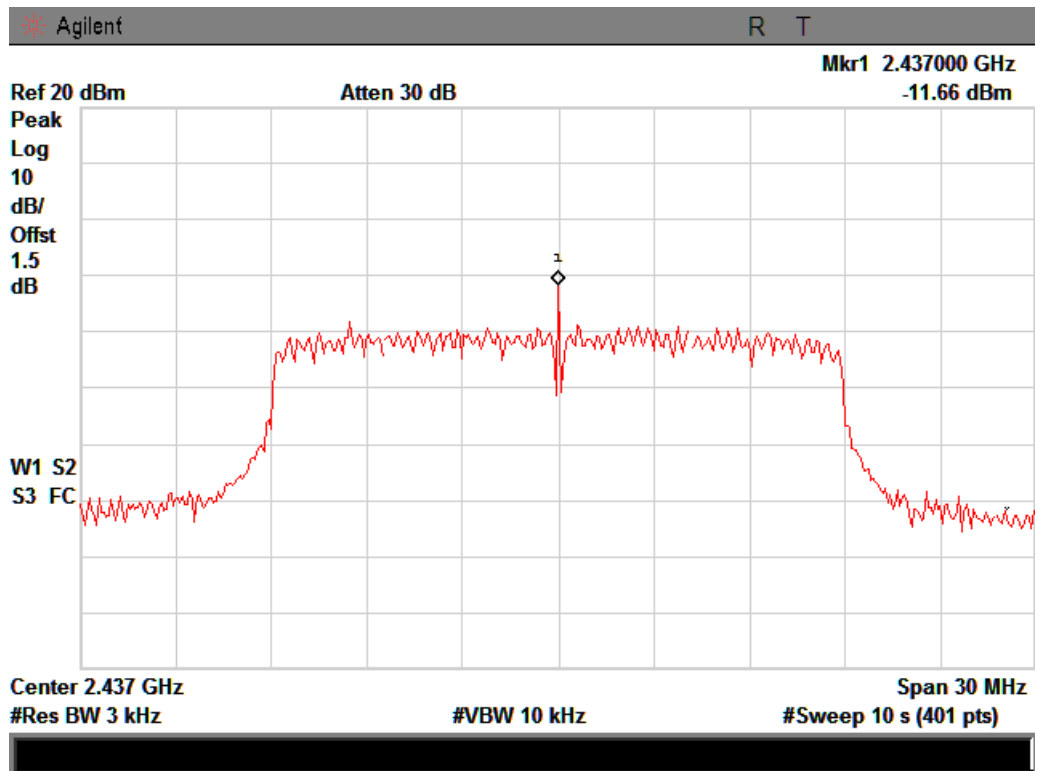

High Channel

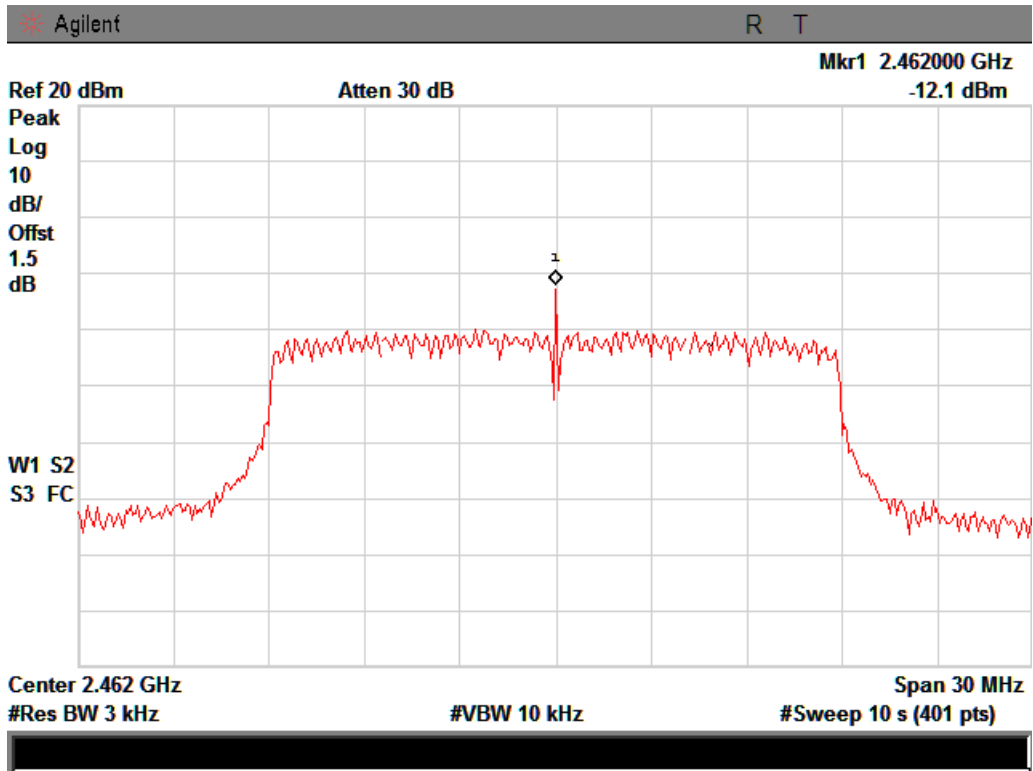

For 802.11n/HT40  
Low Channel

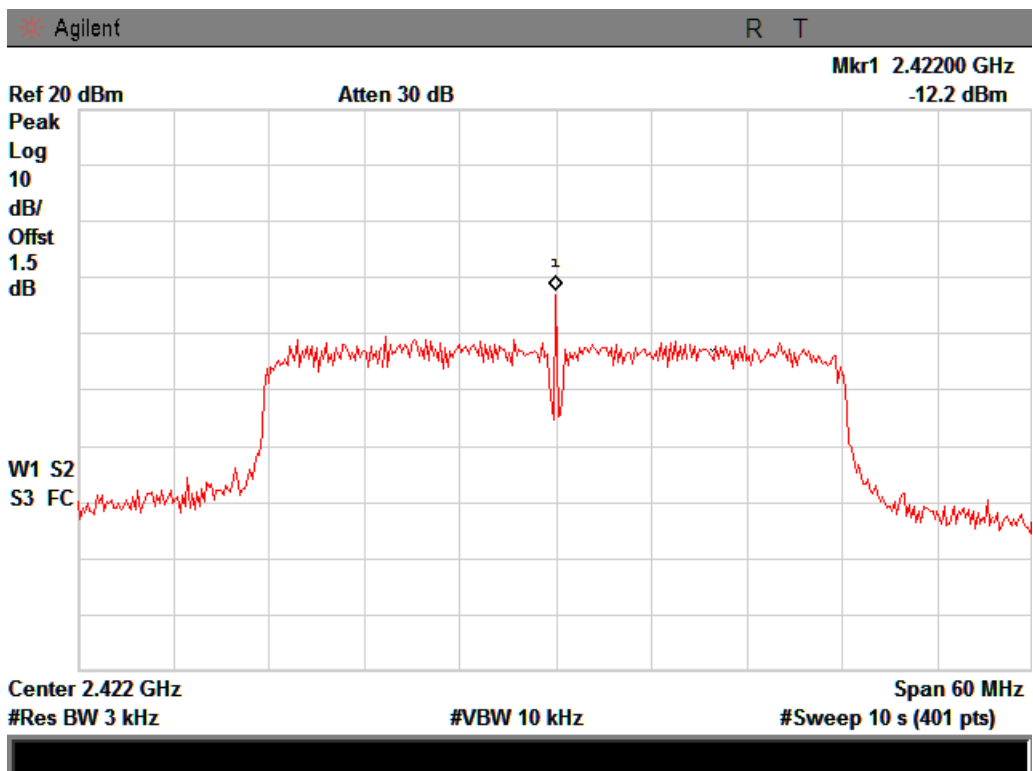

Middle Channel

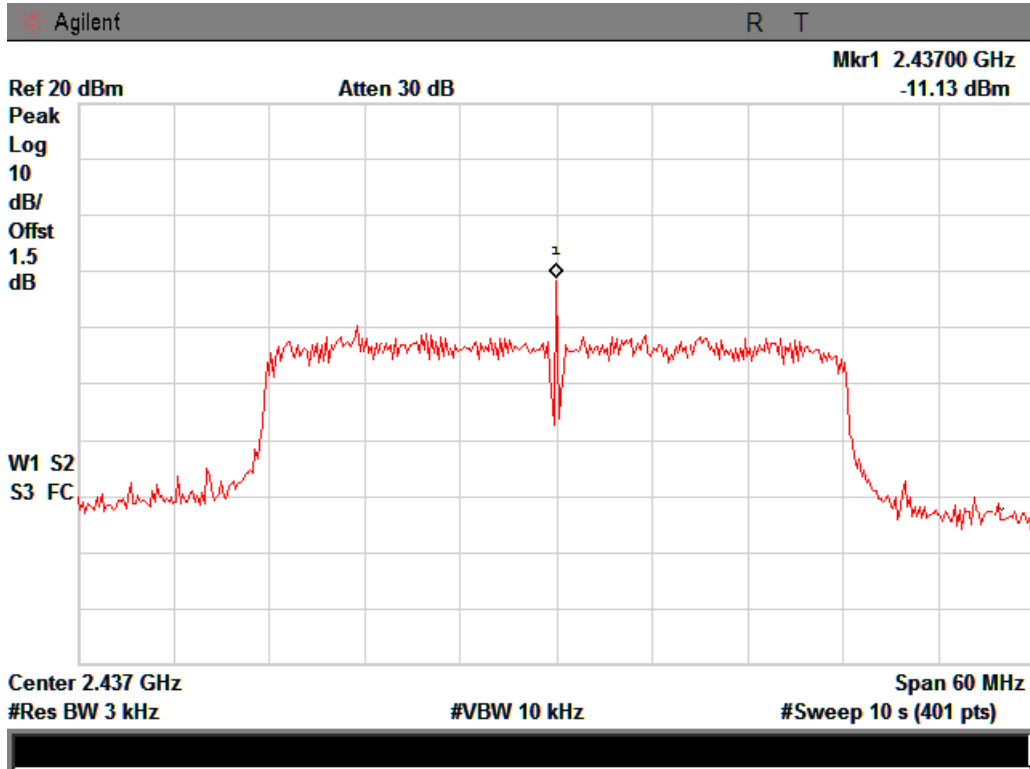

High Channel

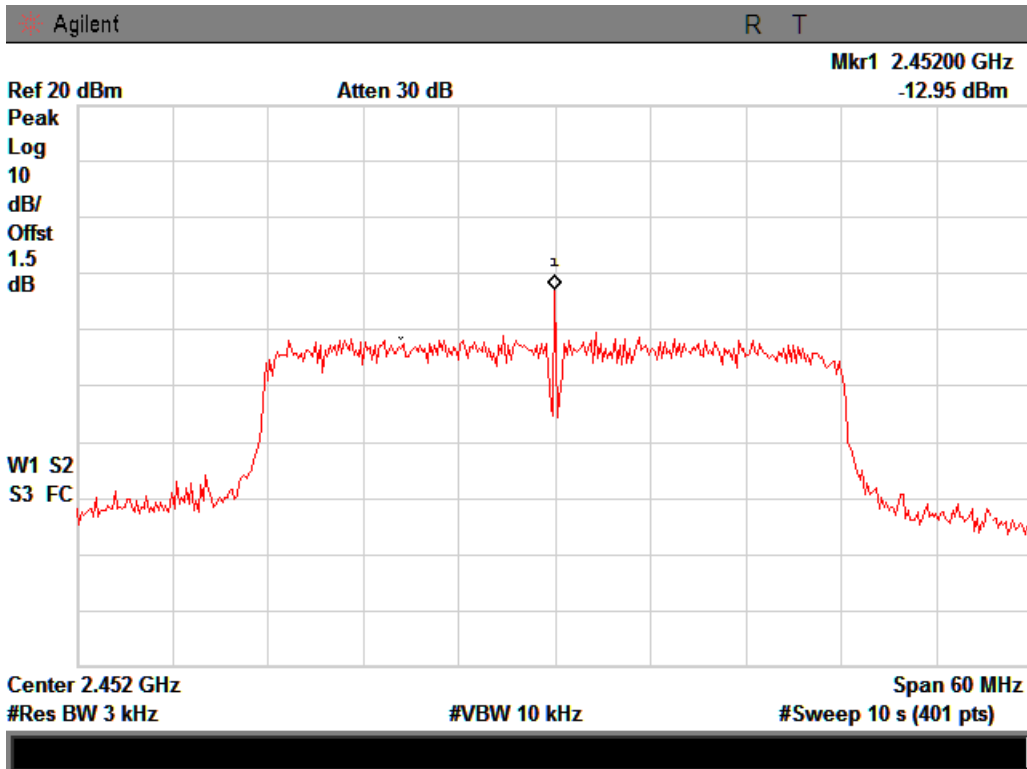

## **9. Band Edges Measurement**

### **9.1 Limits of Band Edges Measurement**

According to §15.247 (d) In any 100 kHz bandwidth outside the frequency band in which the spread spectrum or digitally modulated intentional radiator is operating, the radio frequency power that is produced by the intentional radiator shall be at least 20 dB below that in the 100 kHz bandwidth within the band that contains the highest level of the desired power, based on either an RF conducted or a radiated measurement, provided the transmitter demonstrates compliance with the peak conducted power limits.

### **9.2 Test Equipment List and Details**

See section 2.4.

### **9.3 Test Procedure**

The transmitter output was connected to the spectrum analyzer via a low lose cable. Set both RBW and VBW of spectrum analyzer to 100 kHz with suitable frequency span including 100 MHz bandwidth from band edge. The band edges was measured and recorded. The spectrum plots (Peak RBW=VBW=1MHz; Average RBW=1MHz, VBW=10Hz) are attached on the following pages.

### **9.4 Test Result**

PASS

Detailed information test plot, Please refer to the following pages.

**IEEE 802.11b**  
 Lowest Band edge- Vertical

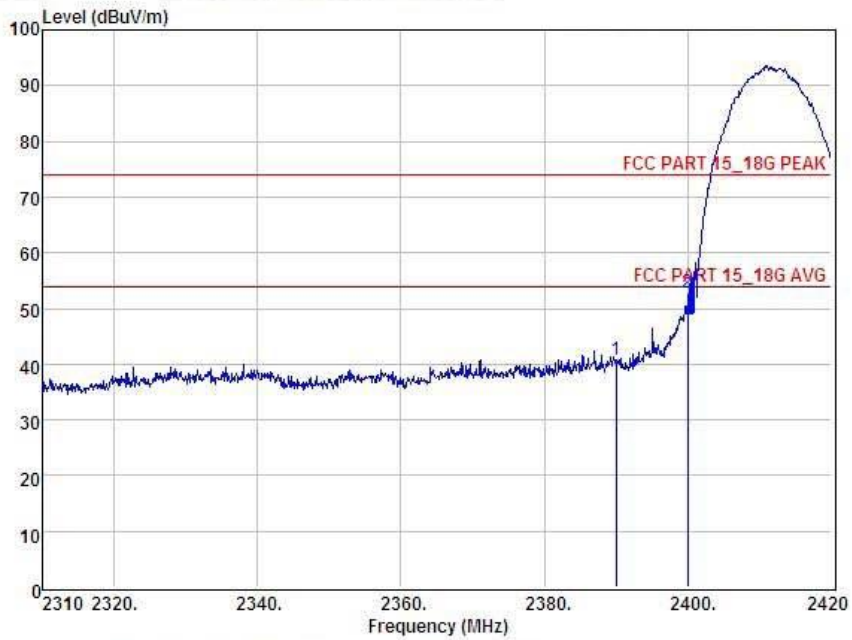

Condition : FCC PART 15\_18G PEAK 3m POL: VERTICAL

Item	Freq MHz	Read Level dBuV	Antenna Factor dB	Preamp Factor dB	Cable Loss dB	Level dBuV	Limit dBuV	Margin dBuV	Remark
1	2390.00	44.07	27.62	34.97	3.92	40.64	74.00	-33.36	Peak
2	2400.00	56.27	27.62	34.97	3.94	52.86	74.00	-21.14	Peak

Remark: Level = Read Level + Antenna Factor - Preamp Factor + Cable Loss



High Band edge- Vertical

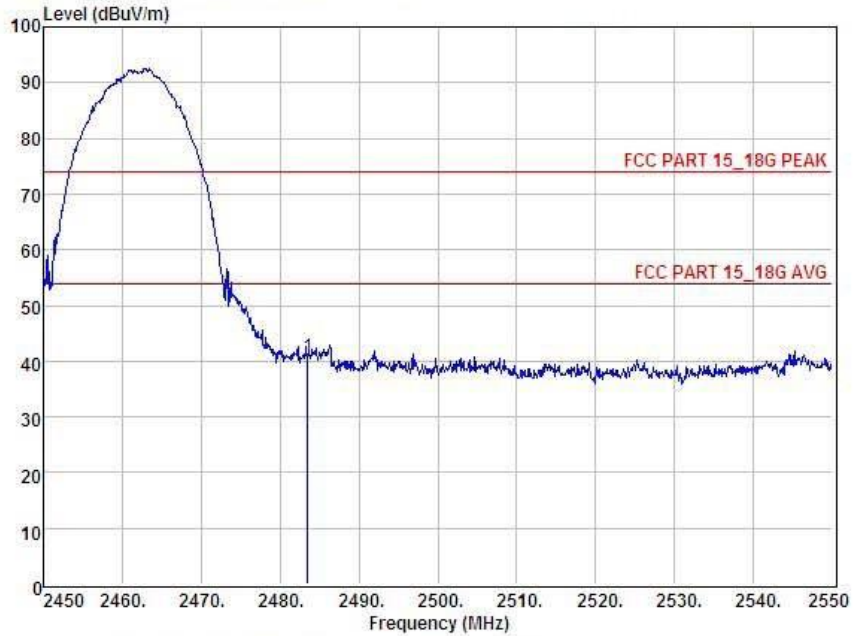

Condition : FCC PART 15_18G PEAK 3m. POL: VERTICAL									
Item	Freq	Read Level	Antenna Factor	Preamp Factor	Cable Loss	Level	Limit	Margin	Remark
	MHz	dBuV	dB	dB	dB	dBuV	dBuV	dBuV	
1	2483.50	44.21	27.59	34.97	4.00	40.83	74.00	-33.17	Peak

Remark: Level = Read Level + Antenna Factor - Preamp Factor + Cable Loss

Lowest Band edge-Horizontal

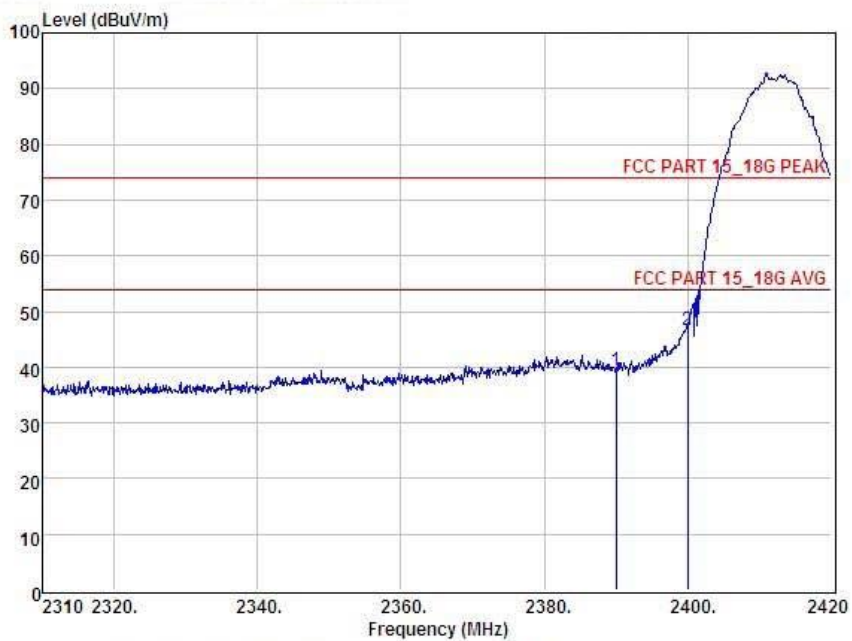

Condition : FCC PART 15\_18G PEAK 3m POL: HORIZONTAL

Item	Freq MHz	Read Level dBuV	Antenna Factor dB	Preamp Factor dB	Cable Loss dB	Level dBuV	Limit dBuV	Margin dBuV	Remark
1	2390.00	42.95	27.62	34.97	3.92	39.52	74.00	-34.48	Peak
2	2400.00	50.14	27.62	34.97	3.94	46.73	74.00	-27.27	Peak

Remark: Level = Read Level + Antenna Factor - Preamp Factor + Cable Loss

High Band edge- Horizontal

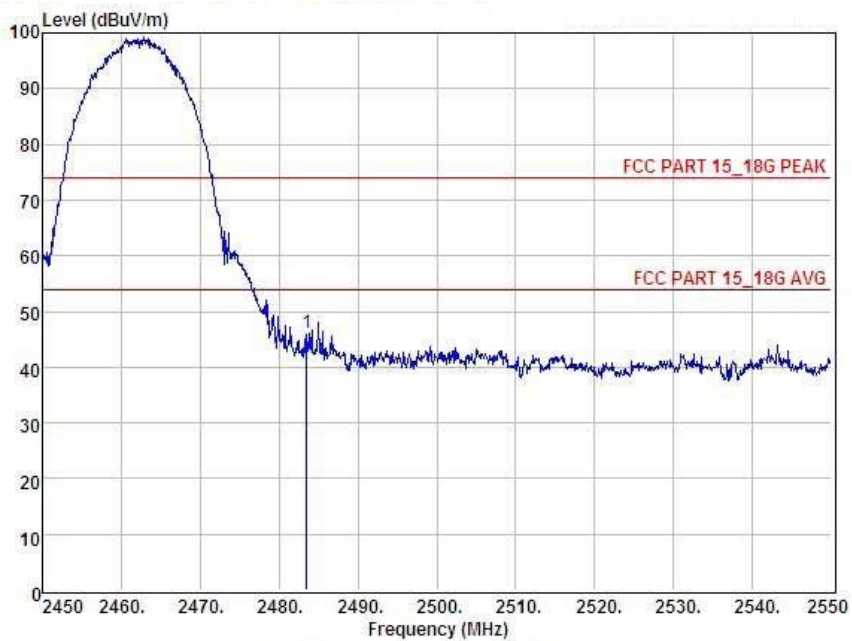

Condition : FCC PART 15_18G PEAK 3m POL: HORIZONTAL									
Item	Freq	Read Level	Antenna Factor	Preamp Factor	Cable Loss	Level	Limit	Margin	Remark
	MHz	dBuV	dB	dB	dB	dBuV	dBuV	dBuV	
1	2483.50	49.52	27.59	34.97	4.00	46.14	74.00	-27.86	Peak

Remark: Level = Read Level + Antenna Factor - Preamp Factor + Cable Loss

IEEE 802.11g  
 Lowest Band edge- Vertical

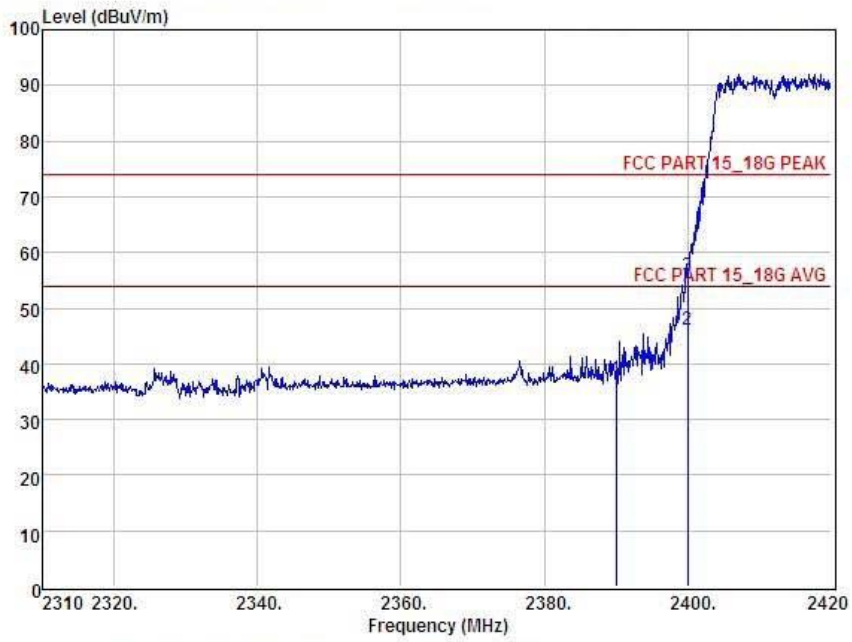

Condition : FCC PART 15\_18G PEAK 3m POL: VERTICAL

Item	Freq MHz	Read Level dBuV	Antenna Factor dB	Preamp Factor dB	Cable Loss dB	Level dBuV	Limit dBuV	Margin dBuV	Remark
1	2390.00	40.79	27.62	34.97	3.92	37.36	74.00	-36.64	Peak
2	2400.00	49.54	27.62	34.97	3.94	46.13	54.00	-7.87	Average
3	2400.00	59.09	27.62	34.97	3.94	55.68	74.00	-18.32	Peak

Remark: Level = Read Level + Antenna Factor - Preamp Factor + Cable Loss

High Band edge- Vertical

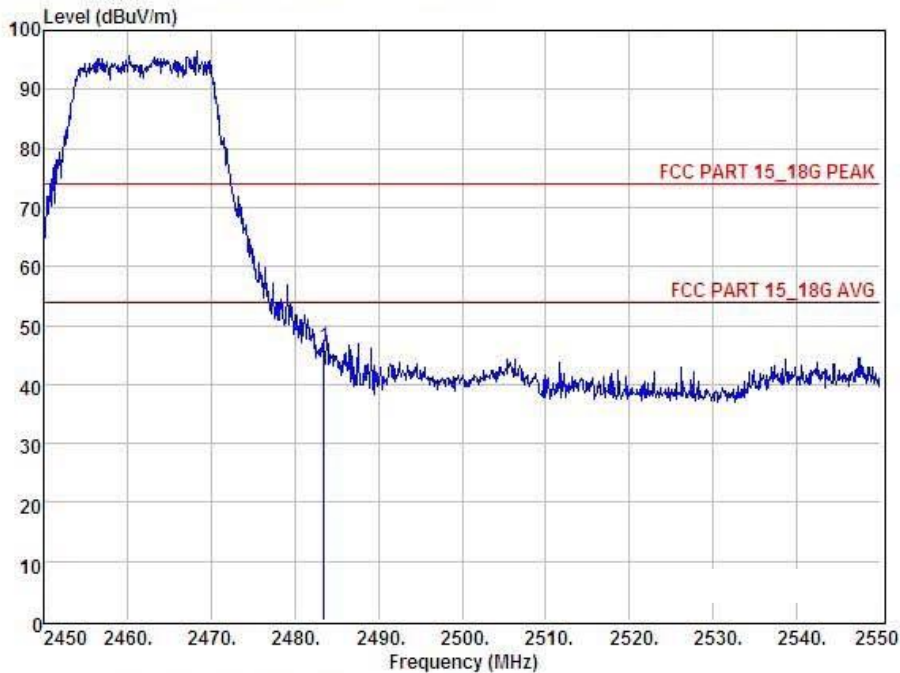

Condition : FCC PART 15\_18G PEAK 3m POL: VERTICAL

Item	Freq MHz	Read Level dBuV	Antenna Factor dB	Preamp Factor dB	Cable Loss dB	Level dBuV	Limit dBuV	Margin dBuV	Remark
1	2483.50	49.86	27.59	34.97	4.00	46.48	74.00	-27.52	Peak

Remark: Level = Read Level + Antenna Factor - Preamp Factor + Cable Loss

# Lowest Band edge-Horizontal

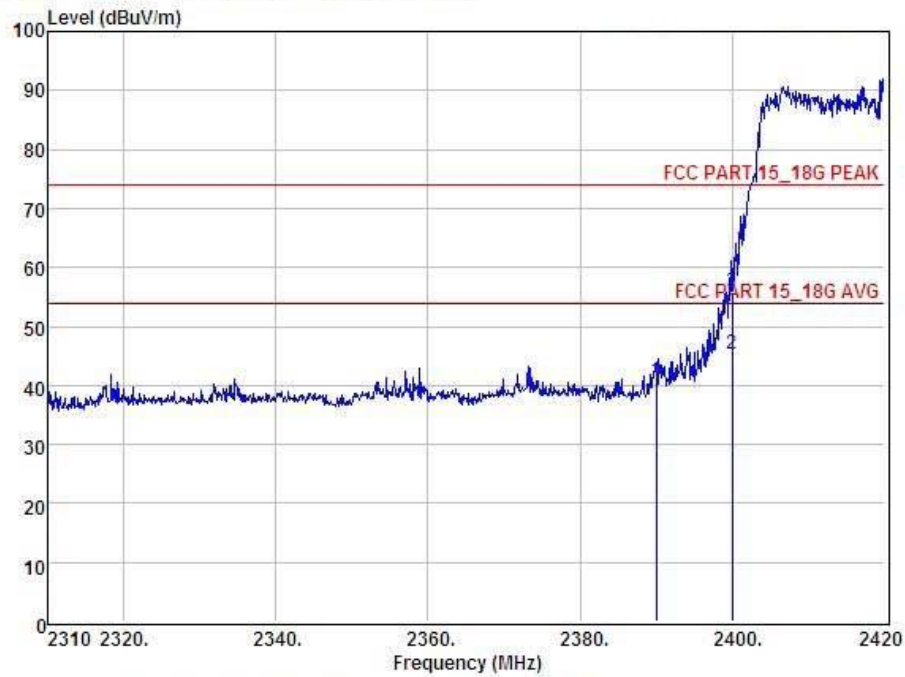

Condition : FCC PART 15\_18G PEAK 3m POL: HORIZONTAL

Item	Freq MHz	Read Level dBuV	Antenna Factor dB	Preamp Factor dB	Cable Loss dB	Level dBuV	Limit dBuV	Margin dBuV	Remark
1	2390.00	44.12	27.62	34.97	3.92	40.69	74.00	-33.31	Peak
2	2400.00	48.79	27.62	34.97	3.94	48.38	54.00	-8.62	Average
3	2400.00	59.30	27.62	34.97	3.94	55.89	74.00	-18.11	Peak

Remark: Level = Read Level + Antenna Factor - Preamp Factor + Cable Loss

# High Band edge- Horizontal

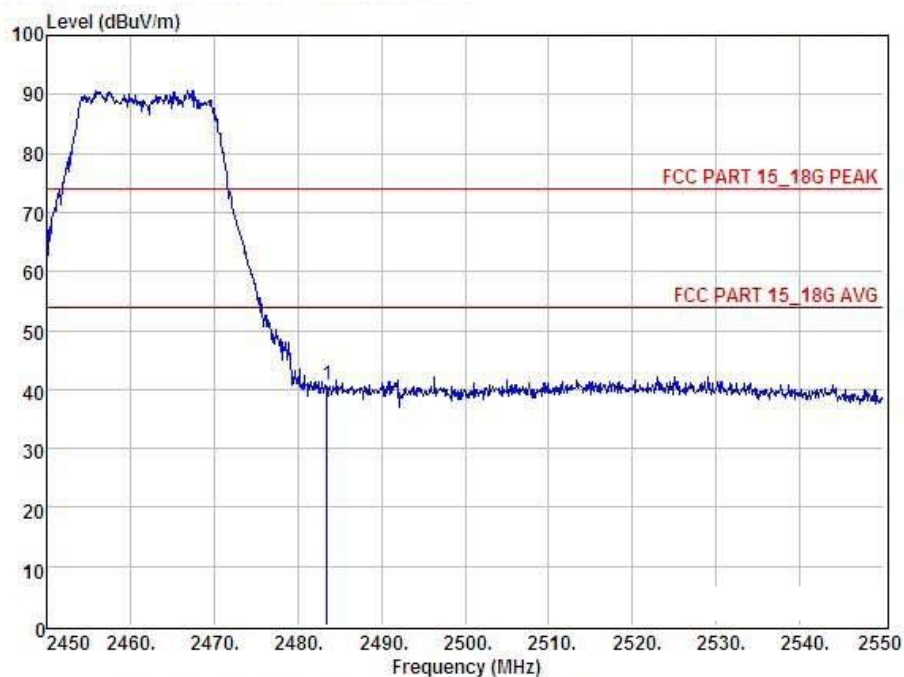

Condition : FCC PART 15\_18G PEAK 3m POL: HORIZONTAL

Item	Freq MHz	Read Level dBuV	Antenna Factor dB	Preamp Factor dB	Cable Loss dB	Level dBuV	Limit dBuV	Margin dBuV	Remark
1	2483.50	44.00	27.59	34.97	4.00	40.62	74.00	-33.38	Peak

Remark: Level = Read Level + Antenna Factor - Preamp Factor + Cable Loss

IEEE 802.11n:HT20  
 Lowest Band edge- Vertical

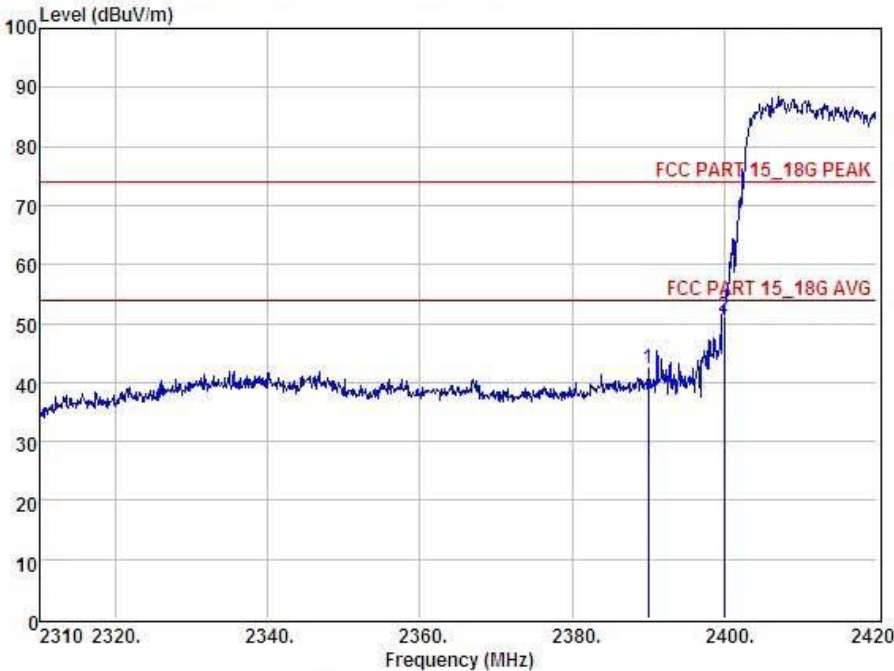

Condition : FCC PART 15\_18G PEAK 3m POL: VERTICAL

Item	Freq MHz	Read Level dBuV	Antenna Factor dB	Preamp Factor dB	Cable Loss dB	Level dBuV	Limit dBuV	Margin dBuV	Remark
1	2390.00	45.84	27.62	34.97	3.92	42.41	74.00	-31.59	Peak
2	2400.00	54.69	27.62	34.97	3.94	51.28	74.00	-22.72	Peak

Remark: Level = Read Level + Antenna Factor - Preamp Factor + Cable Loss



High Band edge- Vertical

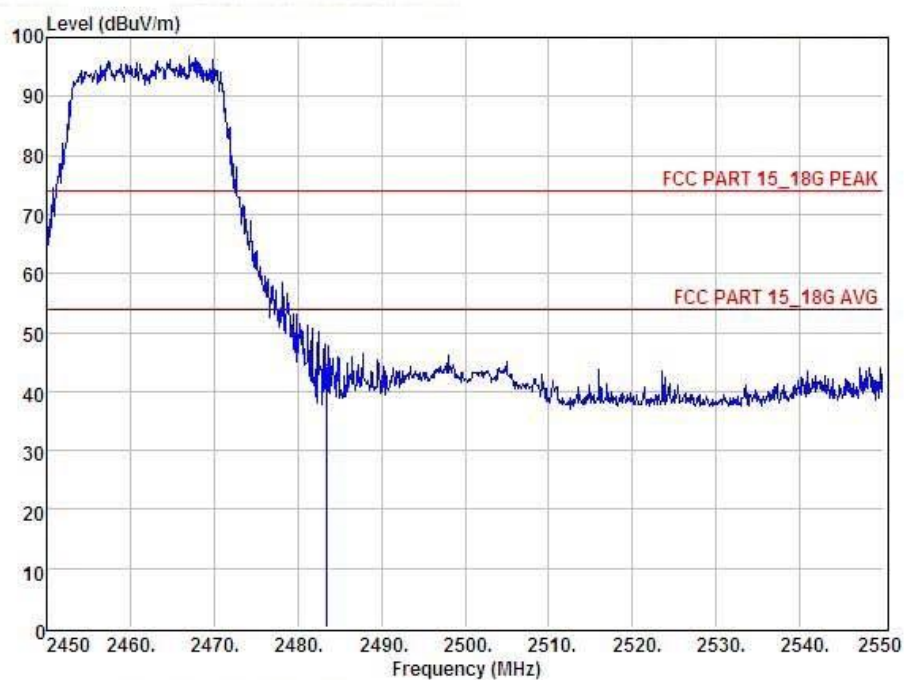

Condition : FCC PART 15\_18G PEAK 3m POL: VERTICAL

Item	Freq MHz	Read Level dBuV	Antenna Factor dB	Preamp Factor dB	Cable Loss dB	Level dBuV	Limit dBuV	Margin dBuV	Remark
1	2483.50	44.96	27.59	34.97	4.00	41.58	74.00	-32.42	Peak

Remark: Level = Read Level + Antenna Factor - Preamp Factor + Cable Loss

Lowest Band edge-Horizontal

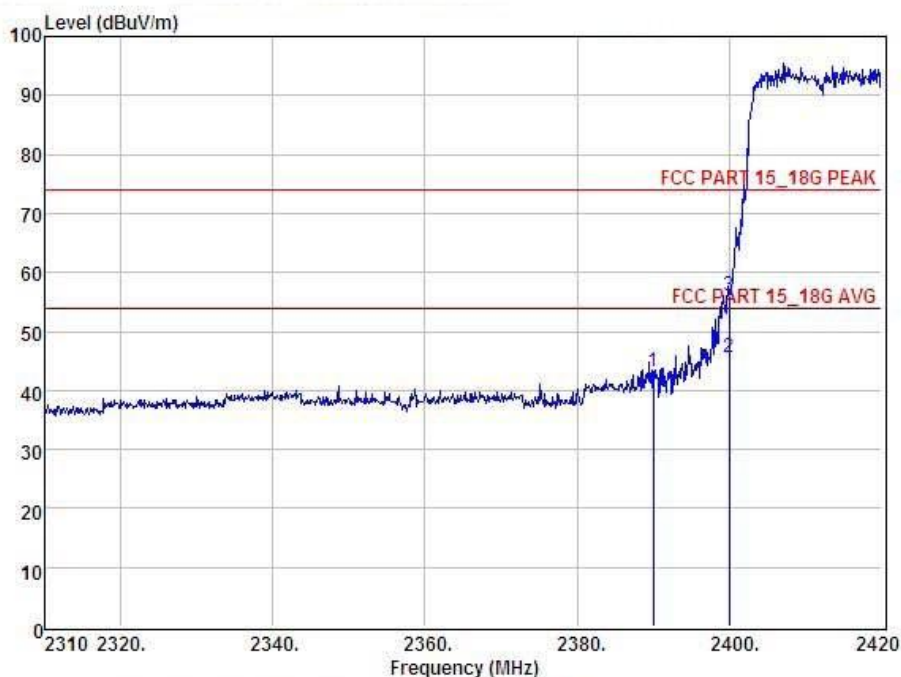

Condition : FCC PART 15\_18G PEAK 3m POL: HORIZONTAL

Item	Freq MHz	Read Level dBuV	Antenna Factor dB	Preamp Factor dB	Cable Loss dB	Level dBuV	Limit dBuV	Margin dBuV	Remark
1	2390.00	46.67	27.62	34.97	3.92	43.24	74.00	-30.76	Peak
2	2400.00	49.12	27.62	34.97	3.94	45.71	54.00	-8.29	Average
3	2400.00	59.49	27.62	34.97	3.94	56.08	74.00	-17.92	Peak

Remark: Level = Read Level + Antenna Factor - Preamp Factor + Cable Loss

High Band edge- Horizontal

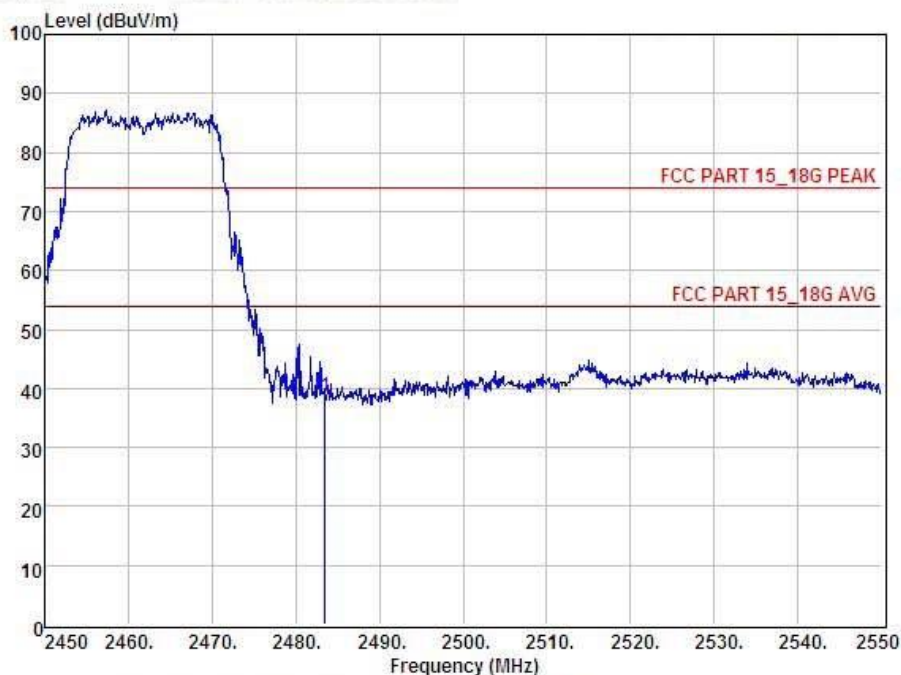

Condition : FCC PART 15\_18G PEAK 3m POL: HORIZONTAL

Item	Freq MHz	Read Level dBuV	Antenna Factor dB	Preamp Factor dB	Cable Loss dB	Level dBuV	Limit dBuV	Margin dBuV	Remark
1	2483.50	42.00	27.59	34.97	4.00	38.62	74.00	-35.38	Peak

Remark: Level = Read Level + Antenna Factor - Preamp Factor + Cable Loss

IEEE 802.11n:HT40  
 Lowest Band edge- Vertical

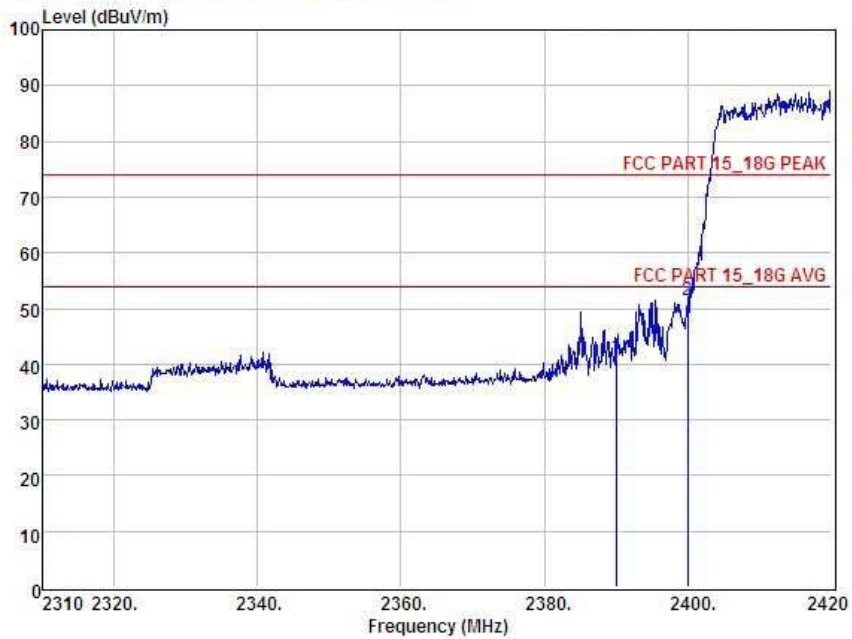

Condition : FCC PART 15\_18G PEAK 3m POL: VERTICAL

Item	Freq MHz	Read Level dBuV	Antenna Factor dB	Preamp Factor dB	Cable Loss dB	Level dBuV	Limit dBuV	Margin dBuV	Remark
1	2390.00	44.71	27.62	34.97	3.92	41.28	74.00	-32.72	Peak
2	2400.00	54.88	27.62	34.97	3.94	51.47	74.00	-22.53	Peak

Remark: Level = Read Level + Antenna Factor - Preamp Factor + Cable Loss

# High Band edge- Vertical

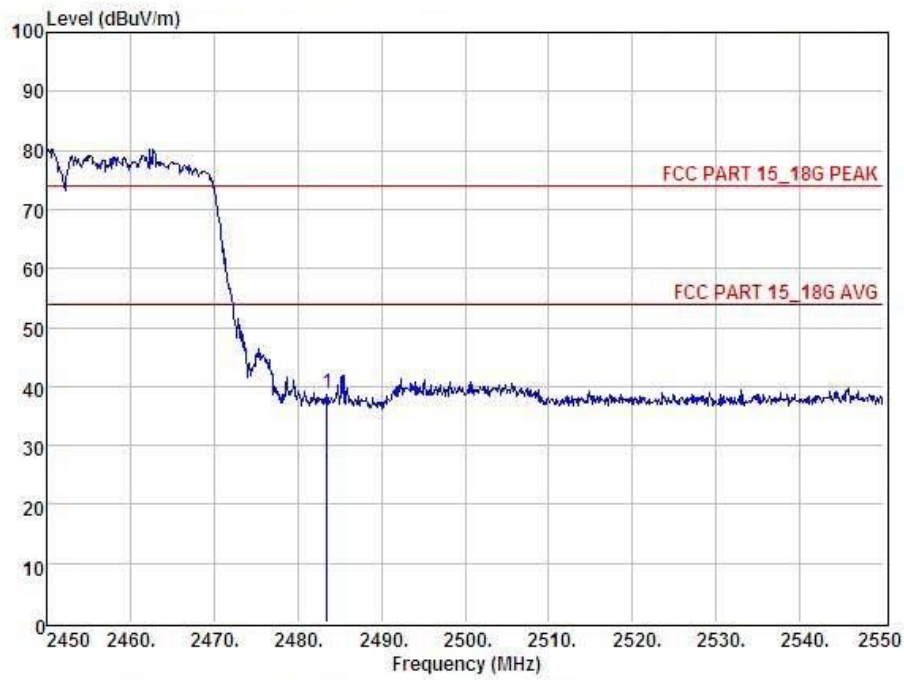

Condition : FCC PART 15_18G PEAK 3m POL: VERTICAL									
Item	Freq	Read	Antenna	Preamp	Cable	Level	Limit	Margin	Remark
	MHz	Level	Factor	Factor	Loss	dBuV	dBuV	dBuV	
		dBuV	dB	dB	dB				
1	2483.50	42.12	27.59	34.97	4.00	38.74	74.00	-35.26	Peak

Remark: Level = Read Level + Antenna Factor - Preamp Factor + Cable Loss

Lowest Band edge-Horizontal

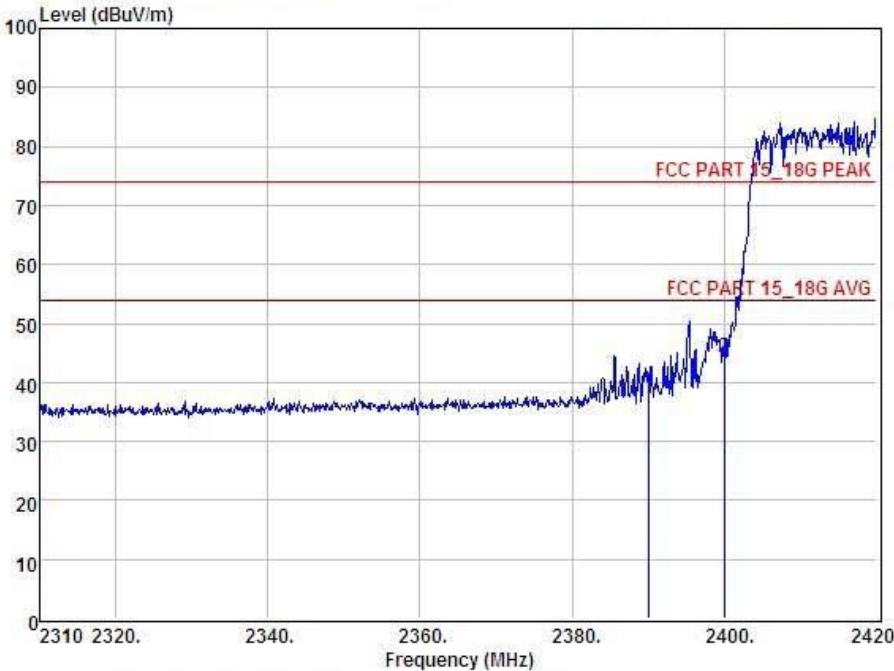

Condition : FCC PART 15\_18G PEAK 3m POL: HORIZONTAL

Item	Freq MHz	Read Level dBuV	Antenna Factor dB	Preamp Factor dB	Cable Loss dB	Level dBuV	Limit dBuV	Margin dBuV	Remark
1	2390.00	41.78	27.62	34.97	3.92	38.35	74.00	-35.65	Peak
2	2400.00	47.64	27.62	34.97	3.94	44.23	74.00	-29.77	Peak

Remark: Level = Read Level + Antenna Factor - Preamp Factor + Cable Loss

High Band edge- Horizontal

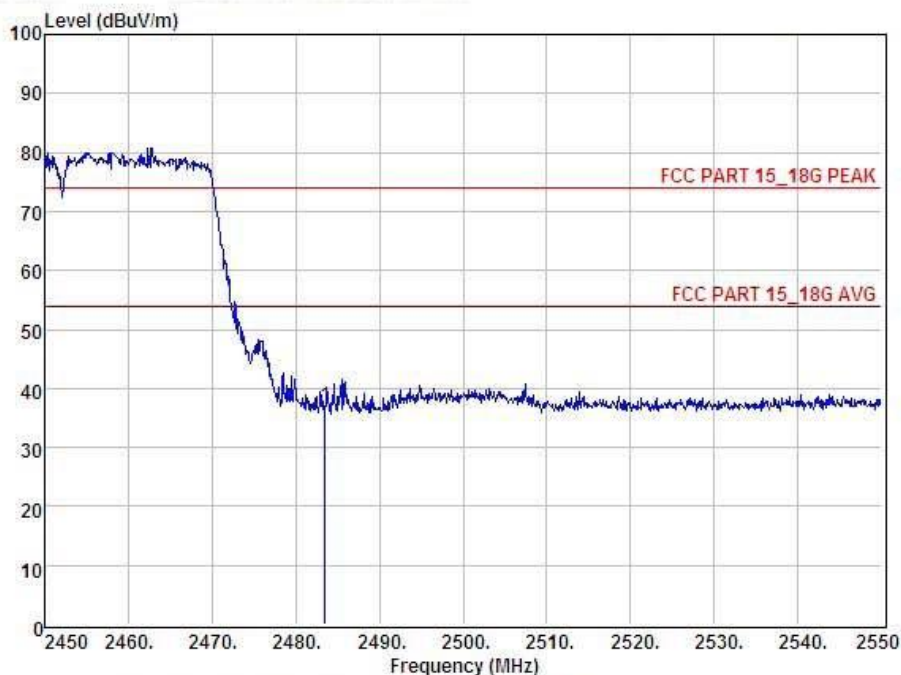

Condition : FCC PART 15\_18G PEAK 3m POL: HORIZONTAL

Item	Freq MHz	Read Level dBuV	Antenna Factor dB	Preamp Factor dB	Cable Loss dB	Level dBuV	Limit dBuV	Margin dBuV	Remark
1	2483.50	40.35	27.59	34.97	4.00	36.97	74.00	-37.03	Peak

Remark: Level = Read Level + Antenna Factor - Preamp Factor + Cable Loss

## 10. Radiated Emission Measurement

### 10.1 Limits of Radiated Emission Measurement

According to §15.247(c), 15.205 15.209(b) &15.35 (b), the field strength of emissions from intentional radiators operated within these frequency bands shall comply with the following:

Section 15.209:

30 - 88 MHz 40 dBuV/m @3M

88 -216 MHz 43.5 dBuV/m @3M

216 -960 MHz 46 dBuV/m @3M

Above 960 MHz 54dBuV/m @3M

The emission limit in this paragraph is based on measurement instrumentation employing an average detector. The provisions in §15.35 for limiting peak emissions apply.

Emissions that fall in the restricted bands (15.205) must be less than 54dBuV/m otherwise the spurious and harmonics must be attenuated by at least 20dB.

### 10.2 EUT Setup

#### Radiated Measurement Setup

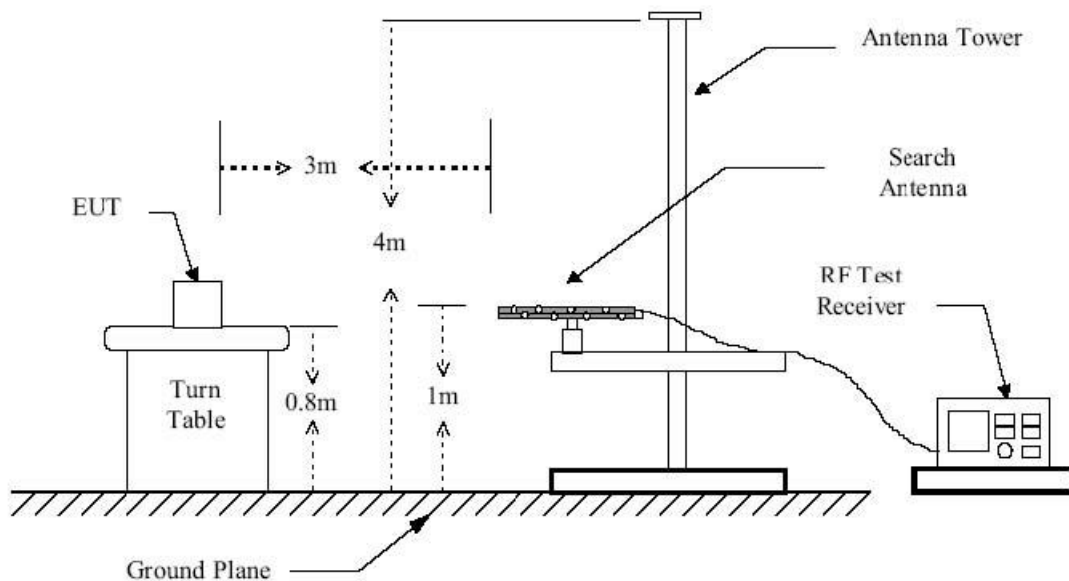

### 10.3 Test Equipment List and Details

See section 2.4.



## 10.4 Test Procedure

1. The EUT was placed on the top of a rotating table 0.8 meters above the ground at a 3 meter semi-anechoic chamber. The table was rotated 360 degrees to determine the position of the

highest radiation.

2. The EUT was set 3 meters away from the interference-receiving antenna, which was mounted on the top of a variable-height antenna tower.

3. The antenna is a broadband antenna, and its height is varied from one meter to four meters above the ground to determine the maximum value of the field strength. Both horizontal and vertical polarizations of the antenna are set to make the measurement.

4. For each suspected emission, the EUT was arranged to its worst case and then the antenna was tuned to heights from 1 meter to 4 meters and the rotatable table was turned from 0 degrees to 360 degrees to find the maximum reading.

5. The test-receiver system was set to Peak Detect Function and Specified Bandwidth with Maximum Hold Mode.

6. If the emission level of the EUT in peak mode was 10 dB lower than the limit specified, then testing could be stopped and the peak values of the EUT would be reported. Otherwise the emissions that did not have 10 dB margin would be re-tested one by one using the quasi-peak method or average method as specified and then reported in Data sheet peak mode and QP mode.

### NOTE:

1. The resolution bandwidth and video bandwidth of test receiver/spectrum analyzer is 120kHz for Quasi-peak detection at frequency below 1GHz.

2. The resolution bandwidth of test receiver/spectrum analyzer is 1 MHz and video bandwidth is 3MHz for Peak detection at frequency above 1GHz.

3. The resolution bandwidth of test receiver/spectrum analyzer is 1 MHz and the video bandwidth is 10Hz for Average detection (AV) at frequency above 1GHz.

## 10.5 Test Result

According to the data below, the FCC Part 15.205, 15.209 and 15.247 standards, and had the worst margin of:

-4.37 dB $\mu$ V at 63.95MHz in the Vertical polarization, with 9KHz to 25 GHz, 3Meters

Note: this EUT was tested in 3 orthogonal positions and the worst case position data was reported.

**From 9KHz to 30MHz: Conclusion: PASS**

**Note:** *The amplitude of spurious emissions which are attenuated by more than 20dB below the permissible value has no need to be reported.*

*The following test mode for the worst mode.*

Spurious Emission From 30 MHz to 1 GHz  
 Horizontal  
 Test mode: Link mode

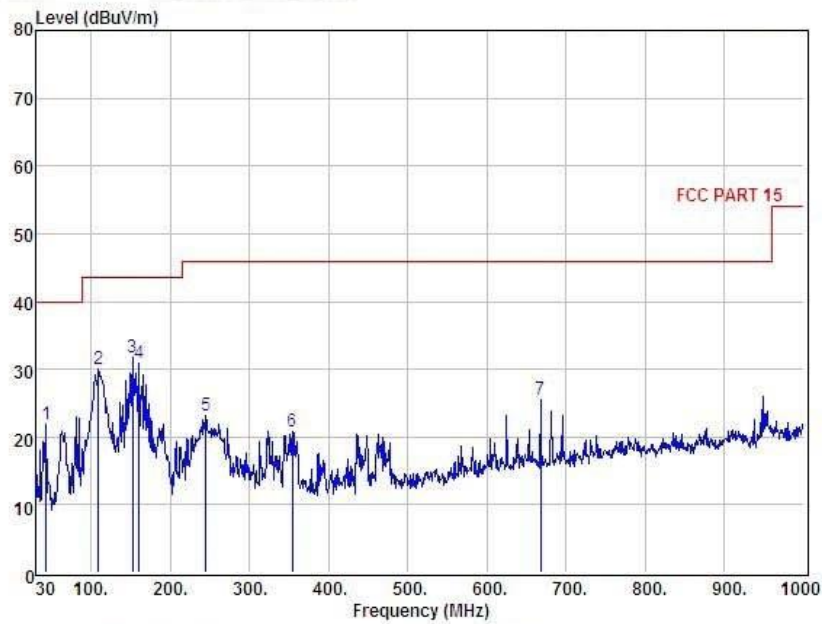

Condition : FCC PART 15 3m POL: HORIZONTAL									
Item	Freq MHz	Read Level dBuV	Antenna Factor dB	Preamp Factor dB	Cable Loss dB	Level dBuV	Limit dBuV	Margin dBuV	Remark
1	43.58	39.21	13.79	31.17	0.09	21.92	40.00	-18.08	QP
2	109.54	49.93	11.13	31.43	0.38	30.01	43.50	-13.49	QP
3	152.22	48.55	14.16	31.43	0.41	31.69	43.50	-11.81	QP
4	160.95	47.67	14.14	31.31	0.46	30.96	43.50	-12.54	QP
5	245.34	41.67	11.52	31.00	0.87	23.06	46.00	-22.94	QP
6	353.98	36.96	13.91	30.65	0.64	20.86	46.00	-25.14	QP
7	667.29	35.60	19.30	30.30	0.96	25.56	46.00	-20.44	QP

Remark: Level = Read Level + Antenna Factor - Preamp Factor + Cable Loss

Vertical  
 Test mode: Link mode

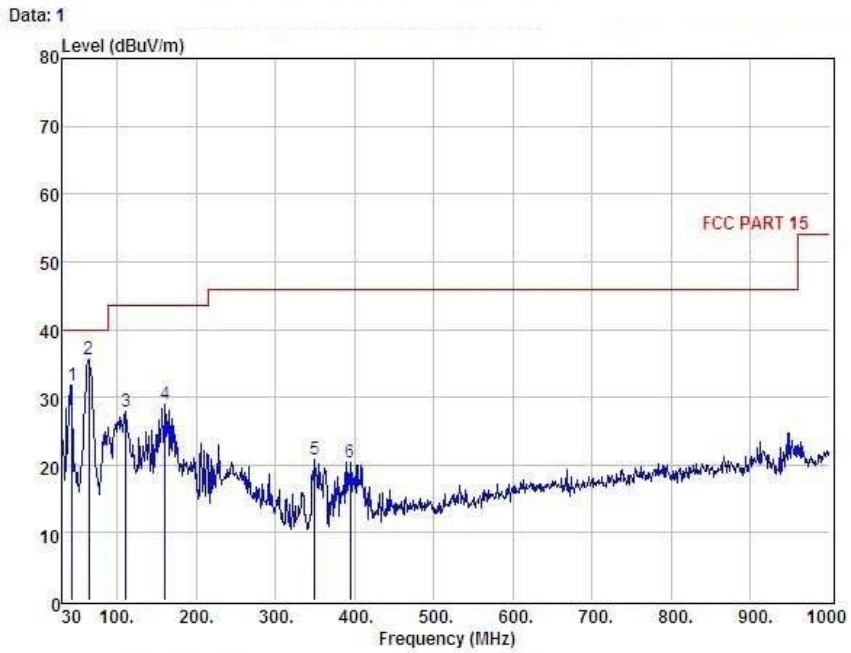

Condition : FCC PART 15									
3m POL: VERTICAL									
Item	Freq	Read	Antenna	Preamp	Cable	Level	Limit	Margin	Remark
	MHz	Level	Factor	Factor	Loss	dBuV	dBuV	dBuV	
		dBuV	dB	dB	dB				
1	43.58	49.09	13.79	31.17	0.09	31.80	40.00	-8.20	QP
2	63.95	54.73	11.98	31.32	0.24	35.63	40.00	-4.37	QP
3	111.48	47.53	11.32	31.40	0.44	27.89	43.50	-15.61	QP
4	160.95	45.66	14.14	31.31	0.46	28.95	43.50	-14.55	QP
5	349.13	36.95	13.80	30.60	0.60	20.75	46.00	-25.25	QP
6	394.72	36.00	14.64	30.86	0.67	20.45	46.00	-25.55	QP

Remark: Level = Read Level + Antenna Factor - Preamp Factor + Cable Loss

## Spurious Emission Above 1GHz For TX mode

For 802.11b

Frequency MHz	Detector	Meter Reading dBuV	Direction Degree	Polar H / V	Antenna Loss dB	Cable loss dB	Amplifier dB	Correction Amplitude dBuV/m	Limit dBuV/m	Margin dB
Low Channel (1G to 25GHz)										
4824.0	PK	48.36	247	V	34.1	5.2	33.0	54.66	74	-19.34
4824.0	PK	50.08	136	H	34.1	5.2	33.0	56.38	74	-17.62
7236.0	PK	45.71	253	V	37.4	6.1	33.5	55.71	74	-18.29
7236.0	PK	45.34	124	H	37.4	6.1	33.5	55.34	74	-18.66
4824.0	AV	36.38	168	V	34.1	5.2	33.0	42.68	54	-11.32
4824.0	AV	36.07	172	H	34.1	5.2	33.0	42.37	54	-11.63
7236.0	AV	31.53	154	V	37.4	6.1	33.5	41.53	54	-12.47
7236.0	AV	32.47	97	H	37.4	6.1	33.5	42.47	54	-11.53
Middle Channel (1G to 25GHz)										
4874.0	PK	47.86	166	V	34.1	5.2	33.0	54.16	74	-19.84
4874.0	PK	49.49	148	H	34.1	5.2	33.0	55.79	74	-18.21
7311.0	PK	43.92	139	V	37.4	6.1	33.5	53.92	74	-20.08
7311.0	PK	44.38	154	H	37.4	6.1	33.5	54.38	74	-19.62
4874.0	AV	35.56	128	V	34.1	5.2	33.0	41.86	54	-12.14
4874.0	AV	35.85	174	H	34.1	5.2	33.0	42.15	54	-11.85
7311.0	AV	31.63	153	V	37.4	6.1	33.5	41.63	54	-12.37
7311.0	AV	32.51	183	H	37.4	6.1	33.5	42.51	54	-11.49
High Channel (1G to 25GHz)										
4924.0	PK	48.23	147	V	34.1	5.2	33.0	54.53	74	-19.47
4924.0	PK	47.49	189	H	34.1	5.2	33.0	53.79	74	-20.21
7386.0	PK	45.56	243	V	37.4	6.1	33.5	55.56	74	-18.44
7386.0	PK	44.87	257	H	37.4	6.1	33.5	54.87	74	-19.13
4924.0	AV	35.24	183	V	34.1	5.2	33.0	41.54	54	-12.46
4924.0	AV	35.85	172	H	34.1	5.2	33.0	42.15	54	-11.85
7386.0	AV	32.58	104	V	37.4	6.1	33.5	42.58	54	-11.42
7386.0	AV	32.62	121	H	37.4	6.1	33.5	42.62	54	-11.38

Note: Testing is carried out with frequency rang 30MHz to the tenth harmonics, which above 5<sup>th</sup> Harmonics is close to the noise base even antenna close up to 1meter distance according the measurement of ANSI C63.4.

For 802.11g

Frequency MHz	Detector	Meter Reading dBuV	Direction Degree	Polar H / V	Antenna Loss dB	Cable loss dB	Amplifier dB	Correction Amplitude dBuV/m	Limit dBuV/m	Margin dB
Low Channel (1G to 25GHz)										
4824.0	PK	49.03	196	V	34.1	5.2	33.0	55.33	74	-18.67
4824.0	PK	48.27	147	H	34.1	5.2	33.0	54.57	74	-19.43
7236.0	PK	44.92	132	V	37.4	6.1	33.5	54.92	74	-19.08
7236.0	PK	43.86	158	H	37.4	6.1	33.5	53.86	74	-20.14
4824.0	AV	35.43	209	V	34.1	5.2	33.0	41.73	54	-12.27
4824.0	AV	36.34	244	H	34.1	5.2	33.0	42.64	54	-11.36
7236.0	AV	31.47	235	V	37.4	6.1	33.5	41.47	54	-12.53
7236.0	AV	32.13	212	H	37.4	6.1	33.5	42.13	54	-11.87
Middle Channel (1G to 25GHz)										
4874.0	PK	48.04	158	V	34.1	5.2	33.0	54.34	74	-19.66
4874.0	PK	47.45	154	H	34.1	5.2	33.0	53.75	74	-20.25
7311.0	PK	45.55	136	V	37.4	6.1	33.5	55.55	74	-18.45
7311.0	PK	44.62	127	H	37.4	6.1	33.5	54.62	74	-19.38
4874.0	AV	35.54	166	V	34.1	5.2	33.0	41.84	54	-12.16
4874.0	AV	35.96	148	H	34.1	5.2	33.0	42.26	54	-11.74
7311.0	AV	31.42	216	V	37.4	6.1	33.5	41.42	54	-12.58
7311.0	AV	32.63	49	H	37.4	6.1	33.5	42.63	54	-11.37
High Channel (1G to 25GHz)										
4924.0	PK	48.16	137	V	34.1	5.2	33.0	54.46	74	-19.54
4924.0	PK	47.42	128	H	34.1	5.2	33.0	53.72	74	-20.28
7386.0	PK	45.57	175	V	37.4	6.1	33.5	55.57	74	-18.43
7386.0	PK	44.38	149	H	37.4	6.1	33.5	54.38	74	-19.62
4924.0	AV	35.51	162	V	34.1	5.2	33.0	41.81	54	-12.19
4924.0	AV	36.35	188	H	34.1	5.2	33.0	42.65	54	-11.35
7386.0	AV	32.26	218	V	37.4	6.1	33.5	42.26	54	-11.74
7386.0	AV	31.92	244	H	37.4	6.1	33.5	41.92	54	-12.08

Note: Testing is carried out with frequency rang 30MHz to the tenth harmonics, which above 5<sup>th</sup> Harmonics is close to the noise base even antenna close up to 1meter distance according the measurement of ANSI C63.4.

For 802.11n/HT20

Frequency MHz	Detector	Meter Reading dBuV	Direction Degree	Polar H / V	Antenna Loss dB	Cable loss dB	Amplifier dB	Correction Amplitude dBuV/m	Limit dBuV/m	Margin dB
Low Channel (1G to 25GHz)										
4824.0	PK	48.07	237	V	34.1	5.2	33.0	54.37	74	-19.63
4824.0	PK	48.63	284	H	34.1	5.2	33.0	54.93	74	-19.07
7236.0	PK	43.57	356	V	37.4	6.1	33.5	53.57	74	-20.43
7236.0	PK	45.91	41	H	37.4	6.1	33.5	55.91	74	-18.09
4824.0	AV	35.45	79	V	34.1	5.2	33.0	41.75	54	-12.25
4824.0	AV	36.33	159	H	34.1	5.2	33.0	42.63	54	-11.37
7236.0	AV	31.51	213	V	37.4	6.1	33.5	41.51	54	-12.49
7236.0	AV	32.17	264	H	37.4	6.1	33.5	42.17	54	-11.83
Middle Channel (1G to 25GHz)										
4874.0	PK	47.76	287	V	34.1	5.2	33.0	54.06	74	-19.94
4874.0	PK	48.33	294	H	34.1	5.2	33.0	54.63	74	-19.37
7311.0	PK	43.18	152	V	37.4	6.1	33.5	53.18	74	-20.82
7311.0	PK	44.37	148	H	37.4	6.1	33.5	54.37	74	-19.63
4874.0	AV	34.96	173	V	34.1	5.2	33.0	41.26	54	-12.74
4874.0	AV	36.62	179	H	34.1	5.2	33.0	42.92	54	-11.08
7311.0	AV	32.33	256	V	37.4	6.1	33.5	42.33	54	-11.67
7311.0	AV	31.81	235	H	37.4	6.1	33.5	41.81	54	-12.19
High Channel (1G to 25GHz)										
4924.0	PK	48.12	283	V	34.1	5.2	33.0	54.42	74	-19.58
4924.0	PK	47.25	237	H	34.1	5.2	33.0	53.55	74	-20.45
7386.0	PK	44.33	126	V	37.4	6.1	33.5	54.33	74	-19.67
7386.0	PK	44.56	95	H	37.4	6.1	33.5	54.56	74	-19.44
4924.0	AV	35.57	158	V	34.1	5.2	33.0	41.87	54	-12.13
4924.0	AV	35.98	164	H	34.1	5.2	33.0	42.28	54	-11.72
7386.0	AV	31.94	307	V	37.4	6.1	33.5	41.94	54	-12.06
7386.0	AV	32.17	289	H	37.4	6.1	33.5	42.17	54	-11.83

Note: Testing is carried out with frequency rang 30MHz to the tenth harmonics, which above 5<sup>th</sup> Harmonics is close to the noise base even antenna close up to 1meter distance according the measurement of ANSI C63.4.

For 802.11n/HT40

Frequency MHz	Detector	Meter Reading dBuV	Direction Degree	Polar H / V	Antenna Loss dB	Cable loss dB	Amplifier dB	Correction Amplitude dBuV/m	Limit dBuV/m	Margin dB
Low Channel (1G to 25GHz)										
4844.0	PK	46.92	237	V	34.1	5.2	33.0	53.22	74	-20.78
4844.0	PK	47.44	284	H	34.1	5.2	33.0	53.74	74	-20.26
7266.0	PK	44.26	356	V	37.4	6.1	33.5	54.26	74	-19.74
7266.0	PK	45.43	41	H	37.4	6.1	33.5	55.43	74	-18.57
4844.0	AV	35.64	79	V	34.1	5.2	33.0	41.94	54	-12.06
4844.0	AV	36.31	159	H	34.1	5.2	33.0	42.61	54	-11.39
7266.0	AV	32.18	213	V	37.4	6.1	33.5	42.18	54	-11.82
7266.0	AV	33.42	264	H	37.4	6.1	33.5	43.42	54	-10.58
Middle Channel (1G to 25GHz)										
4874.0	PK	47.72	287	V	34.1	5.2	33.0	54.02	74	-19.98
4874.0	PK	47.23	294	H	34.1	5.2	33.0	53.53	74	-20.47
7311.0	PK	44.97	152	V	37.4	6.1	33.5	54.97	74	-19.03
7311.0	PK	45.41	148	H	37.4	6.1	33.5	55.41	74	-18.59
4874.0	AV	36.06	173	V	34.1	5.2	33.0	42.36	54	-11.64
4874.0	AV	35.42	179	H	34.1	5.2	33.0	41.72	54	-12.28
7311.0	AV	32.24	256	V	37.4	6.1	33.5	42.24	54	-11.76
7311.0	AV	32.17	235	H	37.4	6.1	33.5	42.17	54	-11.83
High Channel (1G to 25GHz)										
4904.0	PK	49.26	283	V	34.1	5.2	33.0	55.56	74	-18.44
4904.0	PK	48.33	237	H	34.1	5.2	33.0	54.63	74	-19.37
7356.0	PK	43.82	126	V	37.4	6.1	33.5	53.82	74	-20.18
7356.0	PK	44.53	95	H	37.4	6.1	33.5	54.53	74	-19.47
4904.0	AV	35.33	158	V	34.1	5.2	33.0	41.63	54	-12.37
4904.0	AV	35.85	164	H	34.1	5.2	33.0	42.15	54	-11.85
7356.0	AV	32.26	307	V	37.4	6.1	33.5	42.26	54	-11.74
7356.0	AV	31.71	289	H	37.4	6.1	33.5	41.71	54	-12.29

Note: Testing is carried out with frequency rang 30MHz to the tenth harmonics, which above 5<sup>th</sup> Harmonics is close to the noise base even antenna close up to 1meter distance according the measurement of ANSI C63.4.