



Test Report

Report No.: MTi220324012-05E1
Date of issue: 2022-08-22
Applicant: Shenzhen Smart-eye Digital Electronics Co., Ltd
Product name: IPCAM
Model(s): Y1(763), Y2(795), Q7(639), G3, R11, R12, 640, 641, 642, 764
FCC ID: ZCB-Y1

Shenzhen Microtest Co., Ltd.
<http://www.mtitest.com>

Instructions

1. The report shall not be partially reproduced without the written consent of the laboratory;
2. The test results of this report are only responsible for the samples submitted;
3. This report is invalid without the seal and signature of the laboratory;
4. This report is invalid if transferred, altered or tampered with in any form without authorization;
5. Any objection to this report shall be submitted to the laboratory within 15 days from the date of receipt of the report.

Table of Contents

1	GENERAL INFORMATION	6
1.1	DESCRIPTION OF EUT	6
1.2	OPERATION CHANNEL LIST	7
1.3	TEST CHANNEL LIST	7
1.4	ANCILLARY EQUIPMENT LIST	7
1.5	DESCRIPTION OF SUPPORT UNITS	8
2	SUMMARY OF TEST RESULTS	9
3	TEST FACILITIES AND ACCREDITATIONS	10
3.1	TEST LABORATORY	10
3.2	ENVIRONMENTAL CONDITIONS	10
3.3	MEASUREMENT UNCERTAINTY	10
3.4	TEST SOFTWARE	10
4	EQUIPMENT LIST	11
5	TEST RESULT	12
5.1	ANTENNA REQUIREMENT	12
5.1.1	<i>Standard requirement</i>	12
5.1.2	<i>EUT antenna</i>	12
5.2	PEAK OUTPUT POWER	13
5.2.1	<i>Limit</i>	13
5.2.2	<i>Test setup</i>	13
5.2.3	<i>Test procedure</i>	13
5.2.4	<i>Test results</i>	14
5.3	POWER SPECTRAL DENSITY	15
5.3.1	<i>Limit</i>	15
5.3.2	<i>Test setup</i>	15
5.3.3	<i>Test procedure</i>	15
5.3.4	<i>Test results</i>	16
5.4	CONDUCTED EMISSION	19
5.4.1	<i>Limits</i>	19
5.4.2	<i>Test setup</i>	19
5.4.3	<i>Test procedure</i>	20
5.4.4	<i>Test results</i>	20
5.5	RADIATED SPURIOUS	23
5.5.1	<i>Limits</i>	23
5.5.2	<i>Test setup</i>	24
5.5.3	<i>Test procedure</i>	25
5.5.4	<i>Test results</i>	26
5.5.4.1	<i>Radiation emission</i>	26
5.5.4.2	<i>Band edge - radiated</i>	31
5.6	BAND EDGE - CONDUCTED	32
5.6.1	<i>Limits</i>	32
5.6.2	<i>Test setup</i>	32
5.6.3	<i>Test procedure</i>	32
5.6.4	<i>Test results</i>	33
5.7	6DB BANDWIDTH	36
5.7.1	<i>Limit</i>	36
5.7.2	<i>Test setup</i>	36
5.7.3	<i>Test procedure</i>	36
5.7.4	<i>Test results</i>	36
5.8	DUTY CYCLE	43
5.8.1	<i>Limit</i>	43
5.8.2	<i>Measuring instruments</i>	43



5.8.3	Test setup	43
5.8.4	Test procedure.....	43
5.8.5	Test Results.....	44
5.9	SPURIOUS RF CONDUCTED EMISSIONS	45
5.9.1	Limit	45
5.9.2	Measuring instruments	45
5.9.3	Test setup	45
5.9.4	Test procedure.....	45
5.9.5	Test results	45
PHOTOGRAPHS OF THE TEST SETUP		48
PHOTOGRAPHS OF THE EUT.....		50

TEST RESULT CERTIFICATION	
Applicant's name.....	Shenzhen Smart-eye Digital Electronics Co., Ltd
Address.....	2F, Block 1, Shangrong Industrial Zone, No.2 Baolong Road 5, Longgang, Shenzhen, China
Manufacturer's Name.....	Shenzhen Smart-eye Digital Electronics Co., Ltd
Address.....	2F, Block 1, Shangrong Industrial Zone, No.2 Baolong Road 5, Longgang, Shenzhen, China
Product description	
Product name.....	IPCAM
Trademark.....	galayou; wansview
Model Name.....	Y1(763)
Serial Model.....	Y2(795), Q7(639), G3, R11, R12, 640, 641, 642, 764
Standards.....	FCC Part 15.247
Test procedure.....	ANSI C63.10-2013 KDB 558074 D01 D15.247 Meas Guidance v05r02
Date of Test	
Date (s) of performance of tests.....:	2022-05-13 ~ 2022-08-16
Test Result.....:	Pass
This device described above has been tested by Shenzhen Microtest Co., Ltd. and the test results show that the equipment under test (EUT) is in compliance with the FCC requirements. And it is applicable only to the tested sample identified in the report.	

Testing Engineer

:



 (Eugene Qiu)

Technical Manager

:

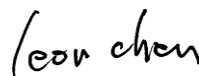

 (Leon Chen)

Authorized Signatory

:



 (Tom Xue)

1 General information

1.1 Description of EUT

Product name:	IPCAM
Model name:	Y1(763)
Serial model:	Y2(795), Q7(639), G3, R11, R12, 640, 641, 642, 764
Model difference:	All the models are the same circuit and module, except the model name.
Operation frequency:	802.11b/g/n20:2412~2462 MHz
Modulation type:	IEEE 802.11b : DSSS (DBPSK, DQPSK, CCK) IEEE 802.11g/n (HT20) : OFDM (64QAM, 16QAM, QPSK, BPSK)
Bit Rate of transmitter:	802.11b:11/5.5/2/1 Mbps 802.11g:54/48/36/24/18/12/9/6Mbps 802.11n(20MHz) use 800 ns GI: 65.0/58.5/52.0/39.0/26.0/19.5/13.0/6.5 Mbps (MCS0~MCS7)
Antenna type:	External Antenna
Antenna gain:	3dBi
Max. output power:	14.28dBm
Power supply:	Input: DC 5V/1A
Adapter information:	Adapter: Model: G006A0501000U Input: 100-240V~ 50/60Hz 0.3A Output: 5V=1A
Hardware version:	V1.0
Software version:	V1.0
Serial number:	MTi220324012-05-S0001

1.2 Operation channel list

Channel List for 802.11b/g/n (20)

Channel	Frequency (MHz)	Channel	Frequency (MHz)
01	2412	07	2442
02	2417	08	2447
03	2422	09	2452
04	2427	10	2457
05	2432	11	2462
06	2437	\	\

1.3 Test channel list

Channel List for 802.11b/g/n (20)

Channel	Channel	Frequency (MHz)
Low	01	2412
Middle	06	2437
High	11	2462

1.4 Ancillary equipment list

Equipment	Model	S/N	Manufacturer
Mobile phone	Mate 30	/	HUAWEI

1.5 Description of Support Units

The EUT has been tested as an independent unit together with other necessary accessories or support units. The following support units or accessories were used to form a representative test configuration during the tests.

Item	Equipment	Brand	Model/Type No.	Series No.	Note
/	/	/	/	/	/
/	/	/	/	/	/

Note:

- (1) The support equipment was authorized by Declaration of Confirmation.
- (2) For detachable type I/O cable should be specified the length in cm in 『Length』 column.

2 Summary of Test Results

Test procedures according to the technical standards:

No.	Standard Section	Test Item	Result	Remark
1	15.203	Antenna Requirement	Pass	
2	15.247 (b)	Peak Output Power	Pass	
3	15.247 (e)	Power Spectral Density	Pass	
4	15.207	Conducted Emission	Pass	
5	15.247 (d) & 15.209	Radiated Spurious Emission	Pass	
6	15.205	Band Edge Emission	Pass	
7	15.247 (a)(2)	6dB Bandwidth	Pass	
8	558074 D01 15.247 Meas Guidance v05r02 Chapter 6	Duty Cycle	Pass	
9	15.247(d)	Spurious RF Conducted Emissions	Pass	

3 Test Facilities and Accreditations

3.1 Test laboratory

Test Laboratory	Shenzhen Microtest Co., Ltd
Location	101, No. 7, Zone 2, Xinxing Industrial Park, Fuhai Avenue, Xinhe Community, Fuhai Street, Bao'an District, Shenzhen, Guangdong, China.
FCC Registration No.:	448573

3.2 Environmental conditions

Temperature:	15°C~35°C
Humidity	20%~75%
Atmospheric pressure	98kPa~101kPa

3.3 Measurement uncertainty

The reported uncertainty of measurement $y \pm U$ where expanded uncertainty U is based on a standard uncertainty multiplied by a coverage factor of $k=2$ providing a level of confidence of approximately 95 %

No.	Item	Uncertainty
1	Conducted Emission Test	$\pm 1.38\text{dB}$
2	RF power, conducted	$\pm 0.16\text{dB}$
3	Spurious emissions, conducted	$\pm 0.21\text{dB}$
4	All emissions, radiated(<1G)	$\pm 4.68\text{dB}$
5	All emissions, radiated(>1G)	$\pm 4.89\text{dB}$
6	Temperature	$\pm 0.5^\circ\text{C}$
7	Humidity	$\pm 2\%$

3.4 Test software

Software Name	Manufacturer	Model	Version
Bluetooth and WiFi Test System	Shenzhen JS tonskend co., ltd	JS1120-3	2.5.77.0418

4 Equipment list

Equipment No.	Equipment Name	Manufacturer	Model	Serial No.	Calibration date	Due date
MTI-E043	EMI Test Receiver	Rohde&schwarz	ESCI7	101166	2022/05/05	2023/05/04
MTI-E044	TRILOG Broadband Antenna	schwarzbeck	VULB 9163	9163-1338	2021/05/30	2023/05/29
MTI-E047	Amplifier	Hewlett-Packard	8447F	3113A06150	2022/05/05	2023/05/04
MTI-E089	ESG Vector Signal Generator	Agilent	N5182A	MY49060455	2022/05/05	2023/05/04
MTI-E058	ESG Series Analog Ssignal Generator	Agilent	E4421B	GB40051240	2022/05/05	2023/05/04
MTI-E062	PXA Signal Analyzer	Agilent	N9030A	MY51350296	2022/05/05	2023/05/04
MTI-E066	MXA Signal Analyzer	Agilent	N9020A	MY50143483	2022/05/05	2023/05/04
MTi-E067	RF Control Unit	Tonscend	JS0806-1	19D8060152	2022/05/05	2023/05/04
MTI-E078	Synthesized Sweeper	Agilent	83752A	3610A01957	2022/05/05	2023/05/04
MTI-E079	DC Power Supply	Agilent	E3632A	MY40027695	2022/05/05	2023/05/04
MTI-E045	Double Ridged Broadband Horn Antenna	schwarzbeck	BBHA 9120D	9120D-2278	2021/05/30	2023/05/29
MTI-E021	EMI Test Receiver	Rohde&schwarz	ESCS30	100210	2022/05/05	2023/05/04
MTI-E022	Pulse Limiter	Schwarzbeck	VSTD 9561-F	00679	2022/05/05	2023/05/04
MTI-E023	Artificial mains network	Schwarzbeck	NSLK 8127	NSLK 8127 #841	2022/05/05	2023/05/04
MTI-E046	Active Loop Antenna	Schwarzbeck	FMZB 1519B	00044	2021/05/30	2023/05/29
MTI-E048	Amplifier	Agilent	8449B	3008A02400	2022/05/05	2023/05/04
MTI-E072	Thermometer Clock Humidity Monitor	-	HTC-1	/	2022/05/05	2023/05/04
Note: the calibration interval of the above test instruments is 12 or 24 months and the calibrations are traceable to international system unit (SI).						

5 Test Result

5.1 Antenna requirement

5.1.1 Standard requirement

15.203 requirement: For intentional device, according to 15.203: an intentional radiator shall be designed to ensure that no antenna other than that furnished by the responsible party shall be used with the device

5.1.2 EUT antenna

The EUT antenna is External antenna (3dBi). It comply with the standard requirement. In case of replacement of broken antenna the same antenna type must be used.

5.2 Peak output power

5.2.1 Limit

Section	Test Item	Limit	Frequency Range (MHz)
15.247(b)(3)	Peak output power	1 watt or 30dBm	2400-2483.5

5.2.2 Test setup

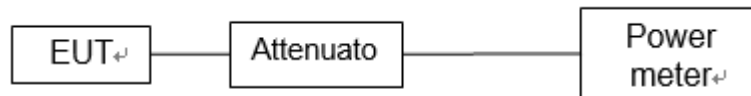

5.2.3 Test procedure

The EUT was directly connected to the Power meter.

5.2.4 Test results
802.11b

Test Channel	Frequency (MHz)	Maximum Peak Conducted Output Power(dBm)	Limit (dBm)
CH01	2412	14.28	30
CH06	2437	13.76	30
CH11	2462	12.01	30

802.11g

Test Channel	Frequency (MHz)	Maximum Peak Conducted Output Power(dBm)	Limit (dBm)
CH01	2412	13.32	30
CH06	2437	12.62	30
CH11	2462	10.94	30

802.11n20

Test Channel	Frequency (MHz)	Maximum Peak Conducted Output Power(dBm)	Limit (dBm)
CH01	2412	11.95	30
CH06	2437	11.31	30
CH11	2462	9.72	30

5.3 Power spectral density

5.3.1 Limit

Section	Test Item	Limit	Frequency Range (MHz)
15.247(e)	Power Spectral Density	8 dBm (in any 3kHz)	2400-2483.5

5.3.2 Test setup



5.3.3 Test procedure

- a. The EUT tested system was configured as the statements of 2.1 unless otherwise a special operating condition is specified in the follows during the testing.
- b. Set analyzer center frequency to DTS channel center frequency.
- c. Set the span to 1.5 times the DTS channel bandwidth.
- d. Set the RBW ≥ 3 kHz.
- e. Set the VBW $\geq 3 \times$ RBW.
- f. Detector = peak.
- g. Sweep time = auto couple.
- h. Trace mode = max hold.
- i. Allow trace to fully stabilize.
- j. Use the peak marker function to determine the maximum amplitude level.
- k. If measured value exceeds limit, reduce RBW (no less than 3 kHz) and repeat.

5.3.4 Test results

802.11b			
Frequency	Power Density (dBm/3kHz)	Limit (dBm/3kHz)	Result
2412 MHz	-9.45	8	Pass
2437 MHz	-9.51	8	Pass
2462 MHz	-11.11	8	Pass

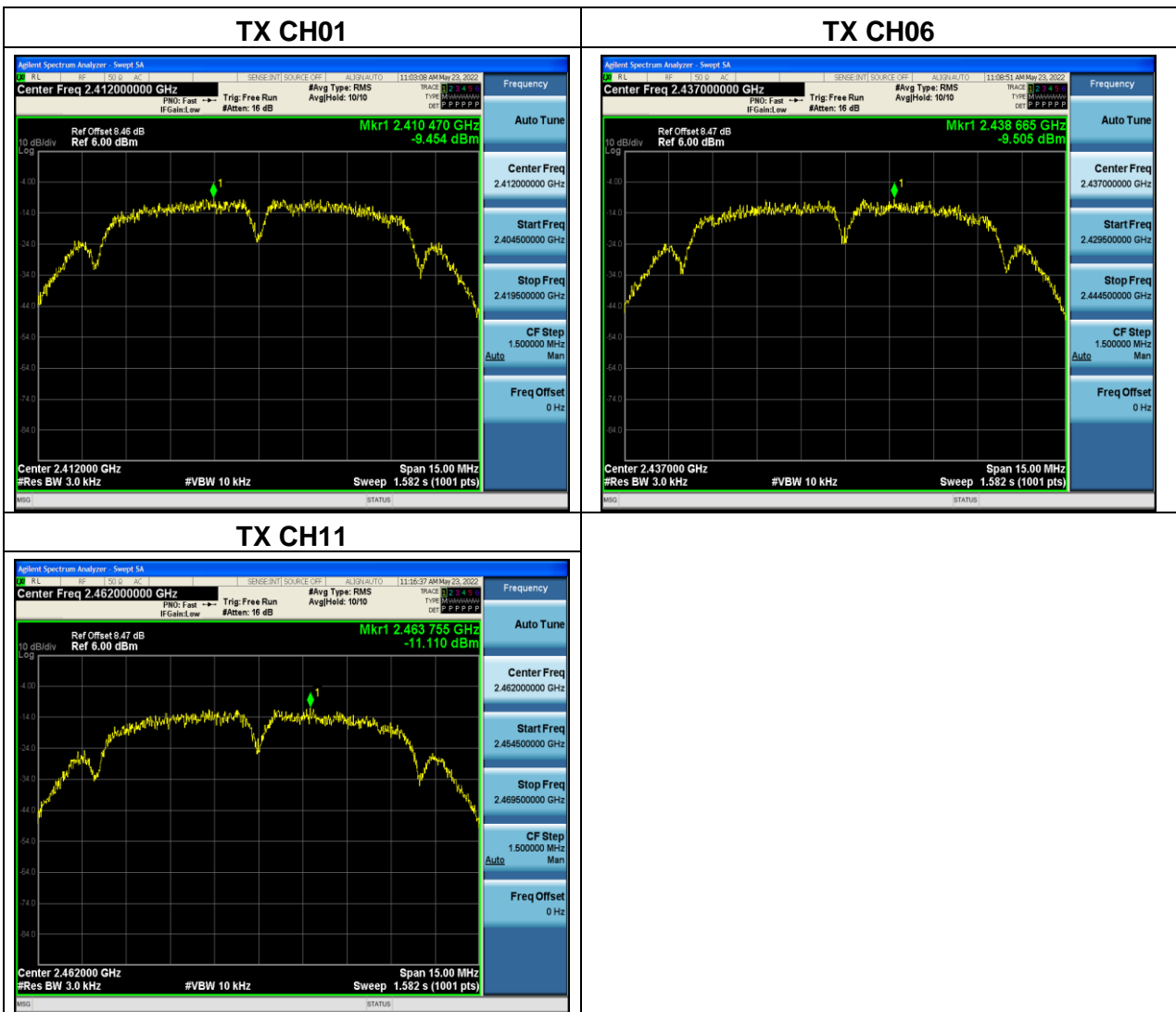

802.11g			
Frequency	Power Density (dBm/3kHz)	Limit (dBm/3kHz)	Result
2412 MHz	-12.27	8	Pass
2437 MHz	-12.26	8	Pass
2462 MHz	-13.53	8	Pass

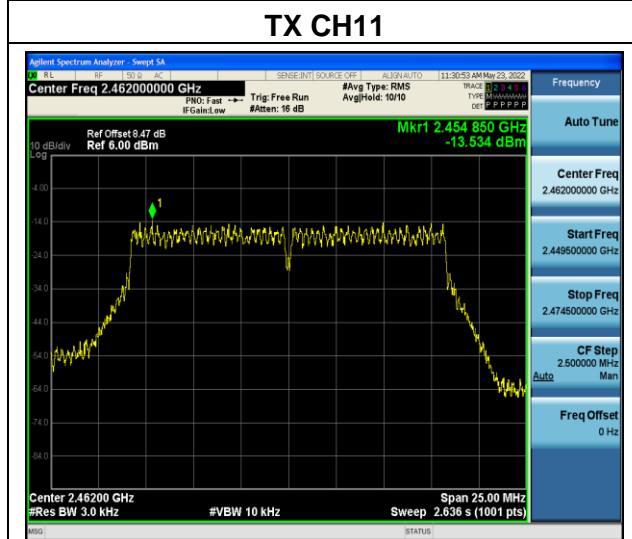
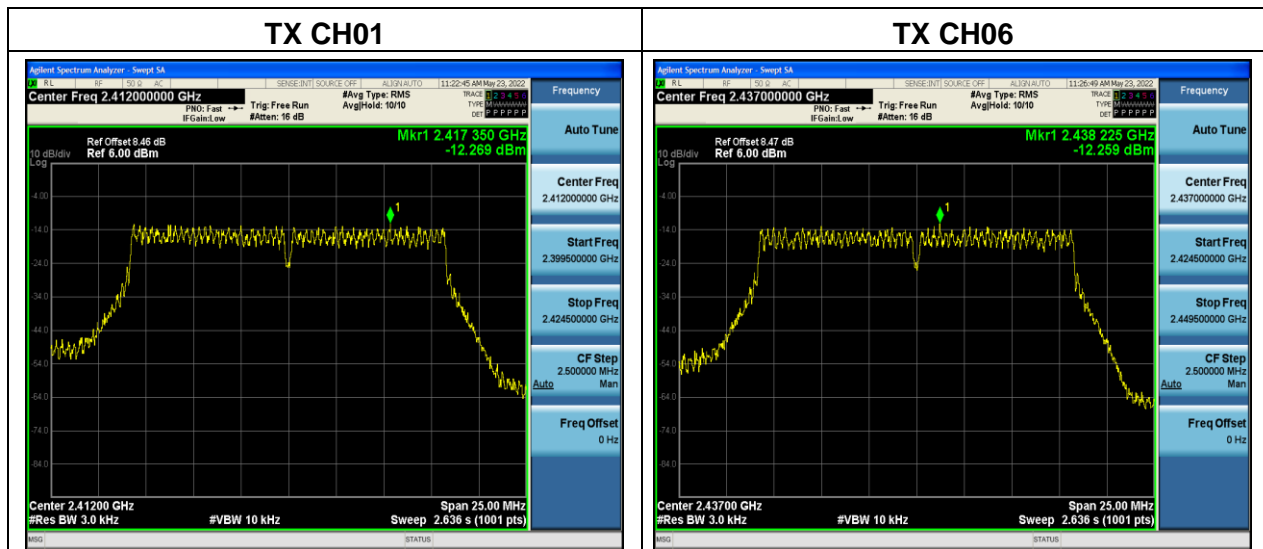

802.11n20			
Frequency	Power Density (dBm/3kHz)	Limit (dBm/3kHz)	Result
2412 MHz	-13.59	8	Pass
2437 MHz	-13.26	8	Pass
2462 MHz	-15.39	8	Pass

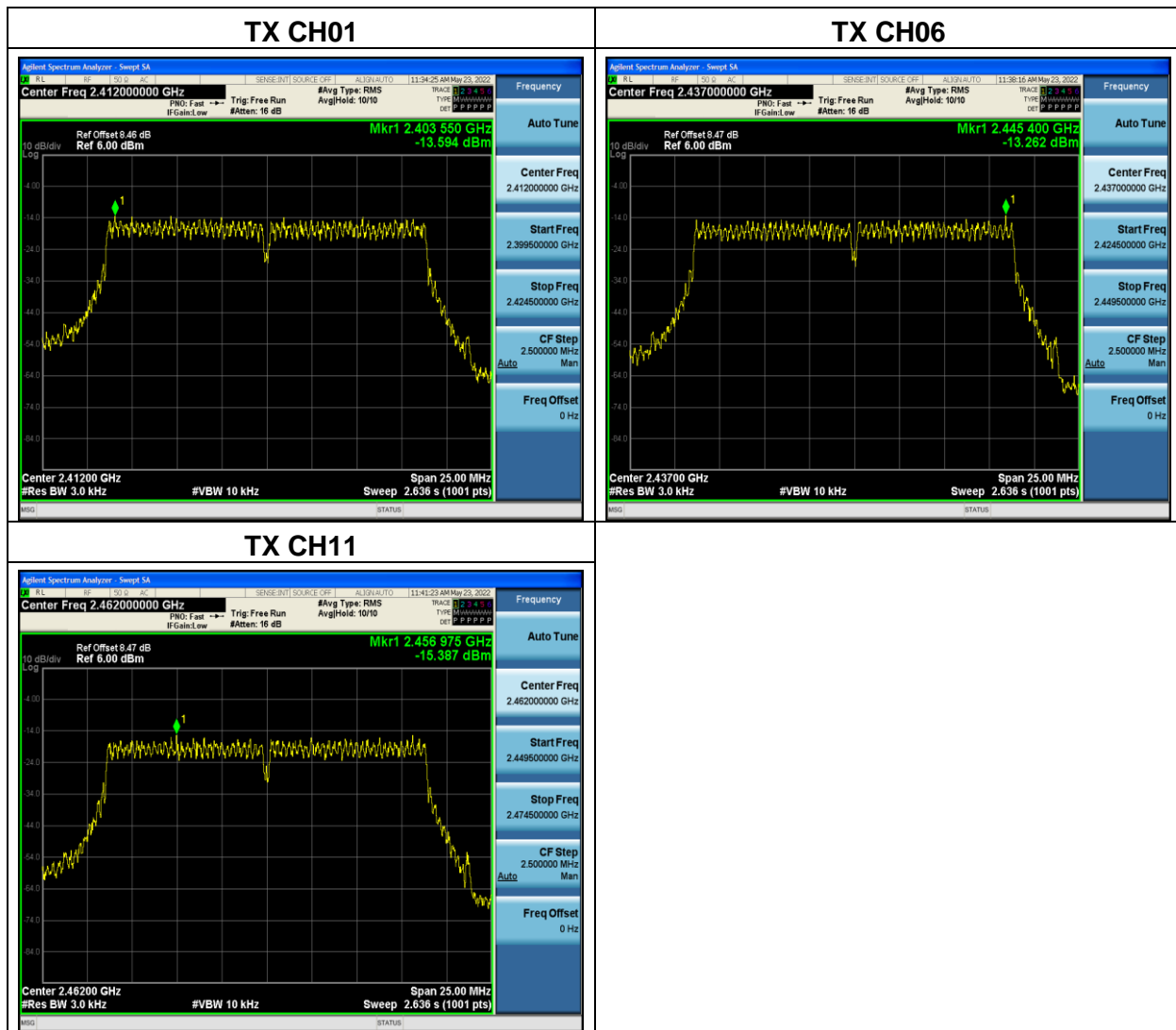

5.4 Conducted emission

5.4.1 Limits

According to FCC Part 15.207(a) and KDB 174176 D01 Line Conducted FAQ v01r01.

FREQUENCY (MHz)	Class B (dBuV)	
	Quasi-peak	Average
0.15 -0.5	66 - 56 *	56 - 46 *
0.50 -5.0	56.00	46.00
5.0 -30.0	60.00	50.00

Note: *Decreases with the logarithm of the frequency..

5.4.2 Test setup

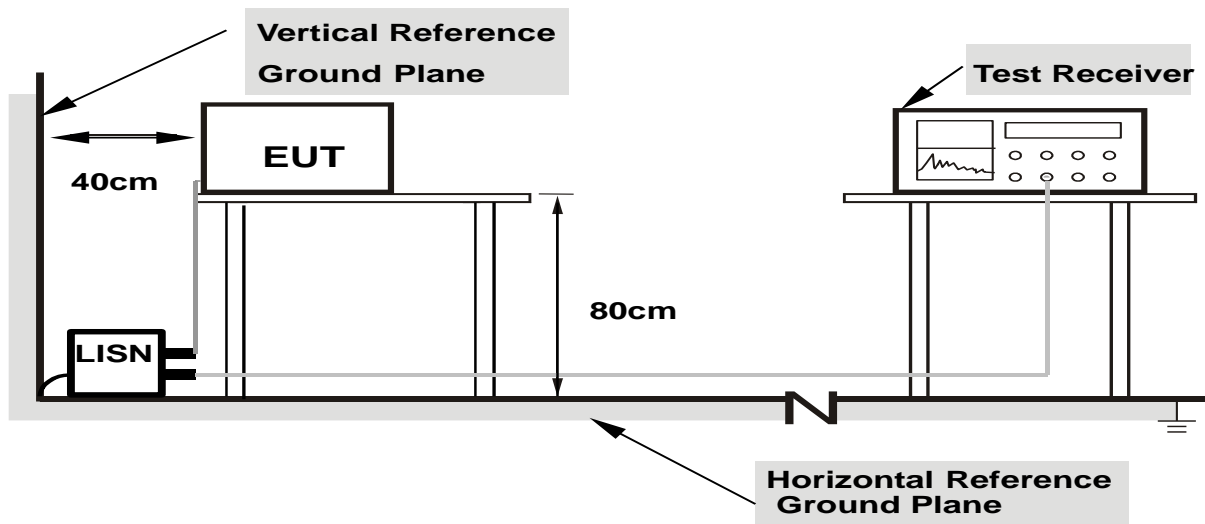

Note: 1.Support units were connected to second LISN.

2.Both of LISNs (AMN) are 80 cm from EUT and at least 80 from other units and other metal planes

5.4.3 Test procedure

a. EUT Operating Conditions

The EUT was configured for testing in a typical fashion (as a customer would normally use it). The EUT has been programmed to continuously transmit during test. This operating condition was tested and used to collect the included data.

b. The following table is the setting of the receiver

Receiver Parameters	Setting
Attenuation	10 dB
Start Frequency	0.15 MHz
Stop Frequency	30 MHz
IF Bandwidth	9 kHz

- c. The EUT was placed 0.8 meters from the horizontal ground plane with EUT being connected to the power mains through a line impedance stabilization network (LISN). All other support equipments powered from additional LISN(s). The LISN provide 50 Ohm/ 50uH of coupling impedance for the measuring instrument.
- d. Interconnecting cables that hang closer than 40 cm to the ground plane shall be folded back and forth in the center forming a bundle 30 to 40 cm long.
- e. I/O cables that are not connected to a peripheral shall be bundled in the center. The end of the cable may be terminated, if required, using the correct terminating impedance. The overall length shall not exceed 1 m.
- f. LISN at least 80 cm from nearest part of EUT chassis.

For the actual test configuration, please refer to the related Item –EUT Test Photos.

5.4.4 Test results

Note:

1. All the modulation modes have been tested, the report only shows the worst mode. The worst mode is 802.11b CH06
2. Emission Level = Reading Level + Factor, Margin = Emission Level - Limit, Factor = LISN modulus + Cable Loss

Test data

EUT:	IPCAM	Model Name:	Y1(763)
Pressure:	1010hPa	Phase::	L
Test Voltage:	Power by adapter AC 120V/60Hz	Test Mode:	Charging+TX

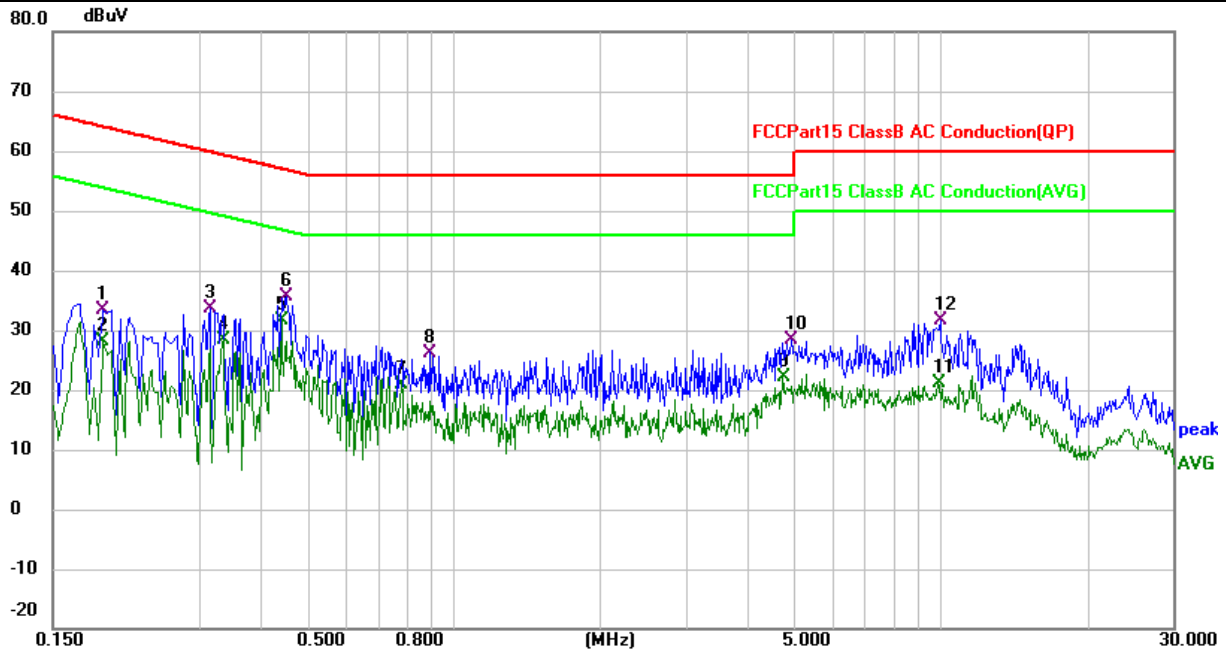

No.	Mk.	Freq. MHz	Reading Level dBuV	Correct Factor dB	Measure- ment dBuV	Limit dBuV	Over dB	Detector
1		0.1900	22.74	10.66	33.40	64.04	-30.64	QP
2		0.1900	17.42	10.66	28.08	54.04	-25.96	AVG
3		0.3140	22.71	10.89	33.60	59.86	-26.26	QP
4		0.3339	17.32	10.94	28.26	49.35	-21.09	AVG
5	*	0.4420	20.47	11.19	31.66	47.02	-15.36	AVG
6		0.4500	24.45	11.21	35.66	56.88	-21.22	QP
7		0.7820	8.90	11.94	20.84	46.00	-25.16	AVG
8		0.8900	14.08	12.17	26.25	56.00	-29.75	QP
9		4.7420	11.86	10.26	22.12	46.00	-23.88	AVG
10		4.9500	18.01	10.26	28.27	56.00	-27.73	QP
11		9.8660	10.67	10.40	21.07	50.00	-28.93	AVG
12		9.9780	21.32	10.41	31.73	60.00	-28.27	QP

EUT:	IPCAM	Model Name:	Y1(763)
Pressure:	1010hPa	Phase::	N
Test Voltage:	Power by adapter AC 120V/60Hz	Test Mode:	Charging+TX

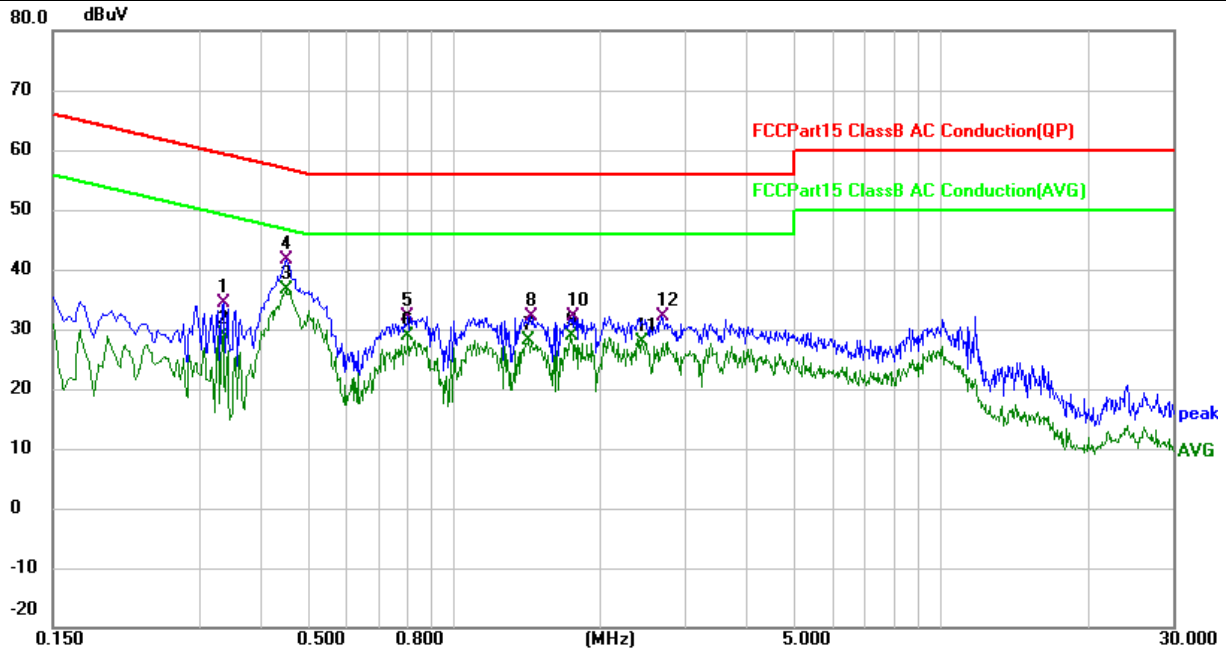

No.	Mk.	Freq. MHz	Reading Level dBuV	Correct Factor dB	Measure- ment dBuV	Limit dBuV	Over dB	Detector
1		0.3339	23.44	10.90	34.34	59.35	-25.01	QP
2		0.3339	18.29	10.90	29.19	49.35	-20.16	AVG
3	*	0.4500	25.35	11.18	36.53	46.88	-10.35	AVG
4		0.4540	30.55	11.19	41.74	56.80	-15.06	QP
5		0.8059	20.12	11.98	32.10	56.00	-23.90	QP
6		0.8059	16.95	11.98	28.93	46.00	-17.07	AVG
7		1.4299	15.00	13.25	28.25	46.00	-17.75	AVG
8		1.4340	18.87	13.25	32.12	56.00	-23.88	QP
9		1.7380	14.87	13.91	28.78	46.00	-17.22	AVG
10		1.7540	18.11	13.94	32.05	56.00	-23.95	QP
11		2.4460	17.53	10.39	27.92	46.00	-18.08	AVG
12		2.6780	21.87	10.35	32.22	56.00	-23.78	QP

5.5 Radiated spurious

5.5.1 Limits

20dBc in any 100 kHz bandwidth outside the operating frequency band. In case the emission fall within the restricted band specified on 15.205(a), then the 15.209(a) limit in the table below has to be followed.

Frequency (MHz)	Field Strength (micorvolts/meter)	Measurement Distance (meters)
0.009~0.490	2400/F(kHz)	300
0.490~1.705	24000/F(kHz)	30
1.705~30.0	30	30
30~88	100	3
88~216	150	3
216~960	200	3
Above 960	500	3

Spectrum Parameter	Setting
Attenuation	Auto
Start Frequency	1000 MHz
Stop Frequency	10th carrier harmonic
RB / VB (emission in restricted band)	1 MHz / 1 MHz for Peak, 1 MHz / 10Hz for Average

Receiver Parameter	Setting
Attenuation	Auto
Start ~ Stop Frequency	9kHz~150kHz / RB 200Hz for QP
Start ~ Stop Frequency	150kHz~30MHz / RB 9kHz for QP
Start ~ Stop Frequency	30MHz~1000MHz / RB 120kHz for QP

5.5.2 Test setup

Radiated emission test-up frequency below 30MHz

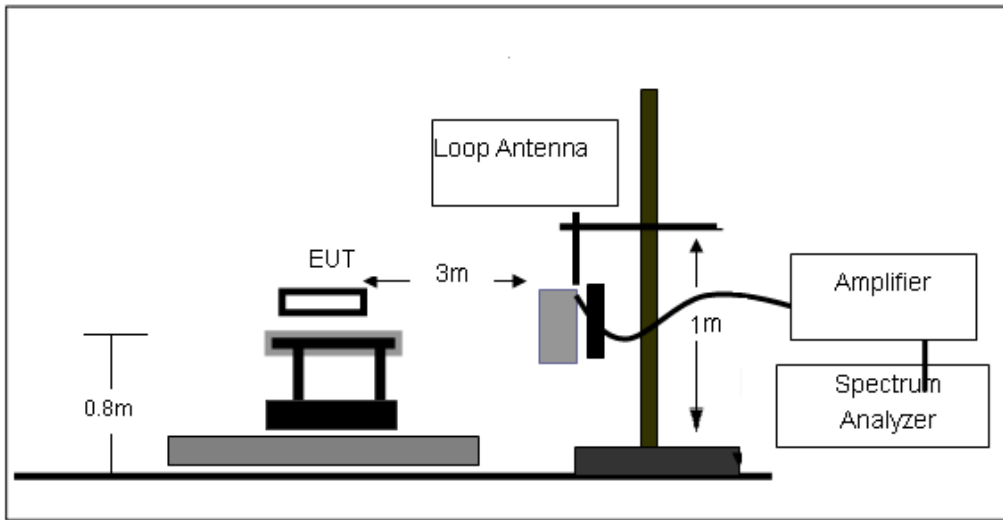

Radiated emission test-up frequency 30MHz~1GHz

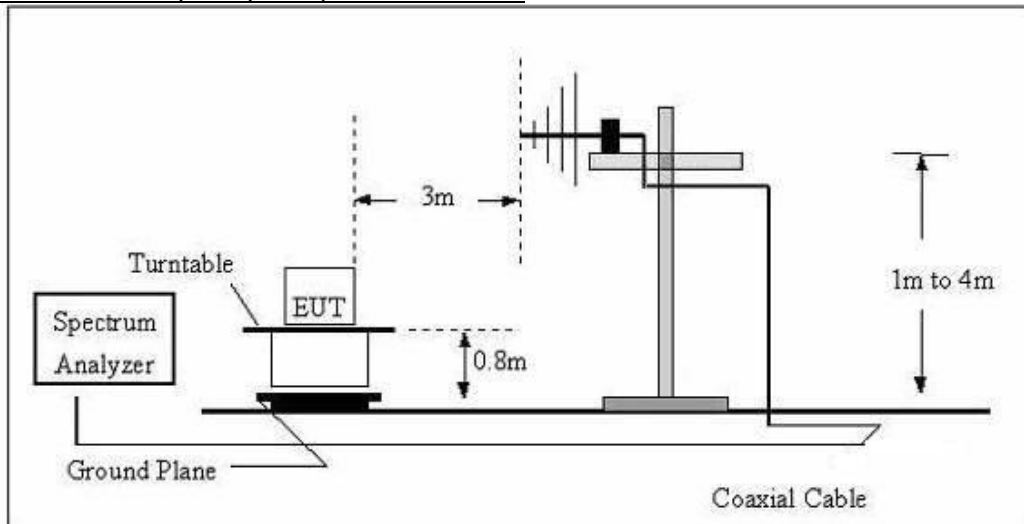

Radiated emission test-up frequency above 1GHz

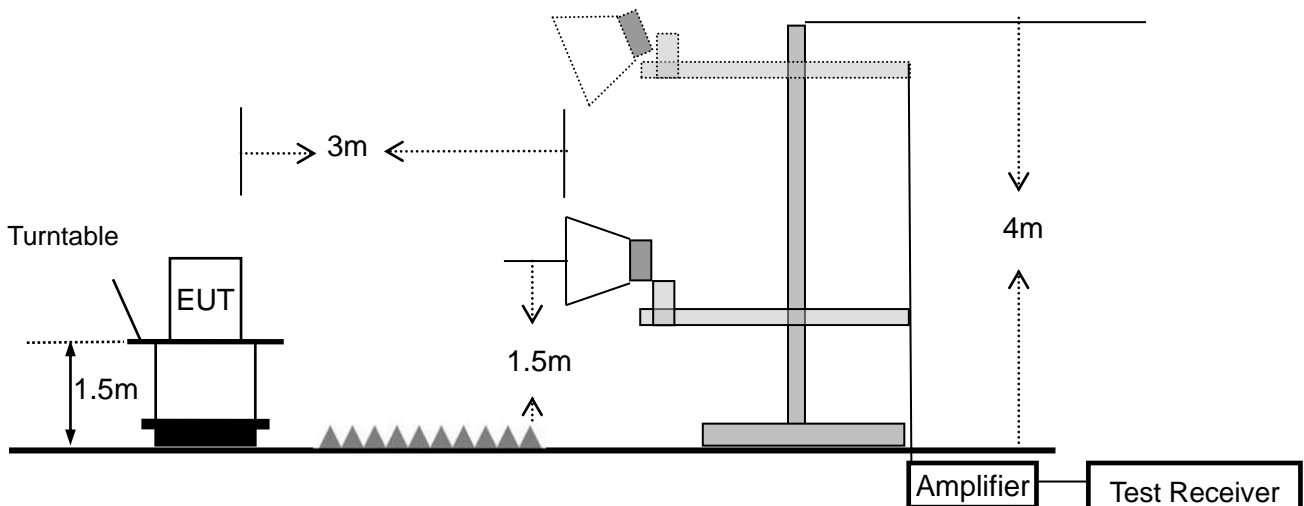

5.5.3 Test procedure

- a. EUT operating conditions. The EUT tested system was configured as the statements of 2.4 unless otherwise a special operating condition is specified in the follows during the testing.
- b. The measuring distance of at 3 m shall be used for measurements at frequency up to 1GHz. For frequencies above 1GHz, any suitable measuring distance may be used.
- c. The EUT was placed on the top of a rotating table 0.8 meters above the ground at a 3 meter open area test site. The table was rotated 360 degrees to determine the position of the highest radiation.
- d. The height of the equipment or of the substitution antenna shall be 0.8 m; the height of the test antenna shall vary between 1 m to 4 m. Both horizontal and vertical polarizations of the antenna are set to make the measurement.
- e. For emission measurements above 1 GHz, the EUT shall be placed at a height of 1.5 m above the floor on a support that is RF transparent for the frequencies of interest. Final measurements for the EUT require a measurement antenna height scan of 1 m to 4 m.
- f. The initial step in collecting conducted emission data is a spectrum analyzer peak detector mode pre-scanning the measurement frequency range. Significant peaks are then marked and then Quasi Peak detector mode re-measured.
- g. If the Peak Mode measured value compliance with and lower than Quasi Peak Mode Limit, the EUT shall be deemed to meet QP Limits and then no additional QP Mode measurement performed.
- h. For the actual test configuration, please refer to the related Item –EUT Test photos.

Note: Both horizontal and vertical antenna polarities were tested and performed pretest to three orthogonal axis. The worst case emissions were reported

5.5.4 Test results

5.5.4.1 Radiation emission

Below 30MHz

EUT:	IPCAM	Model Name:	Y1(763)
Pressure:	1010 hPa	Phase:	H
Test Mode:	Charging+TX	Test Voltage:	Power by adapter AC 120V/60Hz

Freq.	Reading	Limit	Margin	State
(MHz)	(dBuV/m)	(dBuV/m)	(dB)	P/F
--	--	--	--	Pass
--	--	--	--	Pass

Note:

1. For 9k-30MHz, the amplitude of spurious emissions which are attenuated by more than 20dB below the permissible value has no need to be reported.
2. Distance extrapolation factor = $40 \log(\text{specific distance}/\text{test distance})(\text{dB})$.
3. Limit line = specific limits (dBuV) + distance extrapolation factor.

Between 30MHz – 1GHz

EUT:	IPCAM	Model Name:	Y1(763)
Pressure:	1010 hPa	Phase:	H
Test Mode:	Charging+TX	Test Voltage:	Power by adapter AC 120V/60Hz

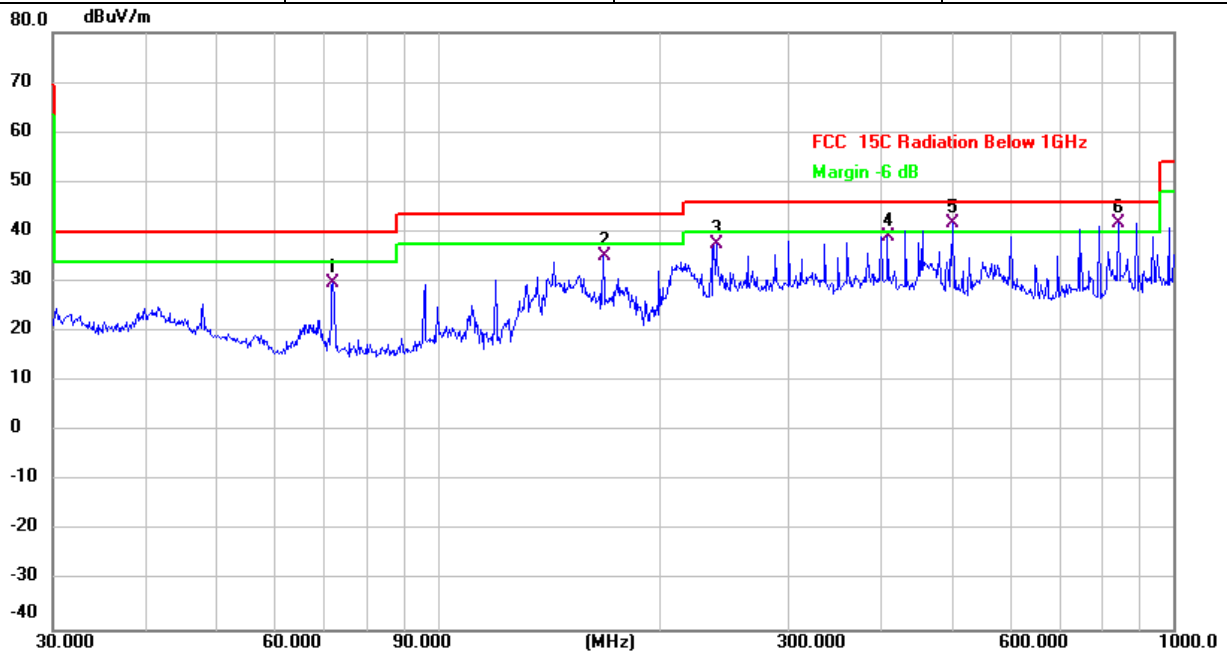

No.	Mk.	Freq.	Reading Level	Correct Factor	Measurement	Limit	Over	
		MHz	dBuV	dB	dBuV/m	dBuV/m	dB	Detector
1		72.0843	39.68	-10.04	29.64	40.00	-10.36	QP
2		167.8243	44.79	-9.66	35.13	43.50	-8.37	QP
3		239.1473	44.03	-6.35	37.68	46.00	-8.32	QP
4		408.9460	43.13	-3.98	39.15	46.00	-6.85	QP
5	!	501.1790	43.90	-2.20	41.70	46.00	-4.30	QP
6	*	842.1296	39.26	2.52	41.78	46.00	-4.22	QP

EUT:	IPCAM	Model Name:	Y1(763)
Pressure:	1010 hPa	Phase:	V
Test Mode:	Charging+TX	Test Voltage:	Power by adapter AC 120V/60Hz

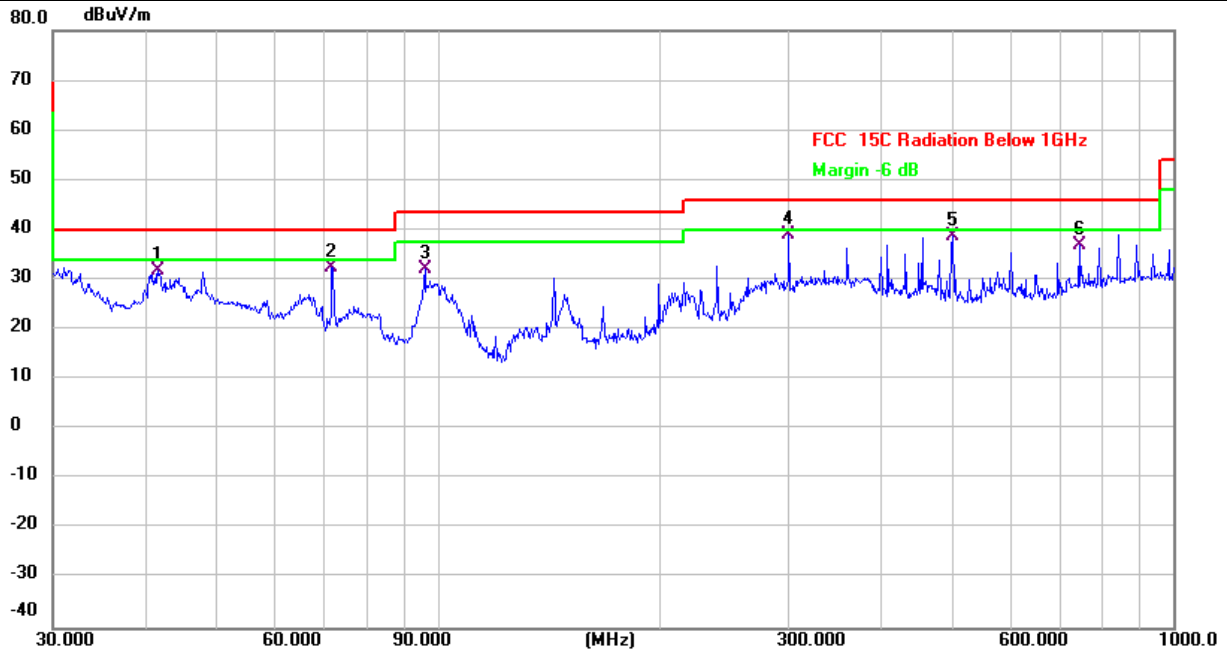

No.	Mk.	Freq.	Reading Level	Correct Factor	Measurement	Limit	Over	
		MHz	dBuV	dB	dBuV/m	dBuV/m	dB	Detector
1		41.7129	39.73	-7.90	31.83	40.00	-8.17	QP
2		71.8320	42.61	-10.03	32.58	40.00	-7.42	QP
3		96.0986	40.76	-8.66	32.10	43.50	-11.40	QP
4	*	300.3672	44.80	-5.86	38.94	46.00	-7.06	QP
5		501.1790	41.08	-2.20	38.88	46.00	-7.12	QP
6		744.8661	36.27	0.72	36.99	46.00	-9.01	QP

Note:

1. Emission Level = Meter Reading + Factor, Margin= Emission Level- Limit, Factor = Antenna Factor + Cable Loss – Pre-amplifier.
2. The three modulated high, medium and low channels have been tested. The report only shows the worst mode. The worst mode is 802.11b CH11.

1GHz-25GHz

Frequency	Reading Level	Correct Factor	Measurement	Limits	Over	Detector	Polarization
(MHz)	(dB μ V)	(dB/m)	(dB μ V/m)	(dB μ V/m)	(dB)	Peak/AVG	H/V
802.11b - 2412 MHz TX mode							
4824.000	50.42	0.91	51.33	74.00	-22.67	Peak	V
4824.000	48.39	0.91	49.30	54.00	-4.70	AVG	V
7236.000	41.26	5.77	47.03	74.00	-26.97	Peak	V
7236.000	35.25	5.77	41.02	54.00	-12.98	AVG	V
9648.000	42.13	6.29	48.42	74.00	-25.58	Peak	V
9648.000	35.94	6.29	42.23	54.00	-11.77	AVG	V
4824.000	49.63	0.91	50.54	74.00	-23.46	Peak	H
4824.000	47.30	0.91	48.21	54.00	-5.79	AVG	H
7236.000	40.82	5.77	46.59	74.00	-27.41	Peak	H
7236.000	34.39	5.77	40.16	54.00	-13.84	AVG	H
9648.000	41.84	6.29	48.13	74.00	-25.87	Peak	H
9648.000	35.76	6.29	42.05	54.00	-11.95	AVG	H
802.11b - 2437 MHz TX mode							
4874.000	52.57	1.14	53.71	74.00	-20.29	Peak	V
4874.000	50.43	1.14	51.57	54.00	-2.43	AVG	V
7311.000	40.00	5.55	45.55	74.00	-28.45	Peak	V
7311.000	33.70	5.55	39.25	54.00	-14.75	AVG	V
9748.000	41.98	6.22	48.20	74.00	-25.80	Peak	V
9748.000	35.93	6.22	42.15	54.00	-11.85	AVG	V
4874.000	50.36	1.14	51.50	74.00	-22.50	Peak	H
4874.000	48.07	1.14	49.21	54.00	-4.79	AVG	H
7311.000	40.54	5.55	46.09	74.00	-27.91	Peak	H
7311.000	34.51	5.55	40.06	54.00	-13.94	AVG	H
9748.000	41.65	6.22	47.87	74.00	-26.13	Peak	H
9748.000	35.17	6.22	41.39	54.00	-12.61	AVG	H

802.11b - 2462 MHz TX mode							
4924.000	52.48	1.37	53.85	74.00	-20.15	Peak	V
4924.000	50.22	1.37	51.59	54.00	-2.41	AVG	V
7386.000	41.12	5.32	46.44	74.00	-27.56	Peak	V
7386.000	34.85	5.32	40.17	54.00	-13.83	AVG	V
9848.000	41.73	6.14	47.87	74.00	-26.13	Peak	V
9848.000	35.14	6.14	41.28	54.00	-12.72	AVG	V
4924.000	51.50	1.37	52.87	74.00	-21.13	Peak	H
4924.000	49.31	1.37	50.68	54.00	-3.32	AVG	H
7386.000	40.60	5.32	45.92	74.00	-28.08	Peak	H
7386.000	33.85	5.32	39.17	54.00	-14.83	AVG	H
9848.000	41.23	6.14	47.37	74.00	-26.63	Peak	H
9848.000	35.02	6.14	41.16	54.00	-12.84	AVG	H

Note:

1. Emission Level= Antenna Factor + Cable Loss + Read Level - Preamp Factor
2. All other emissions more than 20dB below the limit.
3. The three modulated high, medium and low channels have been tested. The report only shows the worst mode. The worst mode is 802.11b.

5.5.4.2 Band edge - radiated

Frequency	Reading Level	Correct Factor	Measurement	Limits	Over	Detector	Polarization
(MHz)	(dB μ V)	(dB/m)	(dB μ V/m)	(dB μ V/m)	(dB)	Peak/AVG	H/V
802.11b – Low band-edge							
(MHz)	(dB μ V)	(dB/m)	(dB μ V/m)	(dB μ V/m)	(dB)	Peak/AVG	H/V
2310	43.97	-6.60	37.37	74.00	-36.63	Peak	V
2310	34.23	-6.60	27.63	54.00	-26.37	AVG	V
2390	69.97	-6.23	63.74	74.00	-10.26	Peak	V
2390	54.23	-6.23	48.00	54.00	-6.00	AVG	V
2310	47.26	-6.60	40.66	74.00	-33.34	Peak	H
2310	37.26	-6.60	30.66	54.00	-23.34	AVG	H
2390	71.26	-6.23	65.03	74.00	-8.97	Peak	H
2390	57.30	-6.23	51.07	54.00	-2.93	AVG	H
802.11b – High band-edge							
2483.5	73.02	-5.79	67.23	74.00	-6.77	Peak	V
2483.5	56.28	-5.79	50.49	54.00	-3.51	AVG	V
2500	56.70	-5.72	50.98	74.00	-23.02	Peak	V
2500	43.63	-5.72	37.91	54.00	-16.09	AVG	V
2483.5	72.92	-5.79	67.13	74.00	-6.87	Peak	H
2483.5	54.54	-5.79	48.75	54.00	-5.25	AVG	H
2500	57.28	-5.72	51.56	74.00	-22.44	Peak	H
2500	41.82	-5.72	36.10	54.00	-17.90	AVG	H

Note:

1. All Readings are Peak Value (VBW=3MHz) and AV Value (VBW=10Hz).
2. Emission Level= Antenna Factor + Cable Loss + Read Level - Preamp Factor.
3. All the modulation modes have been tested, and only the worst results are reflected in the report.

5.6 Band edge - Conducted

5.6.1 Limits

In any 100 kHz bandwidth outside the frequency band in which the spread spectrum or digitally modulated intentional radiator is operating, the radio frequency power that is produced by the intentional radiator shall be at least 20 dB below that in the 100 kHz bandwidth within the band that contains the highest level of the desired power, based on either an RF conducted or a radiated measurement, provided the transmitter demonstrates compliance with the peak conducted power limits. If the transmitter complies with the conducted power limits based on the use of RMS averaging over a time interval, as permitted under paragraph (b)(3) of this section, the attenuation required under this paragraph shall be 30 dB instead of 20 dB. Attenuation below the general limits specified in §15.209(a) is not required. In addition, radiated emissions which fall in the restricted bands, as defined in §15.205(a), must also comply with the radiated emission limits specified in §15.209(a) (see §15.205(c)).

5.6.2 Test setup



5.6.3 Test procedure

- Check the calibration of the measuring instrument using either an internal calibrator or a known signal from an external generator.
- Position the EUT without connection to measurement instrument. Turn on the EUT and connect its antenna terminal to measurement instrument via a low loss cable. Then set it to any one measured frequency within its operating range, and make sure the instrument is operated in its linear range.
- Set RBW to 100 kHz and VBW of spectrum analyzer to 300 kHz with a convenient frequency span including 100 kHz bandwidth from band edge.
- Measure the highest amplitude appearing on spectral display and set it as a reference level. Plot the graph with marking the highest point and edge frequency.
- Repeat above procedures until all measured frequencies were complete.

5.6.4 Test results

Test plots:

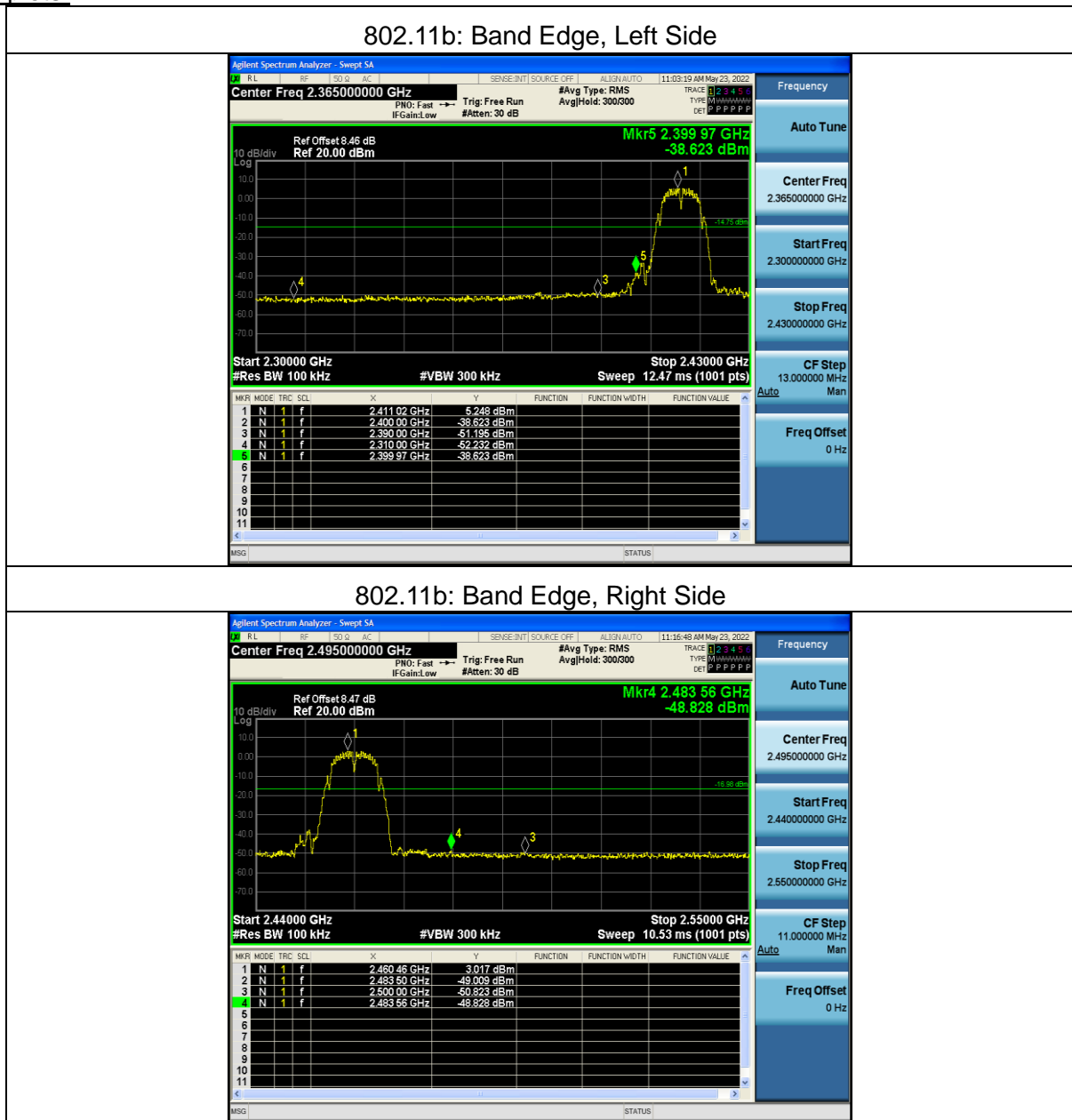

802.11g: Band Edge, Left Side



802.11g: Band Edge, Right Side

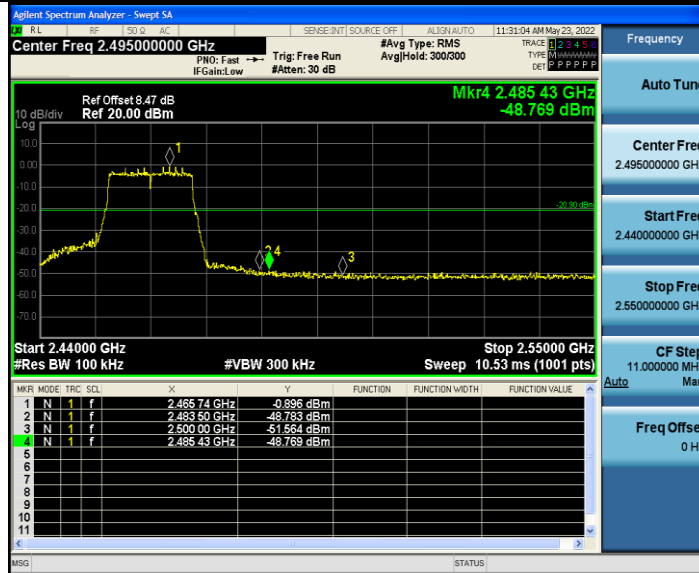

802.11n20: Band Edge, Left Side

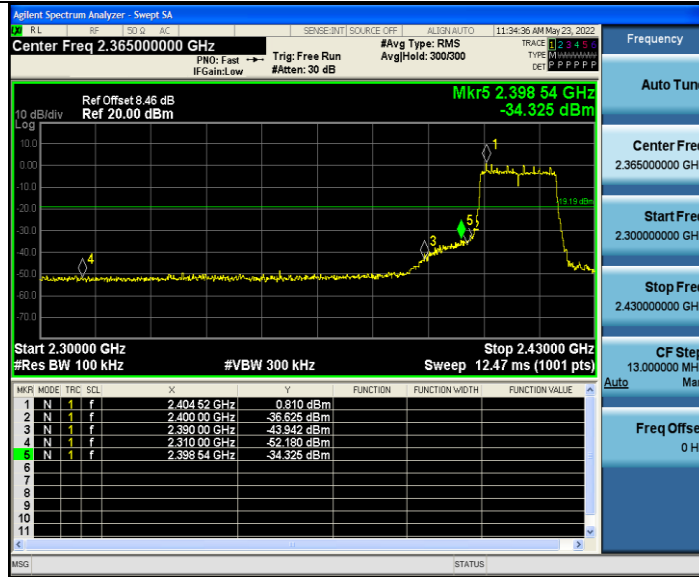

802.11n20: Band Edge, Right Side

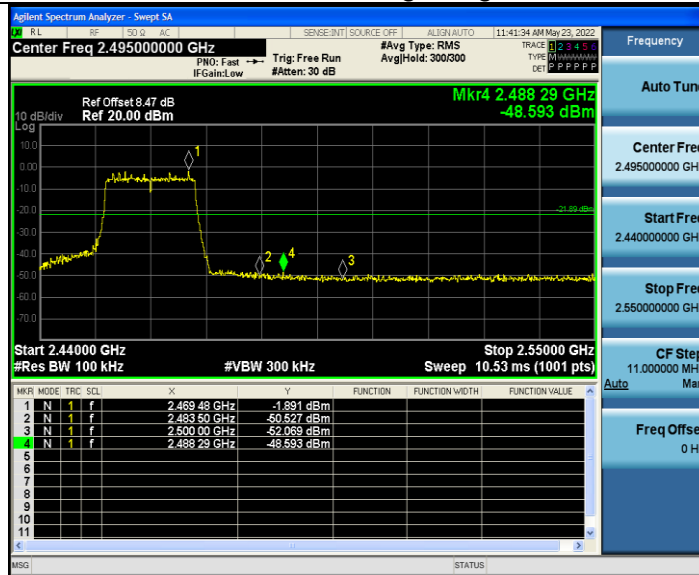

5.7 6dB bandwidth

5.7.1 Limit

Section	Test Item	Limit	Frequency Range (MHz)
15.247(a)(2)	Bandwidth	$\geq 500\text{kHz}$ (6dB bandwidth)	2400-2483.5

5.7.2 Test setup

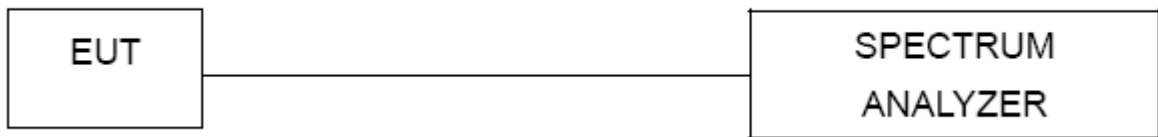

5.7.3 Test procedure

- a. Set RBW= 100 kHz.
- b. Set the video bandwidth (VBW) $\geq 3 \times$ RBW.
- c. Detector = Peak.
- d. Trace mode = max hold.
- e. Sweep = auto couple.
- f. Allow the trace to stabilize.
- g. Measure the maximum width of the emission that is constrained by the frequencies associated with the two outermost amplitude points (upper and lower) that are attenuated by 6 dB relative to the maximum level measured in the fundamental emission.

5.7.4 Test results

EUT:	IPCAM	Model Name:	Y1(763)
Pressure:	1012 hPa	Test Voltage:	Power by adapter AC 120V/60Hz
Test Mode:	TX b Mode /CH01, CH06, CH11		

Channel	Frequency (MHz)	6dB bandwidth (MHz)	Limit (kHz)	Result
Low	2412	9.116	500	Pass
Middle	2437	9.057	500	Pass
High	2462	9.135	500	Pass

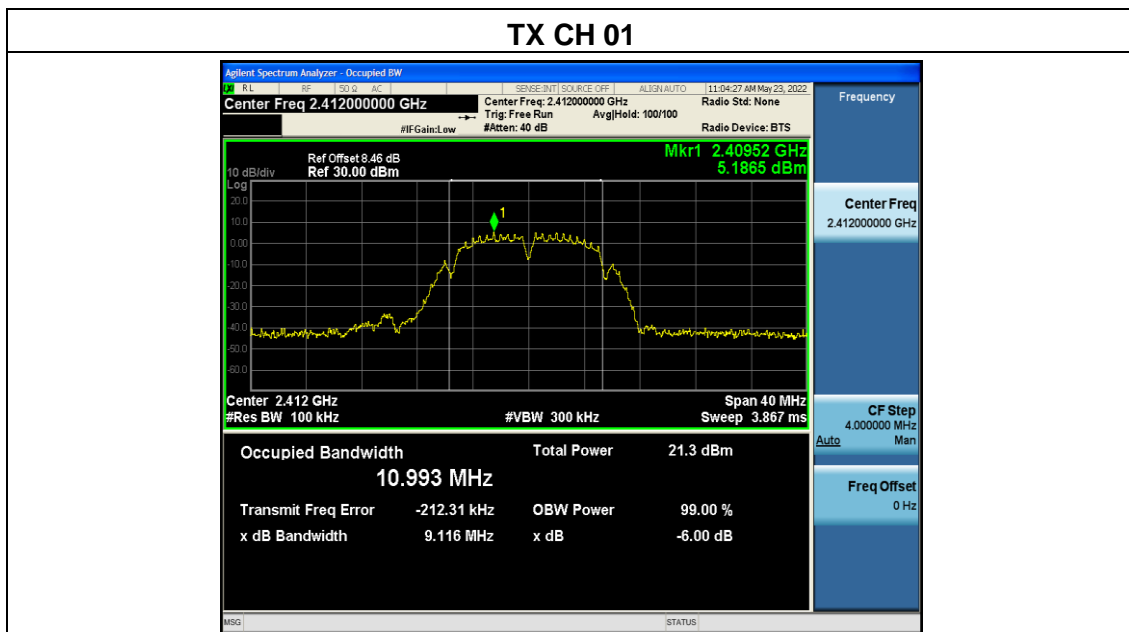

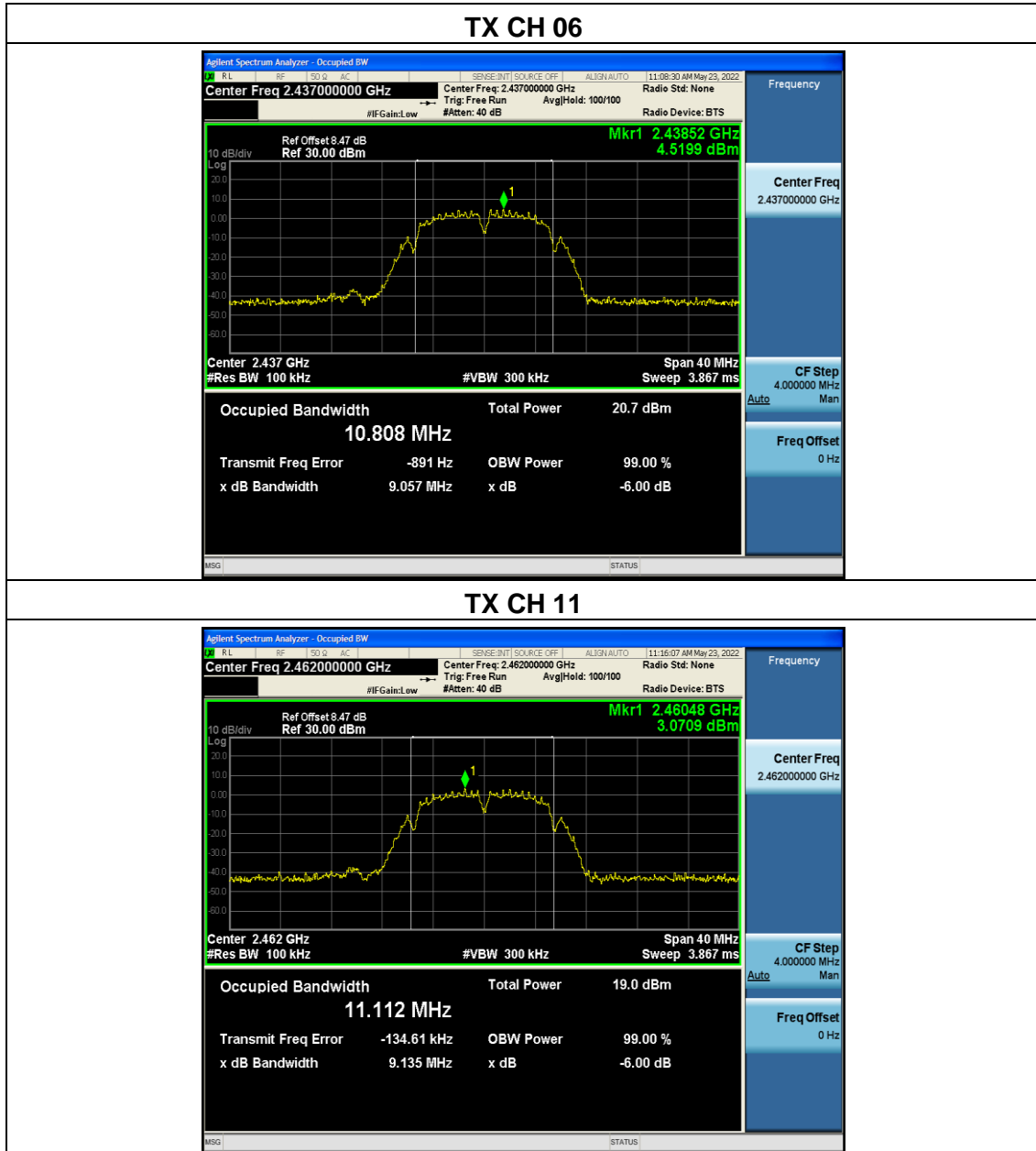

EUT:	IPCAM	Model Name:	Y1(763)
Pressure:	1012 hPa	Test Voltage:	Power by adapter AC 120V/60Hz
Test Mode:	TX g Mode /CH01, CH06, CH11		

Channel	Frequency (MHz)	6dB bandwidth (MHz)	Limit (kHz)	Result
Low	2412	16.43	500	Pass
Middle	2437	16.45	500	Pass
High	2462	16.40	500	Pass

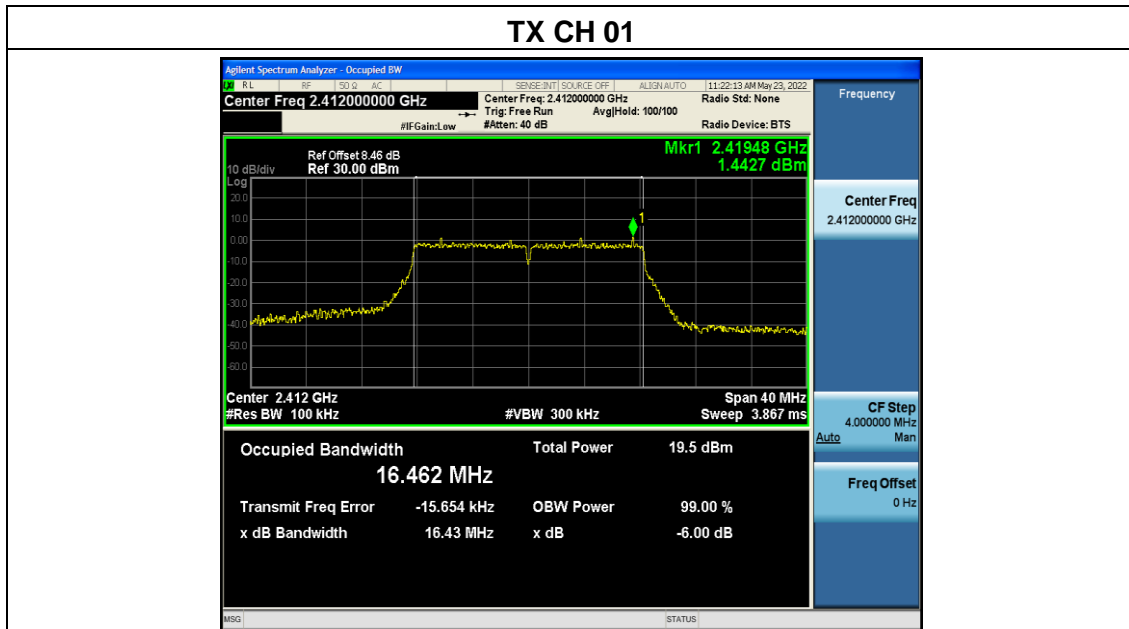

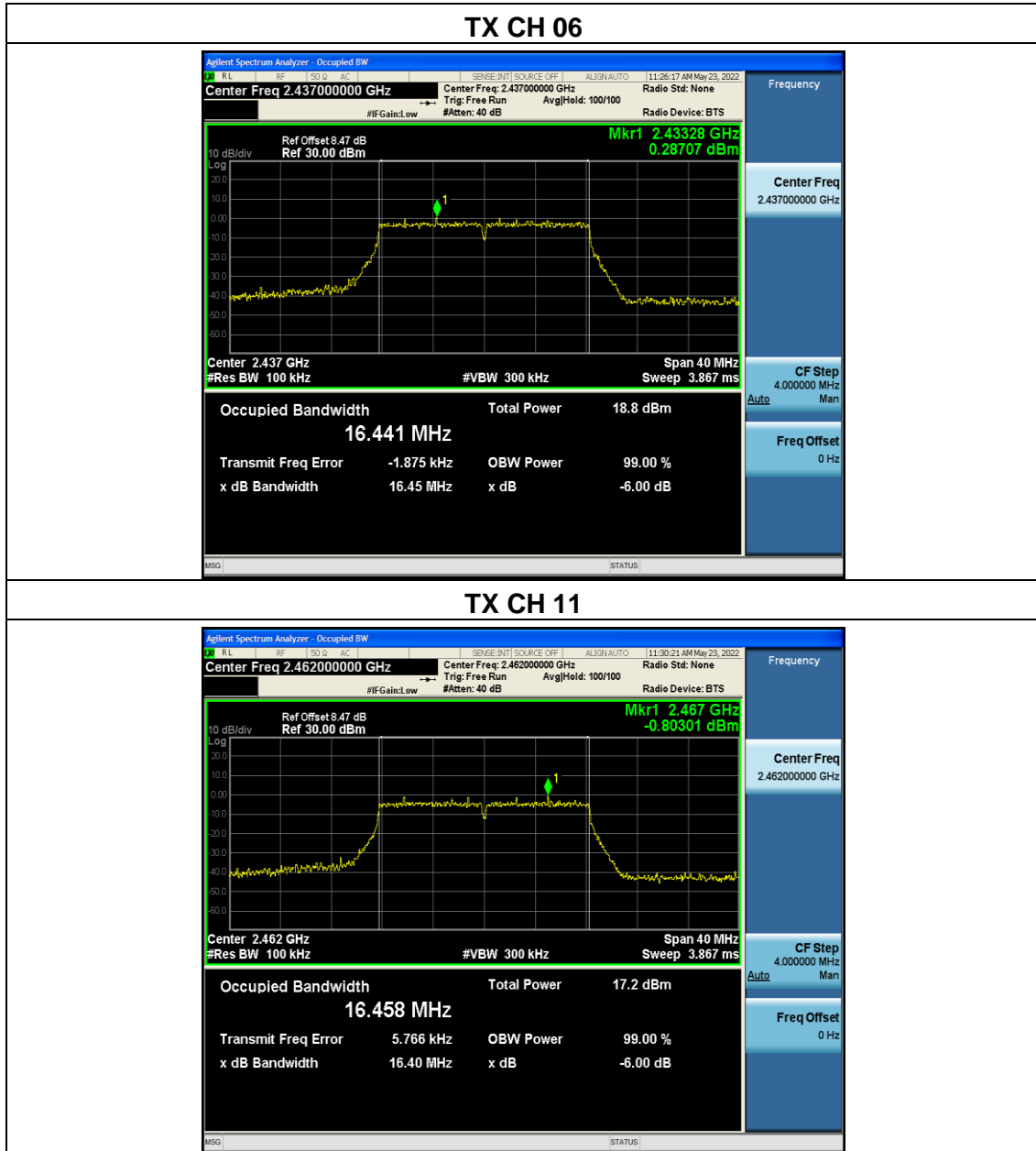

EUT:	IPCAM	Model Name:	Y1(763)
Pressure:	1012 hPa	Test Voltage:	Power by adapter AC 120V/60Hz
Test Mode:	TX n20 Mode /CH01, CH06, CH11		

Channel	Frequency (MHz)	6dB bandwidth (MHz)	Limit (kHz)	Result
Low	2412	17.66	500	Pass
Middle	2437	17.72	500	Pass
High	2462	17.63	500	Pass

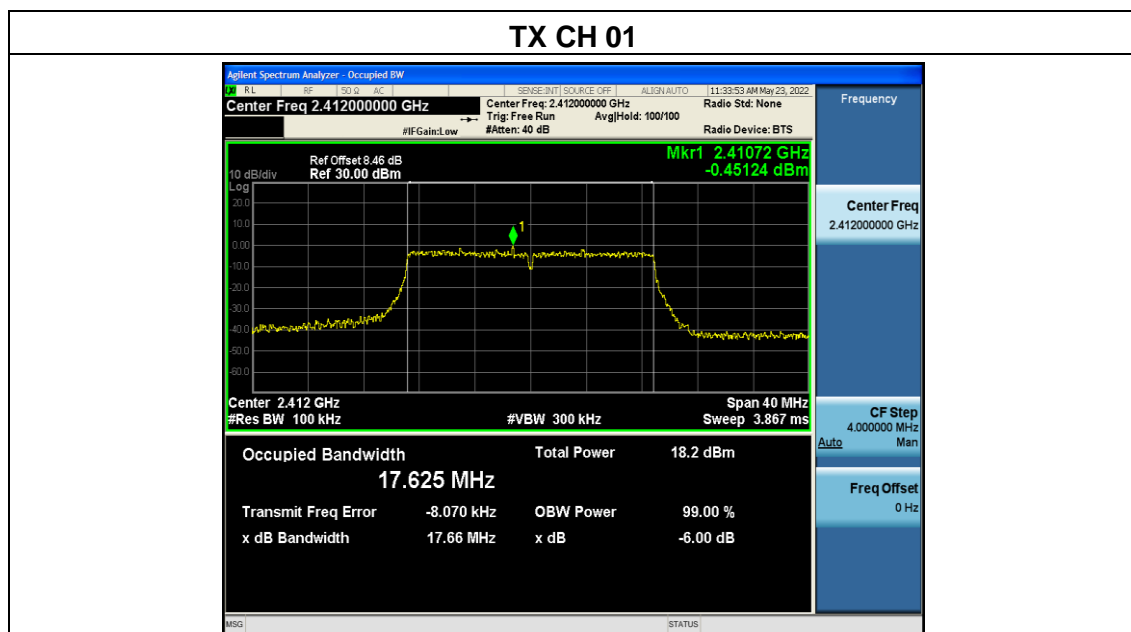

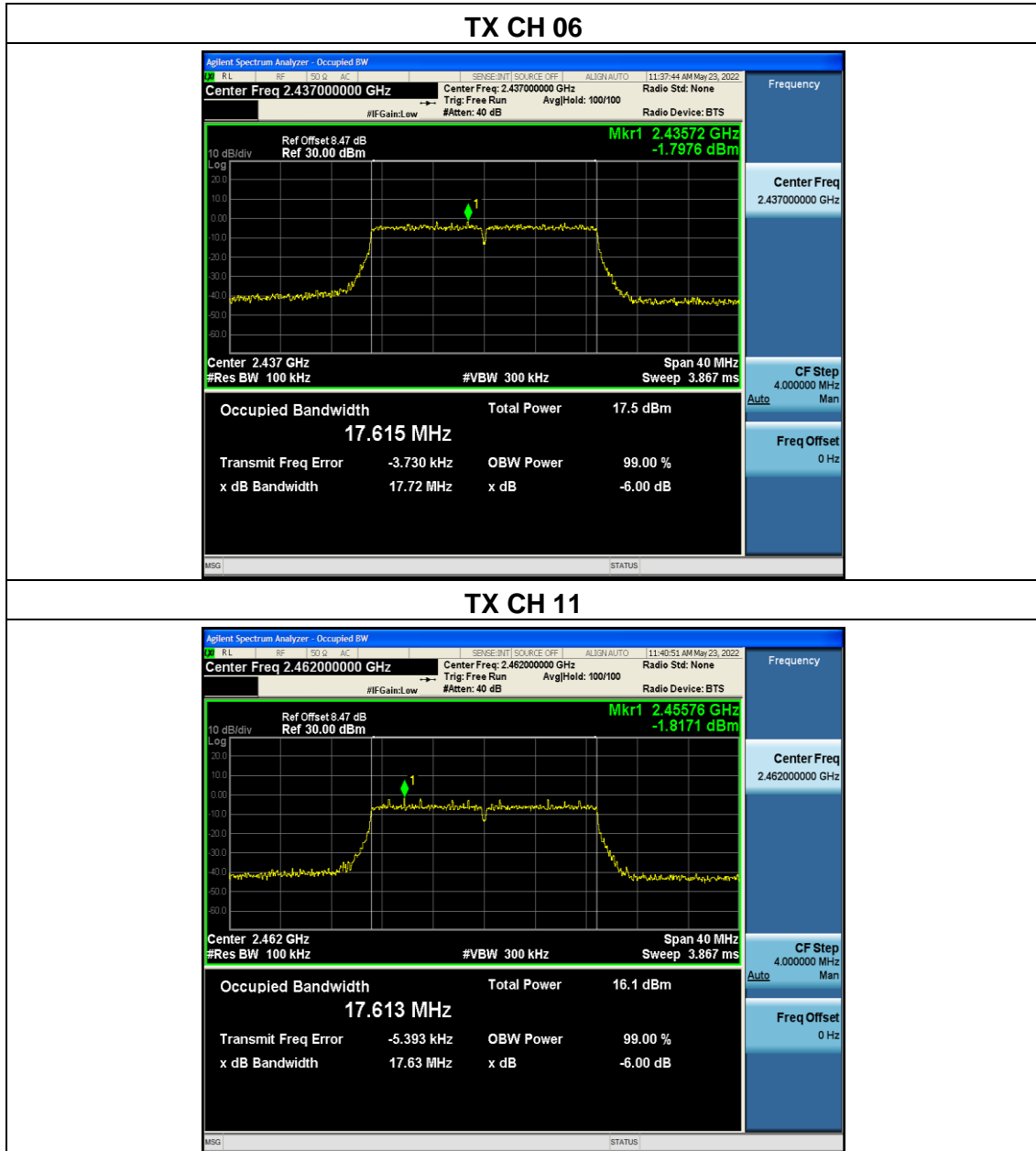

5.8 Duty Cycle

5.8.1 Limit

No limit requirement.

5.8.2 Measuring instruments

The Measuring equipment is listed in the section 4 of this test report.

5.8.3 Test setup



5.8.4 Test procedure

The zero-span mode on a spectrum analyzer or EMI receiver if the response time and spacing between bins on the sweep are sufficient to permit accurate measurements of the on and off times of the transmitted signal. Set the center frequency of the instrument to the center frequency of the transmission. Set $RBW \geq OBW$ if possible; otherwise, set RBW to the largest available value. Set $VBW \geq RBW$. Set detector = peak or average. The zero-span measurement method shall not be used unless both RBW and VBW are $> 50/T$ and the number of sweep points across duration T exceeds 100. (For example, if VBW and/or RBW are limited to 3 MHz, then the zero-span method of measuring duty cycle shall not be used if $T \leq 16.7$ microseconds.)

The transmitter output is connected to the Spectrum Analyzer. We tested according to the zero-span measurement method, 6.0(b) in KDB 558074

The largest available value of RBW is 8 MHz and VBW is 50 MHz. The zero-span method of measuring duty cycle shall not be used if $T \leq 6.25$ microseconds. ($50/6.25 = 8$)

The zero-span method was used because all measured T data are > 6.25 microseconds and both RBW and VBW are $> 50/T$.

The RF output of EUT was connected to the spectrum analyzer by RF cable and attenuator.

The path loss was compensated to the results for each measurement.

Set to the maximum power setting and enable the EUT transmit continuously.

The EUT was operating in controlled its channel.

Use the following spectrum analyzer settings:

Span = Zero Span

RBW = 8MHz (the largest available value)

VBW = 8MHz (\geq RBW)

Number of points in Sweep > 100

Detector function = peak

Trace = Clear write

Measure T total and Ton

Calculate Duty Cycle = Ton / T total

5.8.5 Test Results

EUT:	IPCAM	Model Name:	Y1(763)
Pressure:	1012 hPa	Test Voltage:	Power by adapter AC 120V/60Hz
Test Mode:	TX b/g/n(20) Mode / CH06		

Mode	Data rate	Channel	T _{on}	T _{total}	Duty Cycle	Duty Cycle Factor (dB)	VBW Setting
802.11b	1Mbps	6	-	-	100%	0	10Hz
802.11g	6Mbps	6	-	-	100%	0	1kHz
802.11n HT20	MCS0	6	-	-	100%	0	1kHz

5.9 Spurious RF Conducted Emissions

5.9.1 Limit

Below -20dB of the highest emission level in operating band.

5.9.2 Measuring instruments

The Measuring equipment is listed in the section 4 of this test report.

5.9.3 Test setup

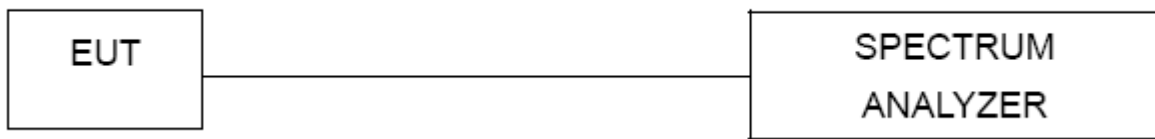

5.9.4 Test procedure

The Spurious RF conducted emissions compliance of RF radiated emission should be measured by following the guidance in ANSI C63.10-2013 with respect to maximizing the emission by rotating the EUT, measuring the emission while the EUT is situated in three orthogonal planes (if appropriate), adjusting the measurement antenna height and polarization etc. Set RBW=100kHz and VBW= 300kHz to measure the peak field strength, and measure frequency range from 9kHz to 26.5GHz.

5.9.5 Test results

Note:

- 1: The measurement frequency range is from 9kHz to the 10th harmonic of the fundamental frequency; The lowest, middle and highest channels are tested to verify the spurious emissions and band edge measurement data.
- 2: The three modulated high, medium and low channels have been tested. The report only shows the worst mode. The worst mode is 802.11b CH01/06/11.

802.11b on Channel 01



802.11b on Channel 01

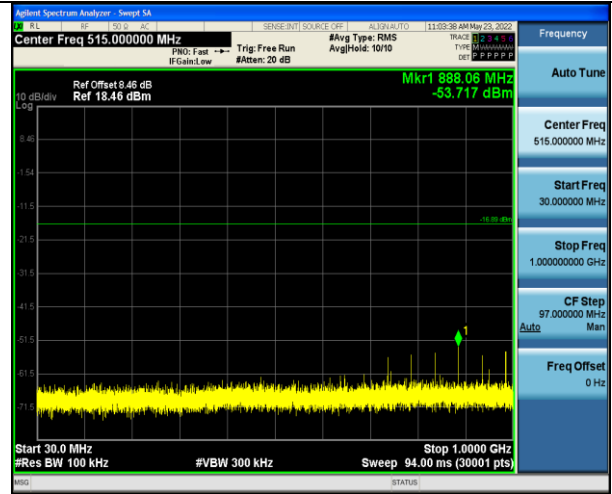

802.11b on Channel 01

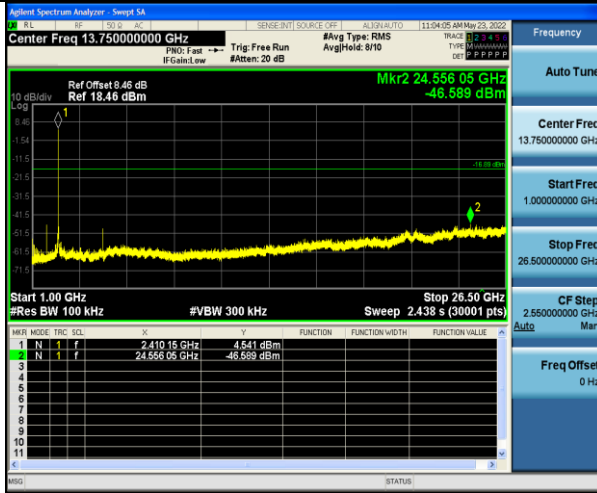

802.11b on Channel 06



802.11b on Channel 06

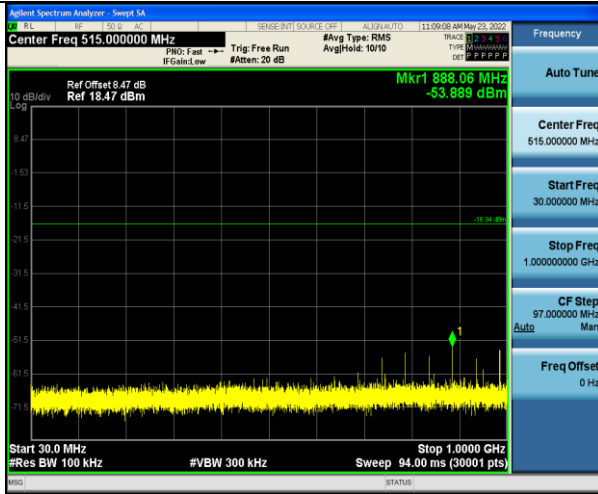

802.11b on Channel 06

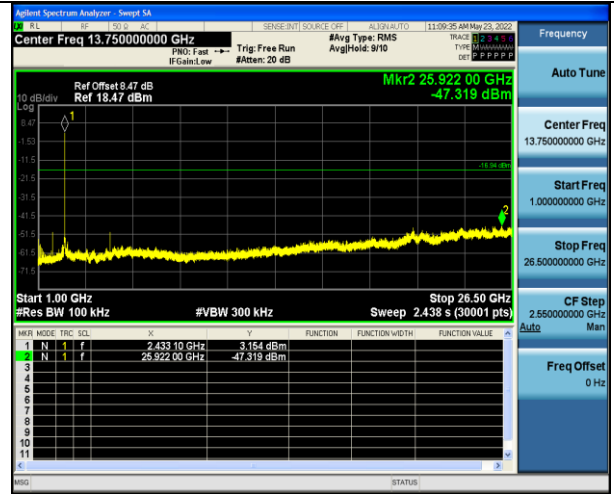

802.11b on Channel 11



802.11b on Channel 11

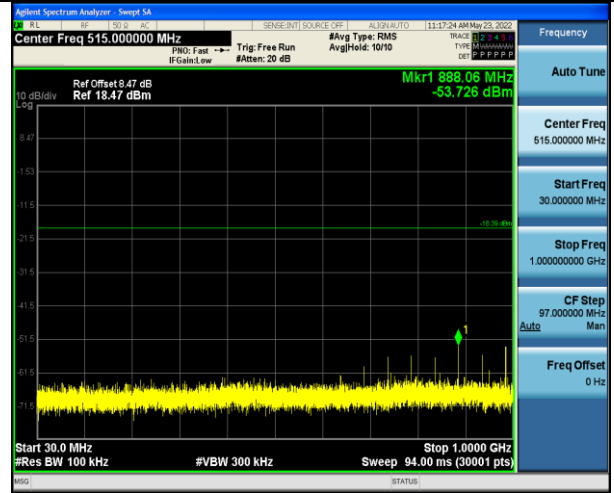

802.11b on Channel 11

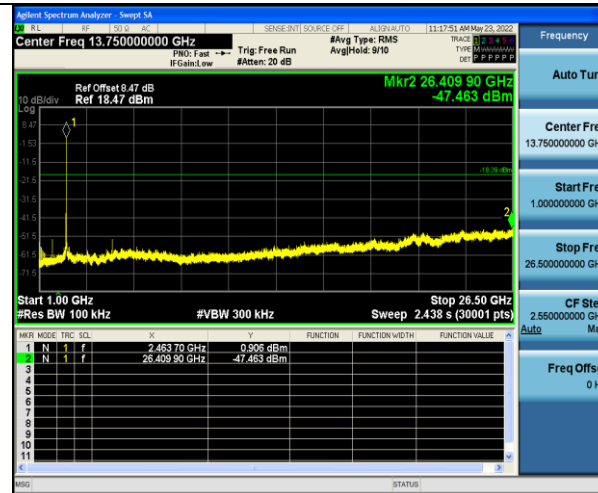



Photographs of the Test Setup

Radiated emission

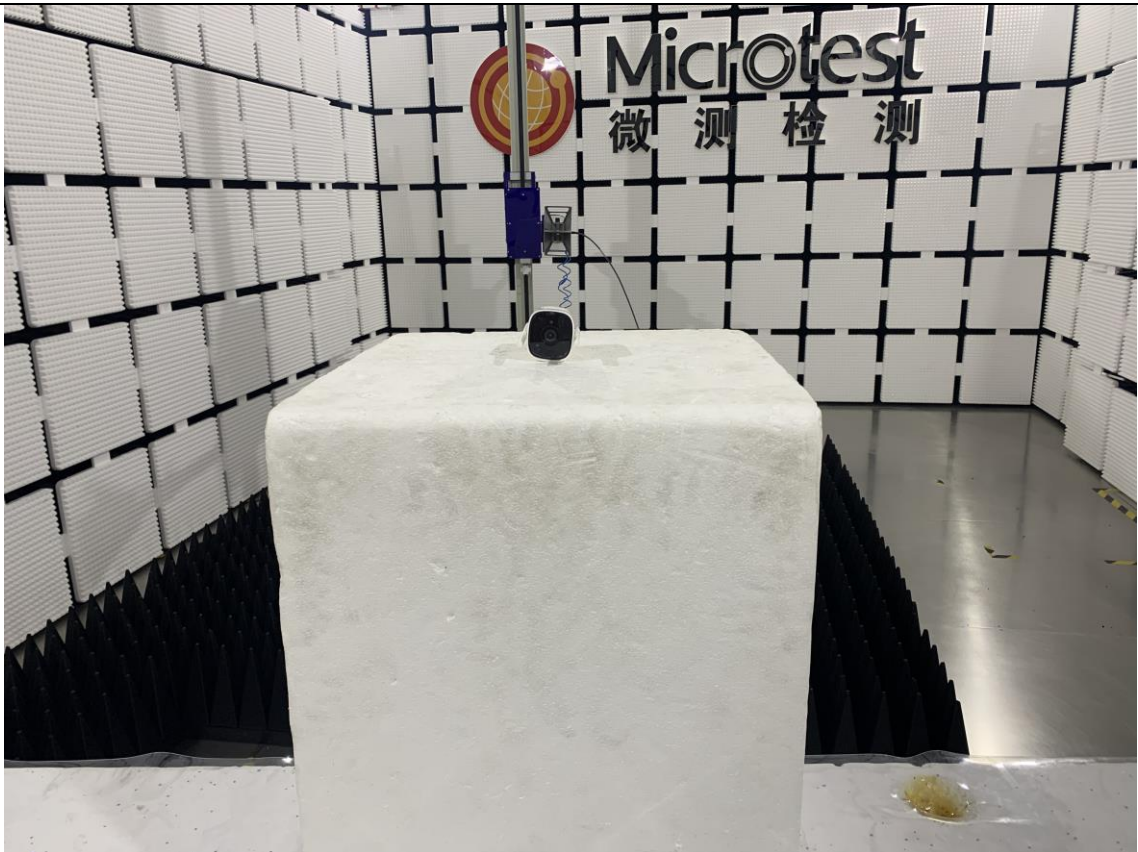
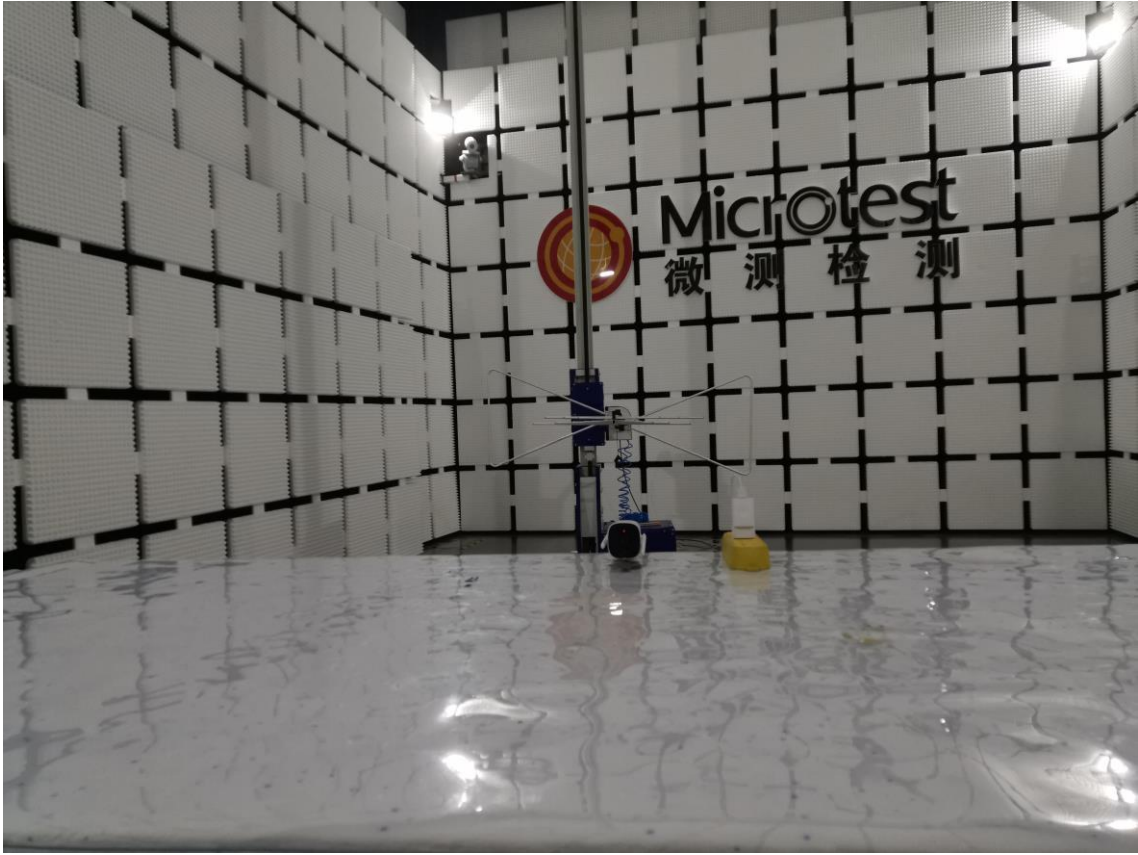



Conducted emission





Photographs of the EUT

See the Appendix - EUT Photos.

----END OF REPORT----