

Test Report

FCCID: ZCB-850G

Date of issue: Sept. 05, 2018

| | |
|---------------------|---|
| Report Number: | MTi180903E006 |
| Sample Description: | Base Station |
| Model(s): | 850G, 851G, 852G, T1, T2, T3 |
| Applicant: | Shenzhen Smart-eye Digital Electronics Co.,Ltd |
| Address: | #6 Northern Zone, Shangxue S&T City, Bantian, Longgang District, Shenzhen, China. |
| Date of Test: | Aug. 18, 2018 to Sept. 05, 2018 |

Shenzhen Microtest Co., Ltd.
<http://www.mtitest.com>

Table of Contents

| | | |
|----------|---|-----------|
| 1 | GENERAL INFORMATION | 3 |
| 1.1 | DESCRIPTION OF EUT | 4 |
| 1.2 | OPERATION CHANNEL LIST | 5 |
| 1.3 | TEST CHANNEL LIST | 5 |
| 1.4 | ANCILLARY EQUIPMENT LIST | 6 |
| 1.5 | DESCRIPTION OF SUPPORT UNITS | 6 |
| 2 | SUMMARY OF TEST RESULTS | 7 |
| 3 | TEST FACILITIES AND ACCREDITATIONS | 8 |
| 3.1 | TEST LABORATORY | 8 |
| 3.2 | ENVIRONMENTAL CONDITIONS | 8 |
| 3.3 | MEASUREMENT UNCERTAINTY | 8 |
| 3.4 | TEST SOFTWARE | 8 |
| 4 | EQUIPMENT LIST | 9 |
| 5 | TEST RESULT | 10 |
| 5.1 | ANTENNA REQUIREMENT | 10 |
| 5.1.1 | <i>Standard requirement</i> | 10 |
| 5.1.2 | <i>EUT Antenna</i> | 10 |
| 5.2 | PEAK OUTPUT POWER | 11 |
| 5.2.1 | <i>Limit</i> | 11 |
| 5.2.2 | <i>Test setup</i> | 11 |
| 5.2.3 | <i>Test procedure</i> | 11 |
| 5.2.4 | <i>Test results</i> | 12 |
| 5.3 | POWER SPECTRAL DENSITY | 13 |
| 5.3.1 | <i>Limit</i> | 13 |
| 5.3.2 | <i>Test Setup</i> | 13 |
| 5.3.3 | <i>Test Procedure</i> | 13 |
| 5.3.4 | <i>Test Results</i> | 14 |
| 5.4 | CONDUCTED EMISSION | 18 |
| 5.4.1 | <i>Limits</i> | 18 |
| 5.4.2 | <i>Test setup</i> | 18 |
| 5.4.3 | <i>Test procedure</i> | 19 |
| 5.4.4 | <i>Test results</i> | 20 |
| 5.5 | RADIATED SPURIOUS | 24 |
| 5.5.1 | <i>Limits</i> | 24 |
| 5.5.2 | <i>Test setup</i> | 25 |
| 5.5.3 | <i>Test procedure</i> | 26 |
| 5.5.4 | <i>Test results</i> | 27 |
| 5.5.4.1 | <i>Radiation emission</i> | 27 |
| 5.5.4.2 | <i>Band edge - radiated</i> | 31 |
| 5.5.4.3 | <i>Spurious Emission in Restricted Band 3260MMHz-18000MHz</i> | 33 |
| 5.6 | CONDUCTION SPURIOUS EMISSION | 34 |
| 5.6.1 | <i>Limits</i> | 34 |
| 5.6.2 | <i>Test setup</i> | 34 |
| 5.6.3 | <i>Test procedure</i> | 34 |
| 5.6.4 | <i>Test results</i> | 35 |
| 5.7 | 6DB BANDWIDTH | 39 |
| 5.7.1 | <i>Limit</i> | 39 |
| 5.7.2 | <i>Test setup</i> | 39 |
| 5.7.3 | <i>Test procedure</i> | 39 |
| 5.7.4 | <i>Test results</i> | 40 |
| | PHOTOGRAPHS OF THE TEST SETUP | 48 |
| | PHOTOGRAPHS OF THE EUT | 50 |

Test Result Certification

Applicant's name: Shenzhen Smart-eye Digital Electronics Co.,Ltd
Address: #6 Northern Zone, Shangxue S&T City, Bantian, Longgang District, Shenzhen, China.

Manufacture's name: Shenzhen Smart-eye Digital Electronics Co.,Ltd
Address: #6 Northern Zone, Shangxue S&T City, Bantian, Longgang District, Shenzhen, China.

Product name: Base Station

Trademark: N/A

Model name: 850G

Serial Model: 851G, 852G, T1, T2, T3

Standards: FCC Part 15.247
ANSI C63.10-2013

Test Procedure: KDB 558074 D01 DTS Meas Guidance v04
KDB 174176 D01 Line Conducted FAQ v01r01

This device described above has been tested by Shenzhen Microtest Co., Ltd. and the test results show that the equipment under test (EUT) compliance with the FCC requirements. And it is applicable only to the tested sample identified in the report.

Tested by:



Demi Mu

Sept. 05, 2018

Reviewed by:



Blue Zheng

Sept. 05, 2018

Approved by:



Smith Chen

Sept. 05, 2018

1 General information

1.1 Description of EUT

| | |
|--------------------------|---|
| Product name: | Base Station |
| Model name: | 850G |
| Serial Model: | 851G, 852G, T1, T2, T3 |
| Model difference: | The wireless module used in the product is the same, just different in appearance and color. |
| Operation frequency: | 802.11b/g/n20:2412~2462 MHz 802.11n40:2422~2452 MHz |
| Modulation type: | IEEE 802.11b : DSSS (DBPSK, DQPSK, CCK) IEEE 802.11g/n (HT20/HT40) : OFDM (64QAM, 16QAM, QPSK, BPSK) |
| Bit Rate of transmitter: | 802.11b:11/5.5/2/1 Mbps 802.11g:54/48/36/24/18/12/9/6Mbps 802.11n(20MHz) use 800 ns GI: 65.0/58.5/52.0/39.0/26.0/19.5/13.0/6.5 Mbps (MCS0~MCS7) 802.11n(40MHz) use 800 ns GI: 13.5/27/40.5/54/81/108/121.5/135Mbps |
| Antenna type: | Metal Antenna |
| Antenna gain: | 3dBi |
| Max. output power: | 16.80dBm |
| Power supply: | DC 5V from adapter |
| Battery: | N/A |
| Adapter information: | Model:GLH50D2000HW Input:100-240V~ 50/60Hz 0.40A Output:5V 2000mA |
| Hardware version: | v1.0 |
| Software version: | V-2.0.13 |

1.2 Operation channel list

Channel List for 802.11b/g/n(20)

| Channel | Frequency (MHz) | Channel | Frequency (MHz) |
|---------|-----------------|---------|-----------------|
| 01 | 2412 | 07 | 2442 |
| 02 | 2417 | 08 | 2447 |
| 03 | 2422 | 09 | 2452 |
| 04 | 2427 | 10 | 2457 |
| 05 | 2432 | 11 | 2462 |
| 06 | 2437 | \ | \ |

Channel List for 802.11n(40)

| Channel | Frequency (MHz) | Channel | Frequency (MHz) |
|---------|-----------------|---------|-----------------|
| 03 | 2422 | 07 | 2442 |
| 04 | 2427 | 08 | 2447 |
| 05 | 2432 | 09 | 2452 |
| 06 | 2437 | \ | \ |

1.3 Test channel list

Channel List for 802.11b/g/n(20)

| Channel | Channel | Frequency (MHz) |
|---------|---------|-----------------|
| Low | 01 | 2412 |
| Middle | 06 | 2437 |
| High | 11 | 2462 |

Channel List for 802.11n(40)

| Channel | Channel | Frequency (MHz) |
|---------|---------|-----------------|
| Low | 03 | 2422 |
| Middle | 06 | 2437 |
| High | 09 | 2452 |

1.4 Ancillary equipment list

| Equipment | Model | S/N | Manufacturer | Certificate type |
|-----------|--------------|-----|--------------|------------------|
| Adapter | GLH50D2000HW | / | / | / |

1.5 Description of Support Units

The EUT has been tested as an independent unit together with other necessary accessories or support units. The following support units or accessories were used to form a representative test configuration during the tests.

| Item | Equipment | Brand | Model/Type No. | Series No. | Note |
|------|-----------|-------|----------------|------------|------|
| / | / | / | / | / | / |
| / | / | / | / | / | / |

Note:

- (1)The support equipment was authorized by Declaration of Confirmation.
- (2)For detachable type I/O cable should be specified the length in cm in 『Length』 column.

2 Summary of Test Results

Test procedures according to the technical standards:

| No. | Standard Section | Test Item | Result | Remark |
|-----|---------------------|----------------------------|--------|--------|
| 1 | 15.203 | Antenna Requirement | Pass | |
| 2 | 15.247 (b) | Peak Output Power | Pass | |
| 3 | 15.247 (e) | Power Spectral Density | Pass | |
| 4 | 15.207 | Conducted Emission | Pass | |
| 5 | 15.247 (d) & 15.209 | Radiated Spurious Emission | Pass | |
| 6 | 15.205 | Band Edge Emission | Pass | |
| 7 | 15.247 (a)(2) | 6dB Bandwidth | Pass | |

3 Test Facilities and Accreditations

3.1 Test laboratory

| | |
|-----------------------|---|
| Test Laboratory | Shenzhen Microtest Co., Ltd |
| Location | No.102A & 302A, East Block, Hengfang Industrial Park, Xingye Road, Xixiang, Bao'an District, Shenzhen, Guangdong, China |
| FCC Registration No.: | FCC Registration No.: 448573 |

3.2 Environmental conditions

| | |
|----------------------|--------------|
| Temperature: | 20°C~30°C |
| Humidity | 30%~70% |
| Atmospheric pressure | 98kPa~101kPa |

3.3 Measurement uncertainty

The reported uncertainty of measurement $y \pm U$, where expanded uncertainty U is based on a standard uncertainty multiplied by a coverage factor of $k=2$, providing a level of confidence of approximately 95 %

| No. | Item | Uncertainty |
|-----|-------------------------------|-------------------------|
| 1 | Conducted Emission Test | $\pm 1.38\text{dB}$ |
| 2 | RF power, conducted | $\pm 0.16\text{dB}$ |
| 3 | Spurious emissions, conducted | $\pm 0.21\text{dB}$ |
| 4 | All emissions, radiated(<1G) | $\pm 4.68\text{dB}$ |
| 5 | All emissions, radiated(>1G) | $\pm 4.89\text{dB}$ |
| 6 | Temperature | $\pm 0.5^\circ\text{C}$ |
| 7 | Humidity | $\pm 2\%$ |

3.4 Test software

| Software Name | Manufacturer | Model | Version |
|----------------|--------------|-------|-----------|
| RF Test System | Farad | LZ-RF | Lz_Rf 3A3 |

4 Equipment list

| Equipment No. | Equipment Name | Manufacturer | Model | Serial No. | Calibration date | Due date |
|---------------|--|-------------------------------|----------------|---------------|------------------|------------|
| MTI-E001 | Spectrum Analyzer | Agilent | E4407B | MY41441082 | 2017/09/18 | 2018/09/17 |
| MTI-E002 | CMU 200 universal radio communication tester | Rohde&schwarz | CMU 200 | 114587 | 2017/09/18 | 2018/09/17 |
| MTI-E003 | Spectrum Analyzer | R&S | ESCI | MTI-E003 | 2017/09/18 | 2018/09/17 |
| MTI-E004 | EMI Test Receiver | Rohde&schwarz | ESPI | 1000314 | 2017/09/18 | 2018/09/17 |
| MTI-E006 | Broadband antenna | schwarzbeck | VULB9163 | 872 | 2017/09/18 | 2018/09/17 |
| MTI-E007 | Horn antenna | schwarzbeck | BBHA9120D | 1201 | 2017/09/18 | 2018/09/17 |
| MTI-E014 | amplifier | America | 8447D | 3113A06150 | 2017/09/18 | 2018/09/17 |
| MTI-E015 | Conduction Immunity Signal Generator | Schloder | CDG6000 | 126A1343/2015 | 2017/09/18 | 2018/09/17 |
| MTI-E016 | Coupled decoupling network | Schloder | CDA M2/M3 | A2210332/2015 | 2017/09/18 | 2018/09/17 |
| MTI-E032 | Comprehensive test instrument | Rohde&schwarz | CMW500 | 124192 | 2017/09/13 | 2018/09/12 |
| MTI-E034 | amplifier | Agilent | 8449B | 3008A02400 | 2017/08/22 | 2018/08/21 |
| MTI-E037 | Artificial power network | Schwarzbeck | NSLK8127 | #841 | 2017/9/26 | 2018/9/25 |
| MTI-E040 | Spectrum analyzer | Agilent | N9020A | MY49100060 | 2017/09/05 | 2018/09/04 |
| MTI-E041 | Signal generator | Agilent | N5182A | MY49060455 | 2017/09/23 | 2018/09/22 |
| MTI-E042 | Analog signal generator | Agilent | E4421B | GB40051240 | 2017/09/23 | 2018/09/22 |
| MTI-E043 | Power sensor | Dare Instruments | RPR3006W | 16I00054SN016 | 2017/09/29 | 2018/09/28 |
| MTI-E047 | 10dB attenuator | Mini-Circuits | UNAT-10+ | 15542 | 2017/09/24 | 2018/09/23 |
| MTI-E049 | spectrum analyzer | Rohde&schwarz | FSP-38 | 100019 | 2017/09/18 | 2018/09/17 |
| MTI-E050 | PSG Signal generator | Agilent | E8257D | MY46520873 | 2017/09/24 | 2018/09/23 |
| MTI-E051 | Active Loop Antenna 9kHz - 30MHz | Schwarzbeck | FMZB 1519 B | 00044 | 2017/09/26 | 2018/09/25 |
| MTI-E052 | 18-40GHz amplifier | Chengdu step Micro Technology | ZLNA-18-40G-21 | 1608001 | 2017/09/18 | 2018/09/17 |
| MTI-E053 | 15-40G Antenna | Schwarzbeck | BBHA9170 | BBHA9170582 | 2017/09/18 | 2018/09/17 |
| MTI-E058 | Artificial power network | Schwarzbeck | NSLK8127 | #841 | 2017/12/05 | 2018/12/04 |

Note: the calibration interval of the above test instruments is 12 months and the calibrations are traceable to international system unit (SI).

5 Test Result

5.1 Antenna requirement

5.1.1 Standard requirement

15.203 requirement: For intentional device, according to 15.203: an intentional radiator shall be designed to ensure that no antenna other than that furnished by the responsible party shall be used with the device

5.1.2 EUT Antenna

The EUT antenna is Metal antenna (3dBi). It comply with the standard requirement. In case of replacement of broken antenna the same antenna type must be used.

5.2 Peak output power

5.2.1 Limit

| FCC Part15 Subpart C | | | | |
|----------------------|-------------------|-----------------|-----------------------|--------|
| Section | Test Item | Limit | Frequency Range (MHz) | Result |
| 15.247(b)(3) | Peak output power | 1 watt or 30dBm | 2400-2483.5 | Pass |

5.2.2 Test setup

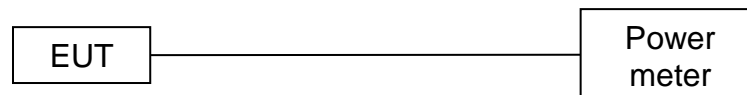

5.2.3 Test procedure

The EUT was directly connected to the Power meter.

5.2.4 Test results

802.11b

| Test Channel | Frequency (MHz) | Maximum Peak Conducted Output Power | LIMIT (dBm) |
|--------------|-----------------|-------------------------------------|-------------|
| CH01 | 2412 | 14.99 | 30 |
| CH06 | 2437 | 15.75 | 30 |
| CH11 | 2462 | 16.80 | 30 |

802.11g

| Test Channel | Frequency (MHz) | Maximum Peak Conducted Output Power | LIMIT (dBm) |
|--------------|-----------------|-------------------------------------|-------------|
| CH01 | 2412 | 13.41 | 30 |
| CH06 | 2437 | 14.30 | 30 |
| CH11 | 2462 | 15.20 | 30 |

802.11n20

| Test Channel | Frequency (MHz) | Maximum Peak Conducted Output Power | LIMIT (dBm) |
|--------------|-----------------|-------------------------------------|-------------|
| CH01 | 2412 | 13.26 | 30 |
| CH06 | 2437 | 14.17 | 30 |
| CH11 | 2462 | 14.72 | 30 |

802.11n40

| Test Channel | Frequency (MHz) | Maximum Peak Conducted Output Power | LIMIT (dBm) |
|--------------|-----------------|-------------------------------------|-------------|
| CH03 | 2422 | 10.43 | 30 |
| CH06 | 2437 | 11.00 | 30 |
| CH09 | 2452 | 11.46 | 30 |

5.3 Power spectral density

5.3.1 Limit

| FCC Part15 Subpart C | | | | |
|----------------------|------------------------|------------------------|-----------------------|--------|
| Section | Test Item | Limit | Frequency Range (MHz) | Result |
| 15.247 | Power Spectral Density | 8 dBm (in any 3kHz) | 2400-2483.5 | Pass |

5.3.2 Test Setup

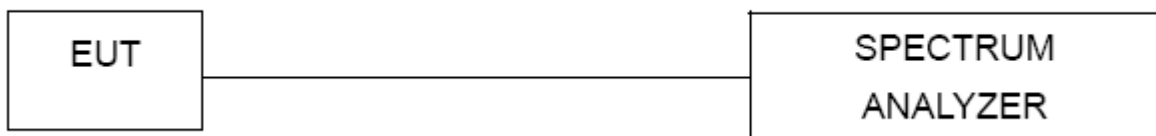

5.3.3 Test Procedure

- a. The EUT tested system was configured as the statements of 2.1 unless otherwise a special operating condition is specified in the follows during the testing.
- b. Set analyzer center frequency to DTS channel center frequency.
- c. Set the span to 1.5 times the DTS channel bandwidth.
- d. Set the RBW ≥ 3 kHz.
- e. Set the VBW $\geq 3 \times$ RBW.
- f. Detector = peak.
- g. Sweep time = auto couple.
- h. Trace mode = max hold.
- i. Allow trace to fully stabilize.
- j. Use the peak marker function to determine the maximum amplitude level.
- k. If measured value exceeds limit, reduce RBW (no less than 3 kHz) and repeat.

5.3.4 Test Results

| 802.11b | | | |
|-----------|--------------------------|-------------------|--------|
| Frequency | Power Density (dBm/3kHz) | Limit 8(dBm/3kHz) | Result |
| 2412 MHz | -7.756 | 8 | Pass |
| 2437 MHz | -9.226 | 8 | Pass |
| 2462 MHz | -8.217 | 8 | Pass |

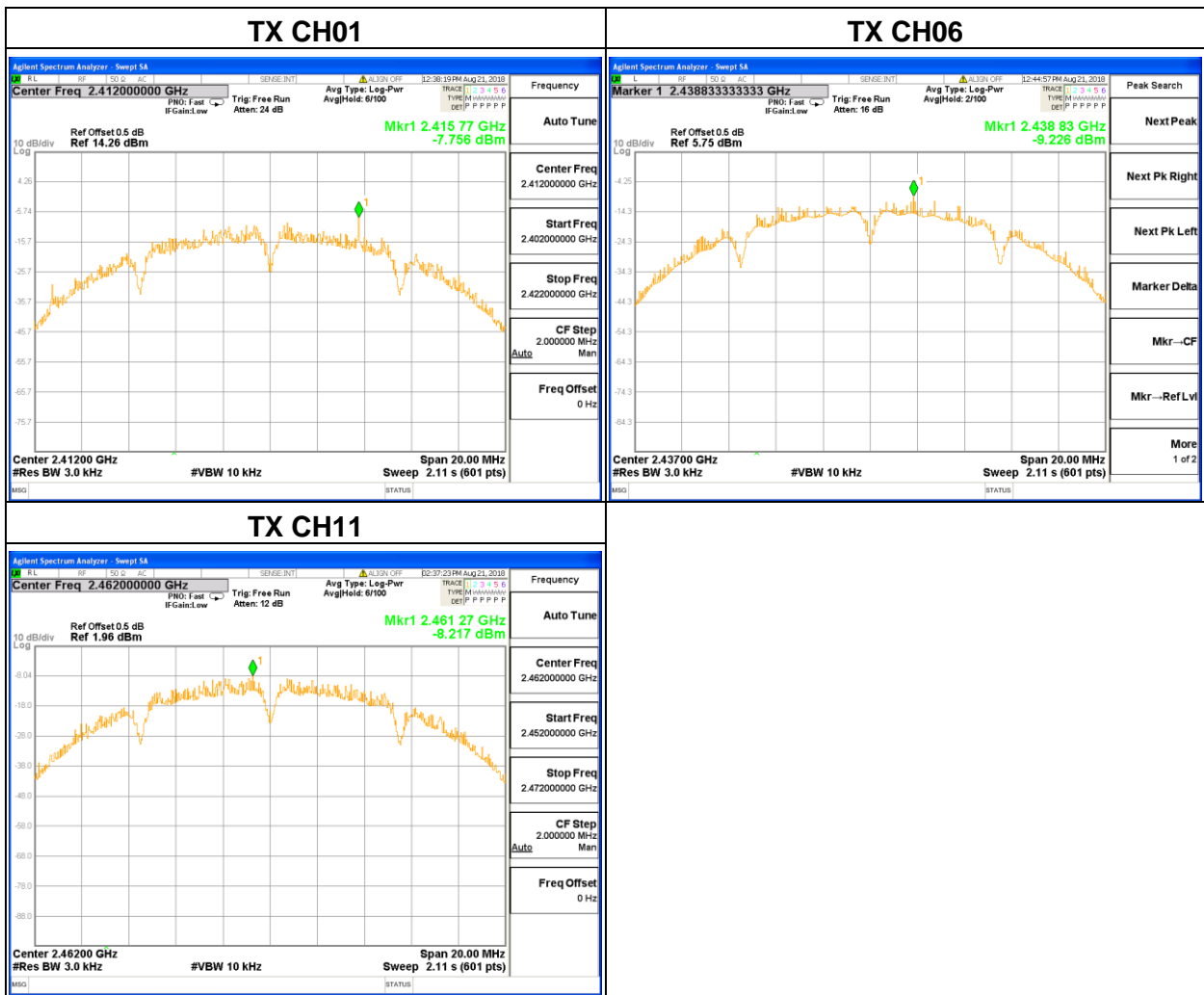

| 802.11g | | | |
|-----------|-------------------------|-------------------|--------|
| Frequency | Power Density (dBm/kHz) | Limit 8(dBm/3kHz) | Result |
| 2412 MHz | -12.844 | 8 | Pass |
| 2437 MHz | -12.396 | 8 | Pass |
| 2462 MHz | -11.073 | 8 | Pass |

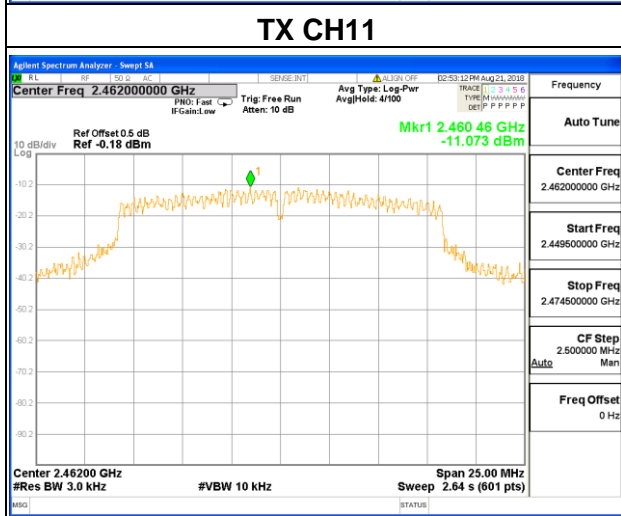
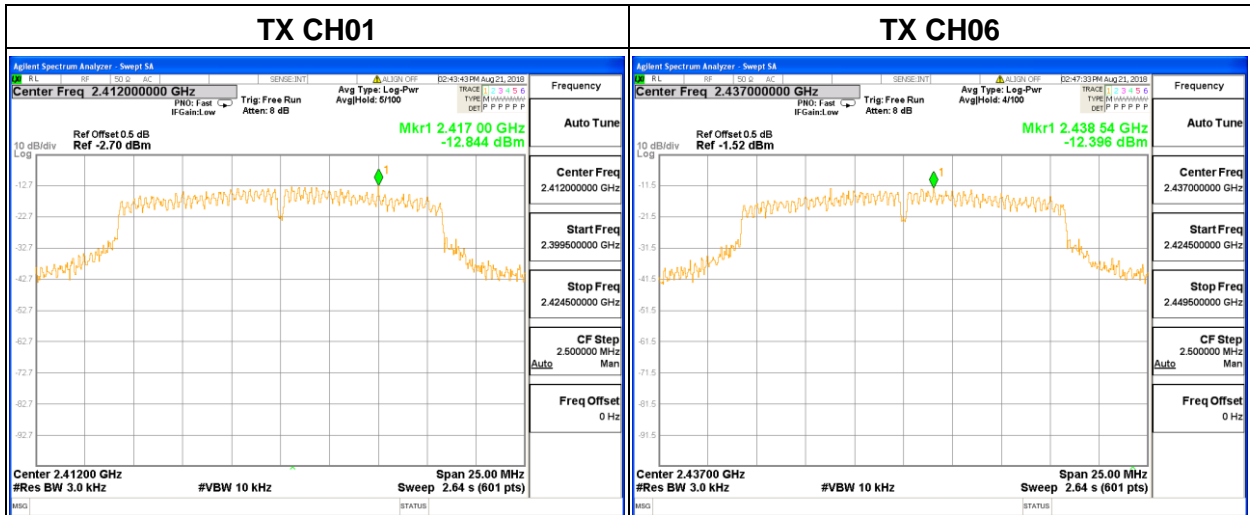

| 802.11n20 | | | |
|-----------|-------------------------|-------------------|--------|
| Frequency | Power Density (dBm/kHz) | Limit 8(dBm/3kHz) | Result |
| 2412 MHz | -13.526 | 8 | Pass |
| 2437 MHz | -12.557 | 8 | Pass |
| 2462 MHz | -11.031 | 8 | Pass |

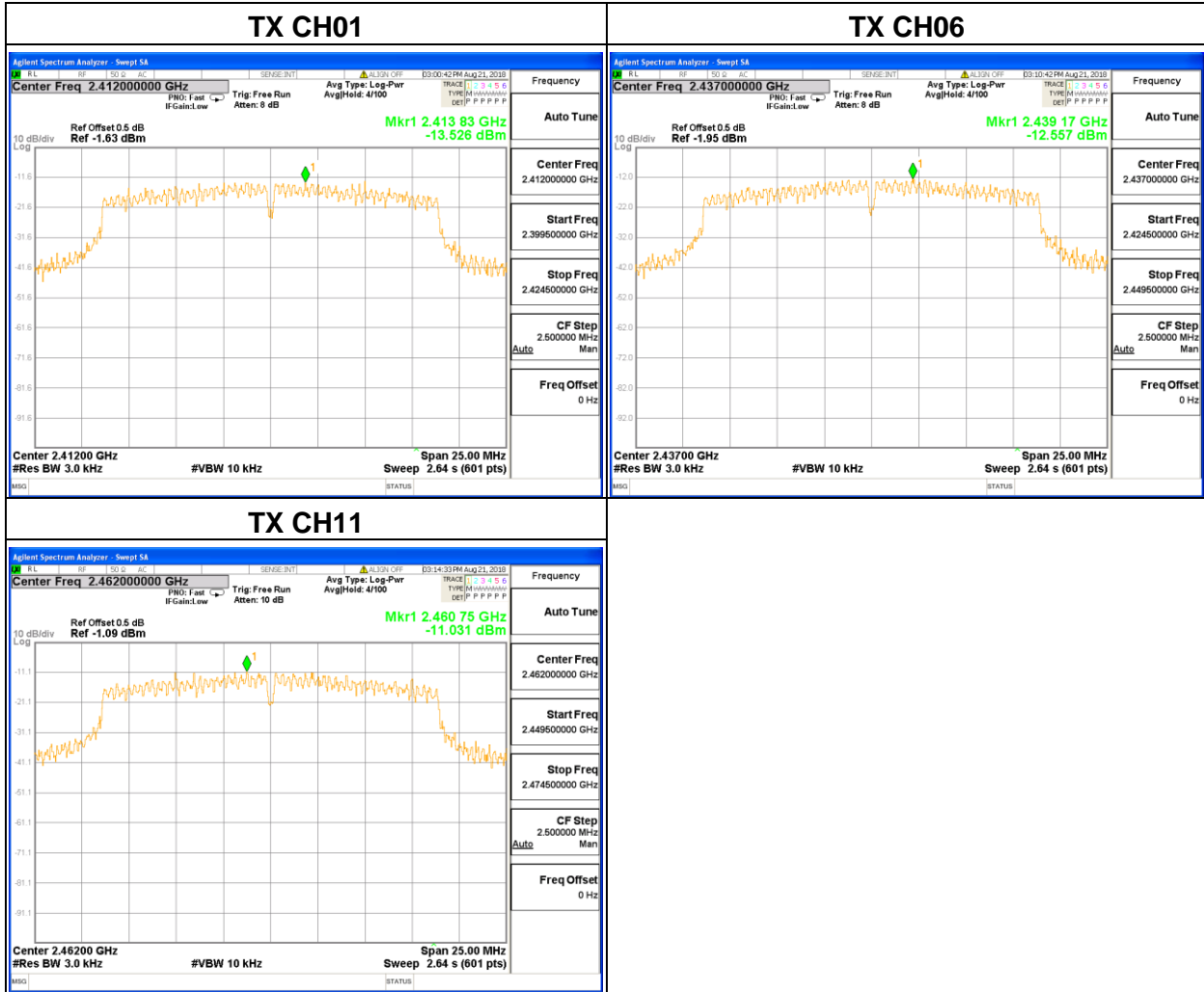

| 802.11n40 | | | |
|-----------|-------------------------|-------------------|--------|
| Frequency | Power Density (dBm/kHz) | Limit 8(dBm/3kHz) | Result |
| 2422 MHz | -15.270 | 8 | Pass |
| 2437 MHz | -15.651 | 8 | Pass |
| 2452 MHz | -14.966 | 8 | Pass |

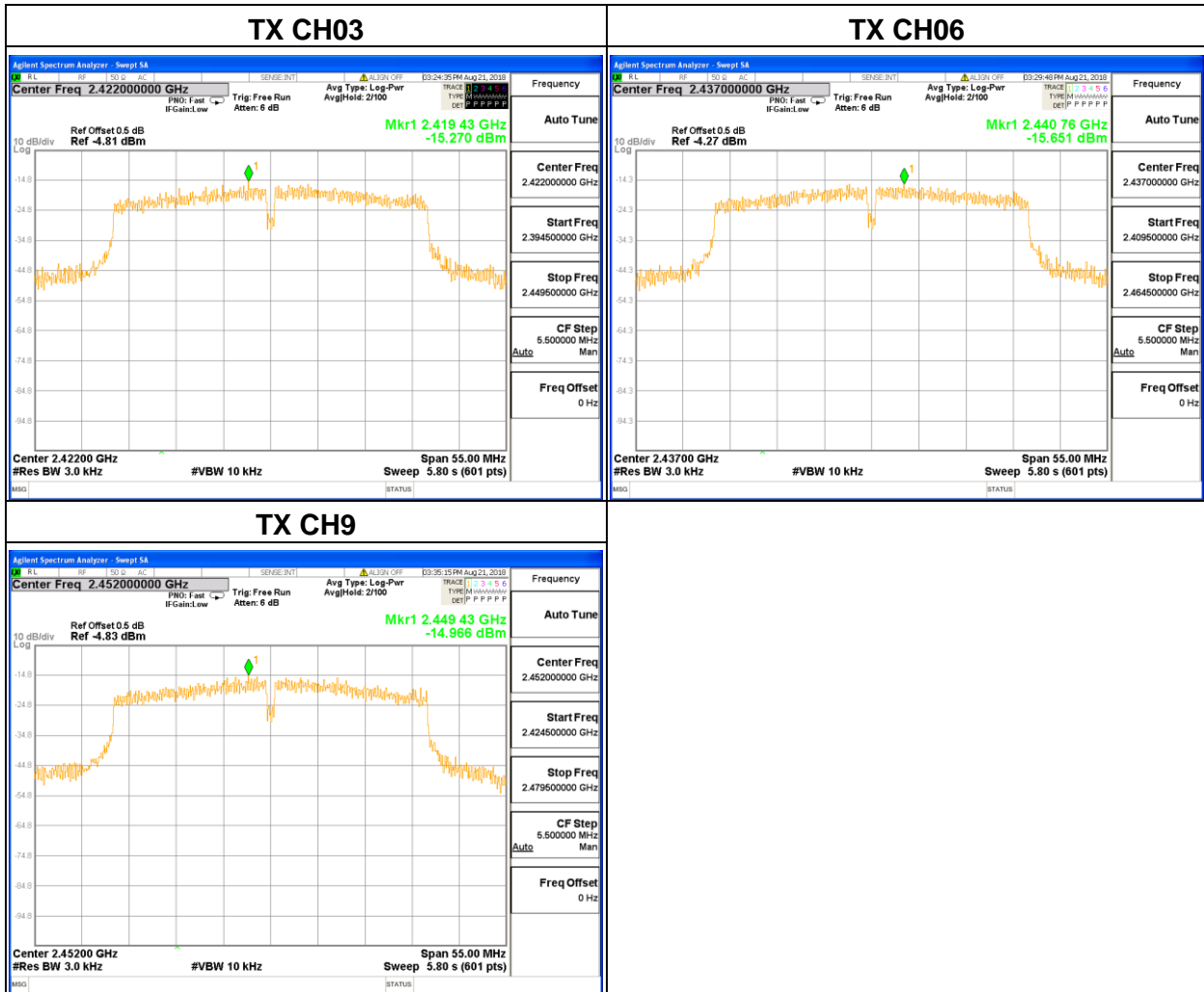

5.4 Conducted emission

5.4.1 Limits

According to FCC Part 15.207(a) and KDB 174176 D01 Line Conducted FAQ v01r01.

| FREQUENCY (MHz) | Class B (dBuV) | |
|-----------------|----------------|-----------|
| | Quasi-peak | Average |
| 0.15 -0.5 | 66 - 56 * | 56 - 46 * |
| 0.50 -5.0 | 56.00 | 46.00 |
| 5.0 -30.0 | 60.00 | 50.00 |

Note

(1)The tighter limit applies at the band edges.

(2)The limit of " * " marked band means the limitation decreases linearly with the logarithm of the frequency in the range.

5.4.2 Test setup

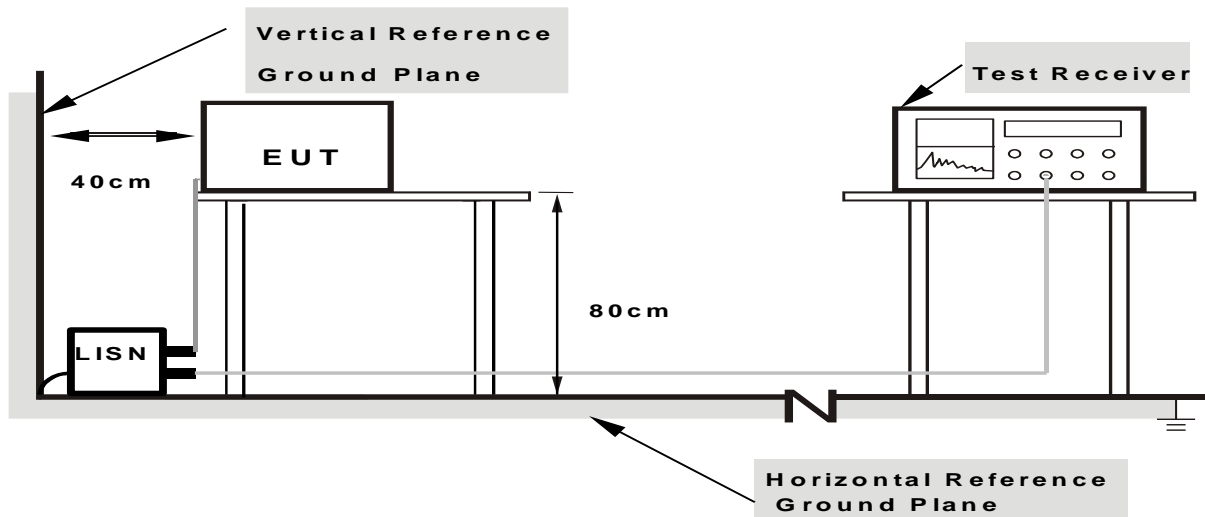

Note: 1.Support units were connected to second LISN.

2.Both of LISNs (AMN) are 80 cm from EUT and at least 80 from other units and other metal planes

5.4.3 Test procedure

a. EUT Operating Conditions

The EUT was configured for testing in a typical fashion (as a customer would normally use it). The EUT has been programmed to continuously transmit during test. This operating condition was tested and used to collect the included data.

b. The following table is the setting of the receiver

| Receiver Parameters | Setting |
|---------------------|----------|
| Attenuation | 10 dB |
| Start Frequency | 0.15 MHz |
| Stop Frequency | 30 MHz |
| IF Bandwidth | 9 kHz |

- c. The EUT was placed 0.8 meters from the horizontal ground plane with EUT being connected to the power mains through a line impedance stabilization network (LISN). All other support equipments powered from additional LISN(s). The LISN provide 50 Ohm/ 50uH of coupling impedance for the measuring instrument.
- d. Interconnecting cables that hang closer than 40 cm to the ground plane shall be folded back and forth in the center forming a bundle 30 to 40 cm long.
- e. I/O cables that are not connected to a peripheral shall be bundled in the center. The end of the cable may be terminated, if required, using the correct terminating impedance. The overall length shall not exceed 1 m.
- f. LISN at least 80 cm from nearest part of EUT chassis.

For the actual test configuration, please refer to the related Item –EUT Test Photos.

5.4.4 Test results

| | | | |
|----------------|---------------------------------|---------------------|------|
| EUT : | Base Station | Model Name. : | 850G |
| Temperature : | 26 °C | Relative Humidity : | 54% |
| Pressure : | 1010hPa | Phase : | L |
| Test Voltage : | DC 5V from adapter AC 120V/60Hz | Test Mode : | TX |

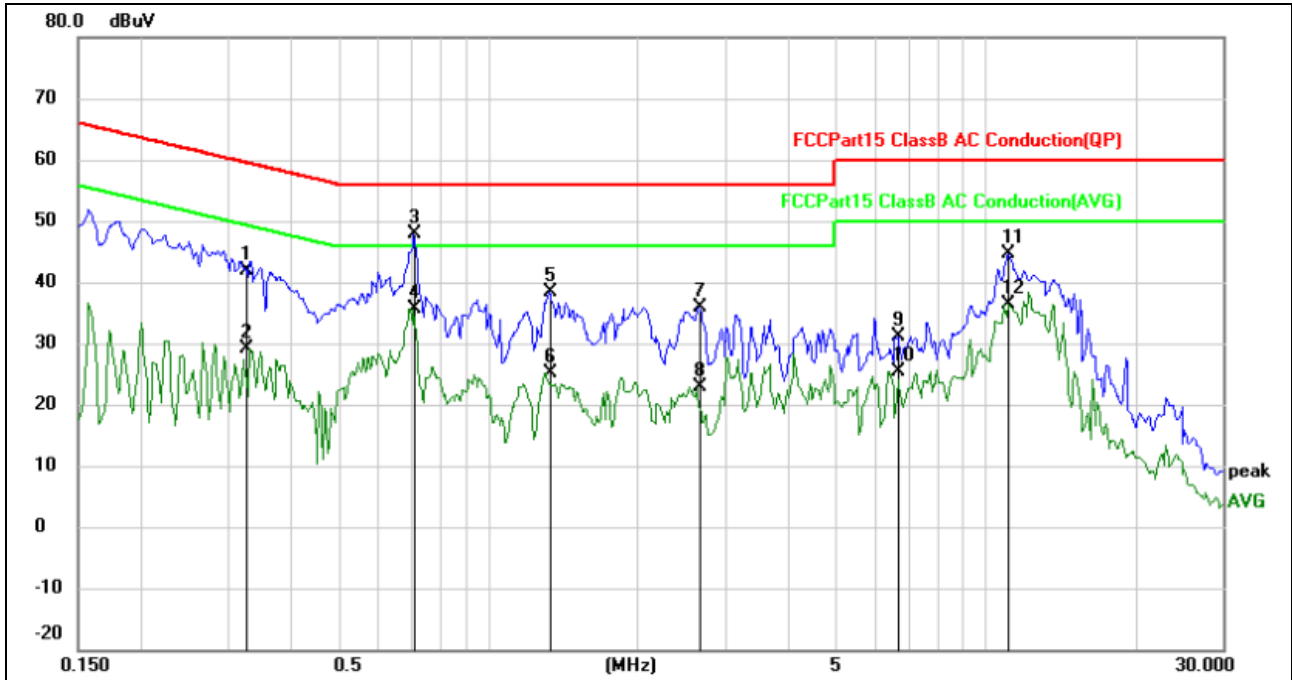

| No. | Mk. | Freq. | Reading Level | Correct Factor | Measurement | Limit | Over | Detector | Comment |
|-----|-----|---------|---------------|----------------|-------------|-------|--------|----------|---------|
| | | MHz | dBuV | dB | dBuV | dBuV | dB | | |
| 1 | | 0.3268 | 40.25 | 1.57 | 41.82 | 59.53 | -17.71 | QP | |
| 2 | | 0.3268 | 27.45 | 1.57 | 29.02 | 49.53 | -20.51 | AVG | |
| 3 | * | 0.7086 | 46.35 | 1.57 | 47.92 | 56.00 | -8.08 | QP | |
| 4 | | 0.7086 | 34.11 | 1.57 | 35.68 | 46.00 | -10.32 | AVG | |
| 5 | | 1.3297 | 36.71 | 1.58 | 38.29 | 56.00 | -17.71 | QP | |
| 6 | | 1.3297 | 23.48 | 1.58 | 25.06 | 46.00 | -20.94 | AVG | |
| 7 | | 2.6617 | 34.70 | 1.17 | 35.87 | 56.00 | -20.13 | QP | |
| 8 | | 2.6617 | 21.75 | 1.17 | 22.92 | 46.00 | -23.08 | AVG | |
| 9 | | 6.6680 | 30.63 | 0.38 | 31.01 | 60.00 | -28.99 | QP | |
| 10 | | 6.6680 | 24.98 | 0.38 | 25.36 | 50.00 | -24.64 | AVG | |
| 11 | | 11.1289 | 44.21 | 0.37 | 44.58 | 60.00 | -15.42 | QP | |
| 12 | | 11.1289 | 36.09 | 0.37 | 36.46 | 50.00 | -13.54 | AVG | |

| | | | |
|----------------|---------------------------------|---------------------|------|
| EUT : | Base Station | Model Name. : | 850G |
| Temperature : | 26 °C | Relative Humidity : | 54% |
| Pressure : | 1010hPa | Phase : | N |
| Test Voltage : | DC 5V from adapter AC 120V/60Hz | Test Mode : | TX |

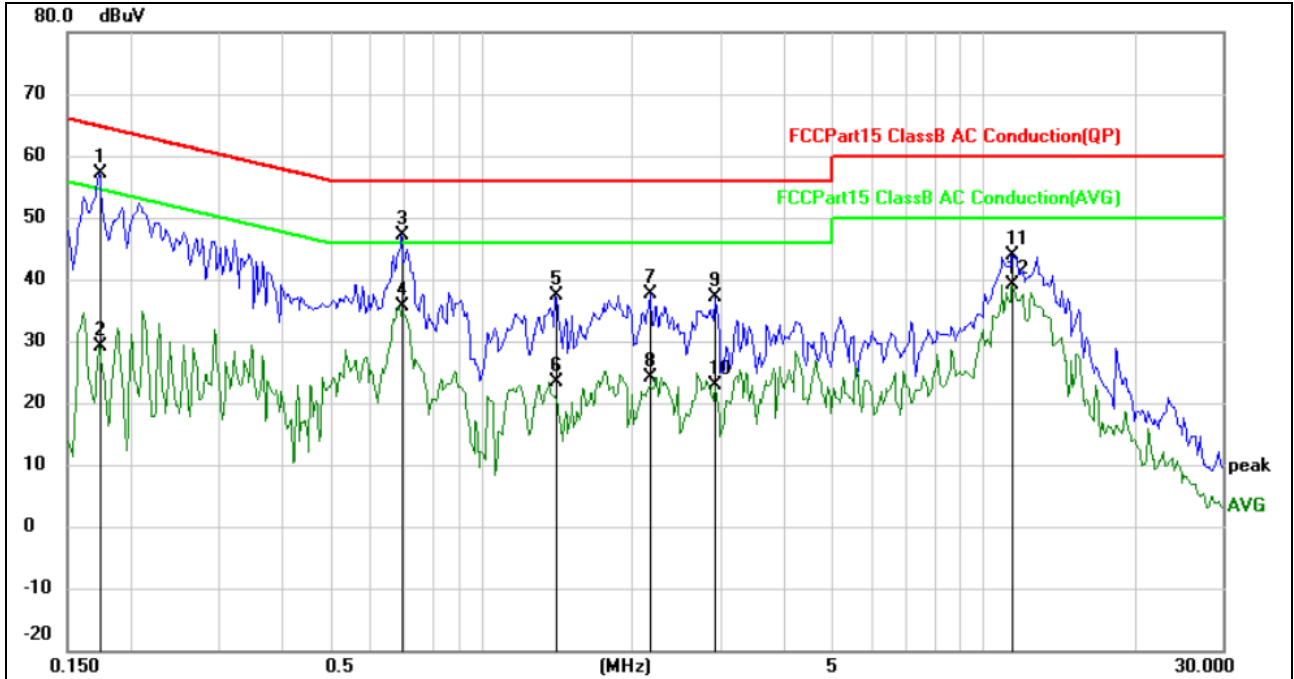

| No. | Mk. | Freq. | Reading Level | Correct Factor | Measurement | Limit | Over | Detector | Comment |
|-----|-----|---------|---------------|----------------|-------------|-------|--------|----------|---------|
| | | MHz | dBuV | dB | dBuV | dBuV | dB | | |
| 1 | * | 0.1734 | 55.68 | 1.57 | 57.25 | 64.80 | -7.55 | QP | |
| 2 | | 0.1734 | 27.57 | 1.57 | 29.14 | 54.80 | -25.66 | AVG | |
| 3 | | 0.6969 | 45.44 | 1.57 | 47.01 | 56.00 | -8.99 | QP | |
| 4 | | 0.6969 | 34.01 | 1.57 | 35.58 | 46.00 | -10.42 | AVG | |
| 5 | | 1.4078 | 35.72 | 1.58 | 37.30 | 56.00 | -18.70 | QP | |
| 6 | | 1.4078 | 21.82 | 1.58 | 23.40 | 46.00 | -22.60 | AVG | |
| 7 | | 2.1773 | 36.13 | 1.46 | 37.59 | 56.00 | -18.41 | QP | |
| 8 | | 2.1773 | 22.79 | 1.46 | 24.25 | 46.00 | -21.75 | AVG | |
| 9 | | 2.9234 | 36.15 | 1.06 | 37.21 | 56.00 | -18.79 | QP | |
| 10 | | 2.9234 | 21.87 | 1.06 | 22.93 | 46.00 | -23.07 | AVG | |
| 11 | | 11.4336 | 43.41 | 0.37 | 43.78 | 60.00 | -16.22 | QP | |
| 12 | | 11.4336 | 38.77 | 0.37 | 39.14 | 50.00 | -10.86 | AVG | |

| | | | |
|----------------|---------------------------------|---------------------|------|
| EUT : | Base Station | Model Name. : | 850G |
| Temperature : | 26 °C | Relative Humidity : | 54% |
| Pressure : | 1010hPa | Phase : | L |
| Test Voltage : | DC 5V from adapter AC 240V/60Hz | Test Mode : | TX |

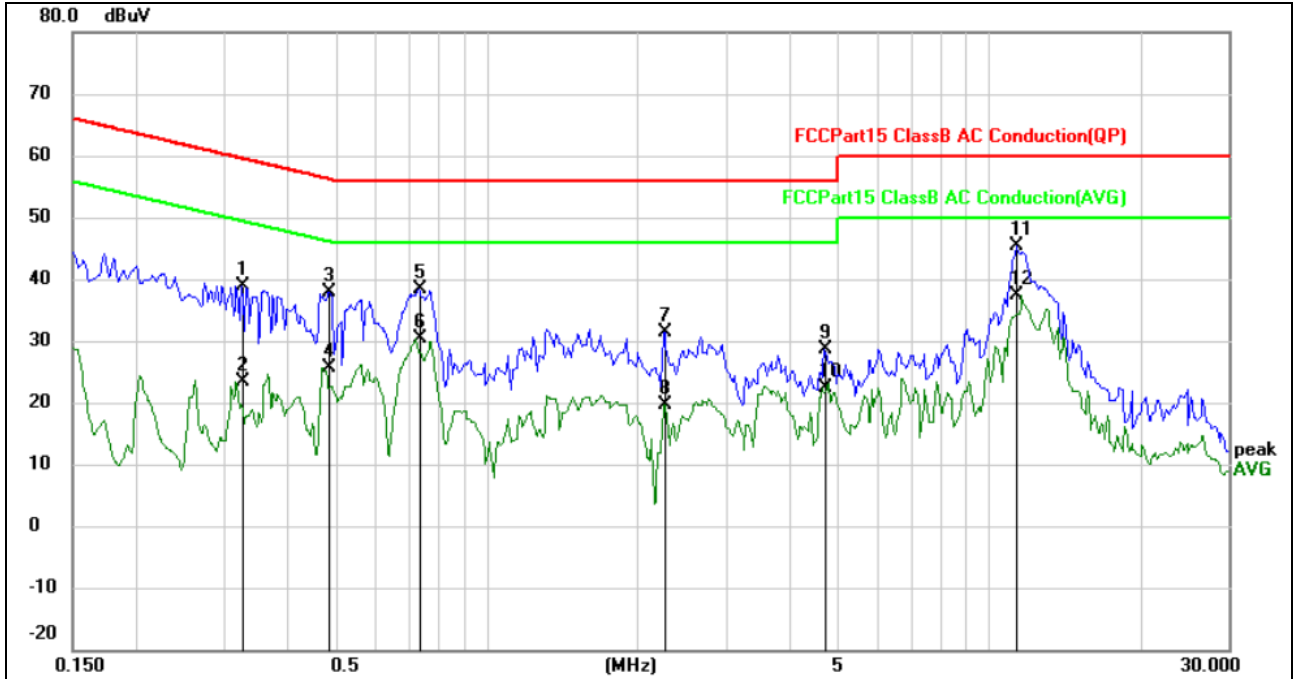

| No. | Mk. | Freq. MHz | Reading Level dBuV | Correct Factor dB | Measure- ment dBuV | Limit dBuV | Over dB | Detector | Comment |
|-----|-----|--------------|--------------------------|-------------------------|--------------------------|---------------|------------|----------|---------|
| 1 | | 0.3256 | 38.78 | 0.02 | 38.80 | 59.56 | -20.76 | QP | |
| 2 | | 0.3256 | 23.43 | 0.02 | 23.45 | 49.56 | -26.11 | AVG | |
| 3 | | 0.4858 | 37.92 | 0.02 | 37.94 | 56.24 | -18.30 | QP | |
| 4 | | 0.4858 | 25.54 | 0.02 | 25.56 | 46.24 | -20.68 | AVG | |
| 5 | | 0.7319 | 38.36 | 0.02 | 38.38 | 56.00 | -17.62 | QP | |
| 6 | | 0.7319 | 30.38 | 0.02 | 30.40 | 46.00 | -15.60 | AVG | |
| 7 | | 2.2594 | 31.44 | 0.03 | 31.47 | 56.00 | -24.53 | QP | |
| 8 | | 2.2594 | 19.72 | 0.03 | 19.75 | 46.00 | -26.25 | AVG | |
| 9 | | 4.6992 | 28.58 | 0.04 | 28.62 | 56.00 | -27.38 | QP | |
| 10 | | 4.6992 | 22.24 | 0.04 | 22.28 | 46.00 | -23.72 | AVG | |
| 11 | | 11.3555 | 45.20 | 0.10 | 45.30 | 60.00 | -14.70 | QP | |
| 12 | * | 11.3555 | 37.20 | 0.10 | 37.30 | 50.00 | -12.70 | AVG | |

| | | | |
|----------------|---------------------------------|---------------------|------|
| EUT : | Base Station | Model Name. : | 850G |
| Temperature : | 26 °C | Relative Humidity : | 54% |
| Pressure : | 1010hPa | Phase : | N |
| Test Voltage : | DC 5V from adapter AC 240V/60Hz | Test Mode : | TX |

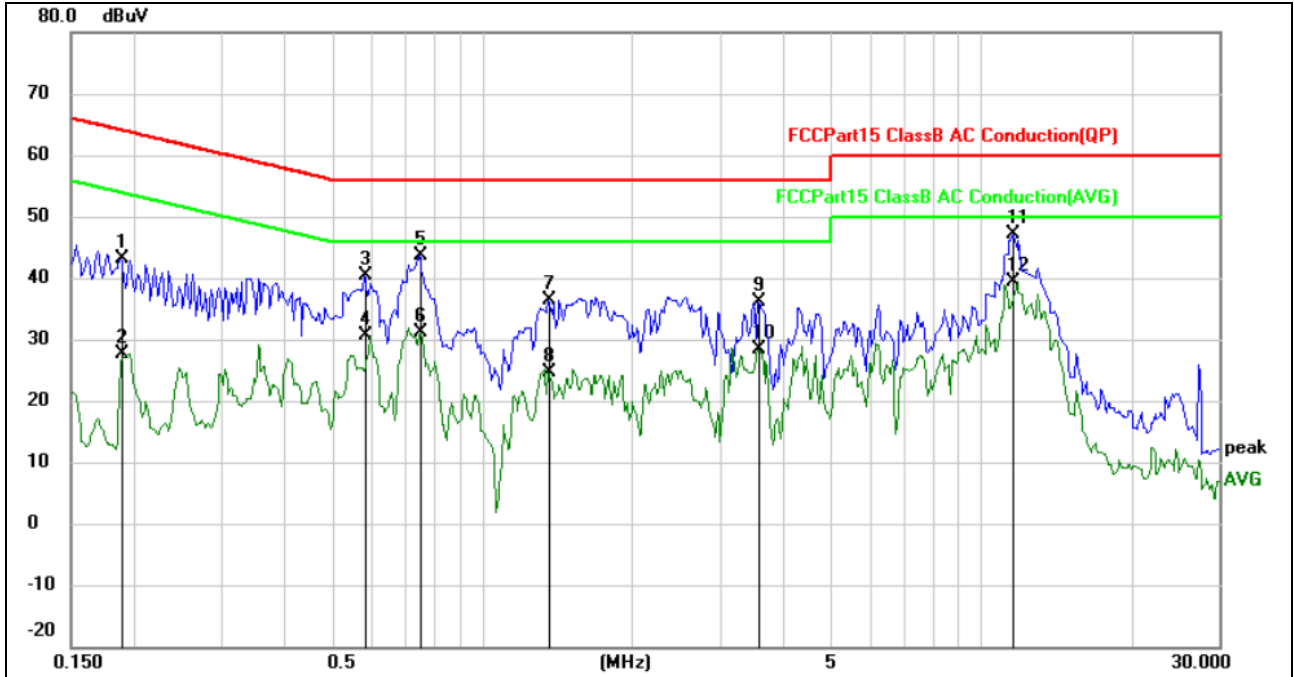

| No. | Mk. | Freq. MHz | Reading Level dBuV | Correct Factor dB | Measurement dBuV | Limit dBuV | Over dB | Detector | Comment |
|-----|-----|-----------|--------------------|-------------------|------------------|------------|---------|----------|---------|
| 1 | | 0.1890 | 43.16 | 0.02 | 43.18 | 64.08 | -20.90 | QP | |
| 2 | | 0.1890 | 27.73 | 0.02 | 27.75 | 54.08 | -26.33 | AVG | |
| 3 | | 0.5796 | 40.43 | 0.02 | 40.45 | 56.00 | -15.55 | QP | |
| 4 | | 0.5796 | 30.50 | 0.02 | 30.52 | 46.00 | -15.48 | AVG | |
| 5 | | 0.7477 | 43.65 | 0.02 | 43.67 | 56.00 | -12.33 | QP | |
| 6 | | 0.7477 | 31.15 | 0.02 | 31.17 | 46.00 | -14.83 | AVG | |
| 7 | | 1.3569 | 36.36 | 0.02 | 36.38 | 56.00 | -19.62 | QP | |
| 8 | | 1.3569 | 24.49 | 0.02 | 24.51 | 46.00 | -21.49 | AVG | |
| 9 | | 3.5703 | 36.15 | 0.04 | 36.19 | 56.00 | -19.81 | QP | |
| 10 | | 3.5703 | 28.27 | 0.04 | 28.31 | 46.00 | -17.69 | AVG | |
| 11 | | 11.5977 | 46.95 | 0.10 | 47.05 | 60.00 | -12.95 | QP | |
| 12 | * | 11.5977 | 39.36 | 0.10 | 39.46 | 50.00 | -10.54 | AVG | |

5.5 Radiated spurious

5.5.1 Limits

20dBc in any 100 kHz bandwidth outside the operating frequency band. In case the emission fall within the restricted band specified on 15.205(a), then the 15.209(a) limit in the table below has to be followed.

| Frequency (MHz) | Field Strength (micorvolts/meter) | Measurement Distance (meters) |
|-----------------|-----------------------------------|-------------------------------|
| 0.009~0.490 | 2400/F(KHz) | 300 |
| 0.490~1.705 | 24000/F(KHz) | 30 |
| 1.705~30.0 | 30 | 30 |
| 30~88 | 100 | 3 |
| 88~216 | 150 | 3 |
| 216~960 | 200 | 3 |
| Above 960 | 500 | 3 |

| Spectrum Parameter | Setting |
|---------------------------------------|--|
| Attenuation | Auto |
| Start Frequency | 1000 MHz |
| Stop Frequency | 10th carrier harmonic |
| RB / VB (emission in restricted band) | 1 MHz / 1 MHz for Peak, 1 MHz / 10Hz for Average |

| Receiver Parameter | Setting |
|------------------------|----------------------------------|
| Attenuation | Auto |
| Start ~ Stop Frequency | 9kHz~150kHz / RB 200Hz for QP |
| Start ~ Stop Frequency | 150kHz~30MHz / RB 9kHz for QP |
| Start ~ Stop Frequency | 30MHz~1000MHz / RB 120kHz for QP |

5.5.2 Test setup

Radiated emission test-up frequency below 30MHz

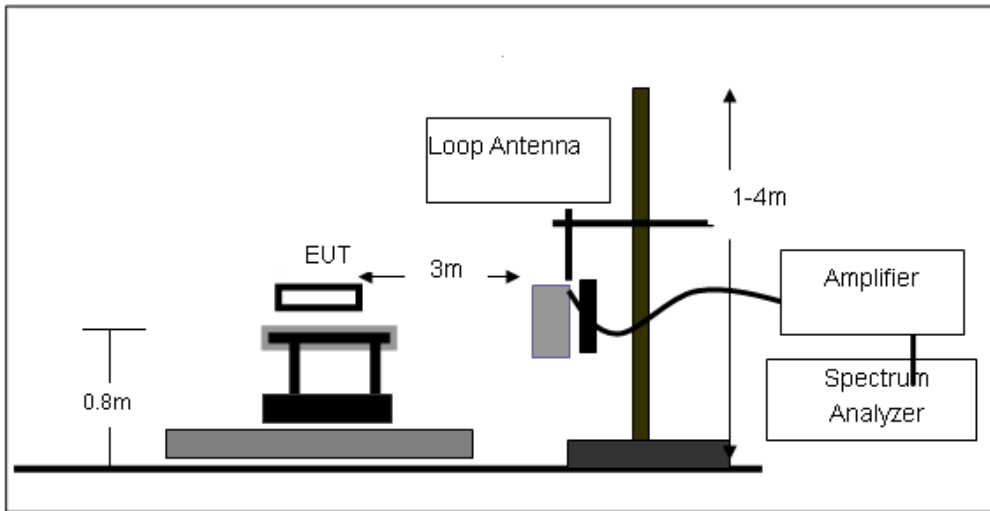

Radiated emission test-up frequency 30MHz~1GHz

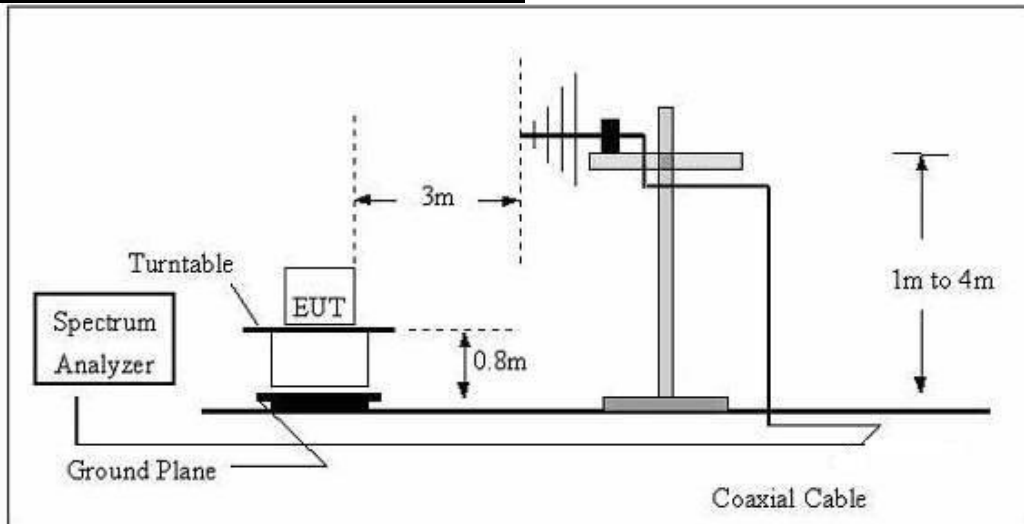

Radiated emission test-up frequency above 1GHz

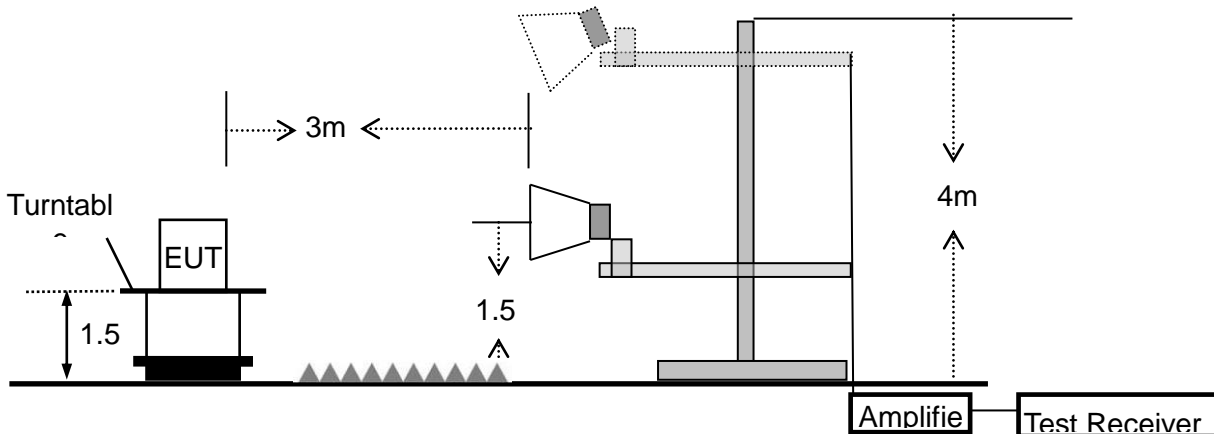

5.5.3 Test procedure

- a. EUT operating conditions. The EUT tested system was configured as the statements of 2.4 unless otherwise a special operating condition is specified in the follows during the testing.
- b. The measuring distance of at 3 m shall be used for measurements at frequency up to 1GHz. For frequencies above 1GHz, any suitable measuring distance may be used.
- c. The EUT was placed on the top of a rotating table 0.8 meters above the ground at a 3 meter open area test site. The table was rotated 360 degrees to determine the position of the highest radiation.
- d. The height of the equipment or of the substitution antenna shall be 0.8 m; the height of the test antenna shall vary between 1 m to 4 m. Both horizontal and vertical polarizations of the antenna are set to make the measurement.
- e. The initial step in collecting conducted emission data is a spectrum analyzer peak detector mode pre-scanning the measurement frequency range. Significant peaks are then marked and then Quasi Peak detector mode re-measured.
- f. If the Peak Mode measured value compliance with and lower than Quasi Peak Mode Limit, the EUT shall be deemed to meet QP Limits and then no additional QP Mode measurement performed.
- g. For the actual test configuration, please refer to the related Item –EUT Test photos.

Note: Both horizontal and vertical antenna polarities were tested and performed pretest to three orthogonal axis. The worst case emissions were reported

5.5.4 Test results

5.5.4.1 Radiation emission

Below 30MHz

| | | | |
|--------------------|--------------|----------------|---------------------------------|
| EUT : | Base Station | Model Name : | 850G |
| Relative Humidity: | 52% | Phase: | H |
| Pressure: | 1010 hPa | Test Voltage : | DC 5V from adapter AC 120V/60Hz |
| Test Mode : | TX | | |

| Freq. (MHz) | Reading (dBuV/m) | Limit (dBuV/m) | Margin (dB) | State P/F |
|----------------|---------------------|-------------------|----------------|--------------|
| -- | -- | -- | -- | Pass |
| -- | -- | -- | -- | Pass |

Note:

The amplitude of spurious emissions which are attenuated by more than 20dB below the permissible value has no need to be reported.

Distance extrapolation factor = $40 \log(\text{specific distance}/\text{test distance})$ (dB);

Limit line = specific limits(dBuV) + distance extrapolation factor.

Between 30MHz – 1GHz

All the modulation modes have been tested, and the worst result was report as below:

| | | | |
|--------------------|--------------|----------------|---------------------------------|
| EUT : | Base Station | Model Name : | 850G |
| Relative Humidity: | 52% | Phase: | H |
| Pressure: | 1010 hPa | Test Voltage : | DC 5V from adapter AC 120V/60Hz |
| Test Mode : | TX | | |

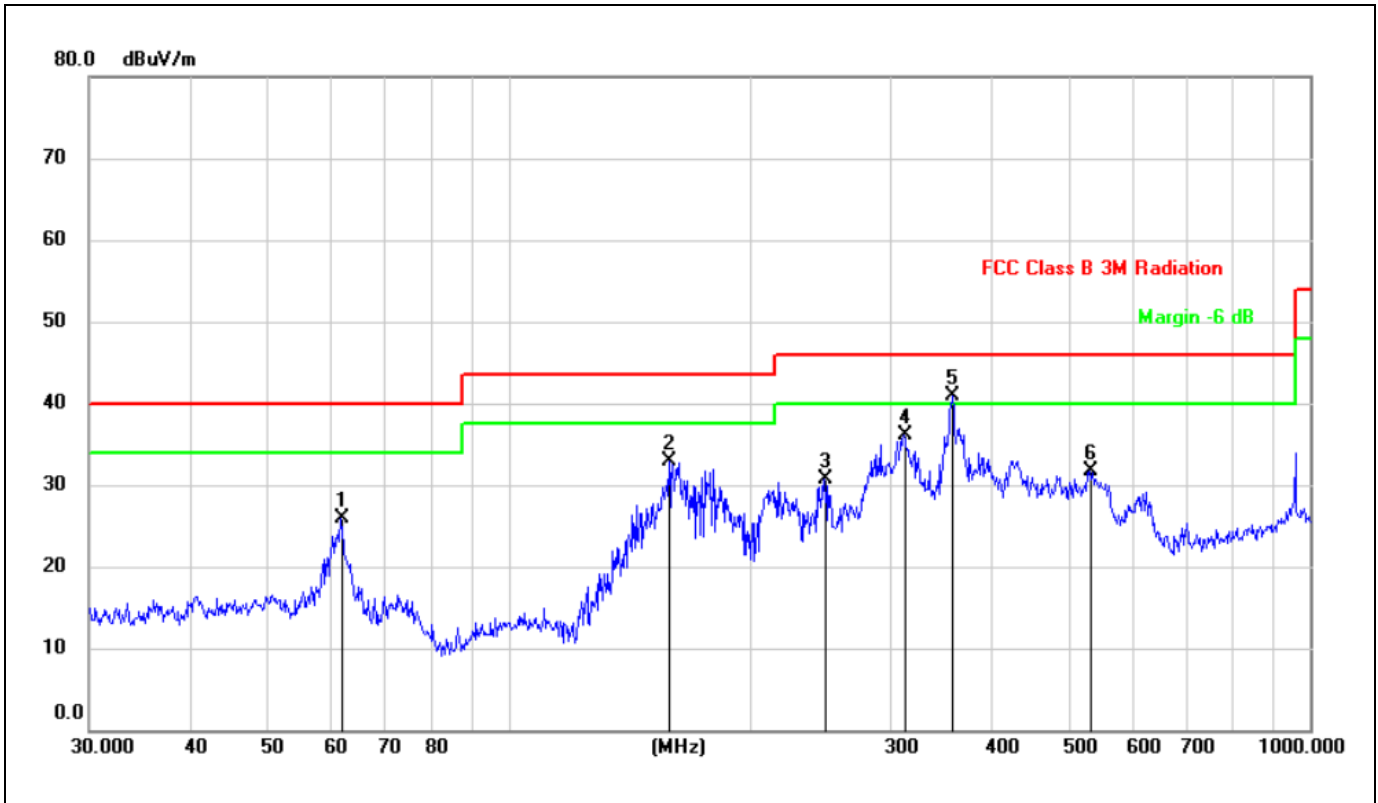

| No. | Mk. | Freq. | Reading Level | Correct Factor | Measurement | Limit | Over | |
|-----|-----|----------|---------------|----------------|-------------|--------|--------|----------|
| | | MHz | dBuV | dBuV/m | dBuV/m | dBuV/m | dB | Detector |
| 1 | | 61.7781 | 37.59 | -11.62 | 25.97 | 40.00 | -14.03 | QP |
| 2 | | 158.6677 | 47.10 | -14.11 | 32.99 | 43.50 | -10.51 | QP |
| 3 | | 247.6819 | 40.76 | -10.10 | 30.66 | 46.00 | -15.34 | QP |
| 4 | | 311.0867 | 44.41 | -8.40 | 36.01 | 46.00 | -9.99 | QP |
| 5 | * | 357.9287 | 48.42 | -7.43 | 40.99 | 46.00 | -5.01 | QP |
| 6 | | 530.1014 | 36.84 | -5.16 | 31.68 | 46.00 | -14.32 | QP |

| | | | |
|--------------------|--------------|----------------|---------------------------------|
| EUT : | Base Station | Model Name : | 850G |
| Relative Humidity: | 52% | Phase: | V |
| Pressure: | 1010 hPa | Test Voltage : | DC 5V from adapter AC 120V/60Hz |
| Test Mode : | TX | | |

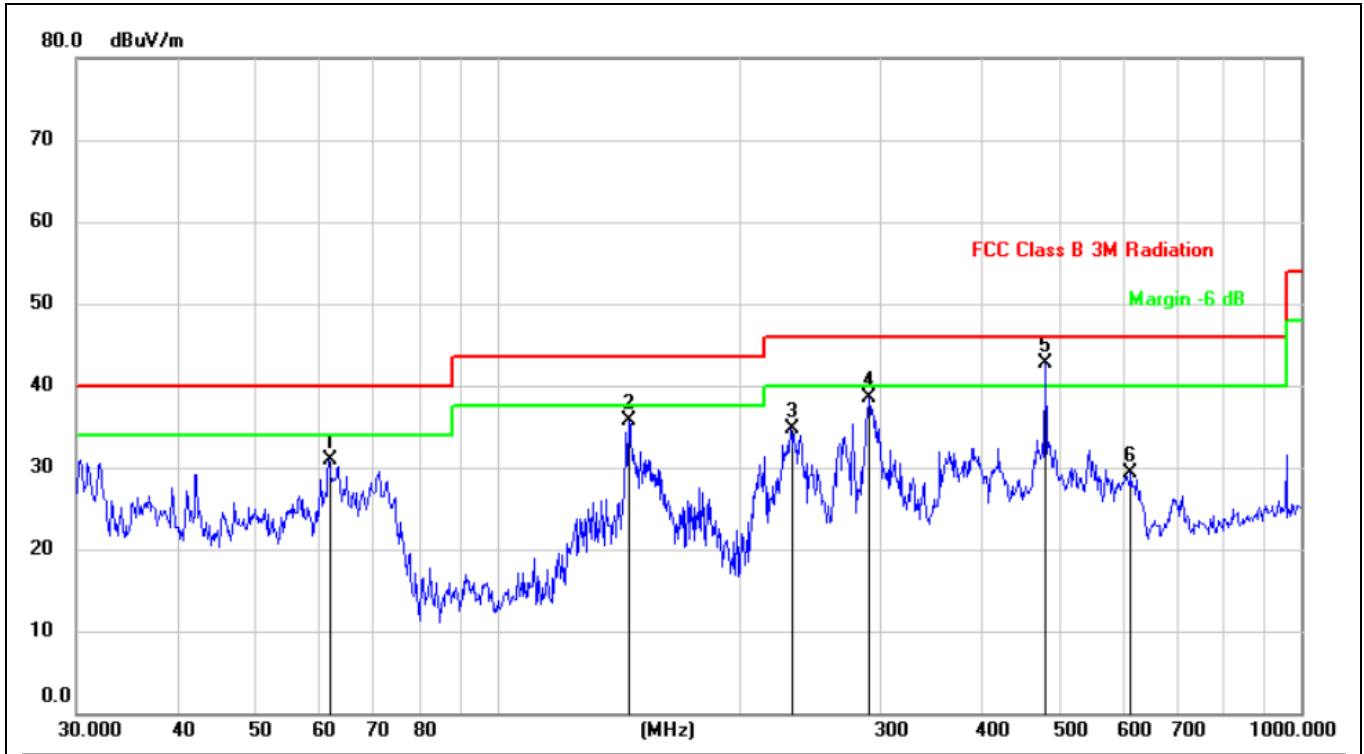

| No. | Mk. | Freq. MHz | Reading Level dBuV | Correct Factor dBuV/m | Measure- ment dBuV/m | Limit dBuV/m | Over dB | Detector |
|-----|-----|--------------|--------------------------|-----------------------------|----------------------------|-----------------|------------|----------|
| 1 | | 61.7781 | 42.48 | -11.62 | 30.86 | 40.00 | -9.14 | QP |
| 2 | | 145.8611 | 49.35 | -13.65 | 35.70 | 43.50 | -7.80 | QP |
| 3 | | 231.7179 | 45.27 | -10.65 | 34.62 | 46.00 | -11.38 | QP |
| 4 | | 290.0172 | 46.47 | -7.90 | 38.57 | 46.00 | -7.43 | QP |
| 5 | * | 480.5276 | 47.97 | -5.36 | 42.61 | 46.00 | -3.39 | QP |
| 6 | | 614.2142 | 34.55 | -5.18 | 29.37 | 46.00 | -16.63 | QP |

1G-25GHz

- Note: (1) All Readings are Peak Value (VBW=3MHz) and AV Value (VBW=10Hz).
 (2) Emission Level= Antenna Factor + Cable Loss + Read Level - Preamp Factor
 (3) All other emissions more than 20dB below the limit.

All the modulation modes have been tested, and the worst result was report as below:

For 802.11b

| Frequency | Read Level | Cable loss | Antenna Factor | Preamp Factor | Emission Level | Limits | Margin | Remark | Comment |
|--|------------|------------|----------------|---------------|----------------|----------|--------|--------|------------|
| (MHz) | (dBμV) | (dB) | dB/m | (dB) | (dBμV/m) | (dBμV/m) | (dB) | | |
| Low Channel (2412 MHz)(802.11b)--Above 1G | | | | | | | | | |
| 4824.161 | 63.29 | 5.21 | 35.59 | 44.30 | 59.79 | 74.00 | -14.21 | Pk | Vertical |
| 4824.161 | 40.72 | 5.21 | 35.59 | 44.30 | 37.22 | 54.00 | -16.78 | AV | Vertical |
| 7236.396 | 59.77 | 6.48 | 36.27 | 44.60 | 57.92 | 74.00 | -16.08 | Pk | Vertical |
| 7236.396 | 43.94 | 6.48 | 36.27 | 44.60 | 42.09 | 54.00 | -11.91 | AV | Vertical |
| 4824.154 | 60.80 | 5.21 | 35.55 | 44.30 | 57.26 | 74.00 | -16.74 | Pk | Horizontal |
| 4824.154 | 42.91 | 5.21 | 35.55 | 44.30 | 39.37 | 54.00 | -14.63 | AV | Horizontal |
| 7236.168 | 62.52 | 6.48 | 36.27 | 44.52 | 60.75 | 74.00 | -13.25 | Pk | Horizontal |
| 7236.168 | 47.26 | 6.48 | 36.27 | 44.52 | 45.49 | 54.00 | -8.51 | AV | Horizontal |
| Middle Channel (2437 MHz)(802.11b)--Above 1G | | | | | | | | | |
| 4874.112 | 63.02 | 5.21 | 35.66 | 44.20 | 59.69 | 74.00 | -14.31 | Pk | Vertical |
| 4874.112 | 42.90 | 5.21 | 35.66 | 44.20 | 39.57 | 54.00 | -14.43 | AV | Vertical |
| 7311.247 | 60.49 | 7.10 | 36.50 | 44.43 | 59.66 | 74.00 | -14.34 | Pk | Vertical |
| 7311.247 | 46.79 | 7.10 | 36.50 | 44.43 | 45.96 | 54.00 | -8.04 | AV | Vertical |
| 4874.132 | 61.12 | 5.21 | 35.66 | 44.20 | 57.79 | 74.00 | -16.21 | Pk | Horizontal |
| 4874.132 | 48.39 | 5.21 | 35.66 | 44.20 | 45.06 | 54.00 | -8.94 | AV | Horizontal |
| 7311.085 | 60.02 | 7.10 | 36.50 | 44.43 | 59.19 | 74.00 | -14.81 | Pk | Horizontal |
| 7311.085 | 41.68 | 7.10 | 36.50 | 44.43 | 40.85 | 54.00 | -13.15 | AV | Horizontal |
| High Channel (2462 MHz)(802.11b)--Above 1G | | | | | | | | | |
| 4924.169 | 65.70 | 5.21 | 35.52 | 44.21 | 62.22 | 74.00 | -11.78 | Pk | Vertical |
| 4924.169 | 42.85 | 5.21 | 35.52 | 44.21 | 39.37 | 54.00 | -14.63 | AV | Vertical |
| 7386.215 | 61.06 | 7.10 | 36.53 | 44.60 | 60.09 | 74.00 | -13.91 | Pk | Vertical |
| 7386.215 | 44.70 | 7.10 | 36.53 | 44.60 | 43.73 | 54.00 | -10.27 | AV | Vertical |
| 4924.045 | 66.59 | 5.21 | 35.52 | 44.21 | 63.11 | 74.00 | -10.89 | Pk | Horizontal |
| 4924.045 | 47.11 | 5.21 | 35.52 | 44.21 | 43.63 | 54.00 | -10.37 | AV | Horizontal |
| 7386.132 | 60.83 | 7.10 | 36.53 | 44.60 | 59.86 | 74.00 | -14.14 | Pk | Horizontal |
| 7386.132 | 45.13 | 7.10 | 36.53 | 44.60 | 44.16 | 54.00 | -9.84 | AV | Horizontal |

5.5.4.2 Band edge - radiated

Note: (1) All Readings are Peak Value (VBW=3MHz) and AV Value (VBW=10Hz).
 (2) Emission Level= Antenna Factor + Cable Loss + Read Level - Preamp Factor
 (3) All other emissions more than 20dB below the limit.

| Frequency | Meter Reading | Cable Loss | Antenna Factor | Preamp Factor | Emission Level | Limits | Margin | Detector | Comment |
|-----------|---------------|------------|----------------|---------------|----------------|----------|--------|----------|------------|
| (MHz) | (dBμV) | (dB) | dB/m | (dB) | (dBμV/m) | (dBμV/m) | (dB) | Type | |
| 802.11b | | | | | | | | | |
| 2310.00 | 56.27 | 2.97 | 27.80 | 43.80 | 43.24 | 74 | -30.76 | Pk | Horizontal |
| 2310.00 | 43.72 | 2.97 | 27.80 | 43.80 | 30.69 | 54 | -23.31 | AV | Horizontal |
| 2310.00 | 58.60 | 2.97 | 27.80 | 43.80 | 45.57 | 74 | -28.43 | Pk | Vertical |
| 2310.00 | 42.42 | 2.97 | 27.80 | 43.80 | 29.39 | 54 | -24.61 | AV | Vertical |
| 2390.00 | 57.47 | 3.14 | 27.21 | 43.80 | 44.02 | 74 | -29.98 | Pk | Vertical |
| 2390.00 | 42.02 | 3.14 | 27.21 | 43.80 | 28.57 | 54 | -25.43 | AV | Vertical |
| 2390.00 | 56.23 | 3.14 | 27.21 | 43.80 | 42.78 | 74 | -31.22 | Pk | Horizontal |
| 2390.00 | 42.08 | 3.14 | 27.21 | 43.80 | 28.63 | 54 | -25.37 | AV | Horizontal |
| 2483.50 | 58.24 | 3.58 | 27.70 | 44.00 | 45.52 | 74 | -28.48 | Pk | Vertical |
| 2483.50 | 43.18 | 3.58 | 27.70 | 44.00 | 30.46 | 54 | -23.54 | AV | Vertical |
| 2483.50 | 59.31 | 3.58 | 27.70 | 44.00 | 46.59 | 74 | -27.41 | Pk | Horizontal |
| 2483.50 | 42.00 | 3.58 | 27.70 | 44.00 | 29.28 | 54 | -24.72 | AV | Horizontal |
| 802.11g | | | | | | | | | |
| 2310.00 | 58.57 | 2.97 | 27.80 | 43.80 | 45.54 | 74 | -28.46 | Pk | Horizontal |
| 2310.00 | 44.15 | 2.97 | 27.80 | 43.80 | 31.12 | 54 | -22.88 | AV | Horizontal |
| 2310.00 | 57.13 | 2.97 | 27.80 | 43.80 | 44.10 | 74 | -29.90 | Pk | Vertical |
| 2310.00 | 42.86 | 2.97 | 27.80 | 43.80 | 29.83 | 54 | -24.17 | AV | Vertical |
| 2390.00 | 57.27 | 3.14 | 27.21 | 43.80 | 43.82 | 74 | -30.18 | Pk | Vertical |
| 2390.00 | 41.85 | 3.14 | 27.21 | 43.80 | 28.40 | 54 | -25.60 | AV | Vertical |
| 2390.00 | 57.68 | 3.14 | 27.21 | 43.80 | 44.23 | 74 | -29.77 | Pk | Horizontal |
| 2390.00 | 43.56 | 3.14 | 27.21 | 43.80 | 30.11 | 54 | -23.89 | AV | Horizontal |
| 2483.50 | 58.72 | 3.58 | 27.70 | 44.00 | 46.00 | 74 | -28.00 | Pk | Vertical |
| 2483.50 | 43.64 | 3.58 | 27.70 | 44.00 | 30.92 | 54 | -23.08 | AV | Vertical |
| 2483.50 | 58.46 | 3.58 | 27.70 | 44.00 | 45.74 | 74 | -28.26 | Pk | Horizontal |
| 2483.50 | 41.68 | 3.58 | 27.70 | 44.00 | 28.96 | 54 | -25.04 | AV | Horizontal |

| 802.11n20 | | | | | | | | | |
|-----------|-------|------|-------|-------|-------|----|--------|----|------------|
| 2310.00 | 58.39 | 2.97 | 27.80 | 43.80 | 45.36 | 74 | -28.64 | Pk | Horizontal |
| 2310.00 | 43.45 | 2.97 | 27.80 | 43.80 | 30.42 | 54 | -23.58 | AV | Horizontal |
| 2310.00 | 58.54 | 2.97 | 27.80 | 43.80 | 45.51 | 74 | -28.49 | Pk | Vertical |
| 2310.00 | 42.67 | 2.97 | 27.80 | 43.80 | 29.64 | 54 | -24.36 | AV | Vertical |
| 2390.00 | 57.39 | 3.14 | 27.21 | 43.80 | 43.94 | 74 | -30.06 | Pk | Vertical |
| 2390.00 | 41.81 | 3.14 | 27.21 | 43.80 | 28.36 | 54 | -25.64 | AV | Vertical |
| 2390.00 | 56.97 | 3.14 | 27.21 | 43.80 | 43.52 | 74 | -30.48 | Pk | Horizontal |
| 2390.00 | 42.72 | 3.14 | 27.21 | 43.80 | 29.27 | 54 | -24.73 | AV | Horizontal |
| 2483.50 | 57.97 | 3.58 | 27.70 | 44.00 | 45.25 | 74 | -28.75 | Pk | Vertical |
| 2483.50 | 42.41 | 3.58 | 27.70 | 44.00 | 29.69 | 54 | -24.31 | AV | Vertical |
| 2483.50 | 58.53 | 3.58 | 27.70 | 44.00 | 45.81 | 74 | -28.19 | Pk | Horizontal |
| 2483.50 | 42.54 | 3.58 | 27.70 | 44.00 | 29.82 | 54 | -24.18 | AV | Horizontal |
| 802.11n40 | | | | | | | | | |
| 2310.00 | 57.83 | 2.97 | 27.80 | 43.80 | 44.80 | 74 | -29.20 | Pk | Horizontal |
| 2310.00 | 43.38 | 2.97 | 27.80 | 43.80 | 30.35 | 54 | -23.65 | AV | Horizontal |
| 2310.00 | 58.64 | 2.97 | 27.80 | 43.80 | 45.61 | 74 | -28.39 | Pk | Vertical |
| 2310.00 | 41.93 | 2.97 | 27.80 | 43.80 | 28.90 | 54 | -25.10 | AV | Vertical |
| 2390.00 | 57.42 | 3.14 | 27.21 | 43.80 | 43.97 | 74 | -30.03 | Pk | Vertical |
| 2390.00 | 42.31 | 3.14 | 27.21 | 43.80 | 28.86 | 54 | -25.14 | AV | Vertical |
| 2390.00 | 56.49 | 3.14 | 27.21 | 43.80 | 43.04 | 74 | -30.96 | Pk | Horizontal |
| 2390.00 | 41.84 | 3.14 | 27.21 | 43.80 | 28.39 | 54 | -25.61 | AV | Horizontal |
| 2483.50 | 58.19 | 3.58 | 27.70 | 44.00 | 45.47 | 74 | -28.53 | Pk | Vertical |
| 2483.50 | 43.05 | 3.58 | 27.70 | 44.00 | 30.33 | 54 | -23.67 | AV | Vertical |
| 2483.50 | 59.05 | 3.58 | 27.70 | 44.00 | 46.33 | 74 | -27.67 | Pk | Horizontal |
| 2483.50 | 41.85 | 3.58 | 27.70 | 44.00 | 29.13 | 54 | -24.87 | AV | Horizontal |

5.5.4.3 Spurious Emission in Restricted Band 3260MMHz-18000MHZ

All the modulation modes have been tested, and the worst result was report as below:

| Frequency | Reading | Cable | Antenna | Preamp | Emission | Limits | Margin | Detector | Comment |
|-----------|--------------|-------|---------|--------|----------------|----------------|--------|----------|------------|
| (MHz) | (dB μ V) | (dB) | dB/m | (dB) | (dB μ V/m) | (dB μ V/m) | (dB) | Type | |
| 3260 | 60.45 | 4.04 | 29.57 | 44.70 | 49.36 | 74 | -24.64 | Pk | Vertical |
| 3260 | 55.77 | 4.04 | 29.57 | 44.70 | 44.68 | 54 | -9.32 | AV | Vertical |
| 3260 | 62.00 | 4.04 | 29.57 | 44.70 | 50.91 | 74 | -23.09 | Pk | Horizontal |
| 3260 | 56.43 | 4.04 | 29.57 | 44.70 | 45.34 | 54 | -8.66 | AV | Horizontal |
| 3332 | 64.58 | 4.26 | 29.87 | 44.40 | 54.31 | 74 | -19.69 | Pk | Vertical |
| 3332 | 53.81 | 4.26 | 29.87 | 44.40 | 43.54 | 54 | -10.46 | AV | Vertical |
| 3332 | 63.20 | 4.26 | 29.87 | 44.40 | 52.93 | 74 | -21.07 | Pk | Horizontal |
| 3332 | 52.58 | 4.26 | 29.87 | 44.40 | 42.31 | 54 | -11.69 | AV | Horizontal |
| 17797 | 42.96 | 10.99 | 43.95 | 43.50 | 54.40 | 74 | -19.60 | Pk | Vertical |
| 17797 | 32.39 | 10.99 | 43.95 | 43.50 | 43.83 | 54 | -10.17 | AV | Vertical |
| 17788 | 44.20 | 11.81 | 43.69 | 44.60 | 55.10 | 74 | -18.90 | Pk | Horizontal |
| 17788 | 32.11 | 11.81 | 43.69 | 44.60 | 43.01 | 54 | -10.99 | AV | Horizontal |

5.6 Conduction spurious emission

5.6.1 Limits

In any 100 kHz bandwidth outside the frequency band in which the spread spectrum or digitally modulated intentional radiator is operating, the radio frequency power that is produced by the intentional radiator shall be at least 20 dB below that in the 100 kHz bandwidth within the band that contains the highest level of the desired power, based on either an RF conducted or a radiated measurement, provided the transmitter demonstrates compliance with the peak conducted power limits. If the transmitter complies with the conducted power limits based on the use of RMS averaging over a time interval, as permitted under paragraph (b)(3) of this section, the attenuation required under this paragraph shall be 30 dB instead of 20 dB. Attenuation below the general limits specified in §15.209(a) is not required. In addition, radiated emissions which fall in the restricted bands, as defined in §15.205(a), must also comply with the radiated emission limits specified in §15.209(a) (see §15.205(c)).

5.6.2 Test setup



5.6.3 Test procedure

- a) Check the calibration of the measuring instrument using either an internal calibrator or a known signal from an external generator.
- b) Position the EUT without connection to measurement instrument. Turn on the EUT and connect its antenna terminal to measurement instrument via a low loss cable. Then set it to any one measured frequency within its operating range, and make sure the instrument is operated in its linear range.
- c) Set RBW to 100 kHz and VBW of spectrum analyzer to 300 kHz with a convenient frequency span including 100 kHz bandwidth from band edge.
- d) Measure the highest amplitude appearing on spectral display and set it as a reference level. Plot the graph with marking the highest point and edge frequency.
- e) Repeat above procedures until all measured frequencies were complete.

EUT OPERATION CONDITIONS

The EUT tested system was configured as the statements of 2.4 unless otherwise a special operating condition is specified in the follows during the testing.

5.6.4 Test results

Test plots:

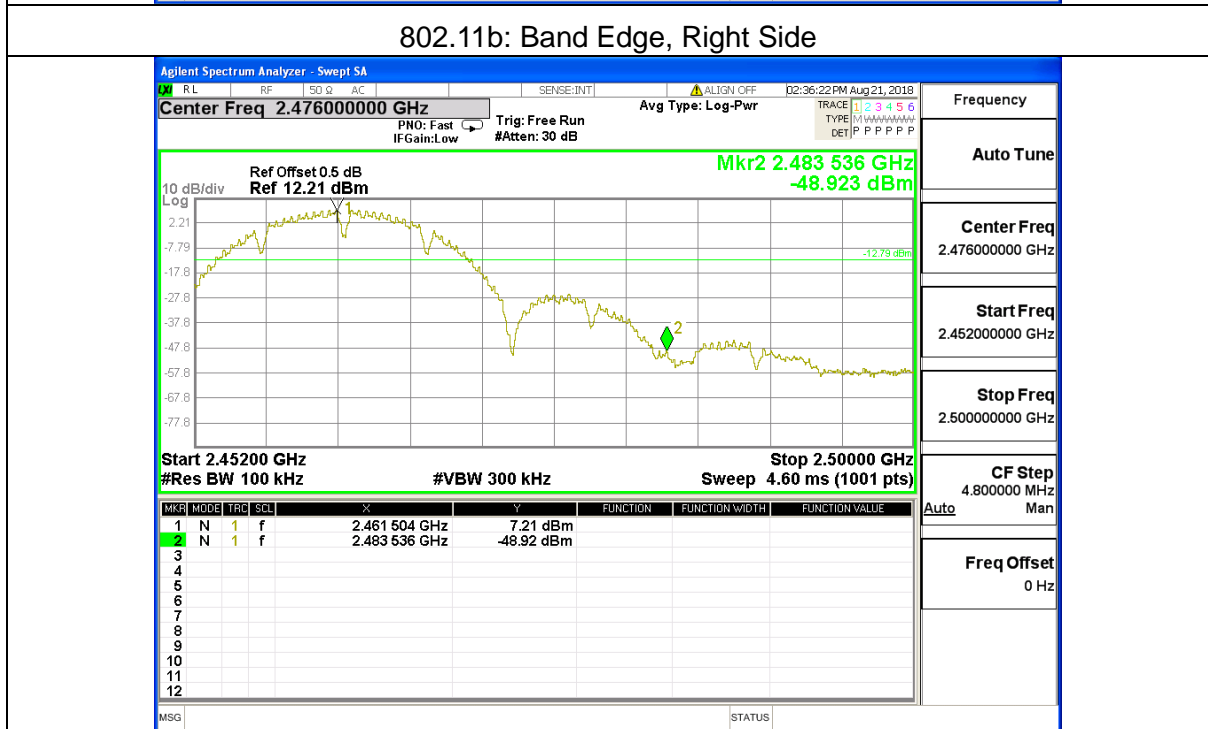
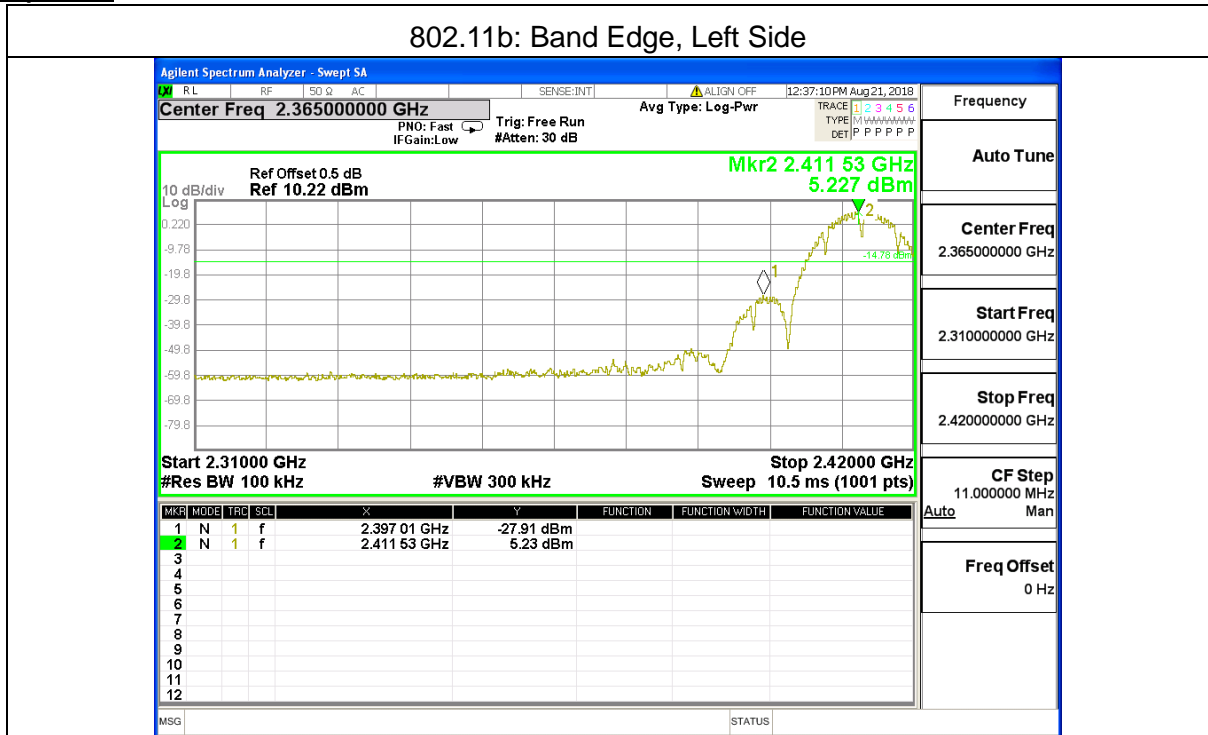

802.11g: Band Edge, Left Side

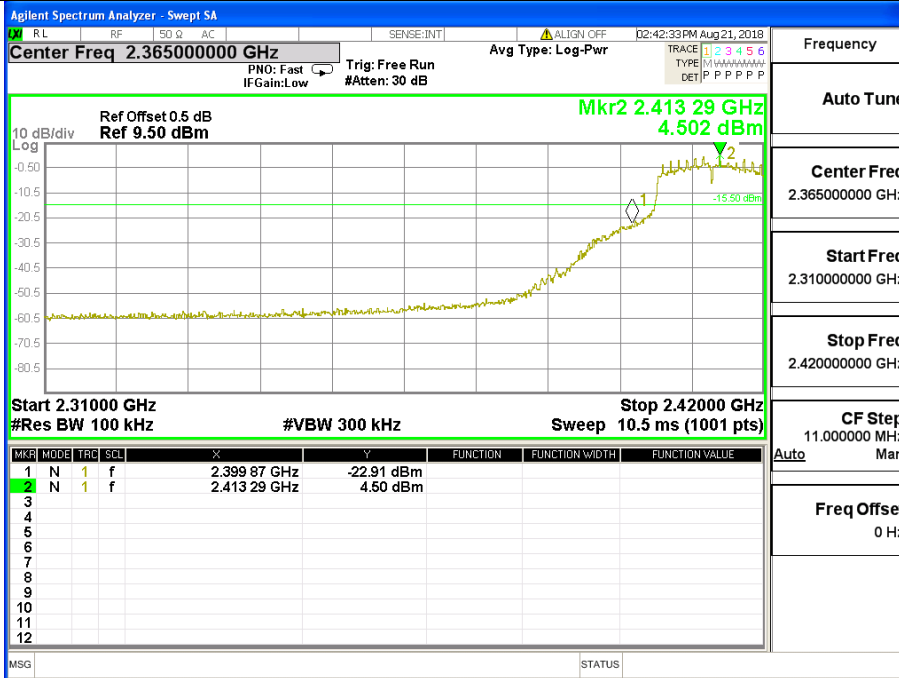

802.11g: Band Edge, Right Side

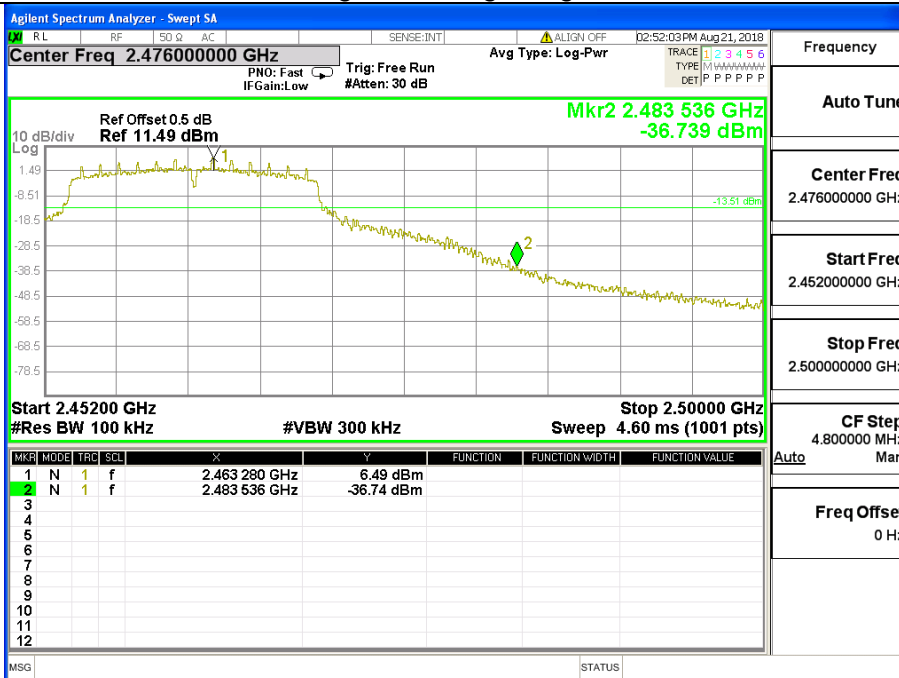

802.11n20: Band Edge, Left Side

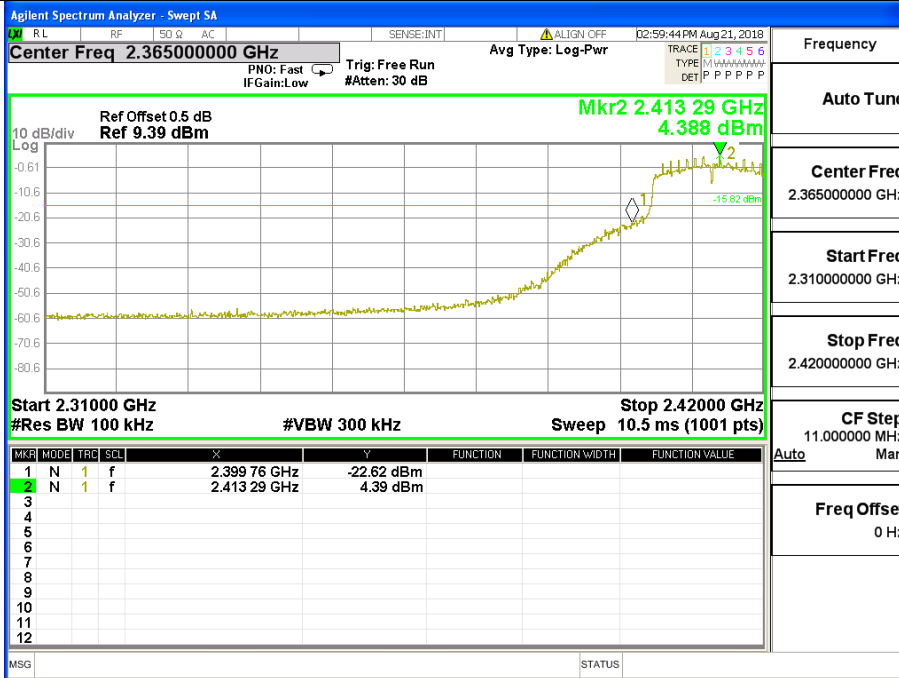

802.11n20: Band Edge, Right Side

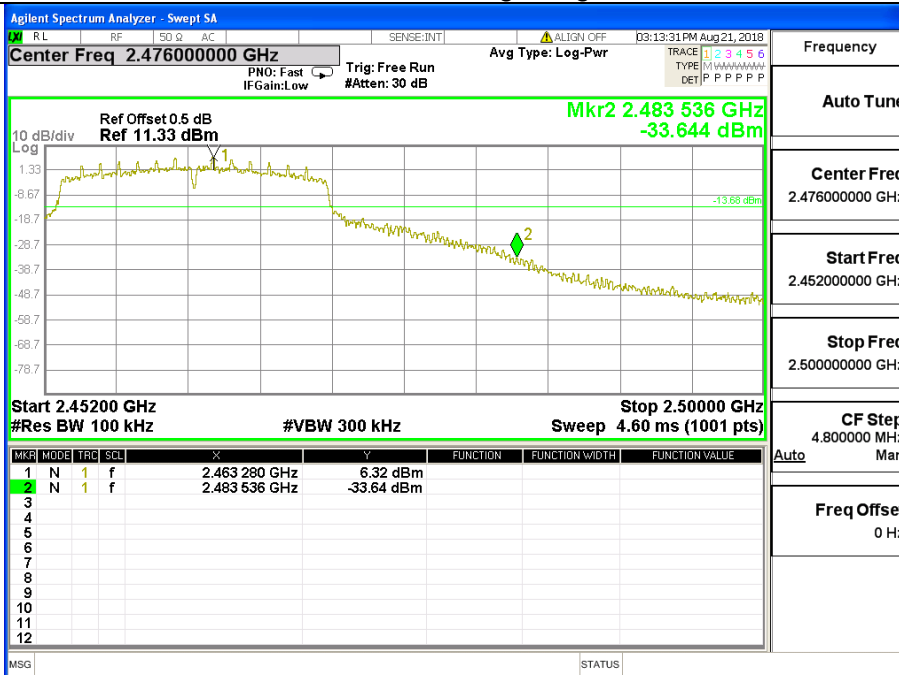

802.11n40: Band Edge, Left Side

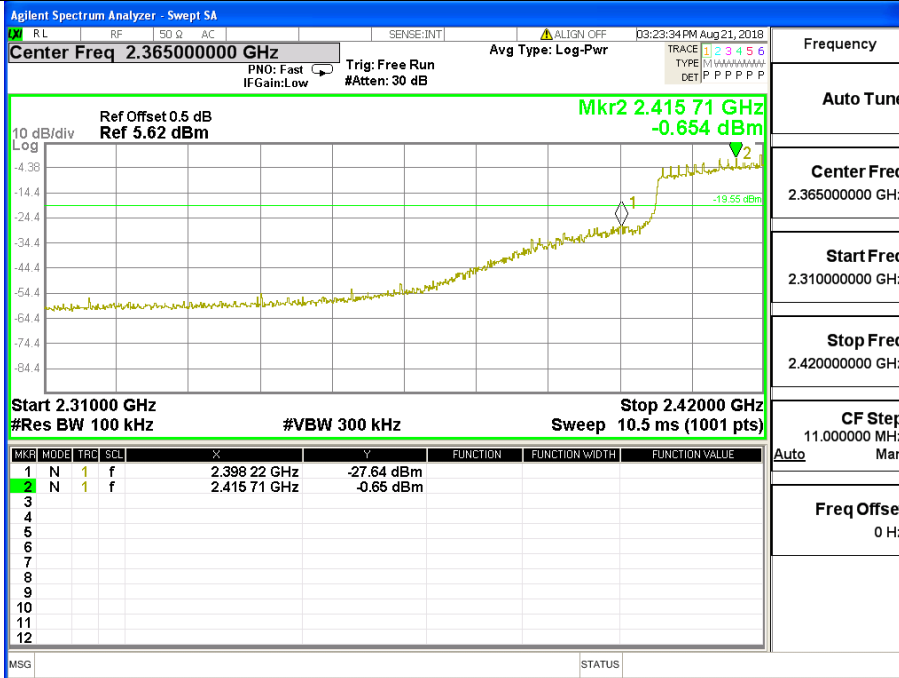

802.11n40: Band Edge, Right Side

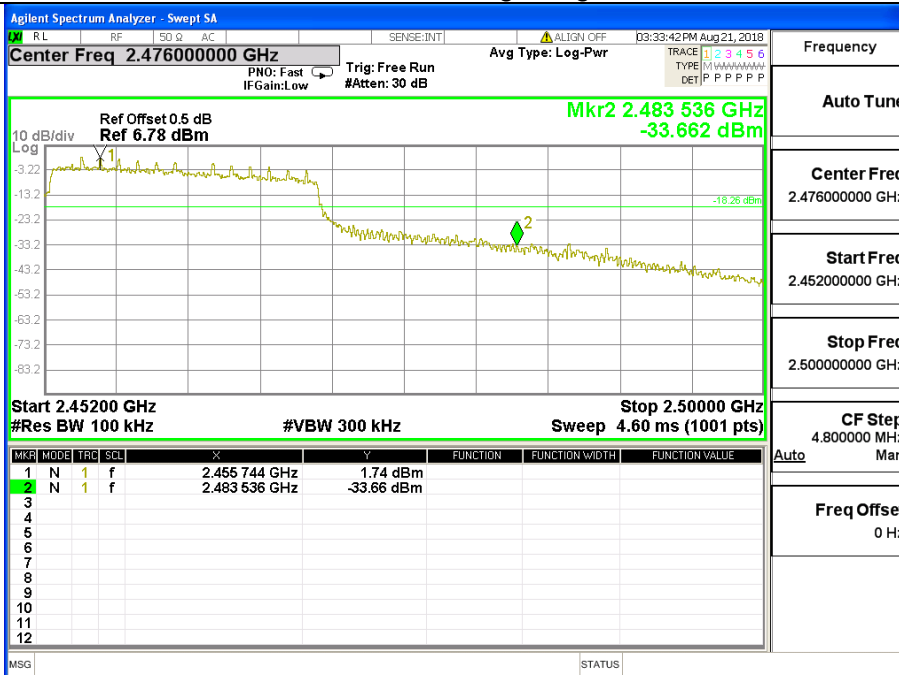

5.7 6dB bandwidth

5.7.1 Limit

| FCC Part15 Subpart C | | | | |
|----------------------|-----------|---|-----------------------|--------|
| Section | Test Item | Limit | Frequency Range (MHz) | Result |
| 15.247(a)(2) | Bandwidth | $\geq 500\text{KHz}$ (6dB bandwidth) | 2400-2483.5 | Pass |

5.7.2 Test setup



5.7.3 Test procedure

- a. Set RBW= 100 kHz.
- b. Set the video bandwidth (VBW) $\geq 3 \times$ RBW.
- c. Detector = Peak.
- d. Trace mode = max hold.
- e. Sweep = auto couple.
- f. Allow the trace to stabilize.
- g. Measure the maximum width of the emission that is constrained by the frequencies associated with the two outermost amplitude points (upper and lower) that are attenuated by 6 dB relative to the maximum level measured in the fundamental emission.

EUT Operation Conditions

The EUT tested system was configured as the statements of 2.4 unless otherwise a special operating condition is specified in the follows during the testing.

5.7.4 Test results

| | | | |
|---------------|-----------------------------|---------------------|------------------------------------|
| EUT : | Base Station | Model Name : | 850G |
| Temperature : | 25 °C | Relative Humidity : | 60% |
| Pressure : | 1012 hPa | Test Voltage : | DC 5V from AC Adapter 120V/60Hz |
| Test Mode : | TX b Mode /CH01, CH06, CH11 | | |

| Channel | Frequency (MHz) | 6dB bandwidth (MHz) | Limit (kHz) | Result |
|---------|-----------------|---------------------|-------------|--------|
| Low | 2412 | 8.573 | 500 | Pass |
| Middle | 2437 | 9.063 | 500 | Pass |
| High | 2462 | 10.05 | 500 | Pass |

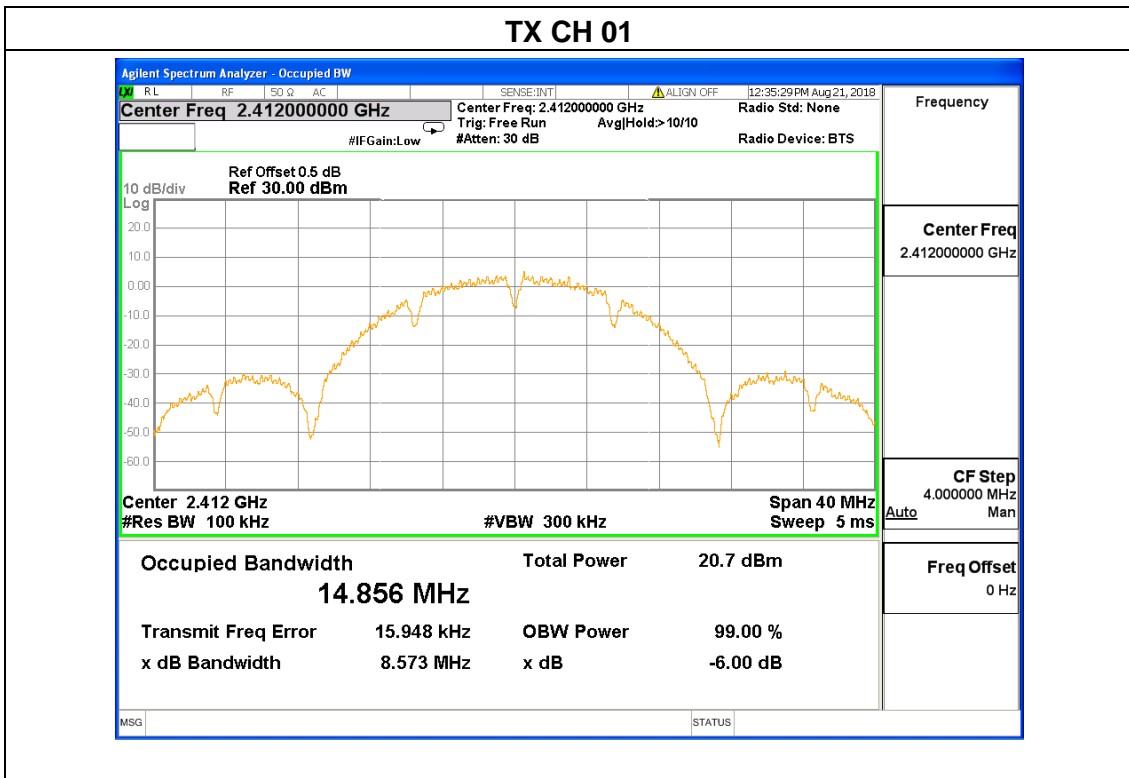

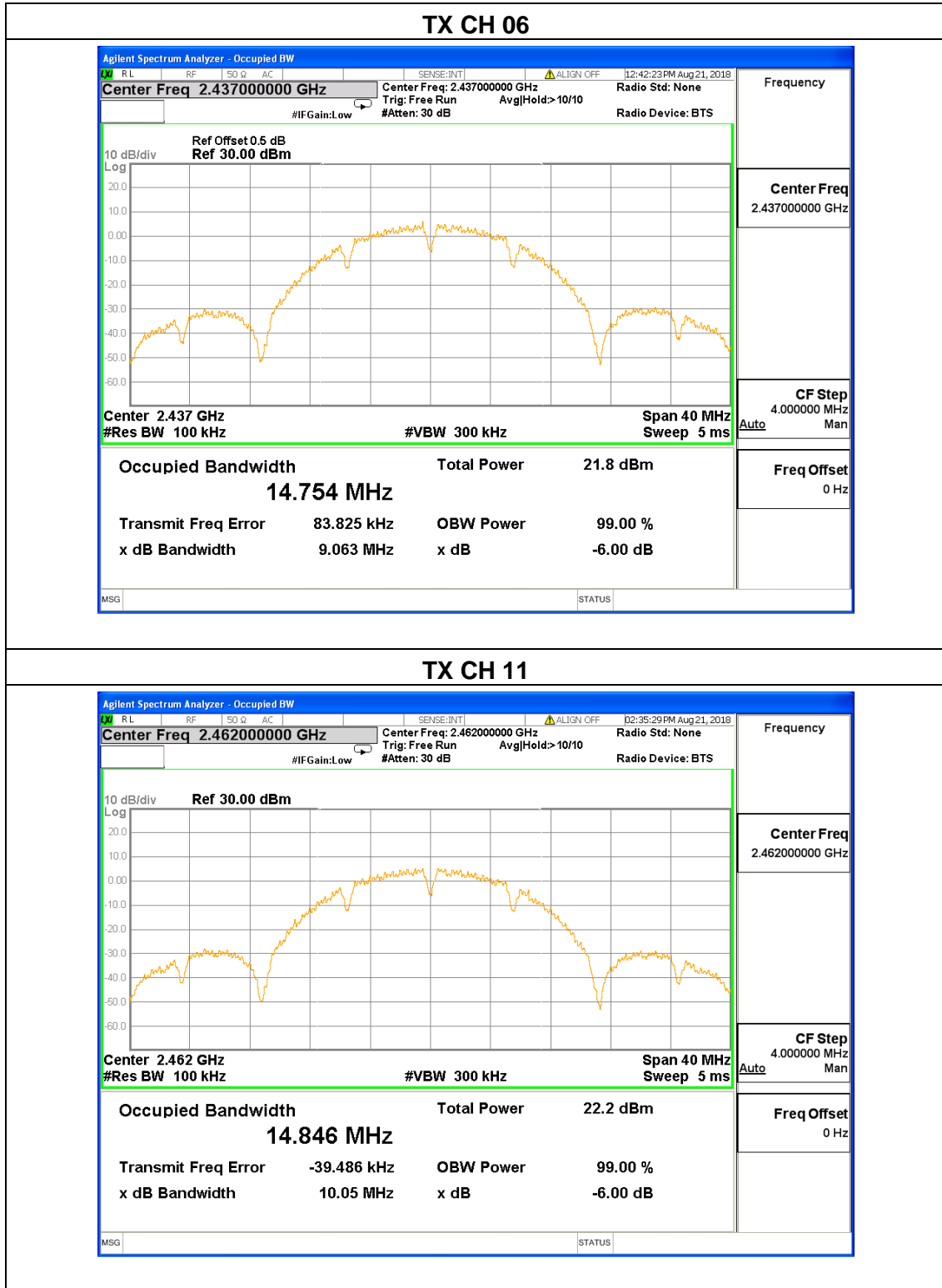

| | | | |
|---------------|-----------------------------|---------------------|------------------------------------|
| EUT : | Base Station | Model Name : | 850G |
| Temperature : | 25 °C | Relative Humidity : | 60% |
| Pressure : | 1012 hPa | Test Voltage : | DC 5V from AC Adapter 120V/60Hz |
| Test Mode : | TX g Mode /CH01, CH06, CH11 | | |

| Channel | Frequency (MHz) | 6dB bandwidth (MHz) | Limit (kHz) | Result |
|---------|-----------------|---------------------|-------------|--------|
| Low | 2412 | 15.11 | 500 | Pass |
| Middle | 2437 | 15.10 | 500 | Pass |
| High | 2462 | 15.11 | 500 | Pass |

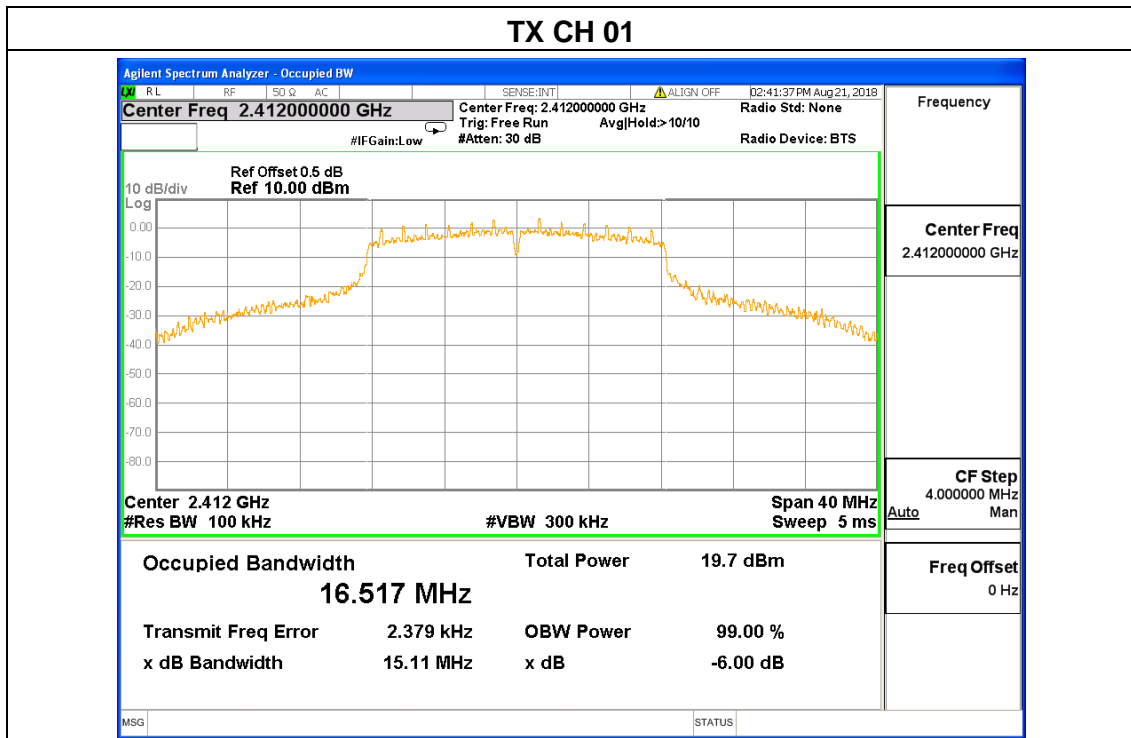

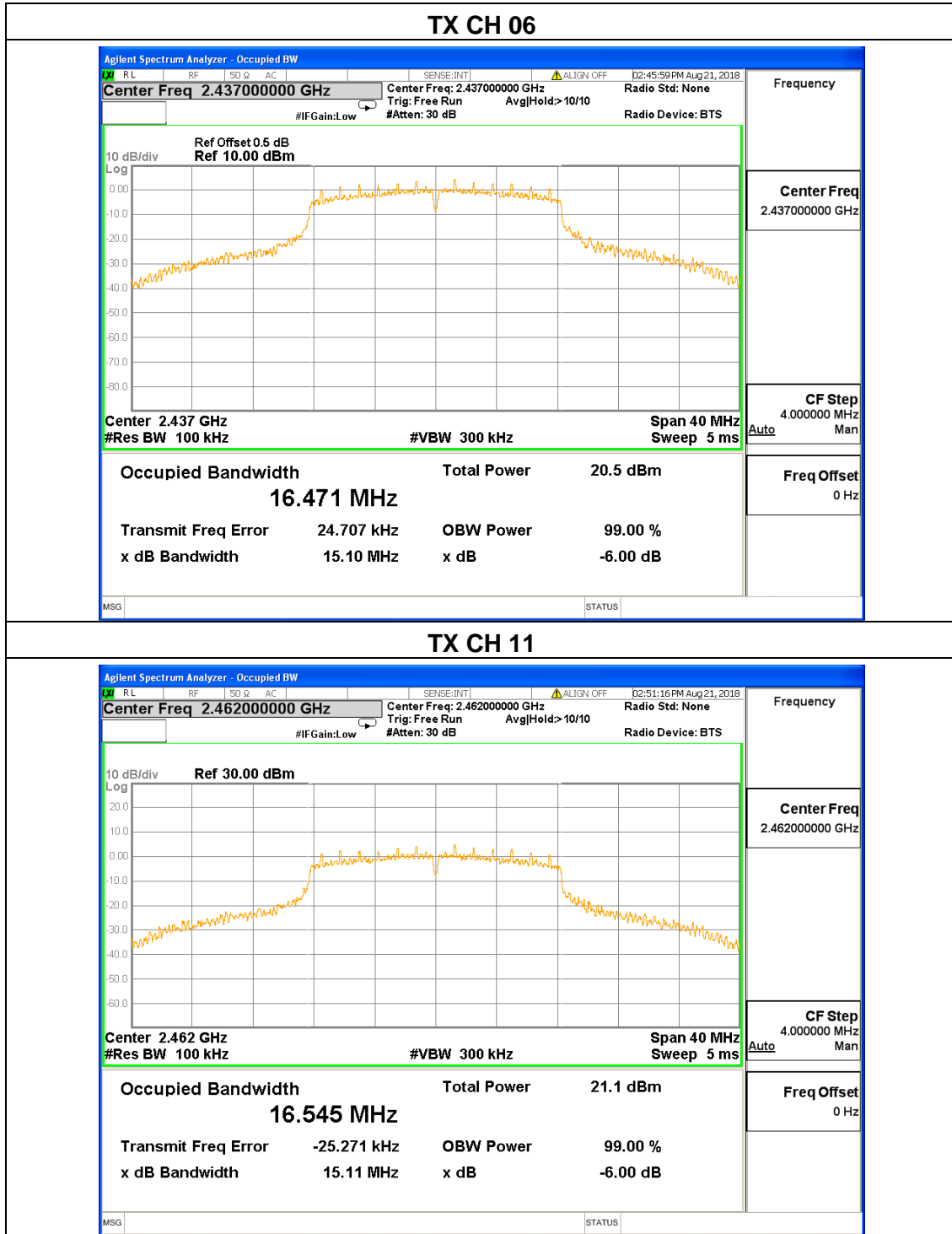

| | | | |
|---------------|-------------------------------|---------------------|------------------------------------|
| EUT : | Base Station | Model Name : | 850G |
| Temperature : | 25 °C | Relative Humidity : | 60% |
| Pressure : | 1012 hPa | Test Voltage : | DC 5V from AC Adapter 120V/60Hz |
| Test Mode : | TX n20 Mode /CH01, CH06, CH11 | | |

| Channel | Frequency (MHz) | 6dB bandwidth (MHz) | Limit (kHz) | Result |
|---------|-----------------|---------------------|-------------|--------|
| Low | 2412 | 15.11 | 500 | Pass |
| Middle | 2437 | 15.11 | 500 | Pass |
| High | 2462 | 15.10 | 500 | Pass |

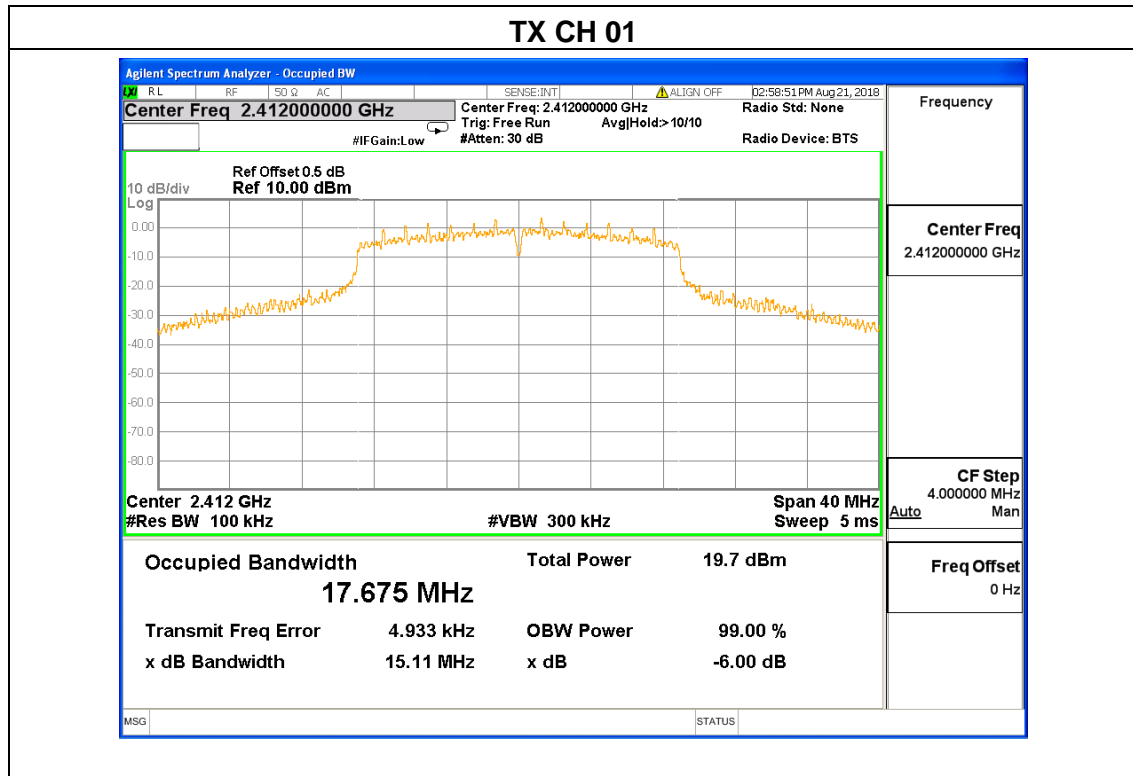

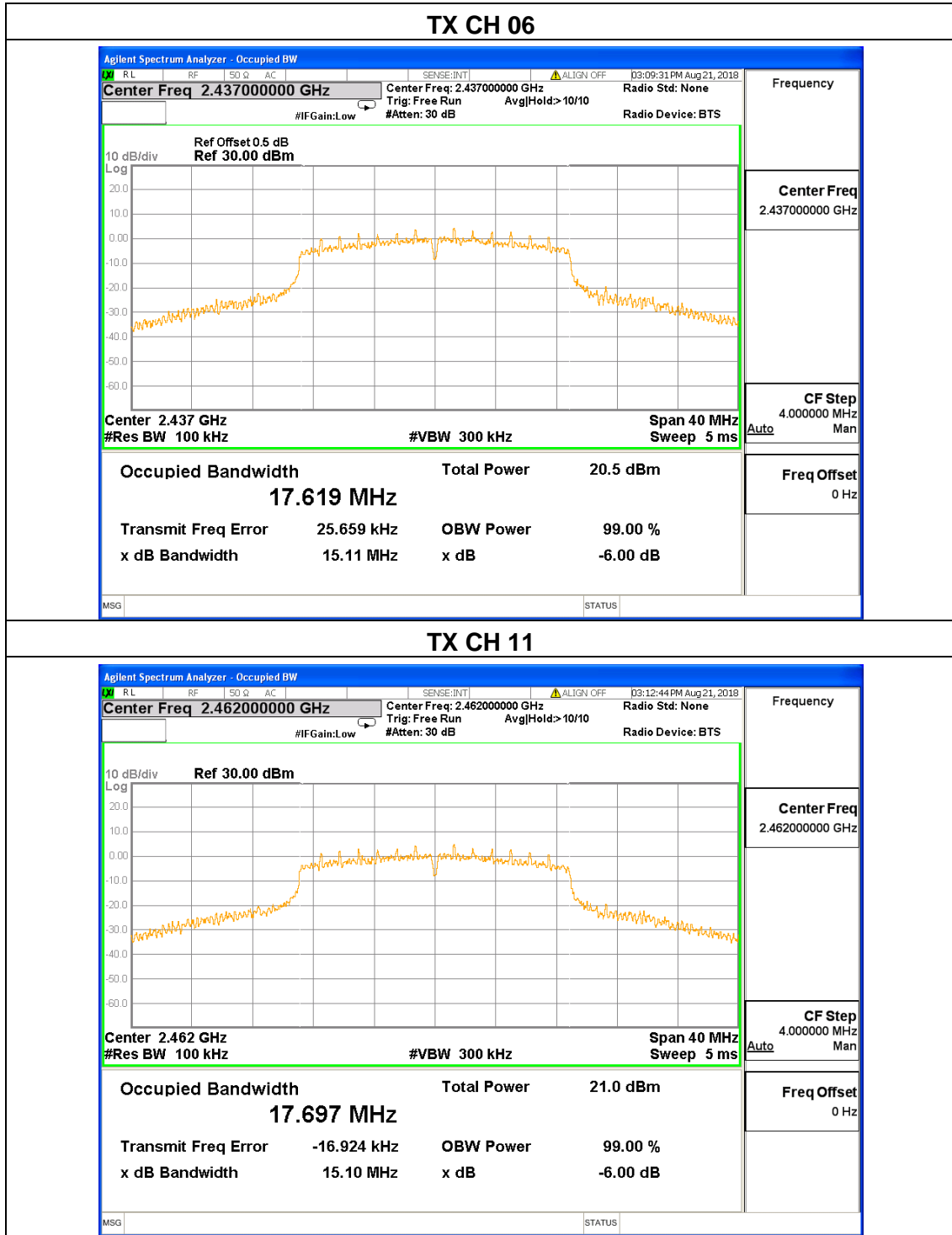

| | | | |
|---------------|-------------------------------|---------------------|------------------------------------|
| EUT : | Base Station | Model Name : | 850G |
| Temperature : | 25 °C | Relative Humidity : | 60% |
| Pressure : | 1012 hPa | Test Voltage : | DC 5V from AC Adapter 120V/60Hz |
| Test Mode : | TX n40 Mode /CH03, CH06, CH09 | | |

| Channel | Frequency (MHz) | 6dB bandwidth (MHz) | Limit (kHz) | Result |
|---------|-----------------|---------------------|-------------|--------|
| Low | 2422 | 35.07 | 500 | Pass |
| Middle | 2437 | 33.83 | 500 | Pass |
| High | 2452 | 35.05 | 500 | Pass |

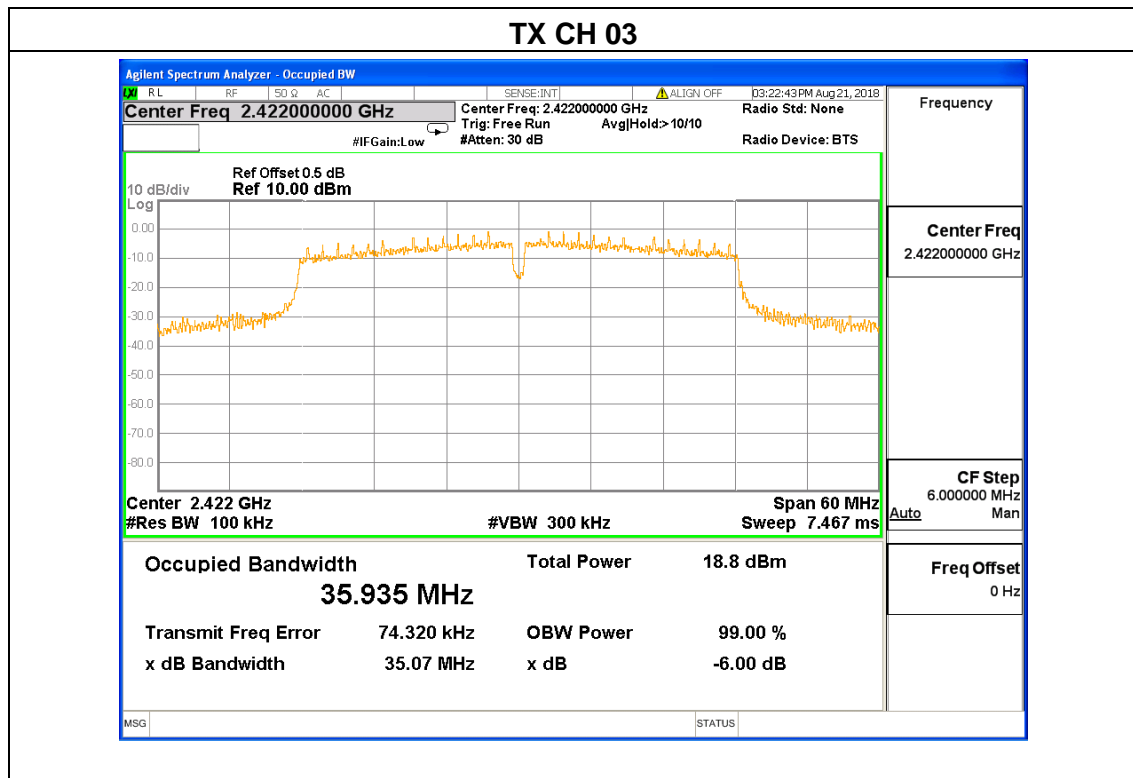

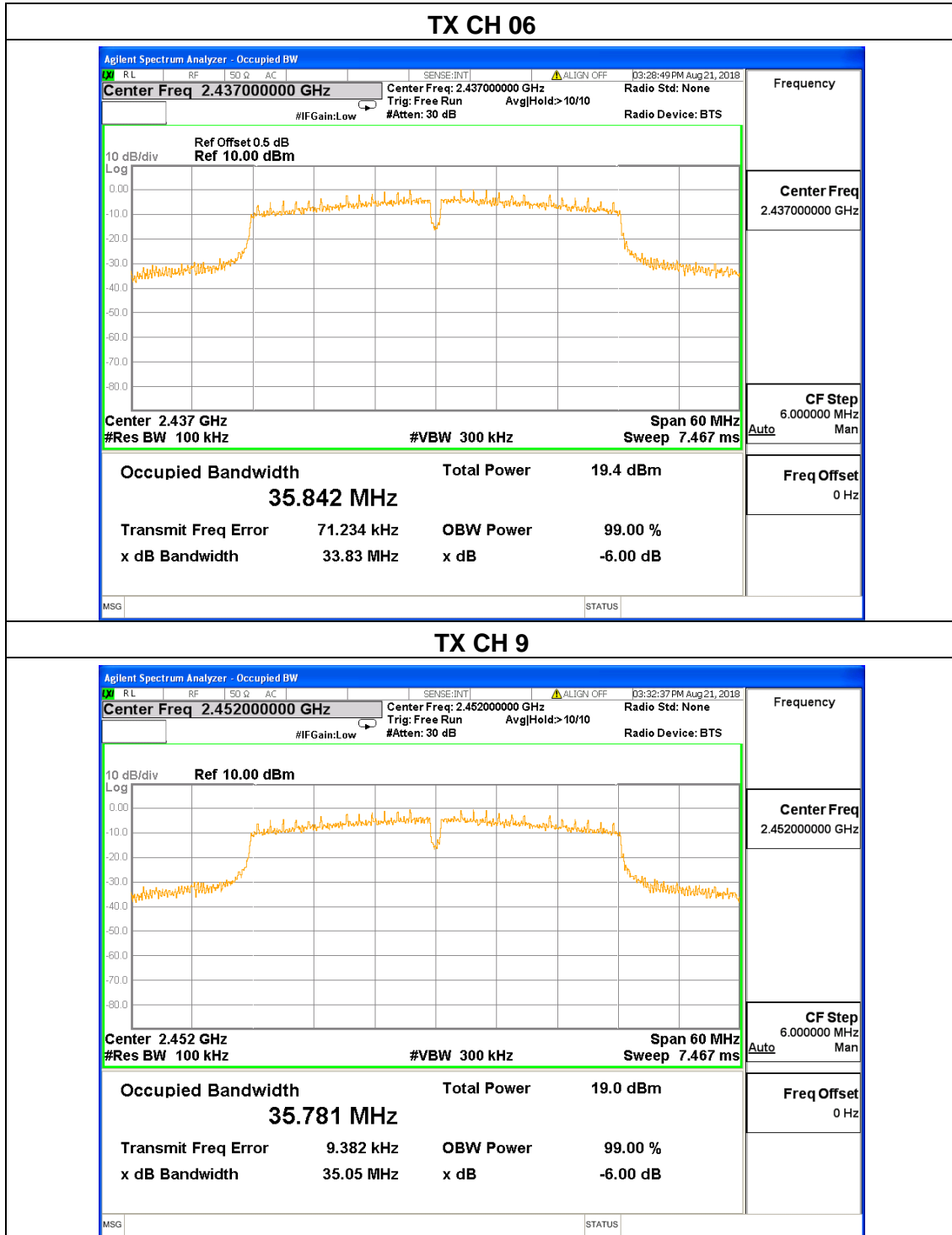

Photographs of the Test Setup

Radiated emission

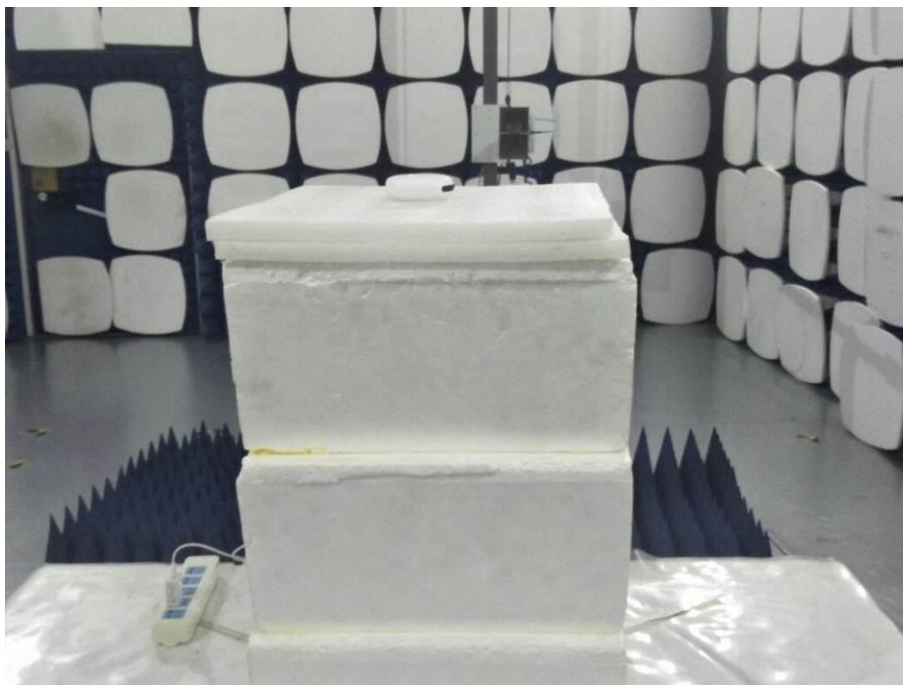
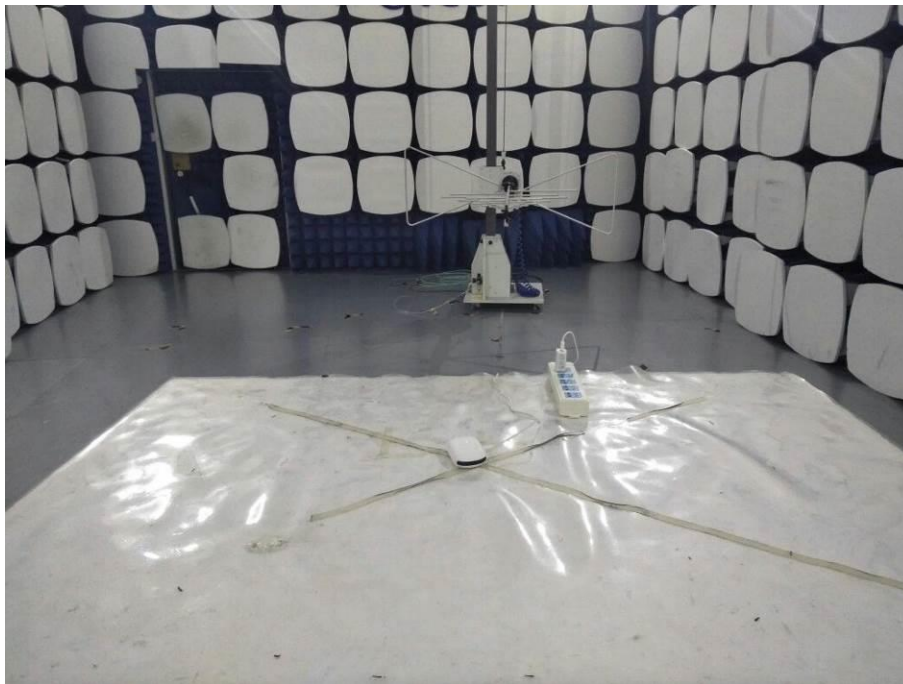

Conducted emission



Photographs of the EUT

See the APPENDIX 1: EUT PHOTO in the report No.: MTi180903E006-1.

----END OF REPORT----