

Test Report

FCC ID: ZCB-704RA

Date of issue: May 14, 2018

Report Number:	MTi180511E040
Sample Description:	IP Camera
Model(s):	704RA, 632RA, 633RA, 634RA, 635RA, 705RA, 750RA, 754RA, 756RA, 756GBU
Applicant:	Shenzhen Smart-eye Digital Electronics Co.,Ltd
Address:	#6 Northern Zone, Shangxue S&T City, Bantian, Longgang District, Shenzhen, China
Date of Test:	May 3, 2018 to May 14, 2018

Shenzhen Microtest Co., Ltd.
<http://www.mtitest.com>

Table of Contents

1	GENERAL INFORMATION	5
1.1	DESCRIPTION OF EUT	5
1.2	OPERATION CHANNEL LIST	6
1.3	TEST CHANNEL LIST	6
1.4	ANCILLARY EQUIPMENT LIST	6
1.5	DESCRIPTION OF SUPPORT UNITS	6
2	SUMMARY OF TEST RESULTS.....	8
3	TEST FACILITIES AND ACCREDITATIONS.....	9
3.1	TEST LABORATORY	9
3.2	ENVIRONMENTAL CONDITIONS	9
3.3	MEASUREMENT UNCERTAINTY	9
3.4	TEST SOFTWARE	9
4	EQUIPMENT LIST	10
5	TEST RESULT	11
5.1	ANTENNA REQUIREMENT	11
5.1.1	<i>Standard requirement.....</i>	<i>11</i>
5.1.2	<i>EUT Antenna</i>	<i>11</i>
5.2	PEAK OUTPUT POWER	12
5.2.1	<i>Limit</i>	<i>12</i>
5.2.2	<i>Test setup</i>	<i>12</i>
5.2.3	<i>Test procedure.....</i>	<i>12</i>
5.2.4	<i>Test results</i>	<i>13</i>
5.3	POWER SPECTRAL DENSITY	14
5.3.1	<i>Limit</i>	<i>14</i>
5.3.2	<i>Test Setup.....</i>	<i>14</i>
5.3.3	<i>Test Procedure.....</i>	<i>14</i>
5.3.4	<i>Test Results.....</i>	<i>15</i>
5.4	CONDUCTED EMISSION	19
5.4.1	<i>Limits.....</i>	<i>19</i>
5.4.2	<i>Test setup</i>	<i>19</i>
5.4.3	<i>Test procedure.....</i>	<i>20</i>
5.4.4	<i>Test results</i>	<i>21</i>
5.4.5	23
5.5	RADIATED SPURIOUS	25
5.5.1	<i>Limits.....</i>	<i>25</i>
5.5.2	<i>Test setup</i>	<i>26</i>
5.5.3	<i>Test procedure.....</i>	<i>27</i>
5.5.4	<i>Test results</i>	<i>28</i>
5.5.4.1	<i>Radiation emission</i>	<i>28</i>
5.5.4.2	<i>Band edge - radiated</i>	<i>32</i>
5.5.4.3	<i>Spurious Emission in Restricted Band 3260MMHz-18000MHz.....</i>	<i>34</i>
5.6	CONDUCTION SPURIOUS EMISSION.....	35
5.6.1	<i>Limits.....</i>	<i>35</i>
5.6.2	<i>Test setup</i>	<i>35</i>
5.6.3	<i>Test procedure.....</i>	<i>35</i>
5.6.4	<i>Test results</i>	<i>36</i>
5.7	6DB BANDWIDTH	40
5.7.1	<i>Limit</i>	<i>40</i>
5.7.2	<i>Test setup</i>	<i>40</i>
5.7.3	<i>Test procedure.....</i>	<i>40</i>
5.7.4	<i>Test results</i>	<i>41</i>

This test report is valid for the tested samples only. It cannot be reproduced except in full without prior written consent of Shenzhen Microtest Co., Ltd.

This test report is valid for the tested samples only. It cannot be reproduced except in full without prior written consent of Shenzhen Microtest Co., Ltd.

Tel:(86-755)88850135

Fax: (86-755) 88850136

Web: <http://www.mtitest.com>

E-mail: mti@51mti.com

Address: No.102A & 302A, East Block, Hengfang Industrial Park, Xingye Road, Xixiang, Bao'an District, Shenzhen, Guangdong, China

Test Result Certification

Applicant's name: Shenzhen Smart-eye Digital Electronics Co.,Ltd
Address: #6 Northern Zone, Shangxue S&T City, Bantian, Longgang District, Shenzhen, China

Manufacture's Name: Shenzhen Smart-eye Digital Electronics Co.,Ltd
Address: #6 Northern Zone, Shangxue S&T City, Bantian, Longgang District, Shenzhen, China

Product name: IP Camera

Trademark: N/A

Model name: 704RA

Serial Model: 632RA, 633RA, 634RA, 635RA, 705RA, 750RA, 754RA, 756RA, 756GBU

Standards: FCC Part 15.247
ANSI C63.10-2013

Test Procedure: KDB 558074 v01r04
KDB 174176 D01 Line Conducted FAQ v01r01

This device described above has been tested by Shenzhen Microtest Co., Ltd. and the test results show that the equipment under test (EUT) compliance with the FCC requirements. And it is applicable only to the tested sample identified in the report.

Tested by: Leo Su

Leo Su May 14, 2018

Reviewed by: Blue Zheng

Blue Zheng May 14, 2018

Approved by: Smith Chen

Smith Chen May 14, 2018

This test report is valid for the tested samples only. It cannot be reproduced except in full without prior written consent of Shenzhen Microtest Co., Ltd.

1 General information

1.1 Description of EUT

Product name	IP Camera
Model name	704RA
Serial Model	632RA, 633RA, 634RA, 635RA, 705RA, 750RA, 754RA, 756RA, 756GBU
Model difference:	All the model are the same circuit and RF module, Except the appearance, color and model No..
Operation Frequency	802.11b/g/n20:2412~2462 MHz 802.11n40:2422~2452 MHz
Modulation Type:	IEEE 802.11b : DSSS (DBPSK, DQPSK, CCK) IEEE 802.11g/n (HT20/HT40) : OFDM (64QAM, 16QAM, QPSK, BPSK)
Bit Rate of Transmitter	802.11b:11/5.5/2/1 Mbps 802.11g:54/48/36/24/18/12/9/6Mbps 802.11n(20MHz) use 800 ns GI: 65.0/58.5/52.0/39.0/26.0/19.5/13.0/6.5 Mbps (MCS0~MCS7) 802.11n(40MHz) use 800 ns GI: 13.5/27/40.5/54/81/108/121.5/135Mbps
Antenna Type	PCB Mounted Embedded Antenna
Antenna Gain (dBi)	3.3dBi
Max. Output Power:	12.87dBm
Power Supply:	AC 120V/60Hz from adapter
Battery:	N/A
Adapter information:	Model: SW-050100 Input:100-240V~ 50/60Hz 0.3A MAX Output:5V 1A
Hardware Version:	25-00704RA101
Software Version:	V1.0

This test report is valid for the tested samples only. It cannot be reproduced except in full without prior written consent of Shenzhen Microtest Co., Ltd.

1.2 Operation channel list

Channel List for 802.11b/g/n(20)

Channel	Frequency (MHz)	Channel	Frequency (MHz)
01	2412	07	2442
02	2417	08	2447
03	2422	09	2452
04	2427	10	2457
05	2432	11	2462
06	2437	\	\

Channel List for 802.11n(40)

Channel	Frequency (MHz)	Channel	Frequency (MHz)
03	2422	07	2442
04	2427	08	2447
05	2432	09	2452
06	2437	\	\

1.3 Test channel list

Channel List for 802.11b/g/n(20)

Channel	Channel	Frequency (MHz)
Low	01	2412
Middle	06	2437
High	11	2462

Note: DutyCycle>98%

Channel List for 802.11n(40)

Channel	Channel	Frequency (MHz)
Low	03	2422
Middle	06	2437
High	09	2452

Note: DutyCycle>98%

1.4 Ancillary equipment list

Equipment	Model	S/N	Manufacturer	Certificate type
/	/	/	/	/

1.5 Description of Support Units

The EUT has been tested as an independent unit together with other necessary accessories or support units. The following support units or accessories were used to form a representative test configuration during the tests.

Item	Equipment	Brand	Model/Type No.	Series No.	Note
1	adapter	/	SW-050100	/	/
/	/	/	/	/	/

This test report is valid for the tested samples only. It cannot be reproduced except in full without prior written consent of Shenzhen Microtest Co., Ltd.

Note:

- (1)The support equipment was authorized by Declaration of Confirmation.
- (2)For detachable type I/O cable should be specified the length in cm in 『Length』 column.

2 Summary of Test Results

Test procedures according to the technical standards:

No.	Standard Section	Test Item	Result	Remark
1	15.203	Antenna Requirement	Pass	
2	15.247 (b)	Peak Output Power	Pass	
3	15.247 (d)	Power Spectral Density	Pass	
4	15.207	Conducted Emission	Pass	
5	15.247 (c)	Radiated Spurious Emission	Pass	
6	15.205	Band Edge Emission	Pass	
7	15.247 (a)(2)	6dB Bandwidth	Pass	

This test report is valid for the tested samples only. It cannot be reproduced except in full without prior written consent of Shenzhen Microtest Co., Ltd.

3 Test Facilities and Accreditations

3.1 Test laboratory

Test Laboratory	Shenzhen Microtest Co., Ltd
Location	No.102A & 302A, East Block, Hengfang Industrial Park, Xingye Road, Xixiang, Bao'an District, Shenzhen, Guangdong, China
FCC Registration No.:	FCC Registration No.: 448573

3.2 Environmental conditions

Temperature:	20°C~30°C
Humidity	30%~70%
Atmospheric pressure	98kPa~101kPa

3.3 Measurement uncertainty

The reported uncertainty of measurement $y \pm U$ where expanded uncertainty U is based on a standard uncertainty multiplied by a coverage factor of $k=2$ providing a level of confidence of approximately 95 %

No.	Item	Uncertainty
1	Conducted Emission Test	$\pm 1.38\text{dB}$
2	RF power, conducted	$\pm 0.16\text{dB}$
3	Spurious emissions, conducted	$\pm 0.21\text{dB}$
4	All emissions, radiated(<1G)	$\pm 4.68\text{dB}$
5	All emissions, radiated(>1G)	$\pm 4.89\text{dB}$
6	Temperature	$\pm 0.5^\circ\text{C}$
7	Humidity	$\pm 2\%$

3.4 Test software

Software Name	Manufacturer	Model	Version
RF Test System	Farad	LZ-RF	Lz_Rf 3A3

This test report is valid for the tested samples only. It cannot be reproduced except in full without prior written consent of Shenzhen Microtest Co., Ltd.

4 Equipment list

Equipment No.	Equipment Name	Manufacturer	Model	Serial No.	Calibration date	Due date
MTI-E001	Spectrum Analyzer	Agilent	E4407B	MY41441082	2017/09/18	2018/09/17
MTI-E002	CMU 200 universal radio communication tester	Rohde&schwarz	CMU 200	114587	2017/09/18	2018/09/17
MTI-E003	Spectrum Analyzer	R&S	ESCI	MTI-E003	2017/09/18	2018/09/17
MTI-E004	EMI Test Receiver	Rohde&schwarz	ESPI	1000314	2017/09/18	2018/09/17
MTI-E006	Broadband antenna	schwarabeck	VULB9163	872	2017/09/18	2018/09/17
MTI-E007	Horn antenna	schwarabeck	BBHA9120D	1201	2017/09/18	2018/09/17
MTI-E014	amplifier	America	8447D	3113A06150	2017/09/18	2018/09/17
MTI-E015	Conduction Immunity Signal Generator	Schloder	CDG6000	126A1343/2015	2017/09/18	2018/09/17
MTI-E016	Coupled decoupling network	Schloder	CDA M2/M3	A2210332/2015	2017/09/18	2018/09/17
MTI-E032	Comprehensive test instrument	Rohde&schwarz	CMW500	124192	2017/09/13	2018/09/12
MTI-E034	amplifier	Agilent	8449B	3008A02400	2017/08/22	2018/08/21
MTI-E040	Spectrum analyzer	Agilent	N9020A	MY49100060	2017/09/05	2018/09/04
MTI-E041	Signal generator	Agilent	N5182A	MY49060455	2017/09/23	2018/09/22
MTI-E042	Analog signal generator	Agilent	E4421B	GB40051240	2017/09/23	2018/09/22
MTI-E043	Power probe	Dare Instruments	RPR3006W	16I00054SN016	2017/09/29	2018/09/28
MTI-E047	10dB attenuator	Mini-Circuits	UNAT-10+	15542	2017/09/24	2018/09/23
MTI-E049	spectrum analyzer	Rohde&schwarz	FSP-38	100019	2017/09/18	2018/09/17
MTI-E050	PSG Signal generator	Agilent	E8257D	MY46520873	2017/09/24	2018/09/23
MTI-E051	Active Loop Antenna 9kHz - 30MHz	Schwarzbeek	FMZB 1519 B	00044	2017/09/26	2018/09/25
MTI-E052	18-40GHz amplifier	Chengdu step Micro Technology	ZLNA-18-40G-21	1608001	2017/09/18	2018/09/17
MTI-E053	15-40G Antenna	Schwarzbeek	BBHA9170	BBHA9170582	2017/09/18	2018/09/17

Note: the calibration interval of the above test instruments is 12 months and the calibrations are traceable to international system unit (SI).

This test report is valid for the tested samples only. It cannot be reproduced except in full without prior written consent of Shenzhen Microtest Co., Ltd.

5 Test Result

5.1 Antenna requirement

5.1.1 Standard requirement

15.203 requirement: For intentional device, according to 15.203: an intentional radiator shall be designed to ensure that no antenna other than that furnished by the responsible party shall be used with the device

5.1.2 EUT Antenna

The antenna is an PCB Mounted Embedded antenna, which was permanently affixed to the device and un-replaced, complies with 15.203. In addition, the maximum antenna gain is 3.3dBi.

5.2 Peak output power

5.2.1 Limit

FCC Part15 Subpart C				
Section	Test Item	Limit	Frequency Range (MHz)	Result
15.247(b)(3)	Peak output power	1 watt or 30dBm	2400-2483.5	Pass

5.2.2 Test setup

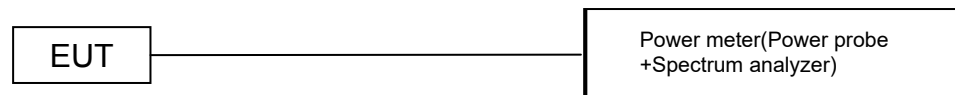

5.2.3 Test procedure

The EUT was directly connected to the Power meter.

5.2.4 Test results

802.11b

Test Channel	Frequency (MHz)	Maximum Peak Conducted Output Power	LIMIT (dBm)
CH01	2412	12.87	30
CH06	2437	12.68	30
CH11	2462	12.72	30

802.11g

Test Channel	Frequency (MHz)	Maximum Peak Conducted Output Power	LIMIT (dBm)
CH01	2412	11.76	30
CH06	2437	11.62	30
CH11	2462	11.57	30

802.11n20

Test Channel	Frequency (MHz)	Maximum Peak Conducted Output Power	LIMIT (dBm)
CH01	2412	9.05	30
CH06	2437	8.91	30
CH11	2462	8.86	30

802.11n40

Test Channel	Frequency (MHz)	Maximum Peak Conducted Output Power	LIMIT (dBm)
CH03	2422	9.02	30
CH06	2437	8.87	30
CH09	2452	8.81	30

This test report is valid for the tested samples only. It cannot be reproduced except in full without prior written consent of Shenzhen Microtest Co., Ltd.

5.3 Power spectral density

5.3.1 Limit

FCC Part15 Subpart C				
Section	Test Item	Limit	Frequency Range (MHz)	Result
15.247	Power Spectral Density	8 dBm (in any 3KHz)	2400-2483.5	Pass

5.3.2 Test Setup

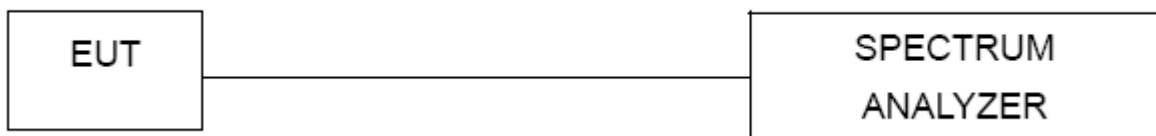

5.3.3 Test Procedure

- a. The EUT tested system was configured as the statements of 2.1 Unless otherwise a special operating condition is specified in the follows during the testing.
- b. Set analyzer center frequency to DTS channel center frequency.
- c. Set the span to 1.5 times the DTS channel bandwidth.
- d. Set the RBW \geq 3 kHz.
- e. Set the VBW \geq 3 x RBW.
- f. Detector = peak.
- g. Sweep time = auto couple.
- h. Trace mode = max hold.
- i. Allow trace to fully stabilize.
- j. Use the peak marker function to determine the maximum amplitude level.
- k. If measured value exceeds limit, reduce RBW (no less than 3 kHz) and repeat.

5.3.4 Test Results

802.11b			
Frequency	Power Density (dBm)	Limit 8dBm/3kHz	Result
2412 MHz	-11.26	8	Pass
2437 MHz	-11.94	8	Pass
2462 MHz	-11.47	8	Pass

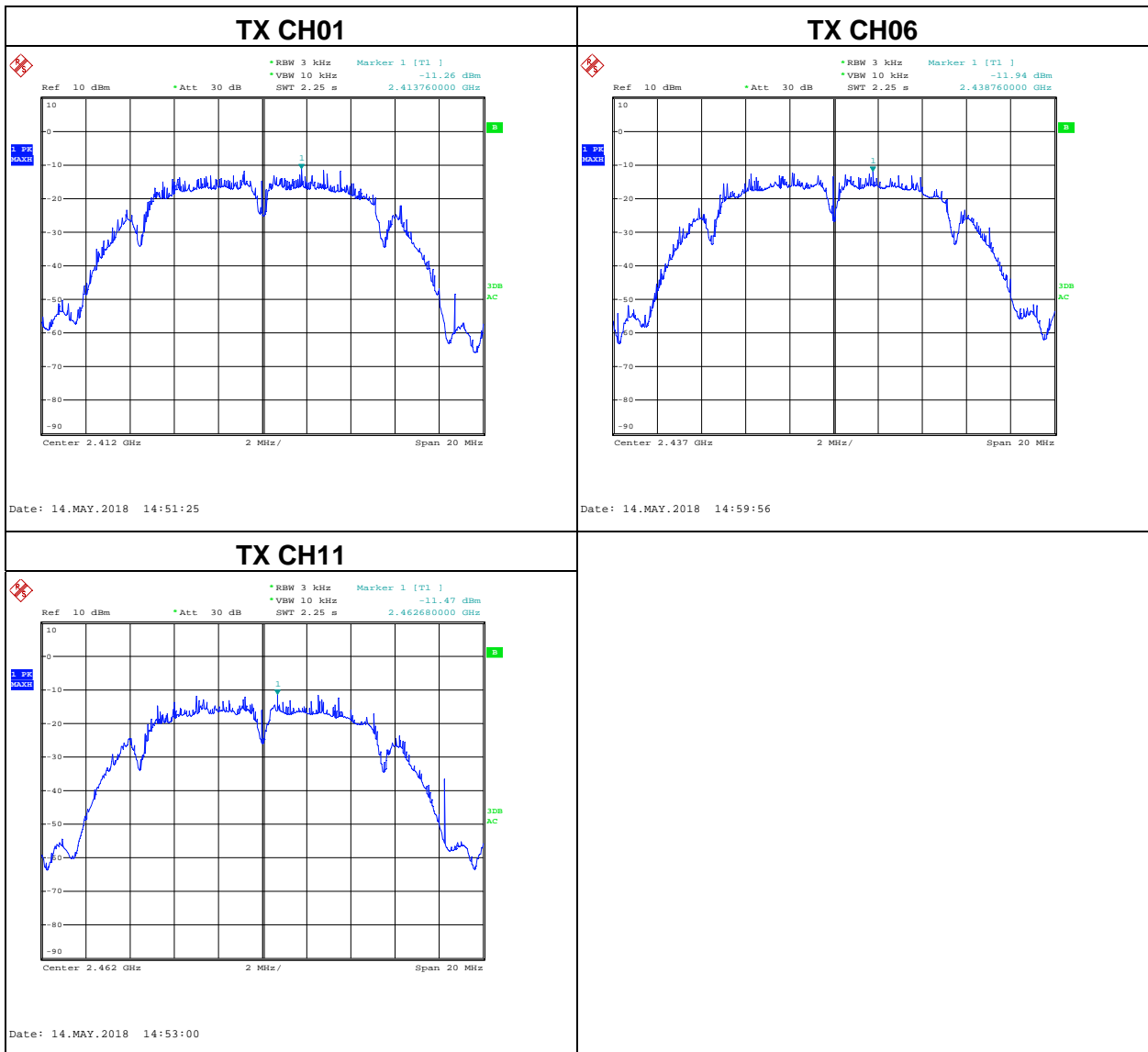

This test report is valid for the tested samples only. It cannot be reproduced except in full without prior written consent of Shenzhen Microtest Co., Ltd.

802.11g			
Frequency	Power Density (dBm)	Limit 8dBm/3kHz	Result
2412 MHz	-12.50	8	Pass
2437 MHz	-12.17	8	Pass
2462 MHz	-12.30	8	Pass

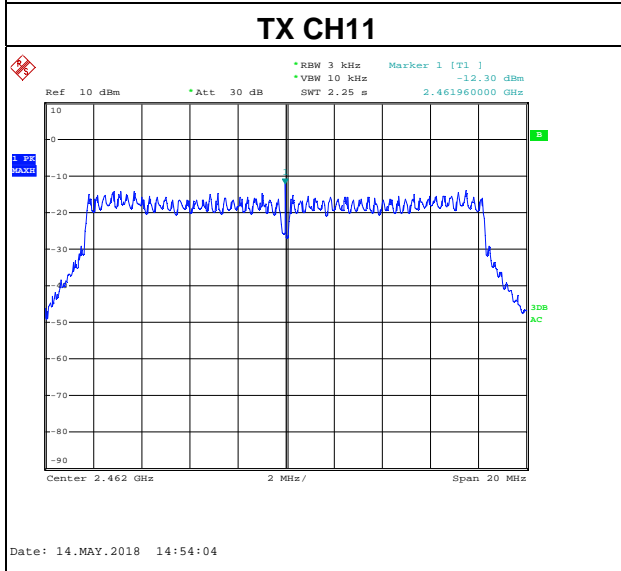
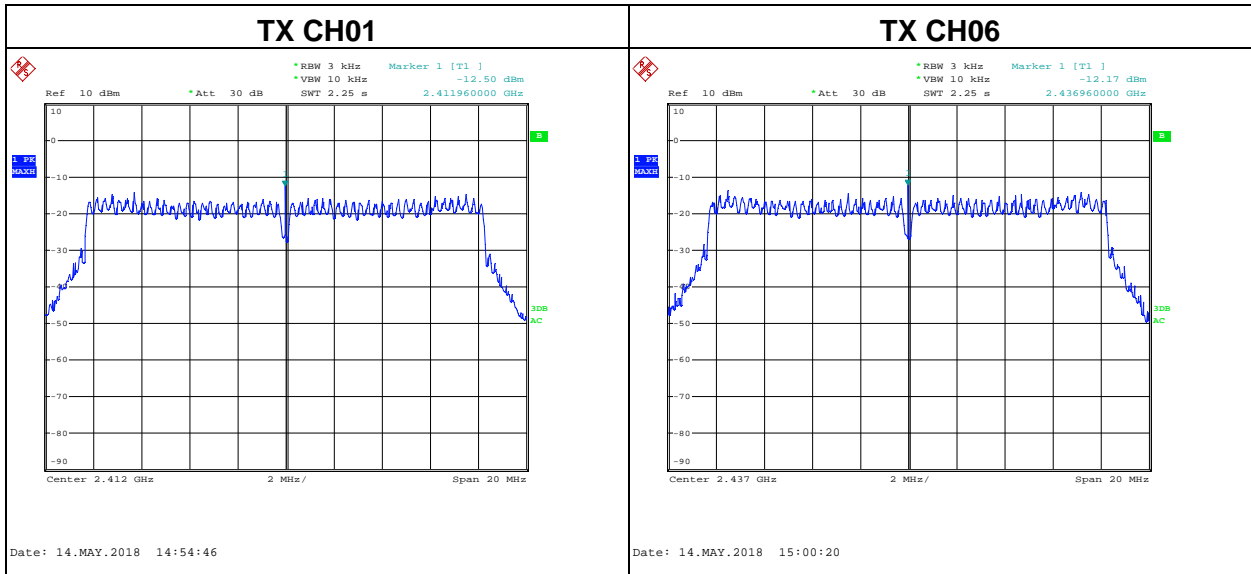

This test report is valid for the tested samples only. It cannot be reproduced except in full without prior written consent of Shenzhen Microtest Co., Ltd.

802.11n20			
Frequency	Power Density (dBm)	Limit 8dBm/3kHz	Result
2412 MHz	-12.14	8	Pass
2437 MHz	-13.36	8	Pass
2462 MHz	-12.96	8	Pass

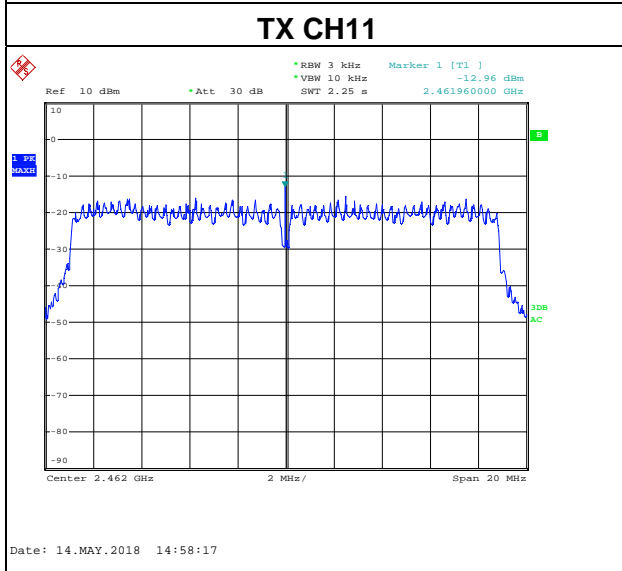
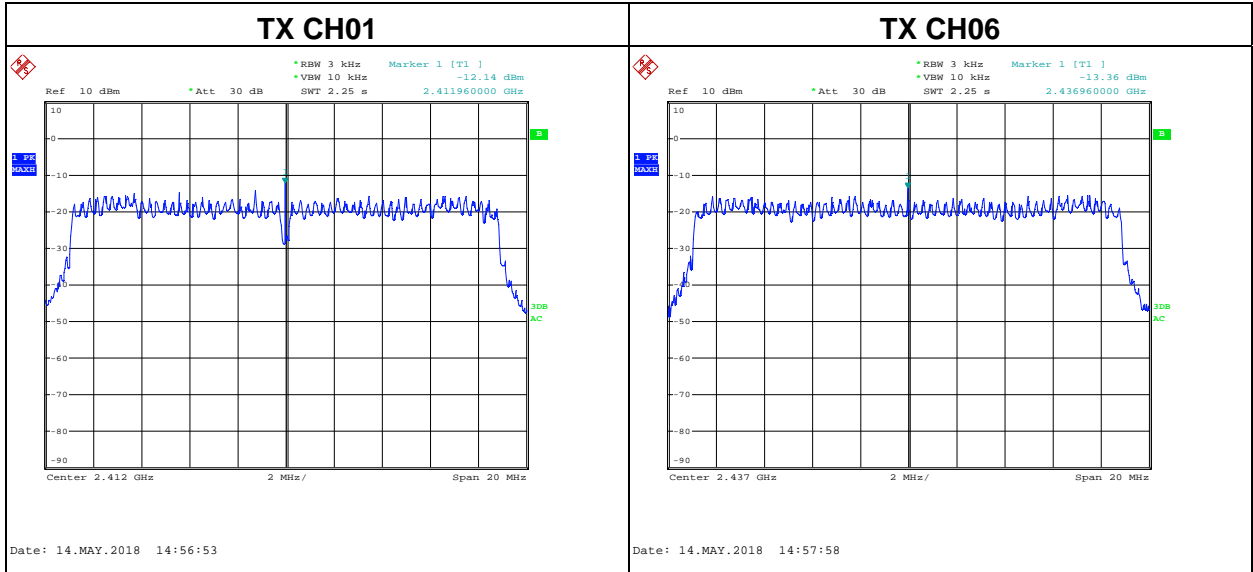

This test report is valid for the tested samples only. It cannot be reproduced except in full without prior written consent of Shenzhen Microtest Co., Ltd.

802.11n40			
Frequency	Power Density (dBm)	Limit 8dBm/3kHz	Result
2422 MHz	-11.89	8	Pass
2437 MHz	-16.89	8	Pass
2452 MHz	-13.27	8	Pass

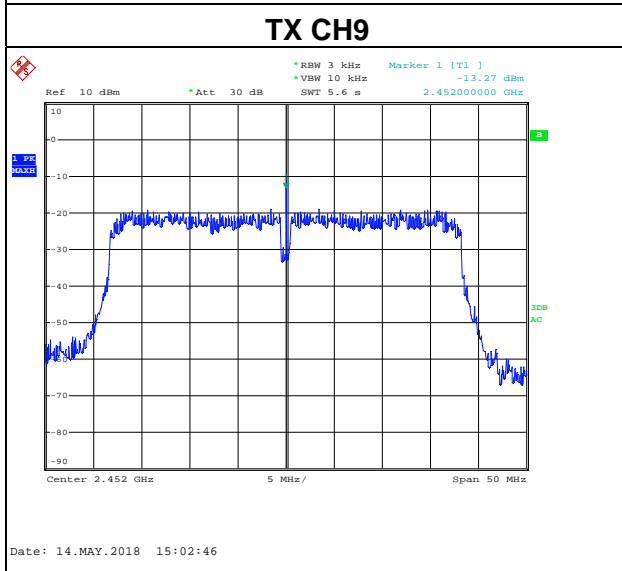
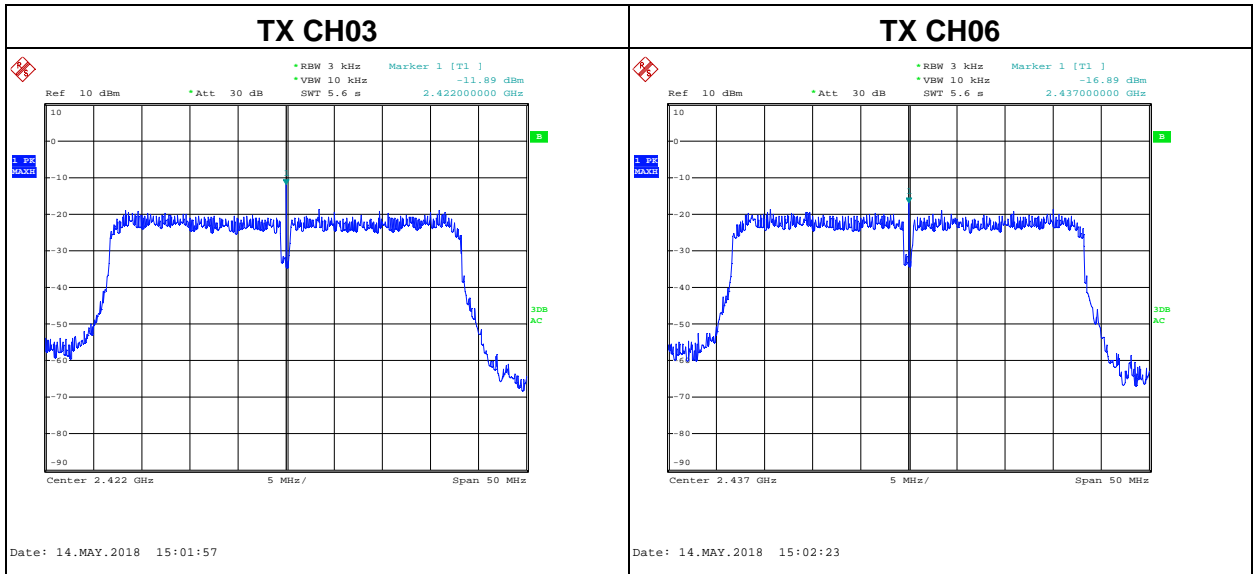

This test report is valid for the tested samples only. It cannot be reproduced except in full without prior written consent of Shenzhen Microtest Co., Ltd.

5.4 Conducted emission

5.4.1 Limits

According to FCC Part 15.207(a) and KDB 174176 D01 Line Conducted FAQ v01r01.

FREQUENCY (MHz)	Class B (dBuV)	
	Quasi-peak	Average
0.15 -0.5	66 - 56 *	56 - 46 *
0.50 -5.0	56.00	46.00
5.0 -30.0	60.00	50.00

Note

(1)The tighter limit applies at the band edges.

(2)The limit of " * " marked band means the limitation decreases linearly with the logarithm of the frequency in the range.

5.4.2 Test setup

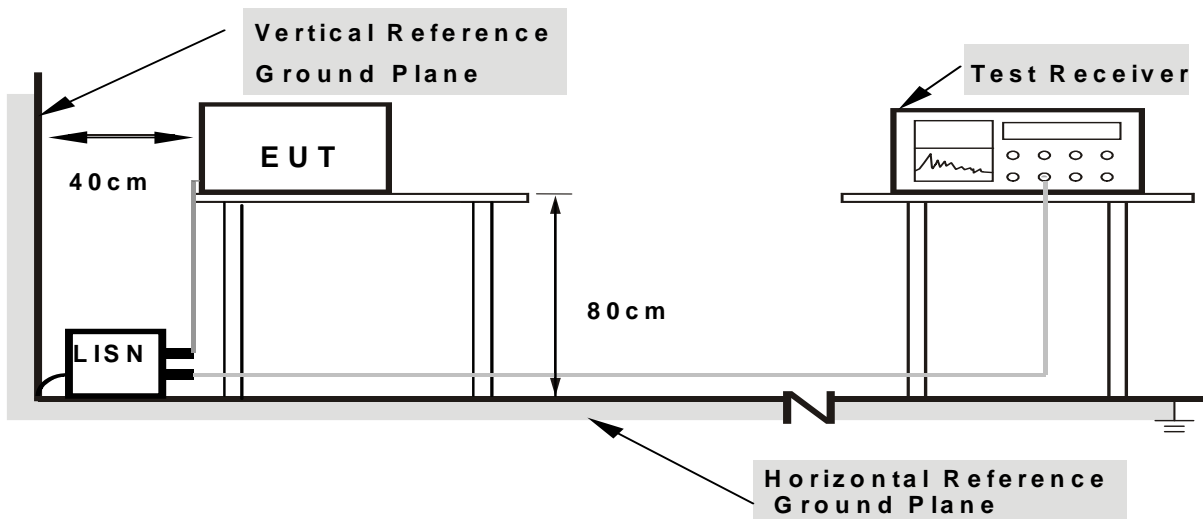

Note: 1.Support units were connected to second LISN.

2.Both of LISNs (AMN) are 80 cm from EUT and at least 80 from other units and other metal planes

5.4.3 Test procedure

a. EUT Operating Conditions

The EUT was configured for testing in a typical fashion (as a customer would normally use it). The EUT has been programmed to continuously transmit during test. This operating condition was tested and used to collect the included data.

b. The following table is the setting of the receiver

Receiver Parameters	Setting
Attenuation	10 dB
Start Frequency	0.15 MHz
Stop Frequency	30 MHz
IF Bandwidth	9 kHz

- c. The EUT was placed 0.8 meters from the horizontal ground plane with EUT being connected to the power mains through a line impedance stabilization network (LISN). All other support equipments powered from additional LISN(s). The LISN provide 50 Ohm/ 50uH of coupling impedance for the measuring instrument.
- d. Interconnecting cables that hang closer than 40 cm to the ground plane shall be folded back and forth in the center forming a bundle 30 to 40 cm long.
- e. I/O cables that are not connected to a peripheral shall be bundled in the center. The end of the cable may be terminated, if required, using the correct terminating impedance. The overall length shall not exceed 1 m.
- f. LISN at least 80 cm from nearest part of EUT chassis.

For the actual test configuration, please refer to the related Item –EUT Test Photos.

5.4.4 Test results

EUT :	IP Camera	Model Name. :	704RA
Temperature :	26 °C	Relative Humidity :	54%
Pressure :	1010hPa	Phase :	N
Test Voltage :	DC 5V from AC Adapter 120V/60Hz	Test Mode :	TX

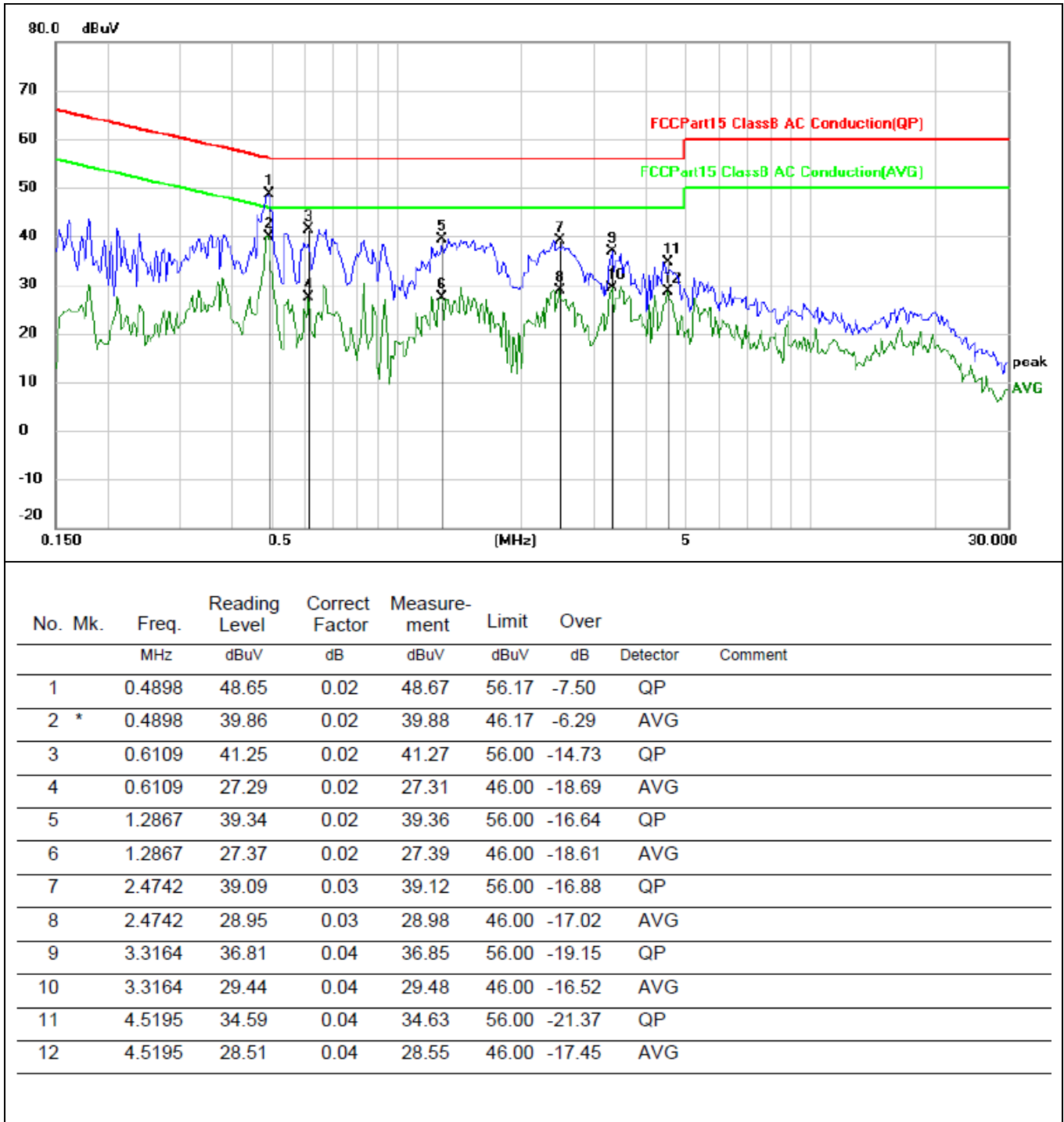

This test report is valid for the tested samples only. It cannot be reproduced except in full without prior written consent of Shenzhen Microtest Co., Ltd.

EUT :	IP Camera	Model Name. :	704RA
Temperature :	26 °C	Relative Humidity :	54%
Pressure :	1010hPa	Phase :	L
Test Voltage :	DC 5V from AC Adapter 120V/60Hz	Test Mode :	TX

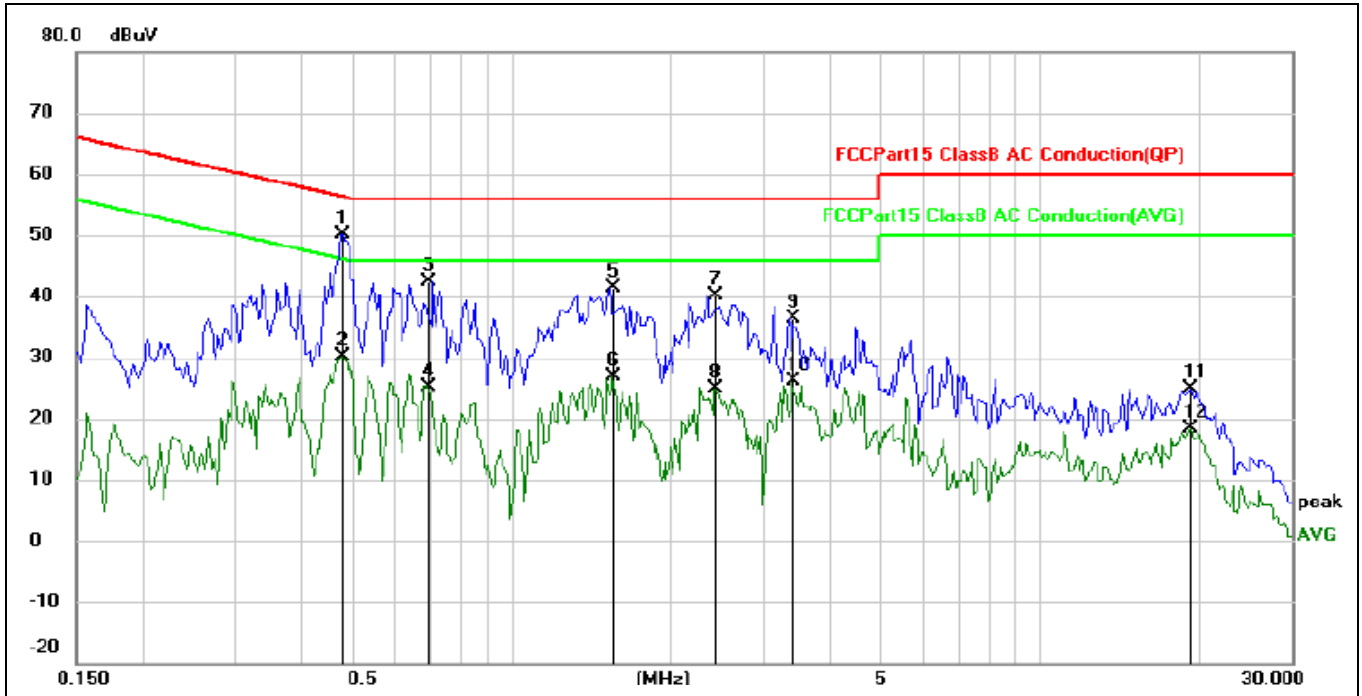

No.	Mk.	Freq. MHz	Reading Level dBuV	Correct Factor dB	Measure- ment dBuV	Limit dBuV	Over dB	Detector	Comment
1	*	0.4781	50.06	0.02	50.08	56.37	-6.29	QP	
2		0.4781	30.03	0.02	30.05	46.37	-16.32	AVG	
3		0.6969	42.26	0.02	42.28	56.00	-13.72	QP	
4		0.6969	25.11	0.02	25.13	46.00	-20.87	AVG	
5		1.5523	41.29	0.02	41.31	56.00	-14.69	QP	
6		1.5523	26.79	0.02	26.81	46.00	-19.19	AVG	
7		2.4312	40.12	0.03	40.15	56.00	-15.85	QP	
8		2.4312	24.86	0.03	24.89	46.00	-21.11	AVG	
9		3.4102	36.46	0.04	36.50	56.00	-19.50	QP	
10		3.4102	26.00	0.04	26.04	46.00	-19.96	AVG	
11		19.3164	24.90	0.09	24.99	60.00	-35.01	QP	
12		19.3164	18.35	0.09	18.44	50.00	-31.56	AVG	

This test report is valid for the tested samples only. It cannot be reproduced except in full without prior written consent of Shenzhen Microtest Co., Ltd.

5.4.5

EUT :	IP Camera	Model Name. :	704RA
Temperature :	26 °C	Relative Humidity :	54%
Pressure :	1010hPa	Phase :	N
Test Voltage :	DC 5V from AC Adapter 240V/60Hz	Test Mode :	TX

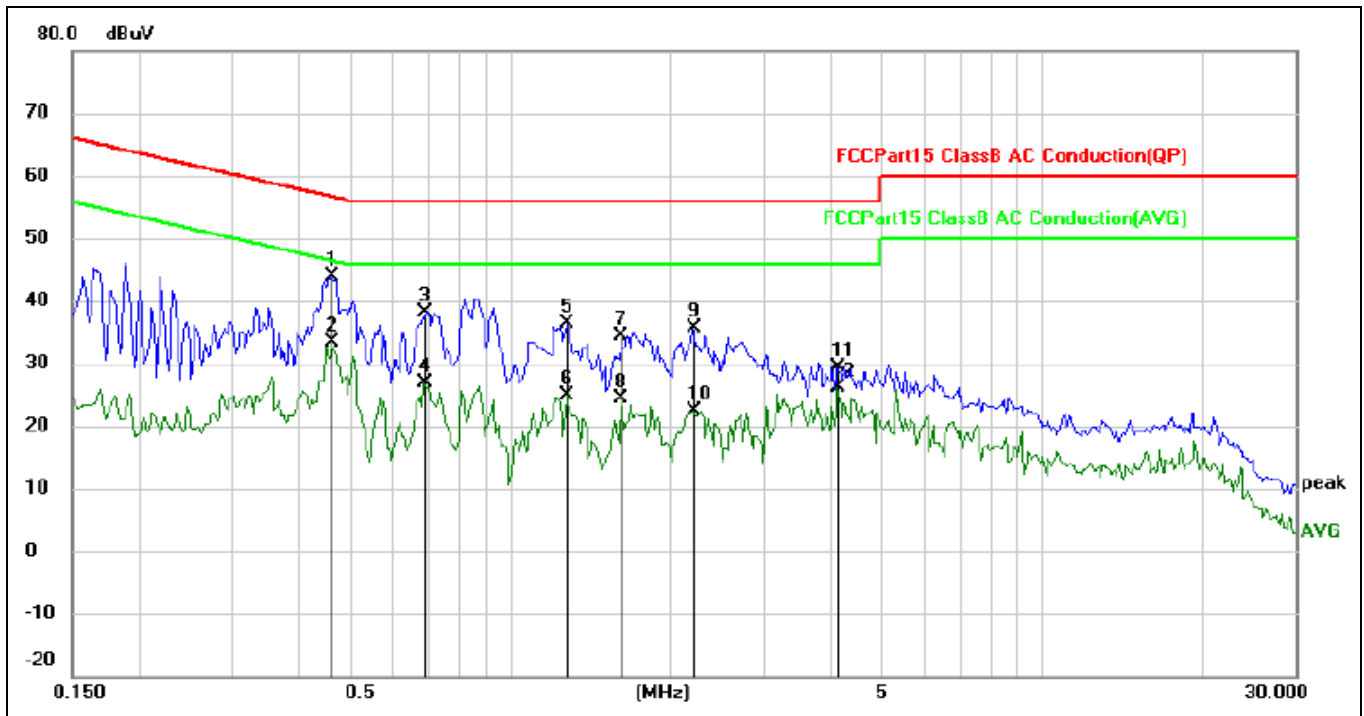

No.	Mk.	Freq. MHz	Reading Level dBuV	Correct Factor dB	Measure- ment dBuV	Limit dBuV	Over dB	Detector	Comment
1	*	0.4625	42.26	1.57	43.83	56.65	-12.82	QP	
2		0.4625	31.71	1.57	33.28	46.65	-13.37	AVG	
3		0.6891	36.53	1.57	38.10	56.00	-17.90	QP	
4		0.6891	25.19	1.57	26.76	46.00	-19.24	AVG	
5		1.2789	34.86	1.58	36.44	56.00	-19.56	QP	
6		1.2789	23.34	1.58	24.92	46.00	-21.08	AVG	
7		1.6187	32.81	1.58	34.39	56.00	-21.61	QP	
8		1.6187	22.76	1.58	24.34	46.00	-21.66	AVG	
9		2.2086	34.09	1.44	35.53	56.00	-20.47	QP	
10		2.2086	21.04	1.44	22.48	46.00	-23.52	AVG	
11		4.1211	28.68	0.82	29.50	56.00	-26.50	QP	
12		4.1211	25.32	0.82	26.14	46.00	-19.86	AVG	

This test report is valid for the tested samples only. It cannot be reproduced except in full without prior written consent of Shenzhen Microtest Co., Ltd.

EUT :	IP Camera	Model Name. :	704RA
Temperature :	26 °C	Relative Humidity :	54%
Pressure :	1010hPa	Phase :	L
Test Voltage :	DC 5V from AC Adapter 240V/60Hz	Test Mode :	TX

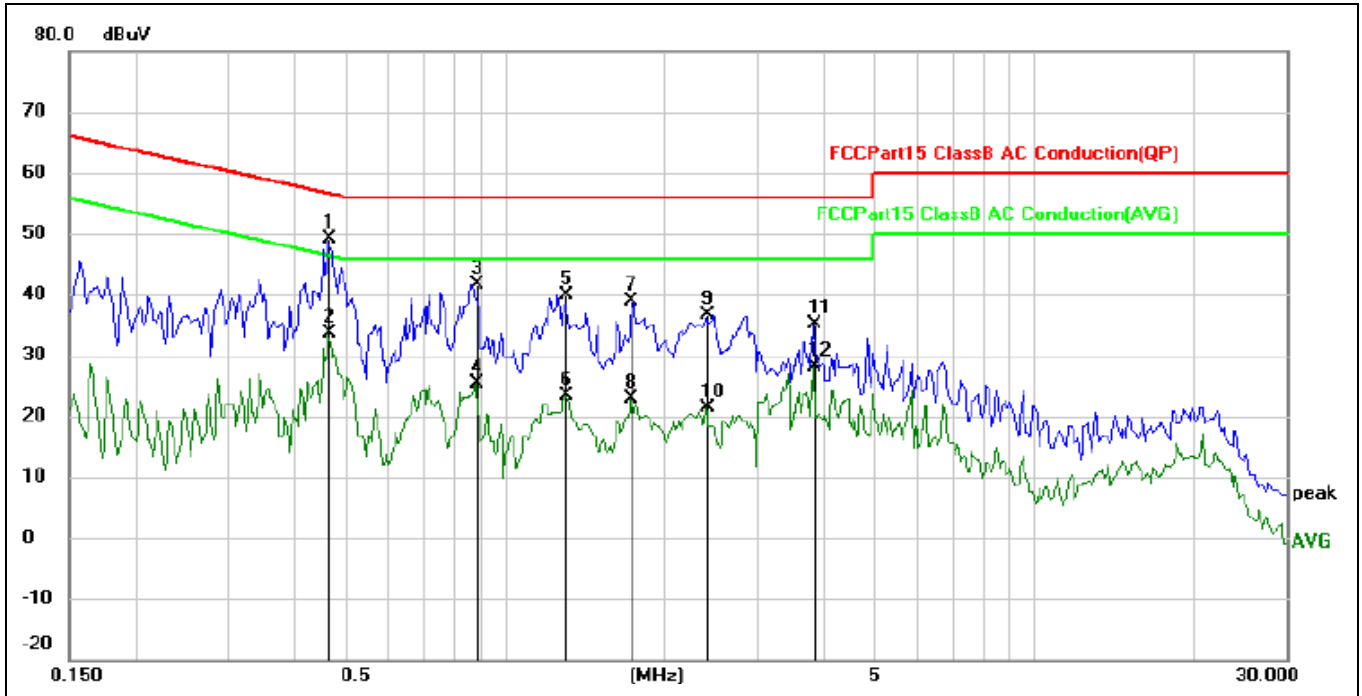

No.	Mk.	Freq. MHz	Reading Level dBuV	Correct Factor dB	Measure- ment dBuV	Limit dBuV	Over dB	Detector	Comment
1	*	0.4637	47.53	1.57	49.10	56.63	-7.53	QP	
2		0.4637	32.09	1.57	33.66	46.63	-12.97	AVG	
3		0.8805	39.97	1.57	41.54	56.00	-14.46	QP	
4		0.8805	23.89	1.57	25.46	46.00	-20.54	AVG	
5		1.3023	38.42	1.58	40.00	56.00	-16.00	QP	
6		1.3023	21.91	1.58	23.49	46.00	-22.51	AVG	
7		1.7281	37.32	1.58	38.90	56.00	-17.10	QP	
8		1.7281	21.36	1.58	22.94	46.00	-23.06	AVG	
9		2.4038	35.21	1.31	36.52	56.00	-19.48	QP	
10		2.4038	19.99	1.31	21.30	46.00	-24.70	AVG	
11		3.8320	34.10	0.91	35.01	56.00	-20.99	QP	
12		3.8320	27.14	0.91	28.05	46.00	-17.95	AVG	

This test report is valid for the tested samples only. It cannot be reproduced except in full without prior written consent of Shenzhen Microtest Co., Ltd.

5.5 Radiated spurious

5.5.1 Limits

20dBc in any 100 kHz bandwidth outside the operating frequency band. In case the emission fall within the restricted band specified on 15.205(a), then the 15.209(a) limit in the table below has to be followed.

Frequency (MHz)	Field Strength (micorvolts/meter)	Measurement Distance (meters)
0.009~0.490	2400/F(KHz)	300
0.490~1.705	24000/F(KHz)	30
1.705~30.0	30	30
30~88	100	3
88~216	150	3
216~960	200	3
Above 960	500	3

Spectrum Parameter	Setting
Attenuation	Auto
Start Frequency	1000 MHz
Stop Frequency	10th carrier harmonic
RB / VB (emission in restricted band)	1 MHz / 1 MHz for Peak, 1 MHz / 10Hz for Average

Receiver Parameter	Setting
Attenuation	Auto
Start ~ Stop Frequency	9kHz~150kHz / RB 200Hz for QP
Start ~ Stop Frequency	150kHz~30MHz / RB 9kHz for QP
Start ~ Stop Frequency	30MHz~1000MHz / RB 120kHz for QP

5.5.2 Test setup

Radiated emission test-up frequency below 30MHz

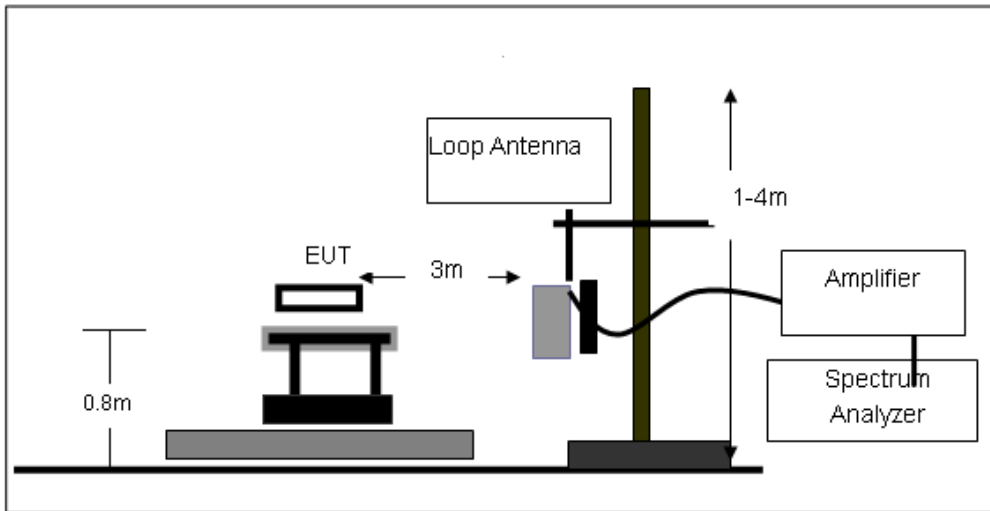

Radiated emission test-up frequency 30MHz~1GHz

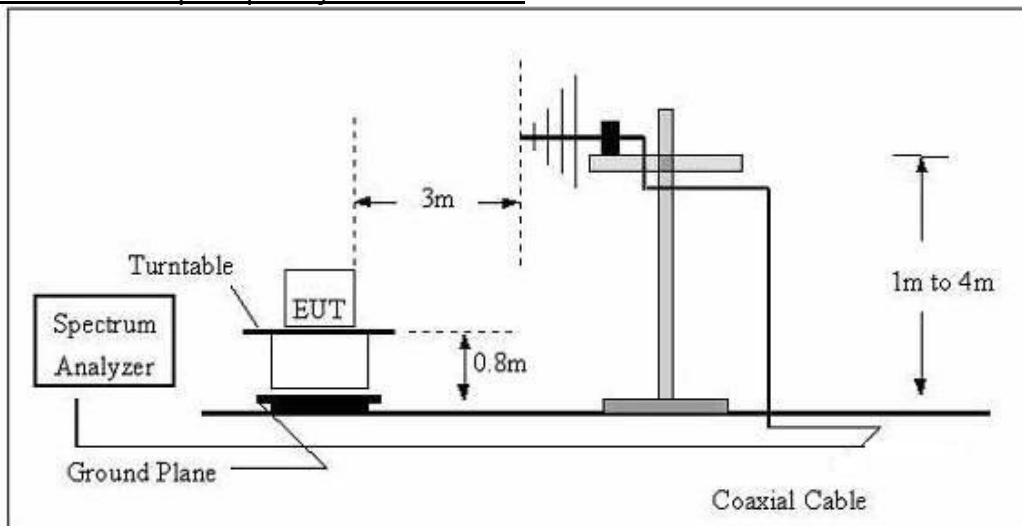

Radiated emission test-up frequency above 1GHz

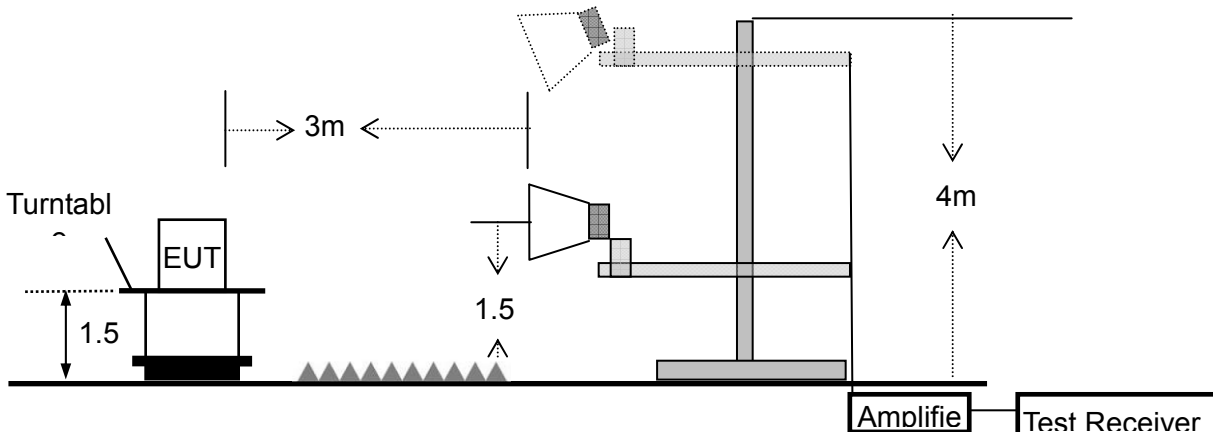

This test report is valid for the tested samples only. It cannot be reproduced except in full without prior written consent of Shenzhen Microtest Co., Ltd.

5.5.3 Test procedure

- a. EUT operating conditions. The EUT tested system was configured as the statements of 2.4 Unless otherwise a special operating condition is specified in the follows during the testing.
- b. The measuring distance of at 3 m shall be used for measurements at frequency up to 1GHz. For frequencies above 1GHz, any suitable measuring distance may be used.
- c. The EUT was placed on the top of a rotating table 0.8 meters above the ground at a 3 meter open area test site. The table was rotated 360 degrees to determine the position of the highest radiation.
- d. The height of the equipment or of the substitution antenna shall be 0.8 m; the height of the test antenna shall vary between 1 m to 4 m. Both horizontal and vertical polarizations of the antenna are set to make the measurement.
- e. The initial step in collecting conducted emission data is a spectrum analyzer peak detector mode pre-scanning the measurement frequency range. Significant peaks are then marked and then Quasi Peak detector mode re-measured.
- f. If the Peak Mode measured value compliance with and lower than Quasi Peak Mode Limit, the EUT shall be deemed to meet QP Limits and then no additional QP Mode measurement performed.
- g. For the actual test configuration, please refer to the related Item –EUT Test photos.

Note: Both horizontal and vertical antenna polarities were tested and performed pretest to three orthogonal axis. The worst case emissions were reported

5.5.4 Test results

5.5.4.1 Radiation emission

Below 30MHz

EUT :	IP Camera	Model Name :	704RA
Relative Humidity:	52%	Phase:	H
Pressure:	1010 hPa	Test Voltage :	DC 5V from adapter AC 120V/60Hz
Test Mode :	TX		

Freq. (MHz)	Reading (dBuV/m)	Limit (dBuV/m)	Margin (dB)	State P/F
--	--	--	--	Pass
--	--	--	--	Pass

Note:

The amplitude of spurious emissions which are attenuated by more than 20dB below the permissible value has no need to be reported.

Distance extrapolation factor = $40 \log(\text{specific distance}/\text{test distance})$ (dB);

Limit line = specific limits(dBuV) + distance extrapolation factor.

Between 30MHz – 1GHz

All the modulation modes have been tested, and the worst result was report as below:

EUT :	IP Camera	Model Name :	704RA
Relative Humidity:	52%	Phase:	H
Pressure:	1010 hPa	Test Voltage :	DC 5V from adapter AC 120V/60Hz
Test Mode :	TX		

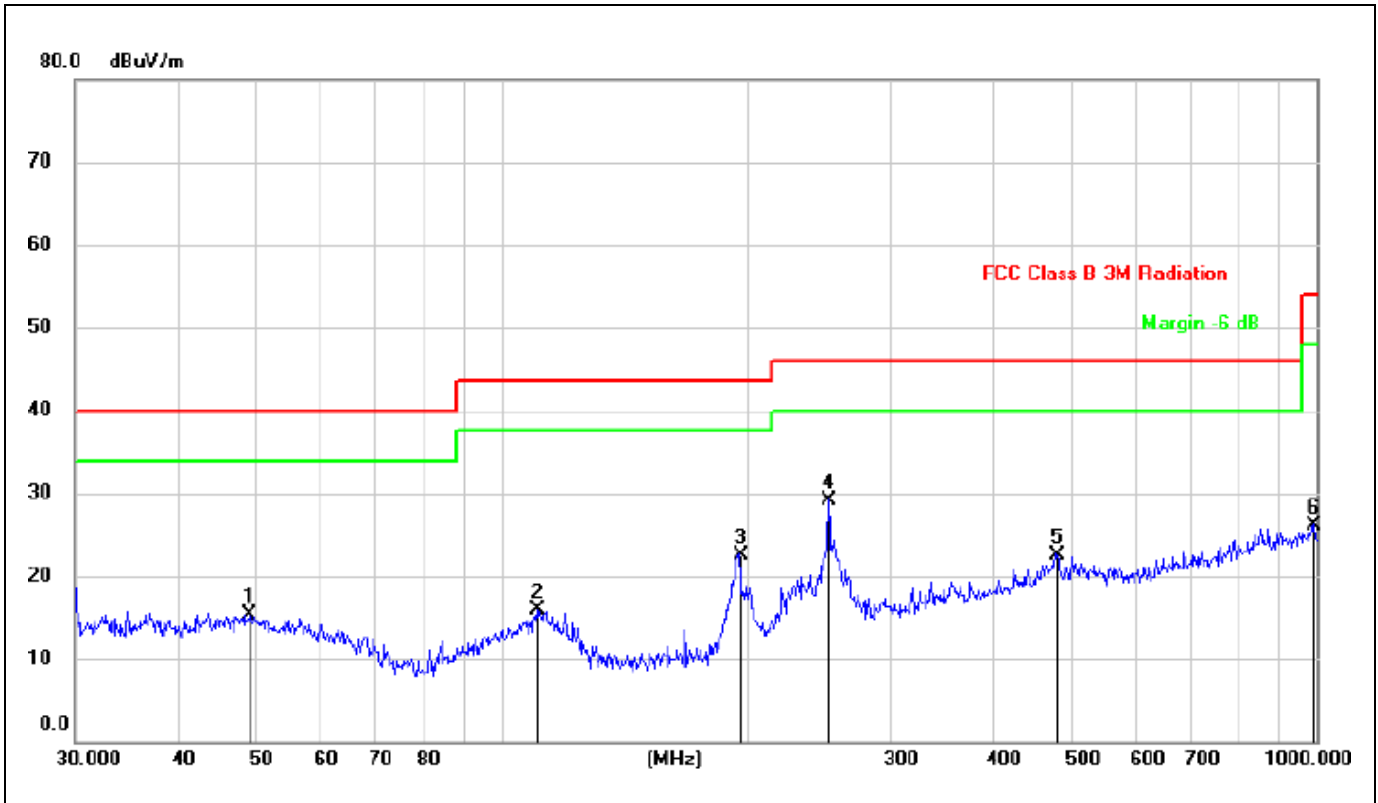

No.	Mk.	Freq. MHz	Reading Level dBuV	Correct Factor dBuV/m	Measure- ment dBuV/m	Limit dBuV/m	Over dB	Detector
1		49.1865	24.97	-9.67	15.30	40.00	-24.70	QP
2		110.5687	27.45	-11.55	15.90	43.50	-27.60	QP
3		195.8220	34.97	-12.37	22.60	43.50	-20.90	QP
4	*	252.0627	39.16	-9.96	29.20	46.00	-16.80	QP
5		478.8456	27.99	-5.39	22.60	46.00	-23.40	QP
6		993.0114	26.62	-0.42	26.20	54.00	-27.80	QP

This test report is valid for the tested samples only. It cannot be reproduced except in full without prior written consent of Shenzhen Microtest Co., Ltd.

EUT :	IP Camera	Model Name :	704RA
Relative Humidity:	52%	Phase:	V
Pressure:	1010 hPa	Test Voltage :	DC 5V from adapter AC 120V/60Hz
Test Mode :	TX		

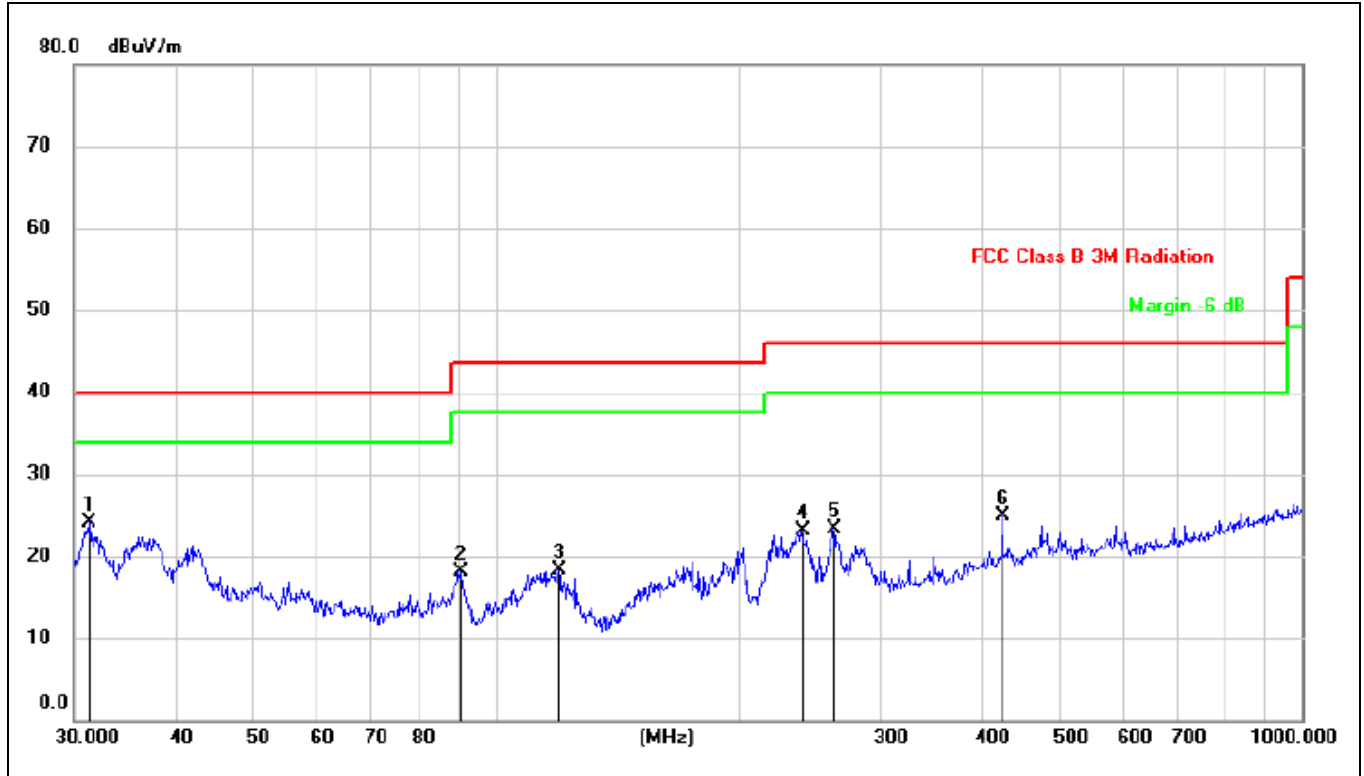

No.	Mk.	Freq. MHz	Reading Level dBuV	Correct Factor dBuV/m	Measure- ment dBuV/m	Limit dBuV/m	Over dB	Detector
1	*	31.3992	35.66	-11.46	24.20	40.00	-15.80	QP
2		90.5374	31.22	-13.02	18.20	43.50	-25.30	QP
3		119.8556	30.37	-12.07	18.30	43.50	-25.20	QP
4		239.9874	33.46	-10.36	23.10	46.00	-22.90	QP
5		261.9753	33.69	-10.29	23.40	46.00	-22.60	QP
6		425.0280	31.18	-6.18	25.00	46.00	-21.00	QP

This test report is valid for the tested samples only. It cannot be reproduced except in full without prior written consent of Shenzhen Microtest Co., Ltd.

1G-25GHz

Note: (1)RBW 3MHz VBW 3MHz , PK detector for PK value, RMS detector for AV value
(2) Emission Level= Antenna Factor + Cable Loss + Read Level - Preamp Factor
(3) All other emissions more than 20dB below the limit.

All the modulation modes have been tested, and the worst result was report as below:

For 802.11b

Frequency	Read Level	Cable loss	Antenna Factor	Preamp Factor	Emission Level	Limits	Margin	Remark	Comment
(MHz)	(dBμV)	(dB)	dB/m	(dB)	(dBμV/m)	(dBμV/m)	(dB)		
Low Channel (2412 MHz)(802.11b)--Above 1G									
4824.161	62.79	5.21	35.59	44.30	59.29	74.00	-14.71	Pk	Vertical
4824.161	41.07	5.21	35.59	44.30	37.57	54.00	-16.43	AV	Vertical
7236.396	60.29	6.48	36.27	44.60	58.44	74.00	-15.56	Pk	Vertical
7236.396	43.69	6.48	36.27	44.60	41.84	54.00	-12.16	AV	Vertical
4824.154	61.36	5.21	35.55	44.30	57.82	74.00	-16.18	Pk	Horizontal
4824.154	42.35	5.21	35.55	44.30	38.81	54.00	-15.19	AV	Horizontal
7236.168	63.46	6.48	36.27	44.52	61.69	74.00	-12.31	Pk	Horizontal
7236.168	46.81	6.48	36.27	44.52	45.04	54.00	-8.96	AV	Horizontal
Middle Channel (2437 MHz)(802.11b)--Above 1G									
4874.112	62.41	5.21	35.66	44.20	59.08	74.00	-14.92	Pk	Vertical
4874.112	42.27	5.21	35.66	44.20	38.94	54.00	-15.06	AV	Vertical
7311.247	59.71	7.10	36.50	44.43	58.88	74.00	-15.12	Pk	Vertical
7311.247	47.37	7.10	36.50	44.43	46.54	54.00	-7.46	AV	Vertical
4874.132	61.13	5.21	35.66	44.20	57.80	74.00	-16.20	Pk	Horizontal
4874.132	48.44	5.21	35.66	44.20	45.11	54.00	-8.89	AV	Horizontal
7311.085	59.92	7.10	36.50	44.43	59.09	74.00	-14.91	Pk	Horizontal
7311.085	41.67	7.10	36.50	44.43	40.84	54.00	-13.16	AV	Horizontal
High Channel (2462 MHz)(802.11b)--Above 1G									
4924.169	65.40	5.21	35.52	44.21	61.92	74.00	-12.08	Pk	Vertical
4924.169	43.16	5.21	35.52	44.21	39.68	54.00	-14.32	AV	Vertical
7386.215	61.29	7.10	36.53	44.60	60.32	74.00	-13.68	Pk	Vertical
7386.215	44.32	7.10	36.53	44.60	43.35	54.00	-10.65	AV	Vertical
4924.045	67.11	5.21	35.52	44.21	63.63	74.00	-10.37	Pk	Horizontal
4924.045	46.76	5.21	35.52	44.21	43.28	54.00	-10.72	AV	Horizontal
7386.132	60.90	7.10	36.53	44.60	59.93	74.00	-14.07	Pk	Horizontal
7386.132	45.10	7.10	36.53	44.60	44.13	54.00	-9.87	AV	Horizontal

This test report is valid for the tested samples only. It cannot be reproduced except in full without prior written consent of Shenzhen Microtest Co., Ltd.

5.5.4.2 Band edge - radiated

Note: (1)RBW 3MHz VBW 3MHz , PK detector for PK value, RMS detector for AV value
(2)Emission Level= Antenna Factor + Cable Loss + Read Level - Preamp Factor
(3) All other emissions more than 20dB below the limit.

Frequency	Meter Reading	Cable Loss	Antenna Factor	Preamp Factor	Emission Level	Limits	Margin	Detector	Comment
(MHz)	(dBμV)	(dB)	dB/m	(dB)	(dBμV/m)	(dBμV/m)	(dB)	Type	
802.11b									
2310.00	55.74	2.97	27.80	43.80	42.71	74	-31.29	Pk	Horizontal
2310.00	43.41	2.97	27.80	43.80	30.38	54	-23.62	AV	Horizontal
2310.00	59.03	2.97	27.80	43.80	46.00	74	-28.00	Pk	Vertical
2310.00	42.42	2.97	27.80	43.80	29.39	54	-24.61	AV	Vertical
2390.00	57.32	3.14	27.21	43.80	43.87	74	-30.13	Pk	Vertical
2390.00	41.79	3.14	27.21	43.80	28.34	54	-25.66	AV	Vertical
2390.00	56.97	3.14	27.21	43.80	43.52	74	-30.48	Pk	Horizontal
2390.00	41.98	3.14	27.21	43.80	28.53	54	-25.47	AV	Horizontal
2483.50	58.28	3.58	27.70	44.00	45.56	74	-28.44	Pk	Vertical
2483.50	42.60	3.58	27.70	44.00	29.88	54	-24.12	AV	Vertical
2483.50	58.98	3.58	27.70	44.00	46.26	74	-27.74	Pk	Horizontal
2483.50	41.77	3.58	27.70	44.00	29.05	54	-24.95	AV	Horizontal
802.11g									
2310.00	58.28	2.97	27.80	43.80	45.25	74	-28.75	Pk	Horizontal
2310.00	44.06	2.97	27.80	43.80	31.03	54	-22.97	AV	Horizontal
2310.00	56.40	2.97	27.80	43.80	43.37	74	-30.63	Pk	Vertical
2310.00	43.24	2.97	27.80	43.80	30.21	54	-23.79	AV	Vertical
2390.00	57.98	3.14	27.21	43.80	44.53	74	-29.47	Pk	Vertical
2390.00	42.34	3.14	27.21	43.80	28.89	54	-25.11	AV	Vertical
2390.00	57.70	3.14	27.21	43.80	44.25	74	-29.75	Pk	Horizontal
2390.00	43.35	3.14	27.21	43.80	29.90	54	-24.10	AV	Horizontal
2483.50	59.20	3.58	27.70	44.00	46.48	74	-27.52	Pk	Vertical
2483.50	44.21	3.58	27.70	44.00	31.49	54	-22.51	AV	Vertical
2483.50	58.47	3.58	27.70	44.00	45.75	74	-28.25	Pk	Horizontal
2483.50	42.10	3.58	27.70	44.00	29.38	54	-24.62	AV	Horizontal

This test report is valid for the tested samples only. It cannot be reproduced except in full without prior written consent of Shenzhen Microtest Co., Ltd.

802.11n20									
2310.00	57.65	2.97	27.80	43.80	44.62	74	-29.38	Pk	Horizontal
2310.00	43.83	2.97	27.80	43.80	30.80	54	-23.20	AV	Horizontal
2310.00	58.36	2.97	27.80	43.80	45.33	74	-28.67	Pk	Vertical
2310.00	42.20	2.97	27.80	43.80	29.17	54	-24.83	AV	Vertical
2390.00	58.05	3.14	27.21	43.80	44.60	74	-29.40	Pk	Vertical
2390.00	42.30	3.14	27.21	43.80	28.85	54	-25.15	AV	Vertical
2390.00	56.80	3.14	27.21	43.80	43.35	74	-30.65	Pk	Horizontal
2390.00	41.86	3.14	27.21	43.80	28.41	54	-25.59	AV	Horizontal
2483.50	57.60	3.58	27.70	44.00	44.88	74	-29.12	Pk	Vertical
2483.50	42.24	3.58	27.70	44.00	29.52	54	-24.48	AV	Vertical
2483.50	59.10	3.58	27.70	44.00	46.38	74	-27.62	Pk	Horizontal
2483.50	41.68	3.58	27.70	44.00	28.96	54	-25.04	AV	Horizontal
802.11n40									
2310.00	59.30	2.97	27.80	43.80	46.27	74	-27.73	Pk	Horizontal
2310.00	44.94	2.97	27.80	43.80	31.91	54	-22.09	AV	Horizontal
2310.00	56.67	2.97	27.80	43.80	43.64	74	-30.36	Pk	Vertical
2310.00	43.67	2.97	27.80	43.80	30.64	54	-23.36	AV	Vertical
2390.00	57.62	3.14	27.21	43.80	44.17	74	-29.83	Pk	Vertical
2390.00	42.07	3.14	27.21	43.80	28.62	54	-25.38	AV	Vertical
2390.00	58.29	3.14	27.21	43.80	44.84	74	-29.16	Pk	Horizontal
2390.00	43.96	3.14	27.21	43.80	30.51	54	-23.49	AV	Horizontal
2483.50	58.38	3.58	27.70	44.00	45.66	74	-28.34	Pk	Vertical
2483.50	44.67	3.58	27.70	44.00	31.95	54	-22.05	AV	Vertical
2483.50	59.07	3.58	27.70	44.00	46.35	74	-27.65	Pk	Horizontal
2483.50	41.85	3.58	27.70	44.00	29.13	54	-24.87	AV	Horizontal

This test report is valid for the tested samples only. It cannot be reproduced except in full without prior written consent of Shenzhen Microtest Co., Ltd.

5.5.4.3 Spurious Emission in Restricted Band 3260MHz-18000MHz

All the modulation modes have been tested, and the worst result was report as below:

Frequency	Reading	Cable	Antenna	Preamp	Emission	Limits	Margin	Detector	Comment
(MHz)	(dB μ V)	(dB)	dB/m	(dB)	(dB μ V/m)	(dB μ V/m)	(dB)	Type	
3260	60.61	4.04	29.57	44.70	49.52	74	-24.48	Pk	Vertical
3260	55.96	4.04	29.57	44.70	44.87	54	-9.13	AV	Vertical
3260	61.49	4.04	29.57	44.70	50.40	74	-23.60	Pk	Horizontal
3260	56.95	4.04	29.57	44.70	45.86	54	-8.14	AV	Horizontal
3332	64.88	4.26	29.87	44.40	54.61	74	-19.39	Pk	Vertical
3332	53.83	4.26	29.87	44.40	43.56	54	-10.44	AV	Vertical
3332	62.75	4.26	29.87	44.40	52.48	74	-21.52	Pk	Horizontal
3332	52.67	4.26	29.87	44.40	42.40	54	-11.60	AV	Horizontal
17797	42.74	10.99	43.95	43.50	54.18	74	-19.82	Pk	Vertical
17797	32.97	10.99	43.95	43.50	44.41	54	-9.59	AV	Vertical
17788	43.71	11.81	43.69	44.60	54.61	74	-19.39	Pk	Horizontal
17788	32.38	11.81	43.69	44.60	43.28	54	-10.72	AV	Horizontal

This test report is valid for the tested samples only. It cannot be reproduced except in full without prior written consent of Shenzhen Microtest Co., Ltd.

5.6 Conduction spurious emission

5.6.1 Limits

In any 100 kHz bandwidth outside the frequency band in which the spread spectrum or digitally modulated intentional radiator is operating, the radio frequency power that is produced by the intentional radiator shall be at least 20 dB below that in the 100 kHz bandwidth within the band that contains the highest level of the desired power, based on either an RF conducted or a radiated measurement, provided the transmitter demonstrates compliance with the peak conducted power limits. If the transmitter complies with the conducted power limits based on the use of RMS averaging over a time interval, as permitted under paragraph (b)(3) of this section, the attenuation required under this paragraph shall be 30 dB instead of 20 dB. Attenuation below the general limits specified in §15.209(a) is not required. In addition, radiated emissions which fall in the restricted bands, as defined in §15.205(a), must also comply with the radiated emission limits specified in §15.209(a) (see §15.205(c)).

5.6.2 Test setup

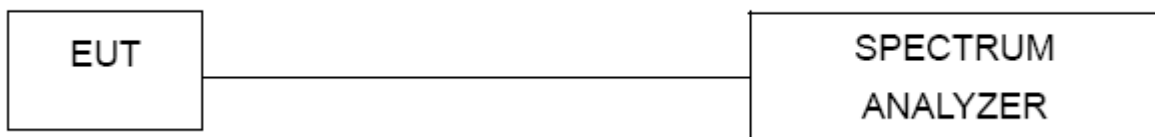

5.6.3 Test procedure

- a) Check the calibration of the measuring instrument using either an internal calibrator or a known signal from an external generator.
- b) Position the EUT without connection to measurement instrument. Turn on the EUT and connect its antenna terminal to measurement instrument via a low loss cable. Then set it to any one measured frequency within its operating range, and make sure the instrument is operated in its linear range.
- c) Set RBW to 100 kHz and VBW of spectrum analyzer to 300 kHz with a convenient frequency span including 100 kHz bandwidth from band edge.
- d) Measure the highest amplitude appearing on spectral display and set it as a reference level. Plot the graph with marking the highest point and edge frequency.
- e) Repeat above procedures until all measured frequencies were complete.

EUT OPERATION CONDITIONS

The EUT tested system was configured as the statements of 2.4 Unless otherwise a special operating condition is specified in the follows during the testing.

5.6.4 Test results

Test plots:

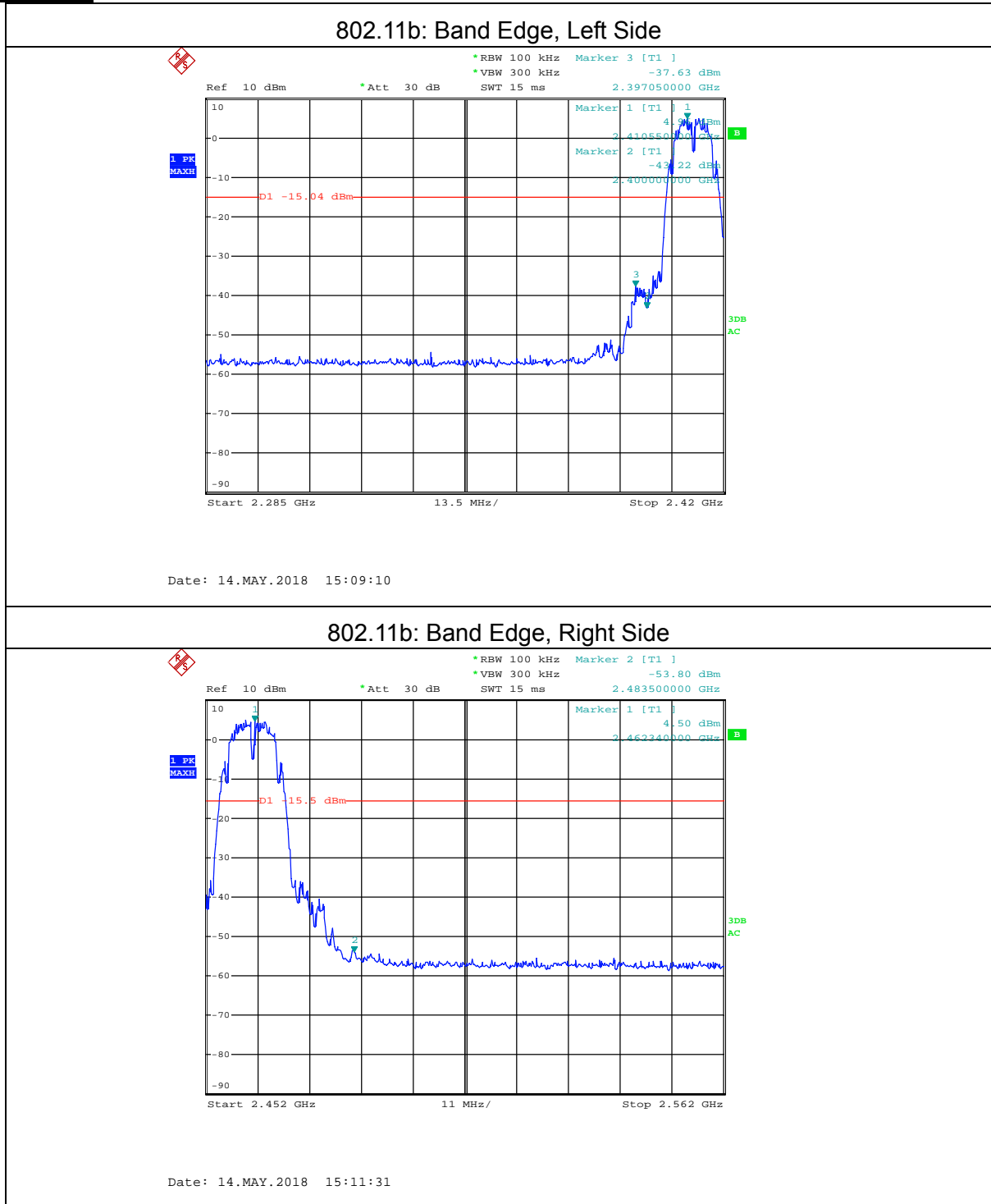

This test report is valid for the tested samples only. It cannot be reproduced except in full without prior written consent of Shenzhen Microtest Co., Ltd.

802.11g: Band Edge, Left Side

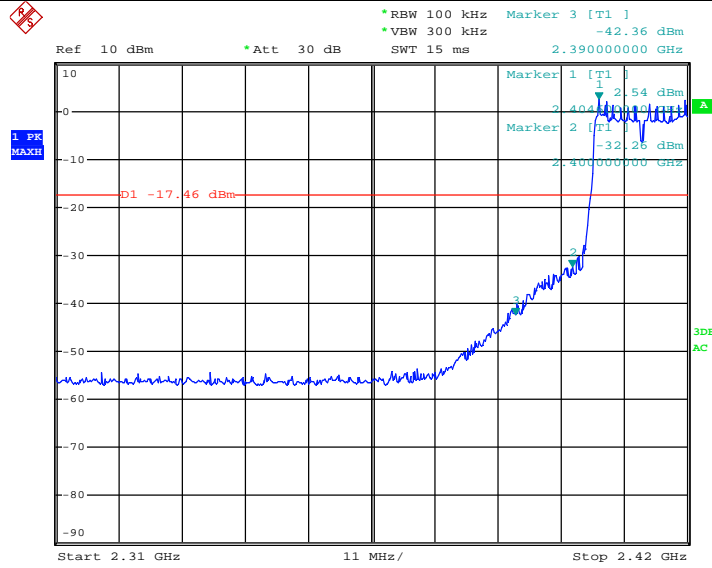

Date: 14.MAY.2018 15:20:01

802.11g: Band Edge, Right Side

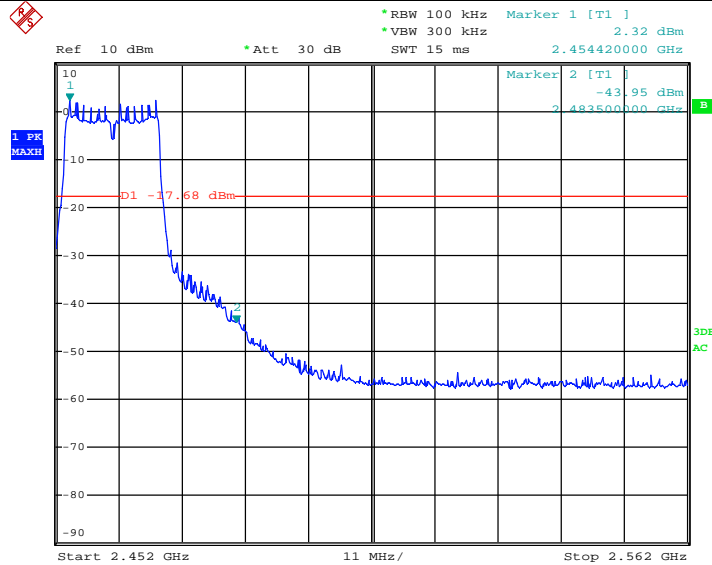

Date: 14.MAY.2018 15:13:23

This test report is valid for the tested samples only. It cannot be reproduced except in full without prior written consent of Shenzhen Microtest Co., Ltd.

802.11n20: Band Edge, Left Side

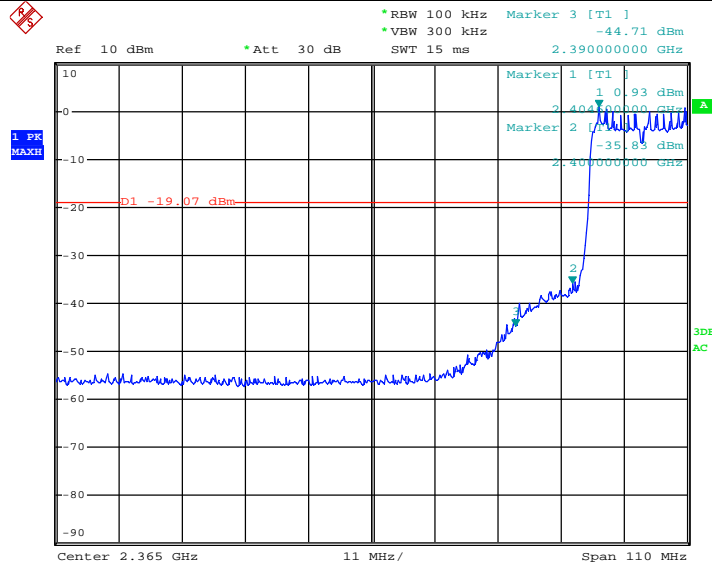

Date: 14.MAY.2018 15:22:41

802.11n20: Band Edge, Right Side

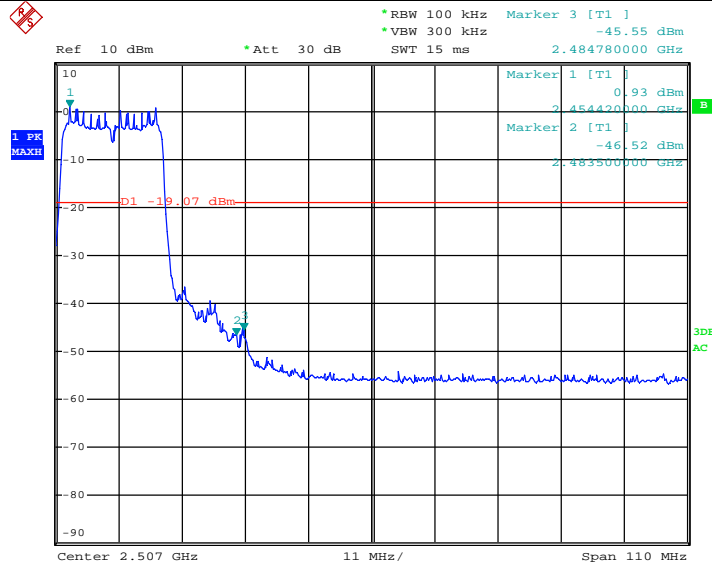

Date: 14.MAY.2018 15:35:38

This test report is valid for the tested samples only. It cannot be reproduced except in full without prior written consent of Shenzhen Microtest Co., Ltd.

802.11n40: Band Edge, Left Side

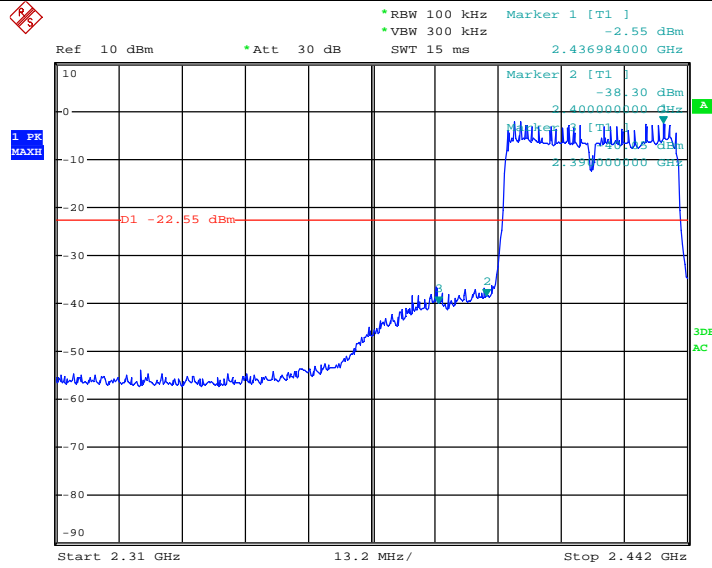

Date: 14.MAY.2018 15:44:40

802.11n40: Band Edge, Right Side

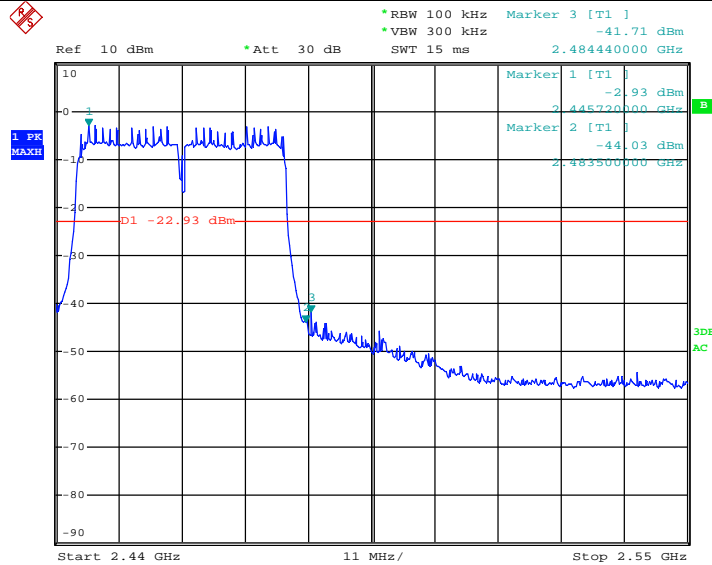

Date: 14.MAY.2018 15:40:42

This test report is valid for the tested samples only. It cannot be reproduced except in full without prior written consent of Shenzhen Microtest Co., Ltd.

5.7 6dB bandwidth

5.7.1 Limit

FCC Part15 Subpart C				
Section	Test Item	Limit	Frequency Range (MHz)	Result
15.247(a)(2)	Bandwidth	$\geq 500\text{KHz}$ (6dB bandwidth)	2400-2483.5	Pass

5.7.2 Test setup



5.7.3 Test procedure

- a. Set RBW= 100 kHz.
- b. Set the video bandwidth (VBW) $\geq 3 \times$ RBW.
- c. Detector = Peak.
- d. Trace mode = max hold.
- e. Sweep = auto couple.
- f. Allow the trace to stabilize.
- g. Measure the maximum width of the emission that is constrained by the frequencies associated with the two outermost amplitude points (upper and lower) that are attenuated by 6 dB relative to the maximum level measured in the fundamental emission.

EUT Operation Conditions

The EUT tested system was configured as the statements of 2.4 Unless otherwise a special operating condition is specified in the follows during the testing.

5.7.4 Test results

EUT :	IP Camera	Model Name :	704RA
Temperature :	25 °C	Relative Humidity :	60%
Pressure :	1012 hPa	Test Voltage :	DC 5V from AC Adapter 120V/60Hz
Test Mode :	TX b Mode /CH01, CH06, CH11		

Channel	Frequency (MHz)	6dB bandwidth (MHz)	Limit (kHz)	Result
Low	2412	9.92	500	Pass
Middle	2437	9.92	500	Pass
High	2462	9.52	500	Pass

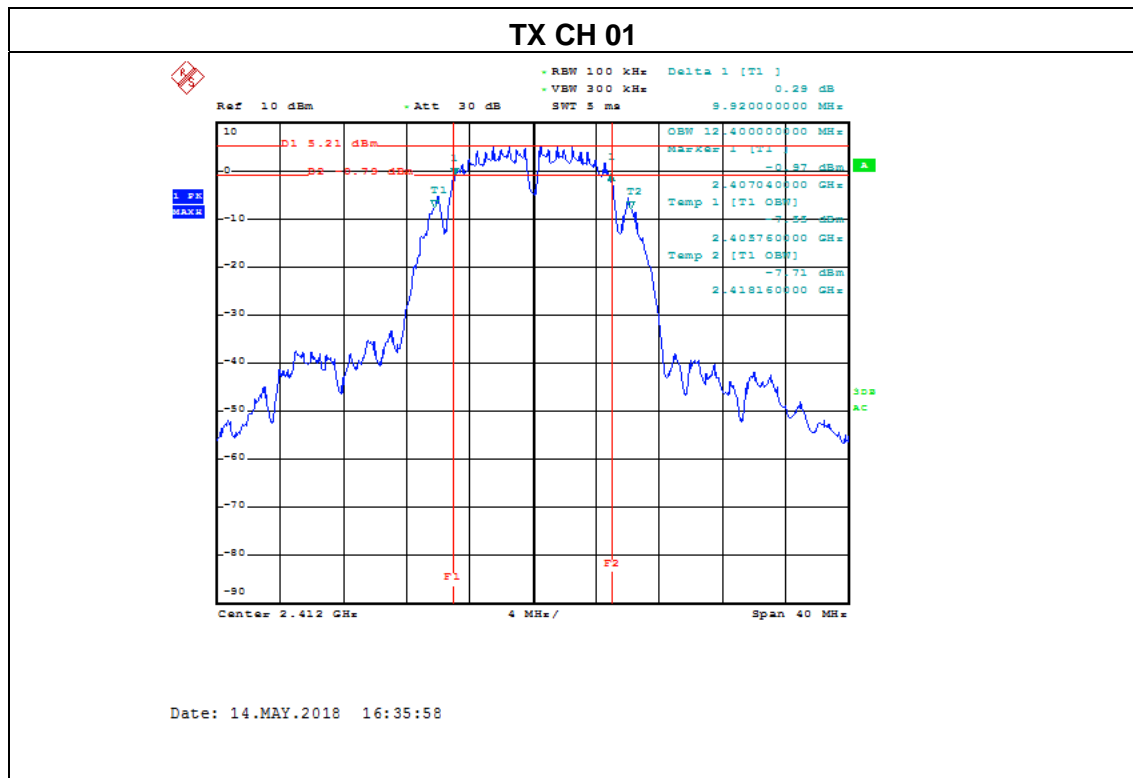

This test report is valid for the tested samples only. It cannot be reproduced except in full without prior written consent of Shenzhen Microtest Co., Ltd.

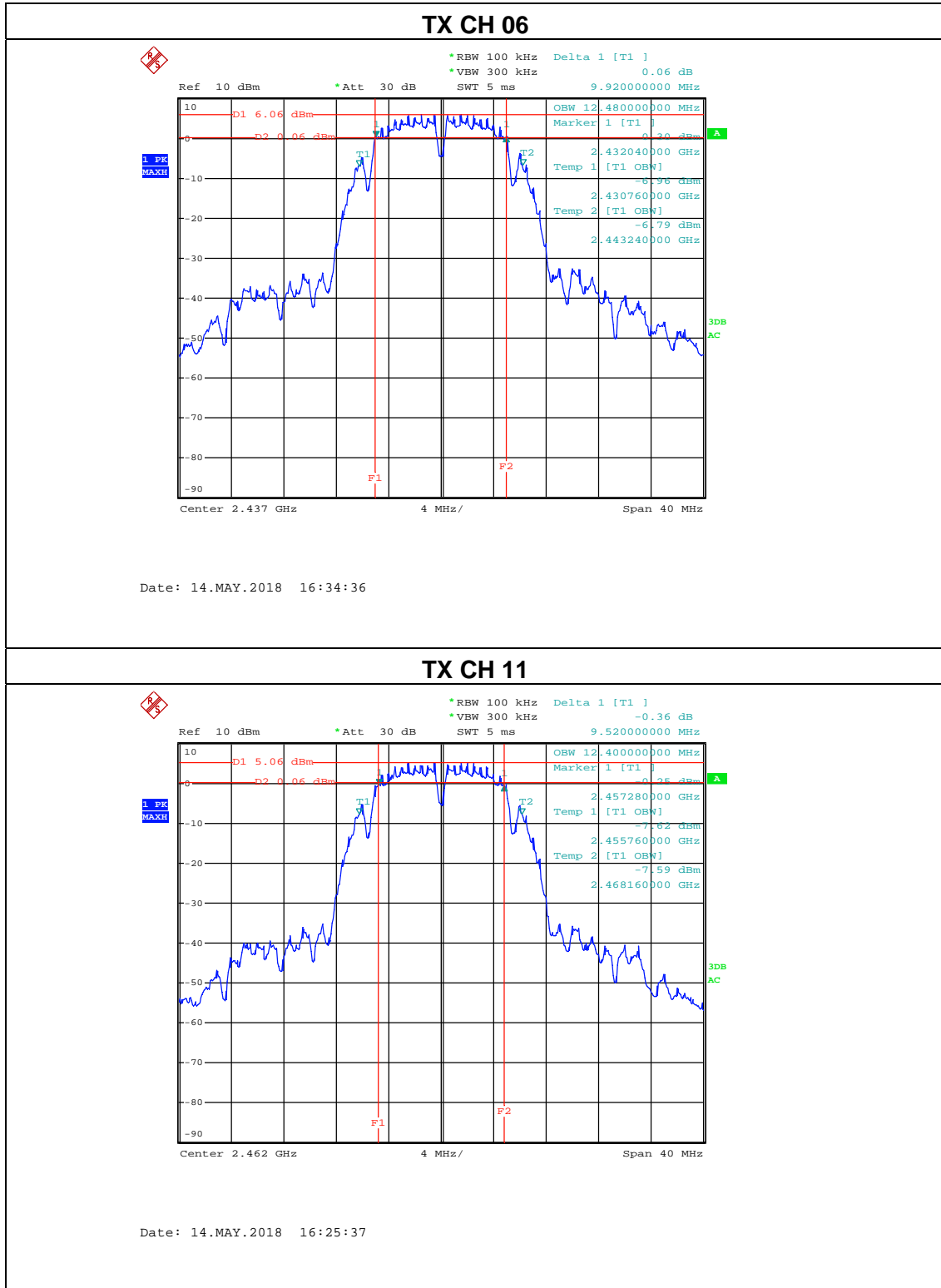

This test report is valid for the tested samples only. It cannot be reproduced except in full without prior written consent of Shenzhen Microtest Co., Ltd.

EUT :	IP Camera	Model Name :	704RA
Temperature :	25 °C	Relative Humidity :	60%
Pressure :	1012 hPa	Test Voltage :	DC 5V from AC Adapter 120V/60Hz
Test Mode :	TX g Mode /CH01, CH06, CH11		

Channel	Frequency (MHz)	6dB bandwidth (MHz)	Limit (kHz)	Result
Low	2412	16.32	500	Pass
Middle	2437	16.32	500	Pass
High	2462	16.32	500	Pass

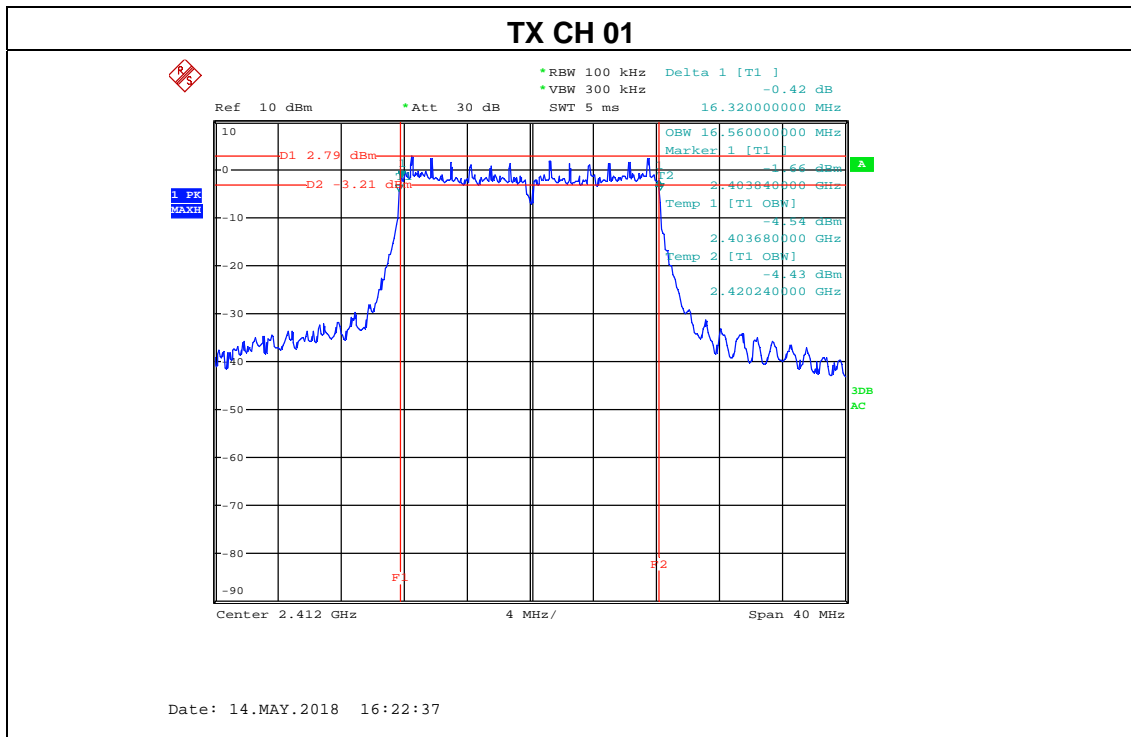

This test report is valid for the tested samples only. It cannot be reproduced except in full without prior written consent of Shenzhen Microtest Co., Ltd.

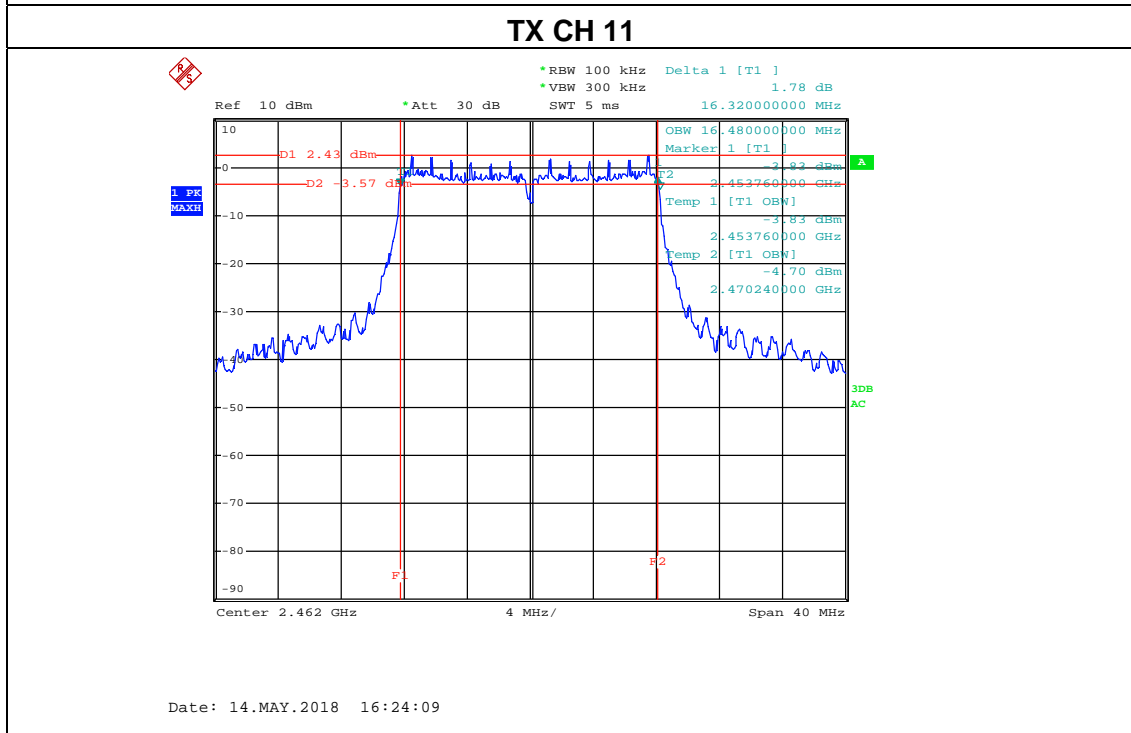
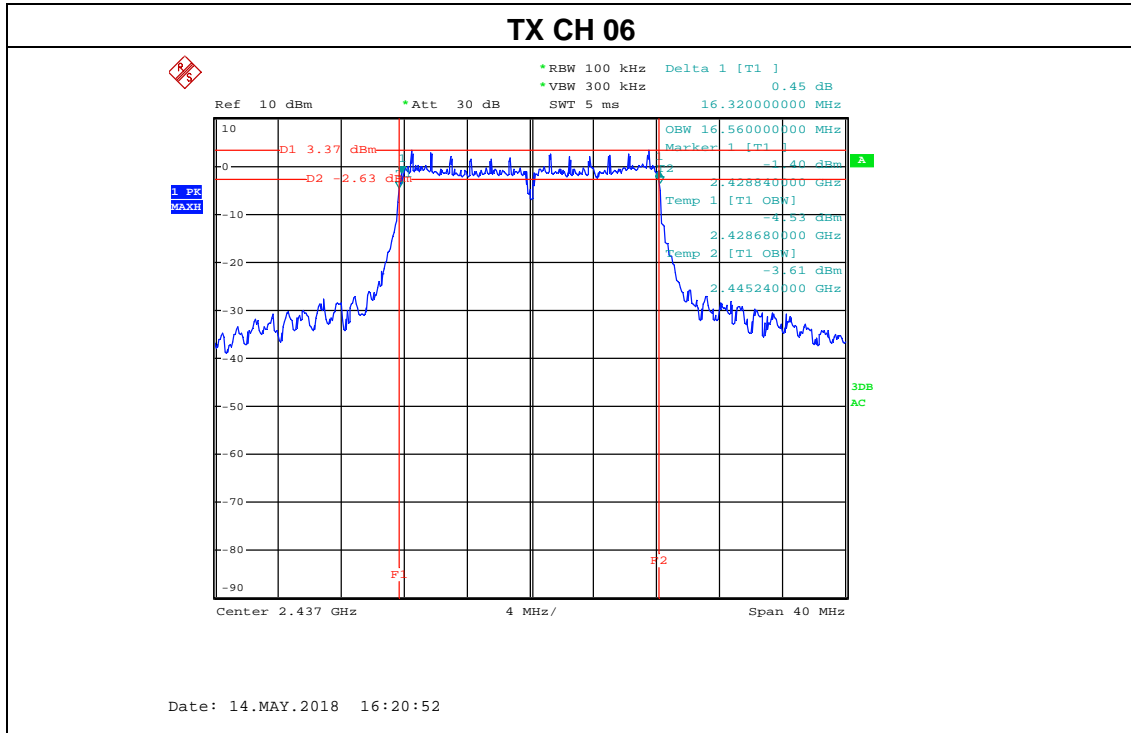

This test report is valid for the tested samples only. It cannot be reproduced except in full without prior written consent of Shenzhen Microtest Co., Ltd.

EUT :	IP Camera	Model Name :	704RA
Temperature :	25 °C	Relative Humidity :	60%
Pressure :	1012 hPa	Test Voltage :	DC 5V from AC Adapter 120V/60Hz
Test Mode :	TX n20 Mode /CH01, CH06, CH11		

Channel	Frequency (MHz)	6dB bandwidth (MHz)	Limit (kHz)	Result
Low	2412	17.20	500	Pass
Middle	2437	17.12	500	Pass
High	2462	17.04	500	Pass

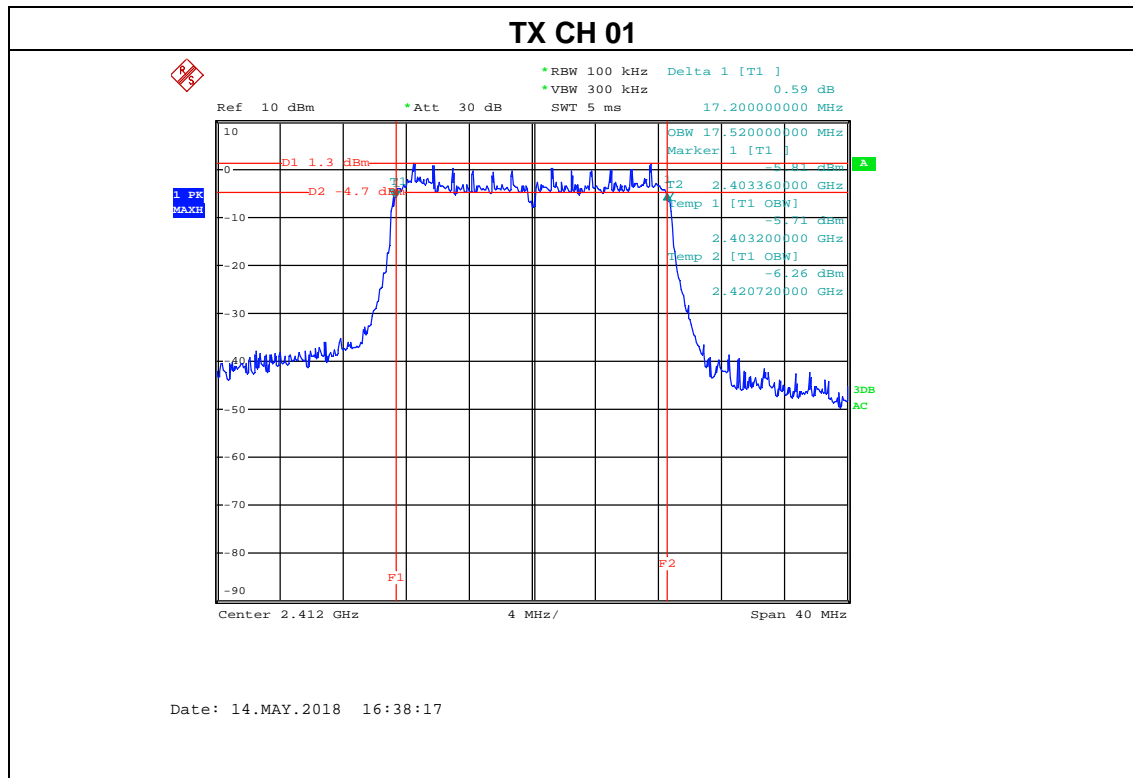

This test report is valid for the tested samples only. It cannot be reproduced except in full without prior written consent of Shenzhen Microtest Co., Ltd.

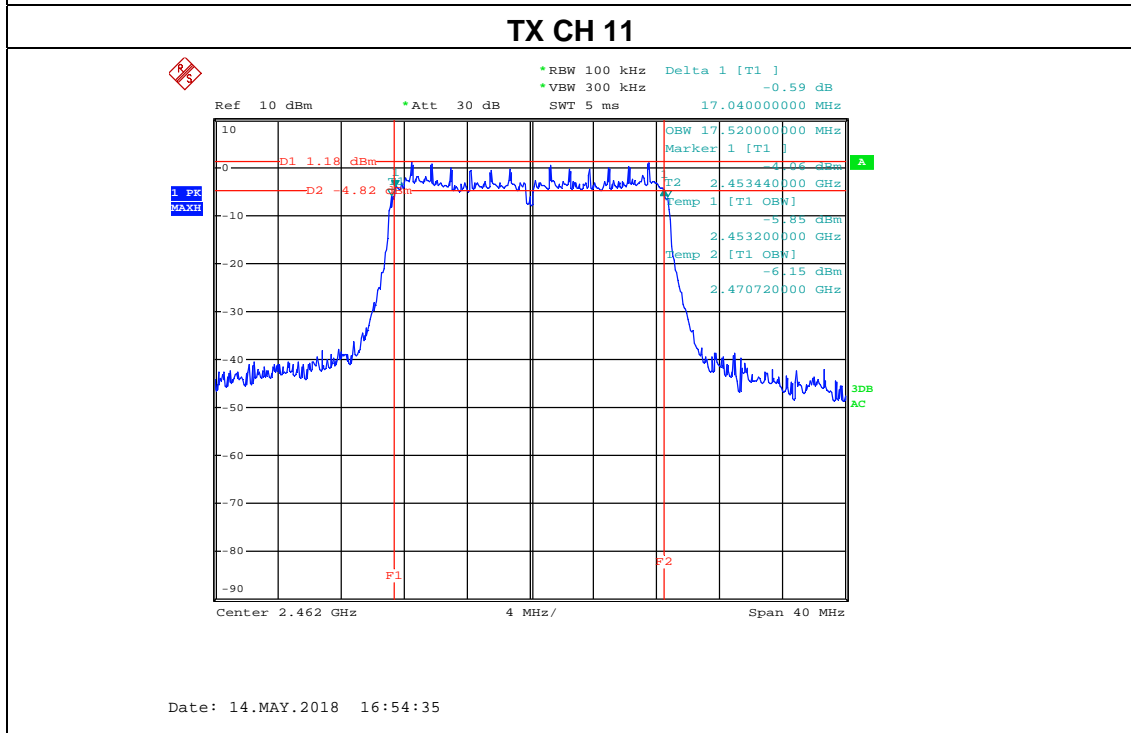
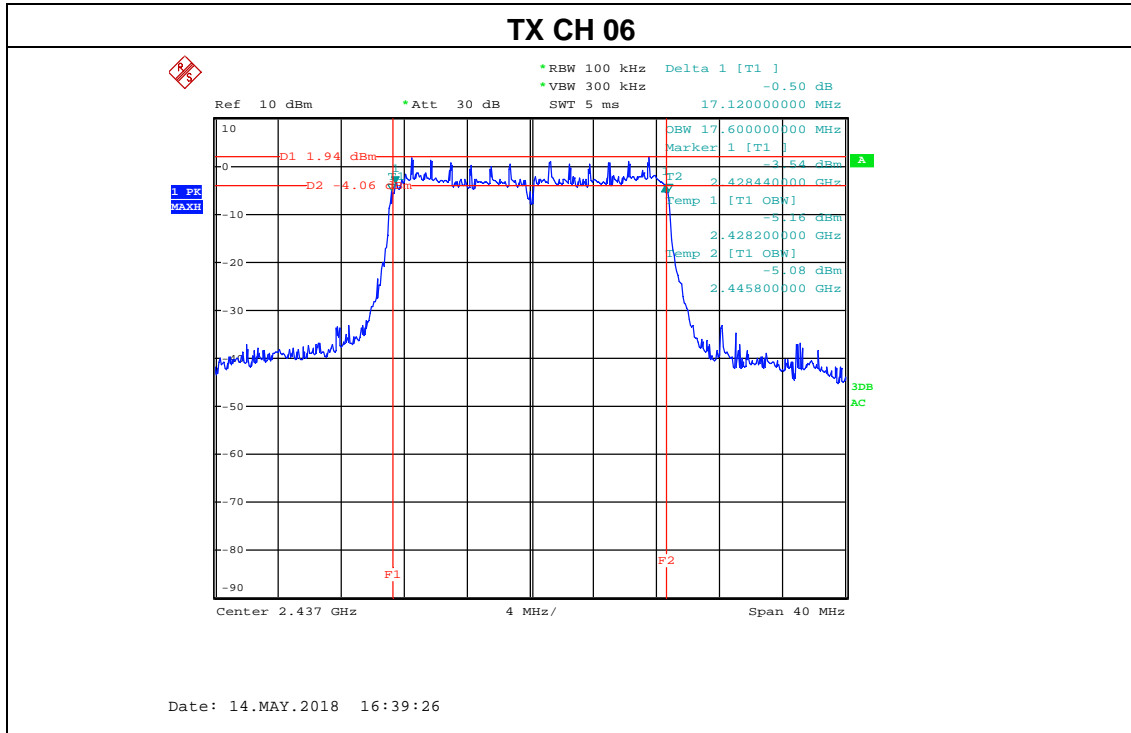

This test report is valid for the tested samples only. It cannot be reproduced except in full without prior written consent of Shenzhen Microtest Co., Ltd.

EUT :	IP Camera	Model Name :	704RA
Temperature :	25 °C	Relative Humidity :	60%
Pressure :	1012 hPa	Test Voltage :	DC 5V from AC Adapter 120V/60Hz
Test Mode :	TX n40 Mode /CH03, CH06, CH09		

Channel	Frequency (MHz)	6dB bandwidth (MHz)	Limit (kHz)	Result
Low	2422	35.52	500	Pass
Middle	2437	35.68	500	Pass
High	2452	35.20	500	Pass

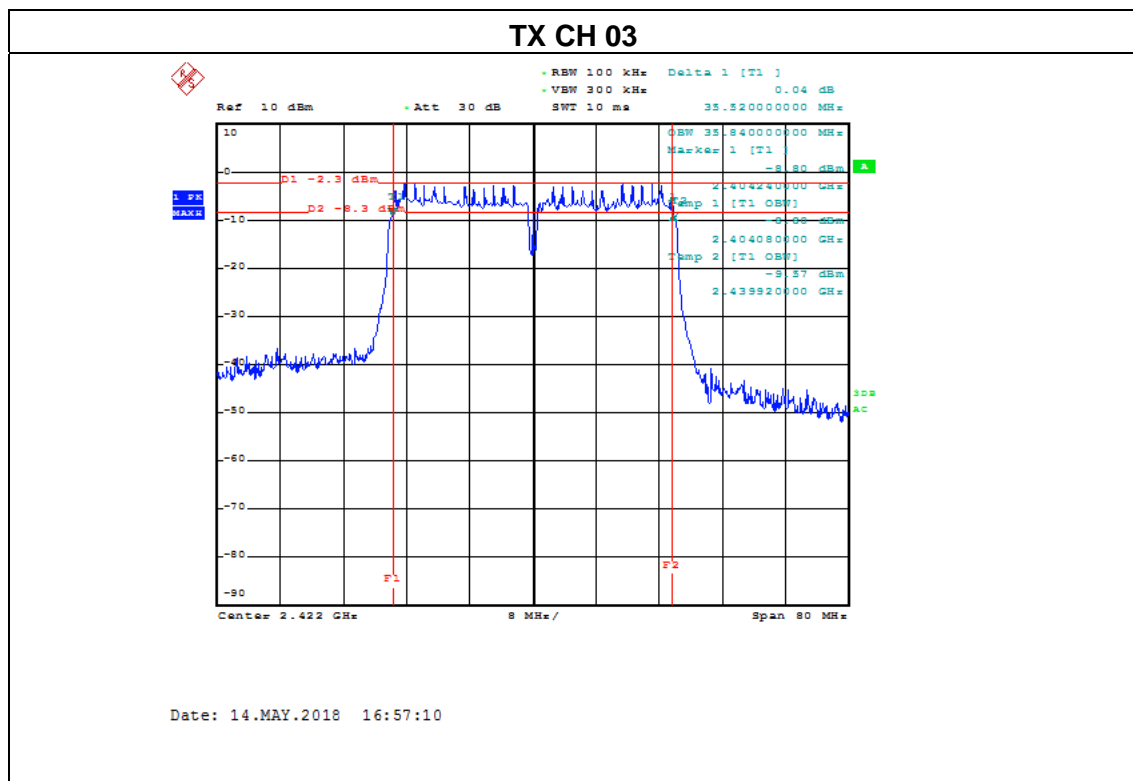

This test report is valid for the tested samples only. It cannot be reproduced except in full without prior written consent of Shenzhen Microtest Co., Ltd.

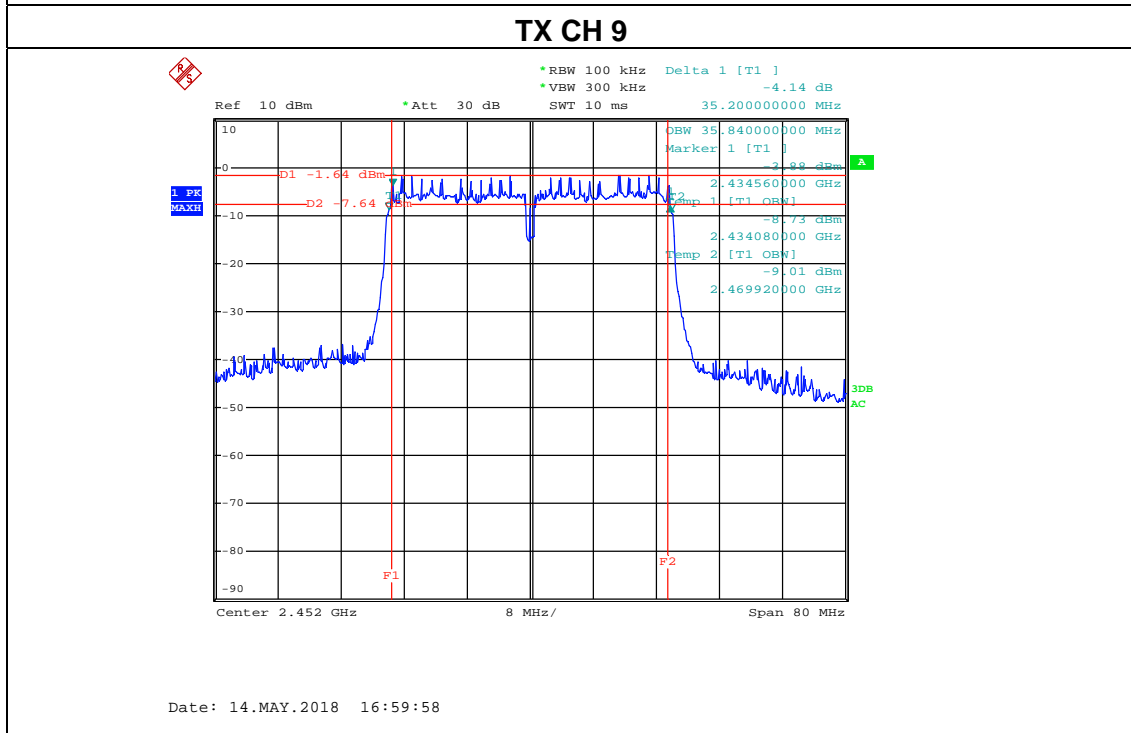
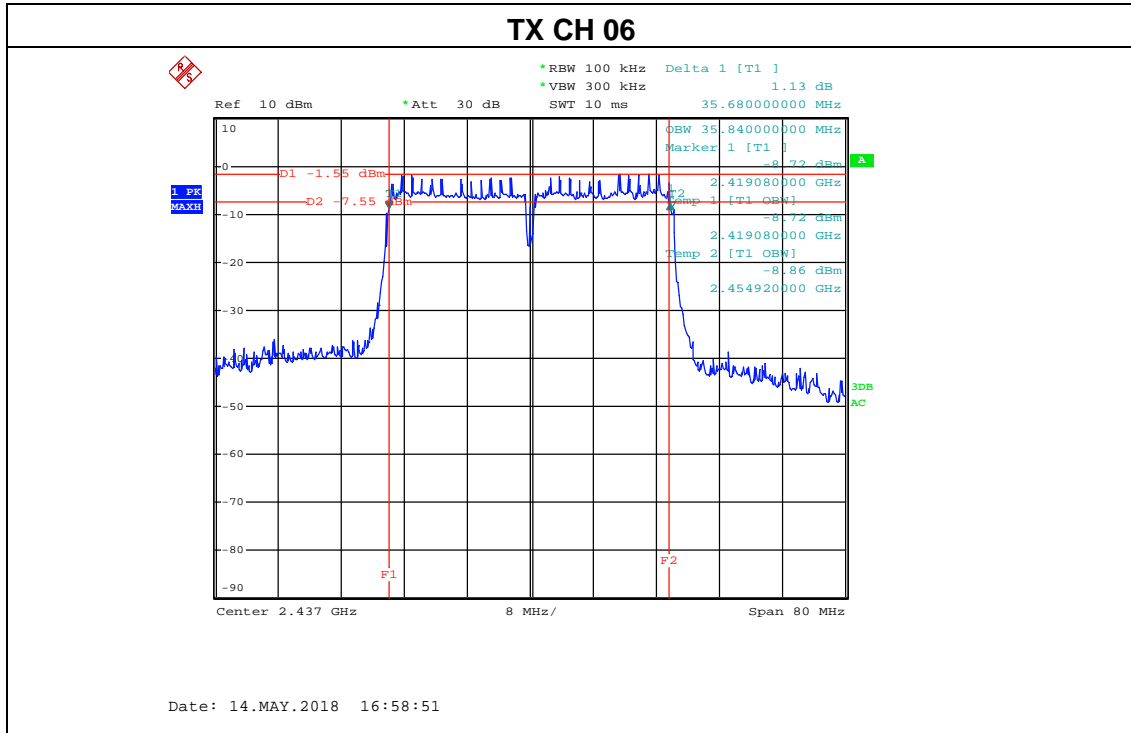

This test report is valid for the tested samples only. It cannot be reproduced except in full without prior written consent of Shenzhen Microtest Co., Ltd.

Photographs of the Test Setup

Radiated emission

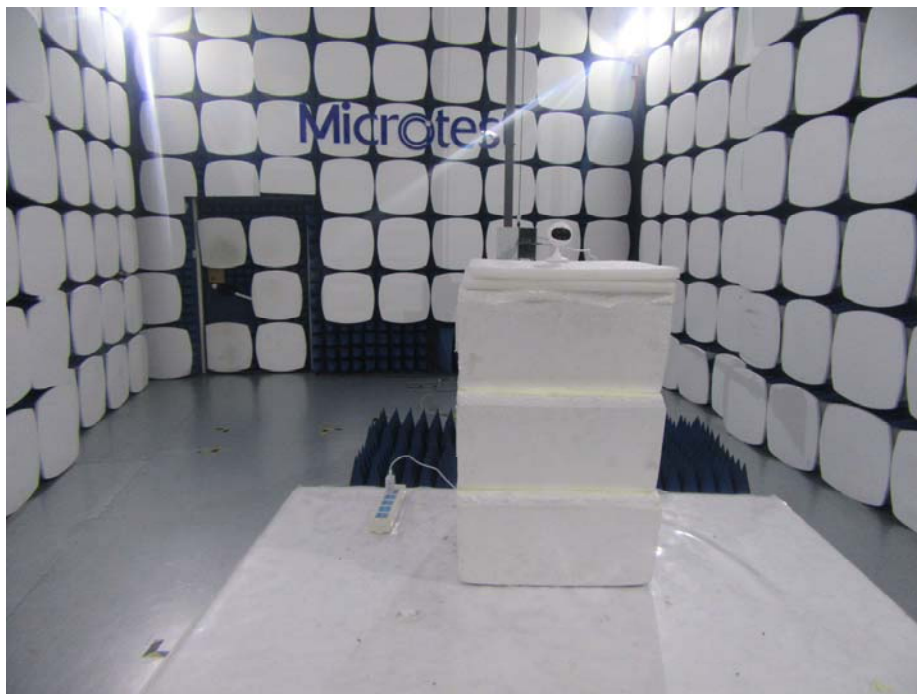
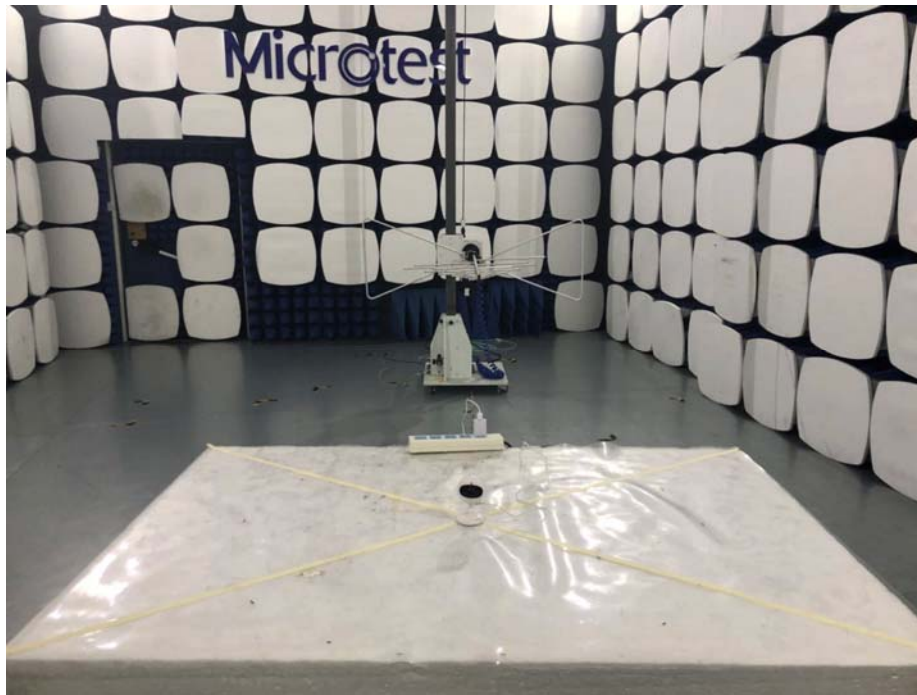

This test report is valid for the tested samples only. It cannot be reproduced except in full without prior written consent of Shenzhen Microtest Co., Ltd.

Conducted emission



----END OF REPORT----

This test report is valid for the tested samples only. It cannot be reproduced except in full without prior written consent of Shenzhen Microtest Co., Ltd.