

Table 14.1-14: SAR Values (LTE Band66 - Body)

Frequency		Mode	Test Position	Figure No.	Conducte d Power (dBm)	Max. tune-up Power (dBm)	Measure d SAR(10g) (W/kg)	Reported SAR(10g)(W/kg)	Measure d SAR(1g) (W/kg)	Reporte d SAR(1g) (W/kg)	Powe r Drift (dB)
Ch.	MHz										
Ambient Temperature: 22.9°C Liquid Temperature: 22.5°C											
132572	1770	1RB-High	Rear	Note1	23.93	24.7	0.235	0.28	0.398	0.48	-0.12
132572	1770	1RB-High	Right	Note2	23.93	24.7	0.307	0.37	0.531	0.63	-0.08
132572	1770	1RB-High	Top	Note1	23.93	24.7	0.246	0.29	0.452	0.54	0.04
132072	1720	50RB-High	Rear	Note1	22.38	23.7	0.191	0.26	0.348	0.47	0.17
132072	1720	50RB-High	Right	Note2	22.38	23.7	0.244	0.33	0.428	0.58	-0.03
132072	1720	50RB-High	Top	Note1	22.38	23.7	0.144	0.20	0.254	0.34	0.08
132572	1770	1RB-High	Rear	Fig.14	12.5	12.8	0.27	0.29	0.619	0.66	0.05
132572	1770	1RB-High	Right	/	12.5	12.8	0.179	0.19	0.446	0.48	-0.01
132572	1770	1RB-High	Top	/	12.5	12.8	0.168	0.18	0.47	0.50	0.07
132072	1720	50RB-Mid	Rear	/	12.23	12.8	0.263	0.30	0.614	0.70	-0.02
132072	1720	50RB-Mid	Right	/	12.23	12.8	0.13	0.15	0.29	0.33	0.08
132072	1720	50RB-Mid	Top	/	12.23	12.8	0.144	0.16	0.381	0.43	-0.13

Note: The distance between the EUT and the phantom bottom is 0mm.

Note1: The distance between the EUT and the phantom bottom is 19mm.

Note2: The distance between the EUT and the phantom bottom is 13mm

Note3: The LTE mode is QPSK_20MHz

14.2 SAR results for Standard procedure

There is zoom scan measurement to be added for the highest measured SAR in each exposure configuration/band.

Table 14.2-1: SAR Values (GSM 850 MHz Band - Body)

Frequency		Mode (number of timeslots)	Test Positi on	Figure No.	Conduct ed Power (dBm)	Max. tune- up Power (dBm)	Measured SAR(10g) (W/kg)	Reported SAR(10g) (W/kg)	Measure d SAR(1g) (W/kg)	Reporte d SAR(1g) (W/kg)	Power Drift (dB)
Ch.	MHz										
		Ambient Temperature: 22.9 °C		Liquid Temperature: 22.5 °C							
251	848.8	GPRS (1)	Rear	Fig.1	26.84	27	0.247	0.26	0.557	0.58	0.02

Note: The distance between the EUT and the phantom bottom is 0mm.

Table 14.2-2: SAR Values (GSM 1900 MHz Band - Body)

Frequency		Mode (number of timeslots)	Test Positi on	Figur e No.	Conduct ed Power (dBm)	Max. tune- up Power (dBm)	Measure d SAR(10g) (W/kg)	Reported SAR(10g) (W/kg)	Measure d SAR(1g) (W/kg)	Reporte d SAR(1g) (W/kg)	Power Drift (dB)
Ch.	MHz										
		Ambient Temperature: 22.9 °C		Liquid Temperature: 22.5 °C							
810	1909.8	GPRS (3)	Rear	Fig.2	17.21	17.8	0.246	0.28	0.575	0.66	0

Note: The distance between the EUT and the phantom bottom is 0mm.

Table 14.2-3: SAR Values (WCDMA 1900 MHz Band - Body)

Frequency		Test Position	Figure No.	Conducted Power (dBm)	Max. tune-up Power (dBm)	Measured SAR(10g) (W/kg)	Reported SAR(10g)(W/kg)	Measured SAR(1g) (W/kg)	Reported SAR(1g) (W/kg)	Power Drift (dB)
Ch.	MHz									
		Ambient Temperature: 22.9 °C		Liquid Temperature: 22.5 °C						
9262	1852.4	Right	Fig.3	23.7	24.5	0.362	0.44	0.607	0.73	-0.04

Note: The distance between the EUT and the phantom bottom is 13mm.

Table 14.2-4: SAR Values (WCDMA 1700 MHz Band - Body)

Frequency		Test Position	Figure No.	Conducte d Power (dBm)	Max. tune- up Power (dBm)	Measured SAR(10g) (W/kg)	Reported SAR(10g)(W/kg)	Measured SAR(1g) (W/kg)	Reported SAR(1g) (W/kg)	Power Drift (dB)
Ch.	MHz									
		Ambient Temperature: 22.9 °C		Liquid Temperature: 22.5 °C						
1312	1712.4	Rear	Fig.4	13.25	13.3	0.329	0.33	0.76	0.77	0

Note: The distance between the EUT and the phantom bottom is 0mm.

Table 14.2-5: SAR Values (WCDMA 850 MHz Band - Body)

Frequency		Test Position	Figure No.	Conducted Power (dBm)	Max. tune-up Power (dBm)	Measured SAR(10g) (W/kg)	Reported SAR(10g) (W/kg)	Measured SAR(1g) (W/kg)	Reported SAR(1g) (W/kg)	Power Drift (dB)	
Ch.	MHz										
		Ambient Temperature: 22.9 °C				Liquid Temperature: 22.5 °C					
4132	826.4	Rear	Fig.5	17.14	18	0.236	0.29	0.573	0.70	0.02	

Note: The distance between the EUT and the phantom bottom is 0mm.

Table 14.2-6: SAR Values (LTE Band2 - Body)

Frequency		Mode	Test Position	Figure No.	Conducted Power (dBm)	Max. tune-up Power (dBm)	Measured SAR(10g) (W/kg)	Reported SAR(10g) (W/kg)	Measured SAR(1g) (W/kg)	Reported SAR(1g) (W/kg)	Power Drift (dB)
Ch.	MHz										
		Ambient Temperature: 22.9 °C				Liquid Temperature: 22.5 °C					
19100	1900	50RB-Mid	Top	Fig.6	22.68	23.5	0.467	0.56	0.841	1.02	0.01

Note1: The distance between the EUT and the phantom bottom is 19mm.

Note2: The LTE mode is QPSK_20MHz.

Table 14.2-7: SAR Values (LTE Band5 - Body)

Frequency		Mode	Test Position	Figure No.	Conducted Power (dBm)	Max. tune-up Power (dBm)	Measured SAR(10g) (W/kg)	Reported SAR(10g) (W/kg)	Measured SAR(1g) (W/kg)	Reported SAR(1g) (W/kg)	Power Drift (dB)
Ch.	MHz										
		Ambient Temperature: 22.9 °C				Liquid Temperature: 22.5 °C					
20450	829	1RB-Low	Rear	Fig.7	16.49	17.8	0.201	0.27	0.513	0.69	0.11

Note1: The distance between the EUT and the phantom bottom is 0mm.

Note2: The LTE mode is QPSK_10MHz.

Table 14.2-8: SAR Values (LTE Band7 - Body)

Frequency		Mode	Test Position	Figure No.	Conducted Power (dBm)	Max. tune-up Power (dBm)	Measured SAR(10g) (W/kg)	Reported SAR(10g) (W/kg)	Measured SAR(1g) (W/kg)	Reported SAR(1g) (W/kg)	Power Drift (dB)
Ch.	MHz										
		Ambient Temperature: 22.9 °C				Liquid Temperature: 22.5 °C					
20850	2510	1RB-Low	Rear	Fig.8	10.98	11.7	0.211	0.25	0.601	0.71	0.08

Note1: The distance between the EUT and the phantom bottom is 0mm.

Note2: The LTE mode is QPSK_20MHz.

Table 14.2-9: SAR Values (LTE Band12 - Body)

Frequency		Mode	Test Position	Figure No.	Conducted Power (dBm)	Max. tune-up Power (dBm)	Measured SAR(10g) (W/kg)	Reported SAR(10g) (W/kg)	Measured SAR(1g) (W/kg)	Reported SAR(1g) (W/kg)	Power Drift (dB)
Ch.	MHz										
		Ambient Temperature: 22.9°C		Liquid Temperature: 22.5°C							
23060	704	1RB-Low	Rear	Fig.9	16.71	17.1	0.27	0.30	0.644	0.70	-0.01

Note1: The distance between the EUT and the phantom bottom is 0mm.

Note2: The LTE mode is QPSK_10MHz.

Table 14.2-10: SAR Values (LTE Band18 - Body)

Frequency		Mode	Test Position	Figure No.	Conducted Power (dBm)	Max. tune-up Power (dBm)	Measured SAR(10g) (W/kg)	Reported SAR(10g) (W/kg)	Measured SAR(1g) (W/kg)	Reported SAR(1g) (W/kg)	Power Drift (dB)
Ch.	MHz										
		Ambient Temperature: 22.9°C		Liquid Temperature: 22.5°C							
23925	822.5	36RB-Low	Rear	Fig.10	17.01	17.6	0.255	0.29	0.616	0.71	0.15

Note1: The distance between the EUT and the phantom bottom is 0mm.

Note2: The LTE mode is QPSK_15MHz

Table 14.2-11: SAR Values (LTE Band19 - Body)

Frequency		Mode	Test Position	Figure No.	Conducted Power (dBm)	Max. tune-up Power (dBm)	Measured SAR(10g) (W/kg)	Reported SAR(10g) (W/kg)	Measured SAR(1g) (W/kg)	Reported SAR(1g) (W/kg)	Power Drift (dB)
Ch.	MHz										
		Ambient Temperature: 22.9°C		Liquid Temperature: 22.5°C							
24075	837.5	1RB-Low	Rear	Fig.11	17.09	17.2	0.31	0.32	0.727	0.75	0.19

Note1: The distance between the EUT and the phantom bottom is 0mm.

Note2: The LTE mode is QPSK_15MHz

Table 14.2-12: SAR Values (LTE Band28 - Body)

Frequency		Mode	Test Position	Figure No.	Conducted Power (dBm)	Max. tune-up Power (dBm)	Measured SAR(10g) (W/kg)	Reported SAR(10g) (W/kg)	Measured SAR(1g) (W/kg)	Reported SAR(1g) (W/kg)	Power Drift (dB)
Ch.	MHz										
		Ambient Temperature: 22.9°C		Liquid Temperature: 22.5°C							
27310	713	1RB-Low	Rear	Fig.12	15.8	16.6	0.23	0.28	0.53	0.64	-0.11

Note1: The distance between the EUT and the phantom bottom is 0mm.

Note2: The LTE mode is QPSK_20MHz

Table 14.2-13: SAR Values (LTE Band38 - Body)

Frequency		Mode	Test Position	Figure No.	Conducted Power (dBm)	Max. tune-up Power (dBm)	Measured SAR(10g) (W/kg)	Reported SAR(10g) (W/kg)	Measured SAR(1g) (W/kg)	Reported SAR(1g) (W/kg)	Power Drift (dB)
Ch.	MHz										
		Ambient Temperature: 22.9 °C		Liquid Temperature: 22.5 °C							
27310	713	50RB-High	Rear	Fig.13	12.52	13.1	0.221	0.25	0.651	0.74	0

Note1: The distance between the EUT and the phantom bottom is 0mm.

Note2: The LTE mode is QPSK_20MHz

Table 14.2-14: SAR Values (LTE Band66 - Body)

Frequency		Mode	Test Position	Figure No.	Conducted Power (dBm)	Max. tune-up Power (dBm)	Measured SAR(10g) (W/kg)	Reported SAR(10g) (W/kg)	Measured SAR(1g) (W/kg)	Reported SAR(1g) (W/kg)	Power Drift (dB)
Ch.	MHz										
		Ambient Temperature: 22.9 °C		Liquid Temperature: 22.5 °C							
132572	1770	1RB-High	Rear	Fig.14	12.5	12.8	0.27	0.29	0.619	0.66	0.05

Note1: The distance between the EUT and the phantom bottom is 0mm.

Note2: The LTE mode is QPSK_20MHz

14.3 WLAN Evaluation for 2.4G

According to the KDB248227 D01, SAR is measured for 2.4GHz 802.11b DSSS using the initial test position procedure.

Body Evaluation

Table 14.3-1: SAR Values (WLAN - Body)– 802.11b (Fast SAR)

Frequency		Test Position	Figure No./ Note	Conducted Power (dBm)	Max. tune-up Power (dBm)	Measured SAR(10g) (W/kg)	Reported SAR(10g)(W/kg)	Measured SAR(1g) (W/kg)	Reported SAR(1g) (W/kg)	Power Drift (dB)
MHz	Ch.									
		Ambient Temperature: 22.9 °C				Liquid Temperature: 22.5 °C				
11	2462	Rear	Note1	18.52	19.5	0.109	0.14	0.213	0.27	0.08
11	2462	Top	Note1	18.52	19.5	0.179	0.22	0.357	0.45	-0.12
6	2437	Rear	Note2	13.59	14	0.21	0.23	0.595	0.66	-0.07
6	2437	Top	Note2	13.59	14	0.159	0.17	0.423	0.46	-0.01

Note1: The distance between the EUT and the phantom bottom is 18mm.

Note2: The distance between the EUT and the phantom bottom is 0mm

As shown above table, the initial test position for body is “Rear 0mm”. So the body SAR of WLAN is presented as below:

Table 14.3-2: SAR Values (WLAN - Body)– 802.11b (Full SAR)

Frequency		Test Position	Figure No./ Note	Conducted Power (dBm)	Max. tune-up Power (dBm)	Measured SAR(10g) (W/kg)	Reported SAR(10g) (W/kg)	Measured SAR(1g) (W/kg)	Reported SAR(1g) (W/kg)	Power Drift (dB)
MHz	Ch.									
		Ambient Temperature: 22.9 °C				Liquid Temperature: 22.5 °C				
6	2437	Rear	Fig.15	13.59	14	0.209	0.23	0.596	0.66	-0.07

Note: The distance between the EUT and the phantom bottom is 0mm.

Note1: When the reported SAR of the initial test position is > 0.4 W/kg, SAR is repeated for the 802.11 transmission mode configuration tested in the initial test position using subsequent highest estimated 1-g SAR conditions determined by area scans, on the highest maximum output power channel, until the reported SAR is ≤ 0.8 W/kg.

Note2: For all positions/configurations tested using the initial test position and subsequent test positions, when the reported SAR is > 0.8 W/kg, SAR is measured for these test positions/configurations on the subsequent next highest measured output power channel until the reported SAR is ≤ 1.2 W/kg or all required channels are tested.

According to the KDB248227 D01, The reported SAR must be scaled to 100% transmission duty factor to determine compliance at the maximum tune-up tolerance limit. The scaled reported SAR is presented as below.

Table 14.3-3: SAR Values (WLAN - Body) – 802.11b (Scaled Reported SAR)

Frequency		Test Position	Actual duty factor	maximum duty factor	Reported SAR (1g)(W/kg)	Scaled reported SAR (1g)(W/kg)
MHz	Ch.					
2437	6	Rear	99.2%	100%	0.66	0.67

SAR is not required for OFDM because the 802.11b adjusted SAR ≤ 1.2 W/kg.

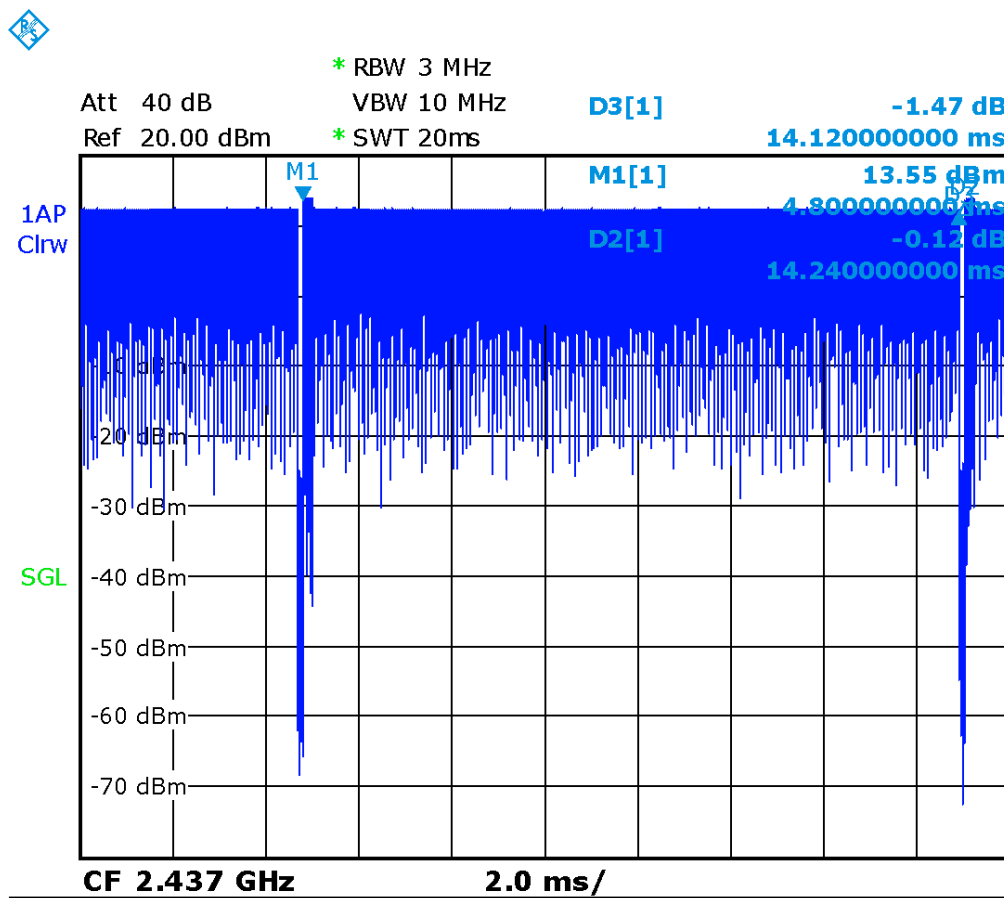

Picture 14.1

Duty factor plot

14.4 WLAN Evaluation For 5G

Table 14.4-1: OFDM mode specified maximum output power of WLAN antenna

802.11 mode	a	g	n		ac			
Ch. BW(MHz)	20	20	20	40	20	40	80	160
U-NII-1	X		X	X	X	X	X	
U-NII-2A	X		X	X	X	X	X	
U-NII-2C	X		X	X	X	X	X	
U-NII-3	X		X	X	X	X	X	
§ 15.247 (5.8 GHz)								

X: maximum(conducted) output power(mW), including tolerance, specified for production units

Table 14.4-2: Maximum output power specified of WLAN antenna – Body-Normal power

802.11 mode	a	g	n		ac			
Ch. BW(MHz)	20	20	20	40	20	40	80	160
U-NII-1	79		63	50	63	56	45	
U-NII-2A	79		63	50	63	56	45	
U-NII-2C	79		63	50	63	56	45	
U-NII-3	79		63	50	63	56	45	
§ 15.247 (5.8 GHz)								

- The maximum output power specified for production units is the same for all channels, modulations and data rates in each channel bandwidth configuration of the 802.11a/g/n/ac modes.
- The **blue highlighted** cells represent highest output configurations in each standalone or aggregated frequency band, with tune-up tolerance included.

Table 14.4-3: Maximum output power specified of WLAN antenna – Body-Low power

802.11 mode	a	g	n		ac			
Ch. BW(MHz)	20	20	20	40	20	40	80	160
U-NII-1	6		6	6	6	6	6	
U-NII-2A	6		6	6	6	6	6	
U-NII-2C	6		6	6	6	6	6	
U-NII-3	6		6	6	6	6	6	
§ 15.247 (5.8 GHz)								

- The maximum output power specified for production units is the same for all channels, modulations and data rates in each channel bandwidth configuration of the 802.11a/g/n/ac modes.
- The **blue highlighted** cells represent highest output configurations in each standalone or aggregated frequency band, with tune-up tolerance included.

Table 14.4-4: Maximum output power measured of WLAN antenna, for the applicable OFDM configurations according to the default power measurement procedures for selection initial test configurations – Body-Normal power

802.11 mode	a		n		ac		
	20	20	40	20	40	80	
U-NII-1	36/40/44/48 69/72/72/65	36/40/44/48 Lower power	38/46 Lower power	36/40/44/48 Lower power	38/46 Lower power	42 Lower power	
U-NII-2A	52/56/60/64 63/58/55/57	52/56/60/64 Lower power	54/62 Lower power	52/56/60/64 Lower power	54/62 Lower power	58 Lower power	
U-NII-2C	100/104/108/112/116/120/124/128/132/136/140/144/70/65/60/58/61/58/68/73/70/61/45/60	100/104/108/12/116/120/124/4/128/132/136/140/144 Lower power	102/110/118/126/134/142 Lower power	100/104/108/112/116/120/124/128/132/136/140/144 Lower power	102/110/118/126/134/142 Lower power	106/122/138 Lower power	
U-NII-3	149/153/157/161/165 72/77/72/66/62	149/153/157/161/165 Lower power	151/159 Lower power	149/153/157/161/165 Lower power	151/159 Lower power	155 Lower power	

- The **bold numbers** is the maximum output measured power (mW).
- Channels with measured maximum power within 0.25dB are considered to have the same measured output.
- Channels selected for initial test configuration are **highlighted in yellow**.

Table 14.4-5: Maximum output power measured of WLAN antenna, for the applicable OFDM configurations according to the default power measurement procedures for selection initial test configurations – Body-Low power

802.11 mode	a		n		ac		
	20	20	40	20	40	80	
U-NII-1	36/40/44/48 Lower power	36/40/44/48 Lower power	38/46 Lower power	36/40/44/48 Lower power	38/46 Lower power	42 5	
U-NII-2A	52/56/60/64 Lower power	52/56/60/64 Lower power	54/62 Lower power	52/56/60/64 Lower power	54/62 Lower power	58 5	
U-NII-2C	100/104/108/112/116/120/124/128/132/136/140/144/70/65/60/58/61/58/68/73/70/61/45/60 Lower power	100/104/108/12/116/120/124/4/128/132/136/140/144 Lower power	102/110/118/126/134/142 Lower power	100/104/108/112/116/120/124/128/132/136/140/144 Lower power	102/110/118/126/134/142 Lower power	106/122/138 4/5/5	
U-NII-3	149/153/157/161/165 Lower power	149/153/157/161/165 Lower power	151/159 Lower power	149/153/157/161/165 Lower power	151/159 Lower power	155 5	

- The **bold numbers** is the maximum output measured power (mW).
- Channels with measured maximum power within 0.25dB are considered to have the same measured output.
- Channels selected for initial test configuration are **highlighted in yellow**.

Table 14.4-6: Reported SAR of initial test configuration for Body-18mm

802.11 mode	a	n		ac		
		20	40	20	40	80
U-NII-1	36/40/44/48 UNII-2A exclusion applied	36/40/44/4 8	38/46	36/40/44/48	38/46	42
U-NII-2A	52 /56/60/64 0.51	52/56/60/6 4	54/62	52/56/60/64	54/62	58
U-NII-2C	100/104/108/112/116/120/ 124/ 128 /132/136/140/144 0.38	100/104/10 8/112/116/ 120/124/12 8/132/136/ 140/144	102/110/118/1 26/134/142	100/104/108/11 2/116/120/124/ 128/132/136/14 0/144	102/110/118/1 26/134/142	106/122/ 138
U-NII-3	149/ 153 /157/161/165 0.46	149/153/15 7/161/165	151/159	149/153/157/16 1/165	151/159	155
Highest measured output power channel tested initially are in yellow highlight .						

Table 14.4-7: Reported SAR of initial test configuration for Body-18mm

802.11 mode	a	n		ac		
		20	40	20	40	80
U-NII-1	36/40/44/48	36/40/44/48	38/46	36/40/44/48	38/46	42 UNII-2A exclusion applied
U-NII-2A	52/56/60/64	52/56/60/64	54/62	52/56/60/64	54/62	58 0.39
U-NII-2C	100/104/108/112/116/120/ 124/128/132/136/140/144	100/104/108 /112/116/120 /124/128/13 2/136/140/1 44	102/110/118/ 126/134/142	100/104/108 /112/116/120 /124/128/13 2/136/140/1 44	102/110/11 8/126/134/ 142	106/ 122 /138 0.75
U-NII-3	149/153/157/161/165	149/153/157 /161/165	151/159	149/153/157 /161/165	151/159	155 0.62
Highest measured output power channel tested initially are in yellow highlight .						

Table 14.4-7: SAR Values (WLAN 5G - Body)

Frequency		Test Position	Figure No.	Conducted Power (dBm)	Max. tune-up Power (dBm)	Measured SAR(10g) (W/kg)	Reported SAR(10g) (W/kg)	Measured SAR(1g) (W/kg)	Reported SAR(1g) (W/kg)	Power Drift (dB)
Ch.	MHz									
52	5260	Rear	Note1	17.98	19	0.11	0.14	0.288	0.36	0.14
52	5260	Top	Note1	17.98	19	0.161	0.20	0.4	0.51	-0.04
128	5640	Rear	Note1	18.63	19	0.124	0.14	0.318	0.35	0.12
128	5640	Top	Note1	18.63	19	0.144	0.16	0.352	0.38	-0.06
153	5765	Rear	Note1	18.87	19	0.145	0.15	0.372	0.38	0.14
153	5765	Top	Note1	18.87	19	0.182	0.19	0.448	0.46	0.03
58	5290	Rear	/	7.21	7.5	0.068	0.07	0.302	0.32	-0.06
58	5290	Top	/	7.21	7.5	0.064	0.07	0.363	0.39	0.12
122	5610	Rear	Fig.16	7.06	7.5	0.137	0.15	0.679	0.75	-0.09
122	5610	Top	/	7.06	7.5	0.0554	0.06	0.291	0.32	-0.03
155	5775	Rear	/	7.32	7.5	0.117	0.12	0.594	0.62	-0.07
155	5775	Top	/	7.32	7.5	0.077	0.08	0.349	0.36	0.08

Note: The distance between the EUT and the phantom bottom is 0mm.

Note1: The distance between the EUT and the phantom bottom is 18mm.

According to the KDB248227 D01, The reported SAR must be scaled to 100% transmission duty factor to determine compliance at the maximum tune-up tolerance limit. The scaled reported SAR is presented as below.

Table 14.4-8 SAR Values (WLAN 5G - Body) (Scaled Reported SAR)

Frequency		Test Position	D (mm)	Actual duty factor	maximum duty factor	Reported SAR (1g) (W/kg)	Scaled reported SAR (1g) (W/kg)
Ch.	MHz						
122	5610	Rear	0	98%	100%	0.75	0.77

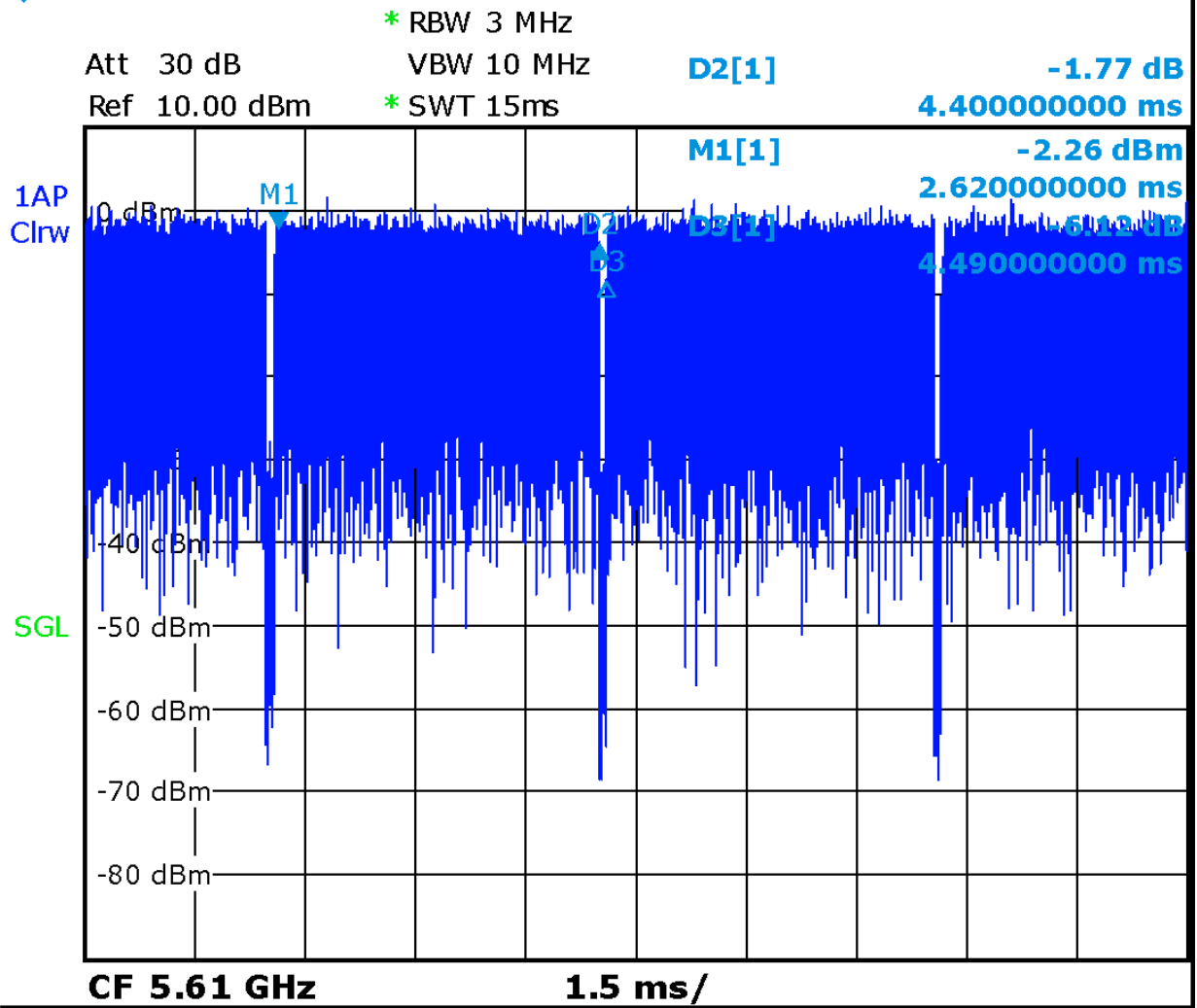

Picture 14.2 The plot of duty factor

15 SAR Measurement Variability

SAR measurement variability must be assessed for each frequency band, which is determined by the SAR probe calibration point and tissue-equivalent medium used for the device measurements. When both head and body tissue-equivalent media are required for SAR measurements in a frequency band, the variability measurement procedures should be applied to the tissue medium with the highest measured SAR, using the highest measured SAR configuration for that tissue-equivalent medium.

The following procedures are applied to determine if repeated measurements are required.

- 1) Repeated measurement is not required when the original highest measured SAR is < 0.80 W/kg; steps 2) through 4) do not apply.
- 2) When the original highest measured SAR is ≥ 0.80 W/kg, repeat that measurement once.
- 3) Perform a second repeated measurement only if the ratio of largest to smallest SAR for the original and first repeated measurements is > 1.20 or when the original or repeated measurement is ≥ 1.45 W/kg (~ 10% from the 1-g SAR limit).
- 4) Perform a third repeated measurement only if the original, first or second repeated measurement is ≥ 1.5 W/kg and the ratio of largest to smallest SAR for the original, first and second repeated measurements is > 1.20 .

Mode	CH	Freq	Test Poosition	Original SAR (W/kg)	First Repeated SAR(W/kg)	The Ratio
LTE Band2	18700	1860 MHz	Top 0mm	0.917	0.908	1.01

16 Measurement Uncertainty

16.1 Measurement Uncertainty for Normal SAR Tests (300MHz~3GHz)

No.	Error Description	Type	Uncertainty value	Probably Distribution	Div.	(Ci) 1g	(Ci) 10g	Std. Unc. (1g)	Std. Unc. (10g)	Degree of freedom
Measurement system										
1	Probe calibration	B	6.0	N	1	1	1	6.0	6.0	∞
2	Isotropy	B	4.7	R	$\sqrt{3}$	0.7	0.7	1.9	1.9	∞
3	Boundary effect	B	1.0	R	$\sqrt{3}$	1	1	0.6	0.6	∞
4	Linearity	B	4.7	R	$\sqrt{3}$	1	1	2.7	2.7	∞
5	Detection limit	B	1.0	N	1	1	1	0.6	0.6	∞
6	Readout electronics	B	0.3	R	$\sqrt{3}$	1	1	0.3	0.3	∞
7	Response time	B	0.8	R	$\sqrt{3}$	1	1	0.5	0.5	∞
8	Integration time	B	2.6	R	$\sqrt{3}$	1	1	1.5	1.5	∞
9	RF ambient conditions-noise	B	0	R	$\sqrt{3}$	1	1	0	0	∞
10	RF ambient conditions-reflection	B	0	R	$\sqrt{3}$	1	1	0	0	∞
11	Probe positioned mech. restrictions	B	0.4	R	$\sqrt{3}$	1	1	0.2	0.2	∞
12	Probe positioning with respect to phantom shell	B	2.9	R	$\sqrt{3}$	1	1	1.7	1.7	∞
13	Post-processing	B	1.0	R	$\sqrt{3}$	1	1	0.6	0.6	∞
Test sample related										
14	Test sample positioning	A	3.3	N	1	1	1	3.3	3.3	71
15	Device holder uncertainty	A	3.4	N	1	1	1	3.4	3.4	5
16	Drift of output power	B	5.0	R	$\sqrt{3}$	1	1	2.9	2.9	∞
Phantom and set-up										
17	Phantom uncertainty	B	4.0	R	$\sqrt{3}$	1	1	2.3	2.3	∞
18	Liquid conductivity (target)	B	5.0	R	$\sqrt{3}$	0.64	0.43	1.8	1.2	∞
19	Liquid conductivity (meas.)	A	2.06	N	1	0.64	0.43	1.32	0.89	43
20	Liquid permittivity (target)	B	5.0	R	$\sqrt{3}$	0.6	0.49	1.7	1.4	∞
21	Liquid permittivity (meas.)	A	1.6	N	1	0.6	0.49	1.0	0.8	521

Combined standard uncertainty	$u_c = \sqrt{\sum_{i=1}^{21} c_i^2 u_i^2}$							9.55	9.43	257
Expanded uncertainty (confidence interval of 95 %)	$u_e = 2u_c$							19.1	18.9	

16.2 Measurement Uncertainty for Normal SAR Tests (3~6GHz)

No.	Error Description	Type	Uncertainty value	Probably Distribution	Div.	(Ci) 1g	(Ci) 10g	Std. Unc. (1g)	Std. Unc. (10g)	Degree of freedom
Measurement system										
1	Probe calibration	B	6.55	N	1	1	1	6.55	6.55	∞
2	Isotropy	B	4.7	R	$\sqrt{3}$	0.7	0.7	1.9	1.9	∞
3	Boundary effect	B	2.0	R	$\sqrt{3}$	1	1	1.2	1.2	∞
4	Linearity	B	4.7	R	$\sqrt{3}$	1	1	2.7	2.7	∞
5	Detection limit	B	1.0	R	$\sqrt{3}$	1	1	0.6	0.6	∞
6	Readout electronics	B	0.3	R	$\sqrt{3}$	1	1	0.3	0.3	∞
7	Response time	B	0.8	R	$\sqrt{3}$	1	1	0.5	0.5	∞
8	Integration time	B	2.6	R	$\sqrt{3}$	1	1	1.5	1.5	∞
9	RF ambient conditions-noise	B	0	R	$\sqrt{3}$	1	1	0	0	∞
10	RF ambient conditions-reflection	B	0	R	$\sqrt{3}$	1	1	0	0	∞
11	Probe positioned mech. restrictions	B	0.8	R	$\sqrt{3}$	1	1	0.5	0.5	∞
12	Probe positioning with respect to phantom shell	B	6.7	R	$\sqrt{3}$	1	1	3.9	3.9	∞
13	Post-processing	B	4.0	R	$\sqrt{3}$	1	1	2.3	2.3	∞
Test sample related										
14	Test sample positioning	A	3.3	N	1	1	1	3.3	3.3	71
15	Device holder uncertainty	A	3.4	N	1	1	1	3.4	3.4	5
16	Drift of output power	B	5.0	R	$\sqrt{3}$	1	1	2.9	2.9	∞
Phantom and set-up										
17	Phantom uncertainty	B	4.0	R	$\sqrt{3}$	1	1	2.3	2.3	∞
18	Liquid conductivity (target)	B	5.0	R	$\sqrt{3}$	0.64	0.43	1.8	1.2	∞
19	Liquid conductivity (meas.)	A	2.06	N	1	0.64	0.43	1.32	0.89	43

20	Liquid permittivity (target)	B	5.0	R	$\sqrt{3}$	0.6	0.49	1.7	1.4	∞
21	Liquid permittivity (meas.)	A	1.6	N	1	0.6	0.49	1.0	0.8	521
Combined standard uncertainty		$u_c = \sqrt{\sum_{i=1}^{21} c_i^2 u_i^2}$						10.7	10.6	257
Expanded uncertainty (confidence interval of 95 %)		$u_e = 2u_c$						21.4	21.1	

16.3 Measurement Uncertainty for Fast SAR Tests (300MHz~3GHz)

No.	Error Description	Type	Uncertainty value	Probably Distribution	Div.	(Ci) 1g	(Ci) 10g	Std. Unc. (1g)	Std. Unc. (10g)	Degree of freedom
Measurement system										
1	Probe calibration	B	6.0	N	1	1	1	6.0	6.0	∞
2	Isotropy	B	4.7	R	$\sqrt{3}$	0.7	0.7	1.9	1.9	∞
3	Boundary effect	B	1.0	R	$\sqrt{3}$	1	1	0.6	0.6	∞
4	Linearity	B	4.7	R	$\sqrt{3}$	1	1	2.7	2.7	∞
5	Detection limit	B	1.0	R	$\sqrt{3}$	1	1	0.6	0.6	∞
6	Readout electronics	B	0.3	R	$\sqrt{3}$	1	1	0.3	0.3	∞
7	Response time	B	0.8	R	$\sqrt{3}$	1	1	0.5	0.5	∞
8	Integration time	B	2.6	R	$\sqrt{3}$	1	1	1.5	1.5	∞
9	RF ambient conditions-noise	B	0	R	$\sqrt{3}$	1	1	0	0	∞
10	RF ambient conditions-reflection	B	0	R	$\sqrt{3}$	1	1	0	0	∞
11	Probe positioned mech. Restrictions	B	0.4	R	$\sqrt{3}$	1	1	0.2	0.2	∞
12	Probe positioning with respect to phantom shell	B	2.9	R	$\sqrt{3}$	1	1	1.7	1.7	∞
13	Post-processing	B	1.0	R	$\sqrt{3}$	1	1	0.6	0.6	∞
14	Fast SAR z-Approximation	B	7.0	R	$\sqrt{3}$	1	1	4.0	4.0	∞
Test sample related										
15	Test sample positioning	A	3.3	N	1	1	1	3.3	3.3	71
16	Device holder uncertainty	A	3.4	N	1	1	1	3.4	3.4	5
17	Drift of output power	B	5.0	R	$\sqrt{3}$	1	1	2.9	2.9	∞

Phantom and set-up										
18	Phantom uncertainty	B	4.0	R	$\sqrt{3}$	1	1	2.3	2.3	∞
19	Liquid conductivity (target)	B	5.0	R	$\sqrt{3}$	0.64	0.43	1.8	1.2	∞
20	Liquid conductivity (meas.)	A	2.06	N	1	0.64	0.43	1.32	0.89	43
21	Liquid permittivity (target)	B	5.0	R	$\sqrt{3}$	0.6	0.49	1.7	1.4	∞
22	Liquid permittivity (meas.)	A	1.6	N	1	0.6	0.49	1.0	0.8	521
Combined standard uncertainty		$u_c = \sqrt{\sum_{i=1}^{22} c_i^2 u_i^2}$						10.4	10.3	257
Expanded uncertainty (confidence interval of 95 %)		$u_e = 2u_c$						20.8	20.6	

16.4 Measurement Uncertainty for Fast SAR Tests (3~6GHz)

No.	Error Description	Type	Uncertainty value	Probably Distribution	Div.	(Ci) 1g	(Ci) 10g	Std. Unc. (1g)	Std. Unc. (10g)	Degree of freedom
Measurement system										
1	Probe calibration	B	6.55	N	1	1	1	6.55	6.55	∞
2	Isotropy	B	4.7	R	$\sqrt{3}$	0.7	0.7	1.9	1.9	∞
3	Boundary effect	B	2.0	R	$\sqrt{3}$	1	1	1.2	1.2	∞
4	Linearity	B	4.7	R	$\sqrt{3}$	1	1	2.7	2.7	∞
5	Detection limit	B	1.0	R	$\sqrt{3}$	1	1	0.6	0.6	∞
6	Readout electronics	B	0.3	R	$\sqrt{3}$	1	1	0.3	0.3	∞
7	Response time	B	0.8	R	$\sqrt{3}$	1	1	0.5	0.5	∞
8	Integration time	B	2.6	R	$\sqrt{3}$	1	1	1.5	1.5	∞
9	RF ambient conditions-noise	B	0	R	$\sqrt{3}$	1	1	0	0	∞
10	RF ambient conditions-reflection	B	0	R	$\sqrt{3}$	1	1	0	0	∞
11	Probe positioned mech. Restrictions	B	0.8	R	$\sqrt{3}$	1	1	0.5	0.5	∞
12	Probe positioning with respect to phantom shell	B	6.7	R	$\sqrt{3}$	1	1	3.9	3.9	∞
13	Post-processing	B	1.0	R	$\sqrt{3}$	1	1	0.6	0.6	∞
14	Fast SAR z-Approximation	B	14.0	R	$\sqrt{3}$	1	1	8.1	8.1	∞

Test sample related										
15	Test sample positioning	A	3.3	N	1	1	1	3.3	3.3	71
16	Device holder uncertainty	A	3.4	N	1	1	1	3.4	3.4	5
17	Drift of output power	B	5.0	R	$\sqrt{3}$	1	1	2.9	2.9	∞
Phantom and set-up										
18	Phantom uncertainty	B	4.0	R	$\sqrt{3}$	1	1	2.3	2.3	∞
19	Liquid conductivity (target)	B	5.0	R	$\sqrt{3}$	0.64	0.43	1.8	1.2	∞
20	Liquid conductivity (meas.)	A	2.06	N	1	0.64	0.43	1.32	0.89	43
21	Liquid permittivity (target)	B	5.0	R	$\sqrt{3}$	0.6	0.49	1.7	1.4	∞
22	Liquid permittivity (meas.)	A	1.6	N	1	0.6	0.49	1.0	0.8	521
Combined standard uncertainty		$u_c = \sqrt{\sum_{i=1}^{22} c_i^2 u_i^2}$						13.5	13.4	257
Expanded uncertainty (confidence interval of 95 %)		$u_e = 2u_c$						27.0	26.8	

17 MAIN TEST INSTRUMENTS

No.	Name	Type	Serial Number	Calibration Date	Valid Period
01	Network analyzer	N5239A	MY46110673	January 24, 2020	One year
02	Power meter	NRP2	106277	September 4, 2019	One year
03	Power sensor	NRP8S	104291		
04	Signal Generator	E4438C	MY49070393	January 4, 2020	One Year
05	Amplifier	60S1G4	0331848	No Calibration Requested	
06	BTS	CMW500	166370	June 27, 2019	One year
07	E-field Probe	SPEAG EX3DV4	3617	Jan 30, 2020	One year
08	DAE	SPEAG DAE4	777	Jan 8, 2020	One year
09	Dipole Validation Kit	SPEAG D750V3	1017	July 18,2019	One year
10	Dipole Validation Kit	SPEAG D835V2	4d069	July 18,2019	One year
11	Dipole Validation Kit	SPEAG D1750V2	1003	July 16,2019	One year
12	Dipole Validation Kit	SPEAG D1900V2	5d101	July 17,2019	One year
13	Dipole Validation Kit	SPEAG D2450V2	853	July 17,2019	One year
14	Dipole Validation Kit	SPEAG D2600V2	1012	July 17,2019	One year
15	Dipole Validation Kit	SPEAG D5GHzV2	1060	July 22, 2019	One year

END OF REPORT BODY

ANNEX A Graph Results

GSM850_CH251 Rear 0mm

Date: 6/26/2020

Electronics: DAE4 Sn777

Medium: head 835 MHz

Medium parameters used: $f = 848.8$ MHz; $\sigma = 0.901$ mho/m; $\epsilon_r = 40.67$; $\rho = 1000$ kg/m³

Ambient Temperature: 22.9°C, Liquid Temperature: 22.5°C

Communication System: GSM850 848.8 MHz Duty Cycle: 1:8.3

Probe: EX3DV4 – SN3617 ConvF(9.66,9.66,9.66)

Area Scan (71x121x1): Interpolated grid: $dx=1.000$ mm, $dy=1.000$ mm

Maximum value of SAR (interpolated) = 0.633 W/kg

Zoom Scan (7x7x7)/Cube 0: Measurement grid: $dx=5$ mm, $dy=5$ mm, $dz=5$ mm

Reference Value = 2.679 V/m; Power Drift = 0.02 dB

Peak SAR (extrapolated) = 1.64 W/kg

SAR(1 g) = 0.557 W/kg; SAR(10 g) = 0.247 W/kg

Maximum value of SAR (measured) = 0.558 W/kg

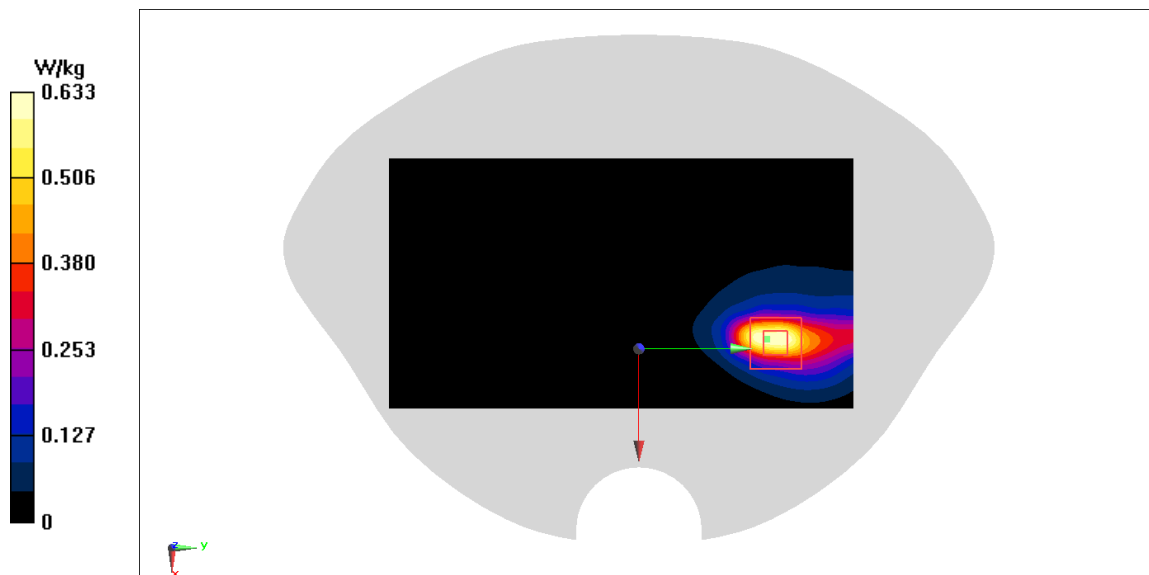

Fig A.1

PCS1900_CH810 Rear 0mm

Date: 6/28/2020

Electronics: DAE4 Sn777

Medium: head 1900 MHz

Medium parameters used: $f = 1909.8$ MHz; $\sigma = 1.42$ mho/m; $\epsilon_r = 39.37$; $\rho = 1000$ kg/m³

Ambient Temperature: 22.9°C, Liquid Temperature: 22.5°C

Communication System: PCS1900 1909.8 MHz Duty Cycle: 1:2.67

Probe: EX3DV4 – SN3617 ConvF(8.14,8.14,8.14)

Area Scan (71x121x1): Interpolated grid: dx=1.000 mm, dy=1.000 mm

Maximum value of SAR (interpolated) = 0.66 W/kg

Zoom Scan (7x7x7)/Cube 0: Measurement grid: dx=5mm, dy=5mm, dz=5mm

Reference Value = 0 V/m; Power Drift = 0 dB

Peak SAR (extrapolated) = 1.84 W/kg

SAR(1 g) = 0.575 W/kg; SAR(10 g) = 0.246 W/kg

Maximum value of SAR (measured) = 0.62 W/kg

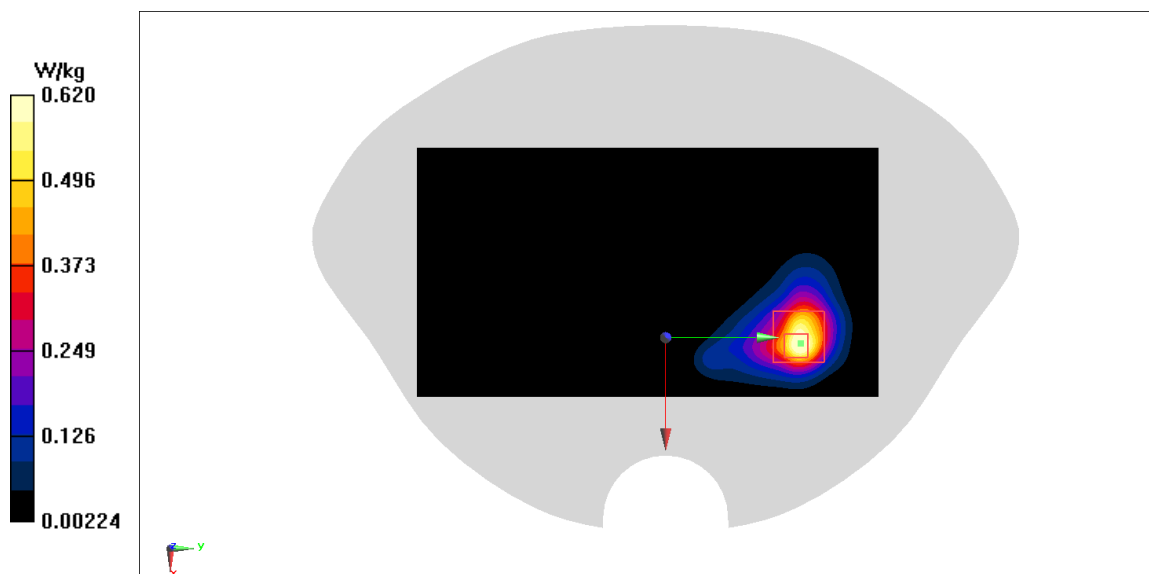

Fig A.2

WCDMA1900-BII_CH9262 Right 13mm

Date: 6/28/2020

Electronics: DAE4 Sn777

Medium: head 1900 MHz

Medium parameters used: $f = 1852.4$ MHz; $\sigma = 1.365$ mho/m; $\epsilon_r = 39.44$; $\rho = 1000$ kg/m³

Ambient Temperature: 22.9°C, Liquid Temperature: 22.5°C

Communication System: WCDMA1900-BII 1852.4 MHz Duty Cycle: 1:1

Probe: EX3DV4 – SN3617 ConvF(8.14,8.14,8.14)

Area Scan (71x121x1): Interpolated grid: dx=1.000 mm, dy=1.000 mm

Maximum value of SAR (interpolated) = 0.669 W/kg

Zoom Scan (7x7x7)/Cube 0: Measurement grid: dx=5mm, dy=5mm, dz=5mm

Reference Value = 5.635 V/m; Power Drift = -0.04 dB

Peak SAR (extrapolated) = 0.985 W/kg

SAR(1 g) = 0.607 W/kg; SAR(10 g) = 0.362 W/kg

Maximum value of SAR (measured) = 0.656 W/kg

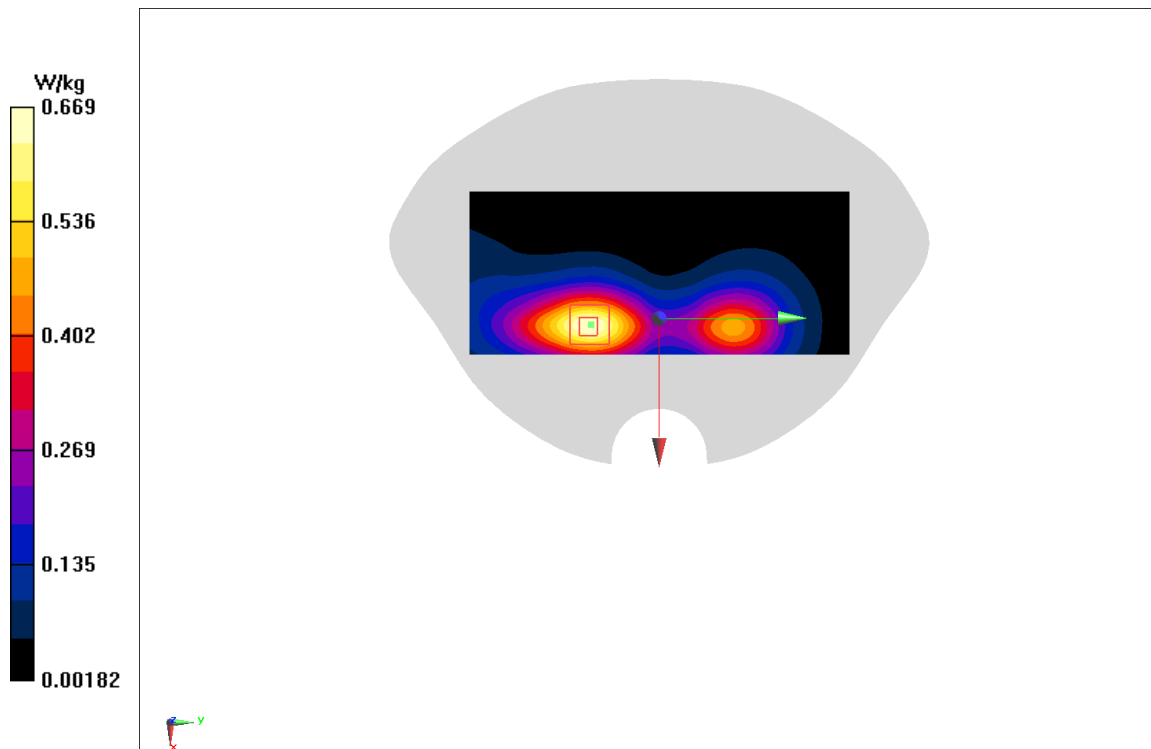

Fig A.3

WCDMA1700-BIV_CH1312 Rear 0mm

Date: 6/27/2020

Electronics: DAE4 Sn777

Medium: head 1750 MHz

Medium parameters used: $f = 1712.4$ MHz; $\sigma = 1.318$ mho/m; $\epsilon_r = 40.25$; $\rho = 1000$ kg/m³

Ambient Temperature: 22.9°C, Liquid Temperature: 22.5°C

Communication System: WCDMA1700-BIV 1712.4 MHz Duty Cycle: 1:1

Probe: EX3DV4 – SN3617 ConvF(8.41,8.41,8.41)

Area Scan (71x121x1): Interpolated grid: dx=1.000 mm, dy=1.000 mm

Maximum value of SAR (interpolated) = 0.877 W/kg

Zoom Scan (7x7x7)/Cube 0: Measurement grid: dx=5mm, dy=5mm, dz=5mm

Reference Value = 0 V/m; Power Drift = 0 dB

Peak SAR (extrapolated) = 2.16 W/kg

SAR(1 g) = 0.76 W/kg; SAR(10 g) = 0.329 W/kg

Maximum value of SAR (measured) = 0.756 W/kg

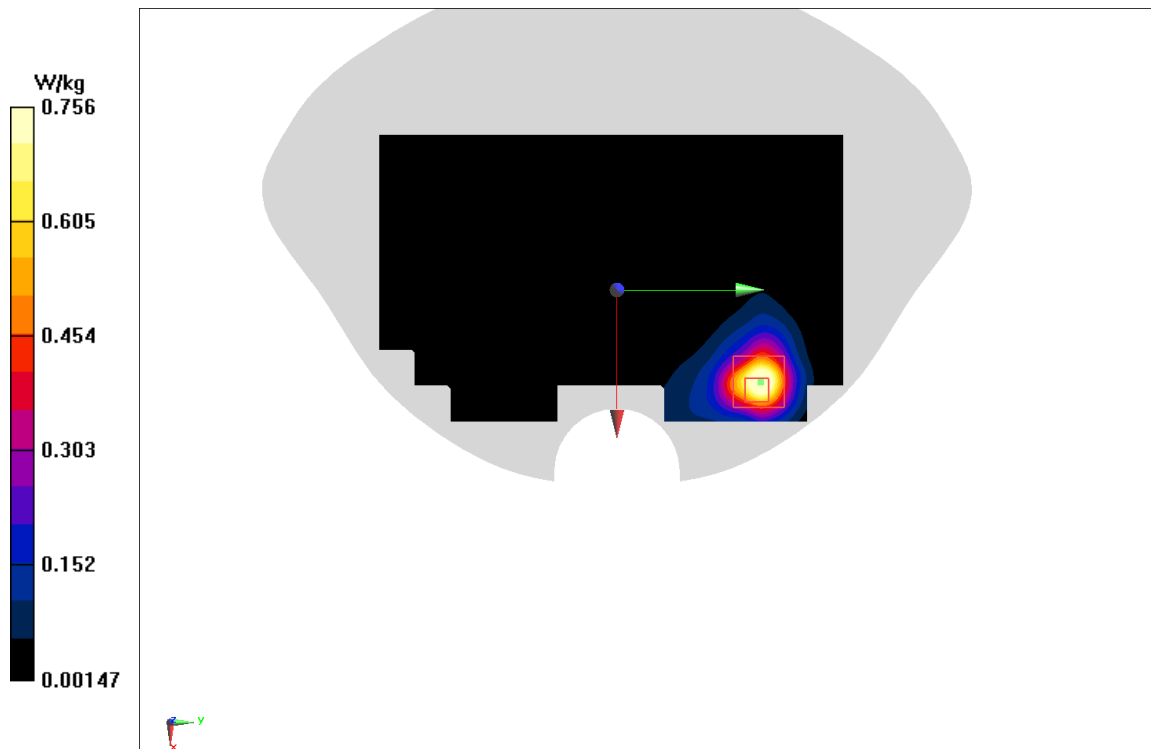

Fig A.4

WCDMA850-BV_CH4132 Rear 0mm

Date: 6/26/2020

Electronics: DAE4 Sn777

Medium: head 835 MHz

Medium parameters used: $f = 826.4$ MHz; $\sigma = 0.879$ mho/m; $\epsilon_r = 40.7$; $\rho = 1000$ kg/m³

Ambient Temperature: 22.9°C, Liquid Temperature: 22.5°C

Communication System: WCDMA850-BV 826.4 MHz Duty Cycle: 1:1

Probe: EX3DV4 – SN3617 ConvF(9.66,9.66,9.66)

Area Scan (71x121x1): Interpolated grid: dx=1.000 mm, dy=1.000 mm

Maximum value of SAR (interpolated) = 0.694 W/kg

Zoom Scan (7x7x7)/Cube 0: Measurement grid: dx=5mm, dy=5mm, dz=5mm

Reference Value = 4.581 V/m; Power Drift = 0.02 dB

Peak SAR (extrapolated) = 2.14 W/kg

SAR(1 g) = 0.573 W/kg; SAR(10 g) = 0.236 W/kg

Maximum value of SAR (measured) = 0.674 W/kg

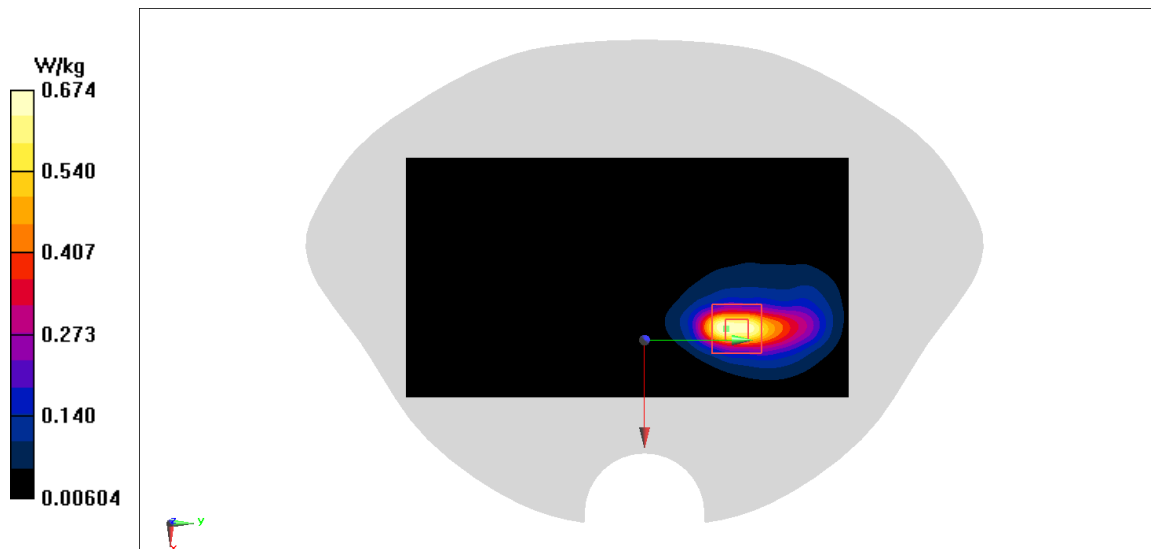

Fig A.5

LTE1900-FDD2_CH18700 Top 19mm

Date: 6/28/2020

Electronics: DAE4 Sn777

Medium: head 1900 MHz

Medium parameters used: $f = 1860$ MHz; $\sigma = 1.373$ mho/m; $\epsilon_r = 39.43$; $\rho = 1000$ kg/m³

Ambient Temperature: 22.9°C, Liquid Temperature: 22.5°C

Communication System: LTE1900-FDD2 1860 MHz Duty Cycle: 1:1

Probe: EX3DV4 – SN3617 ConvF(8.14,8.14,8.14)

Area Scan (71x121x1): Interpolated grid: dx=1.000 mm, dy=1.000 mm

Maximum value of SAR (interpolated) = 0.957 W/kg

Zoom Scan (7x7x7)/Cube 0: Measurement grid: dx=5mm, dy=5mm, dz=5mm

Reference Value = 6.772 V/m; Power Drift = 0.01 dB

Peak SAR (extrapolated) = 1.39 W/kg

SAR(1 g) = 0.841 W/kg; SAR(10 g) = 0.467 W/kg

Maximum value of SAR (measured) = 0.912 W/kg

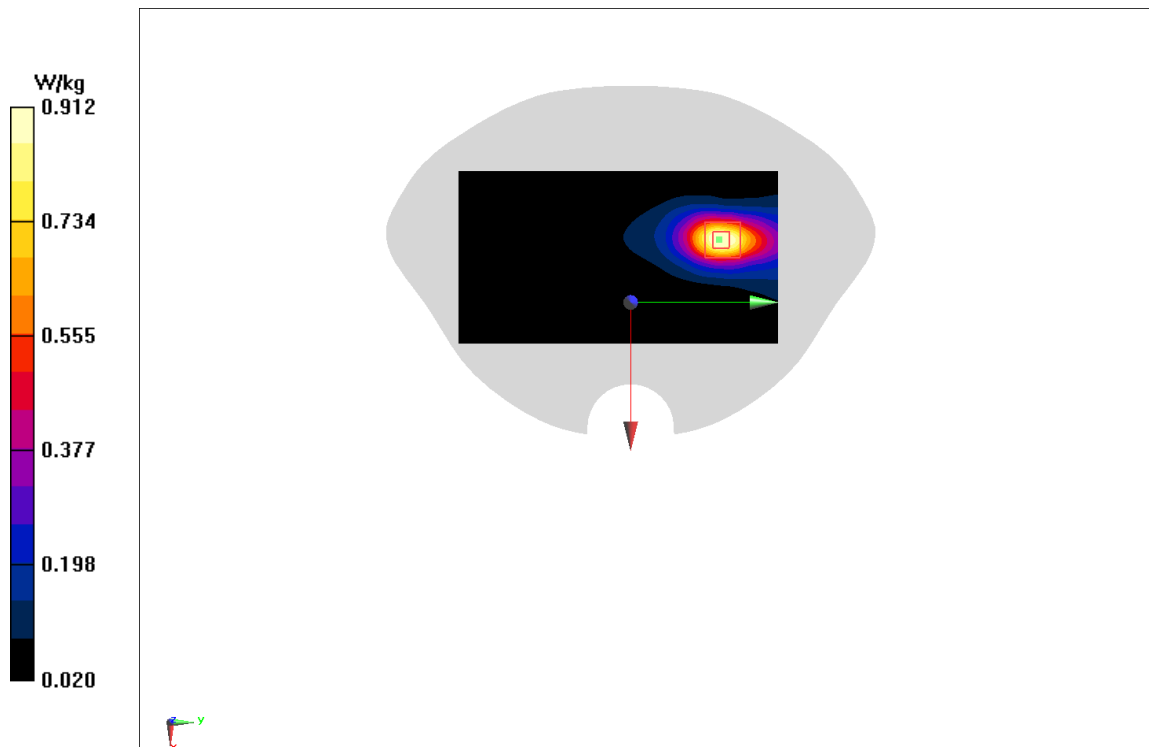

Fig A.6

LTE850-FDD5_CH20450 25RB-High Rear 0mm

Date: 6/26/2020

Electronics: DAE4 Sn777

Medium: head 835 MHz

Medium parameters used: $f = 829$ MHz; $\sigma = 0.882$ mho/m; $\epsilon_r = 40.7$; $\rho = 1000$ kg/m³

Ambient Temperature: 22.9°C, Liquid Temperature: 22.5°C

Communication System: LTE850-FDD5 829 MHz Duty Cycle: 1:1

Probe: EX3DV4 – SN3617 ConvF(9.66,9.66,9.66)

Area Scan (71x121x1): Interpolated grid: dx=1.000 mm, dy=1.000 mm

Maximum value of SAR (interpolated) = 1.21 W/kg

Zoom Scan (7x7x7)/Cube 0: Measurement grid: dx=5mm, dy=5mm, dz=5mm

Reference Value = 4.128 V/m; Power Drift = 0.11 dB

Peak SAR (extrapolated) = 0.87 W/kg

SAR(1 g) = 0.513 W/kg; SAR(10 g) = 0.201 W/kg

Maximum value of SAR (measured) = 0.73 W/kg

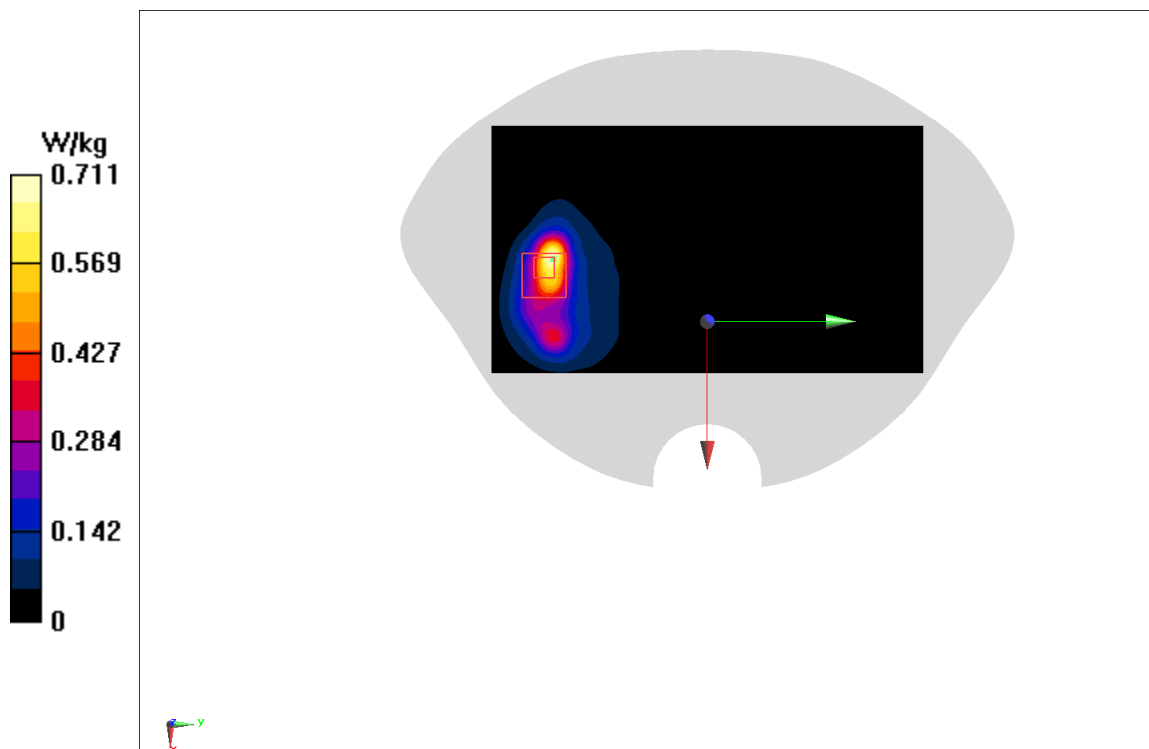

Fig A.7

LTE2500-FDD7_CH20850 1RB-Low Rear 0mm

Date: 6/30/2020

Electronics: DAE4 Sn777

Medium: head 2600 MHz

Medium parameters used: $f = 2510$ MHz; $\sigma = 1.87$ mho/m; $\epsilon_r = 39.12$; $\rho = 1000$ kg/m³

Ambient Temperature: 22.9°C, Liquid Temperature: 22.5°C

Communication System: LTE2500-FDD7 2510 MHz Duty Cycle: 1:1

Probe: EX3DV4 – SN3617 ConvF(7.52,7.52,7.52)

Area Scan (71x121x1): Interpolated grid: dx=1.000 mm, dy=1.000 mm

Maximum value of SAR (interpolated) = 0.739 W/kg

Zoom Scan (7x7x7)/Cube 0: Measurement grid: dx=5mm, dy=5mm, dz=5mm

Reference Value = 0.472 V/m; Power Drift = 0.08 dB

Peak SAR (extrapolated) = 1.93 W/kg

SAR(1 g) = 0.601 W/kg; SAR(10 g) = 0.211 W/kg

Maximum value of SAR (measured) = 0.759 W/kg

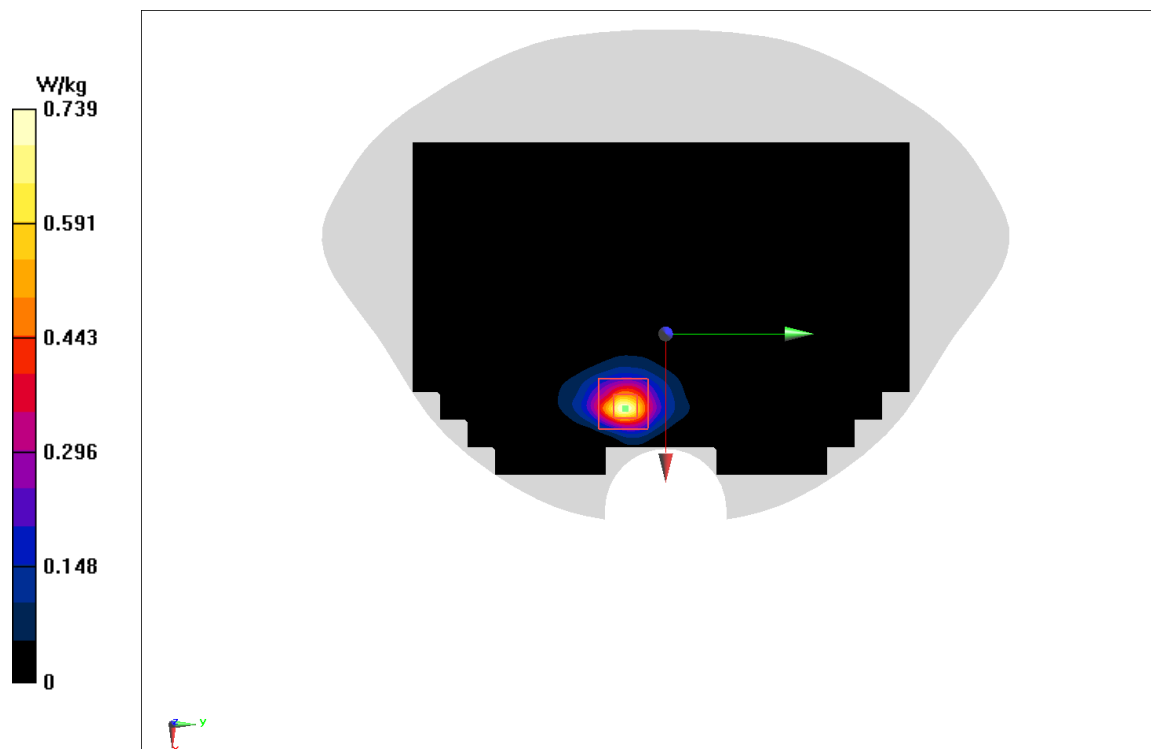

Fig A.8

LTE700-FDD12_CH23060 1RB-Low Rear 0mm

Date: 6/25/2020

Electronics: DAE4 Sn777

Medium: head 750 MHz

Medium parameters used: $f = 704$ MHz; $\sigma = 0.846$ mho/m; $\epsilon_r = 42.56$; $\rho = 1000$ kg/m³

Ambient Temperature: 22.9°C, Liquid Temperature: 22.5°C

Communication System: LTE700-FDD12 704 MHz Duty Cycle: 1:1

Probe: EX3DV4 – SN3617 ConvF(10.07,10.07,10.07)

Area Scan (71x121x1): Interpolated grid: dx=1.000 mm, dy=1.000 mm

Maximum value of SAR (interpolated) = 0.472 W/kg

Zoom Scan (7x7x7)/Cube 0: Measurement grid: dx=5mm, dy=5mm, dz=5mm

Reference Value = 5.675 V/m; Power Drift = -0.01 dB

Peak SAR (extrapolated) = 2.1 W/kg

SAR(1 g) = 0.644 W/kg; SAR(10 g) = 0.27 W/kg

Maximum value of SAR (measured) = 0.782 W/kg

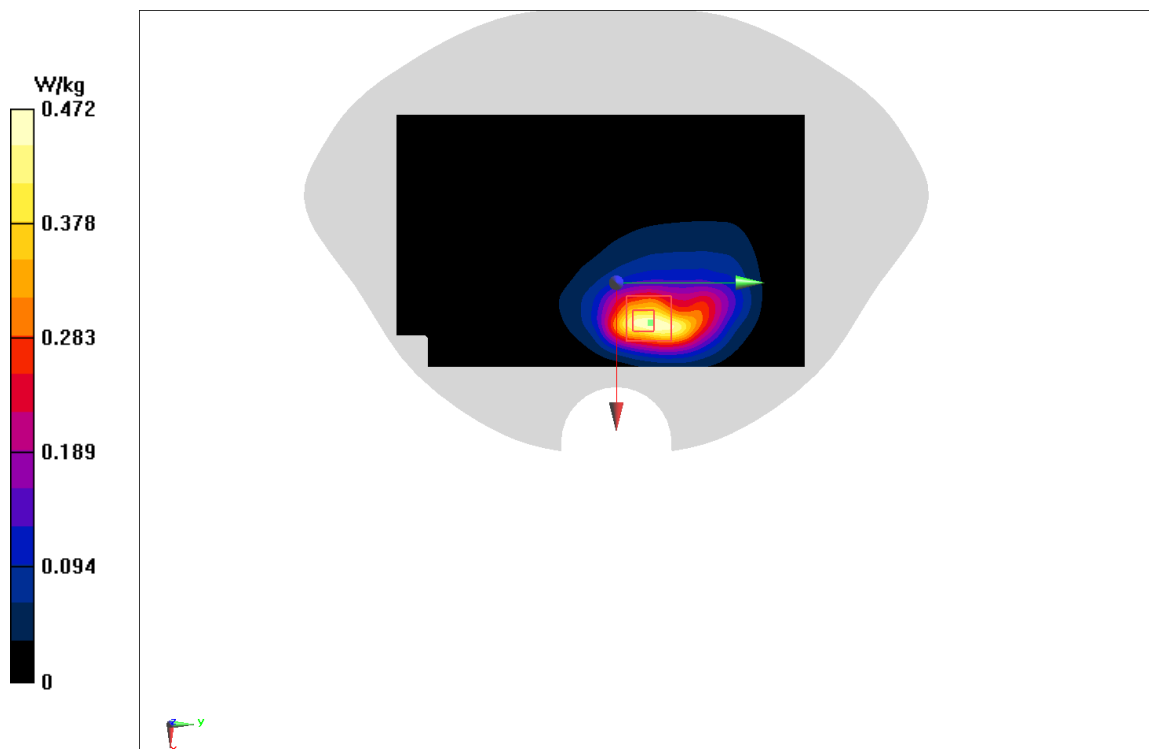
**Fig A.9**

LTE800-B18_CH23925 36RB-Low Rear 0mm

Date: 6/26/2020

Electronics: DAE4 Sn777

Medium: head 835 MHz

Medium parameters used: $f = 822.5$ MHz; $\sigma = 0.876$ mho/m; $\epsilon_r = 40.71$; $\rho = 1000$ kg/m³

Ambient Temperature: 22.9°C, Liquid Temperature: 22.5°C

Communication System: LTE800-B18 822.5MHz Duty Cycle: 1:1

Probe: EX3DV4 – SN3617 ConvF(9.66,9.66,9.66)

Area Scan (71x121x1): Interpolated grid: dx=1.000 mm, dy=1.000 mm

Maximum value of SAR (interpolated) = 0.79 W/kg

Zoom Scan (7x7x7)/Cube 0: Measurement grid: dx=5mm, dy=5mm, dz=5mm

Reference Value = 4.850 V/m; Power Drift = 0.15 dB

Peak SAR (extrapolated) = 9.93 W/kg

SAR(1 g) = 0.616 W/kg; SAR(10 g) = 0.255 W/kg

Maximum value of SAR (measured) = 0.77 W/kg

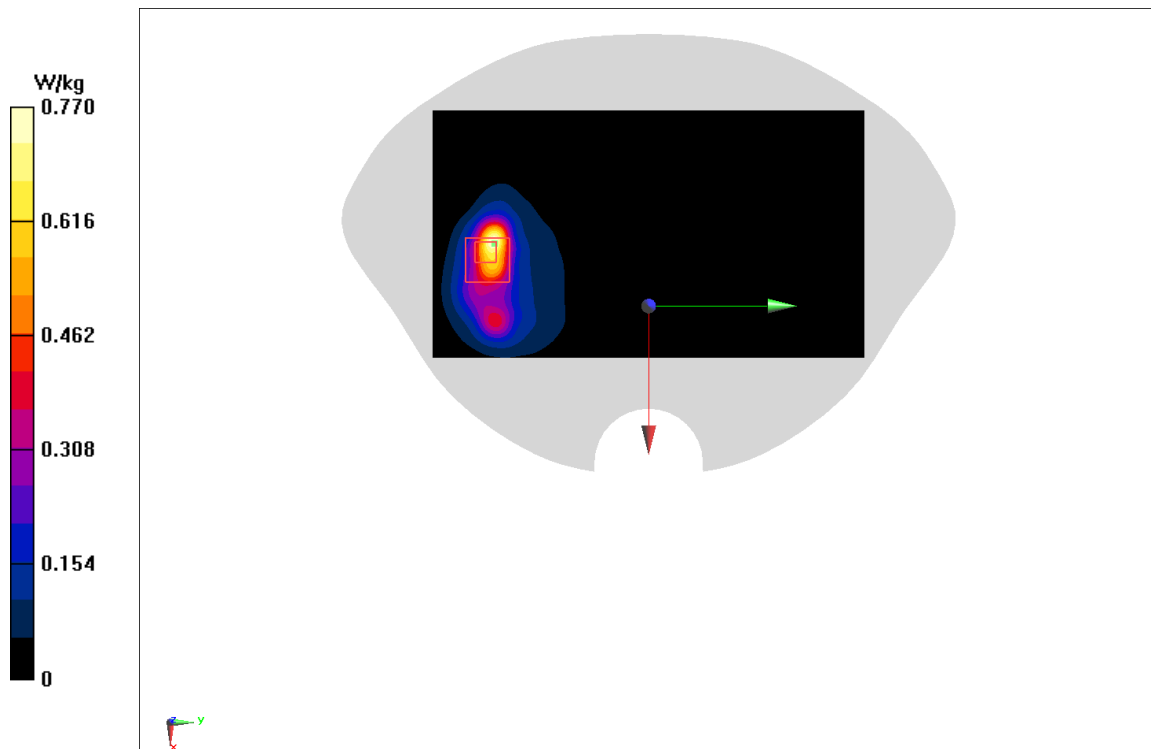

Fig A.10

LTE800-B19_CH24075 1RB-Low Rear 0mm

Date: 6/26/2020

Electronics: DAE4 Sn777

Medium: head 835 MHz

Medium parameters used: $f = 837.5$ MHz; $\sigma = 0.891$ mho/m; $\epsilon_r = 40.69$; $\rho = 1000$ kg/m³

Ambient Temperature: 22.9°C, Liquid Temperature: 22.5°C

Communication System: LTE800-B19 837.5 MHz Duty Cycle: 1:1

Probe: EX3DV4 – SN3617 ConvF(9.66,9.66,9.66)

Area Scan (71x121x1): Interpolated grid: dx=1.000 mm, dy=1.000 mm

Maximum value of SAR (interpolated) = 0.82 W/kg

Zoom Scan (7x7x7)/Cube 0: Measurement grid: dx=5mm, dy=5mm, dz=5mm

Reference Value = 5.508 V/m; Power Drift = 0.19 dB

Peak SAR (extrapolated) = 13.4 W/kg

SAR(1 g) = 0.727 W/kg; SAR(10 g) = 0.31 W/kg

Maximum value of SAR (measured) = 0.947 W/kg

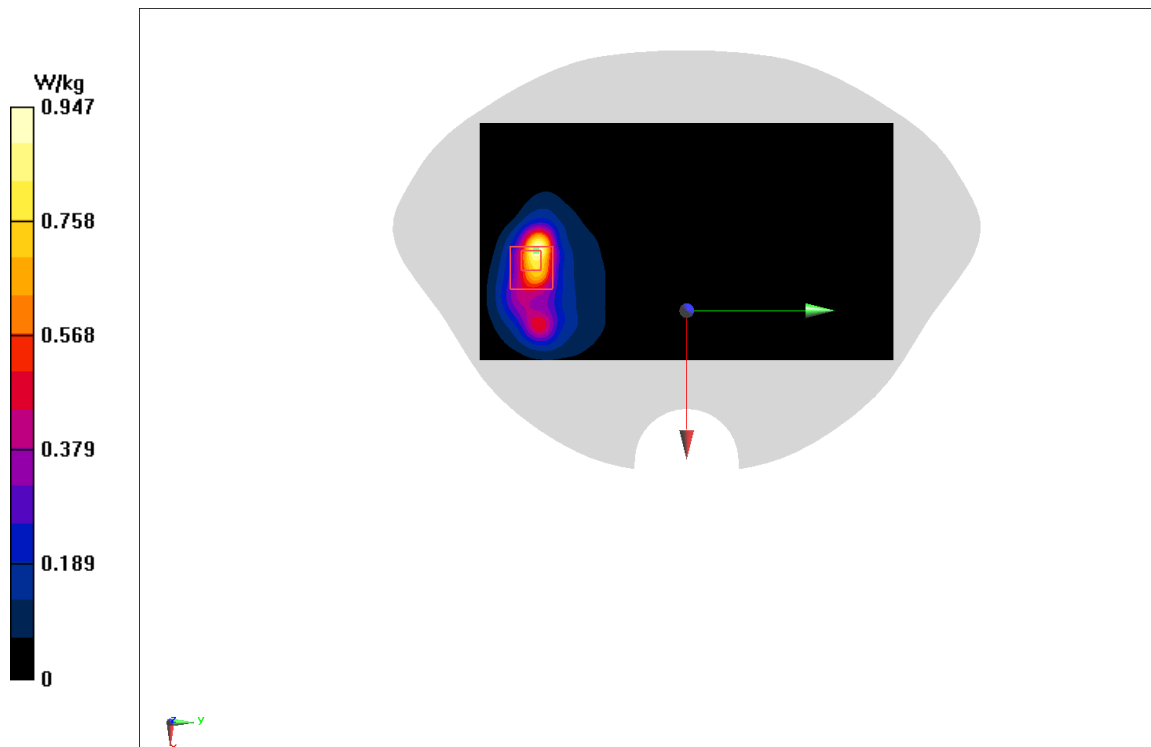

Fig A.11

LTE700-FDD28_CH27310 1RB-Low Rear 0mm

Date: 6/25/2020

Electronics: DAE4 Sn777

Medium: head 750 MHz

Medium parameters used: $f = 713 \text{ MHz}$; $\sigma = 0.845 \text{ mho/m}$; $\epsilon_r = 41.886$; $\rho = 1000 \text{ kg/m}^3$

Ambient Temperature: 22.9°C, Liquid Temperature: 22.5°C

Communication System: LTE700-FDD28 713 MHz Duty Cycle: 1:1

Probe: EX3DV4 – SN3617 (10.07,10.07,10.07)

Area Scan (71x121x1): Interpolated grid: $dx=1.000 \text{ mm}$, $dy=1.000 \text{ mm}$

Maximum value of SAR (interpolated) = 3.97 W/kg

Zoom Scan (7x7x7)/Cube 0: Measurement grid: $dx=5\text{mm}$, $dy=5\text{mm}$, $dz=5\text{mm}$

Reference Value = 8.848 V/m; Power Drift = -0.11 dB

Peak SAR (extrapolated) = 15.6 W/kg

SAR(1 g) = 0.53 W/kg; SAR(10 g) = 0.23 W/kg

Maximum value of SAR (measured) = 0.711 W/kg

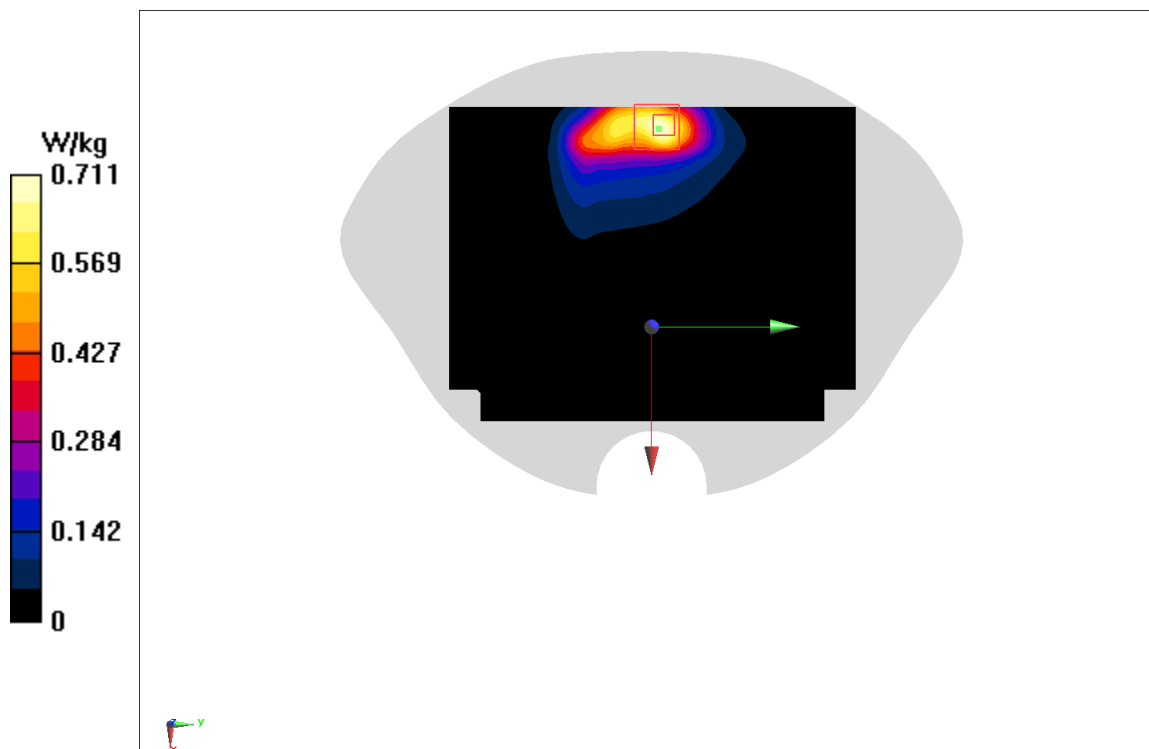

Fig A.12

LTE2600-TDD38_CH38150 50RB-High Rear 0mm

Date: 6/30/2020

Electronics: DAE4 Sn777

Medium: head 2600 MHz

Medium parameters used: $f = 2610$ MHz; $\sigma = 1.966$ mho/m; $\epsilon_r = 39$; $\rho = 1000$ kg/m³

Ambient Temperature: 22.9°C, Liquid Temperature: 22.5°C

Communication System: LTE2600-TDD38 2610 MHz Duty Cycle: 1:1.58

Probe: EX3DV4 – SN3617 ConvF(7.52,7.52,7.52)

Area Scan (71x121x1): Interpolated grid: dx=1.000 mm, dy=1.000 mm

Maximum value of SAR (interpolated) = 0.68 W/kg

Zoom Scan (7x7x7)/Cube 0: Measurement grid: dx=5mm, dy=5mm, dz=5mm

Reference Value = 0 V/m; Power Drift = 0 dB

Peak SAR (extrapolated) = 2.64 W/kg

SAR(1 g) = 0.651 W/kg; SAR(10 g) = 0.221 W/kg

Maximum value of SAR (measured) = 1.67 W/kg

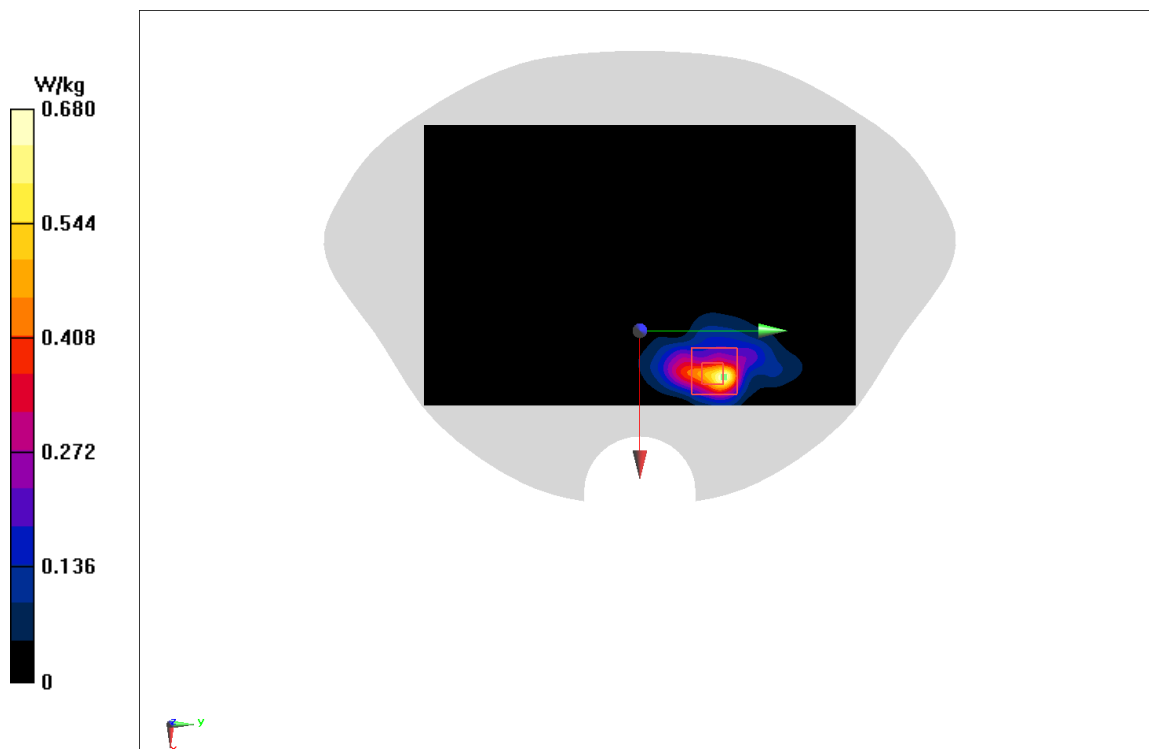

Fig A.13

LTE1700-FDD66_CH132572 1RB-High Rear 0mm

Date: 6/27/2020

Electronics: DAE4 Sn777

Medium: head 1750 MHz

Medium parameters used: $f = 1770$ MHz; $\sigma = 1.37$ mho/m; $\epsilon_r = 40.399$; $\rho = 1000$ kg/m³

Ambient Temperature: 22.9°C, Liquid Temperature: 22.5°C

Communication System: LTE1700-FDD66 1770 MHz Duty Cycle: 1:1

Probe: EX3DV4 – SN3617 ConvF(8.41,8.41,8.41)

Area Scan (71x121x1): Interpolated grid: dx=1.000 mm, dy=1.000 mm

Maximum value of SAR (interpolated) = 0.757 W/kg

Zoom Scan (7x7x7)/Cube 0: Measurement grid: dx=5mm, dy=5mm, dz=5mm

Reference Value = 0 V/m; Power Drift = 0.05 dB

Peak SAR (extrapolated) = 1.71 W/kg

SAR(1 g) = 0.619 W/kg; SAR(10 g) = 0.27 W/kg

Maximum value of SAR (measured) = 0.632 W/kg



Fig A.14

WLAN2450_CH6 Rear 0mm

Date: 6/29/2020

Electronics: DAE4 Sn777

Medium: head 2450 MHz

Medium parameters used: $f = 2437$ MHz; $\sigma = 1.806$ mho/m; $\epsilon_r = 39.85$; $\rho = 1000$ kg/m³

Ambient Temperature: 22.9°C, Liquid Temperature: 22.5°C

Communication System: WLAN2450 2437 MHz Duty Cycle: 1:1

Probe: EX3DV4 – SN3617 ConvF(7.65,7.65,7.65)

Area Scan (71x121x1): Interpolated grid: dx=1.000 mm, dy=1.000 mm

Maximum value of SAR (interpolated) = 1.29 W/kg

Zoom Scan (7x7x7)/Cube 0: Measurement grid: dx=5mm, dy=5mm, dz=5mm

Reference Value = 1.58 V/m; Power Drift = -0.07 dB

Peak SAR (extrapolated) = 2.03 W/kg

SAR(1 g) = 0.596 W/kg; SAR(10 g) = 0.209 W/kg

Maximum value of SAR (measured) = 1.35 W/kg



Fig A.15

WLAN_CH122 Rear 0mm

Date: 6/29/2020

Electronics: DAE4 Sn777

Medium: head 5GHz

Medium parameters used: $f = 5610$ MHz; $\sigma = 4.86$ mho/m; $\epsilon_r = 33.81$; $\rho = 1000$ kg/m³

Ambient Temperature: 22.9°C, Liquid Temperature: 22.5°C

Communication System: WLAN 5610 MHz Duty Cycle: 1:1

Probe: EX3DV4 – SN3617 ConvF(4.99, 4.99, 4.99)

Area Scan (71x121x1): Interpolated grid: dx=1.000 mm, dy=1.000 mm

Maximum value of SAR (interpolated) = 2.87 W/kg

Zoom Scan (7x7x7)/Cube 0: Measurement grid: dx=5mm, dy=5mm, dz=5mm

Reference Value = 0 V/m; Power Drift = -0.09 dB

Peak SAR (extrapolated) = 4.76 W/kg

SAR(1 g) = 0.679 W/kg; SAR(10 g) = 0.137 W/kg

Maximum value of SAR (measured) = 2.46 W/kg

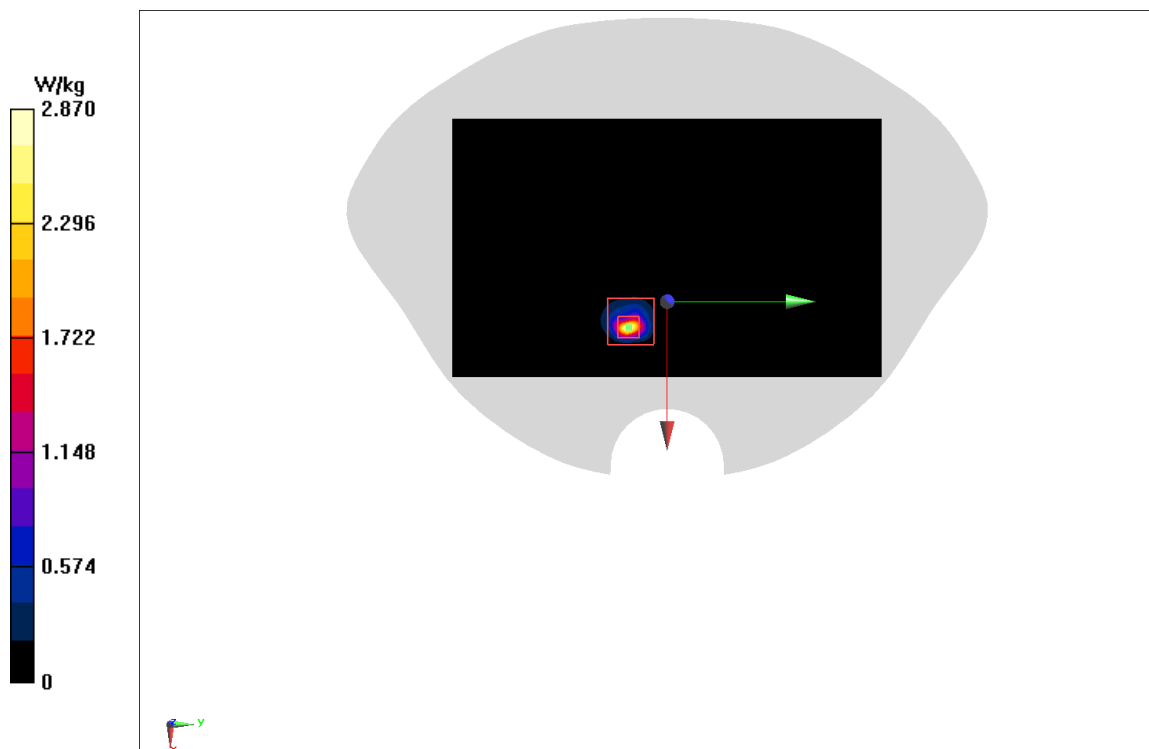

Fig A.16

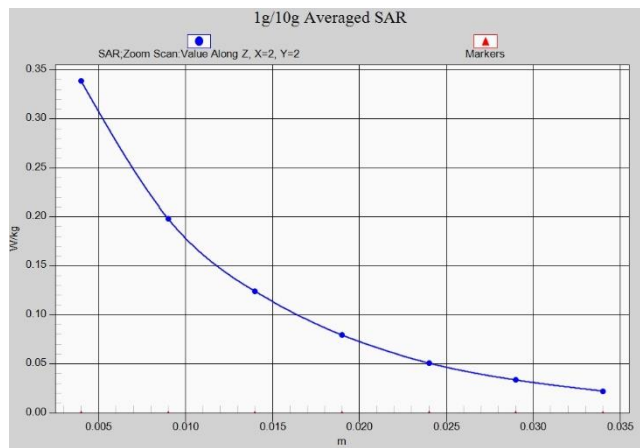

Fig.A.1- 1 Z-Scan at power reference point (GSM850)

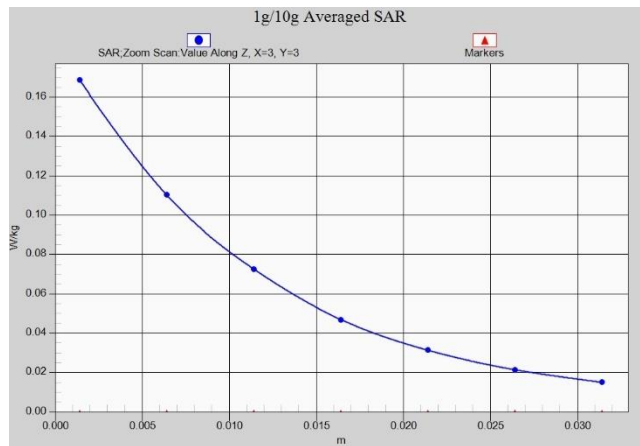

Fig.A.1- 2 Z-Scan at power reference point (PCS1900)

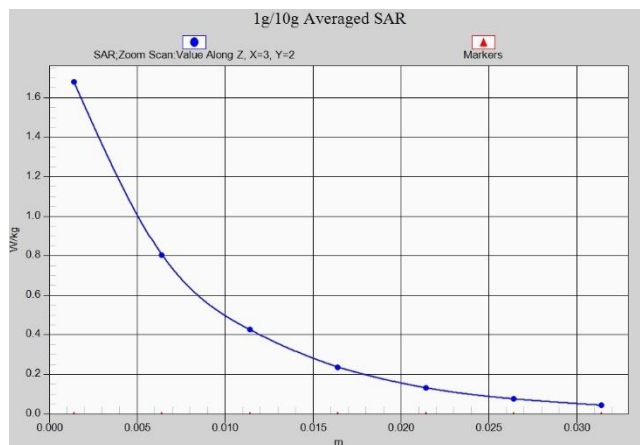

Fig.A.1- 3 Z-Scan at power reference point (W1900 r)

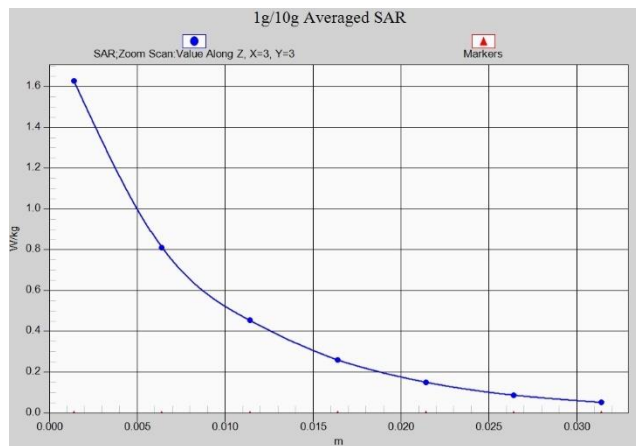

Fig.A.1- 4 Z-Scan at power reference point (W1700)

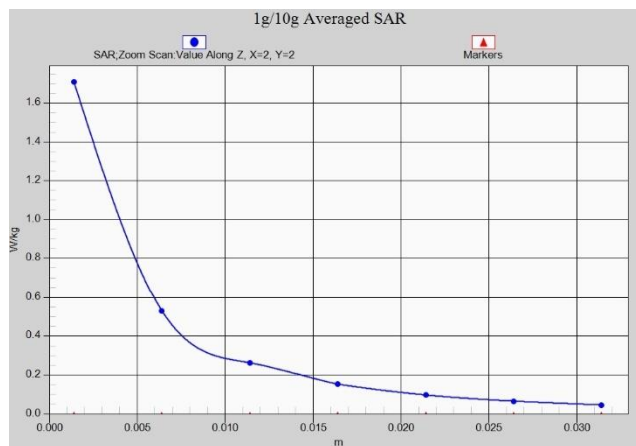

Fig.A.1-5 Z-Scan at power reference point (W850)

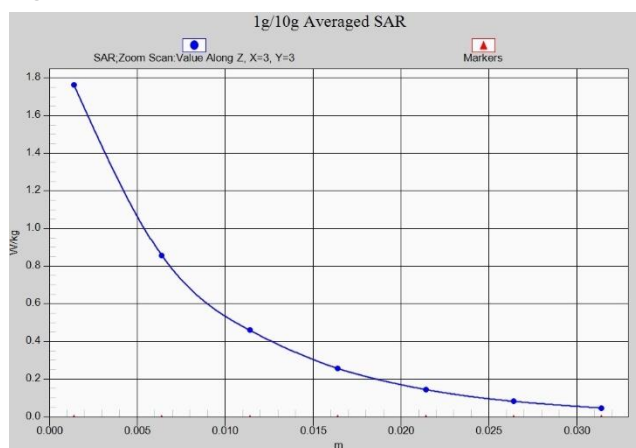

Fig.A.1- 6 Z-Scan at power reference point (LTEB2)



Fig.A.1- 7 Z-Scan at power reference point (LTEB5)

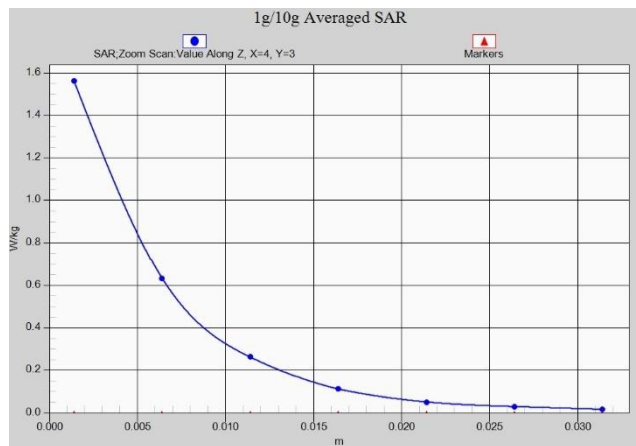

Fig.A.1- 8 Z-Scan at power reference point (LTEB7)

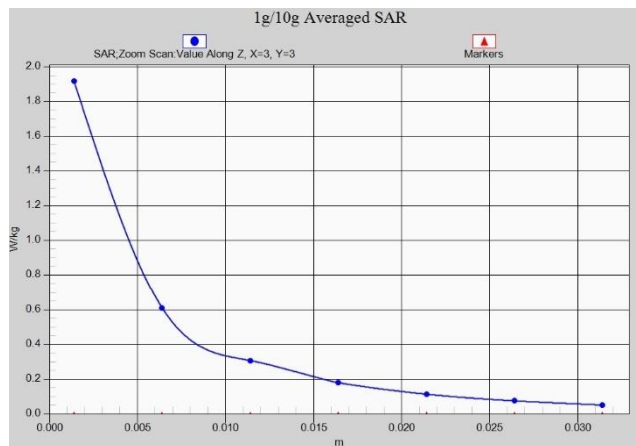

Fig.A.1- 9 Z-Scan at power reference point (LTEB12)

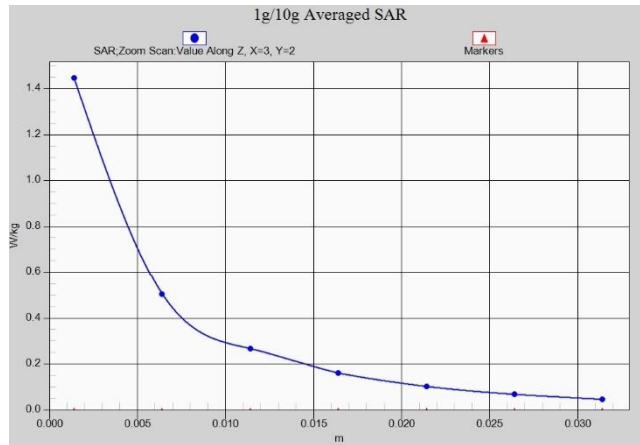

Fig.A.1- 10 Z-Scan at power reference point (LTEB13)

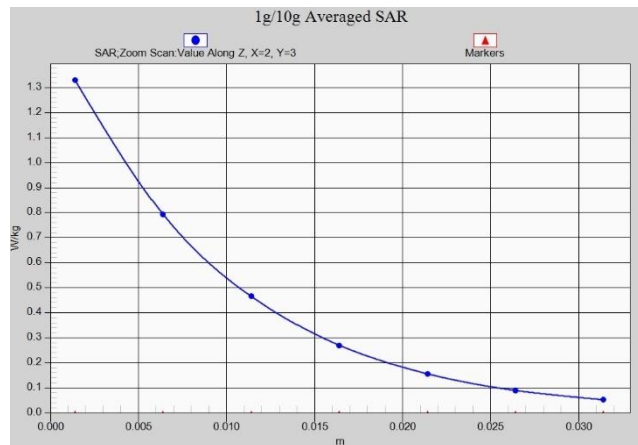

Fig.A.1- 11Z-Scan at power reference point (LTEB66)

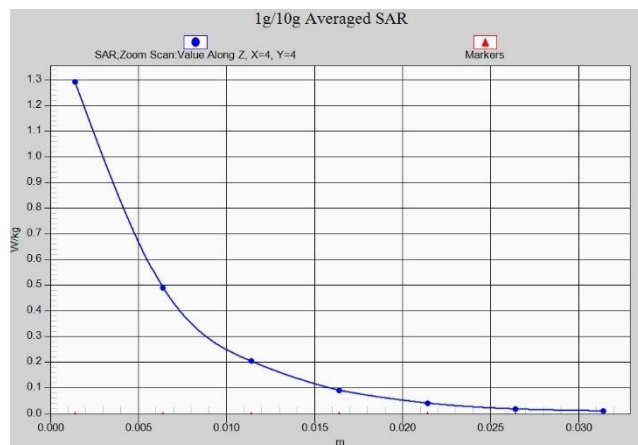

Fig.A.1- 12 Z-Scan at power reference point (WIFI2.4G)

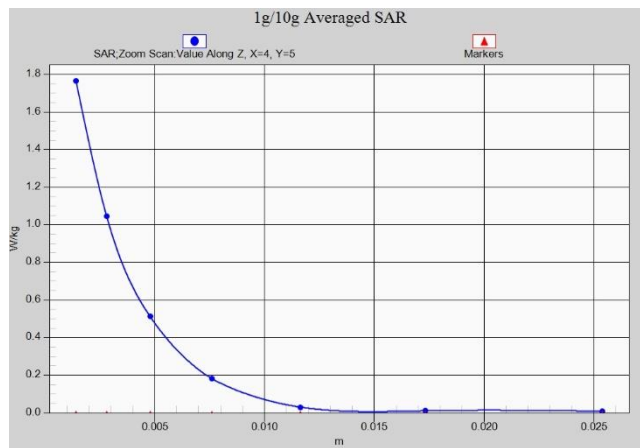

Fig.A.1- 13 Z-Scan at power reference point (WIFI5G)

ANNEX B System Verification Results

750 MHz

Date: 6/25/2020

Electronics: DAE4 Sn777

Medium: Head 750 MHz

Medium parameters used: $f = 750 \text{ MHz}$; $\sigma = 0.89 \text{ mho/m}$; $\epsilon_r = 42.5$; $\rho = 1000 \text{ kg/m}^3$

Ambient Temperature: 22.9°C Liquid Temperature: 22.5°C

Communication System: CW Frequency: 750 MHz Duty Cycle: 1:1

Probe: EX3DV4 – SN3617 ConvF(10.07,10.07,10.07)

System Validation /Area Scan (81x191x1): Interpolated grid: $dx=1.000 \text{ mm}$, $dy=1.000 \text{ mm}$

Reference Value = 58.99 V/m ; Power Drift = -0.02

Fast SAR: SAR(1 g) = 2.12 W/kg ; SAR(10 g) = 1.39 W/kg

Maximum value of SAR (interpolated) = 2.82 W/kg

System Validation /Zoom Scan (7x7x7)/Cube 0: Measurement grid: $dx=5\text{mm}$, $dy=5\text{mm}$, $dz=5\text{mm}$

Reference Value = 58.99 V/m ; Power Drift = -0.02 dB

Peak SAR (extrapolated) = 3.23 W/kg

SAR(1 g) = 2.18 W/kg ; SAR(10 g) = 1.36 W/kg

Maximum value of SAR (measured) = 2.82 W/kg

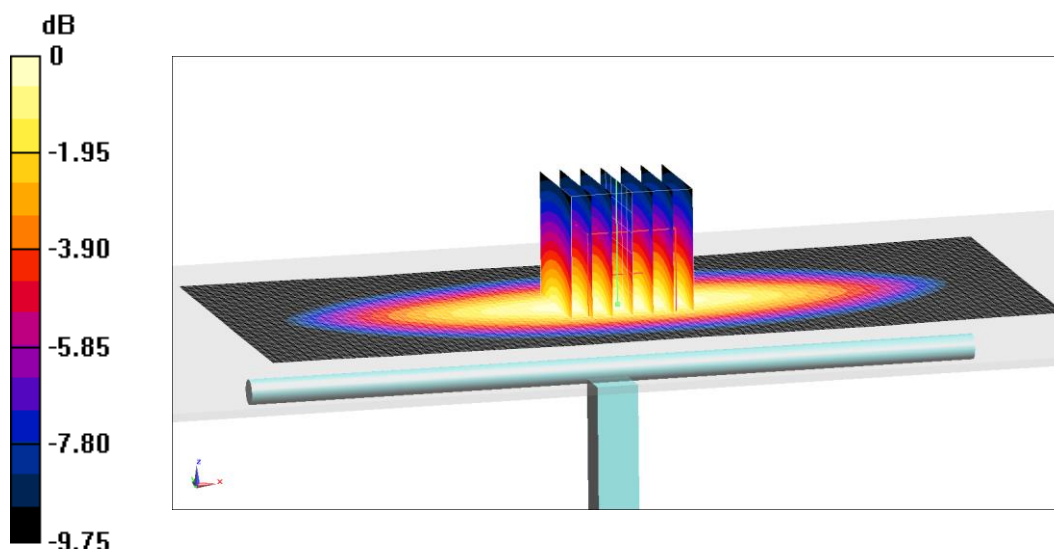

0 dB = $2.82 \text{ W/kg} = 4.5 \text{ dB W/kg}$

Fig.B.1 validation 750 MHz 250mW

835 MHz

Date: 6/26/2020

Electronics: DAE4 Sn777

Medium: Head 835 MHz

Medium parameters used: $f = 835 \text{ MHz}$; $\sigma = 0.888 \text{ mho/m}$; $\epsilon_r = 40.69$; $\rho = 1000 \text{ kg/m}^3$

Ambient Temperature: 22.9°C Liquid Temperature: 22.5°C

Communication System: CW Frequency: 835 MHz Duty Cycle: 1:1

Probe: EX3DV4 – SN3617 ConvF(9.66,9.66,9.66)

System Validation /Area Scan (81x191x1): Interpolated grid: $dx=1.000 \text{ mm}$, $dy=1.000 \text{ mm}$

Reference Value = 63.17 V/m ; Power Drift = 0.1

Fast SAR: SAR(1 g) = 2.39 W/kg ; SAR(10 g) = 1.54 W/kg

Maximum value of SAR (interpolated) = 3.11 W/kg

System Validation /Zoom Scan (7x7x7)/Cube 0: Measurement grid: $dx=5\text{mm}$, $dy=5\text{mm}$, $dz=5\text{mm}$

Reference Value = 63.17 V/m ; Power Drift = 0.1 dB

Peak SAR (extrapolated) = 3.59 W/kg

SAR(1 g) = 2.45 W/kg ; SAR(10 g) = 1.56 W/kg

Maximum value of SAR (measured) = 3.23 W/kg

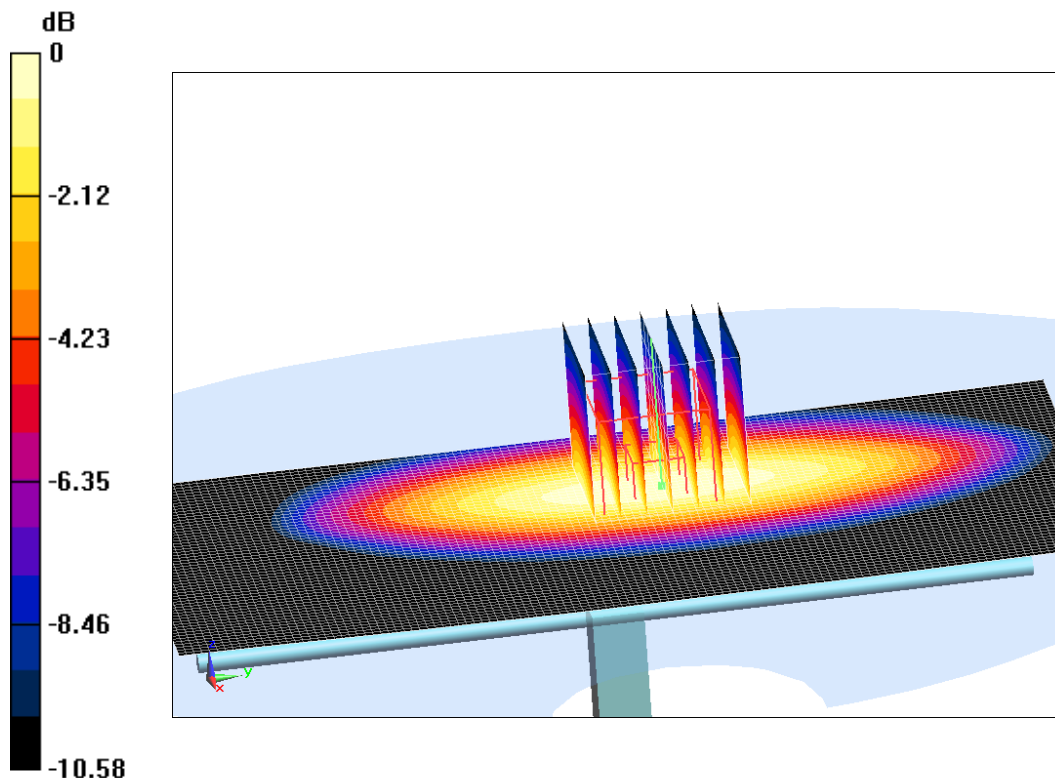

0 dB = $3.23 \text{ W/kg} = 5.09 \text{ dB W/kg}$

Fig.B.2 validation 835 MHz 250mW

1750 MHz

Date: 6/27/2020

Electronics: DAE4 Sn777

Medium: Head 1750 MHz

Medium parameters used: $f = 1750$ MHz; $\sigma = 1.354$ mho/m; $\epsilon_r = 40.2$; $\rho = 1000$ kg/m³

Ambient Temperature: 22.9°C Liquid Temperature: 22.5°C

Communication System: CW Frequency: 1750 MHz Duty Cycle: 1:1

Probe: EX3DV4 – SN3617 ConvF(8.41,8.41,8.41)

System Validation /Area Scan (81x191x1): Interpolated grid: dx=1.000 mm, dy=1.000 mm

Reference Value = 106.22 V/m; Power Drift = 0.01

Fast SAR: SAR(1 g) = 9.32 W/kg; SAR(10 g) = 4.92 W/kg

Maximum value of SAR (interpolated) = 13.82 W/kg

System Validation /Zoom Scan (7x7x7)/Cube 0: Measurement grid: dx=5mm, dy=5mm, dz=5mm

Reference Value = 106.22 V/m; Power Drift = 0.01 dB

Peak SAR (extrapolated) = 16.63 W/kg

SAR(1 g) = 9.12 W/kg; SAR(10 g) = 4.92 W/kg

Maximum value of SAR (measured) = 13.72 W/kg

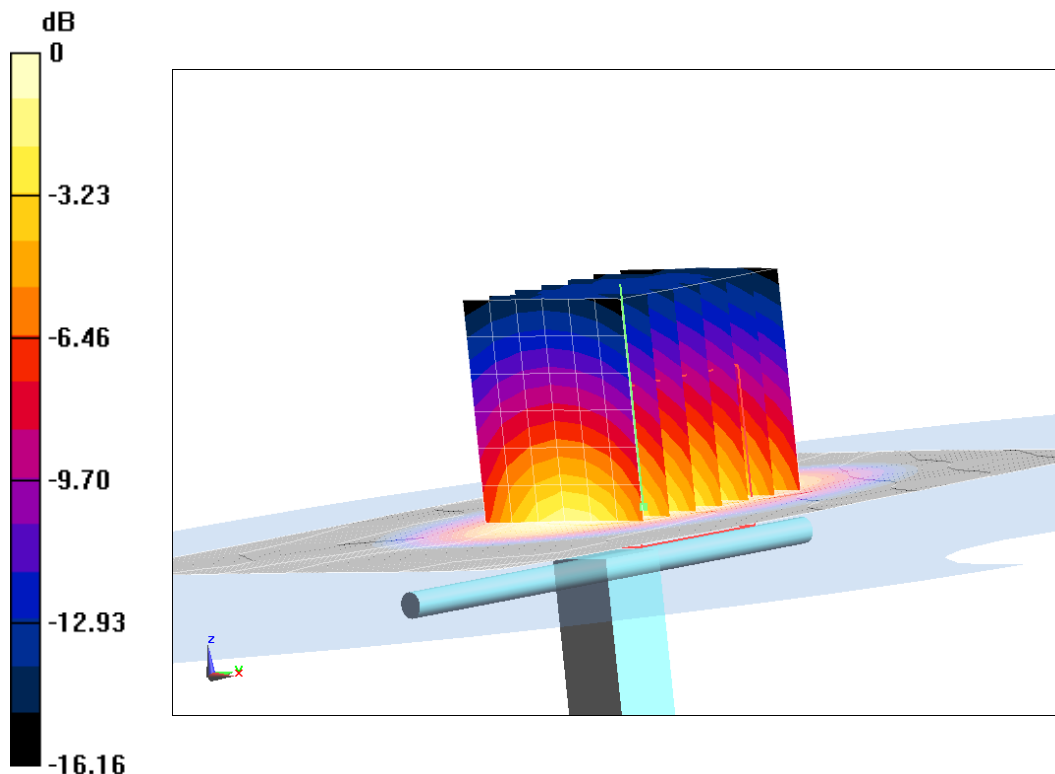

0 dB = 13.72 W/kg = 11.37 dB W/kg

Fig.B.3 validation 1750 MHz 250mW

1900 MHz

Date: 6/28/2020

Electronics: DAE4 Sn777

Medium: Head 1900 MHz

Medium parameters used: $f = 1900$ MHz; $\sigma = 1.411$ mho/m; $\epsilon_r = 39.38$; $\rho = 1000$ kg/m³

Ambient Temperature: 22.9°C Liquid Temperature: 22.5°C

Communication System: CW Frequency: 1900 MHz Duty Cycle: 1:1

Probe: EX3DV4 – SN3617 ConvF(8.14,8.14,8.14)

System Validation /Area Scan (81x191x1): Interpolated grid: dx=1.000 mm, dy=1.000 mm

Reference Value = 107.96 V/m; Power Drift = -0.04

Fast SAR: SAR(1 g) = 9.88 W/kg; SAR(10 g) = 5.27 W/kg

Maximum value of SAR (interpolated) = 15.02 W/kg

System Validation /Zoom Scan (7x7x7)/Cube 0: Measurement grid: dx=5mm, dy=5mm, dz=5mm

Reference Value = 107.96 V/m; Power Drift = -0.04 dB

Peak SAR (extrapolated) = 17.82 W/kg

SAR(1 g) = 10.01 W/kg; SAR(10 g) = 5.18 W/kg

Maximum value of SAR (measured) = 14.99 W/kg

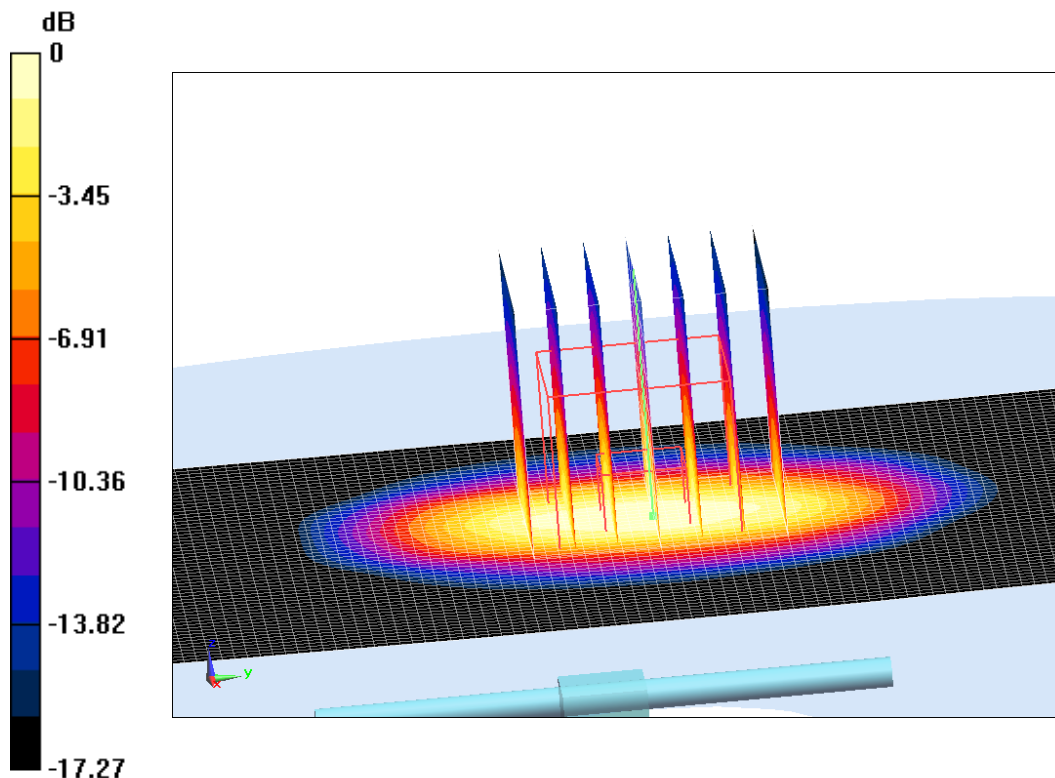

0 dB = 14.99 W/kg = 11.76 dB W/kg

Fig.B.4 validation 1900 MHz 250mW

2450 MHz

Date: 6/29/2020

Electronics: DAE4 Sn777

Medium: Head 2450 MHz

Medium parameters used: $f = 2450$ MHz; $\sigma = 1.818$ mho/m; $\epsilon_r = 39.83$; $\rho = 1000$ kg/m³

Ambient Temperature: 22.9°C Liquid Temperature: 22.5°C

Communication System: CW Frequency: 2450 MHz Duty Cycle: 1:1

Probe: EX3DV4 – SN3617 ConvF(7.65,7.65,7.65)

System Validation /Area Scan (81x191x1): Interpolated grid: dx=1.000 mm, dy=1.000 mm

Reference Value = 116.37 V/m; Power Drift = -0.04

Fast SAR: SAR(1 g) = 13.05 W/kg; SAR(10 g) = 6.07 W/kg

Maximum value of SAR (interpolated) = 21.83 W/kg

System Validation /Zoom Scan (7x7x7)/Cube 0: Measurement grid: dx=5mm, dy=5mm, dz=5mm

Reference Value = 116.37 V/m; Power Drift = -0.04 dB

Peak SAR (extrapolated) = 25.2 W/kg

SAR(1 g) = 12.78 W/kg; SAR(10 g) = 6.12 W/kg

Maximum value of SAR (measured) = 21.15 W/kg

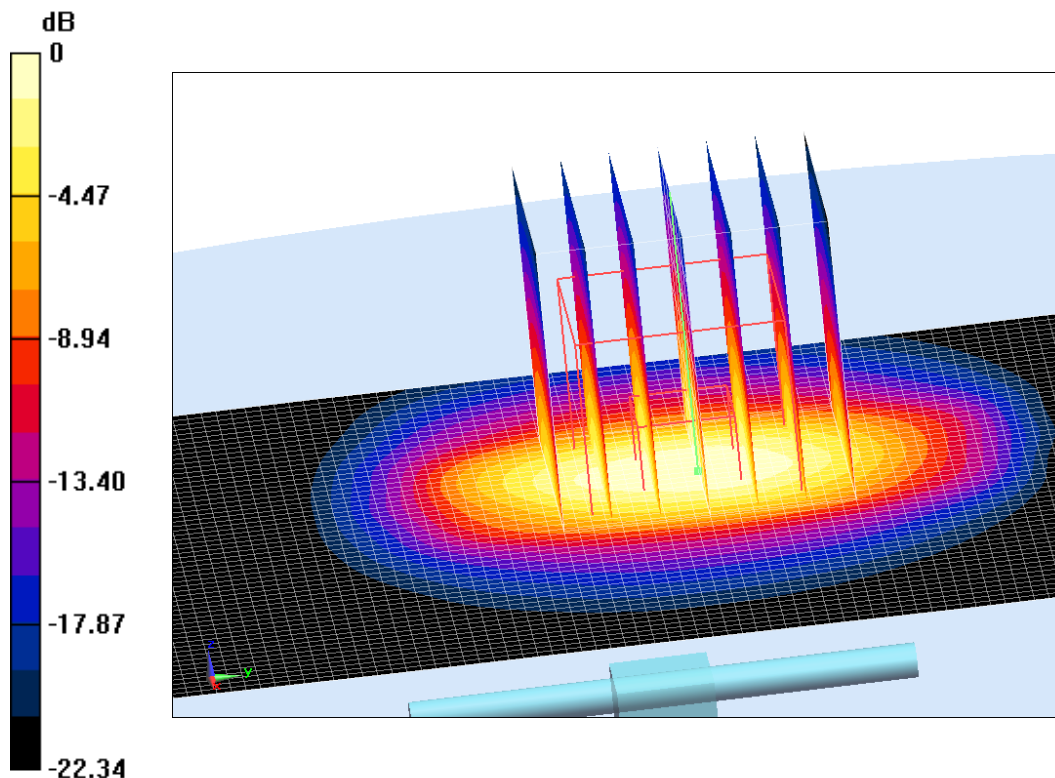

0 dB = 21.15 W/kg = 13.25 dB W/kg

Fig.B.5 validation 2450 MHz 250mW

2600 MHz

Date: 6/30/2020

Electronics: DAE4 Sn777

Medium: Head 2600 MHz

Medium parameters used: $f = 2600$ MHz; $\sigma = 1.956$ mho/m; $\epsilon_r = 39.01$; $\rho = 1000$ kg/m³

Ambient Temperature: 22.9°C Liquid Temperature: 22.5°C

Communication System: CW Frequency: 2600 MHz Duty Cycle: 1:1

Probe: EX3DV4 – SN3617 ConvF(7.52,7.52,7.52)

System Validation /Area Scan (81x191x1): Interpolated grid: dx=1.000 mm, dy=1.000 mm

Reference Value = 120.71 V/m; Power Drift = 0.02

Fast SAR: SAR(1 g) = 13.77 W/kg; SAR(10 g) = 6.15 W/kg

Maximum value of SAR (interpolated) = 24.36 W/kg

System Validation /Zoom Scan (7x7x7)/Cube 0: Measurement grid: dx=5mm, dy=5mm, dz=5mm

Reference Value = 120.71 V/m; Power Drift = 0.02 dB

Peak SAR (extrapolated) = 28.93 W/kg

SAR(1 g) = 13.91 W/kg; SAR(10 g) = 6.29 W/kg

Maximum value of SAR (measured) = 23.56 W/kg

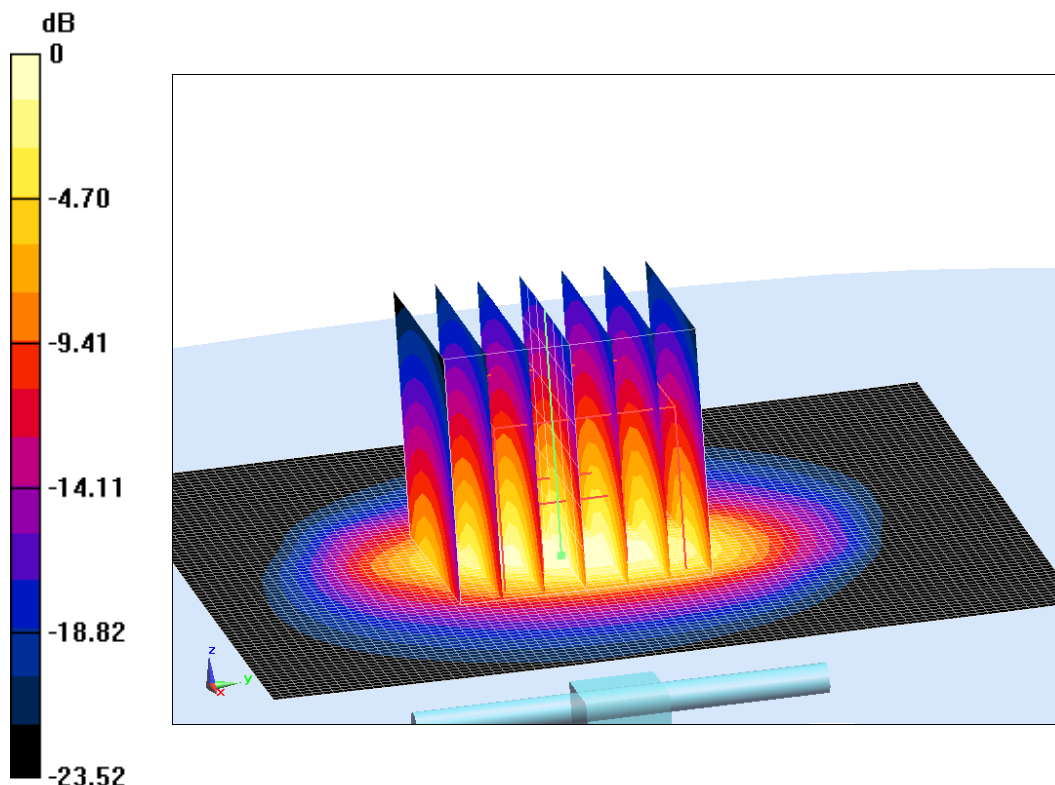

0 dB = 23.56 W/kg = 13.72 dB W/kg

Fig.B.6 validation 2600 MHz 250mW

5250 MHz

Date: 7/1/2020

Electronics: DAE4 Sn777

Medium: Head 5250 MHz

Medium parameters used: $f = 5250$ MHz; $\sigma = 4.729$ mho/m; $\epsilon_r = 36.07$; $\rho = 1000$ kg/m³

Ambient Temperature: 22.9°C Liquid Temperature: 22.5°C

Communication System: CW Frequency: 5250 MHz Duty Cycle: 1:1

Probe: EX3DV4 – SN3617 ConvF(5.39,5.39,5.39)

System Validation /Area Scan (81x191x1): Interpolated grid: dx=1.000 mm, dy=1.000 mm

Reference Value = 75.93 V/m; Power Drift = 0.02

Fast SAR: SAR(1 g) = 19.75 W/kg; SAR(10 g) = 5.86 W/kg

Maximum value of SAR (interpolated) = 17.8 W/kg

System Validation /Zoom Scan (7x7x7)/Cube 0: Measurement grid: dx=5mm, dy=5mm, dz=5mm

Reference Value =75.93 V/m; Power Drift = 0.02 dB

Peak SAR (extrapolated) = 27.55 W/kg

SAR(1 g) = 19.98 W/kg; SAR(10 g) = 5.87 W/kg

Maximum value of SAR (measured) = 18.01 W/kg

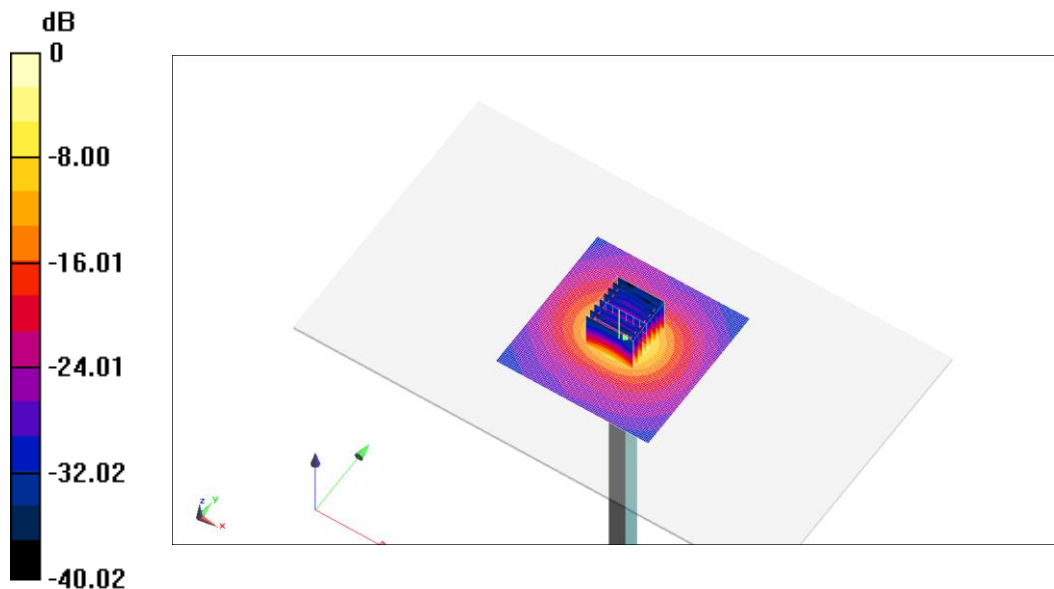

0 dB = 18.01 W/kg = 12.56 dB W/kg

Fig.B.7 validation 5250 MHz 250mW

5600 MHz

Date: 7/2/2020

Electronics: DAE4 Sn777

Medium: Head 5600 MHz

Medium parameters used: $f = 5600$ MHz; $\sigma = 5.153$ mho/m; $\epsilon_r = 35.75$; $\rho = 1000$ kg/m³

Ambient Temperature: 22.9°C Liquid Temperature: 22.5°C

Communication System: CW Frequency: 5600 MHz Duty Cycle: 1:1

Probe: EX3DV4 – SN3617 ConvF(4.99,4.99,4.99)

System Validation /Area Scan (81x191x1): Interpolated grid: dx=1.000 mm, dy=1.000 mm

Reference Value = 75.52 V/m; Power Drift = -0.1

Fast SAR: SAR(1 g) = 21.19 W/kg; SAR(10 g) = 5.91 W/kg

Maximum value of SAR (interpolated) = 19.45 W/kg

System Validation /Zoom Scan (7x7x7)/Cube 0: Measurement grid: dx=5mm, dy=5mm, dz=5mm

Reference Value =75.52 V/m; Power Drift = -0.1 dB

Peak SAR (extrapolated) = 30.47 W/kg

SAR(1 g) = 21.18 W/kg; SAR(10 g) = 6 W/kg

Maximum value of SAR (measured) = 19.58 W/kg

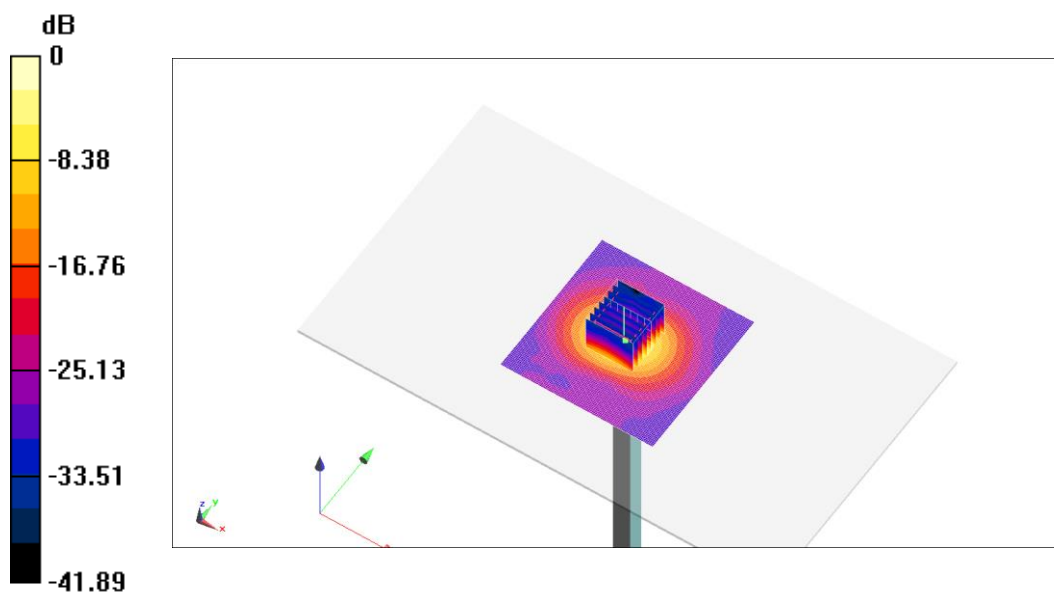

0 dB = 19.58 W/kg = 12.92 dB W/kg

Fig.B.8 validation 5600 MHz 250mW

5750 MHz

Date: 7/3/2020

Electronics: DAE4 Sn777

Medium: Head 5750 MHz

Medium parameters used: $f = 5750$ MHz; $\sigma = 5.201$ mho/m; $\epsilon_r = 35.73$; $\rho = 1000$ kg/m³

Ambient Temperature: 22.9°C Liquid Temperature: 22.5°C

Communication System: CW Frequency: 5750 MHz Duty Cycle: 1:1

Probe: EX3DV4 – SN3617 ConvF(5.1,5.1,5.1)

System Validation /Area Scan (81x191x1): Interpolated grid: dx=1.000 mm, dy=1.000 mm

Reference Value = 72.33 V/m; Power Drift = -0.02

Fast SAR: SAR(1 g) = 20.29 W/kg; SAR(10 g) = 5.81 W/kg

Maximum value of SAR (interpolated) = 19.28 W/kg

System Validation /Zoom Scan (7x7x7)/Cube 0: Measurement grid: dx=5mm, dy=5mm, dz=5mm

Reference Value =72.33 V/m; Power Drift = -0.02 dB

Peak SAR (extrapolated) = 31.37 W/kg

SAR(1 g) = 19.9 W/kg; SAR(10 g) = 5.82 W/kg

Maximum value of SAR (measured) = 18.56 W/kg

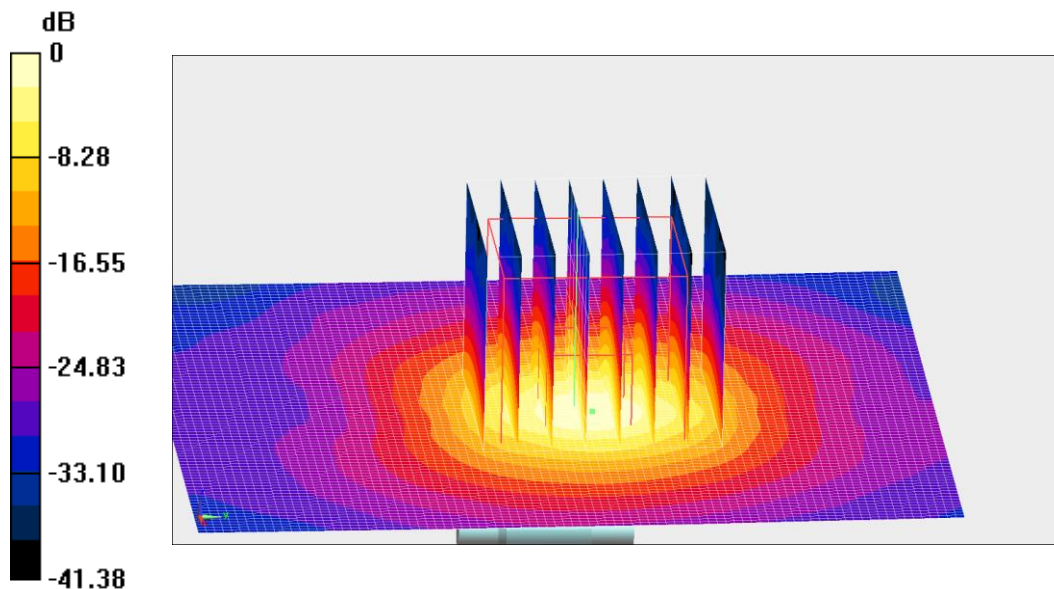

0 dB = 18.56 W/kg = 12.69 dB W/kg

Fig.B.9 validation 5750 MHz 250mW

The SAR system verification must be required that the area scan estimated 1-g SAR is within 3% of the zoom scan 1-g SAR.

Table B.1 Comparison between area scan and zoom scan for system verification

Band	Mode	Area scan (1g)	Zoom scan (1g)	Drift (%)
750MHz	Body	2.12	2.18	-2.75
835 MHz	Body	2.39	2.45	-2.45
1750 MHz	Body	9.32	9.12	2.19
1900MHz	Body	9.88	10.01	-1.30
2450MHz	Body	13.05	12.78	2.11
2600MHz	Body	13.77	13.91	-1.01

ANNEX C SAR Measurement Setup

C.1 Measurement Set-up

The Dasy4 or DASY5 system for performing compliance tests is illustrated above graphically. This system consists of the following items:

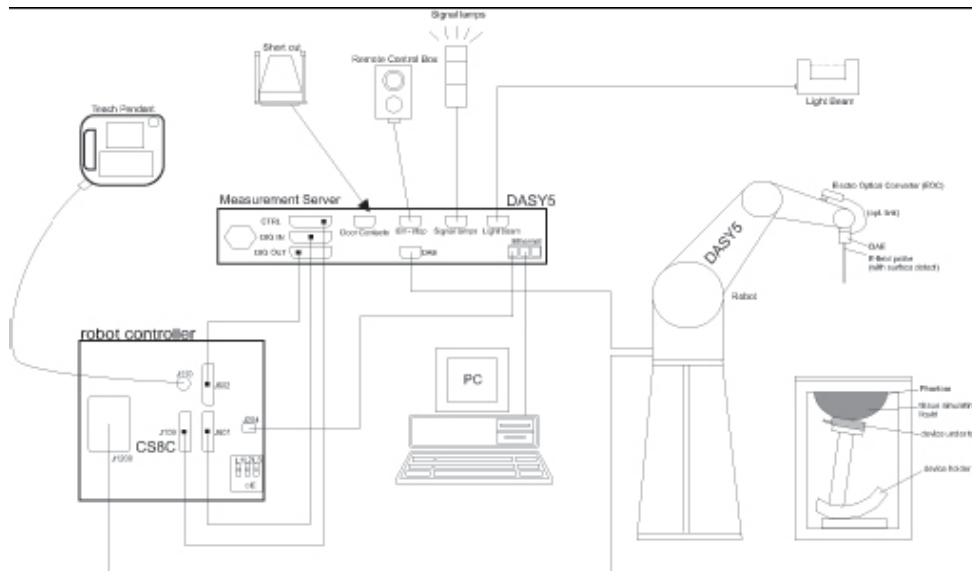

Picture C.1 SAR Lab Test Measurement Set-up

- A standard high precision 6-axis robot (Stäubli TX=RX family) with controller, teach pendant and software. An arm extension for accommodating the data acquisition electronics (DAE).
- An isotropic field probe optimized and calibrated for the targeted measurement.
- A data acquisition electronics (DAE) which performs the signal amplification, signal multiplexing, AD-conversion, offset measurements, mechanical surface detection, collision detection, etc. The unit is battery powered with standard or rechargeable batteries. The signal is optically transmitted to the EOC.
- The Electro-optical converter (EOC) performs the conversion from optical to electrical signals for the digital communication to the DAE. To use optical surface detection, a special version of the EOC is required. The EOC signal is transmitted to the measurement server.
- The function of the measurement server is to perform the time critical tasks such as signal filtering, control of the robot operation and fast movement interrupts.
- The Light Beam used is for probe alignment. This improves the (absolute) accuracy of the probe positioning.
- A computer running WinXP and the DASY4 or DASY5 software.
- Remote control and teach pendant as well as additional circuitry for robot safety such as warning lamps, etc.
- The phantom, the device holder and other accessories according to the targeted measurement.

C.2 Dasy4 or DASY5 E-field Probe System

The SAR measurements were conducted with the dosimetric probe designed in the classical triangular configuration and optimized for dosimetric evaluation. The probe is constructed using the thick film technique; with printed resistive lines on ceramic substrates. The probe is equipped with an optical multifiber line ending at the front of the probe tip. It is connected to the EOC box on the robot arm and provides an automatic detection of the phantom surface. Half of the fibers are connected to a pulsed infrared transmitter, the other half to a synchronized receiver. As the probe approaches the surface, the reflection from the surface produces a coupling from the transmitting to the receiving fibers. This reflection increases first during the approach, reaches maximum and then decreases. If the probe is flatly touching the surface, the coupling is zero. The distance of the coupling maximum to the surface is independent of the surface reflectivity and largely independent of the surface to probe angle. The DASY4 or DASY5 software reads the reflection during a software approach and looks for the maximum using 2nd ord curve fitting. The approach is stopped at reaching the maximum.

Probe Specifications:

Model:	ES3DV3, EX3DV4
Frequency	10MHz — 6.0GHz(EX3DV4)
Range:	10MHz — 4GHz(ES3DV3)
Calibration:	In head and body simulating tissue at Frequencies from 835 up to 5800MHz
Linearity:	± 0.2 dB(30 MHz to 6 GHz) for EX3DV4 ± 0.2 dB(30 MHz to 4 GHz) for ES3DV3
Dynamic Range:	10 mW/kg — 100W/kg
Probe Length:	330 mm
Probe Tip	
Length:	20 mm
Body Diameter:	12 mm
Tip Diameter:	2.5 mm (3.9 mm for ES3DV3)
Tip-Center:	1 mm (2.0mm for ES3DV3)
Application:	SAR Dosimetry Testing Compliance tests of mobile phones Dosimetry in strong gradient fields



Picture C.2 Near-field Probe



Picture C.3 E-field Probe

C.3 E-field Probe Calibration

Each E-Probe/Probe Amplifier combination has unique calibration parameters. A TEM cell calibration procedure is conducted to determine the proper amplifier settings to enter in the probe parameters. The amplifier settings are determined for a given frequency by subjecting the probe to a known E-field density (1 mW/cm²) using an RF Signal generator, TEM cell, and RF Power Meter.

The free space E-field from amplified probe outputs is determined in a test chamber. This calibration can be performed in a TEM cell if the frequency is below 1 GHz and in a waveguide or other methodologies above 1 GHz for free space. For the free space calibration, the probe is placed in the volumetric center of the cavity and at the proper orientation with the field. The probe is then rotated 360 degrees until the three channels show the maximum reading. The power density readings equates to 1 mW/ cm².

E-field temperature correlation calibration is performed in a flat phantom filled with the appropriate simulated brain tissue. The E-field in the medium correlates with the temperature rise in the dielectric medium. For temperature correlation calibration a RF transparent thermistor-based temperature probe is used in conjunction with the E-field probe.

$$SAR = C \frac{\Delta T}{\Delta t}$$

Where:

Δt = Exposure time (30 seconds),

C = Heat capacity of tissue (brain or muscle),

ΔT = Temperature increase due to RF exposure.

$$SAR = \frac{|E|^2 \cdot \sigma}{\rho}$$

Where:

σ = Simulated tissue conductivity,

ρ = Tissue density (kg/m³).

C.4 Other Test Equipment

C.4.1 Data Acquisition Electronics(DAE)

The data acquisition electronics consist of a highly sensitive electrometer-grade preamplifier with auto-zeroing, a channel and gain-switching multiplexer, a fast 16 bit AD-converter and a command decoder with a control logic unit. Transmission to the measurement server is accomplished through an optical downlink for data and status information, as well as an optical uplink for commands and the clock.

The mechanical probe mounting device includes two different sensor systems for frontal and sideways probe contacts. They are used for mechanical surface detection and probe collision detection.

The input impedance of the DAE is 200 MOhm; the inputs are symmetrical and floating. Common mode rejection is above 80 dB.



PictureC.4: DAE

C.4.2 Robot

The SPEAG DASY system uses the high precision robots (DASY4: RX90XL; DASY5: RX160L) type from Stäubli SA (France). For the 6-axis controller system, the robot controller version from Stäubli is used. The Stäubli robot series have many features that are important for our application:

- High precision (repeatability 0.02mm)
- High reliability (industrial design)
- Low maintenance costs (virtually maintenance free due to direct drive gears; no belt drives)
- Jerk-free straight movements (brushless synchron motors; no stepper motors)
- Low ELF interference (motor control fields shielded via the closed metallic construction shields)



Picture C.5 DASY 4



Picture C.6 DASY 5

C.4.3 Measurement Server

The Measurement server is based on a PC/104 CPU board with CPU (dasy4: 166 MHz, Intel Pentium; DASY5: 400 MHz, Intel Celeron), chipdisk (DASY4: 32 MB; DASY5: 128MB), RAM (DASY4: 64 MB, DASY5: 128MB). The necessary circuits for communication with the DAE electronic box, as well as the 16 bit AD converter system for optical detection and digital I/O interface are contained on the DASY I/O board, which is directly connected to the PC/104 bus of the CPU board.

The measurement server performs all real-time data evaluation of field measurements and surface detection, controls robot movements and handles safety operation. The PC operating system cannot interfere with these time critical processes. All connections are supervised by a watchdog, and

disconnection of any of the cables to the measurement server will automatically disarm the robot and disable all program-controlled robot movements. Furthermore, the measurement server is equipped with an expansion port which is reserved for future applications. Please note that this expansion port does not have a standardized pinout, and therefore only devices provided by SPEAG can be connected. Devices from any other supplier could seriously damage the measurement server.



Picture C.7 Server for DASY 4



Picture C.8 Server for DASY 5

C.4.4 Device Holder for Phantom

The SAR in the phantom is approximately inversely proportional to the square of the distance between the source and the liquid surface. For a source at 5mm distance, a positioning uncertainty of $\pm 0.5\text{mm}$ would produce a SAR uncertainty of $\pm 20\%$. Accurate device positioning is therefore crucial for accurate and repeatable measurements. The positions in which the devices must be measured are defined by the standards.

The DASY device holder is designed to cope with the different positions given in the standard. It has two scales for device rotation (with respect to the body axis) and device inclination (with respect to the line between the ear reference points). The rotation centers for both scales is the ear reference point (ERP). Thus the device needs no repositioning when changing the angles.

The DASY device holder is constructed of low-loss

POM material having the following dielectric parameters: relative permittivity $\epsilon = 3$ and loss tangent $\delta = 0.02$.

The amount of dielectric material has been reduced in the closest vicinity of the device, since measurements have suggested that the influence of the clamp on the test results could thus be lowered.

<Laptop Extension Kit>

The extension is lightweight and made of POM, acrylic glass and foam. It fits easily on the upper part of the Mounting Device in place of the phone positioner. The extension is fully compatible with the Twin-SAM and ELI phantoms.



Picture C.9-1: Device Holder

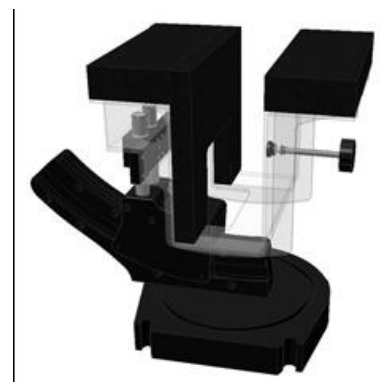

Picture C.9-2: Laptop Extension Kit

C.4.5 Phantom

The SAM Twin Phantom V4.0 is constructed of a fiberglass shell integrated in a table. The shape of the shell is based on data from an anatomical study designed to represent the 90th percentile of the population. The phantom enables the dissymmetric evaluation of SAR for both left and right handed handset usage, as well as body-worn usage using the flat phantom region. Reference markings on the Phantom allow the complete setup of all predefined phantom positions and measurement grids by manually teaching three points in the robot. The shell phantom has a 2mm shell thickness (except the ear region where shell thickness increases to 6 mm).

Shell Thickness: 2 ± 0.2 mm

Filling Volume: Approx. 25 liters

Dimensions: 810 x 1000 x 500 mm (H x L x W)

Available: Special



Picture C.10: SAM Twin Phantom

ANNEX D Position of the wireless device in relation to the phantom

D.1 General considerations

This standard specifies two handset test positions against the head phantom – the “cheek” position and the “tilt” position.

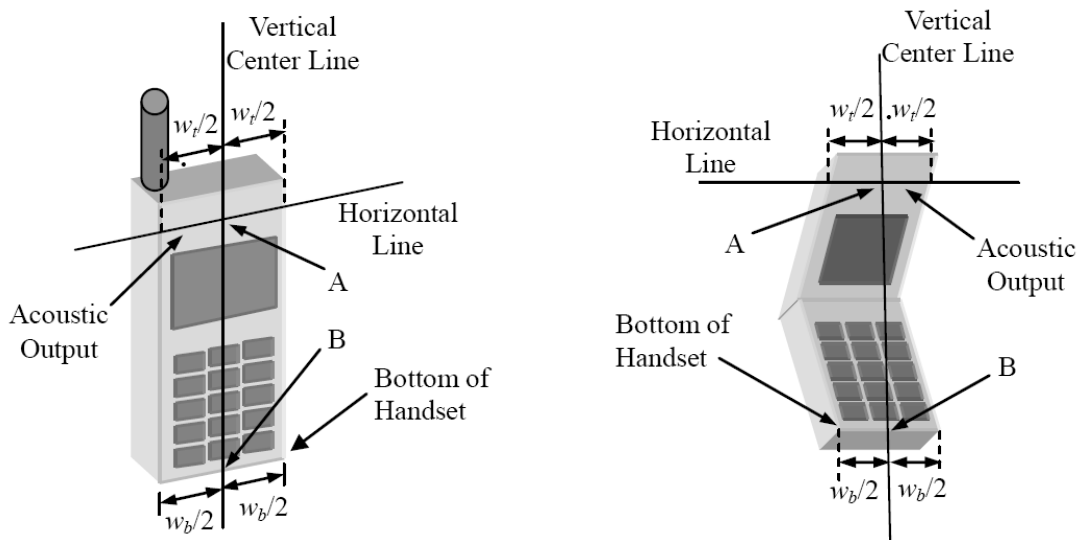

- w_t Width of the handset at the level of the acoustic
- w_b Width of the bottom of the handset
- A Midpoint of the width w_t of the handset at the level of the acoustic output
- B Midpoint of the width w_b of the bottom of the handset

Picture D.1-a Typical “fixed” case handset Picture D.1-b Typical “clam-shell” case handset

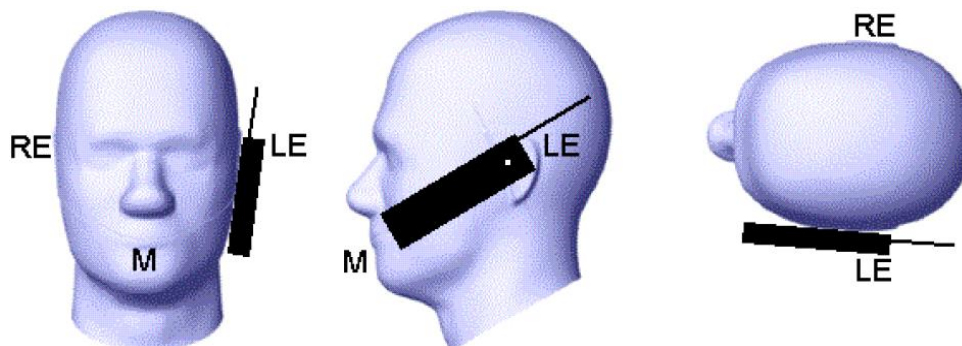

Picture D.2 Cheek position of the wireless device on the left side of SAM

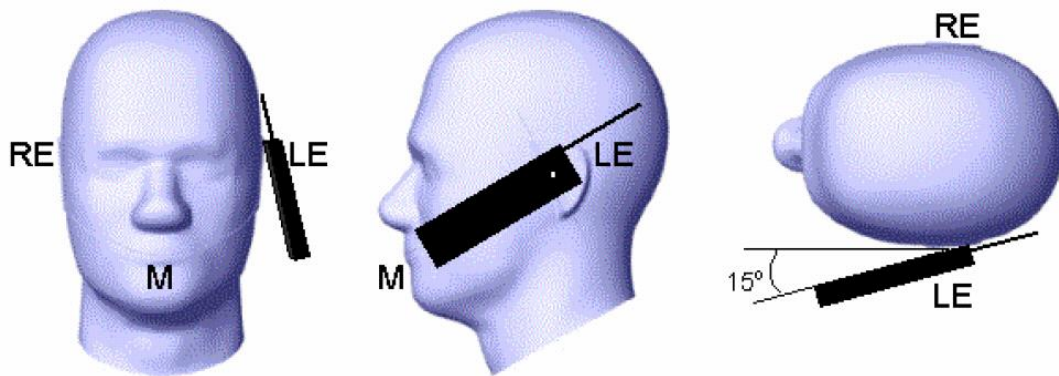

Picture D.3 Tilt position of the wireless device on the left side of SAM

D.2 Body-worn device

A typical example of a body-worn device is a mobile phone, wireless enabled PDA or other battery operated wireless device with the ability to transmit while mounted on a person's body using a carry accessory approved by the wireless device manufacturer.

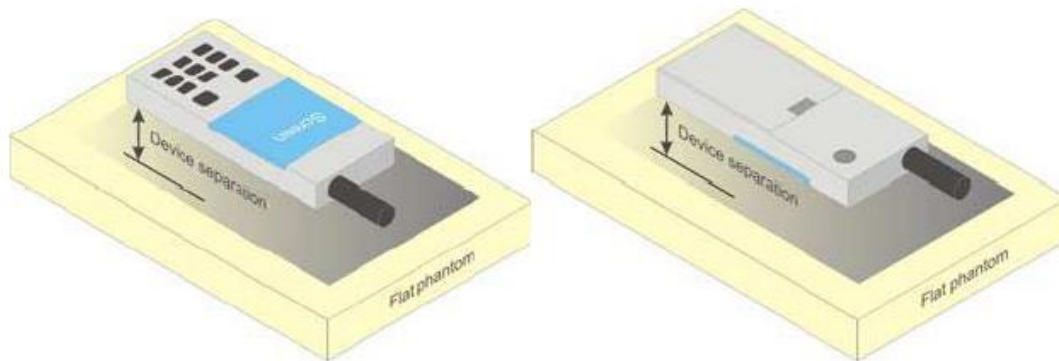

Picture D.4 Test positions for body-worn devices

D.3 Desktop device

A typical example of a desktop device is a wireless enabled desktop computer placed on a table or desk when used.

The DUT shall be positioned at the distance and in the orientation to the phantom that corresponds to the intended use as specified by the manufacturer in the user instructions. For devices that employ an external antenna with variable positions, tests shall be performed for all antenna positions specified. Picture 8.5 show positions for desktop device SAR tests. If the intended use is not specified, the device shall be tested directly against the flat phantom.

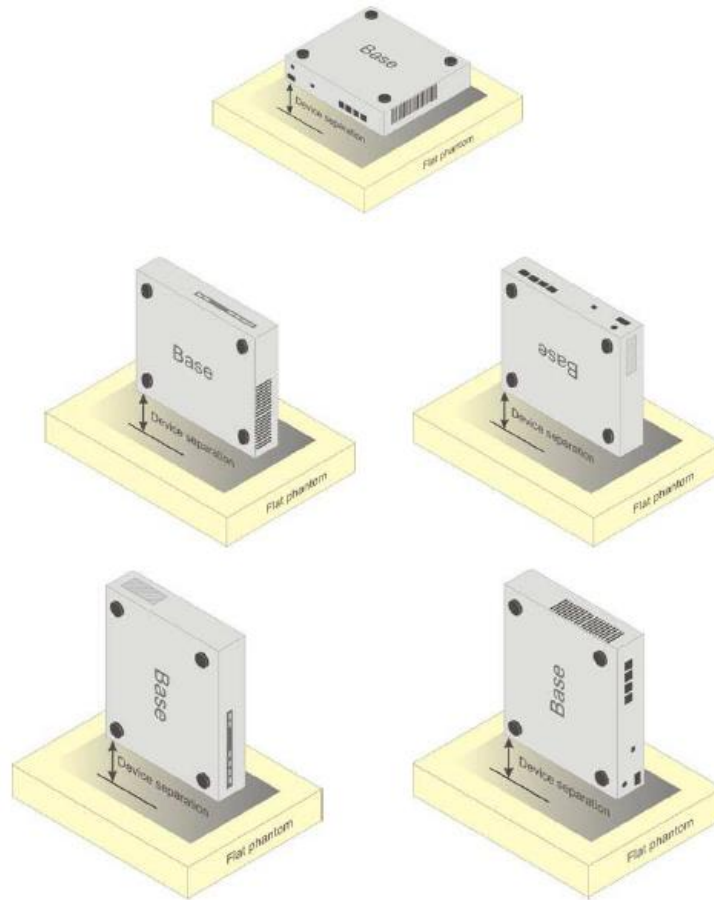

Picture D.5 Test positions for desktop devices

D.4 DUT Setup Photos



Picture D.6

ANNEX E Equivalent Media Recipes

The liquid used for the frequency range of 800-3000 MHz consisted of water, sugar, salt, preventol, glycol monobutyl and Cellulose. The liquid has been previously proven to be suited for worst-case. The Table E.1 shows the detail solution. It's satisfying the latest tissue dielectric parameters requirements proposed by the IEEE 1528 and IEC 62209.

Table E.1: Composition of the Tissue Equivalent Matter

Frequency (MHz)	835 Head	835 Body	1900 Head	1900 Body	2450 Head	2450 Body	5800 Head	5800 Body
Ingredients (% by weight)								
Water	41.45	52.5	55.242	69.91	58.79	72.60	65.53	65.53
Sugar	56.0	45.0	\	\	\	\	\	\
Salt	1.45	1.4	0.306	0.13	0.06	0.18	\	\
Preventol	0.1	0.1	\	\	\	\	\	\
Cellulose	1.0	1.0	\	\	\	\	\	\
Glycol Monobutyl	\	\	44.452	29.96	41.15	27.22	\	\
Diethylenglycol monohexylether	\	\	\	\	\	\	17.24	17.24
Triton X-100	\	\	\	\	\	\	17.24	17.24
Dielectric Parameters Target Value	$\epsilon=41.5$ $\sigma=0.90$	$\epsilon=55.2$ $\sigma=0.97$	$\epsilon=40.0$ $\sigma=1.40$	$\epsilon=53.3$ $\sigma=1.52$	$\epsilon=39.2$ $\sigma=1.80$	$\epsilon=52.7$ $\sigma=1.95$	$\epsilon=35.3$ $\sigma=5.27$	$\epsilon=48.2$ $\sigma=6.00$

Note: There are a little adjustment respectively for 750, 1750, 2600, 5200, 5300 and 5600 based on the recipe of closest frequency in table E.1.

ANNEX F System Validation

The SAR system must be validated against its performance specifications before it is deployed. When SAR probes, system components or software are changed, upgraded or recalibrated, these must be validated with the SAR system(s) that operates with such components.

Table F.1: System Validation for 3617

Probe SN.	Liquid name	Validation date	Frequency point	Status (OK or Not)
3617	Head 750MHz	January 30,2020	750 MHz	OK
3617	Head 850MHz	January 30,2020	835 MHz	OK
3617	Head 900MHz	January 30,2020	900 MHz	OK
3617	Head 1750MHz	January 30,2020	1750 MHz	OK
3617	Head 1810MHz	January 30,2020	1810 MHz	OK
3617	Head 1900MHz	January 30,2020	1900 MHz	OK
3617	Head 2000MHz	January 30,2020	2000 MHz	OK
3617	Head 2100MHz	January 30,2020	2100 MHz	OK
3617	Head 2300MHz	January 30,2020	2300 MHz	OK
3617	Head 2450MHz	January 30,2020	2450 MHz	OK
3617	Head 2600MHz	January 30,2020	2600 MHz	OK
3617	Head 3500MHz	January 30,2020	3500 MHz	OK
3617	Head 3700MHz	January 30,2020	3700 MHz	OK
3617	Head 5200MHz	January 30,2020	5250 MHz	OK
3617	Head 5500MHz	January 30,2020	5600 MHz	OK
3617	Head 5800MHz	January 30,2020	5800 MHz	OK
3617	Body 750MHz	January 30,2020	750 MHz	OK
3617	Body 850MHz	January 30,2020	835 MHz	OK
3617	Body 900MHz	January 30,2020	900 MHz	OK
3617	Body 1750MHz	January 30,2020	1750 MHz	OK
3617	Body 1810MHz	January 30,2020	1810 MHz	OK
3617	Body 1900MHz	January 30,2020	1900 MHz	OK
3617	Body 2000MHz	January 30,2020	2000 MHz	OK
3617	Body 2100MHz	January 30,2020	2100 MHz	OK
3617	Body 2300MHz	January 30,2020	2300 MHz	OK
3617	Body 2450MHz	January 30,2020	2450 MHz	OK
3617	Body 2600MHz	January 30,2020	2600 MHz	OK
3617	Body 3500MHz	January 30,2020	3500 MHz	OK
3617	Body 3700MHz	January 30,2020	3700 MHz	OK
3617	Body 5200MHz	January 30,2020	5250 MHz	OK
3617	Body 5500MHz	January 30,2020	5600 MHz	OK
3617	Body 5800MHz	January 30,2020	5800 MHz	OK

ANNEX G Probe Calibration Certificate

Probe 3617 Calibration Certificate

**Calibration Laboratory of
Schmid & Partner
Engineering AG**
 Zeughausstrasse 43, 8004 Zurich, Switzerland



S Schweizerischer Kalibrierdienst
C Service suisse d'étalonnage
S Servizio svizzero di taratura
S Swiss Calibration Service

Accredited by the Swiss Accreditation Service (SAS)
 The Swiss Accreditation Service is one of the signatories to the EA
 Multilateral Agreement for the recognition of calibration certificates

Accreditation No.: SCS 0108

Client **CTTL (Auden)**

Certificate No: EX3-3617_Jan20/2

CALIBRATION CERTIFICATE (Replacement of No: EX3-3617_Jan20)

Object: **EX3DV4 - SN:3617**
 Calibration procedure(s): **QA CAL-01.v9, QA CAL-12.v9, QA CAL-14.v5, QA CAL-23.v5,
QA CAL-25.v7
Calibration procedure for dosimetric E-field probes**
 Calibration date: **January 30, 2020**

This calibration certificate documents the traceability to national standards, which realize the physical units of measurements (SI).
 The measurements and the uncertainties with confidence probability are given on the following pages and are part of the certificate.

All calibrations have been conducted in the closed laboratory facility: environment temperature (22 ± 3)°C and humidity < 70%.

Calibration Equipment used (M&TE critical for calibration)

Primary Standards	ID	Cal Date (Certificate No.)	Scheduled Calibration
Power meter NRP	SN: 104776	03-Apr-19 (No. 217-02892/02893)	Apr-20
Power sensor NRP-Z91	SN: 103244	03-Apr-19 (No. 217-02892)	Apr-20
Power sensor NRP-Z91	SN: 103245	03-Apr-19 (No. 217-02893)	Apr-20
Reference 20 dB Attenuator	SN: 55277 (20x)	04-Apr-19 (No. 217-02894)	Apr-20
DAE4	SN: 660	27-Dec-19 (No. DAE4-660, Dec19)	Dec-20
Reference Probe ES3DV2	SN: 3013	31-Dec-19 (No. ES3-3013, Dec19)	Dec-20
Secondary Standards	ID	Check Date (in house)	Scheduled Check
Power meter E4419B	SN: GB41293874	06-Apr-16 (in house check Jun-16)	In house check: Jun-20
Power sensor E4412A	SN: MY41496067	06-Apr-16 (in house check Jun-16)	In house check: Jun-20
Power sensor E4412A	SN: 000110210	06-Apr-16 (in house check Jun-16)	In house check: Jun-20
RF generator HP 8648C	SN: US3642U01700	04-Aug-99 (in house check Jun-16)	In house check: Jun-20
Network Analyzer E8358A	SN: US41090477	31-Mar-14 (in house check Oct-19)	In house check: Oct-20

Calibrated by: **Name: Claudio Leubler, Function: Laboratory Technician, Signature: [Signature]**
 Approved by: **Name: Katja Pokovic, Function: Technical Manager, Signature: [Signature]**
 Issued: April 7, 2020

This calibration certificate shall not be reproduced except in full without written approval of the laboratory.

Calibration Laboratory of
Schmid & Partner
Engineering AG
Zeughausstrasse 43, 8004 Zurich, Switzerland



S Schweizerischer Kalibrierdienst
C Service suisse d'étalonnage
S Servizio svizzero di taratura
S Swiss Calibration Service

Accredited by the Swiss Accreditation Service (SAS)
The Swiss Accreditation Service is one of the signatories to the EA
Multilateral Agreement for the recognition of calibration certificates

Accreditation No.: SCS 0108

Glossary:

TSL	tissue simulating liquid
NORM _{x,y,z}	sensitivity in free space
ConvF	sensitivity in TSL / NORM _{x,y,z}
DCP	diode compression point
CF	crest factor (1/duty_cycle) of the RF signal
A, B, C, D	modulation dependent linearization parameters
Polarization φ	φ rotation around probe axis
Polarization ϑ	ϑ rotation around an axis that is in the plane normal to probe axis (at measurement center), i.e., $\vartheta = 0$ is normal to probe axis
Connector Angle	information used in DASY system to align probe sensor X to the robot coordinate system

Calibration is Performed According to the Following Standards:

- IEEE Std 1528-2013, "IEEE Recommended Practice for Determining the Peak Spatial-Averaged Specific Absorption Rate (SAR) in the Human Head from Wireless Communications Devices: Measurement Techniques", June 2013
- IEC 62209-1, "Measurement procedure for the assessment of Specific Absorption Rate (SAR) from hand-held and body-mounted devices used next to the ear (frequency range of 300 MHz to 6 GHz)", July 2016
- IEC 62209-2, "Procedure to determine the Specific Absorption Rate (SAR) for wireless communication devices used in close proximity to the human body (frequency range of 30 MHz to 6 GHz)", March 2010
- KDB 865664, "SAR Measurement Requirements for 100 MHz to 6 GHz"

Methods Applied and Interpretation of Parameters:

- NORM_{x,y,z}: Assessed for E-field polarization $\vartheta = 0$ ($f \leq 900$ MHz in TEM-cell; $f > 1800$ MHz: R22 waveguide). NORM_{x,y,z} are only intermediate values, i.e., the uncertainties of NORM_{x,y,z} does not affect the E²-field uncertainty inside TSL (see below ConvF).
- NORM(f)_{x,y,z} = NORM_{x,y,z} * frequency_response (see Frequency Response Chart). This linearization is implemented in DASY4 software versions later than 4.2. The uncertainty of the frequency response is included in the stated uncertainty of ConvF.
- DCP_{x,y,z}: DCP are numerical linearization parameters assessed based on the data of power sweep with CW signal (no uncertainty required). DCP does not depend on frequency nor media.
- PAR: PAR is the Peak to Average Ratio that is not calibrated but determined based on the signal characteristics
- A_{x,y,z}; B_{x,y,z}; C_{x,y,z}; D_{x,y,z}; VR_{x,y,z}: A, B, C, D are numerical linearization parameters assessed based on the data of power sweep for specific modulation signal. The parameters do not depend on frequency nor media. VR is the maximum calibration range expressed in RMS voltage across the diode.
- ConvF and Boundary Effect Parameters: Assessed in flat phantom using E-field (or Temperature Transfer Standard for $f \leq 800$ MHz) and inside waveguide using analytical field distributions based on power measurements for $f > 800$ MHz. The same setups are used for assessment of the parameters applied for boundary compensation (alpha, depth) of which typical uncertainty values are given. These parameters are used in DASY4 software to improve probe accuracy close to the boundary. The sensitivity in TSL corresponds to NORM_{x,y,z} * ConvF whereby the uncertainty corresponds to that given for ConvF. A frequency dependent ConvF is used in DASY version 4.4 and higher which allows extending the validity from ± 50 MHz to ± 100 MHz.
- Spherical isotropy (3D deviation from isotropy): in a field of low gradients realized using a flat phantom exposed by a patch antenna.
- Sensor Offset: The sensor offset corresponds to the offset of virtual measurement center from the probe tip (on probe axis). No tolerance required.
- Connector Angle: The angle is assessed using the information gained by determining the NORM_x (no uncertainty required).

EX3DV4 – SN:3617

January 30, 2020

DASY/EASY - Parameters of Probe: EX3DV4 - SN:3617

Basic Calibration Parameters

	Sensor X	Sensor Y	Sensor Z	Unc (k=2)
Norm ($\mu\text{V}/(\text{V}/\text{m})^2$) ^A	0.35	0.21	0.32	$\pm 10.1\%$
DCP (mV) ^B	104.3	93.8	97.1	

Calibration Results for Modulation Response

UID	Communication System Name		A dB	B dB- μV	C	D dB	VR mV	Max dev.	Max Unc ^E (k=2)
0	CW	X	0.00	0.00	1.00	0.00	130.5	$\pm 3.5\%$	$\pm 4.7\%$
		Y	0.00	0.00	1.00		137.4		
		Z	0.00	0.00	1.00		129.2		
10352-AAA	Pulse Waveform (200Hz, 10%)	X	5.74	74.31	15.16	10.00	60.0	$\pm 2.6\%$	$\pm 9.6\%$
		Y	20.00	84.63	18.23		60.0		
		Z	20.00	90.64	20.98		60.0		
10353-AAA	Pulse Waveform (200Hz, 20%)	X	11.18	82.57	16.62	6.99	80.0	$\pm 1.6\%$	$\pm 9.6\%$
		Y	11.60	81.13	15.97		80.0		
		Z	20.00	91.54	20.06		80.0		
10354-AAA	Pulse Waveform (200Hz, 40%)	X	20.00	88.75	16.93	3.98	95.0	$\pm 1.0\%$	$\pm 9.6\%$
		Y	1.22	84.13	8.17		95.0		
		Z	20.00	94.77	20.04		95.0		
10355-AAA	Pulse Waveform (200Hz, 60%)	X	20.00	90.94	16.71	2.22	120.0	$\pm 1.3\%$	$\pm 9.6\%$
		Y	0.41	60.00	4.32		120.0		
		Z	20.00	99.77	20.92		120.0		
10387-AAA	QPSK Waveform, 1 MHz	X	0.73	63.23	9.65	0.00	150.0	$\pm 4.1\%$	$\pm 9.6\%$
		Y	0.47	60.00	5.82		150.0		
		Z	0.73	63.00	9.63		150.0		
10388-AAA	QPSK Waveform, 10 MHz	X	2.46	70.66	17.17	0.00	150.0	$\pm 1.7\%$	$\pm 9.6\%$
		Y	2.10	68.37	15.67		150.0		
		Z	2.46	70.34	17.05		150.0		
10396-AAA	64-QAM Waveform, 100 kHz	X	3.34	72.82	19.20	3.01	150.0	$\pm 1.6\%$	$\pm 9.6\%$
		Y	3.57	72.45	19.52		150.0		
		Z	3.45	73.00	19.94		150.0		
10399-AAA	64-QAM Waveform, 40 MHz	X	3.61	68.21	16.41	0.00	150.0	$\pm 3.8\%$	$\pm 9.6\%$
		Y	3.40	67.13	15.82		150.0		
		Z	3.62	68.06	16.39		150.0		
10414-AAA	WLAN CCDF, 64-QAM, 40MHz	X	4.88	66.26	15.89	0.00	150.0	$\pm 6.6\%$	$\pm 9.6\%$
		Y	4.57	64.95	15.35		150.0		
		Z	4.92	66.18	15.92		150.0		

Note: For details on UID parameters see Appendix

The reported uncertainty of measurement is stated as the standard uncertainty of measurement multiplied by the coverage factor $k=2$, which for a normal distribution corresponds to a coverage probability of approximately 95%.

^A The uncertainties of Norm X,Y,Z do not affect the E^2 -field uncertainty inside TSL (see Pages 5 and 6).

^B Numerical linearization parameter: uncertainty not required.

^E Uncertainty is determined using the max. deviation from linear response applying rectangular distribution and is expressed for the square of the field value.



EX3DV4- SN:3617

January 30, 2020

DASY/EASY - Parameters of Probe: EX3DV4 - SN:3617**Sensor Model Parameters**

	C1 fF	C2 fF	α V ⁻¹	T1 ms.V ⁻²	T2 ms.V ⁻¹	T3 ms	T4 V ⁻²	T5 V ⁻¹	T6
X	41.2	299.64	34.06	12.13	0.82	5.00	1.88	0.20	1.00
Y	42.0	334.64	39.96	9.91	1.46	5.06	0.00	0.82	1.01
Z	42.8	318.14	35.45	11.95	0.73	5.04	1.02	0.40	1.01

Other Probe Parameters

Sensor Arrangement	Triangular
Connector Angle (°)	13
Mechanical Surface Detection Mode	enabled
Optical Surface Detection Mode	disabled
Probe Overall Length	337 mm
Probe Body Diameter	10 mm
Tip Length	9 mm
Tip Diameter	2.5 mm
Probe Tip to Sensor X Calibration Point	1 mm
Probe Tip to Sensor Y Calibration Point	1 mm
Probe Tip to Sensor Z Calibration Point	1 mm
Recommended Measurement Distance from Surface	1.4 mm

EX3DV4- SN:3617

January 30, 2020

DASY/EASY - Parameters of Probe: EX3DV4 - SN:3617

Calibration Parameter Determined in Head Tissue Simulating Media

f (MHz) ^C	Relative Permittivity ^F	Conductivity (S/m) ^F	ConvF X	ConvF Y	ConvF Z	Alpha ^G	Depth (mm) ^G	Unc (k=2)
64	54.2	0.75	12.37	12.37	12.37	0.00	1.00	± 13.3 %
150	52.3	0.76	11.63	11.63	11.63	0.00	1.00	± 13.3 %
300	45.3	0.87	11.41	11.41	11.41	0.08	1.20	± 13.3 %
450	43.5	0.87	10.84	10.84	10.84	0.12	1.40	± 13.3 %
750	41.9	0.89	10.07	10.07	10.07	0.61	0.80	± 12.0 %
835	41.5	0.90	9.66	9.66	9.66	0.54	0.84	± 12.0 %
900	41.5	0.97	9.56	9.56	9.56	0.54	0.80	± 12.0 %
1450	40.5	1.20	8.72	8.72	8.72	0.45	0.80	± 12.0 %
1640	40.2	1.31	8.50	8.50	8.50	0.25	0.80	± 12.0 %
1750	40.1	1.37	8.41	8.41	8.41	0.30	0.80	± 12.0 %
1810	40.0	1.40	8.20	8.20	8.20	0.15	1.26	± 12.0 %
1900	40.0	1.40	8.14	8.14	8.14	0.31	0.80	± 12.0 %
2000	40.0	1.40	8.25	8.25	8.25	0.40	0.81	± 12.0 %
2100	39.8	1.49	8.16	8.16	8.16	0.28	0.80	± 12.0 %
2300	39.5	1.67	7.95	7.95	7.95	0.35	0.86	± 12.0 %
2450	39.2	1.80	7.65	7.65	7.65	0.33	0.90	± 12.0 %
2600	39.0	1.96	7.52	7.52	7.52	0.38	0.90	± 12.0 %
3300	38.2	2.71	7.07	7.07	7.07	0.30	1.20	± 13.1 %
3500	37.9	2.91	7.02	7.02	7.02	0.35	1.30	± 13.1 %
3700	37.7	3.12	6.77	6.77	6.77	0.35	1.30	± 13.1 %
3900	37.5	3.32	6.62	6.62	6.62	0.40	1.60	± 13.1 %
4100	37.2	3.53	6.60	6.60	6.60	0.40	1.60	± 13.1 %
4200	37.1	3.63	6.50	6.50	6.50	0.40	1.60	± 13.1 %
4400	36.9	3.84	6.35	6.35	6.35	0.40	1.60	± 13.1 %
4600	36.7	4.04	6.30	6.30	6.30	0.40	1.60	± 13.1 %
4800	36.4	4.25	6.25	6.25	6.25	0.40	1.80	± 13.1 %
4950	36.3	4.40	6.10	6.10	6.10	0.40	1.80	± 13.1 %
5200	36.0	4.66	5.49	5.49	5.49	0.40	1.80	± 13.1 %
5250	35.9	4.71	5.39	5.39	5.39	0.40	1.80	± 13.1 %
5300	35.9	4.76	5.29	5.29	5.29	0.40	1.80	± 13.1 %
5500	35.6	4.96	5.14	5.14	5.14	0.40	1.80	± 13.1 %
5600	35.5	5.07	4.99	4.99	4.99	0.40	1.80	± 13.1 %
5750	35.4	5.22	5.10	5.10	5.10	0.40	1.80	± 13.1 %
5800	35.3	5.27	5.00	5.00	5.00	0.40	1.80	± 13.1 %

^C Frequency validity above 300 MHz of ± 100 MHz only applies for DASY v4.4 and higher (see Page 2), else it is restricted to ± 50 MHz. The uncertainty is the RSS of the ConvF uncertainty at calibration frequency and the uncertainty for the indicated frequency band. Frequency validity below 300 MHz is ± 10, 25, 40, 50 and 70 MHz for ConvF assessments at 30, 64, 128, 150 and 220 MHz respectively. Validity of ConvF assessed at 6 MHz is 4-9 MHz, and ConvF assessed at 13 MHz is 9-19 MHz. Above 5 GHz frequency validity can be extended to ± 110 MHz.

^F At frequencies below 3 GHz, the validity of tissue parameters (ϵ and σ) can be relaxed to ± 10% if liquid compensation formula is applied to measured SAR values. At frequencies above 3 GHz, the validity of tissue parameters (ϵ and σ) is restricted to ± 5%. The uncertainty is the RSS of the ConvF uncertainty for indicated target tissue parameters.

^G Alpha/Depth are determined during calibration. SPEAG warrants that the remaining deviation due to the boundary effect after compensation is always less than ± 1% for frequencies below 3 GHz and below ± 2% for frequencies between 3-6 GHz at any distance larger than half the probe tip diameter from the boundary.

EX3DV4- SN:3617

January 30, 2020

DASY/EASY - Parameters of Probe: EX3DV4 - SN:3617

Calibration Parameter Determined in Body Tissue Simulating Media

f (MHz) ^c	Relative Permittivity ^f	Conductivity (S/m) ^f	ConvF X	ConvF Y	ConvF Z	Alpha ^g	Depth ^h (mm)	Unc (k=2)
750	55.5	0.96	9.80	9.80	9.80	0.50	0.80	± 12.0 %
835	55.2	0.97	9.53	9.53	9.53	0.43	0.80	± 12.0 %
900	55.0	1.05	9.49	9.49	9.49	0.42	0.80	± 12.0 %
1450	54.0	1.30	8.56	8.56	8.56	0.25	0.80	± 12.0 %
1640	53.7	1.42	8.44	8.44	8.44	0.32	0.80	± 12.0 %
1750	53.4	1.49	8.09	8.09	8.09	0.48	0.80	± 12.0 %
1810	53.3	1.52	8.05	8.05	8.05	0.44	0.80	± 12.0 %
1900	53.3	1.52	7.94	7.94	7.94	0.39	0.80	± 12.0 %
2000	53.3	1.52	7.92	7.92	7.92	0.37	0.86	± 12.0 %
2100	53.2	1.62	7.89	7.89	7.89	0.35	0.89	± 12.0 %
2300	52.9	1.81	7.78	7.78	7.78	0.39	0.85	± 12.0 %
2450	52.7	1.95	7.76	7.76	7.76	0.41	0.80	± 12.0 %
2600	52.5	2.16	7.45	7.45	7.45	0.32	0.80	± 12.0 %
3300	51.6	3.08	6.44	6.44	6.44	0.40	1.70	± 13.1 %
3500	51.3	3.31	6.30	6.30	6.30	0.40	1.70	± 13.1 %
3700	51.0	3.55	6.27	6.27	6.27	0.40	1.70	± 13.1 %
3900	51.2	3.78	6.24	6.24	6.24	0.40	1.70	± 13.1 %
4100	50.5	4.01	6.21	6.21	6.21	0.40	1.70	± 13.1 %
4200	50.4	4.13	6.20	6.20	6.20	0.40	1.70	± 13.1 %
4400	50.1	4.37	5.97	5.97	5.97	0.40	1.70	± 13.1 %
4600	49.8	4.60	5.83	5.83	5.83	0.40	1.70	± 13.1 %
4800	49.6	4.83	5.72	5.72	5.72	0.50	1.80	± 13.1 %
4950	49.4	5.01	5.41	5.41	5.41	0.50	1.90	± 13.1 %
5200	49.0	5.30	4.80	4.80	4.80	0.50	1.90	± 13.1 %
5250	48.9	5.36	4.70	4.70	4.70	0.50	1.90	± 13.1 %
5300	48.9	5.42	4.61	4.61	4.61	0.50	1.90	± 13.1 %
5500	48.6	5.65	4.32	4.32	4.32	0.50	1.90	± 13.1 %
5600	48.5	5.77	4.23	4.23	4.23	0.50	1.90	± 13.1 %
5750	48.3	5.94	4.36	4.36	4.36	0.50	1.90	± 13.1 %
5800	48.2	6.00	4.22	4.22	4.22	0.50	1.90	± 13.1 %

^c Frequency validity above 300 MHz of ± 100 MHz only applies for DASY v4.4 and higher (see Page 2), else it is restricted to ± 50 MHz. The uncertainty is the RSS of the ConvF uncertainty at calibration frequency and the uncertainty for the indicated frequency band. Frequency validity below 300 MHz is ± 10, 25, 40, 50 and 70 MHz for ConvF assessments at 30, 64, 128, 150 and 220 MHz respectively. Validity of ConvF assessed at 6 MHz is 4-9 MHz, and ConvF assessed at 13 MHz is 9-19 MHz. Above 5 GHz frequency validity can be extended to ± 110 MHz.

^f At frequencies below 3 GHz, the validity of tissue parameters (ϵ and σ) can be relaxed to ± 10% if liquid compensation formula is applied to measured SAR values. At frequencies above 3 GHz, the validity of tissue parameters (ϵ and σ) is restricted to ± 5%. The uncertainty is the RSS of the ConvF uncertainty for indicated target tissue parameters.

^g Alpha/Depth are determined during calibration. SPEAG warrants that the remaining deviation due to the boundary effect after compensation is always less than ± 1% for frequencies below 3 GHz and below ± 2% for frequencies between 3-6 GHz at any distance larger than half the probe tip diameter from the boundary.

EX3DV4- SN:3617

January 30, 2020

Frequency Response of E-Field (TEM-Cell: ifi110 EXX, Waveguide: R22)

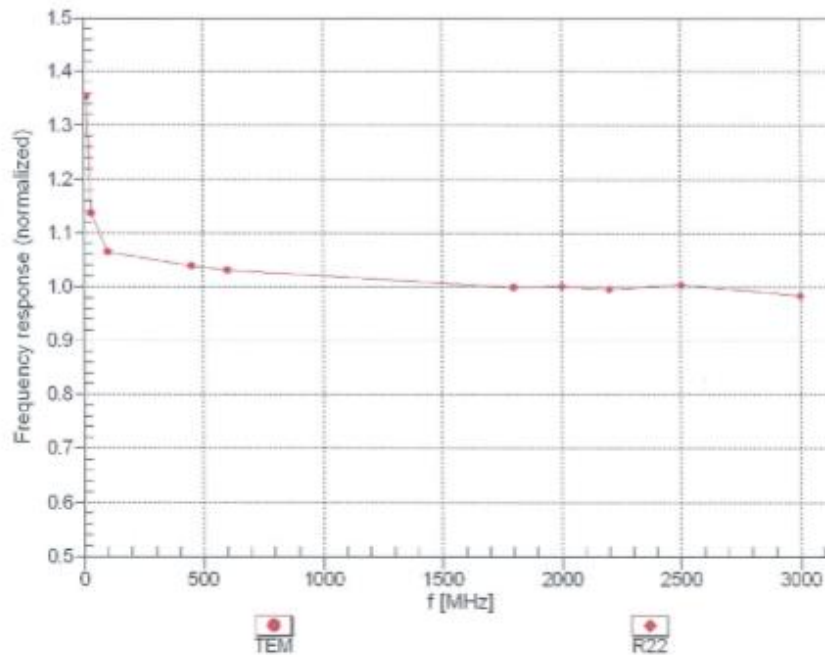
Uncertainty of Frequency Response of E-field: $\pm 6.3\%$ (k=2)

Receiving Pattern (ϕ), $\vartheta = 0^\circ$

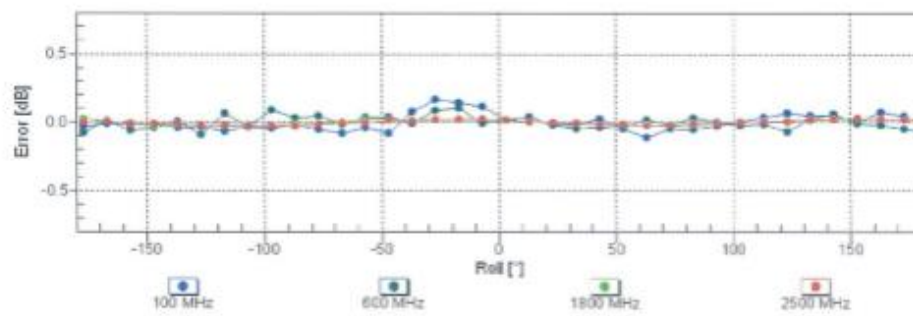
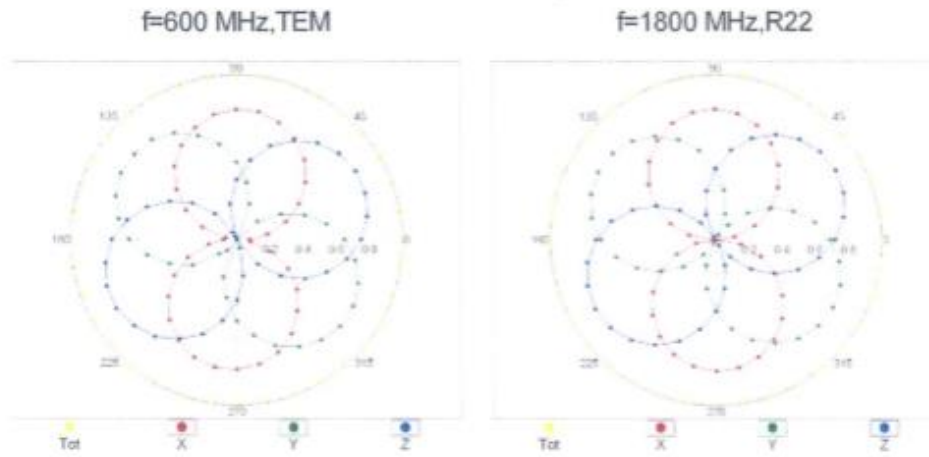

Uncertainty of Axial Isotropy Assessment: $\pm 0.5\%$ (k=2)

EX3DV4- SN:3617

January 30, 2020

Dynamic Range f(SAR_{head}) (TEM cell , f_{eval}= 1900 MHz)

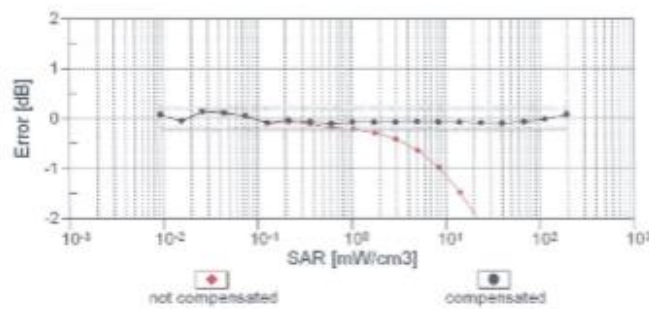
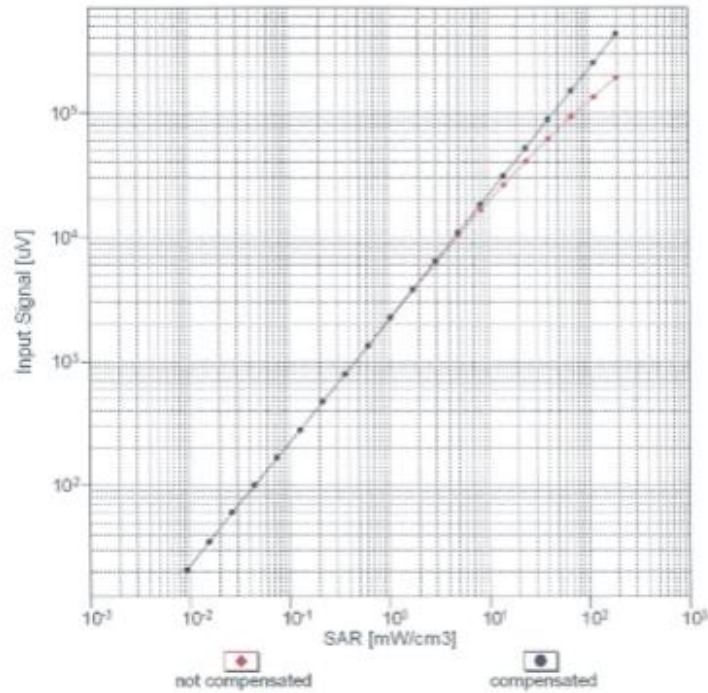

Uncertainty of Linearity Assessment: ± 0.6% (k=2)

EX3DV4- SN:3617

January 30, 2020

Conversion Factor Assessment

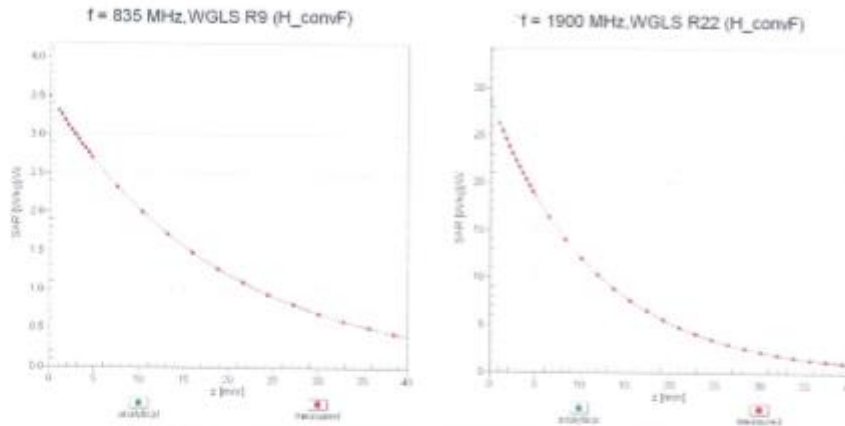

Deviation from Isotropy in Liquid Error (ϕ , θ), $f = 900 \text{ MHz}$

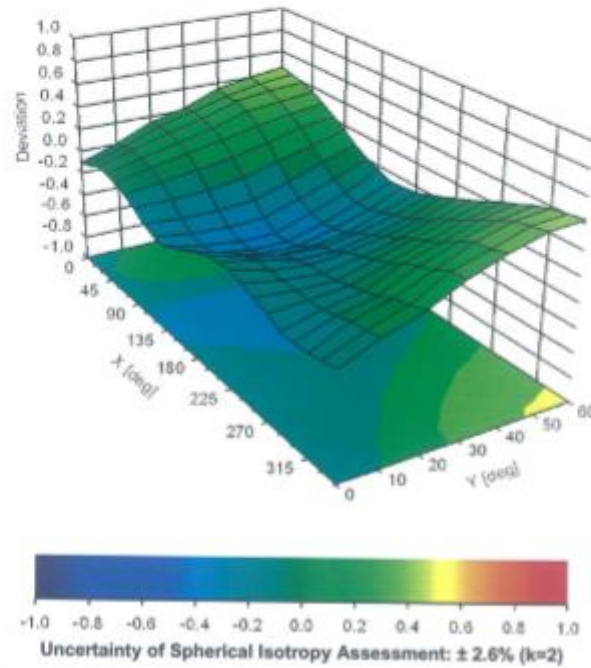

EX3DV4- SN:3617

January 30, 2020

Appendix: Modulation Calibration Parameters

UID	Rev	Communication System Name	Group	PAR (dB)	Unc ² (k=2)
0		CW	CW	0.00	±4.7 %
10010	CAA	SAR Validation (Square, 100ms, 10ms)	Test	10.00	±9.6 %
10011	CAB	UMTS-FDD (WCDMA)	WCDMA	2.91	±9.6 %
10012	CAB	IEEE 802.11b WiFi 2.4 GHz (DSSS, 1 Mbps)	WLAN	1.87	±9.6 %
10013	CAB	IEEE 802.11g WiFi 2.4 GHz (DSSS-OFDM, 6 Mbps)	WLAN	9.46	±9.6 %
10021	DAC	GSM-FDD (TDMA, GMSK)	GSM	9.39	±9.6 %
10023	DAC	GPRS-FDD (TDMA, GMSK, TN 0)	GSM	9.57	±9.6 %
10024	DAC	GPRS-FDD (TDMA, GMSK, TN 0-1)	GSM	6.56	±9.6 %
10025	DAC	EDGE-FDD (TDMA, 8PSK, TN 0)	GSM	12.62	±9.6 %
10026	DAC	EDGE-FDD (TDMA, 8PSK, TN 0-1)	GSM	9.55	±9.6 %
10027	DAC	GPRS-FDD (TDMA, GMSK, TN 0-1-2)	GSM	4.80	±9.6 %
10028	DAC	GPRS-FDD (TDMA, GMSK, TN 0-1-2-3)	GSM	3.55	±9.6 %
10029	DAC	EDGE-FDD (TDMA, 8PSK, TN 0-1-2)	GSM	7.78	±9.6 %
10030	CAA	IEEE 802.15.1 Bluetooth (GFSK, DH1)	Bluetooth	5.30	±9.6 %
10031	CAA	IEEE 802.15.1 Bluetooth (GFSK, DH3)	Bluetooth	1.87	±9.6 %
10032	CAA	IEEE 802.15.1 Bluetooth (GFSK, DH5)	Bluetooth	1.16	±9.6 %
10033	CAA	IEEE 802.15.1 Bluetooth (Pi/4-DQPSK, DH1)	Bluetooth	7.74	±9.6 %
10034	CAA	IEEE 802.15.1 Bluetooth (Pi/4-DQPSK, DH3)	Bluetooth	4.53	±9.6 %
10035	CAA	IEEE 802.15.1 Bluetooth (Pi/4-DQPSK, DH5)	Bluetooth	3.83	±9.6 %
10036	CAA	IEEE 802.15.1 Bluetooth (8-PSK, DH1)	Bluetooth	8.01	±9.6 %
10037	CAA	IEEE 802.15.1 Bluetooth (8-PSK, DH3)	Bluetooth	4.77	±9.6 %
10038	CAA	IEEE 802.15.1 Bluetooth (8-PSK, DH5)	Bluetooth	4.10	±9.6 %
10039	CAB	CDMA2000 (1xRTT, RC1)	CDMA2000	4.57	±9.6 %
10042	CAB	IS-54 / IS-136 FDD (TDMA/FDM, Pi/4-DQPSK, Halfrate)	AMPS	7.78	±9.6 %
10044	CAA	IS-91/EIA/TIA-553 FDD (FDMA, FM)	AMPS	0.00	±9.6 %
10048	CAA	DECT (TDD, TDMA/FDM, GFSK, Full Slot, 24)	DECT	13.80	±9.6 %
10049	CAA	DECT (TDD, TDMA/FDM, GFSK, Double Slot, 12)	DECT	10.79	±9.6 %
10056	CAA	UMTS-TDD (TD-SCDMA, 1.28 Mcps)	TD-SCDMA	11.01	±9.6 %
10058	DAC	EDGE-FDD (TDMA, 8PSK, TN 0-1-2-3)	GSM	6.52	±9.6 %
10059	CAB	IEEE 802.11b WiFi 2.4 GHz (DSSS, 2 Mbps)	WLAN	2.12	±9.6 %
10060	CAB	IEEE 802.11b WiFi 2.4 GHz (DSSS, 5.5 Mbps)	WLAN	2.83	±9.6 %
10061	CAB	IEEE 802.11b WiFi 2.4 GHz (DSSS, 11 Mbps)	WLAN	3.60	±9.6 %
10062	CAC	IEEE 802.11a/h WiFi 5 GHz (OFDM, 6 Mbps)	WLAN	8.66	±9.6 %
10063	CAC	IEEE 802.11a/h WiFi 5 GHz (OFDM, 9 Mbps)	WLAN	8.63	±9.6 %
10064	CAC	IEEE 802.11a/h WiFi 5 GHz (OFDM, 12 Mbps)	WLAN	9.09	±9.6 %
10065	CAC	IEEE 802.11a/h WiFi 5 GHz (OFDM, 18 Mbps)	WLAN	9.00	±9.6 %
10066	CAC	IEEE 802.11a/h WiFi 5 GHz (OFDM, 24 Mbps)	WLAN	9.38	±9.6 %
10067	CAC	IEEE 802.11a/h WiFi 5 GHz (OFDM, 36 Mbps)	WLAN	10.12	±9.6 %
10068	CAC	IEEE 802.11a/h WiFi 5 GHz (OFDM, 48 Mbps)	WLAN	10.24	±9.6 %
10069	CAC	IEEE 802.11a/h WiFi 5 GHz (OFDM, 54 Mbps)	WLAN	10.56	±9.6 %
10071	CAB	IEEE 802.11g WiFi 2.4 GHz (DSSS/OFDM, 9 Mbps)	WLAN	9.83	±9.6 %
10072	CAB	IEEE 802.11g WiFi 2.4 GHz (DSSS/OFDM, 12 Mbps)	WLAN	9.62	±9.6 %
10073	CAB	IEEE 802.11g WiFi 2.4 GHz (DSSS/OFDM, 18 Mbps)	WLAN	9.94	±9.6 %
10074	CAB	IEEE 802.11g WiFi 2.4 GHz (DSSS/OFDM, 24 Mbps)	WLAN	10.30	±9.6 %
10075	CAB	IEEE 802.11g WiFi 2.4 GHz (DSSS/OFDM, 36 Mbps)	WLAN	10.77	±9.6 %
10076	CAB	IEEE 802.11g WiFi 2.4 GHz (DSSS/OFDM, 48 Mbps)	WLAN	10.94	±9.6 %
10077	CAB	IEEE 802.11g WiFi 2.4 GHz (DSSS/OFDM, 54 Mbps)	WLAN	11.00	±9.6 %
10081	CAB	CDMA2000 (1xRTT, RC3)	CDMA2000	3.97	±9.6 %
10082	CAB	IS-54 / IS-136 FDD (TDMA/FDM, Pi/4-DQPSK, Fullrate)	AMPS	4.77	±9.6 %
10090	DAC	GPRS-FDD (TDMA, GMSK, TN 0-4)	GSM	6.56	±9.6 %
10097	CAB	UMTS-FDD (HSDPA)	WCDMA	3.98	±9.6 %
10098	CAB	UMTS-FDD (HSUPA, Subtest 2)	WCDMA	3.98	±9.6 %
10099	DAC	EDGE-FDD (TDMA, 8PSK, TN 0-4)	GSM	9.55	±9.6 %
10100	CAE	LTE-FDD (SC-FDMA, 100% RB, 20 MHz, QPSK)	LTE-FDD	5.67	±9.6 %
10101	CAE	LTE-FDD (SC-FDMA, 100% RB, 20 MHz, 16-QAM)	LTE-FDD	6.42	±9.6 %
10102	CAE	LTE-FDD (SC-FDMA, 100% RB, 20 MHz, 64-QAM)	LTE-FDD	6.60	±9.6 %
10103	CAG	LTE-TDD (SC-FDMA, 100% RB, 20 MHz, QPSK)	LTE-TDD	9.29	±9.6 %
10104	CAG	LTE-TDD (SC-FDMA, 100% RB, 20 MHz, 16-QAM)	LTE-TDD	9.97	±9.6 %
10105	CAG	LTE-TDD (SC-FDMA, 100% RB, 20 MHz, 64-QAM)	LTE-TDD	10.01	±9.6 %
10108	CAG	LTE-FDD (SC-FDMA, 100% RB, 10 MHz, QPSK)	LTE-FDD	5.80	±9.6 %



EX3DV4- SN:3617

January 30, 2020

10109	CAG	LTE-FDD (SC-FDMA, 100% RB, 10 MHz, 16-QAM)	LTE-FDD	6.43	±9.6 %
10110	CAG	LTE-FDD (SC-FDMA, 100% RB, 5 MHz, QPSK)	LTE-FDD	5.75	±9.6 %
10111	CAG	LTE-FDD (SC-FDMA, 100% RB, 5 MHz, 16-QAM)	LTE-FDD	6.44	±9.6 %
10112	CAG	LTE-FDD (SC-FDMA, 100% RB, 10 MHz, 64-QAM)	LTE-FDD	6.59	±9.6 %
10113	CAG	LTE-FDD (SC-FDMA, 100% RB, 5 MHz, 64-QAM)	LTE-FDD	6.62	±9.6 %
10114	CAC	IEEE 802.11n (HT Greenfield, 13.5 Mbps, BPSK)	WLAN	8.10	±9.6 %
10115	CAC	IEEE 802.11n (HT Greenfield, 81 Mbps, 16-QAM)	WLAN	8.46	±9.6 %
10116	CAC	IEEE 802.11n (HT Greenfield, 135 Mbps, 64-QAM)	WLAN	8.15	±9.6 %
10117	CAC	IEEE 802.11n (HT Mixed, 13.5 Mbps, BPSK)	WLAN	8.07	±9.6 %
10118	CAC	IEEE 802.11n (HT Mixed, 81 Mbps, 16-QAM)	WLAN	8.59	±9.6 %
10119	CAC	IEEE 802.11n (HT Mixed, 135 Mbps, 64-QAM)	WLAN	8.13	±9.6 %
10140	CAE	LTE-FDD (SC-FDMA, 100% RB, 15 MHz, 16-QAM)	LTE-FDD	6.49	±9.6 %
10141	CAE	LTE-FDD (SC-FDMA, 100% RB, 15 MHz, 64-QAM)	LTE-FDD	6.53	±9.6 %
10142	CAE	LTE-FDD (SC-FDMA, 100% RB, 3 MHz, QPSK)	LTE-FDD	5.73	±9.6 %
10143	CAE	LTE-FDD (SC-FDMA, 100% RB, 3 MHz, 16-QAM)	LTE-FDD	6.35	±9.6 %
10144	CAE	LTE-FDD (SC-FDMA, 100% RB, 3 MHz, 64-QAM)	LTE-FDD	6.65	±9.6 %
10145	CAF	LTE-FDD (SC-FDMA, 100% RB, 1.4 MHz, QPSK)	LTE-FDD	5.76	±9.6 %
10146	CAF	LTE-FDD (SC-FDMA, 100% RB, 1.4 MHz, 16-QAM)	LTE-FDD	6.41	±9.6 %
10147	CAF	LTE-FDD (SC-FDMA, 100% RB, 1.4 MHz, 64-QAM)	LTE-FDD	6.72	±9.6 %
10149	CAE	LTE-FDD (SC-FDMA, 50% RB, 20 MHz, 16-QAM)	LTE-FDD	6.42	±9.6 %
10150	CAE	LTE-FDD (SC-FDMA, 50% RB, 20 MHz, 64-QAM)	LTE-FDD	6.60	±9.6 %
10151	CAG	LTE-TDD (SC-FDMA, 50% RB, 20 MHz, QPSK)	LTE-TDD	9.28	±9.6 %
10152	CAG	LTE-TDD (SC-FDMA, 50% RB, 20 MHz, 16-QAM)	LTE-TDD	9.92	±9.6 %
10153	CAG	LTE-TDD (SC-FDMA, 50% RB, 20 MHz, 64-QAM)	LTE-TDD	10.05	±9.6 %
10154	CAG	LTE-FDD (SC-FDMA, 50% RB, 10 MHz, QPSK)	LTE-FDD	5.75	±9.6 %
10155	CAG	LTE-FDD (SC-FDMA, 50% RB, 10 MHz, 16-QAM)	LTE-FDD	6.43	±9.6 %
10156	CAG	LTE-FDD (SC-FDMA, 50% RB, 5 MHz, QPSK)	LTE-FDD	5.79	±9.6 %
10157	CAG	LTE-FDD (SC-FDMA, 50% RB, 5 MHz, 16-QAM)	LTE-FDD	6.49	±9.6 %
10158	CAG	LTE-FDD (SC-FDMA, 50% RB, 10 MHz, 64-QAM)	LTE-FDD	6.62	±9.6 %
10159	CAG	LTE-FDD (SC-FDMA, 50% RB, 5 MHz, 64-QAM)	LTE-FDD	6.56	±9.6 %
10160	CAE	LTE-FDD (SC-FDMA, 50% RB, 15 MHz, QPSK)	LTE-FDD	5.82	±9.6 %
10161	CAE	LTE-FDD (SC-FDMA, 50% RB, 15 MHz, 16-QAM)	LTE-FDD	6.43	±9.6 %
10162	CAE	LTE-FDD (SC-FDMA, 50% RB, 15 MHz, 64-QAM)	LTE-FDD	6.58	±9.6 %
10166	CAF	LTE-FDD (SC-FDMA, 50% RB, 1.4 MHz, QPSK)	LTE-FDD	5.46	±9.6 %
10167	CAF	LTE-FDD (SC-FDMA, 50% RB, 1.4 MHz, 16-QAM)	LTE-FDD	6.21	±9.6 %
10168	CAF	LTE-FDD (SC-FDMA, 50% RB, 1.4 MHz, 64-QAM)	LTE-FDD	6.79	±9.6 %
10169	CAE	LTE-FDD (SC-FDMA, 1 RB, 20 MHz, QPSK)	LTE-FDD	5.73	±9.6 %
10170	CAE	LTE-FDD (SC-FDMA, 1 RB, 20 MHz, 16-QAM)	LTE-FDD	6.52	±9.6 %
10171	AAE	LTE-FDD (SC-FDMA, 1 RB, 20 MHz, 64-QAM)	LTE-FDD	6.49	±9.6 %
10172	CAG	LTE-TDD (SC-FDMA, 1 RB, 20 MHz, QPSK)	LTE-TDD	9.21	±9.6 %
10173	CAG	LTE-TDD (SC-FDMA, 1 RB, 20 MHz, 16-QAM)	LTE-TDD	9.48	±9.6 %
10174	CAG	LTE-TDD (SC-FDMA, 1 RB, 20 MHz, 64-QAM)	LTE-TDD	10.25	±9.6 %
10175	CAG	LTE-FDD (SC-FDMA, 1 RB, 10 MHz, QPSK)	LTE-FDD	5.72	±9.6 %
10176	CAG	LTE-FDD (SC-FDMA, 1 RB, 10 MHz, 16-QAM)	LTE-FDD	6.52	±9.6 %
10177	CAI	LTE-FDD (SC-FDMA, 1 RB, 5 MHz, QPSK)	LTE-FDD	5.73	±9.6 %
10178	CAG	LTE-FDD (SC-FDMA, 1 RB, 5 MHz, 16-QAM)	LTE-FDD	6.52	±9.6 %
10179	CAG	LTE-FDD (SC-FDMA, 1 RB, 10 MHz, 64-QAM)	LTE-FDD	6.50	±9.6 %
10180	CAG	LTE-FDD (SC-FDMA, 1 RB, 5 MHz, 64-QAM)	LTE-FDD	6.50	±9.6 %
10181	CAE	LTE-FDD (SC-FDMA, 1 RB, 15 MHz, QPSK)	LTE-FDD	5.72	±9.6 %
10182	CAE	LTE-FDD (SC-FDMA, 1 RB, 15 MHz, 16-QAM)	LTE-FDD	6.52	±9.6 %
10183	AAD	LTE-FDD (SC-FDMA, 1 RB, 15 MHz, 64-QAM)	LTE-FDD	6.50	±9.6 %
10184	CAE	LTE-FDD (SC-FDMA, 1 RB, 3 MHz, QPSK)	LTE-FDD	5.73	±9.6 %
10185	CAE	LTE-FDD (SC-FDMA, 1 RB, 3 MHz, 16-QAM)	LTE-FDD	6.51	±9.6 %
10186	AAE	LTE-FDD (SC-FDMA, 1 RB, 3 MHz, 64-QAM)	LTE-FDD	6.50	±9.6 %
10187	CAF	LTE-FDD (SC-FDMA, 1 RB, 1.4 MHz, QPSK)	LTE-FDD	5.73	±9.6 %
10188	CAF	LTE-FDD (SC-FDMA, 1 RB, 1.4 MHz, 16-QAM)	LTE-FDD	6.52	±9.6 %
10189	AAF	LTE-FDD (SC-FDMA, 1 RB, 1.4 MHz, 64-QAM)	LTE-FDD	6.50	±9.6 %
10193	CAC	IEEE 802.11n (HT Greenfield, 6.5 Mbps, BPSK)	WLAN	8.09	±9.6 %
10194	CAC	IEEE 802.11n (HT Greenfield, 39 Mbps, 16-QAM)	WLAN	8.12	±9.6 %
10195	CAC	IEEE 802.11n (HT Greenfield, 65 Mbps, 64-QAM)	WLAN	8.21	±9.6 %
10196	CAC	IEEE 802.11n (HT Mixed, 6.5 Mbps, BPSK)	WLAN	8.10	±9.6 %
10197	CAC	IEEE 802.11n (HT Mixed, 39 Mbps, 16-QAM)	WLAN	8.13	±9.6 %
10198	CAC	IEEE 802.11n (HT Mixed, 65 Mbps, 64-QAM)	WLAN	8.27	±9.6 %
10219	CAC	IEEE 802.11n (HT Mixed, 7.2 Mbps, BPSK)	WLAN	8.03	±9.6 %