



SAR TEST REPORT

No. I20Z70165-SEM02

For

SAMSUNG Electronics Co., Ltd.

Multi-band GSM/WCDMA/LTE Tablet with Bluetooth, WLAN

Model Name: SM-T505

With

Hardware Version: REV1.0

Software Version: T505.001

FCC ID: ZCASMT505

Issued Date: 2020-7-9

Note:

The test results in this test report relate only to the devices specified in this report. This report shall not be reproduced except in full without the written approval of CTTL.

The report must not be used by the client to claim product certification, approval, or endorsement by NVLAP, NIST, or any agency of the U.S. Government.

Test Laboratory:

CTTL, Telecommunication Technology Labs, CAICT

No. 51, Xueyuan Road, Haidian District, Beijing, P. R. China 100191.

Tel:+86(0)10-62304633-2512, Fax:+86(0)10-62304633-2504

Email: cttl_terminals@caict.ac.cn, website: www.caict.ac.cn

REPORT HISTORY

Report Number	Revision	Issue Date	Description
I20Z70165-SEM02	Rev.0	2020-7-8	Initial creation of test report
I20Z70165-SEM02	Rev.1	2020-7-9	<ol style="list-style-type: none">1. Update the tune up power for GSM850, WCDMA Band2/5 on page 26 and page 29.2. Update the tune up power for low power mode of LTE Band12.3. Update the BT power on page81.4. Update the duty cycle for GSM850/1900 low power on section 14.5. Update tune up procedure for WCDMA Band 2/5 on page 96~97, 107.6. Update the medium parameter on page 140.7. Move the picture of antenna locations from Section 12 to the document "The Photos of SAR test - I20Z70165"

TABLE OF CONTENT

1	TEST LABORATORY	5
1.1	TESTING LOCATION	5
1.2	TESTING ENVIRONMENT.....	5
1.3	PROJECT DATA.....	5
1.4	SIGNATURE	5
2	STATEMENT OF COMPLIANCE	6
3	CLIENT INFORMATION	8
3.1	APPLICANT INFORMATION	8
3.2	MANUFACTURER INFORMATION	8
4	EQUIPMENT UNDER TEST (EUT) AND ANCILLARY EQUIPMENT (AE)	9
4.1	ABOUT EUT	9
4.2	INTERNAL IDENTIFICATION OF EUT USED DURING THE TEST	9
4.3	INTERNAL IDENTIFICATION OF AE USED DURING THE TEST.....	9
5	TEST METHODOLOGY	10
5.1	APPLICABLE LIMIT REGULATIONS	10
5.2	APPLICABLE MEASUREMENT STANDARDS.....	10
6	SPECIFIC ABSORPTION RATE (SAR)	11
6.1	INTRODUCTION.....	11
6.2	SAR DEFINITION	11
7	TISSUE SIMULATING LIQUIDS	12
7.1	TARGETS FOR TISSUE SIMULATING LIQUID.....	12
7.2	DIELECTRIC PERFORMANCE	12
8	SYSTEM VERIFICATION	17
8.1	SYSTEM SETUP	17
8.2	SYSTEM VERIFICATION.....	18
9	MEASUREMENT PROCEDURES	19
9.1	TESTS TO BE PERFORMED.....	19
9.2	GENERAL MEASUREMENT PROCEDURE	21
9.3	WCDMA MEASUREMENT PROCEDURES FOR SAR	22
9.4	SAR MEASUREMENT FOR LTE	23
9.5	BLUETOOTH & WI-FI MEASUREMENT PROCEDURES FOR SAR.....	23
9.6	POWER DRIFT	24
10	AREA SCAN BASED 1-G SAR	25
10.1	REQUIREMENT OF KDB	25
10.2	FAST SAR ALGORITHMS	25

11	CONDUCTED OUTPUT POWER.....	26
11.1	GSM MEASUREMENT RESULT	26
11.2	WCDMA MEASUREMENT RESULT	29
11.3	LTE MEASUREMENT RESULT	31
11.4	WI-FI AND BT MEASUREMENT RESULT	81
12	SIMULTANEOUS TX SAR CONSIDERATIONS	91
12.1	INTRODUCTION	91
12.2	TRANSMIT ANTENNA SEPARATION DISTANCES	91
12.3	STANDALONE SAR TEST EXCLUSION CONSIDERATIONS	92
13	EVALUATION OF SIMULTANEOUS	93
14	SAR TEST RESULT	94
14.1	SAR RESULTS	95
14.2	SAR RESULTS FOR STANDARD PROCEDURE	107
14.3	WLAN EVALUATION FOR 2.4G	111
14.4	WLAN EVALUATION FOR 5G	113
15	SAR MEASUREMENT VARIABILITY	118
16	MEASUREMENT UNCERTAINTY	119
16.1	MEASUREMENT UNCERTAINTY FOR NORMAL SAR TESTS (300MHZ~3GHZ)	119
16.2	MEASUREMENT UNCERTAINTY FOR NORMAL SAR TESTS (3~6GHZ).....	120
16.3	MEASUREMENT UNCERTAINTY FOR FAST SAR TESTS (300MHZ~3GHZ)	121
16.4	MEASUREMENT UNCERTAINTY FOR FAST SAR TESTS (3~6GHZ).....	122
17	MAIN TEST INSTRUMENTS.....	124
ANNEX A	GRAPH RESULTS	125
ANNEX B	SYSTEM VERIFICATION RESULTS	146
ANNEX C	SAR MEASUREMENT SETUP	156
ANNEX D	POSITION OF THE WIRELESS DEVICE IN RELATION TO THE PHANTOM	162
ANNEX E	EQUIVALENT MEDIA RECIPES	165
ANNEX F	SYSTEM VALIDATION	166
ANNEX G	PROBE CALIBRATION CERTIFICATE.....	167
ANNEX H	DIPOLE CALIBRATION CERTIFICATE	190
ANNEX I	SENSOR TRIGGERING DATA SUMMARY	261
ANNEX J	ACCREDITATION CERTIFICATE	266

1 Test Laboratory

1.1 Testing Location

Company Name:	CTTL(Shouxiang)
Address:	No. 51 Shouxiang Science Building, Xueyuan Road, Haidian District, Beijing, P. R. China100191
(if applicable) SAR test lab number	12389A-1

1.2 Testing Environment

Temperature:	18°C~25 °C,
Relative humidity:	30%~ 70%
Ground system resistance:	< 0.5 Ω
Ambient noise & Reflection:	< 0.012 W/kg

1.3 Project Data

Project Leader:	Qi Dianyuan
Test Engineer:	Lin Xiaojun
Testing Start Date:	June 25, 2020
Testing End Date:	July 3, 2020

1.4 Signature



Lin Xiaojun

(Prepared this test report)

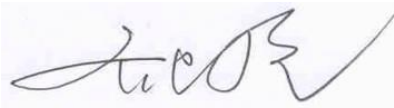

Qi Dianyuan

(Reviewed this test report)

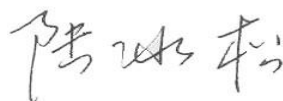

Lu Bingsong

Deputy Director of the laboratory
(Approved this test report)

2 Statement of Compliance

The maximum results of SAR found during testing for SAMSUNG Electronics Co., Ltd. Multi-band GSM/WCDMA/LTE Tablet with Bluetooth, WLAN SM-T505 is as follows:

Table 2.1: Highest Reported SAR (1g)

Exposure Configuration	Technology Band	Highest Reported SAR 1g (W/Kg)	Equipment Class
Hotspot(body)	GSM 850	0.58	PCE
	PCS 1900	0.66	
	UMTS FDD 2	0.73	
	UMTS FDD 4	0.77	
	UMTS FDD 5	0.70	
	LTE Band 2	1.02	
	LTE Band 5	0.69	
	LTE Band 7	0.71	
	LTE Band 12	0.70	
	LTE Band 18	0.71	
	LTE Band 19	0.75	
	LTE Band 28	0.64	
	LTE Band 38	0.74	
	LTE Band 66	0.66	
	WLAN 2.4 GHz	0.67	DTS
WLAN 5 GHz	0.77		

The SAR values found for the Mobile Phone are below the maximum recommended levels of 1.6 W/kg as averaged over any 1g tissue according to the ANSI C95.1-1992.

For body worn operation, this device has been tested and meets FCC RF exposure guidelines when used with any accessory that contains no metal and which provides a minimum separation distance from 0/13/18/19 mm between this device and the body of the user. Use of other accessories may not ensure compliance with FCC RF exposure guidelines.

The EUT battery must be fully charged and checked periodically during the test to ascertain uniform power output.

The measurement together with the test system set-up is described in annex C of this test report. A detailed description of the equipment under test can be found in chapter 4 of this test report.

The highest reported SAR value is obtained at the case of **(Table 2.1)**, and the values are: **1.02 W/kg (1g)**.

Table 2.2: The sum of reported SAR values for main antenna and WiFi2.4G

	Position	Main antenna	WiFi	Sum
Highest reported SAR value for Body	Top 19mm (LTE Band2)	1.02	0.46	1.48

Table 2.3: The sum of reported SAR values for main antenna and WiFi5G

	Position	Main antenna	WiFi	Sum
Highest reported SAR value for Body	Top 19mm (LTE Band2)	1.02	0.51	1.53

Table 2.4: The sum of reported SAR values for main antenna and BT

	Position	Main antenna	BT	Sum
Maximum reported SAR value for Body	Top 19mm (LTE Band2)	1.02	0.10 ^[1]	1.12

[1] - Estimated SAR for Bluetooth (see the table 13.3)

According to the above tables, the highest sum of reported SAR values is **1.53 W/kg (1g)**. The detail for simultaneous transmission consideration is described in chapter 13.



3 Client Information

3.1 Applicant Information

Company Name:	SAMSUNG Electronics Co., Ltd.
Address /Post:	19 Chapin Road, Building D, Pine Brook New Jersey United States, 07058
Contact Person:	Jenni Chun
E-mail:	j1.chun@samsung.com
Telephone:	+1-201-937-4203
Fax:	N/A

3.2 Manufacturer Information

Company Name:	SAMSUNG Electronics Co., Ltd.
Address /Post:	R5, A Tower 22 Floor A-1, (Maetan dong) 129, Samsung-ro, Yeongtong-gu, Suwon-Si, Gyeonggi-do 16677, Korea
Contact Person:	JP KIM
E-mail:	jp426.kim@samsung.com
Telephone:	+82-10-4376-0326
Fax:	N/A

4 Equipment Under Test (EUT) and Ancillary Equipment (AE)

4.1 About EUT

Description:	Multi-band GSM/WCDMA/LTE Tablet with Bluetooth, WLAN
Model name:	SM-T505
Operating mode(s):	GSM 850/900/1800/1900 WCDMA850/1700/1900/900/2100 LTE B1/2/3/4/5/7/8/12/17/18/19/20/38/40/66/ BT, WLAN
Tested Tx Frequency:	825 – 848.8 MHz (GSM 850)
	1850.2 – 1910 MHz (GSM 1900)
	826.4–846.6 MHz (WCDMA 850 Band V)
	1712.4 – 1752.6 MHz (WCDMA 1700 Band IV)
	1852.4–1907.6 MHz (WCDMA1900 Band II)
	1860 – 1900 MHz (LTE Band 2)
	824.7 – 848.3 MHz (LTE Band 5)
	2502.5 – 2567.5 MHz(LTE Band 7)
	699.7 – 715.3 MHz (LTE Band 12)
	817.5 – 827.5 MHz (LTE Band 18)
	832.5 – 842.5 MHz (LTE Band 19)
	704.5 –746.5 MHz (LTE Band 28)
	2572.5 –2617.5 (LTE Band 38)
	1710.7 – 1779.3 MHz (LTE Band 66)
2412 – 2462 MHz (Wi-Fi 2.4G)	
5.15 – 5.35 GHz 5.725 – 5.825 GHz(Wi-Fi 5G)	
GPRS/EGPRS Multislot Class:	33
Device type:	Tablet
Antenna type:	Embedded
Hotspot mode:	Support
Product dimension	Long 247.6mm ;Wide 157.36mm ; Diagonal 293.37mm

4.2 Internal Identification of EUT used during the test

EUT ID*	IMEI/SN	HW Version	SW Version
UT01a	2070165UT28a	REV1.0	T505.001
UT02a	2070165UT34a	REV1.0	T505.001
UT03a	2070165UT22a	REV1.0	T505.001
UT04a	2070165UT23a	REV1.0	T505.001

*EUT ID: is used to identify the test sample in the lab internally.

Note: It is performed to test SAR with the UT01a&UT02a and conducted power with the UT03a&UT04a.

4.3 Internal Identification of AE used during the test

AE ID	Description	Model	SN	Manufactory
AE1	Battery	SCUD-WT-N19	/	SCUD(Fujian)Electronics Co.,Ltd.

5 TEST METHODOLOGY

5.1 Applicable Limit Regulations

ANSI C95.1–1992: IEEE Standard for Safety Levels with Respect to Human Exposure to Radio Frequency Electromagnetic Fields, 3 kHz to 300 GHz.

It specifies the maximum exposure limit of **1.6 W/kg** as averaged over any 1 gram of tissue for portable devices being used within 20 cm of the user in the uncontrolled environment.

5.2 Applicable Measurement Standards

IEEE 1528–2013: Recommended Practice for Determining the Peak Spatial-Average Specific Absorption Rate (SAR) in the Human Head from Wireless Communications Devices: Measurement Techniques.

KDB447498 D01 General RF Exposure Guidance v06: Mobile and Portable Devices RF Exposure Procedures and Equipment Authorization Policies.

KDB616217 D04 SAR for laptop and tablets v01r02 SAR Evaluation Considerations for Laptop, Notebook, Notebook and Tablet Computers.

KDB648474 D04 Handset SAR v01r03: SAR Evaluation Considerations for Wireless Handsets.

KDB941225 D01 SAR test for 3G devices v03r01: SAR Measurement Procedures for 3G Devices

KDB941225 D05 SAR for LTE Devices v02r05: SAR Evaluation Considerations for LTE Devices

KDB248227 D01 802.11 Wi-Fi SAR v02r02: SAR GUIDANCE FOR IEEE 802.11 (Wi-Fi) TRANSMITTERS

KDB865664 D01 SAR measurement 100 MHz to 6 GHz v01r04: SAR Measurement Requirements for 100 MHz to 6 GHz.

KDB865664 D02 RF Exposure Reporting v01r02: RF Exposure Compliance Reporting and Documentation Considerations

6 Specific Absorption Rate (SAR)

6.1 Introduction

SAR is related to the rate at which energy is absorbed per unit mass in an object exposed to a radio field. The SAR distribution in a biological body is complicated and is usually carried out by experimental techniques or numerical modeling. The standard recommends limits for two tiers of groups, occupational/controlled and general population/uncontrolled, based on a person's awareness and ability to exercise control over his or her exposure. In general, occupational/controlled exposure limits are higher than the limits for general population/uncontrolled.

6.2 SAR Definition

The SAR definition is the time derivative (rate) of the incremental energy (dW) absorbed by (dissipated in) an incremental mass (dm) contained in a volume element (dv) of a given density (ρ). The equation description is as below:

$$SAR = \frac{d}{dt} \left(\frac{dW}{dm} \right) = \frac{d}{dt} \left(\frac{dW}{\rho dv} \right)$$

SAR is expressed in units of Watts per kilogram (W/kg)

SAR measurement can be either related to the temperature elevation in tissue by

$$SAR = c \left(\frac{\delta T}{\delta t} \right)$$

Where: C is the specific heat capacity, δT is the temperature rise and δt is the exposure duration, or related to the electrical field in the tissue by

$$SAR = \frac{\sigma |E|^2}{\rho}$$

Where: σ is the conductivity of the tissue, ρ is the mass density of tissue and E is the RMS electrical field strength.

However for evaluating SAR of low power transmitter, electrical field measurement is typically applied.

7 Tissue Simulating Liquids

7.1 Targets for tissue simulating liquid

Table 7.1: Targets for tissue simulating liquid

Frequency(MHz)	Liquid Type	Conductivity(σ)	$\pm 5\%$ Range	Permittivity(ϵ)	$\pm 5\%$ Range
750	Head	0.89	0.85~0.93	41.94	39.8~44.0
835	Head	0.90	0.86~0.95	41.5	39.4~43.6
1750	Head	1.37	1.30~1.44	40.08	38.1~42.1
1900	Head	1.40	1.33~1.47	40.0	38.0~42.0
2450	Head	1.80	1.71~1.89	39.2	37.2~41.2
5250	Head	4.71	4.47~4.95	35.93	34.13~37.73
5600	Head	5.07	4.82~5.32	35.53	33.8~37.3
5750	Head	5.22	4.96~5.48	35.36	33.59~37.13

7.2 Dielectric Performance

Table 7.2: Dielectric Performance of Tissue Simulating Liquid

Measurement Date yyyy/mm/dd	Frequency	Type	Permittivity ϵ	Drift (%)	Conductivity σ (S/m)	Drift (%)
2020/6/25	750 MHz	Head	42.5	1.34	0.89	0.00
2020/6/26	835 MHz	Head	40.69	-1.95	0.888	-1.33
2020/6/27	1750 MHz	Head	40.2	0.30	1.354	-1.17
2020/6/28	1900 MHz	Head	39.38	-1.55	1.411	0.79
2020/6/29	2450 MHz	Head	39.83	1.61	1.818	1.00
2020/6/30	2600 MHz	Head	39.01	0.00	1.956	-0.20
2020/7/1	5250 MHz	Head	36.07	0.39	4.729	0.40
2020/7/2	5600 MHz	Head	35.75	0.62	5.153	1.64
2020/7/3	5750 MHz	Head	35.73	1.05	5.201	-0.36

Note: The liquid temperature is 22.0°C



Picture 7-1 Liquid depth in the Flat Phantom (750 MHz)

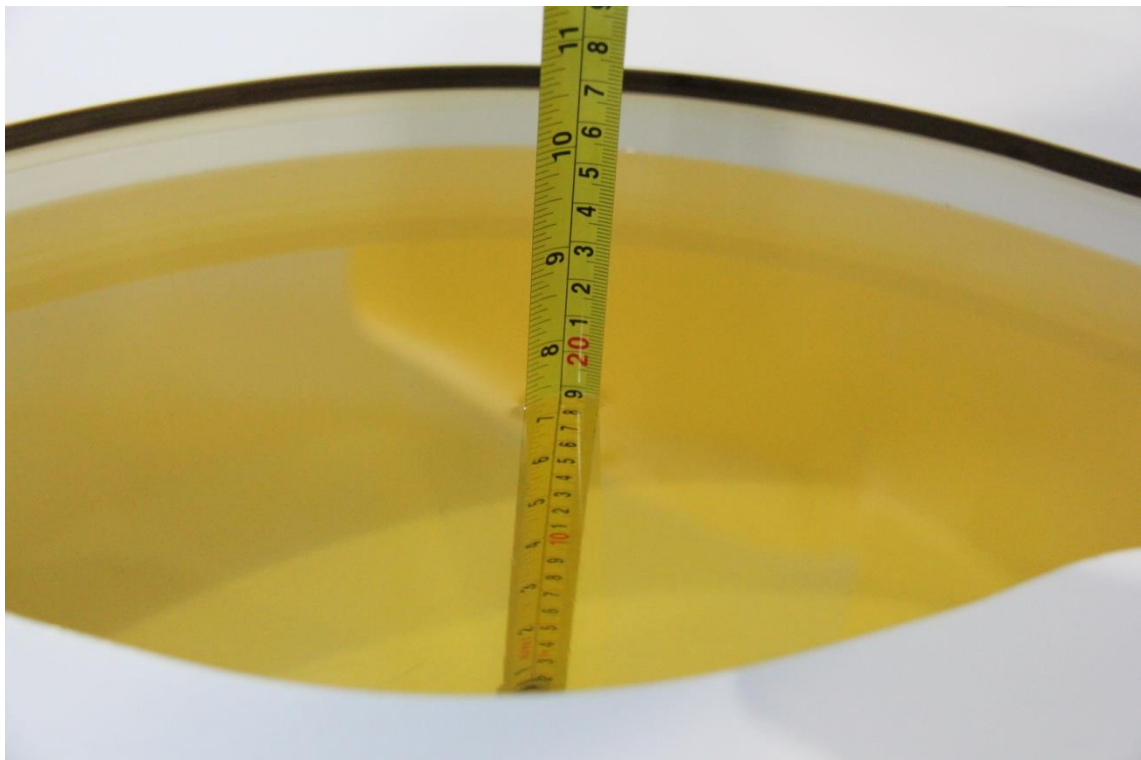

Picture 7-2 Liquid depth in the Flat Phantom (835MHz)

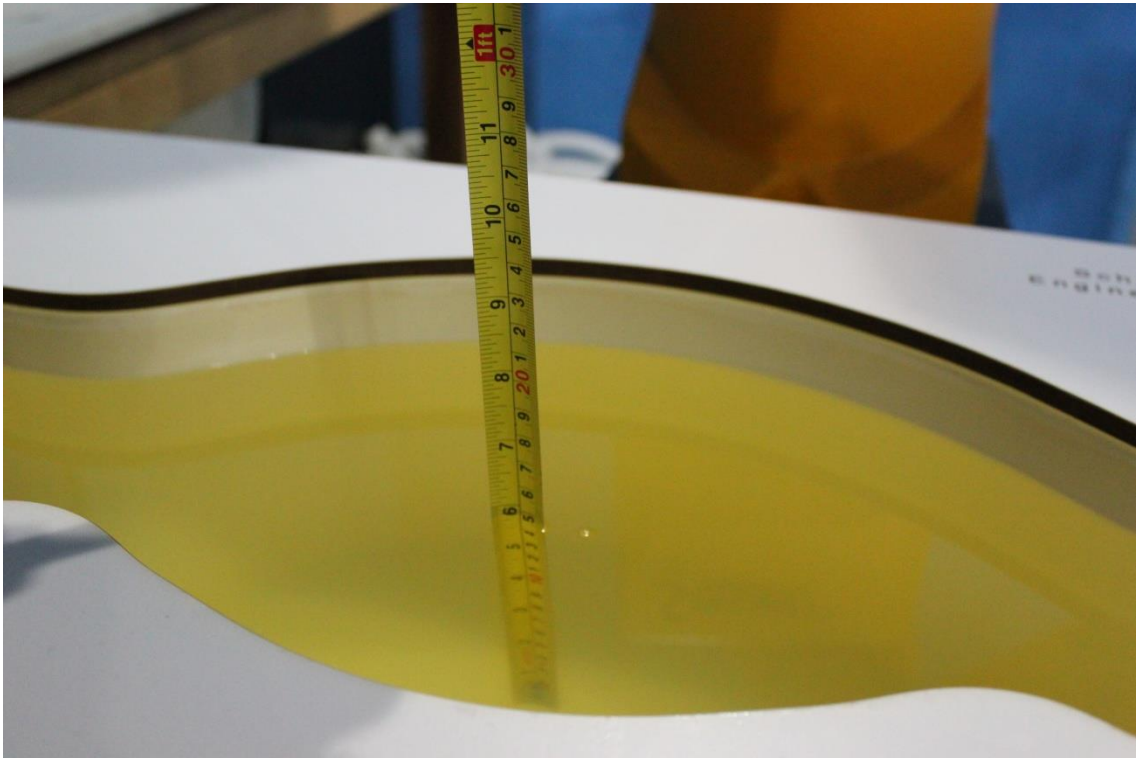

Picture 7-3 Liquid depth in the Flat Phantom (1750MHz)

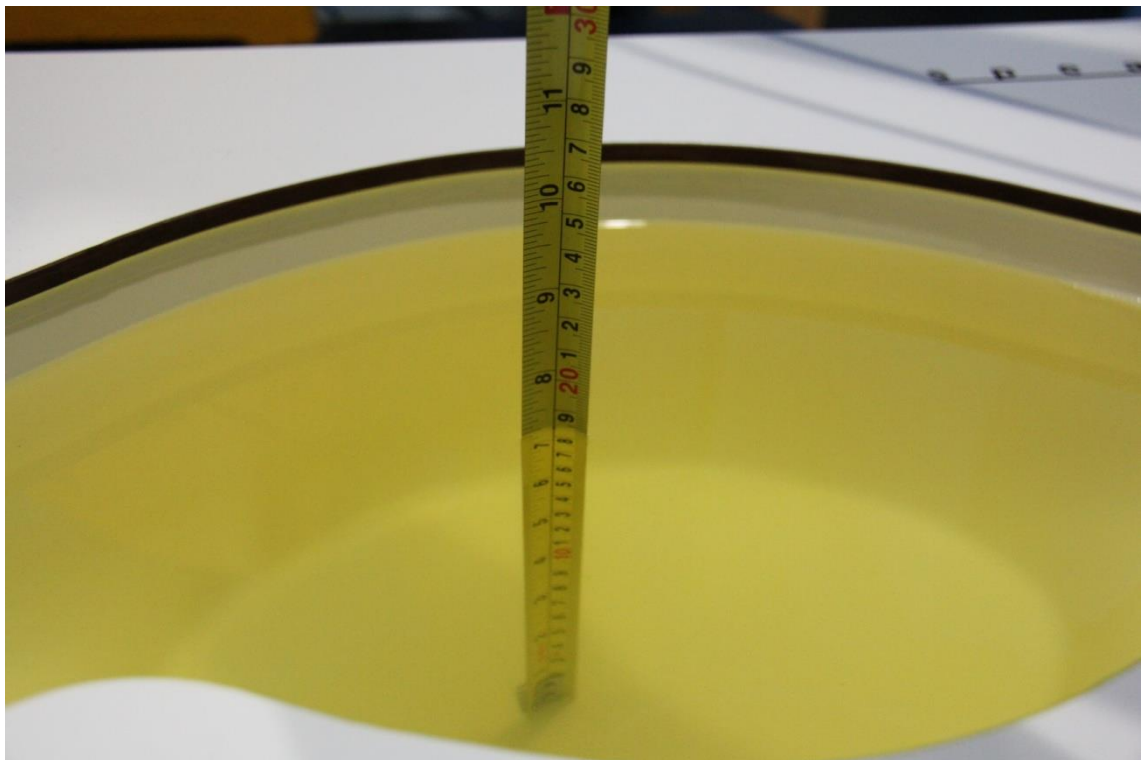

Picture 7-4 Liquid depth in the Flat Phantom (1900MHz)

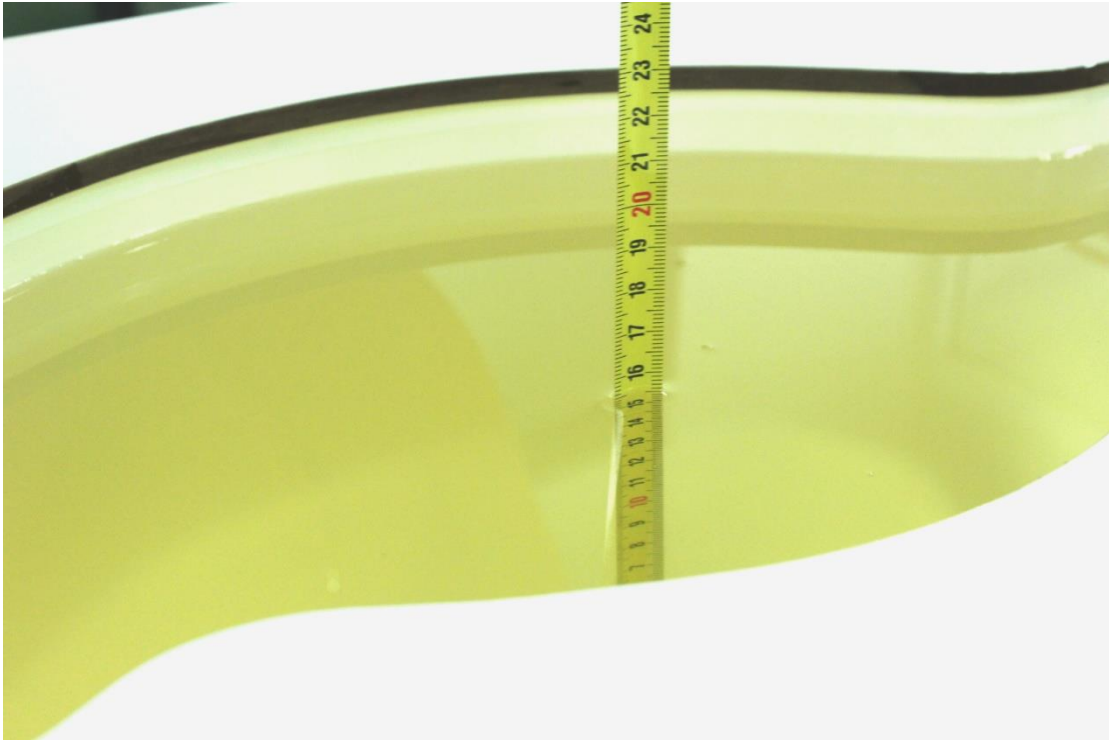

Picture 7-5 Liquid depth in the Flat Phantom (2450MHz)

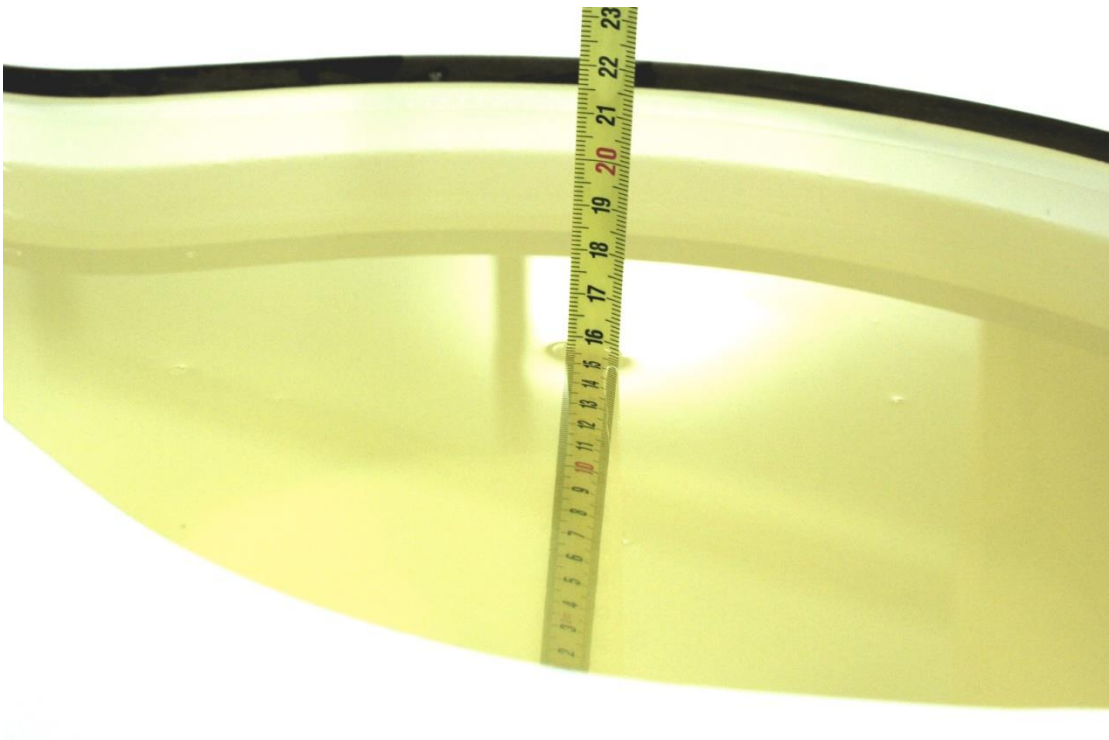

Picture 7-6 Liquid depth in the Flat Phantom (2600MHz)

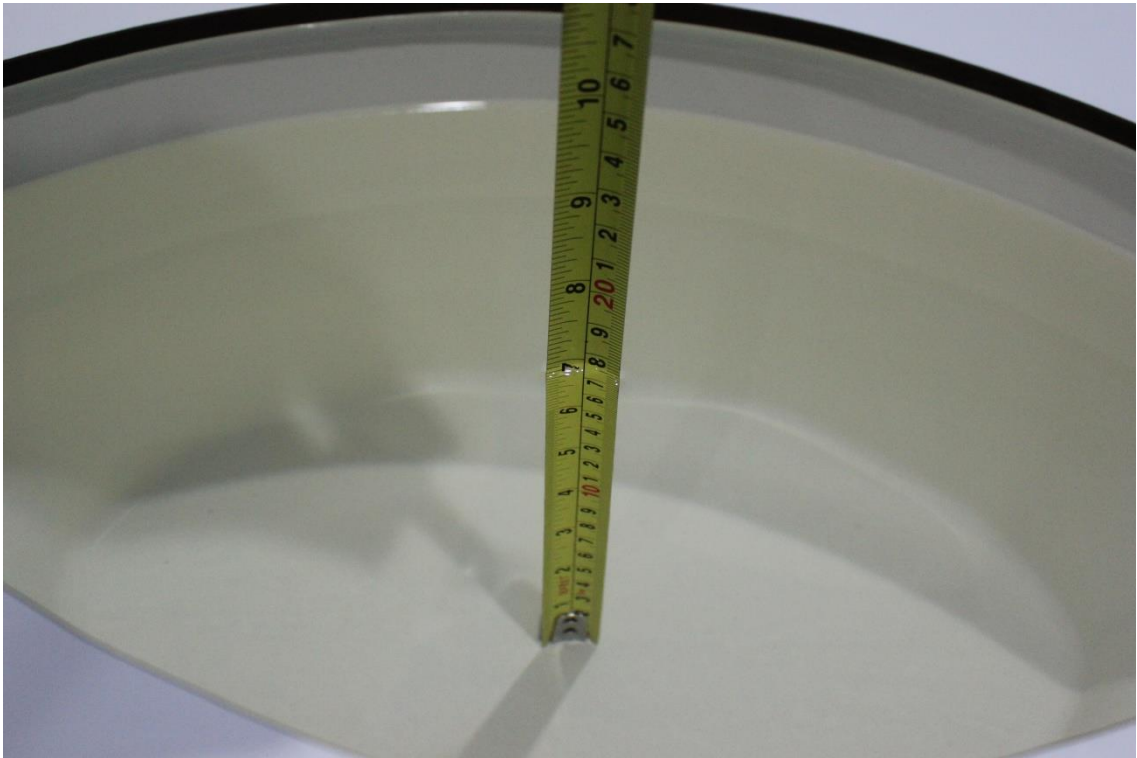

Picture 7-7 Liquid depth in the Flat Phantom (5GHz)

8 System verification

8.1 System Setup

In the simplified setup for system evaluation, the DUT is replaced by a calibrated dipole and the power source is replaced by a continuous wave that comes from a signal generator. The calibrated dipole must be placed beneath the flat phantom section of the SAM twin phantom with the correct distance holder. The distance holder should touch the phantom surface with a light pressure at the reference marking and be oriented parallel to the long side of the phantom. The equipment setup is shown below:

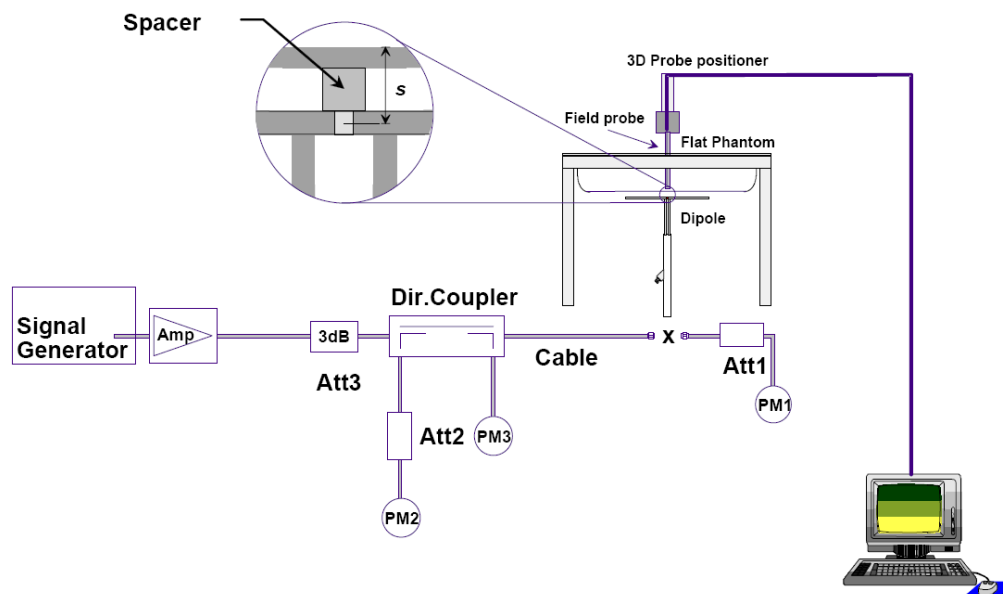

Picture 8.1 System Setup for System Evaluation



Picture 8.2 Photo of Dipole Setup

8.2 System Verification

SAR system verification is required to confirm measurement accuracy, according to the tissue dielectric media, probe calibration points and other system operating parameters required for measuring the SAR of a test device. The system verification must be performed for each frequency band and within the valid range of each probe calibration point required for testing the device.

The system verification results are required that the area scan estimated 1-g SAR is within 3% of the zoom scan 1-g SAR. The details are presented in annex B.

Table 8.1: System Verification of Body

Measurement Date (yyyy-mm-dd)	Frequency	Target value (W/kg)		Measured value (W/kg)		Deviation	
		10 g Average	1 g Average	10 g Average	1 g Average	10 g Average	1 g Average
2020-6-25	750 MHz	5.57	8.57	5.44	8.72	-2.33%	1.75%
2020-6-26	835 MHz	6.29	9.70	6.24	9.8	-0.79%	1.03%
2020-6-27	1750 MHz	19.3	36.6	19.68	36.48	1.97%	-0.33%
2020-6-28	1900 MHz	20.8	39.7	20.72	40.04	-0.38%	0.86%
2020-6-29	2450 MHz	24.2	51.6	24.48	51.12	1.16%	-0.93%
2020-6-30	2600 MHz	25.1	55.8	25.16	55.64	0.24%	-0.29%
2020-7-1	5250 MHz	23.2	80.4	23.5	79.9	1.21%	-0.60%
2020-7-2	5600 MHz	24.1	84.5	24.0	84.7	-0.41%	0.26%
2020-7-3	5750 MHz	23.0	80.4	23.3	79.6	1.22%	-1.00%

9 Measurement Procedures

9.1 Tests to be performed

In order to determine the highest value of the peak spatial-average SAR of a handset, all device positions, configurations and operational modes shall be tested for each frequency band according to steps 1 to 3 below. A flowchart of the test process is shown in picture 9.1.

Step 1: The tests described in 9.2 shall be performed at the channel that is closest to the center of the transmit frequency band (f_c) for:

- a) all device positions (cheek and tilt, for both left and right sides of the SAM phantom, as described in annex D),
- b) all configurations for each device position in a), e.g., antenna extended and retracted, and
- c) all operational modes, e.g., analogue and digital, for each device position in a) and configuration in b) in each frequency band.

If more than three frequencies need to be tested according to 11.1 (i.e., $N_c > 3$), then all frequencies, configurations and modes shall be tested for all of the above test conditions.

Step 2: For the condition providing highest peak spatial-average SAR determined in Step 1, perform all tests described in 9.2 at all other test frequencies, i.e., lowest and highest frequencies. In addition, for all other conditions (device position, configuration and operational mode) where the peak spatial-average SAR value determined in Step 1 is within 3 dB of the applicable SAR limit, it is recommended that all other test frequencies shall be tested as well.

Step 3: Examine all data to determine the highest value of the peak spatial-average SAR found in Steps 1 to 2.

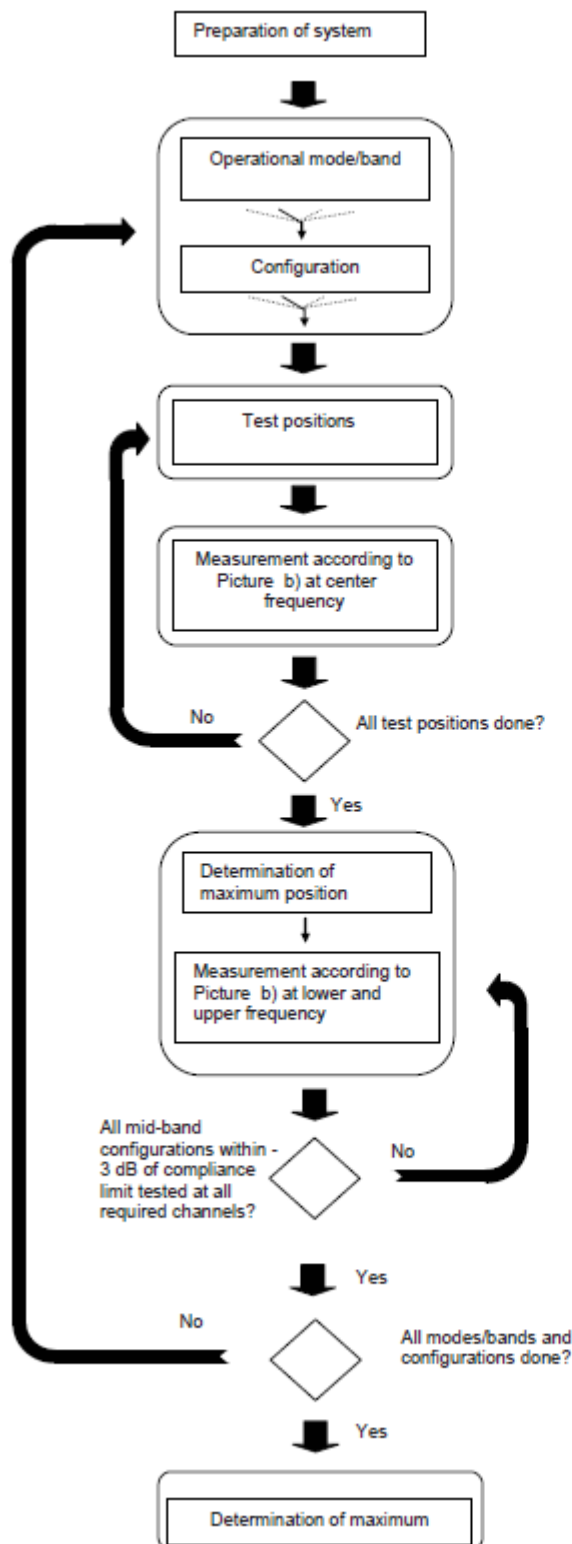

Picture a – Tests to be performed

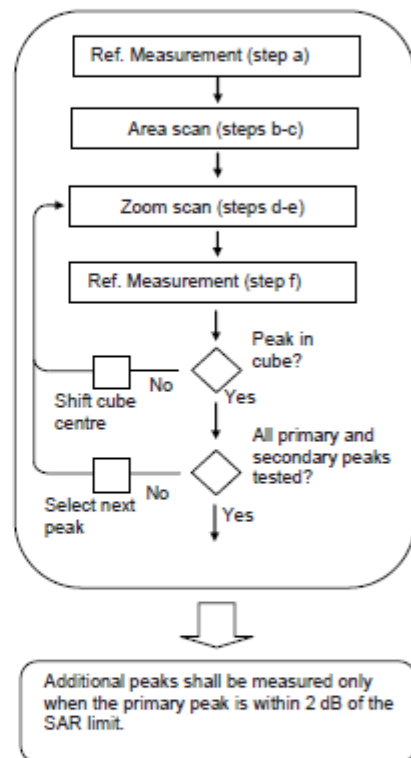

Picture b – General procedure

Picture 9.1 Block diagram of the tests to be performed

9.2 General Measurement Procedure

The area and zoom scan resolutions specified in the table below must be applied to the SAR measurements and fully documented in SAR reports to qualify for TCB approval. Probe boundary effect error compensation is required for measurements with the probe tip closer than half a probe tip diameter to the phantom surface. Both the probe tip diameter and sensor offset distance must satisfy measurement protocols; to ensure probe boundary effect errors are minimized and the higher fields closest to the phantom surface can be correctly measured and extrapolated to the phantom surface for computing 1-g SAR. Tolerances of the post-processing algorithms must be verified by the test laboratory for the scan resolutions used in the SAR measurements, according to the reference distribution functions specified in IEEE Std 1528-2013. The results should be documented as part of the system validation records and may be requested to support test results when all the measurement parameters in the following table are not satisfied.

		≤ 3 GHz	> 3 GHz	
Maximum distance from closest measurement point (geometric center of probe sensors) to phantom surface		5 ± 1 mm	$\frac{1}{2} \cdot \delta \cdot \ln(2) \pm 0.5$ mm	
Maximum probe angle from probe axis to phantom surface normal at the measurement location		$30^\circ \pm 1^\circ$	$20^\circ \pm 1^\circ$	
Maximum area scan spatial resolution: Δx_{Area} , Δy_{Area}		≤ 2 GHz: ≤ 15 mm 2 – 3 GHz: ≤ 12 mm	3 – 4 GHz: ≤ 12 mm 4 – 6 GHz: ≤ 10 mm	
		When the x or y dimension of the test device, in the measurement plane orientation, is smaller than the above, the measurement resolution must be \leq the corresponding x or y dimension of the test device with at least one measurement point on the test device.		
Maximum zoom scan spatial resolution: Δx_{Zoom} , Δy_{Zoom}		≤ 2 GHz: ≤ 8 mm 2 – 3 GHz: ≤ 5 mm*	3 – 4 GHz: ≤ 5 mm* 4 – 6 GHz: ≤ 4 mm*	
Maximum zoom scan spatial resolution, normal to phantom surface	uniform grid: $\Delta z_{Zoom}(n)$	≤ 5 mm	3 – 4 GHz: ≤ 4 mm 4 – 5 GHz: ≤ 3 mm 5 – 6 GHz: ≤ 2 mm	
	graded grid	$\Delta z_{Zoom}(1)$: between 1 st two points closest to phantom surface	≤ 4 mm	3 – 4 GHz: ≤ 3 mm 4 – 5 GHz: ≤ 2.5 mm 5 – 6 GHz: ≤ 2 mm
		$\Delta z_{Zoom}(n>1)$: between subsequent points	$\leq 1.5 \cdot \Delta z_{Zoom}(n-1)$	
Minimum zoom scan volume	x, y, z	≥ 30 mm	3 – 4 GHz: ≥ 28 mm 4 – 5 GHz: ≥ 25 mm 5 – 6 GHz: ≥ 22 mm	
Note: δ is the penetration depth of a plane-wave at normal incidence to the tissue medium; see draft standard IEEE P1528-2011 for details.				
* When zoom scan is required and the <i>reported</i> SAR from the area scan based 1-g SAR estimation procedures of KDB 447498 is ≤ 1.4 W/kg, ≤ 8 mm, ≤ 7 mm and ≤ 5 mm zoom scan resolution may be applied, respectively, for 2 GHz to 3 GHz, 3 GHz to 4 GHz and 4 GHz to 6 GHz.				

9.3 WCDMA Measurement Procedures for SAR

The following procedures are applicable to WCDMA handsets operating under 3GPP Release99, Release 5 and Release 6. The default test configuration is to measure SAR with an established radio link between the DUT and a communication test set using a 12.2kbps RMC (reference measurement channel) configured in Test Loop Mode 1. SAR is selectively confirmed for other physical channel configurations (DPCCH & DPDCH_n), HSDPA and HSPA (HSUPA/HSDPA) modes according to output power, exposure conditions and device operating capabilities. Both uplink and downlink should be configured with the same RMC or AMR, when required. SAR for Release 5 HSDPA and Release 6 HSPA are measured using the applicable FRC (fixed reference channel) and E-DCH reference channel configurations. Maximum output power is verified according to applicable versions of 3GPP TS 34.121 and SAR must be measured according to these maximum output conditions. When Maximum Power Reduction (MPR) is not implemented according to Cubic Metric (CM) requirements for Release 6 HSPA, the following procedures do not apply.

For Release 5 HSDPA Data Devices:

Sub-test	β_c	β_d	β_d (SF)	β_c / β_d	β_{hs}	CM/dB
1	2/15	15/15	64	2/15	4/15	0.0
2	12/15	15/15	64	12/15	24/25	1.0
3	15/15	8/15	64	15/8	30/15	1.5
4	15/15	4/15	64	15/4	30/15	1.5

For Release 6 HSPA Data Devices

Sub-test	β_c	β_d	β_d (SF)	β_c / β_d	β_{hs}	β_{ec}	β_{ed}	β_{ed} (SF)	β_{ed} (codes)	CM (dB)	MPR (dB)	AG Index	E-TFCI
1	11/15	15/15	64	11/15	22/15	209/225	1039/225	4	1	1.5	1.5	20	75
2	6/15	15/15	64	6/15	12/15	12/15	12/15	4	1	1.5	1.5	12	67
3	15/15	9/15	64	15/9	30/15	30/15	$\beta_{ed1}:47/15$ $\beta_{ed2}:47/15$	4	2	1.5	1.5	15	92
4	2/15	15/15	64	2/15	4/15	4/15	56/75	4	1	1.5	1.5	17	71
5	15/15	15/15	64	15/15	24/15	30/15	134/15	4	1	1.5	1.5	21	81

Rel.8 DC-HSDPA (Cat 24)

SAR test exclusion for Rel.8 DC-HSDPA must satisfy the SAR test exclusion requirements of Rel.5 HSDPA. SAR test exclusion for DC-HSDPA devices is determined by power measurements according to the H-Set 12, Fixed Reference Channel (FRC) configuration in Table C.8.1.12 of 3GPP TS 34.121-1. A primary and a secondary serving HS-DSCH Cell are required to perform the power measurement and for the results to qualify for SAR test exclusion.

9.4 SAR Measurement for LTE

SAR tests for LTE are performed with a base station simulator, Rohde & Schwarz CMW500. Closed loop power control was used so the UE transmits with maximum output power during SAR testing. All powers were measured with the CMW 500.

It is performed for conducted power and SAR based on the KDB941225 D05.

SAR is evaluated separately according to the following procedures for the different test positions in each exposure condition – head, body, body-worn accessories and other use conditions. The procedures in the following subsections are applied separately to test each LTE frequency band.

1) QPSK with 1 RB allocation

Start with the largest channel bandwidth and measure SAR for QPSK with 1 RB allocation, using the RB offset and required test channel combination with the highest maximum output power among RB offsets at the upper edge, middle and lower edge of each required test channel. When the reported SAR is ≤ 0.8 W/kg, testing of the remaining RB offset configurations and required test channels is not required for 1 RB allocation; otherwise, SAR is required for the remaining required test channels and only for the RB offset configuration with the highest output power for that channel. When the reported SAR of a required test channel is > 1.45 W/kg, SAR is required for all three RB offset configurations for that required test channel.

2) QPSK with 50% RB allocation

The procedures required for 1 RB allocation in 1) are applied to measure the SAR for QPSK with 50% RB allocation.

3) QPSK with 100% RB allocation

For QPSK with 100% RB allocation, SAR is not required when the highest maximum output power for 100 % RB allocation is less than the highest maximum output power in 50% and 1 RB allocations and the highest reported SAR for 1 RB and 50% RB allocation in 1) and 2) are ≤ 0.8 W/kg. Otherwise, SAR is measured for the highest output power channel; and if the reported SAR is > 1.45 W/kg, the remaining required test channels must also be tested.

9.5 Bluetooth & Wi-Fi Measurement Procedures for SAR

Normal network operating configurations are not suitable for measuring the SAR of 802.11 transmitters in general. Unpredictable fluctuations in network traffic and antenna diversity conditions can introduce undesirable variations in SAR results. The SAR for these devices should be measured using chipset based test mode software to ensure that the results are consistent and reliable.

Chipset based test mode software is hardware dependent and generally varies among manufacturers. The device operating parameters established in a test mode for SAR measurements must be identical to those programmed in production units, including output power levels, amplifier gain settings and other RF performance tuning parameters. The test frequencies should correspond to actual channel frequencies defined for domestic use. SAR for devices with switched diversity should be measured with only one antenna transmitting at a time during each SAR measurement, according to a fixed modulation and data rate. The same data pattern should be used for all measurements.



9.6 Power Drift

To control the output power stability during the SAR test, DASY4 system calculates the power drift by measuring the E-field at the same location at the beginning and at the end of the measurement for each test position. These drift values can be found in section 14 labeled as: (Power Drift [dB]). This ensures that the power drift during one measurement is within 5%.

10 Area Scan Based 1-g SAR

10.1 Requirement of KDB

According to the KDB447498 D01 v05, when the implementation is based the specific polynomial fit

algorithm as presented at the 29th Bioelectromagnetics Society meeting (2007) and the estimated 1-g SAR is ≤ 1.2 W/kg, a zoom scan measurement is not required provided it is also not needed for any other purpose; for example, if the peak SAR location required for simultaneous transmission SAR test exclusion can be determined accurately by the SAR system or manually to discriminate between distinctive peaks and scattered noisy SAR distributions from area scans.

There must not be any warning or alert messages due to various measurement concerns identified by the SAR system; for example, noise in measurements, peaks too close to scan boundary, peaks are too sharp, spatial resolution and uncertainty issues etc. The SAR system verification must also demonstrate that the area scan estimated 1-g SAR is within 3% of the zoom scan 1-g SAR (See Annex B). When all the SAR results for each exposure condition in a frequency band and wireless mode are based on estimated 1-g SAR, the 1-g SAR for the highest SAR configuration must be determined by a zoom scan.

10.2 Fast SAR Algorithms

The approach is based on the area scan measurement applying a frequency dependent attenuation parameter. This attenuation parameter was empirically determined by analyzing a large number of phones. The MOTOROLA FAST SAR was developed and validated by the MOTOROLA Research Group in Ft. Lauderdale.

In the initial study, an approximation algorithm based on Linear fit was developed. The accuracy of the algorithm has been demonstrated across a broad frequency range (136-2450 MHz) and for both 1- and 10-g averaged SAR using a sample of 264 SAR measurements from 55 wireless handsets. For the sample size studied, the root-mean-squared errors of the algorithm are 1.2% and 5.8% for 1- and 10-g averaged SAR, respectively. The paper describing the algorithm in detail is expected to be published in August 2004 within the Special Issue of Transactions on MTT.

In the second step, the same research group optimized the fitting algorithm to an Polynomial fit whereby the frequency validity was extended to cover the range 30-6000MHz. Details of this study can be found in the BEMS 2007 Proceedings.

Both algorithms are implemented in DASY software.

11 Conducted Output Power

There are two sets of tune-up power, Normal power and Low power, for GSM850/1900, WCDMA B2/4/5, LTE Band2,5,7,12,18,19,28,38,66 by proximity sensor. The detail of proximity sensor is presented in annex I.

11.1 GSM Measurement result

During the process of testing, the EUT was controlled via Agilent Digital Radio Communication tester (E5515C) to ensure the maximum power transmission and proper modulation. This result contains conducted output power for the EUT. In all cases, the measured peak output power should be greater and within 5% than EMI measurement.

Normal Power

Table 11.1-1: The conducted power measurement results for GSM, GPRS and EGPRS

GSM 850 Speech (GMSK)	Measured Power (dBm)			Tune up	calculation	Averaged Power (dBm)		
	251	190	128			251	190	128
1 Txslot	32.18	32.19	32.00	33.50	/	/	/	/
GSM 850 GPRS (GMSK)	Measured Power (dBm)				calculation	Averaged Power (dBm)		
	251	190	128			251	190	128
1 Txslot	32.97	32.85	32.76	33.50	-9.03	23.94	23.82	23.73
2 Txslots	32.07	31.95	32.38	32.50	-6.02	26.05	25.93	26.36
3 Txslots	29.93	29.80	29.70	30.50	-4.26	25.67	25.54	25.44
4 Txslots	28.50	28.42	28.36	29.50	-3.01	25.49	25.41	25.35
GSM 850 EGPRS (GMSK)	Measured Power (dBm)				calculation	Averaged Power (dBm)		
	251	190	128			251	190	128
1 Txslot	32.81	32.80	32.73	33.50	-9.03	23.78	23.77	23.70
2 Txslots	31.93	31.90	32.35	32.50	-6.02	25.91	25.88	26.33
3 Txslots	29.83	29.74	29.67	30.50	-4.26	25.57	25.48	25.41
4 Txslots	28.40	28.38	28.31	29.50	-3.01	25.39	25.37	25.30
GSM 850 EGPRS (8PSK)	Measured Power (dBm)				calculation	Averaged Power (dBm)		
	251	190	128			251	190	128
1 Txslot	26.27	26.18	26.29	27.00	-9.03	17.24	17.15	17.26
2 Txslots	24.45	24.44	24.48	25.50	-6.02	18.43	18.42	18.46
3 Txslots	22.25	22.26	22.31	23.50	-4.26	17.99	18.00	18.05
4 Txslots	21.76	21.47	21.11	22.50	-3.01	18.75	18.46	18.10
PCS1900 Speech (GMSK)	Measured Power (dBm)			Tune up	calculation	Averaged Power (dBm)		
	810	661	512			810	661	512
1 Txslot	30.22	30.31	30.13	31.00	/	/	/	/
PCS1900 GPRS (GMSK)	Measured Power (dBm)				calculation	Averaged Power (dBm)		
	810	661	512			810	661	512
1 Txslot	30.18	30.35	30.07	31.00	-9.03	21.15	21.32	21.04
2 Txslots	29.44	29.11	29.20	29.50	-6.02	23.42	23.09	23.18
3 Txslots	27.00	26.98	26.81	27.50	-4.26	22.74	22.72	22.55

4 Txslots	25.77	25.50	25.69	26.50	-3.01	22.76	22.49	22.68
PCS1900 EGPRS (GMSK)	Measured Power (dBm)				calculation	Averaged Power (dBm)		
	810	661	512			810	661	512
1 Txslot	30.02	30.26	30.05	31.00	-9.03	20.99	21.23	21.02
2 Txslots	29.32	29.10	29.19	29.50	-6.02	23.30	23.08	23.17
3 Txslots	26.96	27.00	26.81	27.50	-4.26	22.70	22.74	22.55
4 Txslots	25.79	25.53	25.69	26.50	-3.01	22.78	22.52	22.68
PCS1900 EGPRS (8PSK)	Measured Power (dBm)				calculation	Averaged Power (dBm)		
	810	661	512			810	661	512
1 Txslot	25.04	25.63	24.98	26.00	-9.03	16.01	16.60	15.95
2 Txslots	23.84	23.95	23.80	25.00	-6.02	17.82	17.93	17.78
3 Txslots	22.07	21.64	21.84	23.00	-4.26	17.81	17.38	17.58
4 Txslots	20.50	20.42	20.42	22.00	-3.01	17.49	17.41	17.41

NOTES:

1) Division Factors

To average the power, the division factor is as follows:

1TX-slot = 1 transmit time slot out of 8 time slots=> conducted power divided by (8/1) => -9.03dB

2TX-slots = 2 transmit time slots out of 8 time slots=> conducted power divided by (8/2) => -6.02dB

3TX-slots = 3 transmit time slots out of 8 time slots=> conducted power divided by (8/3) => -4.26dB

4TX-slots = 4 transmit time slots out of 8 time slots=> conducted power divided by (8/4) => -3.01dB

According to the conducted power as above, the body measurements are performed with 2Txslots for GSM850 and GSM1900.

Low Power

GSM 850 Speech (GMSK)	Measured Power (dBm)			Tune up	calculation	Averaged Power (dBm)		
	251	190	128			251	190	128
1 Txslot	26.83	26.74	26.75	27.00	/	/	/	/
GSM 850 GPRS (GMSK)	Measured Power (dBm)				calculation	Averaged Power (dBm)		
	251	190	128			251	190	128
1 Txslot	26.84	26.69	26.68	27.00	-9.03	17.81	17.66	17.65
2 Txslots	23.44	23.53	23.53	24.00	-6.02	17.42	17.51	17.51
3 Txslots	21.84	21.73	21.69	22.30	-4.26	17.58	17.47	17.43
4 Txslots	20.51	20.40	20.36	21.00	-3.01	17.50	17.39	17.35
GSM 850 EGPRS (GMSK)	Measured Power (dBm)				calculation	Averaged Power (dBm)		
	251	190	128			251	190	128
1 Txslot	26.70	26.63	26.63	27.00	-9.03	17.67	17.60	17.60
2 Txslots	23.33	23.47	23.48	24.00	-6.02	17.31	17.45	17.46
3 Txslots	21.75	21.68	21.64	22.30	-4.26	17.49	17.42	17.38
4 Txslots	20.41	20.36	20.31	21.00	-3.01	17.40	17.35	17.30

GSM 850 EGPRS (8PSK)	Measured Power (dBm)				calculation	Averaged Power (dBm)		
	251	190	128			251	190	128
1 Txslot	25.95	26.04	26.00	27.00	-9.03	16.92	17.01	16.97
2 Txslots	23.07	23.10	23.11	24.00	-6.02	17.05	17.08	17.09
3 Txslots	21.66	21.67	21.69	22.30	-4.26	17.40	17.41	17.43
4 Txslots	20.20	20.23	20.23	21.00	-3.01	17.19	17.22	17.22
PCS1900 Speech (GMSK)	Measured Power (dBm)			Tune up	calculation	Averaged Power (dBm)		
	810	661	512			810	661	512
1 Txslot	21.73	21.95	21.92	22.50	/	/	/	/
PCS1900 GPRS (GMSK)	Measured Power (dBm)				calculation	Averaged Power (dBm)		
	810	661	512			810	661	512
1 Txslot	21.82	21.73	21.65	22.50	-9.03	12.79	12.70	12.62
2 Txslots	18.91	18.75	18.89	19.50	-6.02	12.89	12.73	12.87
3 Txslots	17.21	17.03	17.19	17.80	-4.26	12.95	12.77	12.93
4 Txslots	15.52	15.67	15.82	16.50	-3.01	12.51	12.66	12.81
PCS1900 EGPRS (GMSK)	Measured Power (dBm)				calculation	Averaged Power (dBm)		
	810	661	512			810	661	512
1 Txslot	21.76	21.76	21.62	22.50	-9.03	12.73	12.73	12.59
2 Txslots	18.86	18.74	18.85	19.50	-6.02	12.84	12.72	12.83
3 Txslots	17.16	17.01	17.16	17.80	-4.26	12.90	12.75	12.90
4 Txslots	15.48	15.66	15.80	16.50	-3.01	12.47	12.65	12.79
PCS1900 EGPRS (8PSK)	Measured Power (dBm)				calculation	Averaged Power (dBm)		
	810	661	512			810	661	512
1 Txslot	21.56	21.60	21.58	22.50	-9.03	12.53	12.57	12.55
2 Txslots	17.89	17.92	17.91	19.50	-6.02	11.87	11.90	11.89
3 Txslots	17.16	17.19	17.09	17.80	-4.26	12.90	12.93	12.83
4 Txslots	15.87	15.94	15.83	16.50	-3.01	12.86	12.93	12.82

NOTES:

1) Division Factors

To average the power, the division factor is as follows:

1TX-slot = 1 transmit time slot out of 8 time slots=> conducted power divided by (8/1) => -9.03dB

2TX-slots = 2 transmit time slots out of 8 time slots=> conducted power divided by (8/2) => -6.02dB

3TX-slots = 3 transmit time slots out of 8 time slots=> conducted power divided by (8/3) => -4.26dB

4TX-slots = 4 transmit time slots out of 8 time slots=> conducted power divided by (8/4) => -3.01dB

According to the conducted power as above, the body measurements are performed with 1Txslots for GSM850 and 3Txslots for GSM1900.

11.2 WCDMA Measurement result

Table 11.2-1: The conducted Power for WCDMA- Normal power

Item	band	FDDV result			
	ARFCN	4233 (846.6MHz)	4182 (836.4MHz)	4132 (826.4MHz)	Tune up
WCDMA	\	22.99	23.03	22.92	24.00
HSUPA	1	22.02	21.99	22.03	22.50
	2	19.89	19.85	19.91	20.50
	3	20.93	20.99	20.96	21.50
	4	19.80	19.92	20.03	20.50
	5	21.96	21.98	21.89	22.50
HSPA+	\	21.54	21.49	21.55	23.00
DC-HSDPA	1	21.94	21.99	22.01	22.50
	2	21.93	21.95	21.98	22.50
	3	21.42	21.43	21.45	22.00
	4	21.41	21.42	21.43	22.00
Item	band	FDDIV result			
	ARFCN	1513 (1752.6MHz)	1412 (1732.4MHz)	1312 (1712.4MHz)	Tune up
WCDMA	\	23.68	23.75	23.71	24.50
HSUPA	1	22.65	22.63	22.55	23.00
	2	20.66	20.64	20.62	21.00
	3	21.63	21.60	21.64	22.00
	4	20.61	20.57	20.61	21.00
	5	22.64	22.68	22.62	23.00
HSPA+		22.34	22.30	22.31	23.00
DC-HSDPA	1	22.92	22.79	22.68	23.00
	2	22.81	22.74	22.61	23.00
	3	22.31	22.23	22.02	22.50
	4	22.25	22.20	22.01	22.50
Item	band	FDDII result			
	ARFCN	9538 (1907.6MHz)	9400 (1880MHz)	9262 (1852.4MHz)	Tune up
WCDMA	\	23.87	23.66	23.70	24.50
HSUPA	1	22.62	22.65	22.76	23.00
	2	20.70	20.62	20.71	21.00
	3	21.66	21.60	21.74	22.00
	4	20.65	20.63	20.68	21.00
	5	22.70	22.66	22.74	23.00
DC-HSDPA	1	22.38	22.30	22.29	23.00
	2	22.75	22.79	22.34	23.00
	3	22.68	22.69	22.78	23.00
	4	22.17	22.16	22.27	22.50

Table 11.2-2: The conducted Power for WCDMA- Low power

Item	band	FDDV result			
	ARFCN	4233 (846.6MHz)	4182 (836.4MHz)	4132 (826.4MHz)	Tune up
WCDMA	\	17.11	17.17	17.14	18.00
HSUPA	1	16.20	16.19	16.25	18.00
	2	14.11	14.19	14.17	16.00
	3	15.08	15.15	15.20	17.00
	4	14.22	14.18	14.14	16.00
	5	16.22	16.17	16.21	18.00
HSPA+	\	15.61	15.71	15.64	17.60
DC-HSDPA	1	16.11	16.17	16.13	18.00
	2	16.12	16.16	16.14	18.00
	3	15.63	15.70	15.65	17.60
	4	15.61	15.69	15.63	17.60
Item	band	FDDIV result			
	ARFCN	1513 (1752.6MHz)	1412 (1732.4MHz)	1312 (1712.4MHz)	
WCDMA	\	13.21	13.14	13.25	13.30
HSUPA	1	12.18	12.21	12.30	13.30
	2	10.23	10.15	10.31	12.20
	3	11.19	11.24	11.27	13.10
	4	10.17	10.18	10.29	12.10
	5	12.23	12.21	12.33	13.30
HSPA+	\	11.74	11.83	11.85	13.30
DC-HSDPA	1	12.24	12.20	12.29	13.30
	2	12.22	12.21	12.30	13.30
	3	11.64	11.61	11.71	13.30
	4	11.63	11.60	11.68	13.30
Item	band	FDDII result			
	ARFCN	9538 (1907.6MHz)	9400 (1880MHz)	9262 (1852.4MHz)	Tune up
WCDMA	\	12.38	12.37	12.50	12.70
HSUPA	1	11.41	11.42	11.51	12.70
	2	9.40	9.51	9.53	11.40
	3	10.41	10.39	10.52	12.30
	4	9.44	9.42	9.57	11.40
	5	11.44	11.50	11.56	12.40
HSPA+	\	10.98	11.04	11.05	12.70
DC-HSDPA	1	11.38	11.49	11.50	12.70
	2	11.37	11.45	11.49	12.70
	3	10.89	11.01	11.04	12.70
	4	10.91	10.99	11.02	12.70

11.3 LTE Measurement result

Table 11.3-1: Maximum Power Reduction (MPR) for LTE

Modulation	Channel bandwidth / Transmission bandwidth configuration [RB]						MPR (dB)
	1.4 MHz	3 MHz	5 MHz	10 MHz	15 MHz	20 MHz	
QPSK	> 5	> 4	> 8	> 12	> 16	> 18	1
16 QAM	≤ 5	≤ 4	≤ 8	≤ 12	≤ 16	≤ 18	1
16 QAM	> 5	> 4	> 8	> 12	> 16	> 18	2

Table 11.3-2: The tune up for LTE- Normal power

Band	Tune up
LTE Band 2	24.5
LTE Band 5	24.5
LTE Band 7	23.8
LTE Band 12	25.7
LTE Band 18	24.5
LTE Band 19	24.5
LTE Band 28	25.7
LTE Band 38	25
LTE Band 66	24.7

Table 11.3-3: The tune up for LTE- Low power

Band	Tune up
LTE Band 2	12.7
LTE Band 5	17.8
LTE Band 7	11.7
LTE Band 12	17.1
LTE Band 18	17.6
LTE Band 19	17.2
LTE Band 28	16.6
LTE Band 38	13.1
LTE Band 66	12.8

Normal power

Band2						
BANDWIDTH	Number of RBs	Frequency	QPSK	16QAM	64QAM	
1.4MHz	1RB-High (5)	1909.3 (19193)	23.21	23.05	21.51	
		1880 (18900)	23.16	22.63	21.58	
		1850.7 (18607)	23.12	22.72	21.54	
	1RB-Middle (3)	1909.3 (19193)	23.30	23.25	21.45	
		1880 (18900)	23.23	22.67	21.67	
		1850.7 (18607)	23.10	22.72	21.62	
	1RB-Low (0)	1909.3 (19193)	23.17	23.03	21.58	
		1880 (18900)	23.19	22.65	21.40	
		1850.7 (18607)	23.15	22.74	21.51	
	3RB-High (3)	1909.3 (19193)	23.09	22.82	21.53	
		1880 (18900)	23.18	22.77	21.45	
		1850.7 (18607)	23.11	22.62	21.59	
	3RB-Middle (1)	1909.3 (19193)	23.11	22.95	21.52	
		1880 (18900)	23.23	22.84	21.77	
		1850.7 (18607)	23.19	22.64	21.54	
	3RB-Low (0)	1909.3 (19193)	23.13	22.84	21.47	
		1880 (18900)	23.17	22.81	21.27	
		1850.7 (18607)	23.11	22.61	21.52	
	6RB (0)	1909.3 (19193)	22.64	21.57	20.38	
		1880 (18900)	22.62	21.81	20.40	
		1850.7 (18607)	22.61	21.83	20.52	
	3MHz	1RB-High (14)	1908.5 (19185)	23.15	23.03	21.77
			1880 (18900)	23.29	22.72	21.61
			1851.5 (18615)	23.21	22.46	21.53
1RB-Middle (7)		1908.5 (19185)	23.07	22.95	21.31	
		1880 (18900)	23.26	22.66	21.37	
		1851.5 (18615)	23.17	22.46	21.65	
1RB-Low (0)		1908.5 (19185)	23.33	23.13	21.41	
		1880 (18900)	23.16	22.71	21.60	
		1851.5 (18615)	23.10	22.51	21.61	
8RB-High (7)		1908.5 (19185)	22.77	21.74	20.37	
		1880 (18900)	22.78	21.71	20.39	
		1851.5 (18615)	22.78	21.82	20.44	
8RB-Middle (4)		1908.5 (19185)	22.68	21.79	20.63	
		1880 (18900)	22.68	21.78	20.48	
		1851.5 (18615)	22.79	21.84	20.52	
8RB-Low (0)		1908.5 (19185)	22.65	21.78	20.44	
		1880 (18900)	22.71	21.82	20.50	
		1851.5 (18615)	22.68	21.83	20.54	
15RB (0)		1908.5 (19185)	22.68	21.75	20.15	
		1880 (18900)	22.71	21.66	20.42	
		1851.5 (18615)	22.71	21.74	20.42	

5MHz	1RB-High (24)	1907.5 (19175)	23.25	22.50	21.60	
		1880 (18900)	23.30	22.90	21.53	
		1852.5 (18625)	23.57	23.12	21.59	
	1RB-Middle (12)	1907.5 (19175)	23.38	22.57	22.07	
		1880 (18900)	23.44	22.77	21.31	
		1852.5 (18625)	23.41	23.20	21.54	
	1RB-Low (0)	1907.5 (19175)	23.32	22.83	21.68	
		1880 (18900)	23.42	22.99	21.61	
		1852.5 (18625)	23.54	23.30	22.00	
	12RB-High (13)	1907.5 (19175)	22.82	21.80	20.52	
		1880 (18900)	22.66	21.77	20.35	
		1852.5 (18625)	22.71	21.86	20.49	
	12RB-Middle (6)	1907.5 (19175)	22.80	21.83	20.41	
		1880 (18900)	22.76	21.86	20.51	
		1852.5 (18625)	22.76	21.93	20.59	
	12RB-Low (0)	1907.5 (19175)	22.92	21.92	20.56	
		1880 (18900)	22.76	21.85	20.51	
		1852.5 (18625)	22.82	21.95	20.54	
	25RB (0)	1907.5 (19175)	22.80	21.73	20.26	
		1880 (18900)	22.73	21.78	20.40	
		1852.5 (18625)	22.76	21.81	20.58	
	10MHz	1RB-High (49)	1905 (19150)	23.49	22.89	21.85
			1880 (18900)	23.40	22.77	21.64
			1855 (18650)	23.47	23.21	21.85
1RB-Middle (24)		1905 (19150)	23.31	22.63	21.72	
		1880 (18900)	23.34	22.63	21.38	
		1855 (18650)	23.34	23.08	21.58	
1RB-Low (0)		1905 (19150)	23.56	22.92	21.77	
		1880 (18900)	23.37	22.74	21.62	
		1855 (18650)	23.45	23.16	21.80	
25RB-High (25)		1905 (19150)	22.88	21.94	20.56	
		1880 (18900)	22.82	21.81	20.38	
		1855 (18650)	22.84	21.84	20.57	
25RB-Middle (12)		1905 (19150)	22.80	21.80	20.41	
		1880 (18900)	22.74	21.79	20.43	
		1855 (18650)	22.79	21.84	20.54	
25RB-Low (0)		1905 (19150)	22.90	21.95	20.44	
		1880 (18900)	22.65	21.69	20.28	
		1855 (18650)	22.78	21.79	20.42	
50RB (0)		1905 (19150)	22.84	22.06	20.50	
		1880 (18900)	22.78	21.78	20.36	
		1855 (18650)	22.73	21.75	20.43	

15MHz	1RB-High (74)	1902.5 (19125)	23.63	23.29	21.65
		1880 (18900)	23.47	22.80	21.82
		1857.5 (18675)	23.63	23.38	21.96
	1RB-Middle (37)	1902.5 (19125)	23.40	22.98	21.56
		1880 (18900)	23.36	22.62	21.47
		1857.5 (18675)	23.39	23.24	21.75
	1RB-Low (0)	1902.5 (19125)	23.61	23.31	21.82
		1880 (18900)	23.49	22.85	21.95
		1857.5 (18675)	23.68	23.47	21.90
	36RB-High (38)	1902.5 (19125)	22.87	21.91	20.66
		1880 (18900)	22.88	21.86	20.54
		1857.5 (18675)	22.83	21.92	20.57
	36RB-Middle (19)	1902.5 (19125)	22.85	21.80	20.61
		1880 (18900)	22.85	21.84	20.52
		1857.5 (18675)	22.92	21.98	20.69
	36RB-Low (0)	1902.5 (19125)	22.90	21.87	20.68
		1880 (18900)	22.83	21.83	20.59
		1857.5 (18675)	22.92	22.00	20.73
75RB (0)	1902.5 (19125)	22.78	21.80	20.61	
	1880 (18900)	22.77	21.77	20.53	
	1857.5 (18675)	22.83	21.80	20.60	
20MHz	1RB-High (99)	1900 (19100)	23.39	22.56	21.97
		1880 (18900)	23.36	22.66	21.92
		1860 (18700)	23.74	22.74	22.04
	1RB-Middle (50)	1900 (19100)	23.42	22.94	22.28
		1880 (18900)	23.48	22.95	22.31
		1860 (18700)	24.13	23.06	22.46
	1RB-Low (0)	1900 (19100)	23.77	22.97	22.50
		1880 (18900)	23.88	22.92	22.41
		1860 (18700)	24.08	22.89	22.28
	50RB-High (50)	1900 (19100)	22.47	21.52	21.04
		1880 (18900)	22.50	21.52	21.06
		1860 (18700)	22.51	21.44	21.08
	50RB-Middle (25)	1900 (19100)	22.68	21.79	21.19
		1880 (18900)	22.54	21.60	21.08
		1860 (18700)	22.60	21.65	21.29
	50RB-Low (0)	1900 (19100)	22.63	21.67	21.20
		1880 (18900)	22.62	21.57	21.16
		1860 (18700)	22.59	21.62	21.21
100RB (0)	1900 (19100)	22.62	21.57	21.16	
	1880 (18900)	22.61	21.39	21.13	
	1860 (18700)	22.55	21.55	21.18	

Band4					
BANDWIDTH	Number of RBs	Frequency	QPSK	16QAM	64QAM
1.4MHz	1RB-High (5)	1754.3 (20393)	23.15	22.69	22.50
		1732.5 (20175)	23.15	22.68	22.19
		1710.7 (19957)	23.22	23.06	22.22
	1RB-Middle (3)	1754.3 (20393)	23.28	22.75	22.06
		1732.5 (20175)	23.20	22.72	22.17
		1710.7 (19957)	23.32	23.16	22.25
	1RB-Low (0)	1754.3 (20393)	23.23	22.74	22.42
		1732.5 (20175)	23.23	22.72	22.16
		1710.7 (19957)	23.31	23.08	22.18
	3RB-High (3)	1754.3 (20393)	23.21	22.85	22.37
		1732.5 (20175)	23.15	22.64	22.13
		1710.7 (19957)	23.20	22.86	22.19
	3RB-Middle (1)	1754.3 (20393)	23.20	22.90	22.47
		1732.5 (20175)	23.17	22.68	22.13
		1710.7 (19957)	23.26	22.92	22.23
	3RB-Low (0)	1754.3 (20393)	23.24	22.88	22.25
		1732.5 (20175)	23.13	22.64	22.20
		1710.7 (19957)	23.24	22.91	22.16
	6RB (0)	1754.3 (20393)	22.68	21.84	21.13
		1732.5 (20175)	22.65	21.83	21.01
		1710.7 (19957)	22.70	21.63	21.11
3MHz	1RB-High (14)	1753.5 (20385)	23.19	22.69	22.49
		1732.5 (20175)	23.09	22.42	22.13
		1711.5 (19965)	23.22	23.09	22.26
	1RB-Middle (7)	1753.5 (20385)	23.41	22.75	22.21
		1732.5 (20175)	23.18	22.47	22.32
		1711.5 (19965)	23.22	23.07	22.09
	1RB-Low (0)	1753.5 (20385)	23.28	22.75	22.05
		1732.5 (20175)	23.09	22.51	22.09
		1711.5 (19965)	23.35	23.17	22.32
	8RB-High (7)	1753.5 (20385)	22.70	21.75	21.15
		1732.5 (20175)	22.69	21.77	21.08
		1711.5 (19965)	22.67	21.77	21.12
	8RB-Middle (4)	1753.5 (20385)	22.73	21.80	21.22
		1732.5 (20175)	22.71	21.83	21.16
		1711.5 (19965)	22.68	21.76	21.18
	8RB-Low (0)	1753.5 (20385)	22.67	21.72	21.11
		1732.5 (20175)	22.74	21.85	21.13
		1711.5 (19965)	22.76	21.86	21.22
	15RB (0)	1753.5 (20385)	22.77	21.70	21.08
		1732.5 (20175)	22.74	21.76	21.08
		1711.5 (19965)	22.68	21.69	21.09

5MHz	1RB-High (24)	1752.5 (20375)	23.29	22.81	22.24
		1732.5 (20175)	23.22	22.81	22.12
		1712.5 (19975)	23.18	23.13	22.20
	1RB-Middle (12)	1752.5 (20375)	23.18	22.72	22.48
		1732.5 (20175)	23.25	22.78	22.10
		1712.5 (19975)	23.20	23.20	22.17
	1RB-Low (0)	1752.5 (20375)	23.38	22.91	22.38
		1732.5 (20175)	23.31	22.89	22.18
		1712.5 (19975)	23.47	23.35	22.43
	12RB-High (13)	1752.5 (20375)	22.77	21.81	21.16
		1732.5 (20175)	22.66	21.75	21.05
		1712.5 (19975)	22.73	21.89	21.12
	12RB-Middle (6)	1752.5 (20375)	22.73	21.73	21.03
		1732.5 (20175)	22.70	21.80	21.19
		1712.5 (19975)	22.71	21.90	21.12
	12RB-Low (0)	1752.5 (20375)	22.80	21.80	21.13
		1732.5 (20175)	22.78	21.87	21.25
		1712.5 (19975)	22.73	21.90	21.25
25RB (0)	1752.5 (20375)	22.73	21.65	21.05	
	1732.5 (20175)	22.74	21.74	21.07	
	1712.5 (19975)	22.74	21.78	21.13	
10MHz	1RB-High (49)	1750 (20350)	23.50	22.95	22.32
		1732.5 (20175)	23.49	22.78	22.47
		1715 (20000)	23.49	23.31	22.45
	1RB-Middle (24)	1750 (20350)	23.22	22.64	22.42
		1732.5 (20175)	23.18	22.58	22.14
		1715 (20000)	23.19	23.04	22.27
	1RB-Low (0)	1750 (20350)	23.37	22.78	22.47
		1732.5 (20175)	23.40	22.84	22.51
		1715 (20000)	23.53	23.34	22.50
	25RB-High (25)	1750 (20350)	22.74	21.83	21.09
		1732.5 (20175)	22.76	21.78	21.07
		1715 (20000)	22.81	21.80	21.20
	25RB-Middle (12)	1750 (20350)	22.78	21.87	21.13
		1732.5 (20175)	22.78	21.79	21.15
		1715 (20000)	22.69	21.75	21.07
	25RB-Low (0)	1750 (20350)	22.74	21.83	21.15
		1732.5 (20175)	22.70	21.75	21.10
		1715 (20000)	22.65	21.68	21.02
50RB (0)	1750 (20350)	22.83	21.81	21.21	
	1732.5 (20175)	22.80	21.79	21.18	
	1715 (20000)	22.71	21.72	21.15	

15MHz	1RB-High (74)	1747.5 (20325)	23.61	22.96	22.65
		1732.5 (20175)	23.57	23.37	22.46
		1717.5 (20025)	23.62	23.35	22.57
	1RB-Middle (37)	1747.5 (20325)	23.08	22.46	22.12
		1732.5 (20175)	23.10	23.02	22.00
		1717.5 (20025)	23.23	23.07	22.26
	1RB-Low (0)	1747.5 (20325)	23.33	22.68	22.44
		1732.5 (20175)	23.50	23.36	22.48
		1717.5 (20025)	23.55	23.36	22.56
	36RB-High (38)	1747.5 (20325)	22.71	21.69	21.21
		1732.5 (20175)	22.84	21.87	21.17
		1717.5 (20025)	22.71	21.69	21.15
	36RB-Middle (19)	1747.5 (20325)	22.64	21.62	21.04
		1732.5 (20175)	22.64	21.69	21.01
		1717.5 (20025)	22.75	21.68	21.28
	36RB-Low (0)	1747.5 (20325)	22.65	21.65	21.05
		1732.5 (20175)	22.76	21.80	21.21
		1717.5 (20025)	22.67	21.63	21.10
75RB (0)	1747.5 (20325)	22.66	21.67	21.07	
	1732.5 (20175)	22.78	21.79	21.20	
	1717.5 (20025)	22.80	21.79	21.23	
20MHz	1RB-High (99)	1745 (20300)	23.24	23.16	22.45
		1732.5 (20175)	23.21	23.04	22.47
		1720 (20050)	23.47	23.22	22.35
	1RB-Middle (50)	1745 (20300)	23.10	23.04	22.23
		1732.5 (20175)	23.16	22.93	22.19
		1720 (20050)	23.22	23.16	22.26
	1RB-Low (0)	1745 (20300)	23.09	22.98	22.24
		1732.5 (20175)	23.12	23.02	22.40
		1720 (20050)	23.13	23.09	22.50
	50RB-High (50)	1745 (20300)	22.67	21.72	21.22
		1732.5 (20175)	22.72	21.68	21.21
		1720 (20050)	22.68	21.69	21.10
	50RB-Middle (25)	1745 (20300)	22.64	21.68	21.15
		1732.5 (20175)	22.70	21.64	21.02
		1720 (20050)	22.71	21.65	21.12
	50RB-Low (0)	1745 (20300)	22.65	21.67	21.00
		1732.5 (20175)	22.67	21.59	21.05
		1720 (20050)	22.63	21.60	21.19
100RB (0)	1745 (20300)	22.68	21.66	21.17	
	1732.5 (20175)	22.69	21.68	21.13	
	1720 (20050)	22.67	21.67	21.06	

Band5					
BANDWIDTH	Number of RBs	Frequency	QPSK	16QAM	64QAM
1.4MHz	1RB-High (5)	848.3 (20643)	23.47	22.48	22.04
		836.5 (20525)	23.50	22.59	21.88
		824.7 (20407)	23.43	22.82	21.80
	1RB-Middle (3)	848.3 (20643)	23.62	22.50	21.98
		836.5 (20525)	23.55	22.62	22.04
		824.7 (20407)	23.50	22.84	21.92
	1RB-Low (0)	848.3 (20643)	23.51	22.46	22.04
		836.5 (20525)	23.42	22.49	21.87
		824.7 (20407)	23.42	22.81	21.92
	3RB-High (3)	848.3 (20643)	23.49	22.66	21.99
		836.5 (20525)	23.45	22.47	21.60
		824.7 (20407)	23.36	22.52	21.75
	3RB-Middle (1)	848.3 (20643)	23.54	22.68	21.91
		836.5 (20525)	23.50	22.52	21.84
		824.7 (20407)	23.44	22.58	21.86
	3RB-Low (0)	848.3 (20643)	23.52	22.64	22.03
		836.5 (20525)	23.34	22.40	21.79
		824.7 (20407)	23.42	22.58	21.85
	6RB (0)	848.3 (20643)	22.47	21.65	20.90
		836.5 (20525)	22.42	21.66	20.53
		824.7 (20407)	22.35	21.27	20.62
3MHz	1RB-High (14)	847.5 (20635)	23.45	22.49	21.98
		836.5 (20525)	23.43	22.33	21.86
		825.5 (20415)	23.44	22.96	21.90
	1RB-Middle (7)	847.5 (20635)	23.47	22.53	22.29
		836.5 (20525)	23.60	22.48	21.87
		825.5 (20415)	23.48	22.90	21.99
	1RB-Low (0)	847.5 (20635)	23.44	22.53	22.03
		836.5 (20525)	23.44	22.45	21.85
		825.5 (20415)	23.48	22.91	22.01
	8RB-High (7)	847.5 (20635)	22.55	21.59	20.87
		836.5 (20525)	22.47	21.60	20.78
		825.5 (20415)	22.44	21.48	20.62
	8RB-Middle (4)	847.5 (20635)	22.56	21.62	20.90
		836.5 (20525)	22.52	21.64	20.63
		825.5 (20415)	22.45	21.52	20.94
	8RB-Low (0)	847.5 (20635)	22.47	21.55	20.91
		836.5 (20525)	22.43	21.60	20.54
		825.5 (20415)	22.44	21.47	20.79
	15RB (0)	847.5 (20635)	22.56	21.52	20.83
		836.5 (20525)	22.52	21.57	20.53
		825.5 (20415)	22.46	21.46	20.83

5MHz	1RB-High (24)	846.5 (20625)	23.46	22.60	21.97	
		836.5 (20525)	23.59	22.67	21.92	
		826.5 (20425)	23.60	23.04	21.90	
	1RB-Middle (12)	846.5 (20625)	23.49	22.46	21.72	
		836.5 (20525)	23.62	22.68	21.86	
		826.5 (20425)	23.46	23.00	21.79	
	1RB-Low (0)	846.5 (20625)	23.50	22.55	21.94	
		836.5 (20525)	23.64	22.76	21.88	
		826.5 (20425)	23.50	22.99	21.88	
	12RB-High (13)	846.5 (20625)	22.63	21.59	20.93	
		836.5 (20525)	22.48	21.59	20.74	
		826.5 (20425)	22.53	21.69	20.75	
	12RB-Middle (6)	846.5 (20625)	22.60	21.56	20.86	
		836.5 (20525)	22.56	21.65	20.58	
		826.5 (20425)	22.44	21.59	20.85	
	12RB-Low (0)	846.5 (20625)	22.61	21.64	20.78	
		836.5 (20525)	22.51	21.62	20.66	
		826.5 (20425)	22.49	21.59	20.75	
	25RB (0)	846.5 (20625)	22.52	21.50	20.83	
		836.5 (20525)	22.54	21.60	20.76	
		826.5 (20425)	22.46	21.48	20.71	
	10MHz	1RB-High (49)	844 (20600)	23.70	22.75	22.40
			836.5 (20525)	23.57	22.57	22.14
			829 (20450)	23.61	23.09	22.08
1RB-Middle (24)		844 (20600)	23.27	22.31	21.82	
		836.5 (20525)	23.32	22.27	21.69	
		829 (20450)	23.32	22.73	21.85	
1RB-Low (0)		844 (20600)	23.47	22.50	22.10	
		836.5 (20525)	23.51	22.50	21.97	
		829 (20450)	23.44	22.94	22.09	
25RB-High (25)		844 (20600)	22.49	21.70	21.02	
		836.5 (20525)	22.42	21.44	20.67	
		829 (20450)	22.43	21.55	20.77	
25RB-Middle (12)		844 (20600)	22.25	21.47	20.83	
		836.5 (20525)	22.41	21.48	20.75	
		829 (20450)	22.31	21.38	20.72	
25RB-Low (0)		844 (20600)	22.35	21.46	20.72	
		836.5 (20525)	22.40	21.42	20.67	
		829 (20450)	22.44	21.43	20.77	
50RB (0)		844 (20600)	22.45	21.50	20.82	
		836.5 (20525)	22.41	21.43	20.76	
		829 (20450)	22.37	21.41	20.70	

Band7					
BANDWIDTH	Number of RBs	Frequency	QPSK	16QAM	64QAM
5MHz	1RB-High (24)	2567.5 (21425)	22.97	22.09	20.57
		2535 (21100)	22.82	21.90	20.21
		2502.5 (20775)	22.84	22.40	20.60
	1RB-Middle (12)	2567.5 (21425)	23.00	22.13	20.31
		2535 (21100)	22.73	21.88	19.95
		2502.5 (20775)	22.69	22.39	20.28
	1RB-Low (0)	2567.5 (21425)	23.07	22.13	20.69
		2535 (21100)	22.86	21.91	20.09
		2502.5 (20775)	23.01	22.52	20.76
	12RB-High (13)	2567.5 (21425)	21.90	20.98	19.39
		2535 (21100)	21.68	20.74	19.09
		2502.5 (20775)	21.84	20.95	19.35
	12RB-Middle (6)	2567.5 (21425)	21.93	20.99	19.49
		2535 (21100)	21.66	20.74	19.14
		2502.5 (20775)	21.84	20.96	19.37
	12RB-Low (0)	2567.5 (21425)	21.96	21.03	19.47
		2535 (21100)	21.72	20.81	18.98
		2502.5 (20775)	21.94	21.05	19.50
	25RB (0)	2567.5 (21425)	21.93	20.89	19.38
		2535 (21100)	21.68	20.67	18.99
		2502.5 (20775)	21.86	20.89	19.33
10MHz	1RB-High (49)	2565 (21400)	23.06	22.04	20.66
		2535 (21100)	22.80	21.75	20.35
		2505 (20800)	23.05	22.39	20.40
	1RB-Middle (24)	2565 (21400)	22.88	21.90	20.49
		2535 (21100)	22.63	21.61	19.90
		2505 (20800)	22.81	22.20	20.38
	1RB-Low (0)	2565 (21400)	23.12	22.13	20.73
		2535 (21100)	22.90	22.00	20.51
		2505 (20800)	23.08	22.56	20.85
	25RB-High (25)	2565 (21400)	21.91	21.01	19.34
		2535 (21100)	21.72	20.71	18.99
		2505 (20800)	21.77	20.82	19.21
	25RB-Middle (12)	2565 (21400)	21.90	20.98	19.42
		2535 (21100)	21.64	20.66	19.00
		2505 (20800)	21.76	20.83	19.27
	25RB-Low (0)	2565 (21400)	21.90	21.01	19.44
		2535 (21100)	21.72	20.70	19.11
		2505 (20800)	21.87	20.90	19.46
	50RB (0)	2565 (21400)	21.91	20.93	19.42
		2535 (21100)	21.70	20.61	19.10
		2505 (20800)	21.82	20.85	19.29

15MHz	1RB-High (74)	2562.5 (21375)	22.90	22.36	20.57
		2535 (21100)	22.75	22.19	20.58
		2507.5 (20825)	22.71	21.65	20.50
	1RB-Middle (37)	2562.5 (21375)	22.88	22.34	20.63
		2535 (21100)	22.78	22.19	20.13
		2507.5 (20825)	22.81	21.78	20.26
	1RB-Low (0)	2562.5 (21375)	22.80	22.23	20.41
		2535 (21100)	22.73	22.12	20.07
		2507.5 (20825)	22.75	21.75	20.41
	36RB-High (38)	2562.5 (21375)	21.89	20.97	19.40
		2535 (21100)	21.73	20.70	19.08
		2507.5 (20825)	21.71	20.70	19.17
	36RB-Middle (19)	2562.5 (21375)	21.84	20.95	19.42
		2535 (21100)	21.77	20.75	19.15
		2507.5 (20825)	21.86	20.87	19.31
	36RB-Low (0)	2562.5 (21375)	21.82	20.87	19.33
		2535 (21100)	21.74	20.65	19.18
		2507.5 (20825)	21.78	20.80	19.31
75RB (0)	2562.5 (21375)	21.81	20.87	19.32	
	2535 (21100)	21.72	20.70	19.13	
	2507.5 (20825)	21.68	20.69	19.14	
20MHz	1RB-High (99)	2560 (21350)	22.86	22.38	20.49
		2535 (21100)	22.79	22.22	20.40
		2510 (20850)	22.78	22.30	20.70
	1RB-Middle (50)	2560 (21350)	22.78	22.34	20.20
		2535 (21100)	22.76	22.25	20.20
		2510 (20850)	22.76	22.33	20.16
	1RB-Low (0)	2560 (21350)	22.76	22.21	20.33
		2535 (21100)	22.74	22.15	20.33
		2510 (20850)	22.87	22.28	20.60
	50RB-High (50)	2560 (21350)	21.84	20.92	19.38
		2535 (21100)	21.73	20.71	19.10
		2510 (20850)	21.70	20.74	19.14
	50RB-Middle (25)	2560 (21350)	21.86	20.87	19.42
		2535 (21100)	21.89	20.72	19.15
		2510 (20850)	21.80	20.81	19.27
	50RB-Low (0)	2560 (21350)	21.77	20.81	19.26
		2535 (21100)	21.77	20.77	19.20
		2510 (20850)	21.71	20.70	19.18
100RB (0)	2560 (21350)	21.84	20.81	19.27	
	2535 (21100)	21.76	20.70	19.06	
	2510 (20850)	21.75	20.81	19.28	

Band12					
BANDWIDTH	Number of RBs	Frequency	QPSK	16QAM	64QAM
1.4MHz	1RB-High (5)	715.3 (23173)	24.37	23.74	22.45
		707.5 (23095)	24.56	23.60	22.59
		699.7 (23017)	24.48	23.62	22.42
	1RB-Middle (3)	715.3 (23173)	24.40	23.67	22.60
		707.5 (23095)	24.50	23.52	22.63
		699.7 (23017)	24.47	23.60	22.49
	1RB-Low (0)	715.3 (23173)	24.34	23.70	22.38
		707.5 (23095)	24.46	23.46	22.49
		699.7 (23017)	24.52	23.67	22.57
	3RB-High (3)	715.3 (23173)	24.37	23.47	22.39
		707.5 (23095)	24.58	23.73	22.70
		699.7 (23017)	24.45	23.45	22.39
	3RB-Middle (1)	715.3 (23173)	24.40	23.60	22.66
		707.5 (23095)	24.55	23.75	22.54
		699.7 (23017)	24.48	23.48	22.56
	3RB-Low (0)	715.3 (23173)	24.36	23.51	22.41
		707.5 (23095)	24.55	23.71	22.51
		699.7 (23017)	24.53	23.54	22.54
	6RB (0)	715.3 (23173)	23.29	22.25	21.26
		707.5 (23095)	23.51	22.70	21.47
		699.7 (23017)	23.44	22.65	21.37
3MHz	1RB-High (14)	714.5 (23165)	24.39	23.74	22.48
		707.5 (23095)	24.52	23.50	22.46
		700.5 (23025)	24.53	23.42	22.64
	1RB-Middle (7)	714.5 (23165)	24.62	23.73	22.69
		707.5 (23095)	24.49	23.52	22.56
		700.5 (23025)	24.48	23.48	22.68
	1RB-Low (0)	714.5 (23165)	24.51	23.82	22.54
		707.5 (23095)	24.64	23.67	22.56
		700.5 (23025)	24.60	23.47	22.52
	8RB-High (7)	714.5 (23165)	23.42	22.46	21.42
		707.5 (23095)	23.61	22.68	21.58
		700.5 (23025)	23.53	22.65	21.47
	8RB-Middle (4)	714.5 (23165)	23.48	22.57	21.43
		707.5 (23095)	23.55	22.65	21.55
		700.5 (23025)	23.57	22.65	21.52
	8RB-Low (0)	714.5 (23165)	23.47	22.56	21.38
		707.5 (23095)	23.52	22.61	21.34
		700.5 (23025)	23.51	22.64	21.54
	15RB (0)	714.5 (23165)	23.47	22.48	21.36
		707.5 (23095)	23.61	22.54	21.50
		700.5 (23025)	23.57	22.57	21.47

5MHz	1RB-High (24)	713.5 (23155)	25.00	23.90	22.47
		707.5 (23095)	24.58	23.64	22.48
		701.5 (23035)	24.69	23.75	22.71
	1RB-Middle (12)	713.5 (23155)	24.77	23.91	22.38
		707.5 (23095)	24.59	23.62	22.39
		701.5 (23035)	24.63	23.86	22.68
	1RB-Low (0)	713.5 (23155)	24.87	23.88	22.67
		707.5 (23095)	24.61	23.69	22.60
		701.5 (23035)	24.60	23.89	22.60
	12RB-High (13)	713.5 (23155)	23.50	22.65	21.37
		707.5 (23095)	23.58	22.63	21.48
		701.5 (23035)	23.60	22.69	21.56
	12RB-Middle (6)	713.5 (23155)	23.53	22.66	21.50
		707.5 (23095)	23.64	22.64	21.60
		701.5 (23035)	23.63	22.76	21.58
	12RB-Low (0)	713.5 (23155)	23.55	22.71	21.55
		707.5 (23095)	23.65	22.72	21.57
		701.5 (23035)	23.57	22.74	21.61
25RB (0)	713.5 (23155)	23.56	22.58	21.44	
	707.5 (23095)	23.63	22.62	21.64	
	701.5 (23035)	23.75	22.73	21.57	
10MHz	1RB-High (49)	711 (23130)	24.38	23.15	22.98
		707.5 (23095)	24.45	23.81	23.12
		704 (23060)	24.59	23.40	23.05
	1RB-Middle (24)	711 (23130)	24.34	23.29	23.14
		707.5 (23095)	24.38	23.69	23.09
		704 (23060)	24.43	23.42	23.18
	1RB-Low (0)	711 (23130)	24.62	23.56	23.67
		707.5 (23095)	24.69	23.98	23.31
		704 (23060)	24.71	23.64	23.38
	25RB-High (25)	711 (23130)	23.29	22.32	21.85
		707.5 (23095)	23.34	22.32	21.91
		704 (23060)	23.36	22.45	22.09
	25RB-Middle (12)	711 (23130)	23.36	22.38	21.96
		707.5 (23095)	23.35	22.43	22.03
		704 (23060)	23.41	22.53	21.97
	25RB-Low (0)	711 (23130)	23.41	22.45	22.03
		707.5 (23095)	23.40	22.46	22.17
		704 (23060)	23.58	22.72	22.36
50RB (0)	711 (23130)	23.38	22.36	21.98	
	707.5 (23095)	23.39	22.47	22.14	
	704 (23060)	23.39	22.43	22.33	

Band18						
BANDWIDTH	Number of RBs	Frequency	QPSK	16QAM	64QAM	
5MHz	1RB-High (24)	827.5 (23975)	22.98	22.15	21.11	
		822.5 (23925)	22.92	22.21	20.88	
		817.5 (23875)	23.05	22.59	21.10	
	1RB-Middle (12)	827.5 (23975)	22.95	22.23	21.16	
		822.5 (23925)	22.97	22.20	20.97	
		817.5 (23875)	23.03	22.56	21.27	
	1RB-Low (0)	827.5 (23975)	23.11	22.20	21.14	
		822.5 (23925)	23.01	22.20	21.07	
		817.5 (23875)	23.03	22.57	21.12	
	12RB-High (13)	827.5 (23975)	22.04	21.09	20.01	
		822.5 (23925)	22.08	21.17	20.07	
		817.5 (23875)	21.98	21.07	19.72	
	12RB-Middle (6)	827.5 (23975)	22.13	21.15	20.09	
		822.5 (23925)	22.03	21.08	19.88	
		817.5 (23875)	22.11	21.27	19.81	
	12RB-Low (0)	827.5 (23975)	21.93	21.17	20.08	
		822.5 (23925)	22.15	21.30	19.91	
		817.5 (23875)	22.08	21.26	19.96	
	25RB (0)	827.5 (23975)	22.02	21.01	19.68	
		822.5 (23925)	21.98	21.10	20.10	
		817.5 (23875)	22.12	21.17	19.96	
	10MHz	1RB-High (49)	825 (23950)	23.30	22.34	21.29
			822.5 (23925)	23.56	22.30	21.47
			820 (23900)	23.50	22.71	21.39
1RB-Middle (24)		825 (23950)	22.93	21.99	21.16	
		822.5 (23925)	23.09	21.95	21.06	
		820 (23900)	23.16	22.55	21.14	
1RB-Low (0)		825 (23950)	23.15	22.12	21.12	
		822.5 (23925)	23.07	22.14	21.30	
		820 (23900)	23.29	22.51	21.34	
25RB-High (25)		825 (23950)	22.26	21.26	20.01	
		822.5 (23925)	22.09	21.15	19.96	
		820 (23900)	22.11	21.12	19.94	
25RB-Middle (12)		825 (23950)	22.04	21.14	20.05	
		822.5 (23925)	22.04	21.04	19.84	
		820 (23900)	22.16	21.19	19.84	
25RB-Low (0)		825 (23950)	21.98	21.08	19.84	
		822.5 (23925)	22.05	21.01	19.69	
		820 (23900)	22.13	21.12	19.99	
50RB (0)		825 (23950)	22.03	21.10	19.69	
		822.5 (23925)	22.12	21.12	19.72	
		820 (23900)	22.02	21.12	19.96	



15MHz	1RB-High (74)	822.5 (23925)	23.11	22.14	21.19
	1RB-Middle (37)	822.5 (23925)	23.11	22.04	21.26
	1RB-Low (0)	822.5 (23925)	23.18	22.16	21.40
	36RB-High (38)	822.5 (23925)	22.27	21.27	20.18
	36RB-Middle (19)	822.5 (23925)	22.20	21.19	20.08
	36RB-Low (0)	822.5 (23925)	22.30	21.30	20.25
	75RB (0)	822.5 (23925)	22.18	21.17	20.15

Band19					
BANDWIDTH	Number of RBs	Frequency	QPSK	16QAM	64QAM
5MHz	1RB-High (24)	842.5 (24125)	23.14	22.28	21.14
		837.5 (24075)	23.18	22.29	21.23
		832.5 (24025)	23.26	22.69	21.31
	1RB-Middle (12)	842.5 (24125)	23.07	22.16	21.10
		837.5 (24075)	23.20	22.23	21.13
		832.5 (24025)	23.10	22.65	21.19
	1RB-Low (0)	842.5 (24125)	23.14	22.29	21.17
		837.5 (24075)	23.12	22.26	21.16
		832.5 (24025)	23.24	22.73	21.16
	12RB-High (13)	842.5 (24125)	22.19	21.21	20.06
		837.5 (24075)	22.07	21.16	19.98
		832.5 (24025)	22.14	21.30	20.07
	12RB-Middle (6)	842.5 (24125)	22.18	21.20	20.07
		837.5 (24075)	22.14	21.19	20.09
		832.5 (24025)	22.14	21.30	20.02
	12RB-Low (0)	842.5 (24125)	22.20	21.23	20.15
		837.5 (24075)	22.09	21.18	19.95
		832.5 (24025)	22.18	21.30	20.09
	25RB (0)	842.5 (24125)	22.17	21.15	20.04
		837.5 (24075)	22.14	21.16	19.99
		832.5 (24025)	22.13	21.21	20.00
10MHz	1RB-High (49)	840 (24100)	23.50	22.84	21.99
		837.5 (24075)	23.49	22.38	21.46
		835 (24050)	23.51	22.38	21.65
	1RB-Middle (24)	840 (24100)	23.13	22.48	21.09
		837.5 (24075)	23.12	22.10	21.00
		835 (24050)	23.10	22.08	21.09
	1RB-Low (0)	840 (24100)	23.15	22.60	21.32
		837.5 (24075)	23.19	22.22	21.38
		835 (24050)	23.17	22.25	21.38
	25RB-High (25)	840 (24100)	22.24	21.22	20.15
		837.5 (24075)	22.15	21.18	19.95
		835 (24050)	22.22	21.20	20.02
	25RB-Middle (12)	840 (24100)	22.14	21.14	20.04
		837.5 (24075)	22.14	21.26	20.02
		835 (24050)	22.21	21.21	20.01
	25RB-Low (0)	840 (24100)	22.09	21.13	20.01
		837.5 (24075)	22.03	21.16	19.93
		835 (24050)	22.08	21.13	19.98
	50RB (0)	840 (24100)	22.17	21.19	20.01
		837.5 (24075)	22.15	21.14	19.97
		835 (24050)	22.11	21.10	19.95



15MHz	1RB-High (74)	837.5 (24075)	23.28	22.67	21.44
	1RB-Middle (37)	837.5 (24075)	23.23	22.60	21.18
	1RB-Low (0)	837.5 (24075)	23.38	22.79	21.49
	36RB-High (38)	837.5 (24075)	22.35	21.34	20.30
	36RB-Middle (19)	837.5 (24075)	22.26	21.21	20.22
	36RB-Low (0)	837.5 (24075)	22.29	21.26	20.32
	75RB (0)	837.5 (24075)	22.29	21.29	20.22

Band28					
BANDWIDTH	Number of RBs	Frequency	QPSK	16QAM	64QAM
3MHz	1RB-High (14)	746.5 (27645)	23.93	22.78	21.99
		719.5 (27375)	24.45	23.76	22.45
		704.5 (27225)	24.68	23.50	22.65
	1RB-Middle (7)	746.5 (27645)	24.06	22.96	22.09
		719.5 (27375)	24.58	23.86	22.91
		704.5 (27225)	24.58	23.53	22.65
	1RB-Low (0)	746.5 (27645)	23.96	22.89	22.05
		719.5 (27375)	24.48	23.89	22.60
		704.5 (27225)	24.49	23.45	22.55
	8RB-High (7)	746.5 (27645)	22.99	22.19	20.98
		719.5 (27375)	23.46	22.41	21.27
		704.5 (27225)	23.51	22.64	21.56
	8RB-Middle (4)	746.5 (27645)	23.02	22.26	21.06
		719.5 (27375)	23.29	22.60	21.63
		704.5 (27225)	23.48	22.57	21.62
	8RB-Low (0)	746.5 (27645)	22.96	22.22	20.92
		719.5 (27375)	23.46	22.53	21.43
		704.5 (27225)	23.55	22.67	21.52
	15RB (0)	746.5 (27645)	23.01	22.16	20.94
		719.5 (27375)	23.37	22.64	21.09
		704.5 (27225)	23.52	22.49	21.56
5MHz	1RB-High (24)	745.5 (27635)	23.96	23.07	22.36
		720.5 (27385)	24.42	23.55	22.41
		705.5 (27235)	24.88	23.97	22.43
	1RB-Middle (12)	745.5 (27635)	24.14	23.12	22.09
		720.5 (27385)	24.39	23.54	22.53
		705.5 (27235)	24.98	23.90	22.72
	1RB-Low (0)	745.5 (27635)	24.06	23.25	21.83
		720.5 (27385)	24.62	23.65	22.62
		705.5 (27235)	24.89	23.85	22.96
	12RB-High (13)	745.5 (27635)	23.13	22.19	21.01
		720.5 (27385)	23.37	22.45	21.35
		705.5 (27235)	23.57	22.74	21.58
	12RB-Middle (6)	745.5 (27635)	23.20	22.22	21.04
		720.5 (27385)	23.27	22.50	21.41
		705.5 (27235)	23.65	22.80	21.64
	12RB-Low (0)	745.5 (27635)	23.12	22.17	21.02
		720.5 (27385)	23.47	22.46	21.64
		705.5 (27235)	23.60	22.81	21.51
	25RB (0)	745.5 (27635)	23.18	22.13	21.14
		720.5 (27385)	23.49	22.45	21.11
		705.5 (27235)	23.57	22.69	21.71

10MHz	1RB-High (49)	743 (27610)	24.14	23.00	22.27
		723 (27410)	24.41	23.75	22.47
		708 (27260)	24.12	23.08	21.99
	1RB-Middle (24)	743 (27610)	23.91	23.10	22.10
		723 (27410)	24.39	23.75	22.40
		708 (27260)	24.58	23.45	22.56
	1RB-Low (0)	743 (27610)	24.10	23.17	22.21
		723 (27410)	24.53	23.95	22.63
		708 (27260)	24.27	23.18	22.20
	25RB-High (25)	743 (27610)	23.06	22.18	21.00
		723 (27410)	23.34	22.41	21.30
		708 (27260)	23.38	22.44	21.30
	25RB-Middle (12)	743 (27610)	23.06	22.22	21.11
		723 (27410)	23.43	22.44	21.39
		708 (27260)	23.58	22.67	21.56
	25RB-Low (0)	743 (27610)	23.07	22.18	20.91
		723 (27410)	23.37	22.37	21.20
		708 (27260)	23.50	22.60	21.44
50RB (0)	743 (27610)	23.05	22.17	21.06	
	723 (27410)	23.75	22.20	21.00	
	708 (27260)	23.45	22.49	21.36	
15MHz	1RB-High (74)	740.5 (27585)	23.90	23.11	21.88
		725.5 (27435)	24.01	22.99	21.95
		710.5 (27285)	24.34	23.75	22.35
	1RB-Middle (37)	740.5 (27585)	24.19	23.38	22.11
		725.5 (27435)	24.48	23.40	22.57
		710.5 (27285)	24.46	23.88	22.57
	1RB-Low (0)	740.5 (27585)	23.86	23.20	22.11
		725.5 (27435)	24.20	23.27	22.82
		710.5 (27285)	24.55	23.96	22.90
	36RB-High (38)	740.5 (27585)	23.01	21.99	21.02
		725.5 (27435)	23.26	22.27	21.25
		710.5 (27285)	23.46	22.50	21.35
	36RB-Middle (19)	740.5 (27585)	23.10	22.09	21.07
		725.5 (27435)	23.52	22.53	21.47
		710.5 (27285)	23.51	22.55	21.49
	36RB-Low (0)	740.5 (27585)	23.00	22.00	21.03
		725.5 (27435)	23.53	22.42	21.51
		710.5 (27285)	23.52	22.57	21.61
75RB (0)	740.5 (27585)	23.00	21.99	20.94	
	725.5 (27435)	23.33	22.32	21.22	
	710.5 (27285)	23.52	22.52	21.49	

20MHz	1RB-High (99)	738 (27560)	24.08	23.31	22.25
		728 (27460)	23.91	23.39	22.47
		713 (27310)	24.22	23.56	22.87
	1RB-Middle (50)	738 (27560)	24.36	23.48	22.52
		728 (27460)	24.22	23.76	22.86
		713 (27310)	24.37	23.70	23.03
	1RB-Low (0)	738 (27560)	23.99	23.36	22.45
		728 (27460)	24.28	23.71	23.23
		713 (27310)	24.45	23.78	23.70
	50RB-High (50)	738 (27560)	22.90	21.91	21.16
		728 (27460)	23.09	22.12	21.43
		713 (27310)	23.45	22.40	21.75
	50RB-Middle (25)	738 (27560)	22.99	22.04	21.38
		728 (27460)	23.34	22.33	21.69
		713 (27310)	23.44	22.42	21.77
	50RB-Low (0)	738 (27560)	22.86	21.88	21.33
		728 (27460)	23.35	22.42	21.81
		713 (27310)	23.60	22.56	22.04
	100RB (0)	738 (27560)	22.85	21.93	21.25
		728 (27460)	23.25	22.31	21.65
		713 (27310)	23.52	22.55	21.92

Band38					
BANDWIDTH	Number of RBs	Frequency	QPSK	16QAM	64QAM
5MHz	1RB-High (24)	2617.5 (38225)	23.99	23.16	21.21
		2595 (38000)	23.71	23.01	21.35
		2572.5 (37775)	23.79	23.19	21.28
	1RB-Middle (12)	2617.5 (38225)	23.87	23.02	21.27
		2595 (38000)	23.80	23.05	21.21
		2572.5 (37775)	23.74	23.06	21.41
	1RB-Low (0)	2617.5 (38225)	23.97	23.19	21.44
		2595 (38000)	23.90	23.14	21.51
		2572.5 (37775)	23.80	23.19	21.24
	12RB-High (13)	2617.5 (38225)	22.85	21.98	20.29
		2595 (38000)	22.87	21.82	20.47
		2572.5 (37775)	22.78	21.89	20.39
	12RB-Middle (6)	2617.5 (38225)	22.91	21.95	20.45
		2595 (38000)	22.83	21.79	20.48
		2572.5 (37775)	22.78	21.88	20.38
	12RB-Low (0)	2617.5 (38225)	22.91	21.98	20.42
		2595 (38000)	22.83	21.82	20.53
		2572.5 (37775)	22.77	21.89	20.41
	25RB (0)	2617.5 (38225)	22.94	21.93	20.49
		2595 (38000)	22.81	21.84	20.50
		2572.5 (37775)	22.76	21.78	20.41
10MHz	1RB-High (49)	2615 (38200)	24.05	23.66	21.37
		2595 (38000)	24.15	23.56	21.59
		2575 (37800)	23.89	23.22	21.48
	1RB-Middle (24)	2615 (38200)	23.71	23.34	21.22
		2595 (38000)	23.78	23.21	21.25
		2575 (37800)	23.77	23.03	21.38
	1RB-Low (0)	2615 (38200)	23.88	23.48	21.41
		2595 (38000)	23.95	23.54	21.59
		2575 (37800)	24.04	23.05	21.43
	25RB-High (25)	2615 (38200)	22.97	22.05	20.37
		2595 (38000)	22.86	21.89	20.45
		2575 (37800)	22.81	21.83	20.58
	25RB-Middle (12)	2615 (38200)	22.85	21.82	20.37
		2595 (38000)	22.75	21.79	20.45
		2575 (37800)	22.77	21.78	20.39
	25RB-Low (0)	2615 (38200)	22.77	21.85	20.32
		2595 (38000)	22.81	21.85	20.41
		2575 (37800)	22.75	21.73	20.34
	50RB (0)	2615 (38200)	22.90	21.95	20.28
		2595 (38000)	22.73	21.82	20.46
		2575 (37800)	22.82	21.82	20.39

15MHz	1RB-High (74)	2612.5 (38175)	23.93	23.46	21.46	
		2595 (38000)	24.09	23.45	21.49	
		2577.5 (37825)	23.97	23.36	21.42	
	1RB-Middle (37)	2612.5 (38175)	23.97	23.33	21.37	
		2595 (38000)	23.92	23.36	21.34	
		2577.5 (37825)	23.87	23.23	21.27	
	1RB-Low (0)	2612.5 (38175)	23.98	23.29	21.37	
		2595 (38000)	23.84	23.29	21.32	
		2577.5 (37825)	23.82	23.15	21.24	
	36RB-High (38)	2612.5 (38175)	23.21	22.19	20.51	
		2595 (38000)	23.04	22.05	20.53	
		2577.5 (37825)	23.07	22.08	20.50	
	36RB-Middle (19)	2612.5 (38175)	23.10	22.12	20.49	
		2595 (38000)	22.98	22.00	20.46	
		2577.5 (37825)	22.96	22.00	20.44	
	36RB-Low (0)	2612.5 (38175)	23.13	22.13	20.50	
		2595 (38000)	22.94	21.99	20.52	
		2577.5 (37825)	22.89	21.92	20.36	
	75RB (0)	2612.5 (38175)	23.07	22.06	20.45	
		2595 (38000)	22.88	21.99	20.39	
		2577.5 (37825)	22.95	21.96	20.44	
	20MHz	1RB-High (99)	2610 (38150)	24.32	23.57	22.73
			2595 (38000)	24.21	23.63	22.70
			2580 (37850)	24.17	23.51	22.86
		1RB-Middle (50)	2610 (38150)	24.23	23.43	22.75
			2595 (38000)	24.10	23.50	22.64
			2580 (37850)	24.06	23.32	22.71
1RB-Low (0)		2610 (38150)	24.23	23.32	22.91	
		2595 (38000)	24.03	23.39	22.65	
		2580 (37850)	23.95	23.20	22.54	
50RB-High (50)		2610 (38150)	23.23	22.45	21.79	
		2595 (38000)	23.14	22.19	21.78	
		2580 (37850)	23.20	22.03	21.76	
50RB-Middle (25)		2610 (38150)	23.30	22.30	21.78	
		2595 (38000)	23.06	22.05	21.74	
		2580 (37850)	23.26	22.02	21.77	
50RB-Low (0)		2610 (38150)	23.22	22.24	21.87	
		2595 (38000)	23.06	22.06	21.73	
		2580 (37850)	23.04	21.89	21.68	
100RB (0)		2610 (38150)	23.29	22.32	21.82	
		2595 (38000)	23.11	22.04	21.65	
		2580 (37850)	23.07	21.95	21.64	

Band66					
BANDWIDTH	Number of RBs	Frequency	QPSK	16QAM	64QAM
1.4MHz	1RB-High (5)	1779.3 (132665)	23.28	22.33	20.81
		1745 (132322)	23.34	22.46	20.90
		1710.7 (131979)	23.23	22.62	21.03
	1RB-Middle (3)	1779.3 (132665)	23.41	22.38	21.01
		1745 (132322)	23.41	22.50	21.15
		1710.7 (131979)	23.28	22.70	21.15
	1RB-Low (0)	1779.3 (132665)	23.28	22.32	20.96
		1745 (132322)	23.32	22.40	20.86
		1710.7 (131979)	23.23	22.63	20.98
	3RB-High (3)	1779.3 (132665)	23.33	22.41	21.16
		1745 (132322)	23.35	22.37	20.88
		1710.7 (131979)	23.22	22.36	20.97
	3RB-Middle (1)	1779.3 (132665)	23.35	22.51	20.81
		1745 (132322)	23.36	22.43	21.19
		1710.7 (131979)	23.26	22.41	21.09
	3RB-Low (0)	1779.3 (132665)	23.39	22.45	21.14
		1745 (132322)	23.36	22.41	21.14
		1710.7 (131979)	23.20	22.39	20.95
	6RB (0)	1779.3 (132665)	22.24	21.48	19.93
		1745 (132322)	22.33	21.52	19.92
		1710.7 (131979)	22.17	21.13	19.83
3MHz	1RB-High (14)	1778.5 (132657)	23.27	22.76	20.90
		1745 (132322)	23.25	22.36	21.08
		1711.5 (131987)	23.21	22.11	21.04
	1RB-Middle (7)	1778.5 (132657)	23.43	22.88	21.14
		1745 (132322)	23.50	22.42	21.11
		1711.5 (131987)	23.24	22.23	21.12
	1RB-Low (0)	1778.5 (132657)	23.44	22.91	21.06
		1745 (132322)	23.39	22.41	21.14
		1711.5 (131987)	23.19	22.18	21.17
	8RB-High (7)	1778.5 (132657)	22.30	21.40	20.07
		1745 (132322)	22.34	21.39	20.11
		1711.5 (131987)	22.21	21.26	19.87
	8RB-Middle (4)	1778.5 (132657)	22.32	21.44	19.90
		1745 (132322)	22.41	21.46	19.97
		1711.5 (131987)	22.30	21.43	20.01
	8RB-Low (0)	1778.5 (132657)	22.31	21.43	20.21
		1745 (132322)	22.33	21.39	20.08
		1711.5 (131987)	22.23	21.42	19.97
	15RB (0)	1778.5 (132657)	22.33	21.37	20.02
		1745 (132322)	22.40	21.37	19.91
		1711.5 (131987)	22.30	21.32	19.95

5MHz	1RB-High (24)	1777.5 (132647)	23.44	22.46	20.99
		1745 (132322)	23.47	22.85	21.12
		1712.5 (131997)	23.26	22.35	21.05
	1RB-Middle (12)	1777.5 (132647)	23.41	22.40	21.09
		1745 (132322)	23.38	22.83	21.00
		1712.5 (131997)	23.19	22.26	21.06
	1RB-Low (0)	1777.5 (132647)	23.49	22.59	21.10
		1745 (132322)	23.65	22.89	21.03
		1712.5 (131997)	23.34	22.41	21.12
	12RB-High (13)	1777.5 (132647)	22.25	21.45	20.21
		1745 (132322)	22.38	21.52	20.08
		1712.5 (131997)	22.27	21.35	19.95
	12RB-Middle (6)	1777.5 (132647)	22.34	21.48	20.10
		1745 (132322)	22.34	21.50	20.04
		1712.5 (131997)	22.25	21.28	19.93
	12RB-Low (0)	1777.5 (132647)	22.35	21.40	20.25
		1745 (132322)	22.41	21.58	20.15
		1712.5 (131997)	22.30	21.41	20.03
	25RB (0)	1777.5 (132647)	22.38	21.34	20.23
		1745 (132322)	22.36	21.43	19.92
		1712.5 (131997)	22.28	21.22	19.95
10MHz	1RB-High (49)	1775 (132622)	23.80	22.66	21.45
		1745 (132322)	23.86	23.19	21.58
		1715 (132022)	23.87	22.79	21.69
	1RB-Middle (24)	1775 (132622)	23.31	22.30	21.22
		1745 (132322)	23.34	22.63	21.26
		1715 (132022)	23.23	22.24	20.93
	1RB-Low (0)	1775 (132622)	23.24	22.35	21.05
		1745 (132322)	23.18	22.36	21.23
		1715 (132022)	23.31	22.63	21.04
	25RB-High (25)	1775 (132622)	22.45	21.51	20.23
		1745 (132322)	22.47	21.47	20.03
		1715 (132022)	22.36	21.43	20.01
	25RB-Middle (12)	1775 (132622)	22.41	21.46	19.99
		1745 (132322)	22.36	21.42	20.02
		1715 (132022)	22.30	21.41	19.97
	25RB-Low (0)	1775 (132622)	22.28	21.32	20.18
		1745 (132322)	22.27	21.27	19.88
		1715 (132022)	22.15	21.25	19.84
	50RB (0)	1775 (132622)	22.33	21.39	20.07
		1745 (132322)	22.34	21.38	20.02
		1715 (132022)	22.28	21.32	19.96

15MHz	1RB-High (74)	1772.5 (132597)	23.44	22.35	21.38
		1745 (132322)	23.51	22.80	21.19
		1717.5 (132047)	23.52	22.89	21.20
	1RB-Middle (37)	1772.5 (132597)	23.29	22.24	21.20
		1745 (132322)	23.11	22.52	20.82
		1717.5 (132047)	23.32	22.67	20.97
	1RB-Low (0)	1772.5 (132597)	23.65	22.55	21.60
		1745 (132322)	23.44	22.82	21.29
		1717.5 (132047)	23.57	22.98	21.47
	36RB-High (38)	1772.5 (132597)	22.29	21.27	20.11
		1745 (132322)	22.21	21.26	19.83
		1717.5 (132047)	22.22	21.21	19.91
	36RB-Middle (19)	1772.5 (132597)	22.34	21.37	20.11
		1745 (132322)	22.16	21.23	19.82
		1717.5 (132047)	22.31	21.23	19.98
	36RB-Low (0)	1772.5 (132597)	22.40	21.46	20.08
		1745 (132322)	22.28	21.32	19.99
		1717.5 (132047)	22.38	21.31	20.22
	75RB (0)	1772.5 (132597)	22.36	21.39	20.18
		1745 (132322)	22.13	21.21	19.79
		1717.5 (132047)	22.32	21.32	19.92
20MHz	1RB-High (99)	1770 (132572)	23.93	23.11	22.26
		1745 (132322)	23.61	23.09	22.18
		1720 (132072)	23.70	23.10	22.32
	1RB-Middle (50)	1770 (132572)	23.37	22.87	22.00
		1745 (132322)	23.08	22.55	21.87
		1720 (132072)	23.28	22.68	21.94
	1RB-Low (0)	1770 (132572)	23.22	22.70	21.70
		1745 (132322)	22.96	22.42	21.55
		1720 (132072)	23.17	22.58	21.78
	50RB-High (50)	1770 (132572)	22.37	21.39	20.90
		1745 (132322)	22.25	21.30	20.70
		1720 (132072)	22.38	21.38	20.83
	50RB-Middle (25)	1770 (132572)	22.34	21.32	21.00
		1745 (132322)	22.20	21.24	20.59
		1720 (132072)	22.34	21.30	20.75
	50RB-Low (0)	1770 (132572)	22.28	21.22	20.83
		1745 (132322)	22.13	21.13	20.57
		1720 (132072)	22.29	21.23	20.65
	100RB (0)	1770 (132572)	22.33	21.38	20.62
		1745 (132322)	22.22	21.21	20.49
		1720 (132072)	22.36	21.37	20.78

Low power

Band2-Low power					
BANDWIDTH	Number of RBs	Frequency	QPSK	16QAM	64QAM
1.4MHz	1RB-High (5)	1909.3 (19193)	12.22	11.95	12.21
		1880 (18900)	12.16	11.63	12.14
		1850.7 (18607)	12.22	11.78	12.15
	1RB-Middle (3)	1909.3 (19193)	12.22	12.15	12.17
		1880 (18900)	12.30	11.72	12.26
		1850.7 (18607)	12.35	11.80	12.34
	1RB-Low (0)	1909.3 (19193)	12.36	11.99	12.34
		1880 (18900)	12.24	11.68	12.15
		1850.7 (18607)	12.22	11.79	12.19
	3RB-High (3)	1909.3 (19193)	12.25	11.86	12.23
		1880 (18900)	12.26	11.80	12.21
		1850.7 (18607)	12.33	11.70	12.32
	3RB-Middle (1)	1909.3 (19193)	12.28	11.95	12.20
		1880 (18900)	12.23	11.92	12.14
		1850.7 (18607)	12.26	11.75	12.22
	3RB-Low (0)	1909.3 (19193)	12.29	11.87	12.27
		1880 (18900)	12.20	11.87	12.19
		1850.7 (18607)	12.24	11.74	12.21
	6RB (0)	1909.3 (19193)	12.15	11.59	12.11
		1880 (18900)	12.15	11.84	12.07
		1850.7 (18607)	12.19	11.85	12.18
3MHz	1RB-High (14)	1908.5 (19185)	12.36	12.11	12.29
		1880 (18900)	12.35	11.81	12.33
		1851.5 (18615)	12.29	11.63	12.20
	1RB-Middle (7)	1908.5 (19185)	12.26	12.07	12.24
		1880 (18900)	12.23	11.77	12.14
		1851.5 (18615)	12.27	11.64	12.25
	1RB-Low (0)	1908.5 (19185)	12.45	12.18	12.40
		1880 (18900)	12.29	11.83	12.20
		1851.5 (18615)	12.35	11.72	12.33
	8RB-High (7)	1908.5 (19185)	12.34	11.90	12.28
		1880 (18900)	12.36	11.79	12.36
		1851.5 (18615)	12.34	11.95	12.31
	8RB-Middle (4)	1908.5 (19185)	12.32	11.92	12.25
		1880 (18900)	12.32	11.89	12.32
		1851.5 (18615)	12.30	11.97	12.21
	8RB-Low (0)	1908.5 (19185)	12.32	11.90	12.29
		1880 (18900)	12.37	11.83	12.30
		1851.5 (18615)	12.34	11.95	12.27
	15RB (0)	1908.5 (19185)	12.33	11.87	12.25
		1880 (18900)	12.36	11.83	12.33
		1851.5 (18615)	12.40	11.90	12.33

5MHz	1RB-High (24)	1907.5 (19175)	12.39	12.01	12.30
		1880 (18900)	12.29	12.32	12.24
		1852.5 (18625)	12.38	11.97	12.35
	1RB-Middle (12)	1907.5 (19175)	12.45	11.90	12.39
		1880 (18900)	12.41	12.23	12.35
		1852.5 (18625)	12.20	11.92	12.20
	1RB-Low (0)	1907.5 (19175)	12.49	12.06	12.40
		1880 (18900)	12.45	12.43	12.45
		1852.5 (18625)	12.46	12.04	12.37
	12RB-High (13)	1907.5 (19175)	12.44	11.93	12.35
		1880 (18900)	12.29	11.95	12.26
		1852.5 (18625)	12.44	11.88	12.36
	12RB-Middle (6)	1907.5 (19175)	12.36	11.95	12.26
		1880 (18900)	12.37	12.02	12.37
		1852.5 (18625)	12.49	11.94	12.40
	12RB-Low (0)	1907.5 (19175)	12.39	11.99	12.34
		1880 (18900)	12.33	12.01	12.28
		1852.5 (18625)	12.45	12.01	12.43
25RB (0)	1907.5 (19175)	12.35	11.91	12.25	
	1880 (18900)	12.38	11.93	12.38	
	1852.5 (18625)	12.41	11.86	12.37	
10MHz	1RB-High (49)	1905 (19150)	12.58	12.33	12.50
		1880 (18900)	12.41	11.96	12.33
		1855 (18650)	12.56	11.94	12.55
	1RB-Middle (24)	1905 (19150)	12.44	12.20	12.39
		1880 (18900)	12.30	11.81	12.27
		1855 (18650)	12.51	11.80	12.49
	1RB-Low (0)	1905 (19150)	12.53	12.21	12.49
		1880 (18900)	12.55	11.87	12.53
		1855 (18650)	12.52	11.95	12.51
	25RB-High (25)	1905 (19150)	12.37	11.89	12.37
		1880 (18900)	12.34	11.90	12.33
		1855 (18650)	12.54	11.93	12.53
	25RB-Middle (12)	1905 (19150)	12.35	11.89	12.30
		1880 (18900)	12.30	11.87	12.26
		1855 (18650)	12.50	12.01	12.42
	25RB-Low (0)	1905 (19150)	12.31	11.85	12.27
		1880 (18900)	12.23	11.80	12.21
		1855 (18650)	12.44	11.81	12.40
50RB (0)	1905 (19150)	12.43	11.97	12.38	
	1880 (18900)	12.32	11.84	12.30	
	1855 (18650)	12.48	11.80	12.41	

15MHz	1RB-High (74)	1902.5 (19125)	12.53	12.27	12.44
		1880 (18900)	12.41	12.24	12.38
		1857.5 (18675)	12.41	11.83	12.37
	1RB-Middle (37)	1902.5 (19125)	12.32	12.06	12.27
		1880 (18900)	12.32	12.13	12.26
		1857.5 (18675)	12.25	11.70	12.20
	1RB-Low (0)	1902.5 (19125)	12.66	12.29	12.59
		1880 (18900)	12.57	12.38	12.56
		1857.5 (18675)	12.39	11.80	12.38
	36RB-High (38)	1902.5 (19125)	12.36	11.79	12.32
		1880 (18900)	12.24	11.75	12.16
		1857.5 (18675)	12.31	11.81	12.22
	36RB-Middle (19)	1902.5 (19125)	12.39	11.84	12.36
		1880 (18900)	12.36	11.83	12.35
		1857.5 (18675)	12.42	11.94	12.37
	36RB-Low (0)	1902.5 (19125)	12.30	11.85	12.26
		1880 (18900)	12.30	11.78	12.24
		1857.5 (18675)	12.37	11.88	12.33
75RB (0)	1902.5 (19125)	12.33	11.77	12.31	
	1880 (18900)	12.27	11.80	12.21	
	1857.5 (18675)	12.34	11.78	12.25	
20MHz	1RB-High (99)	1900 (19100)	11.92	11.99	11.47
		1880 (18900)	11.94	11.85	11.55
		1860 (18700)	12.05	11.88	11.59
	1RB-Middle (50)	1900 (19100)	12.20	12.19	11.72
		1880 (18900)	12.16	12.21	11.62
		1860 (18700)	12.32	12.13	11.72
	1RB-Low (0)	1900 (19100)	12.22	12.15	11.68
		1880 (18900)	12.26	12.16	11.82
		1860 (18700)	12.23	12.05	11.76
	50RB-High (50)	1900 (19100)	12.18	11.67	11.49
		1880 (18900)	12.23	11.77	11.61
		1860 (18700)	12.19	11.65	11.60
	50RB-Middle (25)	1900 (19100)	12.36	11.88	11.79
		1880 (18900)	12.32	11.88	11.76
		1860 (18700)	12.41	11.86	11.72
	50RB-Low (0)	1900 (19100)	12.33	11.84	11.74
		1880 (18900)	12.35	11.87	11.72
		1860 (18700)	12.30	11.79	11.72
100RB (0)	1900 (19100)	12.25	11.80	11.66	
	1880 (18900)	12.25	11.77	11.58	
	1860 (18700)	12.22	11.76	11.66	

Band4-Low power					
BANDWIDTH	Number of RBs	Frequency	QPSK	16QAM	64QAM
1.4MHz	1RB-High (5)	1754.3 (20393)	12.27	12.27	12.20
		1732.5 (20175)	12.28	12.38	12.27
		1710.7 (19957)	12.28	12.60	12.24
	1RB-Middle (3)	1754.3 (20393)	12.34	12.32	12.34
		1732.5 (20175)	12.38	12.45	12.32
		1710.7 (19957)	12.34	12.62	12.30
	1RB-Low (0)	1754.3 (20393)	12.27	12.28	12.18
		1732.5 (20175)	12.36	12.42	12.32
		1710.7 (19957)	12.29	12.58	12.20
	3RB-High (3)	1754.3 (20393)	12.28	12.41	12.21
		1732.5 (20175)	12.29	12.33	12.26
		1710.7 (19957)	12.30	12.42	12.20
	3RB-Middle (1)	1754.3 (20393)	12.31	12.49	12.25
		1732.5 (20175)	12.29	12.37	12.20
		1710.7 (19957)	12.34	12.48	12.29
	3RB-Low (0)	1754.3 (20393)	12.27	12.43	12.18
		1732.5 (20175)	12.30	12.35	12.28
		1710.7 (19957)	12.28	12.44	12.26
	6RB (0)	1754.3 (20393)	12.25	12.46	12.19
		1732.5 (20175)	12.29	12.46	12.29
		1710.7 (19957)	12.29	12.16	12.28
3MHz	1RB-High (14)	1753.5 (20385)	12.25	12.28	12.20
		1732.5 (20175)	12.25	12.14	12.22
		1711.5 (19965)	12.30	12.58	12.29
	1RB-Middle (7)	1753.5 (20385)	12.33	12.35	12.31
		1732.5 (20175)	12.34	12.21	12.32
		1711.5 (19965)	12.29	12.55	12.20
	1RB-Low (0)	1753.5 (20385)	12.34	12.34	12.28
		1732.5 (20175)	12.29	12.19	12.20
		1711.5 (19965)	12.34	12.63	12.27
	8RB-High (7)	1753.5 (20385)	12.31	12.35	12.27
		1732.5 (20175)	12.31	12.44	12.28
		1711.5 (19965)	12.27	12.35	12.24
	8RB-Middle (4)	1753.5 (20385)	12.35	12.42	12.34
		1732.5 (20175)	12.35	12.46	12.31
		1711.5 (19965)	12.27	12.31	12.26
	8RB-Low (0)	1753.5 (20385)	12.28	12.35	12.19
		1732.5 (20175)	12.28	12.40	12.24
		1711.5 (19965)	12.34	12.41	12.29
	15RB (0)	1753.5 (20385)	12.36	12.31	12.33
		1732.5 (20175)	12.35	12.40	12.28
		1711.5 (19965)	12.25	12.29	12.19

5MHz	1RB-High (24)	1752.5 (20375)	12.33	12.44	12.30	
		1732.5 (20175)	12.30	12.44	12.26	
		1712.5 (19975)	12.33	12.77	12.29	
	1RB-Middle (12)	1752.5 (20375)	12.39	12.40	12.38	
		1732.5 (20175)	12.36	12.44	12.35	
		1712.5 (19975)	12.28	12.75	12.20	
	1RB-Low (0)	1752.5 (20375)	12.51	12.55	12.45	
		1732.5 (20175)	12.48	12.56	12.42	
		1712.5 (19975)	12.43	12.90	12.41	
	12RB-High (13)	1752.5 (20375)	12.36	12.40	12.33	
		1732.5 (20175)	12.32	12.39	12.29	
		1712.5 (19975)	12.37	12.47	12.37	
	12RB-Middle (6)	1752.5 (20375)	12.34	12.37	12.29	
		1732.5 (20175)	12.38	12.41	12.30	
		1712.5 (19975)	12.32	12.46	12.27	
	12RB-Low (0)	1752.5 (20375)	12.39	12.46	12.37	
		1732.5 (20175)	12.34	12.41	12.28	
		1712.5 (19975)	12.32	12.46	12.27	
	25RB (0)	1752.5 (20375)	12.34	12.31	12.28	
		1732.5 (20175)	12.36	12.39	12.31	
		1712.5 (19975)	12.33	12.37	12.31	
	10MHz	1RB-High (49)	1750 (20350)	12.54	12.54	12.48
			1732.5 (20175)	12.56	12.41	12.52
			1715 (20000)	12.49	12.83	12.40
1RB-Middle (24)		1750 (20350)	12.25	12.26	12.20	
		1732.5 (20175)	12.29	12.24	12.23	
		1715 (20000)	12.31	12.62	12.30	
1RB-Low (0)		1750 (20350)	12.48	12.50	12.41	
		1732.5 (20175)	12.46	12.35	12.44	
		1715 (20000)	12.53	12.83	12.46	
25RB-High (25)		1750 (20350)	12.35	12.41	12.26	
		1732.5 (20175)	12.34	12.38	12.30	
		1715 (20000)	12.38	12.44	12.30	
25RB-Middle (12)		1750 (20350)	12.29	12.34	12.20	
		1732.5 (20175)	12.42	12.42	12.37	
		1715 (20000)	12.31	12.37	12.21	
25RB-Low (0)		1750 (20350)	12.41	12.49	12.37	
		1732.5 (20175)	12.40	12.41	12.30	
		1715 (20000)	12.24	12.31	12.19	
50RB (0)		1750 (20350)	12.34	12.34	12.30	
		1732.5 (20175)	12.33	12.35	12.24	
		1715 (20000)	12.33	12.34	12.30	

15MHz	1RB-High (74)	1747.5 (20325)	12.56	12.91	12.49
		1732.5 (20175)	12.48	12.46	12.47
		1717.5 (20025)	12.54	12.83	12.47
	1RB-Middle (37)	1747.5 (20325)	12.25	12.66	12.18
		1732.5 (20175)	12.22	12.15	12.21
		1717.5 (20025)	12.27	12.59	12.26
	1RB-Low (0)	1747.5 (20325)	12.41	12.76	12.41
		1732.5 (20175)	12.45	12.38	12.40
		1717.5 (20025)	12.50	12.86	12.40
	36RB-High (38)	1747.5 (20325)	12.31	12.32	12.28
		1732.5 (20175)	12.33	12.32	12.28
		1717.5 (20025)	12.30	12.35	12.24
	36RB-Middle (19)	1747.5 (20325)	12.29	12.30	12.25
		1732.5 (20175)	12.31	12.32	12.25
		1717.5 (20025)	12.29	12.33	12.26
	36RB-Low (0)	1747.5 (20325)	12.18	12.15	12.18
		1732.5 (20175)	12.31	12.31	12.21
		1717.5 (20025)	12.24	12.30	12.20
75RB (0)	1747.5 (20325)	12.30	12.29	12.29	
	1732.5 (20175)	12.31	12.33	12.28	
	1717.5 (20025)	12.25	12.29	12.22	
20MHz	1RB-High (99)	1745 (20300)	13.53	13.94	12.25
		1732.5 (20175)	13.55	13.91	12.42
		1720 (20050)	13.66	14.05	12.46
	1RB-Middle (50)	1745 (20300)	13.38	13.87	12.22
		1732.5 (20175)	13.42	13.77	12.34
		1720 (20050)	13.50	13.89	12.30
	1RB-Low (0)	1745 (20300)	13.40	13.82	12.29
		1732.5 (20175)	13.43	13.77	12.40
		1720 (20050)	13.51	13.97	12.32
	50RB-High (50)	1745 (20300)	13.42	13.49	12.19
		1732.5 (20175)	13.48	13.47	12.18
		1720 (20050)	13.46	13.46	12.27
	50RB-Middle (25)	1745 (20300)	13.43	13.48	12.30
		1732.5 (20175)	13.38	13.36	12.17
		1720 (20050)	13.47	13.44	12.18
	50RB-Low (0)	1745 (20300)	13.36	13.44	12.05
		1732.5 (20175)	13.39	13.38	12.15
		1720 (20050)	13.39	13.39	12.10
100RB (0)	1745 (20300)	13.46	13.49	12.27	
	1732.5 (20175)	13.49	13.50	12.28	
	1720 (20050)	13.46	13.52	12.13	

Band5-Low power					
BANDWIDTH	Number of RBs	Frequency	QPSK	16QAM	64QAM
1.4MHz	1RB-High (5)	848.3 (20643)	16.33	16.48	16.66
		836.5 (20525)	16.43	16.58	16.23
		824.7 (20407)	16.35	16.79	16.00
	1RB-Middle (3)	848.3 (20643)	16.38	16.47	16.70
		836.5 (20525)	16.49	16.65	16.85
		824.7 (20407)	16.45	16.84	16.62
	1RB-Low (0)	848.3 (20643)	16.36	16.48	16.43
		836.5 (20525)	16.42	16.53	16.81
		824.7 (20407)	16.39	16.76	16.50
	3RB-High (3)	848.3 (20643)	16.36	16.53	16.83
		836.5 (20525)	16.43	16.47	16.26
		824.7 (20407)	16.31	16.55	16.57
	3RB-Middle (1)	848.3 (20643)	16.38	16.56	16.61
		836.5 (20525)	16.37	16.44	16.28
		824.7 (20407)	16.38	16.52	16.77
	3RB-Low (0)	848.3 (20643)	16.33	16.50	16.50
		836.5 (20525)	16.33	16.41	16.98
		824.7 (20407)	16.34	16.51	16.21
	6RB (0)	848.3 (20643)	16.34	16.55	16.66
		836.5 (20525)	16.34	16.54	16.02
		824.7 (20407)	16.35	16.28	16.81
3MHz	1RB-High (14)	847.5 (20635)	16.36	16.34	16.40
		836.5 (20525)	16.40	16.80	16.88
		825.5 (20415)	16.38	16.47	16.48
	1RB-Middle (7)	847.5 (20635)	16.39	16.39	16.80
		836.5 (20525)	16.45	16.86	16.88
		825.5 (20415)	16.44	16.55	16.30
	1RB-Low (0)	847.5 (20635)	16.28	16.24	16.08
		836.5 (20525)	16.50	16.92	16.84
		825.5 (20415)	16.38	16.45	16.87
	8RB-High (7)	847.5 (20635)	16.39	16.53	16.06
		836.5 (20525)	16.43	16.49	16.28
		825.5 (20415)	16.40	16.47	16.95
	8RB-Middle (4)	847.5 (20635)	16.38	16.52	16.67
		836.5 (20525)	16.48	16.60	16.38
		825.5 (20415)	16.32	16.43	16.65
	8RB-Low (0)	847.5 (20635)	16.28	16.41	16.88
		836.5 (20525)	16.41	16.52	16.23
		825.5 (20415)	16.35	16.42	16.63
	15RB (0)	847.5 (20635)	16.43	16.44	16.24
		836.5 (20525)	16.37	16.39	16.24
		825.5 (20415)	16.36	16.35	16.75

5MHz	1RB-High (24)	846.5 (20625)	16.43	16.57	16.85
		836.5 (20525)	16.36	16.92	16.45
		826.5 (20425)	16.49	16.64	16.81
	1RB-Middle (12)	846.5 (20625)	16.34	16.45	16.31
		836.5 (20525)	16.34	16.95	16.96
		826.5 (20425)	16.37	16.59	16.41
	1RB-Low (0)	846.5 (20625)	16.36	16.46	16.06
		836.5 (20525)	16.47	16.75	16.83
		826.5 (20425)	16.43	16.51	16.10
	12RB-High (13)	846.5 (20625)	16.42	16.46	16.70
		836.5 (20525)	16.41	16.57	16.57
		826.5 (20425)	16.41	16.48	16.96
	12RB-Middle (6)	846.5 (20625)	16.35	16.45	16.53
		836.5 (20525)	16.38	16.54	16.45
		826.5 (20425)	16.46	16.55	16.34
	12RB-Low (0)	846.5 (20625)	16.37	16.44	16.24
		836.5 (20525)	16.48	16.64	16.83
		826.5 (20425)	16.41	16.41	16.33
	25RB (0)	846.5 (20625)	16.35	16.35	16.28
		836.5 (20525)	16.41	16.50	16.78
		826.5 (20425)	16.48	16.43	16.31
10MHz	1RB-High (49)	844 (20600)	16.56	16.54	16.56
		836.5 (20525)	16.62	16.78	16.64
		829 (20450)	16.66	16.69	16.87
	1RB-Middle (24)	844 (20600)	16.25	16.20	16.39
		836.5 (20525)	16.33	16.66	16.43
		829 (20450)	16.33	16.35	16.67
	1RB-Low (0)	844 (20600)	16.45	16.49	16.44
		836.5 (20525)	16.57	16.92	16.94
		829 (20450)	16.41	16.45	16.42
	25RB-High (25)	844 (20600)	16.42	16.43	16.50
		836.5 (20525)	16.37	16.41	16.41
		829 (20450)	16.49	16.60	16.51
	25RB-Middle (12)	844 (20600)	16.27	16.30	16.34
		836.5 (20525)	16.36	16.38	16.39
		829 (20450)	16.29	16.40	16.37
	25RB-Low (0)	844 (20600)	16.32	16.34	16.38
		836.5 (20525)	16.42	16.47	16.55
		829 (20450)	16.34	16.47	16.35
	50RB (0)	844 (20600)	16.42	16.41	16.47
		836.5 (20525)	16.39	16.42	16.35
		829 (20450)	16.44	16.46	16.45

Band7-Low power					
BANDWIDTH	Number of RBs	Frequency	QPSK	16QAM	64QAM
5MHz	1RB-High (24)	2567.5 (21425)	10.29	10.60	10.24
		2535 (21100)	10.08	10.30	10.02
		2502.5 (20775)	10.23	10.67	10.26
	1RB-Middle (12)	2567.5 (21425)	10.31	10.56	10.47
		2535 (21100)	10.18	10.24	10.29
		2502.5 (20775)	10.06	10.75	10.05
	1RB-Low (0)	2567.5 (21425)	10.37	10.63	10.31
		2535 (21100)	10.25	10.40	10.10
		2502.5 (20775)	10.31	10.88	10.47
	12RB-High (13)	2567.5 (21425)	10.34	10.39	10.29
		2535 (21100)	10.09	10.15	10.20
		2502.5 (20775)	10.21	10.31	10.10
	12RB-Middle (6)	2567.5 (21425)	10.35	10.44	10.35
		2535 (21100)	10.09	10.17	10.24
		2502.5 (20775)	10.19	10.30	10.08
	12RB-Low (0)	2567.5 (21425)	10.35	10.45	10.34
		2535 (21100)	10.15	10.26	10.01
		2502.5 (20775)	10.23	10.38	10.31
	25RB (0)	2567.5 (21425)	10.37	10.28	10.30
		2535 (21100)	10.07	10.13	10.24
		2502.5 (20775)	10.22	10.29	10.39
10MHz	1RB-High (49)	2565 (21400)	10.45	10.52	10.44
		2535 (21100)	10.20	10.19	10.30
		2505 (20800)	10.35	10.76	10.31
	1RB-Middle (24)	2565 (21400)	10.34	10.34	10.33
		2535 (21100)	10.14	10.05	9.99
		2505 (20800)	10.17	10.51	10.28
	1RB-Low (0)	2565 (21400)	10.45	10.50	10.42
		2535 (21100)	10.34	10.39	10.35
		2505 (20800)	10.42	10.84	10.56
	25RB-High (25)	2565 (21400)	10.32	10.39	10.32
		2535 (21100)	10.04	10.09	10.08
		2505 (20800)	10.13	10.17	10.09
	25RB-Middle (12)	2565 (21400)	10.22	10.36	10.03
		2535 (21100)	10.05	10.08	10.06
		2505 (20800)	10.13	10.19	10.23
	25RB-Low (0)	2565 (21400)	10.28	10.41	10.34
		2535 (21100)	10.12	10.14	9.99
		2505 (20800)	10.25	10.29	10.29
50RB (0)	2565 (21400)	10.28	10.32	10.46	
	2535 (21100)	10.09	10.05	10.21	
	2505 (20800)	10.19	10.20	10.33	

15MHz	1RB-High (74)	2562.5 (21375)	10.15	10.26	10.07
		2535 (21100)	10.81	11.04	10.80
		2507.5 (20825)	10.13	9.90	10.22
	1RB-Middle (37)	2562.5 (21375)	10.58	10.71	10.62
		2535 (21100)	10.88	11.10	10.68
		2507.5 (20825)	10.53	10.30	10.54
	1RB-Low (0)	2562.5 (21375)	10.89	11.01	11.08
		2535 (21100)	10.71	10.95	10.68
		2507.5 (20825)	10.93	10.80	11.05
	36RB-High (38)	2562.5 (21375)	10.33	10.17	10.40
		2535 (21100)	10.82	10.60	10.84
		2507.5 (20825)	10.32	10.14	10.31
	36RB-Middle (19)	2562.5 (21375)	10.58	10.43	10.77
		2535 (21100)	10.86	10.64	10.80
		2507.5 (20825)	10.45	10.26	10.49
	36RB-Low (0)	2562.5 (21375)	10.73	10.58	10.66
		2535 (21100)	10.77	10.56	10.84
		2507.5 (20825)	10.53	10.33	10.64
75RB (0)	2562.5 (21375)	10.48	10.31	10.59	
	2535 (21100)	10.75	10.57	10.78	
	2507.5 (20825)	10.37	10.21	10.47	
20MHz	1RB-High (99)	2560 (21350)	10.15	10.58	9.95
		2535 (21100)	10.88	11.26	10.87
		2510 (20850)	10.21	10.54	10.30
	1RB-Middle (50)	2560 (21350)	10.73	11.16	10.79
		2535 (21100)	10.93	11.30	10.96
		2510 (20850)	10.63	10.96	10.63
	1RB-Low (0)	2560 (21350)	10.96	11.38	11.22
		2535 (21100)	10.69	11.07	11.00
		2510 (20850)	10.98	11.40	11.46
	50RB-High (50)	2560 (21350)	10.40	10.32	10.20
		2535 (21100)	10.93	10.82	10.77
		2510 (20850)	10.37	10.22	10.26
	50RB-Middle (25)	2560 (21350)	10.70	10.61	10.62
		2535 (21100)	10.93	10.82	10.84
		2510 (20850)	10.55	10.39	10.42
	50RB-Low (0)	2560 (21350)	10.87	10.78	10.91
		2535 (21100)	10.84	10.73	10.88
		2510 (20850)	10.60	10.45	10.61
100RB (0)	2560 (21350)	10.62	10.53	10.54	
	2535 (21100)	10.87	10.74	10.79	
	2510 (20850)	10.51	10.39	10.47	

Band12-Low power						
BANDWIDTH	Number of RBs	Frequency	QPSK	16QAM	64QAM	
1.4MHz	1RB-High (5)	715.3	16.08	15.85	16.21	
		707.5	16.27	16.36	16.21	
		699.7	16.27	16.14	16.20	
	1RB-Middle (3)	715.3	16.18	15.93	16.20	
		707.5	16.35	16.43	16.42	
		699.7	16.33	16.13	16.31	
	1RB-Low (0)	715.3	16.04	15.85	15.95	
		707.5	16.23	16.35	16.21	
		699.7	16.27	16.03	16.14	
	3RB-High (3)	715.3	16.11	15.77	16.14	
		707.5	16.21	16.07	16.24	
		699.7	16.26	16.16	16.28	
	3RB-Middle (1)	715.3	15.98	15.77	16.03	
		707.5	16.22	16.06	16.16	
		699.7	16.28	16.19	16.16	
	3RB-Low (0)	715.3	16.00	15.74	15.99	
		707.5	16.20	16.06	16.23	
		699.7	16.23	16.14	16.09	
	6RB (0)	715.3	15.95	15.89	16.04	
		707.5	16.15	15.78	16.06	
		699.7	16.26	16.17	16.21	
	3MHz	1RB-High (14)	714.5	16.11	15.64	16.00
			707.5	16.29	16.41	16.25
			700.5	16.28	16.16	16.25
		1RB-Middle (7)	714.5	16.11	15.72	16.17
			707.5	16.33	16.57	16.44
			700.5	16.34	16.22	16.34
1RB-Low (0)		714.5	16.10	15.72	16.03	
		707.5	16.23	16.38	16.15	
		700.5	16.30	16.17	16.33	
8RB-High (7)		714.5	16.03	15.87	16.08	
		707.5	16.24	16.02	16.30	
		700.5	16.27	16.00	16.33	
8RB-Middle (4)		714.5	16.05	15.89	16.13	
		707.5	16.27	16.08	16.23	
		700.5	16.30	16.07	16.18	
8RB-Low (0)		714.5	16.13	15.93	16.20	
		707.5	16.21	16.01	16.29	
		700.5	16.29	15.99	16.30	
15RB (0)		714.5	16.16	15.85	16.28	
		707.5	16.17	15.95	16.04	
		700.5	16.29	15.94	16.31	

5MHz	1RB-High (24)	713.5	16.30	16.34	16.24	
		707.5	16.32	16.11	16.44	
		701.5	16.44	16.23	16.37	
	1RB-Middle (12)	713.5	16.06	16.32	16.12	
		707.5	16.23	16.23	16.16	
		701.5	16.36	16.31	16.50	
	1RB-Low (0)	713.5	16.24	16.57	16.21	
		707.5	16.35	16.17	16.24	
		701.5	16.51	16.33	16.63	
	12RB-High (13)	713.5	16.02	15.94	16.05	
		707.5	16.29	16.03	16.28	
		701.5	16.30	16.12	16.26	
	12RB-Middle (6)	713.5	16.12	15.97	16.16	
		707.5	16.25	15.99	16.12	
		701.5	16.41	16.17	16.49	
	12RB-Low (0)	713.5	16.15	16.01	16.23	
		707.5	16.27	16.03	16.15	
		701.5	16.37	16.17	16.28	
	25RB (0)	713.5	16.16	15.93	16.03	
		707.5	16.28	15.93	16.20	
		701.5	16.41	16.12	16.54	
	10MHz	1RB-High (49)	711	16.27	16.00	16.31
			707.5	16.52	16.55	16.64
			704	16.49	16.23	16.66
1RB-Middle (24)		711	16.25	15.86	16.31	
		707.5	16.33	16.42	16.23	
		704	16.32	16.03	16.39	
1RB-Low (0)		711	16.54	16.33	16.67	
		707.5	16.67	16.77	16.75	
		704	16.71	16.55	16.72	
25RB-High (25)		711	16.24	15.95	16.09	
		707.5	16.32	16.02	16.10	
		704	16.36	16.16	16.16	
25RB-Middle (12)		711	16.28	16.07	16.19	
		707.5	16.36	16.05	16.20	
		704	16.42	16.24	16.25	
25RB-Low (0)		711	16.38	16.11	16.27	
		707.5	16.41	16.15	16.29	
		704	16.53	16.36	16.51	
50RB (0)		711	16.28	15.96	16.17	
		707.5	16.39	16.08	16.20	
		704	16.40	16.16	16.26	

Band18-Low power						
BANDWIDTH	Number of RBs	Frequency	QPSK	16QAM	64QAM	
5MHz	1RB-High (24)	827.5 (23975)	16.59	16.40	15.75	
		822.5 (23925)	16.61	16.48	15.76	
		817.5 (23875)	16.55	16.75	15.76	
	1RB-Middle (12)	827.5 (23975)	16.49	16.41	15.69	
		822.5 (23925)	16.55	16.39	15.75	
		817.5 (23875)	16.56	16.77	15.74	
	1RB-Low (0)	827.5 (23975)	16.65	16.51	15.79	
		822.5 (23925)	16.70	16.54	15.89	
		817.5 (23875)	16.65	16.74	15.86	
	12RB-High (13)	827.5 (23975)	16.51	16.26	15.68	
		822.5 (23925)	16.56	16.32	15.77	
		817.5 (23875)	16.55	16.36	15.77	
	12RB-Middle (6)	827.5 (23975)	16.56	16.29	15.76	
		822.5 (23925)	16.54	16.37	15.75	
		817.5 (23875)	16.57	16.38	15.76	
	12RB-Low (0)	827.5 (23975)	16.59	16.38	15.75	
		822.5 (23925)	16.56	16.38	15.77	
		817.5 (23875)	16.53	16.38	15.74	
	25RB (0)	827.5 (23975)	16.52	16.19	15.67	
		822.5 (23925)	16.57	16.30	15.79	
		817.5 (23875)	16.56	16.34	15.69	
	10MHz	1RB-High (49)	825 (23950)	16.74	16.50	15.96
			822.5 (23925)	16.84	16.46	16.06
			820 (23900)	16.87	16.91	16.05
1RB-Middle (24)		825 (23950)	16.49	16.21	15.69	
		822.5 (23925)	16.52	16.21	15.65	
		820 (23900)	16.52	16.58	15.70	
1RB-Low (0)		825 (23950)	16.63	16.43	15.76	
		822.5 (23925)	16.57	16.24	15.77	
		820 (23900)	16.60	16.74	15.74	
25RB-High (25)		825 (23950)	16.60	16.41	15.78	
		822.5 (23925)	16.67	16.38	15.88	
		820 (23900)	16.68	16.37	15.86	
25RB-Middle (12)		825 (23950)	16.53	16.37	15.72	
		822.5 (23925)	16.58	16.32	15.78	
		820 (23900)	16.54	16.25	15.69	
25RB-Low (0)		825 (23950)	16.51	16.34	15.69	
		822.5 (23925)	16.56	16.30	15.72	
		820 (23900)	16.50	16.26	15.64	
50RB (0)		825 (23950)	16.59	16.32	15.77	
		822.5 (23925)	16.60	16.32	15.80	
		820 (23900)	16.53	16.26	15.68	



15MHz	1RB-High (74)	822.5 (23925)	16.57	16.52	15.70
	1RB-Middle (37)	822.5 (23925)	16.75	16.77	16.17
	1RB-Low (0)	822.5 (23925)	16.75	16.80	16.18
	36RB-High (38)	822.5 (23925)	16.82	16.49	16.00
	36RB-Middle (19)	822.5 (23925)	16.94	16.66	16.22
	36RB-Low (0)	822.5 (23925)	17.01	16.76	16.34
	75RB (0)	822.5 (23925)	16.87	16.57	16.09

Band19-Low power					
BANDWIDTH	Number of RBs	Frequency	QPSK	16QAM	64QAM
5MHz	1RB-High (24)	842.5 (24125)	16.66	16.49	15.96
		837.5 (24075)	16.57	16.41	15.88
		832.5 (24025)	16.55	16.82	15.80
	1RB-Middle (12)	842.5 (24125)	16.52	16.43	15.83
		837.5 (24075)	16.57	16.41	15.89
		832.5 (24025)	16.43	16.73	15.72
	1RB-Low (0)	842.5 (24125)	16.68	16.49	15.90
		837.5 (24075)	16.60	16.38	15.78
		832.5 (24025)	16.56	16.85	15.89
	12RB-High (13)	842.5 (24125)	16.64	16.39	15.87
		837.5 (24075)	16.51	16.32	15.75
		832.5 (24025)	16.50	16.39	15.82
	12RB-Middle (6)	842.5 (24125)	16.64	16.37	15.98
		837.5 (24075)	16.51	16.33	15.83
		832.5 (24025)	16.56	16.39	15.80
	12RB-Low (0)	842.5 (24125)	16.63	16.42	15.91
		837.5 (24075)	16.50	16.31	15.71
		832.5 (24025)	16.55	16.40	15.83
	25RB (0)	842.5 (24125)	16.62	16.32	15.89
		837.5 (24075)	16.53	16.26	15.83
		832.5 (24025)	16.52	16.28	15.75
10MHz	1RB-High (49)	840 (24100)	16.90	16.61	16.14
		837.5 (24075)	16.89	16.51	16.07
		835 (24050)	16.84	16.92	16.09
	1RB-Middle (24)	840 (24100)	16.48	16.23	15.69
		837.5 (24075)	16.47	16.21	15.66
		835 (24050)	16.56	16.60	15.73
	1RB-Low (0)	840 (24100)	16.53	16.34	15.75
		837.5 (24075)	16.58	16.36	15.86
		835 (24050)	16.62	16.83	15.93
	25RB-High (25)	840 (24100)	16.67	16.49	15.86
		837.5 (24075)	16.60	16.33	15.81
		835 (24050)	16.59	16.35	15.80
	25RB-Middle (12)	840 (24100)	16.53	16.34	15.73
		837.5 (24075)	16.54	16.26	15.77
		835 (24050)	16.56	16.33	15.83
	25RB-Low (0)	840 (24100)	16.47	16.29	15.68
		837.5 (24075)	16.45	16.17	15.65
		835 (24050)	16.49	16.21	15.71
	50RB (0)	840 (24100)	16.55	16.28	15.86
		837.5 (24075)	16.53	16.22	15.77
		835 (24050)	16.51	16.23	15.70



15MHz	1RB-High (74)	837.5 (24075)	16.92	16.95	16.26
	1RB-Middle (37)	837.5 (24075)	17.00	17.00	16.34
	1RB-Low (0)	837.5 (24075)	17.09	17.08	16.46
	36RB-High (38)	837.5 (24075)	16.88	16.47	16.10
	36RB-Middle (19)	837.5 (24075)	16.92	16.49	16.09
	36RB-Low (0)	837.5 (24075)	16.94	16.49	16.06
	75RB (0)	837.5 (24075)	16.87	16.47	16.04

Band28-Low power					
BANDWIDTH	Number of RBs	Frequency	QPSK	16QAM	64QAM
3MHz	1RB-High (14)	746.5 (27645)	15.23	15.04	14.93
		719.5 (27375)	15.63	15.95	15.47
		704.5 (27225)	15.84	15.89	15.55
	1RB-Middle (7)	746.5 (27645)	15.25	15.18	14.96
		719.5 (27375)	15.72	16.17	15.38
		704.5 (27225)	15.96	15.92	15.80
	1RB-Low (0)	746.5 (27645)	15.27	15.14	14.95
		719.5 (27375)	15.72	16.12	15.38
		704.5 (27225)	15.84	15.79	15.67
	8RB-High (7)	746.5 (27645)	15.21	15.26	15.07
		719.5 (27375)	15.63	15.63	15.37
		704.5 (27225)	15.87	15.78	15.58
	8RB-Middle (4)	746.5 (27645)	15.24	15.25	14.98
		719.5 (27375)	15.67	15.71	15.39
		704.5 (27225)	15.81	15.73	15.45
	8RB-Low (0)	746.5 (27645)	15.21	15.25	14.90
		719.5 (27375)	15.68	15.67	15.38
		704.5 (27225)	15.86	15.77	15.61
	15RB (0)	746.5 (27645)	15.24	15.16	14.89
		719.5 (27375)	15.70	15.58	15.55
		704.5 (27225)	15.85	15.70	15.56
5MHz	1RB-High (24)	745.5 (27635)	15.29	15.32	15.02
		720.5 (27385)	15.71	15.72	15.57
		705.5 (27235)	15.76	16.22	15.61
	1RB-Middle (12)	745.5 (27635)	15.25	15.34	15.01
		720.5 (27385)	15.71	15.75	15.40
		705.5 (27235)	15.76	16.26	15.44
	1RB-Low (0)	745.5 (27635)	15.33	15.35	15.07
		720.5 (27385)	15.89	15.88	15.74
		705.5 (27235)	15.85	16.28	15.55
	12RB-High (13)	745.5 (27635)	15.28	15.25	15.05
		720.5 (27385)	15.62	15.60	15.50
		705.5 (27235)	15.81	15.81	15.62
	12RB-Middle (6)	745.5 (27635)	15.37	15.28	15.11
		720.5 (27385)	15.66	15.67	15.32
		705.5 (27235)	15.89	15.88	15.72
	12RB-Low (0)	745.5 (27635)	15.29	15.24	15.10
		720.5 (27385)	15.68	15.70	15.39
		705.5 (27235)	15.92	15.90	15.74
	25RB (0)	745.5 (27635)	15.32	15.18	15.01
		720.5 (27385)	15.67	15.60	15.36
		705.5 (27235)	15.89	15.81	15.76

10MHz	1RB-High (49)	743 (27610)	15.36	15.29	15.06
		723 (27410)	15.64	15.48	15.46
		708 (27260)	15.28	15.56	14.99
	1RB-Middle (24)	743 (27610)	15.29	15.25	15.07
		723 (27410)	15.57	15.41	15.44
		708 (27260)	15.77	16.06	15.49
	1RB-Low (0)	743 (27610)	15.42	15.35	15.20
		723 (27410)	15.78	15.68	15.66
		708 (27260)	15.42	15.76	15.09
	25RB-High (25)	743 (27610)	15.32	15.31	14.97
		723 (27410)	15.53	15.43	15.40
		708 (27260)	15.63	15.59	15.35
	25RB-Middle (12)	743 (27610)	15.29	15.28	15.03
		723 (27410)	15.59	15.51	15.37
		708 (27260)	15.74	15.68	15.55
	25RB-Low (0)	743 (27610)	15.36	15.34	15.23
		723 (27410)	15.61	15.51	15.45
		708 (27260)	15.72	15.67	15.41
50RB (0)	743 (27610)	15.33	15.27	15.22	
	723 (27410)	15.62	15.47	15.35	
	708 (27260)	15.69	15.62	15.39	
15MHz	1RB-High (74)	740.5 (27585)	15.05	14.99	14.70
		725.5 (27435)	15.27	15.58	14.97
		710.5 (27285)	15.65	15.95	15.48
	1RB-Middle (37)	740.5 (27585)	15.36	15.23	15.12
		725.5 (27435)	15.76	16.02	15.54
		710.5 (27285)	15.73	16.09	15.61
	1RB-Low (0)	740.5 (27585)	15.11	14.99	14.89
		725.5 (27435)	15.55	15.88	15.21
		710.5 (27285)	16.02	16.38	15.85
	36RB-High (38)	740.5 (27585)	15.20	15.13	15.07
		725.5 (27435)	15.48	15.45	15.34
		710.5 (27285)	15.71	15.62	15.45
	36RB-Middle (19)	740.5 (27585)	15.28	15.22	14.97
		725.5 (27435)	15.63	15.61	15.37
		710.5 (27285)	15.71	15.64	15.57
	36RB-Low (0)	740.5 (27585)	15.22	15.12	15.09
		725.5 (27435)	15.65	15.62	15.39
		710.5 (27285)	15.77	15.69	15.45
75RB (0)	740.5 (27585)	15.22	15.13	15.05	
	725.5 (27435)	15.59	15.56	15.30	
	710.5 (27285)	15.79	15.72	15.51	



20MHz	1RB-High (99)	738 (27560)	14.67	15.42	14.87
		728 (27460)	14.84	15.61	14.66
		713 (27310)	15.33	15.95	15.05
	1RB-Middle (50)	738 (27560)	14.90	15.74	14.61
		728 (27460)	15.15	15.90	14.89
		713 (27310)	15.35	16.07	15.16
	1RB-Low (0)	738 (27560)	14.72	15.54	14.65
		728 (27460)	15.15	15.98	14.90
		713 (27310)	15.80	16.44	15.55
	50RB-High (50)	738 (27560)	14.92	15.16	14.76
		728 (27460)	15.12	15.30	14.88
		713 (27310)	15.46	15.57	15.15
	50RB-Middle (25)	738 (27560)	15.01	15.23	14.83
		728 (27460)	15.37	15.56	15.22
		713 (27310)	15.50	15.66	15.36
	50RB-Low (0)	738 (27560)	14.87	15.10	14.72
		728 (27460)	15.39	15.55	15.29
		713 (27310)	15.62	15.80	15.51
	100RB (0)	738 (27560)	14.85	15.13	14.73
		728 (27460)	15.22	15.40	15.04
		713 (27310)	15.54	15.67	15.36

Band38-Low power						
BANDWIDTH	Number of RBs	Frequency	QPSK	16QAM	64QAM	
5MHz	1RB-High (24)	2617.5 (38225)	12.23	12.66	12.58	
		2595 (38000)	12.04	12.46	12.50	
		2572.5 (37775)	12.06	12.49	12.44	
	1RB-Middle (12)	2617.5 (38225)	12.23	12.56	12.55	
		2595 (38000)	12.15	12.37	12.62	
		2572.5 (37775)	11.88	12.40	12.68	
	1RB-Low (0)	2617.5 (38225)	12.25	12.68	12.69	
		2595 (38000)	12.20	12.49	12.71	
		2572.5 (37775)	12.09	12.55	12.42	
	12RB-High (13)	2617.5 (38225)	12.20	12.01	12.62	
		2595 (38000)	12.09	11.80	12.69	
		2572.5 (37775)	12.03	11.74	12.61	
	12RB-Middle (6)	2617.5 (38225)	12.24	12.05	12.63	
		2595 (38000)	12.13	11.87	12.75	
		2572.5 (37775)	12.06	11.76	12.66	
	12RB-Low (0)	2617.5 (38225)	12.25	12.05	12.70	
		2595 (38000)	12.12	11.86	12.77	
		2572.5 (37775)	12.03	11.78	12.59	
	25RB (0)	2617.5 (38225)	12.22	11.93	12.61	
		2595 (38000)	12.15	11.90	12.77	
		2572.5 (37775)	12.06	11.78	12.65	
	10MHz	1RB-High (49)	2615 (38200)	12.41	12.89	12.73
			2595 (38000)	12.37	12.71	12.76
			2575 (37800)	12.42	12.67	12.82
1RB-Middle (24)		2615 (38200)	12.09	12.77	12.57	
		2595 (38000)	12.15	12.46	12.76	
		2575 (37800)	12.11	12.49	12.68	
1RB-Low (0)		2615 (38200)	12.27	12.86	12.76	
		2595 (38000)	12.24	12.54	12.71	
		2575 (37800)	12.21	12.44	12.60	
25RB-High (25)		2615 (38200)	12.27	12.02	12.78	
		2595 (38000)	12.17	11.91	12.75	
		2575 (37800)	12.07	11.78	12.74	
25RB-Middle (12)		2615 (38200)	12.15	11.88	12.77	
		2595 (38000)	12.11	11.85	12.68	
		2575 (37800)	12.03	11.74	12.63	
25RB-Low (0)		2615 (38200)	12.16	11.89	12.70	
		2595 (38000)	12.11	11.80	12.79	
		2575 (37800)	12.00	11.73	12.57	
50RB (0)		2615 (38200)	12.19	11.94	12.76	
		2595 (38000)	12.13	11.83	12.74	
		2575 (37800)	12.09	11.79	12.63	

15MHz	1RB-High (74)	2612.5 (38175)	12.55	12.92	12.52	
		2595 (38000)	12.40	12.70	12.69	
		2577.5 (37825)	12.40	12.69	12.59	
	1RB-Middle (37)	2612.5 (38175)	12.52	12.92	12.74	
		2595 (38000)	12.35	12.65	12.59	
		2577.5 (37825)	12.40	12.69	12.79	
	1RB-Low (0)	2612.5 (38175)	12.39	12.81	12.51	
		2595 (38000)	12.17	12.39	12.64	
		2577.5 (37825)	12.21	12.51	12.42	
	36RB-High (38)	2612.5 (38175)	12.50	12.24	12.82	
		2595 (38000)	12.31	12.05	12.84	
		2577.5 (37825)	12.29	12.00	12.84	
	36RB-Middle (19)	2612.5 (38175)	12.52	12.25	12.81	
		2595 (38000)	12.26	11.98	12.84	
		2577.5 (37825)	12.20	11.90	12.76	
	36RB-Low (0)	2612.5 (38175)	12.44	12.13	12.79	
		2595 (38000)	12.17	11.90	12.77	
		2577.5 (37825)	12.12	11.79	12.65	
	75RB (0)	2612.5 (38175)	12.48	12.23	12.78	
		2595 (38000)	12.22	11.94	12.84	
		2577.5 (37825)	12.12	11.88	12.70	
	20MHz	1RB-High (99)	2610 (38150)	12.72	12.95	12.89
			2595 (38000)	12.38	12.67	12.78
			2580 (37850)	12.36	12.62	12.81
		1RB-Middle (50)	2610 (38150)	12.62	12.96	12.93
			2595 (38000)	12.25	12.58	12.86
			2580 (37850)	12.29	12.59	12.81
1RB-Low (0)		2610 (38150)	12.40	12.66	12.92	
		2595 (38000)	12.10	12.48	12.76	
		2580 (37850)	12.10	12.40	12.55	
50RB-High (50)		2610 (38150)	12.52	12.26	13.01	
		2595 (38000)	12.22	12.02	12.80	
		2580 (37850)	12.24	11.90	12.85	
50RB-Middle (25)		2610 (38150)	12.42	12.16	12.96	
		2595 (38000)	12.25	12.01	12.86	
		2580 (37850)	12.27	11.93	12.90	
50RB-Low (0)		2610 (38150)	12.32	12.12	12.97	
		2595 (38000)	12.16	11.93	12.86	
		2580 (37850)	12.10	11.79	12.75	
100RB (0)		2610 (38150)	12.34	12.10	13.01	
		2595 (38000)	12.23	11.93	12.89	
		2580 (37850)	12.11	11.79	12.78	

Band66-Low power					
BANDWIDTH	Number of RBs	Frequency	QPSK	16QAM	64QAM
1.4MHz	1RB-High (5)	1779.3 (132665)	12.13	11.61	12.13
		1745 (132322)	12.17	11.75	12.10
		1710.7 (131979)	12.14	11.96	11.89
	1RB-Middle (3)	1779.3 (132665)	12.21	11.66	12.11
		1745 (132322)	12.18	11.80	12.18
		1710.7 (131979)	12.18	11.99	12.00
	1RB-Low (0)	1779.3 (132665)	12.12	11.61	11.95
		1745 (132322)	12.13	11.72	12.01
		1710.7 (131979)	12.13	11.93	12.16
	3RB-High (3)	1779.3 (132665)	12.13	11.78	12.09
		1745 (132322)	12.15	11.72	12.18
		1710.7 (131979)	12.12	11.79	11.91
	3RB-Middle (1)	1779.3 (132665)	12.18	11.84	11.94
		1745 (132322)	12.18	11.76	12.13
		1710.7 (131979)	12.16	11.84	12.08
	3RB-Low (0)	1779.3 (132665)	12.12	11.77	12.07
		1745 (132322)	12.16	11.74	12.04
		1710.7 (131979)	12.13	11.82	11.96
	6RB (0)	1779.3 (132665)	12.12	11.81	12.06
		1745 (132322)	12.15	11.79	12.13
		1710.7 (131979)	12.12	11.51	12.12
3MHz	1RB-High (14)	1778.5 (132657)	12.12	11.58	12.11
		1745 (132322)	12.13	11.52	12.11
		1711.5 (131987)	12.19	11.98	12.07
	1RB-Middle (7)	1778.5 (132657)	12.14	11.62	12.08
		1745 (132322)	12.23	11.59	12.02
		1711.5 (131987)	12.17	11.93	12.19
	1RB-Low (0)	1778.5 (132657)	12.21	11.72	12.19
		1745 (132322)	12.15	11.61	12.11
		1711.5 (131987)	12.22	12.02	12.13
	8RB-High (7)	1778.5 (132657)	12.16	11.65	12.12
		1745 (132322)	12.17	11.76	11.93
		1711.5 (131987)	12.15	11.72	12.04
	8RB-Middle (4)	1778.5 (132657)	12.15	11.72	11.95
		1745 (132322)	12.26	11.84	12.02
		1711.5 (131987)	12.13	11.72	11.93
	8RB-Low (0)	1778.5 (132657)	12.15	11.74	11.93
		1745 (132322)	12.18	11.77	12.04
		1711.5 (131987)	12.18	11.79	12.10
	15RB (0)	1778.5 (132657)	12.18	11.62	12.06
		1745 (132322)	12.24	11.76	12.05
		1711.5 (131987)	12.14	11.66	12.16

5MHz	1RB-High (24)	1777.5 (132647)	12.21	11.74	12.22	
		1745 (132322)	12.26	11.91	12.23	
		1712.5 (131997)	12.18	12.13	12.19	
	1RB-Middle (12)	1777.5 (132647)	12.29	11.78	12.09	
		1745 (132322)	12.26	11.82	12.05	
		1712.5 (131997)	12.26	12.19	12.18	
	1RB-Low (0)	1777.5 (132647)	12.32	11.88	12.19	
		1745 (132322)	12.39	11.99	12.41	
		1712.5 (131997)	12.30	12.28	12.12	
	12RB-High (13)	1777.5 (132647)	12.19	11.70	12.04	
		1745 (132322)	12.16	11.77	11.95	
		1712.5 (131997)	12.18	11.85	12.01	
	12RB-Middle (6)	1777.5 (132647)	12.26	11.75	12.19	
		1745 (132322)	12.25	11.84	12.12	
		1712.5 (131997)	12.23	11.88	12.01	
	12RB-Low (0)	1777.5 (132647)	12.22	11.78	12.03	
		1745 (132322)	12.22	11.82	11.99	
		1712.5 (131997)	12.26	11.90	12.07	
	25RB (0)	1777.5 (132647)	12.21	11.69	12.04	
		1745 (132322)	12.24	11.77	12.16	
		1712.5 (131997)	12.22	11.79	12.06	
	10MHz	1RB-High (49)	1775 (132622)	12.57	12.02	12.33
			1745 (132322)	12.58	12.53	12.57
			1715 (132022)	12.57	12.09	12.46
1RB-Middle (24)		1775 (132622)	12.16	11.60	11.99	
		1745 (132322)	12.24	12.06	12.04	
		1715 (132022)	12.14	11.62	12.09	
1RB-Low (0)		1775 (132622)	11.55	10.96	11.32	
		1745 (132322)	11.62	11.45	11.47	
		1715 (132022)	11.54	11.07	11.34	
25RB-High (25)		1775 (132622)	12.30	11.82	12.22	
		1745 (132322)	12.34	11.84	12.22	
		1715 (132022)	12.28	11.92	12.22	
25RB-Middle (12)		1775 (132622)	12.26	11.82	12.22	
		1745 (132322)	12.27	11.80	12.21	
		1715 (132022)	12.21	11.81	12.20	
25RB-Low (0)		1775 (132622)	12.14	11.67	11.92	
		1745 (132322)	12.17	11.70	12.13	
		1715 (132022)	12.14	11.74	11.97	
50RB (0)		1775 (132622)	12.24	11.70	12.17	
		1745 (132322)	12.22	11.78	11.98	
		1715 (132022)	12.19	11.74	12.03	

15MHz	1RB-High (74)	1772.5 (132597)	12.14	11.56	11.90
		1745 (132322)	12.20	12.00	12.10
		1717.5 (132047)	12.23	12.10	12.24
	1RB-Middle (37)	1772.5 (132597)	12.03	11.45	11.93
		1745 (132322)	12.10	11.91	12.08
		1717.5 (132047)	12.14	12.02	12.11
	1RB-Low (0)	1772.5 (132597)	12.31	11.70	12.20
		1745 (132322)	12.32	12.13	12.21
		1717.5 (132047)	12.34	12.21	12.36
	36RB-High (38)	1772.5 (132597)	12.03	11.52	11.90
		1745 (132322)	11.97	11.51	11.86
		1717.5 (132047)	12.04	11.51	12.00
	36RB-Middle (19)	1772.5 (132597)	12.06	11.58	11.92
		1745 (132322)	12.05	11.63	11.96
		1717.5 (132047)	12.17	11.62	12.11
	36RB-Low (0)	1772.5 (132597)	12.18	11.68	12.09
		1745 (132322)	12.05	11.60	12.06
		1717.5 (132047)	12.16	11.64	12.01
	75RB (0)	1772.5 (132597)	12.13	11.64	12.14
		1745 (132322)	12.05	11.61	12.05
		1717.5 (132047)	12.13	11.70	12.04
20MHz	1RB-High (99)	1770 (132572)	12.50	12.42	12.33
		1745 (132322)	12.38	12.32	12.39
		1720 (132072)	12.43	12.26	12.28
	1RB-Middle (50)	1770 (132572)	12.14	12.04	12.17
		1745 (132322)	12.08	12.02	12.00
		1720 (132072)	12.12	11.99	12.10
	1RB-Low (0)	1770 (132572)	11.91	11.87	11.88
		1745 (132322)	11.86	11.77	11.74
		1720 (132072)	11.92	11.78	11.81
	50RB-High (50)	1770 (132572)	12.10	11.60	11.89
		1745 (132322)	12.14	11.69	11.89
		1720 (132072)	12.20	11.69	11.92
	50RB-Middle (25)	1770 (132572)	12.10	11.61	11.92
		1745 (132322)	12.11	11.67	11.86
		1720 (132072)	12.23	11.65	11.98
	50RB-Low (0)	1770 (132572)	12.04	11.53	11.86
		1745 (132322)	12.00	11.63	11.75
		1720 (132072)	12.12	11.57	11.90
	100RB (0)	1770 (132572)	12.04	11.60	11.87
		1745 (132322)	12.09	11.60	11.83
		1720 (132072)	12.15	11.69	11.95

The conducted power measurement results of downlink LTE CA Conducted Power are as below(2CA)

Normal power														
DL LTE CA Class	PCC								SCC			Power		
	PCC Band	PCC Bandwidth (MHz)	PCC UL RB size	PCC UL RB offset	PCC DL RB size	PCC DL RB offset	PCC UL Channel	PCC DL Channel	SCC Band	SCC Bandwidth	SCC	Rel 8 LTE Tx Power(dBm)	Rel 10 DL LTE CA Tx Power(dBm)	Tune-up
										(MHz)	DL Channel			
12A-66A	12	5	1	13	25	0	23155	5155	66	20	67036	24.71	24.17	25.7
2A-12A	2	20	1	50	100	0	18700	700	12	10	5060	24.13	24.12	24.5
28A-38A	28	5	1	12	25	0	27235	9235	38	20	38150	24.98	24.89	24.5
5A-7A	5	10	1	49	50	0	20600	2600	7	20	3100	23.7	23.75	24.5
7A-28A	7	10	1	0	50	0	21400	2800	28	20	9310	23.12	23.34	23.8
7A-7A	7	10	1	0	50	0	21400	2800	7	10	3400	23.12	23.32	23.8
66A-66A	66	10	1	49	50	0	132022	66486	66	10	67286	23.93	24.23	24.7
7C	7	10	1	0	50	0	21400	2800	7	20	2949	23.12	23.31	23.8
66B	66	10	1	49	50	0	132572	67036	66	5	67108	23.87	24.23	24.7
66C	66	20	1	99	100	0	132572	67036	66	10	67180	23.93	24.41	24.7

Low power														
DL LTE CA Class	PCC								SCC			Power		
	PCC Band	PCC Bandwidth (MHz)	PCC UL RB size	PCC UL RB offset	PCC DL RB size	PCC DL RB offset	PCC UL Channel	PCC DL Channel	SCC Band	SCC Bandwidth	SCC	Rel 8 LTE Tx Power(dBm)	Rel 10 DL LTE CA Tx Power(dBm)	Tune-up
										(MHz)	DL Channel			
12A-66A	12	5	1	13	25	0	23155	5155	66	20	67036	16.71	16.82	17.1
2A-12A	2	15	1	0	75	0	19125	1125	12	10	5060	12.66	12.61	12.7
28A-38A	28	15	1	0	75	0	27285	9285	38	20	38150	16.02	16.22	16.6
5A-7A	5	10	1	49	50	0	20450	2450	7	20	3100	16.66	16.94	17.8
7A-28A	7	20	1	0	100	0	20850	2850	28	15	9285	10.98	11.23	11.7
7A-7A	7	20	1	0	100	0	20850	2850	7	5	3425	10.98	11.39	11.7
66A-66A	66	10	1	49	50	0	132322	66786	66	10	66786	12.58	12.74	12.8
7C	7	20	1	0	100	0	20850	2850	7	50	2994	10.98	11.46	11.7
66B	66	10	1	49	50	0	132622	67086	66	5	67158	12.58	12.77	12.8
66C	66	10	1	49	50	0	132622	67086	66	20	67230	12.58	12.79	12.8

11.4 Wi-Fi and BT Measurement result

The maximum output power of BT is 9.04dBm.

The maximum tune up of BT is 9.7dBm.

WiFi 2.4G-Normal power

802.11b				
Channel\data rate	1Mbps	2Mbps	5.5Mbps	11Mbps
11(2462MHz)	18.49	18.51	18.52	18.50
6(2437(MHz)	18.30	/	17.87	/
1(2412MHz)	17.61	/	17.58	/
Tune up	19.50	19.50	19.50	19.50

802.11g								
Channel\data rate	6Mbps	9Mbps	12Mbps	18Mbps	24Mbps	36Mbps	48Mbps	54Mbps
11(2462MHz)	17.04	16.52	15.96	16.19	15.99	15.34	14.48	14.39
6(2437(MHz)	16.56	/	/	/	/	/	/	/
1(2412MHz)	16.05	/	/	/	/	/	/	/
Tune up	18.00	17.50	17.00	17.00	17.00	16.50	16.00	15.50

802.11n-20M								
Channel\data rate	MCS0	MCS1	MCS2	MCS3	MCS4	MCS5	MCS6	MCS7
11(2462MHz)	17.05	16.35	16.23	16.19	16.07	15.54	15.01	14.46
6(2437(MHz)	16.57	/	/	/	/	/	/	/
1(2412MHz)	16.05	/	/	/	/	/	/	/
Tune up	18.00	17.50	17.00	17.00	17.00	16.50	16.00	15.00

WiFi 2.4G-Low power

802.11b				
Channel\data rate	1Mbps	2Mbps	5.5Mbps	11Mbps
11(2462MHz)	13.40	/	13.32	/
6(2437(MHz)	13.58	13.55	13.59	13.53
1(2412MHz)	13.27	/	13.25	/
Tune up	14.00	14.00	14.00	14.00

802.11g								
Channel\data rate	6Mbps	9Mbps	12Mbps	18Mbps	24Mbps	36Mbps	48Mbps	54Mbps
11(2462MHz)	13.66	13.62	13.64	13.68	13.66	13.63	13.60	13.61
6(2437(MHz)	13.52	/	/	13.62	/	/	/	/
1(2412MHz)	13.26	/	/	13.30	/	/	/	/
Tune up	14.00	14.00	14.00	14.00	14.00	14.00	14.00	14.00

802.11n-20M								
Channel\data rate	MCS0	MCS1	MCS2	MCS3	MCS4	MCS5	MCS6	MCS7
11(2462MHz)	13.41	13.43	13.56	13.57	13.53	13.45	13.47	13.35
6(2437(MHz)	13.30	/	/	13.48	/	/	/	/
1(2412MHz)	12.98	/	/	13.09	/	/	/	/
Tune up	14.00	14.00	14.00	14.00	14.00	14.00	14.00	14.00

WiFi 5G- Normal power

Channel\data rate	802.11a(dBm)							
	6Mbps	9Mbps	12Mbps	18Mbps	24Mbps	36Mbps	48Mbps	54Mbps
36(5180 MHz)	18.37	/	/	/	/	/	/	/
40(5200 MHz)	18.57	/	/	/	/	/	/	/
44(5220 MHz)	18.58	17.72	17.16	16.68	16.15	15.65	15.25	14.67
48(5240 MHz)	18.13	/	/	/	/	/	/	/
52(5260 MHz)	17.98	16.89	16.38	15.84	15.18	14.79	14.28	13.82
56(5280 MHz)	17.61	/	/	/	/	/	/	/
60(5300 MHz)	17.41	/	/	/	/	/	/	/
64(5320 MHz)	17.58	/	/	/	/	/	/	/
Tune up	19.00	18.50	18.00	17.50	17.00	16.50	16.00	15.50
100(5500 MHz)	18.44	/	/	/	/	/	/	/
104(5520 MHz)	18.12	/	/	/	/	/	/	/
108(5540 MHz)	17.81	/	/	/	/	/	/	/
112(5560 MHz)	17.63	/	/	/	/	/	/	/
116(5580 MHz)	17.83	/	/	/	/	/	/	/
120(5600 MHz)	17.67	/	/	/	/	/	/	/
124(5620 MHz)	18.31	/	/	/	/	/	/	/
128(5640 MHz)	18.63	18.12	17.63	17.26	16.50	16.15	15.63	15.07
132(5660 MHz)	18.47	/	/	/	/	/	/	/
136(5680 MHz)	17.84	/	/	/	/	/	/	/
140(5700 MHz)	16.51	/	/	/	/	/	/	/
144(5720 MHz)	17.80	/	/	/	/	/	/	/
Tune up	19.00	18.50	18.00	17.50	17.00	16.50	16.00	15.50
149(5745 MHz)	18.58	/	/	/	/	/	/	/
153(5765 MHz)	18.87	18.40	17.85	17.46	16.72	16.35	15.79	15.31
157(5785 MHz)	18.59	/	/	/	/	/	/	/
161(5805 MHz)	18.22	/	/	/	/	/	/	/
165(5825 MHz)	17.92	/	/	/	/	/	/	/
Tune up	19.00	18.50	18.00	17.50	17.00	16.50	16.00	15.50

Note: The tune up of CH140(5700 MHz) is 18dBm.

802.11n(dBm)-20MHz								
Channel\data rate	MCS0	MCS1	MCS2	MCS3	MCS4	MCS5	MCS6	MCS7
36(5180 MHz)	17.25	/	/	/	/	/	/	/
40(5200 MHz)	17.36	16.70	16.62	16.58	16.69	16.28	15.61	15.08
44(5220 MHz)	17.18	/	/	/	/	/	/	/
48(5240 MHz)	16.68	/	/	/	/	/	/	/
52(5260 MHz)	16.22	/	/	/	/	/	/	/
56(5280 MHz)	16.24	/	/	/	/	/	/	/
60(5300 MHz)	16.49	/	/	/	/	/	/	/
64(5320 MHz)	16.90	16.38	15.94	15.91	16.09	15.68	15.28	14.80
Tune up	18.00	17.50	17.00	17.00	17.00	16.50	16.00	15.50
100(5500 MHz)	16.47	/	/	/	/	/	/	/
104(5520 MHz)	16.20	/	/	/	/	/	/	/
108(5540 MHz)	16.00	/	/	/	/	/	/	/
112(5560 MHz)	16.01	/	/	/	/	/	/	/
116(5580 MHz)	16.05	/	/	/	/	/	/	/
120(5600 MHz)	16.67	/	/	/	/	/	/	/
124(5620 MHz)	17.23	/	/	/	/	/	/	/
128(5640 MHz)	17.59	17.14	16.65	16.62	16.69	16.27	15.74	15.20
132(5660 MHz)	17.44	/	/	/	/	/	/	/
136(5680 MHz)	16.85	/	/	/	/	/	/	/
140(5700 MHz)	14.05	/	/	/	/	/	/	/
144(5720 MHz)	16.47	/	/	/	/	/	/	/
Tune up	18.00	17.50	17.00	17.00	17.00	16.50	16.00	15.50
149(5745 MHz)	15.62	/	/	/	/	/	/	/
153(5765 MHz)	16.02	15.86	15.96	15.99	15.49	15.50	15.55	15.46
157(5785 MHz)	15.68	/	/	/	/	/	/	/
161(5805 MHz)	15.36	/	/	/	/	/	/	/
165(5825 MHz)	14.98	/	/	/	/	/	/	/
Tune up	18.00	17.50	17.00	17.00	17.00	16.50	16.00	15.50

Note: The tune up of CH140(5700 MHz) is 16dBm.

802.11n(dBm)-40MHz								
Channel\data rate	MCS0	MCS1	MCS2	MCS3	MCS4	MCS5	MCS6	MCS7
38(5190 MHz)	16.95	16.49	16.26	15.45	15.04	13.54	14.36	13.50
46(5230 MHz)	16.48	/	/	/	/	/	/	/
54(5270 MHz)	15.82	/	/	/	/	/	/	/
62(5310 MHz)	16.45	16.14	15.51	14.92	14.24	13.92	13.85	13.32
Tune up	17.00	16.50	16.00	15.50	15.50	15.00	15.00	14.50
102(5510 MHz)	15.96	/	/	/	/	/	/	/
110(5550 MHz)	15.36	/	/	/	/	/	/	/
118(5590 MHz)	15.65	/	/	/	/	/	/	/
126(5630 MHz)	16.98	16.41	15.94	15.36	14.94	14.19	14.24	13.64
134(5670 MHz)	16.63	/	/	/	/	/	/	/
142(5710 MHz)	15.22	/	/	/	/	/	/	/
Tune up	17.00	16.50	16.00	15.50	15.50	15.00	15.00	14.50
151(5755 MHz)	15.30	15.20	15.23	15.14	14.31	14.30	14.22	14.21
159(5795 MHz)	15.17	/	/	/	/	/	/	/
Tune up	17.00	16.50	16.00	15.50	15.50	15.00	15.00	14.50

802.11ac(dBm)-20MHz									
Channel\data rate	MCS0	MCS1	MCS2	MCS3	MCS4	MCS5	MCS6	MCS7	MCS8
36(5180 MHz)	17.29	/	/	/	/	/	/	/	/
40(5200 MHz)	17.39	16.74	16.63	16.62	16.34	15.60	15.64	15.11	14.59
44(5220 MHz)	17.23	/	/	/	/	/	/	/	/
48(5240 MHz)	16.70	/	/	/	/	/	/	/	/
52(5260 MHz)	16.23	/	/	/	/	/	/	/	/
56(5280 MHz)	16.31	/	/	/	/	/	/	/	/
60(5300 MHz)	16.53	/	/	/	/	/	/	/	/
64(5320 MHz)	16.91	16.41	16.02	15.97	15.66	15.23	15.28	14.73	13.98
Tune up	18.00	17.50	17.00	17.00	16.50	16.00	16.00	15.50	15.00
100(5500 MHz)	16.50	/	/	/	/	/	/	/	/
104(5520 MHz)	16.22	/	/	/	/	/	/	/	/
108(5540 MHz)	16.00	/	/	/	/	/	/	/	/
112(5560 MHz)	16.01	/	/	/	/	/	/	/	/
116(5580 MHz)	16.03	/	/	/	/	/	/	/	/
120(5600 MHz)	16.58	/	/	/	/	/	/	/	/
124(5620 MHz)	17.17	/	/	/	/	/	/	/	/
128(5640 MHz)	17.57	17.04	16.71	16.64	16.23	15.69	15.69	15.21	14.75
132(5660 MHz)	17.39	/	/	/	/	/	/	/	/
136(5680 MHz)	16.84	/	/	/	/	/	/	/	/
140(5700 MHz)	14.08	/	/	/	/	/	/	/	/
144(5720 MHz)	16.46	/	/	/	/	/	/	/	/
Tune up	18.00	17.50	17.00	17.00	16.50	16.00	16.00	15.50	15.00
149(5745 MHz)	15.67	/	/	/	/	/	/	/	/
153(5765 MHz)	16.02	15.88	16.00	16.01	15.51	15.48	15.55	15.10	14.54
157(5785 MHz)	15.69	/	/	/	/	/	/	/	/
161(5805 MHz)	15.39	/	/	/	/	/	/	/	/
165(5825 MHz)	14.99	/	/	/	/	/	/	/	/
Tune up	18.00	17.50	17.00	17.00	16.50	16.00	16.00	15.50	15.00

Note: The tune up of CH140(5700 MHz) is 16dBm.



802.11ac(dBm)-40MHz										
Channel\data rate	MCS0	MCS1	MCS2	MCS3	MCS4	MCS5	MCS6	MCS7	MCS8	MCS9
38(5190 MHz)	17.40	16.98	16.45	15.97	15.06	14.41	13.61	13.48	13.52	12.94
46(5230 MHz)	16.97	/	/	/	/	/	/	/	/	/
54(5270 MHz)	16.34	/	/	/	/	/	/	/	/	/
62(5310 MHz)	16.82	16.56	16.05	15.39	14.25	13.93	13.31	12.76	12.79	12.35
Tune up	17.50	17.00	16.50	16.00	15.50	15.00	14.50	14.00	14.00	13.50
102(5510 MHz)	16.53	/	/	/	/	/	/	/	/	/
110(5550 MHz)	15.84	/	/	/	/	/	/	/	/	/
118(5590 MHz)	16.23	/	/	/	/	/	/	/	/	/
126(5630 MHz)	17.41	16.99	16.48	15.76	14.88	14.23	13.71	13.28	13.36	12.78
134(5670 MHz)	17.21	/	/	/	/	/	/	/	/	/
142(5710 MHz)	15.85	/	/	/	/	/	/	/	/	/
Tune up	17.50	17.00	16.50	16.00	15.50	15.00	14.50	14.00	14.00	13.50
151(5755 MHz)	15.27	15.22	15.23	15.16	14.33	14.29	13.76	13.15	13.18	12.74
159(5795 MHz)	15.19	/	/	/	/	/	/	/	/	/
Tune up	17.50	17.00	16.50	16.00	15.50	15.00	14.50	14.00	14.00	13.50
802.11ac(dBm)-80MHz										
Channel\data rate	MCS0	MCS1	MCS2	MCS3	MCS4	MCS5	MCS6	MCS7	MCS8	MCS9
42(5210 MHz)	15.71	15.79	15.64	15.15	14.01	13.40	13.09	12.52	12.04	11.39
58(5290 MHz)	15.59	15.69	14.93	14.39	13.40	12.76	12.39	11.87	11.36	10.91
Tune up	16.50	16.50	16.00	15.50	15.00	14.50	14.00	13.50	13.00	12.50
106(5530 MHz)	14.26	14.35	/	/	/	/	/	/	/	/
122(5610 MHz)	15.60	15.70	15.26	14.65	13.70	13.16	12.75	12.28	11.55	11.04
138(5690 MHz)	14.87	15.00	/	/	/	/	/	/	/	/
Tune up	16.00	16.00	16.00	15.50	15.00	14.50	14.00	13.50	13.00	12.50
155(5775 MHz)	15.55	15.65	14.47	14.18	13.98	12.98	13.01	12.54	11.84	11.30
Tune up	16.50	16.50	16	15.5	15	14.5	14	13.5	13	12.5



WiFi 5G- Low power

802.11a(dBm)								
Channel\data rate	6Mbps	9Mbps	12Mbps	18Mbps	24Mbps	36Mbps	48Mbps	54Mbps
36(5180 MHz)	6.22	/	/	/	/	6.41	/	/
40(5200 MHz)	6.46	/	/	/	/	6.55	/	/
44(5220 MHz)	6.78	/	/	/	/	6.79	/	/
48(5240 MHz)	7.17	7.16	7.19	7.14	7.13	7.21	7.19	7.20
52(5260 MHz)	7.16	7.15	7.17	7.09	7.07	7.13	7.14	7.11
56(5280 MHz)	7.13	/	7.16	/	/	/	/	/
60(5300 MHz)	6.63	/	6.68	/	/	/	/	/
64(5320 MHz)	6.02	/	6.05	/	/	/	/	/
100(5500 MHz)	5.11	/	/	/	/	5.08	/	/
104(5520 MHz)	5.22	/	/	/	/	5.24	/	/
108(5540 MHz)	5.57	/	/	/	/	5.52	/	/
112(5560 MHz)	6.08	/	/	/	/	6.06	/	/
116(5580 MHz)	6.80	/	/	/	/	6.81	/	/
120(5600 MHz)	6.98	6.93	6.95	6.90	6.92	7.03	6.99	6.98
124(5620 MHz)	6.72	/	/	/	/	6.83	/	/
128(5640 MHz)	6.26	/	/	/	/	6.32	/	/
132(5660 MHz)	5.98	/	/	/	/	6.11	/	/
136(5680 MHz)	5.85	/	/	/	/	5.84	/	/
140(5700 MHz)	6.10	/	/	/	/	6.14	/	/
144(5720 MHz)	6.33	/	/	/	/	6.30	/	/
149(5745 MHz)	6.92	/	/	/	/	7.02	/	/
153(5765 MHz)	7.24	7.24	7.25	7.26	7.25	7.27	7.26	7.24
157(5785 MHz)	7.10	/	/	/	/	7.16	/	/
161(5805 MHz)	6.76	/	/	/	/	6.82	/	/
165(5825 MHz)	6.71	/	/	/	/	6.79	/	/
Tune up	7.50	7.50	7.50	7.50	7.50	7.50	7.50	7.50

802.11n(dBm)-20MHz								
Channel\data rate	MCS0	MCS1	MCS2	MCS3	MCS4	MCS5	MCS6	MCS7
36(5180 MHz)	6.24	/	/	/	6.38	/	/	/
40(5200 MHz)	6.48	/	/	/	6.60	/	/	/
44(5220 MHz)	6.79	/	/	/	6.80	/	/	/
48(5240 MHz)	7.19	7.00	7.17	7.15	7.26	7.24	7.25	7.18
52(5260 MHz)	7.17	/	/	/	7.20	/	/	/
56(5280 MHz)	7.19	6.95	7.10	7.09	7.22	7.16	7.20	7.13
60(5300 MHz)	6.68	/	/	/	6.92	/	/	/
64(5320 MHz)	6.05	/	/	/	6.16	/	/	/
100(5500 MHz)	5.03	/	/	/	5.17	/	/	/
104(5520 MHz)	5.11	/	/	/	5.33	/	/	/
108(5540 MHz)	5.47	/	/	/	5.54	/	/	/
112(5560 MHz)	5.97	/	/	/	6.06	/	/	/
116(5580 MHz)	6.74	/	/	/	6.83	/	/	/
120(5600 MHz)	6.86	6.73	6.95	6.94	7.04	7.02	7.03	6.98
124(5620 MHz)	6.62	/	/	/	6.85	/	/	/
128(5640 MHz)	6.25	/	/	/	6.34	/	/	/
132(5660 MHz)	5.93	/	/	/	6.06	/	/	/
136(5680 MHz)	5.78	/	/	/	5.85	/	/	/
140(5700 MHz)	6.06	/	/	/	6.15	/	/	/
144(5720 MHz)	6.25	/	/	/	6.30	/	/	/
149(5745 MHz)	6.87	/	/	/	7.00	/	/	/
153(5765 MHz)	7.20	7.03	7.27	7.23	7.36	7.32	7.34	7.25
157(5785 MHz)	7.09	/	/	/	7.20	/	/	/
161(5805 MHz)	6.72	/	/	/	6.84	/	/	/
165(5825 MHz)	6.68	/	/	/	6.81	/	/	/
Tune up	7.50	7.50	7.50	7.50	7.50	7.50	7.50	7.50



802.11n(dBm)-40MHz								
Channel\data rate	MCS0	MCS1	MCS2	MCS3	MCS4	MCS5	MCS6	MCS7
38(5190 MHz)	6.34	/	/	/	/	/	/	/
46(5230 MHz)	6.89	6.88	6.85	6.79	6.85	6.81	6.80	6.74
54(5270 MHz)	7.06	7.04	7.03	7.00	7.08	7.05	7.06	6.95
62(5310 MHz)	6.51	/	/	/	/	/	/	/
102(5510 MHz)	5.61	/	/	/	/	/	/	/
110(5550 MHz)	6.33	/	/	/	/	/	/	/
118(5590 MHz)	7.21	7.17	7.13	7.09	6.36	6.28	6.21	6.17
126(5630 MHz)	6.29	/	/	/	/	/	/	/
134(5670 MHz)	6.37	/	/	/	/	/	/	/
142(5710 MHz)	6.73	/	/	/	/	/	/	/
151(5755 MHz)	7.47	7.45	7.45	7.46	6.66	6.59	6.51	6.48
159(5795 MHz)	7.39	/	/	/	/	/	/	/
Tune up	7.50	7.50	7.50	7.50	7.50	7.50	7.50	7.50

802.11ac(dBm)-40MHz										
Channel\data rate	MCS0	MCS1	MCS2	MCS3	MCS4	MCS5	MCS6	MCS7	MCS8	MCS9
38(5190 MHz)	6.35	/	/	/	/	/	/	/	/	/
46(5230 MHz)	6.89	6.87	6.85	6.81	6.61	6.52	6.48	6.41	6.34	6.25
54(5270 MHz)	7.04	7.03	7.01	7.00	6.82	6.72	6.66	6.61	6.51	6.47
62(5310 MHz)	6.45	/	/	/	/	/	/	/	/	/
102(5510 MHz)	5.57	/	/	/	/	/	/	/	/	/
110(5550 MHz)	6.29	/	/	/	/	/	/	/	/	/
118(5590 MHz)	7.19	7.14	7.11	7.13	6.37	6.28	6.23	6.19	6.07	6.01
126(5630 MHz)	6.91	/	/	/	/	/	/	/	/	/
134(5670 MHz)	6.33	/	/	/	/	/	/	/	/	/
142(5710 MHz)	6.69	/	/	/	/	/	/	/	/	/
151(5755 MHz)	7.50	7.45	7.49	7.48	6.66	6.56	6.52	6.46	6.36	6.33
159(5795 MHz)	7.38	/	/	/	/	/	/	/	/	/
Tune up	7.50	7.50	7.50	7.50	7.50	7.50	7.50	7.50	7.50	7.50
802.11ac(dBm)-80MHz										
Channel\data rate	MCS0	MCS1	MCS2	MCS3	MCS4	MCS5	MCS6	MCS7	MCS8	MCS9
42(5210 MHz)	7.06	6.90	6.78	6.69	6.07	5.90	5.78	5.67	5.54	5.45
58(5290 MHz)	7.21	7.10	7.03	6.90	6.14	5.96	5.85	5.79	5.68	5.62
106(5530 MHz)	5.78	/	/	/	/	/	/	/	/	/
122(5610 MHz)	7.06	7.01	6.92	6.82	6.11	5.89	5.81	5.73	5.56	5.48
138(5730 MHz)	6.84	/	/	/	/	/	/	/	/	/
155(5775 MHz)	7.32	7.28	7.17	7.09	6.23	6.00	5.91	5.85	5.89	5.78
Tune up	7.50	7.50	7.50	7.50	7.50	7.50	7.50	7.50	7.50	7.50



12 Simultaneous TX SAR Considerations

12.1 Introduction

The following procedures adopted from “FCC SAR Considerations for Cell Phones with Multiple Transmitters” are applicable to handsets with built-in unlicensed transmitters such as 802.11 a/b/g and Bluetooth devices which may simultaneously transmit with the licensed transmitter.

For this device, the BT and Wi-Fi can transmit simultaneous with other transmitters.

12.2 Transmit Antenna Separation Distances

Please refer to the picture of antenna locations in the document: “The Photos of SAR test - I20Z70165”

12.3 Standalone SAR Test Exclusion Considerations

Standalone 1-g head or body SAR evaluation by measurement or numerical simulation is not required when the corresponding SAR Exclusion Threshold condition, listed below, is satisfied. The 1-g SAR test exclusion threshold for 100 MHz to 6 GHz at test separation distances ≤ 50 mm are determined by:

$[(\text{max. power of channel, including tune-up tolerance, mW}) / (\text{min. test separation distance, mm})] \cdot [\sqrt{f(\text{GHz})}] \leq 3.0$ for 1-g SAR, where

- $f(\text{GHz})$ is the RF channel transmit frequency in GHz
- Power and distance are rounded to the nearest mW and mm before calculation
- The result is rounded to one decimal place for comparison

Table 12.1: Standalone SAR test exclusion considerations

Band/Mode	F(GHz)	Position	SAR test exclusion threshold(mW)	RF output power		SAR test exclusion
				dBm	mW	
Bluetooth	2.441	Body	9.60	8.5	7.08	YES
2.4GHz WLAN	2.45	Body	9.58	19.5	89.13	NO
5GHz WLAN	5.2	Body	6.58	19	79.43	NO
	5.3	Body	6.52	19	79.43	NO
	5.6	Body	6.34	19	79.43	NO
	5.8	Body	6.23	19	79.43	NO

13 Evaluation of Simultaneous

Table 13.1: The sum of reported SAR values for main antenna and WiFi2.4G

	Position	Main antenna	WiFi	Sum
Highest reported SAR value for Body	Top 19mm (LTE Band2)	1.02	0.46	1.48

Table 13.2: The sum of reported SAR values for main antenna and WiFi5G

	Position	Main antenna	WiFi	Sum
Highest reported SAR value for Body	Top 19mm (LTE Band2)	1.02	0.51	1.53

Table 13.3: The sum of reported SAR values for main antenna and BT

	Position	Main antenna	BT	Sum
Maximum reported SAR value for Body	Top 19mm (LTE Band2)	1.02	0.10 ^[1]	1.12

[1] - Estimated SAR for Bluetooth (see the table 13.4)

Table 13.4: Estimated SAR for Bluetooth

Mode/Band	F (GHz)	Position	Distance (mm)	Upper limit of power *		Estimated _{1g} (W/kg)
				dBm	mW	
Bluetooth	2.441	Body	19	9.7	9.33	0.10

* - Maximum possible output power declared by manufacturer

When standalone SAR test exclusion applies to an antenna that transmits simultaneously with other antennas, the standalone SAR must be estimated according to following to determine simultaneous transmission SAR test exclusion:

(max. power of channel, including tune-up tolerance, mW)/(min. test separation distance,mm)]·[√f(GHz)/x] W/kg for test separation distances ≤ 50 mm;
where x = 7.5 for 1-g SAR.

When the minimum test separation distance is < 5 mm, a distance of 5 mm is applied to determine SAR test exclusion

Conclusion:

According to the above tables, the sum of reported SAR values is < 1.6W/kg. So the simultaneous transmission SAR with volume scans is not required.

14 SAR Test Result

It is determined by user manual for the distance between the EUT and the phantom bottom. The distance are 0mm, 9mm, 10mm, 12mm and 14mm, and just applied to the condition of body worn accessory.

It is performed for all SAR measurements with area scan based 1-g SAR estimation (Fast SAR). A zoom scan measurement is added when the estimated 1-g SAR is the highest measured SAR in each exposure configuration, wireless mode and frequency band combination or more than 1.2W/kg.

The calculated SAR is obtained by the following formula:

$$\text{Reported SAR} = \text{Measured SAR} \times 10^{(P_{\text{Target}} - P_{\text{Measured}})/10}$$

Where P_{Target} is the power of manufacturing upper limit;

P_{Measured} is the measured power in chapter 11.

Mode	Duty Cycle
GPRS&EGPRS for GSM850/1900 with normal power	1:4
GPRS&EGPRS for GSM850 with low power	1:8.3
GPRS&EGPRS for 1900 with low power	1:2.67
WCDMA<E FDD	1:1
LTE TDD	1:1.58

14.1 SAR results

Table 14.1-1: SAR Values (GSM 850 MHz Band - Body)

Ambient Temperature: 22.9°C Liquid Temperature: 22.5°C											
Frequency		Mode (number of timeslots)	Test Position	Figure No.	Conduct ed Power (dBm)	Max. tune- up Power (dBm)	Measured SAR(10g) (W/kg)	Reported SAR(10g) (W/kg)	Measure d SAR(1g) (W/kg)	Reporte d SAR(1g) (W/kg)	Power Drift (dB)
Ch.	MHz										
190	836.6	GPRS (2)	Rear	Note1	31.95	32.5	0.222	0.25	0.267	0.30	-0.02
190	836.6	GPRS (2)	Right	Note2	31.95	32.5	0.33	0.37	0.483	0.55	0.14
251	848.8	GPRS (2)	Right	Note2	32.07	32.5	0.297	0.33	0.413	0.46	0.07
128	824.2	GPRS (2)	Right	Note2	32.38	32.5	0.321	0.33	0.415	0.43	0.11
190	836.6	GPRS (2)	Top	Note1	31.95	32.5	0.121	0.14	0.162	0.18	-0.02
190	836.6	EGPRS (2)	Right	Note2	31.9	32.5	0.318	0.37	0.475	0.55	-0.14
251	848.8	GPRS (1)	Rear	Fig.1	26.84	27	0.247	0.26	0.557	0.58	0.02
190	836.6	GPRS (1)	Right	/	26.69	27	0.228	0.24	0.444	0.48	-0.1
128	824.2	GPRS (1)	Right	/	26.68	27	0.238	0.26	0.497	0.54	0.02
190	836.6	GPRS (1)	Right	/	26.69	27	0.102	0.11	0.181	0.19	-0.14
190	836.6	GPRS (1)	Rear	/	26.69	27	0.124	0.13	0.266	0.29	-0.06
251	848.8	EGPRS (1)	Right	/	26.7	27	0.206	0.22	0.427	0.46	0.08

Note: The distance between the EUT and the phantom bottom is 0mm.

Note1: The distance between the EUT and the phantom bottom is 19mm.

Note2: The distance between the EUT and the phantom bottom is 13mm.

Table 14.1-2: SAR Values (GSM 1900 MHz Band - Body)

Frequency		Mode (number of timeslots)	Test Position	Figure No.	Conduct ed Power (dBm)	Max. tune- up Power (dBm)	Measure d SAR(10g) (W/kg)	Reported SAR(10g) (W/kg)	Measure d SAR(1g) (W/kg)	Reporte d SAR(1g) (W/kg)	Power Drift (dB)
Ch.	MHz										
Ambient Temperature: 22.9°C Liquid Temperature: 22.5°C											
661	1880	GPRS (2)	Rear	Note1	29.11	29.5	0.115	0.13	0.177	0.19	-0.04
661	1880	GPRS (2)	Right	Note2	29.11	29.5	0.235	0.26	0.412	0.45	0.08
810	1909.8	GPRS (2)	Right	Note2	29.44	29.5	0.224	0.23	0.344	0.35	-0.03
512	1850.2	GPRS (2)	Right	Note2	29.2	29.5	0.28	0.30	0.48	0.51	0.06
661	1880	GPRS (2)	Top	Note1	29.11	29.5	0.202	0.22	0.322	0.35	0.13
512	1850.2	EGPRS (2)	Right	Note2	29.19	29.5	0.172	0.18	0.244	0.26	0.08
810	1909.8	GPRS (3)	Rear	Fig.2	17.21	17.8	0.246	0.28	0.575	0.66	0
661	1880	GPRS (3)	Right	/	17.03	17.8	0.233	0.28	0.544	0.65	-0.12
512	1850.2	GPRS (3)	Right	/	17.19	17.8	0.229	0.26	0.551	0.63	0.06
661	1880	GPRS (3)	Right	/	17.19	17.8	0.161	0.19	0.368	0.42	-0.08
661	1880	GPRS (3)	Rear	/	17.19	17.8	0.108	0.12	0.235	0.27	0.12
810	1909.8	EGPRS (3)	Right	/	17.16	17.8	0.205	0.24	0.501	0.58	0.11

Note: The distance between the EUT and the phantom bottom is 0mm.

Note1: The distance between the EUT and the phantom bottom is 19mm.

Note2: The distance between the EUT and the phantom bottom is 13mm.

Table 14.1-3: SAR Values (WCDMA 1900 MHz Band - Body)

Frequency		Test Position	Figure No.	Conducted Power (dBm)	Max. tune-up Power (dBm)	Measured SAR(10g) (W/kg)	Reported SAR(10g)(W/kg)	Measured SAR(1g) (W/kg)	Reported SAR(1g) (W/kg)	Power Drift (dB)
Ch.	MHz									
Ambient Temperature: 22.9°C Liquid Temperature: 22.5°C										
9400	1880	Rear	Note1	23.66	24.5	0.162	0.20	0.209	0.25	-0.08
9262	1852.4	Right	Note2/Fig.3	23.7	24.5	0.362	0.44	0.607	0.73	-0.04
9538	1907.6	Right	Note2	23.87	24.5	0.338	0.39	0.478	0.55	0.05
9400	1880	Right	Note2	23.66	24.5	0.286	0.35	0.482	0.58	0.07
9400	1880	Top	Note1	23.66	24.5	0.219	0.27	0.333	0.40	-0.11
9538	1907.6	Rear	/	12.38	12.7	0.263	0.28	0.61	0.66	-0.06
9400	1880	Rear	/	12.37	12.7	0.274	0.30	0.627	0.68	-0.01
9262	1852.4	Rear	/	12.5	12.7	0.291	0.30	0.673	0.70	0
9400	1880	Right	/	12.37	12.7	0.146	0.16	0.317	0.34	0.08
9400	1880	Top	/	12.37	12.7	0.121	0.13	0.269	0.29	-0.06

Note: The distance between the EUT and the phantom bottom is 0mm.

Note1: The distance between the EUT and the phantom bottom is 19mm.

Note2: The distance between the EUT and the phantom bottom is 13mm.

Table 14.1-4: SAR Values (WCDMA 1700 MHz Band - Body)

Frequency		Test Position	Figure No.	Conducted Power (dBm)	Max. tune-up Power (dBm)	Measured SAR(10g) (W/kg)	Reported SAR(10g)(W/kg)	Measured SAR(1g) (W/kg)	Reported SAR(1g) (W/kg)	Power Drift (dB)
Ch.	MHz									
Ambient Temperature: 22.9°C Liquid Temperature: 22.5°C										
1412	1732.5	Rear	Note1	23.75	24.5	0.403	0.48	0.646	0.77	-0.05
1513	1752.6	Rear	Note1	23.68	24.5	0.393	0.47	0.622	0.75	0.08
1312	1712.4	Rear	Note1	23.71	24.5	0.36	0.43	0.574	0.69	-0.14
1412	1732.5	Right	Note2	23.75	24.5	0.273	0.32	0.563	0.67	0.14
1412	1732.5	Top	Note1	23.75	24.5	0.264	0.31	0.427	0.51	0.02
1513	1752.6	Rear		13.21	13.3	0.314	0.32	0.732	0.75	-0.1
1412	1732.5	Rear	/	13.14	13.3	0.312	0.32	0.731	0.76	0.08
1312	1712.4	Rear	Fig.4	13.25	13.3	0.329	0.33	0.76	0.77	0
1412	1732.5	Right	/	13.14	13.3	0.17	0.18	0.386	0.40	-0.14
1412	1732.5	Top	/	13.14	13.3	0.13	0.13	0.3	0.31	0.06

Note: The distance between the EUT and the phantom bottom is 0mm.

Note1: The distance between the EUT and the phantom bottom is 19mm.

Note2: The distance between the EUT and the phantom bottom is 13mm.

Table 14.1-5: SAR Values (WCDMA 850 MHz Band - Body)

Frequency		Test Position	Figure No.	Conducted Power (dBm)	Max. tune-up Power (dBm)	Measured SAR(10g) (W/kg)	Reported SAR(10g)(W/kg)	Measured SAR(1g) (W/kg)	Reported SAR(1g) (W/kg)	Power Drift (dB)
Ch.	MHz									
Ambient Temperature: 22.9°C Liquid Temperature: 22.5°C										
4183	836.6	Rear	Note1	23.03	24	0.166	0.21	0.189	0.24	-0.02
4233	846.6	Right	Note2	22.99	24	0.155	0.20	0.19	0.24	-0.14
4132	826.4	Right	Note2	22.92	24	0.148	0.19	0.195	0.25	0.08
4183	836.6	Right	Note2	23.03	24	0.171	0.21	0.207	0.26	-0.05
4183	836.6	Top	Note1	23.03	24	0.081	0.10	0.098	0.12	0.02
4233	846.6	Rear	/	17.11	18	0.2	0.25	0.471	0.58	-0.09
4183	836.6	Rear	/	17.17	18	0.211	0.26	0.491	0.59	0.13
4132	826.4	Rear	Fig.5	17.14	18	0.236	0.29	0.573	0.70	0.02
4183	836.6	Right	/	17.17	18	0.099	0.12	0.202	0.24	-0.11
4183	836.6	Top	/	17.17	18	0.163	0.20	0.356	0.43	-0.03

Note: The distance between the EUT and the phantom bottom is 0mm.

Note1: The distance between the EUT and the phantom bottom is 19mm.

Note2: The distance between the EUT and the phantom bottom is 13mm.

Table 14.1-6: SAR Values (LTE Band2 - Body)

Frequency		Mode	Test Position	Figure No.	Conducted Power (dBm)	Max. tune-up Power (dBm)	Measured SAR(10g) (W/kg)	Reported SAR(10g) (W/kg)	Measured SAR(1g) (W/kg)	Reported SAR(1g) (W/kg)	Power Drift (dB)
Ch.	MHz										
Ambient Temperature: 22.9°C Liquid Temperature: 22.5°C											
18700	1860	1RB-Mid	Rear	Note1	24.13	24.5	0.321	0.35	0.552	0.60	0.05
18700	1860	1RB-Mid	Right	Note2	24.13	24.5	0.433	0.47	0.742	0.81	-0.01
18900	1880	1RB-Low	Top	Note1	23.88	24.5	0.456	0.53	0.767	0.88	0.08
18700	1860	1RB-Mid	Top	Note1	24.13	24.5	0.505	0.55	0.917	1.00	0.08
19100	1900	1RB-Low	Top	Note1	23.77	24.5	0.454	0.54	0.735	0.87	-0.07
19100	1900	50RB-Mid	Rear	Note1	22.68	23.5	0.27	0.33	0.478	0.58	0.01
19100	1900	50RB-Mid	Right	Note2	22.68	23.5	0.405	0.49	0.705	0.85	0.14
19100	1900	50RB-Mid	Top	Note1/ Fig.6	22.68	23.5	0.467	0.56	0.841	1.02	0.01
18900	1880	50RB-Low	Top	Note1	22.62	23.5	0.475	0.58	0.812	0.99	-0.07
18700	1860	50RB-Mid	Top	Note1	22.6	23.5	0.416	0.51	0.755	0.93	-0.01
18700	1860	100RB	Top	Note1	22.5	23.5	0.458	0.58	0.801	1.01	0.03
19100	1900	100RB	Top	Note1	22.58	23.5	0.459	0.57	0.812	1.00	-0.08
18700	1860	1RB-Mid	Rear	/	12.32	12.7	0.282	0.31	0.63	0.69	-0.02
18700	1860	1RB-Low	Right	/	12.32	12.7	0.219	0.24	0.489	0.53	-0.08
18700	1860	1RB-Low	Top	/	12.32	12.7	0.118	0.13	0.293	0.32	-0.05
19100	1900	50RB-Mid	Rear	/	12.36	12.7	0.275	0.30	0.647	0.70	0.17
18700	1860	50RB-Mid	Rear	/	12.41	12.7	0.288	0.31	0.662	0.71	0.01
18900	1880	50RB-Low	Rear	/	12.35	12.7	0.279	0.30	0.647	0.70	0.12
18700	1860	50RB-Mid	Right	/	12.41	12.7	0.232	0.25	0.568	0.61	0.14
18700	1860	50RB-Mid	Top	/	12.41	12.7	0.141	0.15	0.295	0.32	-0.08

Note: The distance between the EUT and the phantom bottom is 0mm.

Note1: The distance between the EUT and the phantom bottom is 19mm.

Note2: The distance between the EUT and the phantom bottom is 13mm

Note3: The LTE mode is QPSK_20MHz.

Table 14.1-7: SAR Values (LTE Band5 - Body)

Frequency		Mode	Test Position	Figure No.	Conducte d Power (dBm)	Max. tune-up Power (dBm)	Measure d SAR(10g) (W/kg)	Reported SAR(10g)(W/kg)	Measure d SAR(1g) (W/kg)	Reporte d SAR(1g) (W/kg)	Powe r Drift (dB)
Ch.	MHz										
Ambient Temperature: 22.9°C Liquid Temperature: 22.5°C											
20600	844	1RB-High	Rear	Note1	23.7	24.5	0.198	0.24	0.279	0.34	-0.04
20600	844	1RB-High	Right	Note2	23.7	24.5	0.205	0.25	0.321	0.39	0.08
20600	844	1RB-High	Top	Note1	23.7	24.5	0.121	0.15	0.195	0.23	-0.07
20600	844	25RB-High	Rear	Note1	22.49	23.5	0.152	0.19	0.219	0.28	0.1
20600	844	25RB-High	Right	Note2	22.49	23.5	0.166	0.21	0.259	0.33	0.07
20600	844	25RB-High	Top	Note1	22.49	23.5	0.066	0.08	0.193	0.24	-0.09
20450	829	1RB-Low	Rear	/	16.66	17.8	0.112	0.15	0.235	0.31	0.01
20450	829	1RB-Low	Right	/	16.66	17.8	0.118	0.15	0.27	0.35	-0.07
20450	829	1RB-Low	Top	/	16.66	17.8	0.078	0.10	0.188	0.24	0.09
20450	829	1RB-Low	Rear	Fig.7	16.49	17.8	0.201	0.27	0.513	0.69	0.11
20450	829	1RB-Low	Right	/	16.49	17.8	0.111	0.15	0.239	0.32	-0.01
20450	829	25RB-Low	Top	/	16.49	17.8	0.073	0.10	0.16	0.22	0.07

Note: The distance between the EUT and the phantom bottom is 0mm.

Note1: The distance between the EUT and the phantom bottom is 19mm.

Note2: The distance between the EUT and the phantom bottom is 13mm

Note3: The LTE mode is QPSK_10MHz.

Table 14.1-8: SAR Values (LTE Band7 - Body)

Frequency		Mode	Test Position	Figure No.	Conducted Power (dBm)	Max. tune-up Power (dBm)	Measured SAR(10g) (W/kg)	Reported SAR(10g) (W/kg)	Measured SAR(1g) (W/kg)	Reported SAR(1g) (W/kg)	Power Drift (dB)
Ch.	MHz										
Ambient Temperature: 22.9°C Liquid Temperature: 22.5°C											
20850	2510	1RB-Low	Rear	Note1	22.87	23.8	0.186	0.23	0.372	0.46	-0.08
20850	2510	1RB-Low	Right	Note2	22.87	23.8	0.034	0.04	0.063	0.08	0.07
20850	2510	1RB-Low	Top	Note1	22.87	23.8	0.19	0.24	0.398	0.49	-0.14
21100	2535	50RB-Mid	Rear	Note1	21.87	22.8	0.165	0.20	0.323	0.40	0.08
21100	2535	50RB-Mid	Right	Note2	21.87	22.8	0.035	0.04	0.064	0.08	-0.07
21100	2535	50RB-Mid	Top	Note1	21.87	22.8	0.137	0.17	0.275	0.34	0.07
20850	2510	1RB-Low	Rear	Fig.8	10.98	11.7	0.211	0.25	0.601	0.71	0.08
20850	2510	1RB-Low	Right	/	10.98	11.7	0.015	0.02	0.057	0.07	0.16
20850	2510	1RB-Low	Top	/	10.98	11.7	0.053	0.06	0.146	0.17	-0.08
21100	2535	50RB-Mid	Rear	/	10.93	11.7	0.121	0.14	0.409	0.49	0.02
21100	2535	50RB-Mid	Right	/	10.93	11.7	0.017	0.02	0.024	0.03	0.01
21100	2535	50RB-Mid	Top	/	10.93	11.7	0.123	0.15	0.306	0.37	-0.04

Note: The distance between the EUT and the phantom bottom is 0mm.

Note1: The distance between the EUT and the phantom bottom is 19mm.

Note2: The distance between the EUT and the phantom bottom is 13mm

Note3: The LTE mode is QPSK_20MHz.

Table 14.1-9: SAR Values (LTE Band12 - Body)

Frequency		Ambient Temperature: 22.9°C					Liquid Temperature: 22.5°C				
Ch.	MHz	Mode	Test Position	Figure No.	Conducted Power (dBm)	Max. tune-up Power (dBm)	Measured SAR(10g) (W/kg)	Reported SAR(10g) (W/kg)	Measured SAR(1g) (W/kg)	Reported SAR(1g) (W/kg)	Power Drift (dB)
23060	704	1RB-Low	Rear	Note1	24.71	25.7	0.098	0.12	0.151	0.19	0.03
23060	704	1RB-Low	Right	Note2	24.71	25.7	0.09	0.11	0.144	0.18	0.08
23060	704	1RB-Low	Top	Note1	24.71	25.7	0.027	0.03	0.048	0.06	-0.07
23060	704	25RB-Low	Rear	Note1	23.58	24.7	0.082	0.11	0.126	0.16	0.04
23060	704	25RB-Low	Right	Note2	23.58	24.7	0.07	0.09	0.111	0.14	0.08
23060	704	25RB-Low	Top	Note1	23.58	24.7	0.021	0.03	0.037	0.05	-0.03
23060	704	1RB-Low	Rear	Fig.9	16.71	17.1	0.27	0.30	0.644	0.70	-0.01
23060	704	1RB-Low	Right	/	16.71	17.1	0.065	0.07	0.157	0.17	-0.05
23060	704	1RB-Low	Top	/	16.71	17.1	0.151	0.17	0.441	0.48	0.12
23060	704	25RB-Low	Rear	/	16.53	17.1	0.256	0.29	0.609	0.69	-0.06
23060	704	25RB-Low	Right	/	16.53	17.1	0.061	0.07	0.148	0.17	0.08
23060	704	25RB-Low	Top	/	16.53	17.1	0.132	0.15	0.345	0.39	-0.07

Note: The distance between the EUT and the phantom bottom is 0mm.

Note1: The distance between the EUT and the phantom bottom is 19mm.

Note2: The distance between the EUT and the phantom bottom is 13mm

Note3: The LTE mode is QPSK_10MHz.

Table 14.1-10: SAR Values (LTE Band18 - Body)

Frequency		Mode	Test Position	Figure No.	Conducte d Power (dBm)	Max. tune-up Power (dBm)	Measure d SAR(10g) (W/kg)	Reported SAR(10g)(W/kg)	Measure d SAR(1g) (W/kg)	Reporte d SAR(1g) (W/kg)	Powe r Drift (dB)
Ch.	MHz										
Ambient Temperature: 22.9°C Liquid Temperature: 22.5°C											
23925	822.5	1RB-Low	Rear	Note1	23.18	24.5	0.143	0.19	0.187	0.25	-0.02
23925	822.5	1RB-Low	Right	Note2	23.18	24.5	0.146	0.20	0.207	0.28	0.07
23925	822.5	1RB-Low	Top	Note1	23.18	24.5	0.056	0.08	0.089	0.12	-0.08
23925	822.5	36RB-Low	Rear	Note1	22.3	23.5	0.121	0.16	0.157	0.21	0.07
23925	822.5	36RB-Low	Right	Note2	22.3	23.5	0.129	0.17	0.182	0.24	-0.12
23925	822.5	36RB-Low	Top	Note1	22.3	23.5	0.05	0.07	0.08	0.11	0.04
23925	822.5	1RB-Low	Rear	/	16.75	17.6	0.247	0.30	0.585	0.71	-0.08
23925	822.5	1RB-Low	Right	/	16.75	17.6	0.131	0.16	0.281	0.34	-0.10
23925	822.5	1RB-Low	Top	/	16.75	17.6	0.099	0.12	0.228	0.28	0.07
23925	822.5	36RB-Low	Rear	Fig.10	17.01	17.6	0.255	0.29	0.616	0.71	0.15
23925	822.5	36RB-Low	Right	/	17.01	17.6	0.131	0.15	0.26	0.30	-0.02
23925	822.5	36RB-Low	Top	/	17.01	17.6	0.093	0.11	0.216	0.25	-0.01

Note: The distance between the EUT and the phantom bottom is 0mm.

Note1: The distance between the EUT and the phantom bottom is 19mm.

Note2: The distance between the EUT and the phantom bottom is 13mm

Note3: The LTE mode is QPSK_15MHz

Table 14.1-11: SAR Values (LTE Band19 - Body)

Frequency		Mode	Test Position	Figure No.	Conducte d Power (dBm)	Max. tune-up Power (dBm)	Measure d SAR(10g) (W/kg)	Reported SAR(10g)(W/kg)	Measure d SAR(1g) (W/kg)	Reporte d SAR(1g) (W/kg)	Powe r Drift (dB)
Ch.	MHz										
Ambient Temperature: 22.9°C Liquid Temperature: 22.5°C											
24075	837.5	1RB-Low	Rear	Note1	23.38	24.5	0.162	0.21	0.23	0.30	0.01
24075	837.5	1RB-Low	Right	Note2	23.38	24.5	0.169	0.22	0.263	0.34	-0.08
24075	837.5	1RB-Low	Top	Note1	23.38	24.5	0.074	0.10	0.115	0.15	0.05
24075	837.5	36RB-High	Rear	Note1	22.35	23.5	0.112	0.15	0.155	0.20	0.03
24075	837.5	36RB-High	Right	Note2	22.35	23.5	0.128	0.17	0.199	0.26	-0.01
24075	837.5	36RB-High	Top	Note1	22.35	23.5	0.061	0.08	0.095	0.12	0.08
24075	837.5	1RB-Low	Rear	Fig.11	17.09	17.2	0.31	0.32	0.727	0.75	0.19
24075	837.5	1RB-Low	Right	/	17.09	17.2	0.136	0.14	0.29	0.30	-0.02
24075	837.5	1RB-Low	Top	/	17.09	17.2	0.12	0.12	0.296	0.30	-0.01
24075	837.5	36RB-Low	Rear	/	16.94	17.2	0.257	0.27	0.683	0.73	0.07
24075	837.5	36RB-Low	Right	/	16.94	17.2	0.127	0.13	0.268	0.28	0.08
24075	837.5	36RB-Low	Top	/	16.94	17.2	0.098	0.10	0.243	0.26	-0.07

Note: The distance between the EUT and the phantom bottom is 0mm.

Note1: The distance between the EUT and the phantom bottom is 19mm.

Note2: The distance between the EUT and the phantom bottom is 13mm

Note3: The LTE mode is QPSK_15MHz

Table 14.1-12: SAR Values (LTE Band28 - Body)

Frequency		Mode	Test Position	Figure No.	Conducte d Power (dBm)	Max. tune-up Power (dBm)	Measure d SAR(10g) (W/kg)	Reported SAR(10g)(W/kg)	Measure d SAR(1g) (W/kg)	Reporte d SAR(1g) (W/kg)	Powe r Drift (dB)
Ch.	MHz										
Ambient Temperature: 22.9°C Liquid Temperature: 22.5°C											
27310	713	1RB-Low	Rear	Note1	24.45	25.7	0.191	0.25	0.294	0.39	-0.08
27310	713	1RB-Low	Right	Note2	24.45	25.7	0.172	0.23	0.279	0.37	-0.03
27310	713	1RB-Low	Top	Note1	24.45	25.7	0.058	0.08	0.102	0.14	0.17
27310	713	50RB-Low	Rear	Note1	23.6	24.7	0.15	0.19	0.234	0.30	0.02
27310	713	50RB-Low	Right	Note2	23.6	24.7	0.143	0.18	0.231	0.30	-0.08
27310	713	50RB-Low	Top	Note1	23.6	24.7	0.047	0.06	0.084	0.11	0.03
27310	713	1RB-Low	Rear	Fig.12	15.8	16.6	0.23	0.28	0.53	0.64	-0.11
27310	713	1RB-Low	Right	/	15.8	16.6	0.068	0.08	0.182	0.22	0.12
27310	713	1RB-Low	Top	/	15.8	16.6	0.111	0.13	0.246	0.30	-0.06
27310	713	50RB-Low	Rear	/	15.62	16.6	0.199	0.25	0.445	0.56	-0.14
27310	713	50RB-Low	Right	/	15.62	16.6	0.06	0.08	0.146	0.18	0.09
27310	713	50RB-Low	Top	/	15.62	16.6	0.109	0.14	0.24	0.30	-0.03

Note: The distance between the EUT and the phantom bottom is 0mm.

Note1: The distance between the EUT and the phantom bottom is 19mm.

Note2: The distance between the EUT and the phantom bottom is 13mm

Note3: The LTE mode is QPSK_20MHz

Table 14.1-13: SAR Values (LTE Band38 - Body)

Frequency		Mode	Test Position	Figure No.	Conducte d Power (dBm)	Max. tune-up Power (dBm)	Measure d SAR(10g) (W/kg)	Reported SAR(10g) (W/kg)	Measure d SAR(1g) (W/kg)	Reporte d SAR(1g) (W/kg)	Powe r Drift (dB)	
Ch.	MHz											
		Ambient Temperature: 22.9°C					Liquid Temperature: 22.5°C					
27310	713	1RB-High	Rear	Note1	24.32	25	0.076	0.09	0.146	0.17	0.09	
27310	713	1RB-High	Right	Note2	24.32	25	0.013	0.02	0.023	0.03	-0.02	
27310	713	1RB-High	Top	Note1	24.32	25	0.063	0.07	0.125	0.15	-0.06	
27310	713	50RB-Mid	Rear	Note1	23.3	24	0.062	0.07	0.115	0.14	0.04	
27310	713	50RB-Mid	Right	Note2	23.3	24	0.009	0.01	0.013	0.02	0.08	
27310	713	50RB-Mid	Top	Note1	23.3	24	0.049	0.06	0.097	0.11	-0.02	
27310	713	1RB-High	Rear	/	12.72	13.1	0.188	0.21	0.513	0.56	-0.06	
27310	713	1RB-High	Right	/	12.72	13.1	0.081	0.09	0.148	0.16	0.08	
27310	713	1RB-High	Top	/	12.72	13.1	0.181	0.20	0.408	0.45	-0.14	
27310	713	50RB-High	Rear	Fig.13	12.52	13.1	0.221	0.25	0.651	0.74	0	
27310	713	50RB-High	Right	/	12.52	13.1	0.081	0.09	0.146	0.17	0.03	
27310	713	50RB-High	Top	/	12.52	13.1	0.172	0.20	0.338	0.39	0.07	

Note: The distance between the EUT and the phantom bottom is 0mm.

Note1: The distance between the EUT and the phantom bottom is 19mm.

Note2: The distance between the EUT and the phantom bottom is 13mm

Note3: The LTE mode is QPSK_20MHz