



No.I21Z70098-SEM01



# SAR TEST REPORT

No. I21Z70098-SEM01

For

**Samsung Electronics Co., Ltd.**

**Tablet PC**

**Modelname: SM-T227U**

With

**Hardware Version: REV1.0**

**Software Version: T227U.001**

**FCC ID: ZCASMT227U**

**Issued Date: 2021-5-17**

**Note:**

The test results in this test report relate only to the devices specified in this report. This report shall not be reproduced except in full without the written approval of CTTL.

The report must not be used by the client to claim product certification, approval, or endorsement by NVLAP, NIST, or any agency of the U.S. Government.

**Test Laboratory:**

CTTL, Telecommunication Technology Labs, CAICT

No. 51, Xueyuan Road, Haidian District, Beijing, P. R. China 100191.

Tel:+86(0)10-62304633-2512, Fax:+86(0)10-62304633-2504

Email: [ctl\\_terminals@caict.ac.cn](mailto:ctl_terminals@caict.ac.cn), website: [www.caict.ac.cn](http://www.caict.ac.cn)

**REPORT HISTORY**

<b>Report Number</b>	<b>Revision</b>	<b>Issue Date</b>	<b>Description</b>
I21Z70098-SEM01	Rev.0	2021-5-7	Initial creation of test report
I21Z70098-SEM01	Rev.1	2021-5-14	Update the information on section 2 of test report. Update the information on section 9.2 of test report. Update the information on section 4.3 of test report.
I21Z70098-SEM01	Rev.2	2021-5-17	Update LTE Band7 and WLAN2450 worst case test results. Update the sum on Table 2.2 and Table 13.1.



## TABLE OF CONTENT

<b>1 TEST LABORATORY .....</b>	<b>5</b>
1.1 TESTING LOCATION .....	5
1.2 TESTING ENVIRONMENT.....	5
1.3 PROJECT DATA .....	5
1.4 SIGNATURE.....	5
<b>2 STATEMENT OF COMPLIANCE .....</b>	<b>6</b>
<b>3 CLIENT INFORMATION .....</b>	<b>8</b>
3.1 APPLICANT INFORMATION.....	8
3.2 MANUFACTURER INFORMATION .....	8
<b>4 EQUIPMENT UNDER TEST (EUT) AND ANCILLARY EQUIPMENT (AE) .....</b>	<b>9</b>
4.1 ABOUT EUT.....	9
4.2 INTERNAL IDENTIFICATION OF EUT USED DURING THE TEST .....	10
4.3 INTERNAL IDENTIFICATION OF AE USED DURING THE TEST .....	10
<b>5 TEST METHODOLOGY .....</b>	<b>11</b>
5.1 APPLICABLE LIMIT REGULATIONS.....	11
5.2 APPLICABLE MEASUREMENT STANDARDS .....	11
<b>6 SPECIFIC ABSORPTION RATE (SAR).....</b>	<b>12</b>
6.1 INTRODUCTION.....	12
6.2 SAR DEFINITION.....	12
<b>7 TISSUE SIMULATING LIQUIDS .....</b>	<b>13</b>
7.1 TARGETS FOR TISSUE SIMULATING LIQUID.....	13
7.2 DIELECTRIC PERFORMANCE .....	14
<b>8 SYSTEM VERIFICATION .....</b>	<b>19</b>
8.1 SYSTEM SETUP.....	19
8.2 SYSTEM VERIFICATION.....	20
<b>9 MEASUREMENT PROCEDURES .....</b>	<b>21</b>
9.1 TESTS TO BE PERFORMED .....	21
9.2 GENERAL MEASUREMENT PROCEDURE.....	22
9.3 WCDMA MEASUREMENT PROCEDURES FOR SAR .....	24
9.4 SAR MEASUREMENT FOR LTE.....	25
9.5 BLUETOOTH & WI-FI MEASUREMENT PROCEDURES FOR SAR .....	27
9.6 POWER DRIFT.....	27
<b>10 AREA SCAN BASED 1-G SAR.....</b>	<b>28</b>
10.1 REQUIREMENT OF KDB.....	28
10.2 FAST SAR ALGORITHMS .....	28
<b>11 CONDUCTED OUTPUT POWER.....</b>	<b>29</b>



11.1 WCDMA MEASUREMENT RESULT ..... 29

11.2 LTE MEASUREMENT RESULT ..... 31

11.3 WI-FI AND BT MEASUREMENT RESULT ..... 103

**12 SIMULTANEOUS TX SAR CONSIDERATIONS ..... 105**

12.1 INTRODUCTION..... 105

12.2 TRANSMIT ANTENNA SEPARATION DISTANCES..... 105

12.3 SAR MEASUREMENT POSITIONS ..... 105

12.4 STANDALONE SAR TEST EXCLUSION CONSIDERATIONS ..... 106

**13 EVALUATION OF SIMULTANEOUS..... 107**

**14 SAR TEST RESULT ..... 108**

14.1 SAR RESULTS FOR FAST SAR ..... 109

14.2 SAR RESULTS FOR STANDARD PROCEDURE ..... 122

14.3 WLAN EVALUATION FOR 2.4G..... 127

14.4 WLAN EVALUATION FOR 5G..... 129

14.5 SAR RESULTS FOR FAST BT ..... 133

**15 SAR MEASUREMENT VARIABILITY..... 134**

**16 MEASUREMENT UNCERTAINTY ..... 135**

16.1 MEASUREMENT UNCERTAINTY FOR NORMAL SAR TESTS (300MHZ~3GHZ)..... 135

16.2 MEASUREMENT UNCERTAINTY FOR NORMAL SAR TESTS (3~6GHZ) ..... 136

16.3 MEASUREMENT UNCERTAINTY FOR FAST SAR TESTS (300MHZ~3GHZ)..... 137

16.4 MEASUREMENT UNCERTAINTY FOR FAST SAR TESTS (3~6GHZ) ..... 138

**17 MAIN TEST INSTRUMENTS..... 140**

**ANNEX A GRAPH RESULTS ..... 141**

**ANNEX B SYSTEM VERIFICATION RESULTS ..... 168**

**ANNEX C SAR MEASUREMENT SETUP ..... 189**

**ANNEX D POSITION OF THE WIRELESS DEVICE IN RELATION TO THE PHANTOM ..... 195**

**ANNEX E EQUIVALENT MEDIA RECIPES ..... 198**

**ANNEX F SYSTEM VALIDATION ..... 199**

**ANNEX G PROBE CALIBRATION CERTIFICATE..... 203**

**ANNEX H DIPOLE CALIBRATION CERTIFICATE ..... 239**

**ANNEX I SENSOR TRIGGERING DATA SUMMARY ..... 318**

**ANNEX J ACCREDITATION CERTIFICATE..... 325**

## 1 Test Laboratory

### 1.1 Testing Location

Company Name:	CTTL(Shouxiang)
Address:	No. 51 Shouxiang Science Building, Xueyuan Road, Haidian District, Beijing, P. R. China100191

### 1.2 Testing Environment

Temperature:	18°C~25°C,
Relative humidity:	30%~ 70%
Ground system resistance:	< 0.5 $\Omega$
Ambient noise & Reflection:	< 0.012 W/kg

### 1.3 Project Data

Project Leader:	Qi Dianyuan
Test Engineer:	Lin Xiaojun
Testing Start Date:	March 29, 2021
Testing End Date:	April 25, 2021

### 1.4 Signature



Lin Xiaojun  
(Prepared this test report)

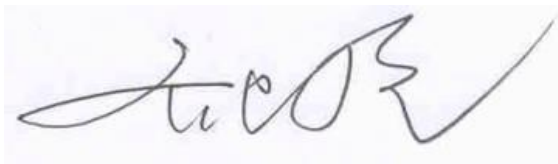

Qi Dianyuan  
(Reviewed this test report)

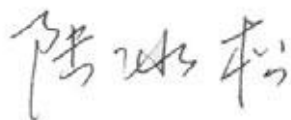

Lu Bingsong  
Deputy Director of the laboratory  
(Approved this test report)

## 2 Statement of Compliance

The maximum results of Specific Absorption Rate (SAR) found during testing for Samsung Electronics Co., Ltd. Tablet PC SM-T227U is as follows:

**Table 2.1: Highest Reported SAR (1g)**

Antenna	Band	Body	1g SAR Limits (W/kg)
		1g SAR(W/kg)	
Main antenna	UMTS FDD 2	0.57	1.6
	UMTS FDD 4	0.59	
	UMTS FDD 5	0.34	
	LTE Band 2	0.77	
	LTE Band 4	<b>0.91</b>	
	LTE Band 5	0.35	
	LTE Band 7	0.88	
	LTE Band 12	0.67	
	LTE Band 13	0.30	
	LTE Band 14	0.34	
	LTE Band 17	0.55	
	LTE Band 25	0.74	
	LTE Band 26	0.31	
	LTE Band 30	0.65	
	LTE Band 41-PC2	0.48	
	LTE Band 41-PC3	0.30	
	WiFi antenna	WiFi 2.4G	
WiFi 5G		0.57	

The SAR values found for the Mobile Phone are below the maximum recommended levels of 1.6 W/Kg as averaged over any 1g tissue according to the ANSI C95.1-1992.

For body worn operation, this device has been tested and meets FCC RF exposure guidelines when used with any accessory that contains no metal and which provides a minimum separation distance of 0/12/21/26/24/14/27 mm between this device and the body of the user. Use of other accessories may not ensure compliance with FCC RF exposure guidelines.

The EUT battery must be fully charged and checked periodically during the test to ascertain uniform power output.

The measurement together with the test system set-up is described in annex C of this test report. A detailed description of the equipment under test can be found in chapter 4 of this test report. The highest reported SAR value is obtained at the case of (**Table 2.1**), and the values are: **0.91 W/kg(1g)**.

**Table 2.2: The sum of SAR values for Main antenna + WiFi-2.4G**

	Position	Cellular antenna	WiFi-2.4G	Sum
<b>Highest SAR value for Body</b>	Rear 0mm	0.91	0.28	<b>1.19</b>

**Table 2.3: The sum of SAR values for Main antenna + WiFi-5G**

	Position	Cellular antenna	WiFi-5G	Sum
<b>Maximum reported SAR value for Body</b>	Top 0mm	0.82	0.31	<b>1.13</b>

**Table 2.4: The sum of SAR values for Main antenna + WiFi-5G +BT**

	Position	Cellular antenna	WiFi-5G	BT	Sum
<b>Maximum reported SAR value for Body</b>	Top 0mm	0.82	0.31	<0.01	<b>1.13</b>

[1] – The SAR of BT is too low to get it, so the “<0.01” is used to indicate the SAR of BT.

According to the above tables, the highest sum of reported SAR values is **1.19 W/kg (1g)**. The detail for simultaneous transmission consideration is described in chapter 13.



### 3 Client Information

#### 3.1 Applicant Information

Company Name:	Samsung Electronics Co Ltd
Address/Post:	19 Chapin Rd., Building D Pine Brook, NJ 07058
Contact Person:	Jenni Chun
Contact Email:	j1.chun@samsung.com
Telephone:	+1-201-937-4203
Fax:	/

#### 3.2 Manufacturer Information

Company Name:	Samsung Electronics Co., Ltd.
Address/Post:	Samsung R5, Maetan dong 129, Samsung ro Youngtong gu, Suwon city 443 742, Korea
Contact Person:	Sunghoon Cho
Contact Email:	ggobi.cho@samsung.com
Telephone:	+82-10-2722-4159
Fax:	/



## 4 Equipment Under Test (EUT) and Ancillary Equipment (AE)

### 4.1 About EUT

Description:	Tablet PC
Model name:	SM-T227U
Operating mode(s):	UMTS FDD 1/2/4/5/8, BT, Wi-Fi LTE Band 1/2/3/4/5/7/8/12/13/14/17/20/25/26/30/41/66/71
Tested Tx Frequency:	826.4–846.6 MHz (WCDMA 850 Band V)
	1712.4 – 1752.6 MHz (WCDMA 1700 Band IV)
	1852.4–1907.6 MHz (WCDMA1900 Band II)
	1860 – 1900 MHz (LTE Band 2)
	1710 – 1755 MHz (LTE Band 4)
	824.7 – 848.3 MHz (LTE Band 5)
	2502.5 – 2567.5 MHz (LTE Band 7)
	699.7 – 715.3 MHz (LTE Band 12)
	779.5 –784.5 MHz (LTE Band 13)
	788 – 798 MHz (LTE Band 14)
	706.5 – 713.5MHz(LTE Band 17)
	1850.7 – 1914.3 MHz (LTE Band 25)
	814.7 – 848.3 MHz (LTE Band 26)
	2307.5 – 2312.5MHz(LTE Band 30)
	2498.5 – 2687.5 MHz (LTE Band 41)
	1710.7 – 1779.3 MHz (LTE Band 66)
	665.5 – 695.5 MHz (LTE Band 71)
2402 – 2480 MHz (Bluetooth)	
2412 – 2462 MHz (Wi-Fi 2.4G)	
5150-5825 MHz (Wi-Fi 5G)	
Test device Production information:	Production unit
Device type:	Portable device
Antenna type:	Integrated antenna

#### 4.2 Internal Identification of EUT used during the test

EUT ID*	IMEI	HW Version	SW Version
EUT1	I210Z70098UT05A	REV1.0	T227U.001
EUT2	I21Z70098UT06A	REV1.0	T227U.001
EUT3	I21Z70098UT07A	REV1.0	T227U.001
EUT4	I21Z70098UT08A	REV1.0	T227U.001
EUT5	I21Z70098UT27A	REV1.0	T227U.001
EUT6	I21Z70098UT28A	REV1.0	T227U.001
EUT7	I21Z70098UT01A	REV1.0	T227U.001
EUT8	I21Z70098UT03A	REV1.0	T227U.001
EUT9	I21Z70098UT17A	REV1.0	T227U.001
EUT10	I21Z70098UT18A	REV1.0	T227U.001

\*EUT ID: is used to identify the test sample in the lab internally.

**Note:** It is performed to test SAR with the EUT1~6 and conducted power with the EUT7~10

#### 4.3 Internal Identification of AE used during the test

AE ID*	Description	Model	SN	Manufacturer
AE1	Battery	HQ-3565S	/	SCUD (Fujian) Electronics Co., Ltd.

\*AE ID: is used to identify the test sample in the lab internally.

## 5 TEST METHODOLOGY

### 5.1 Applicable Limit Regulations

**ANSI C95.1–1992:**IEEE Standard for Safety Levels with Respect to Human Exposure to Radio Frequency Electromagnetic Fields, 3 kHz to 300 GHz.

It specifies the maximum exposure limit of **1.6 W/kg** as averaged over any 1 gram of tissue for portable devices being used within 20 cm of the user in the uncontrolled environment.

### 5.2 Applicable Measurement Standards

**IEEE 1528:2013** Recommended Practice for Determining the Peak Spatial-Average Specific Absorption Rate (SAR) in the Human Head from Wireless Communications Devices: Measurement Techniques.

**KDB447498 D01 General RF Exposure Guidance v06** Mobile and Portable Devices RF Exposure Procedures and Equipment Authorization Policies.

**KDB941225 D01 SAR test for 3G devices v03r01** SAR Measurement Procedures for 3G Devices

**KDB941225 D05 SAR for LTE Devices v02r05** SAR Evaluation Considerations for LTE Devices

**KDB941225 D06 Hotspot Mode SAR v02r01** SAR Evaluation Procedures for Portable Devices with Wireless Router Capabilities

**KDB248227 D01 802.11 Wi-Fi SAR v02r02** SAR GUIDANCE FOR IEEE 802.11 (Wi-Fi) TRANSMITTERS

**KDB865664 D01 SAR measurement 100 MHz to 6 GHz v01r04** SAR Measurement Requirements for 100 MHz to 6 GHz.

**KDB865664 D02 RF Exposure Reporting v01r02** RF Exposure Compliance Reporting and Documentation Considerations

**KDB616217 D04 SAR for laptop and tablets v01r02** SAR evaluation considerations for laptop, notebook and tablet computers.

## 6 Specific Absorption Rate (SAR)

### 6.1 Introduction

SAR is related to the rate at which energy is absorbed per unit mass in an object exposed to a radio field. The SAR distribution in a biological body is complicated and is usually carried out by experimental techniques or numerical modeling. The standard recommends limits for two tiers of groups, occupational/controlled and general population/uncontrolled, based on a person's awareness and ability to exercise control over his or her exposure. In general, occupational/controlled exposure limits are higher than the limits for general population/uncontrolled.

### 6.2 SAR Definition

The SAR definition is the time derivative (rate) of the incremental energy ( $dW$ ) absorbed by (dissipated in) an incremental mass ( $dm$ ) contained in a volume element ( $dv$ ) of a given density ( $\rho$ ). The equation description is as below:

$$SAR = \frac{d}{dt} \left( \frac{dW}{dm} \right) = \frac{d}{dt} \left( \frac{dW}{\rho dv} \right)$$

SAR is expressed in units of Watts per kilogram (W/kg)

SAR measurement can be either related to the temperature elevation in tissue by

$$SAR = c \left( \frac{\delta T}{\delta t} \right)$$

Where:  $C$  is the specific heat capacity,  $\delta T$  is the temperature rise and  $\delta t$  is the exposure duration, or related to the electrical field in the tissue by

$$SAR = \frac{\sigma |E|^2}{\rho}$$

Where:  $\sigma$  is the conductivity of the tissue,  $\rho$  is the mass density of tissue and  $E$  is the RMS electrical field strength.

However for evaluating SAR of low power transmitter, electrical field measurement is typically applied.

## 7 Tissue Simulating Liquids

### 7.1 Targets for tissue simulating liquid

**Table 7.1: Targets for tissue simulating liquid**

Frequency(MHz)	Liquid Type	Conductivity( $\sigma$ )	$\pm 10\%$ Range	Permittivity( $\epsilon$ )	$\pm 10\%$ Range
750	Head	0.89	0.80~0.98	41.94	37.75~46.13
835	Head	0.90	0.81~0.99	41.5	37.35~45.65
1750	Head	1.37	1.23~1.51	40.08	36.07~44.09
1900	Head	1.40	1.26~1.54	40.0	36~44
2300	Head	1.67	1.50~1.84	39.47	37.5~41.4
2450	Head	1.80	1.62~1.98	39.2	35.28~43.12
2600	Head	1.96	1.76~2.16	39.01	35.11~42.91

**Table 7.2: Targets for tissue simulating liquid**

Frequency(MHz)	Liquid Type	Conductivity( $\sigma$ )	$\pm 5\%$ Range	Permittivity( $\epsilon$ )	$\pm 5\%$ Range
5250	Head	4.71	4.47~4.95	35.93	34.13~37.73
5600	Head	5.07	4.82~5.32	35.53	33.8~37.3
5750	Head	5.22	4.96~5.48	35.36	33.59~37.13

The dielectric constant ( $\epsilon_r$ ) and conductivity( $\sigma$ ) of typical tissue-equivalent media recipes are expected to be within  $\pm 5\%$  of the required target values; but for SAR measurement systems that have implemented the SAR error compensation algorithms documented in IEEE Std 1528-2013, to automatically compensate the measured SAR results for deviations between the measured and required tissue dielectric parameters the tolerance for  $\epsilon_r$  and  $\sigma$  may be relaxed to  $\pm 10\%$ . This is limited to frequencies  $\leq 3$  GHz.

## 7.2 Dielectric Performance

Table 7.3: Dielectric Performance of Tissue Simulating Liquid

Measurement Date (yyyy-mm-dd)	Type	Frequency	Permittivity $\epsilon$	Drift (%)	Conductivity $\sigma$ (S/m)	Drift (%)
2021-3-29	Head	750 MHz	44.02	4.96	0.822	-7.64
2021-3-30	Head	750 MHz	43.15	2.89	0.843	-5.28
2021-3-31	Head	750 MHz	43.15	2.89	0.843	-5.28
2021-4-25	Head	750 MHz	44.89	7.03	0.82	-7.87
2021-4-26	Head	750 MHz	45.22	7.82	0.831	-6.63
2021-3-29	Head	835 MHz	43.76	5.45	0.855	-5.00
2021-3-30	Head	835 MHz	42.71	2.92	0.878	-2.44
2021-4-25	Head	835 MHz	44.65	7.59	0.854	-5.11
2021-3-29	Head	1750 MHz	41.48	3.49	1.371	0.07
2021-3-29	Head	1750 MHz	41.59	3.77	1.34	-2.19
2021-3-30	Head	1750 MHz	40.3	0.55	1.375	0.36
2021-3-29	Head	1900 MHz	41.13	2.83	1.455	3.93
2021-3-29	Head	1900 MHz	41.25	3.13	1.442	3.00
2021-3-30	Head	1900 MHz	39.87	-0.33	1.467	4.79
2021-3-30	Head	2300 MHz	39.13	-0.86	1.798	7.66
2021-4-15	Head	2450 MHz	40.77	4.01	1.941	7.83
2021-3-30	Head	2600 MHz	38.5	-1.31	2.017	2.91
2021-4-15	Head	5250 MHz	34.42	-4.20	4.863	3.25
2021-4-16	Head	5600 MHz	33.79	-4.90	5.23	3.16
2021-4-16	Head	5750 MHz	33.69	-4.72	5.431	4.04

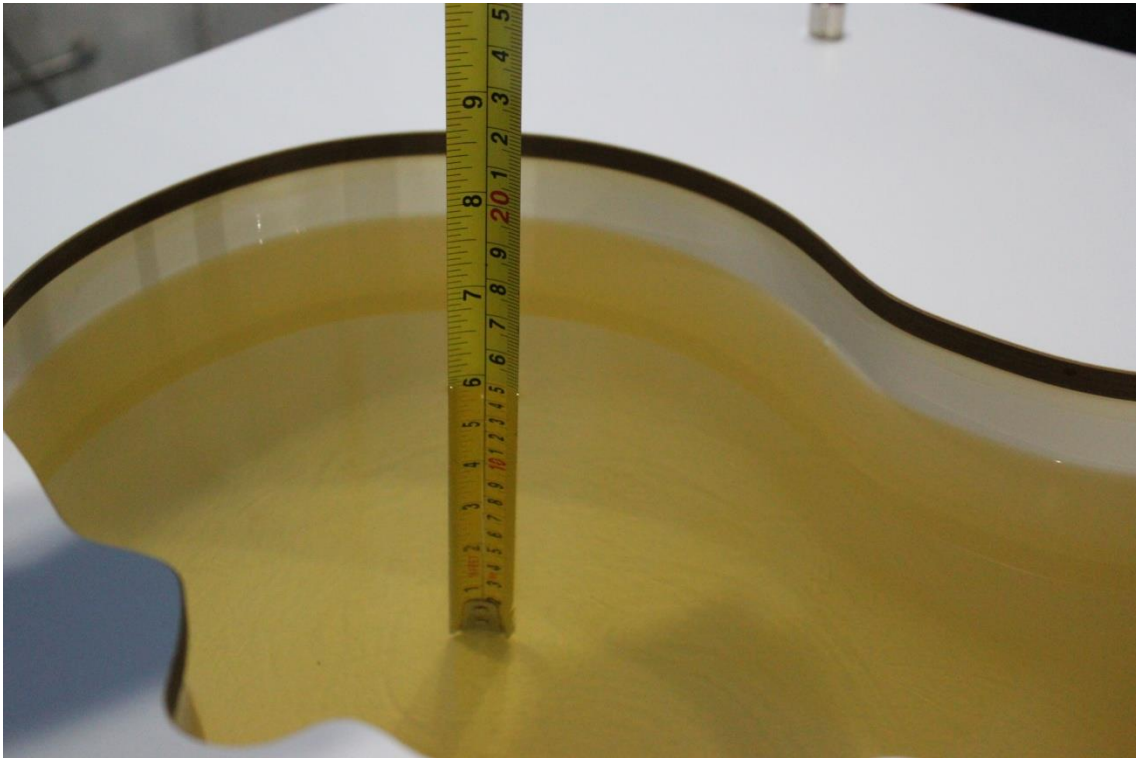

**Picture 7-1 Liquid depth in the Head Phantom (750MHz)**

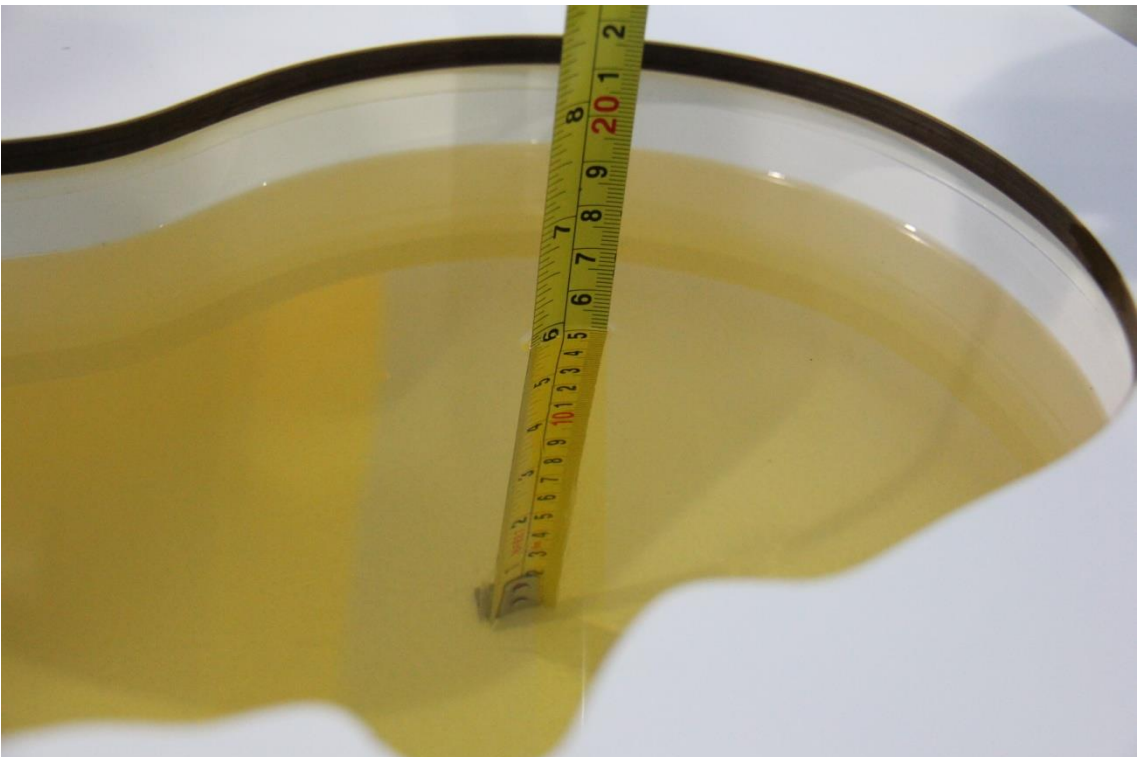

**Picture 7-2 Liquid depth in the Head Phantom (835 MHz)**

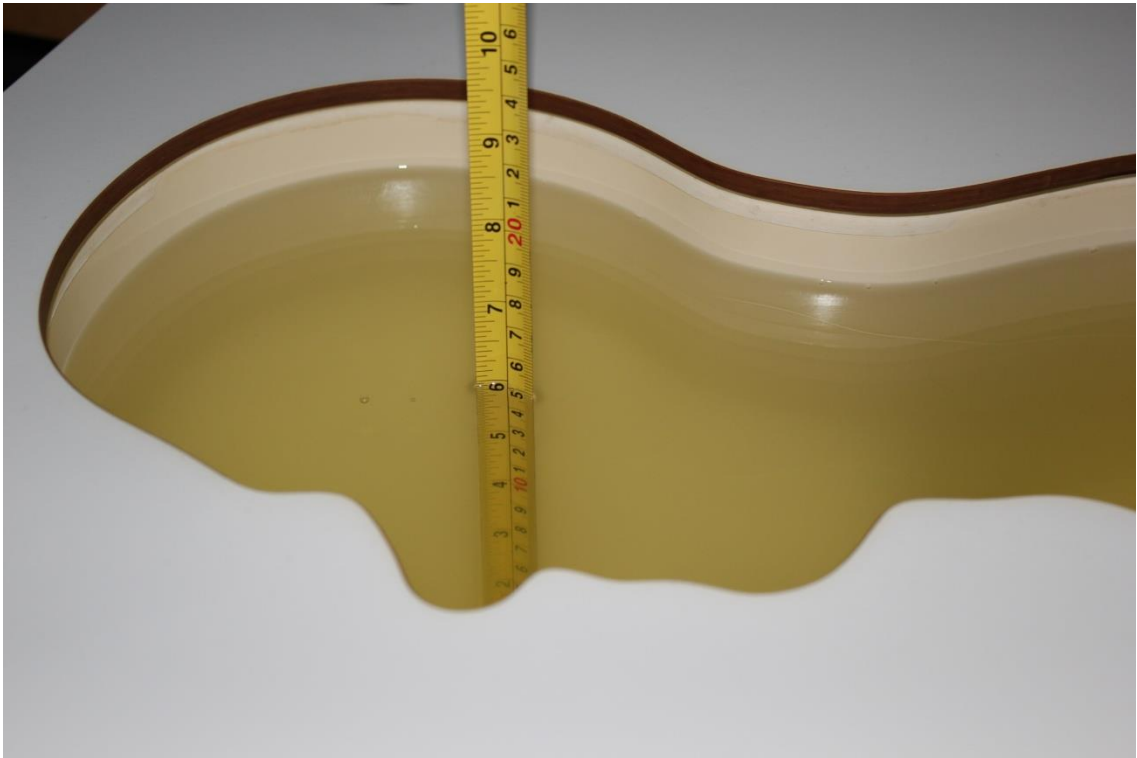

Picture 7-3 Liquid depth in the Head Phantom (1750 MHz)



Picture 7-4 Liquid depth in the Head Phantom (1900 MHz)



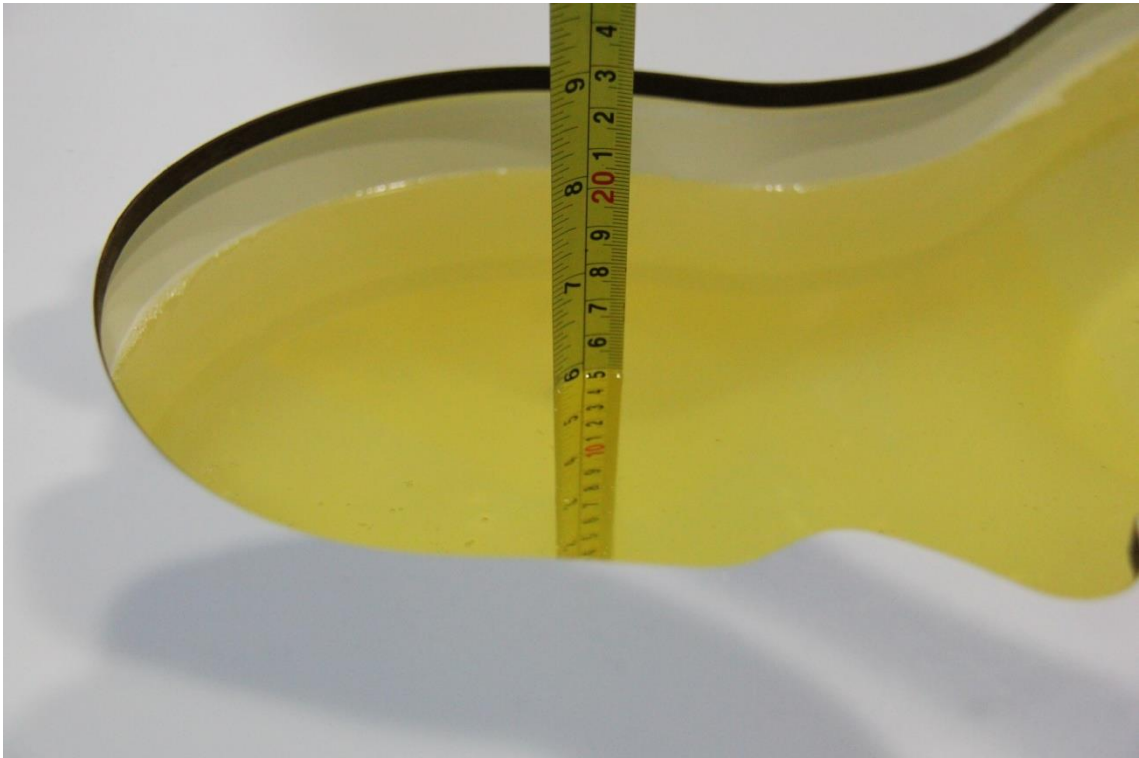

Picture 7-5 Liquid depth in the Head Phantom (2450MHz)



Picture 7-6 Liquid depth in the Head Phantom (2600 MHz Head)



Picture 7-7 Liquid depth in the Head Phantom (5GHz)

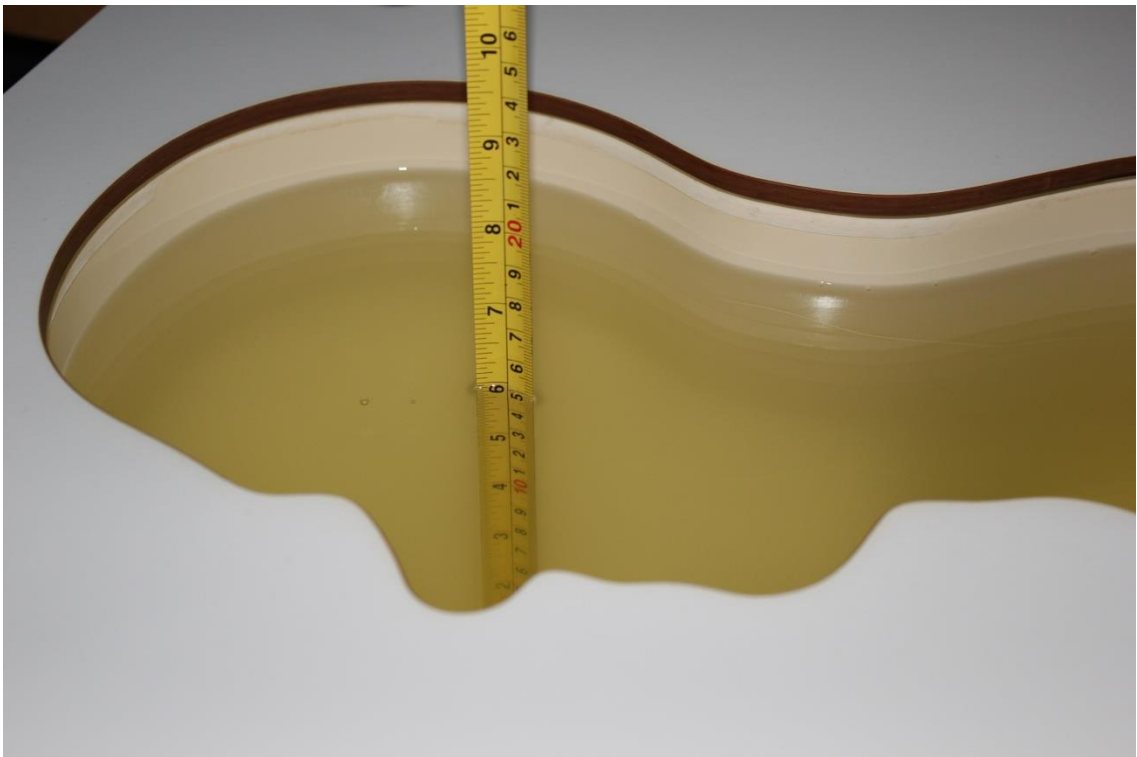

Picture 7-8 Liquid depth in the Head Phantom (2300 MHz Head)

## 8 System verification

### 8.1 System Setup

In the simplified setup for system evaluation, the DUT is replaced by a calibrated dipole and the power source is replaced by a continuous wave that comes from a signal generator. The calibrated dipole must be placed beneath the flat phantom section of the SAM twin phantom with the correct distance holder. The distance holder should touch the phantom surface with a light pressure at the reference marking and be oriented parallel to the long side of the phantom. The equipment setup is shown below:

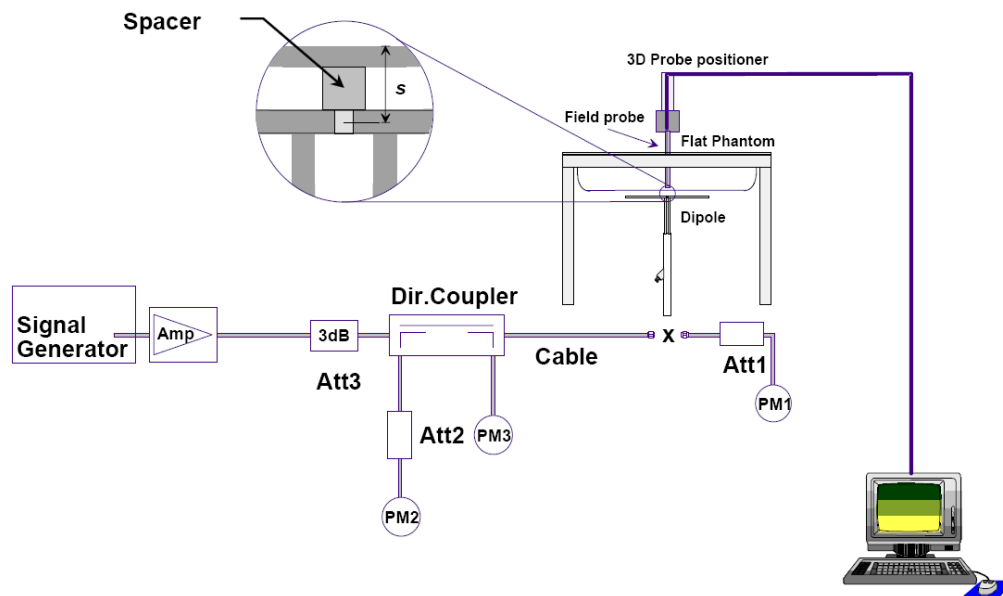

Picture 8.1 System Setup for System Evaluation



Picture 8.2 Photo of Dipole Setup

## 8.2 System Verification

SAR system verification is required to confirm measurement accuracy, according to the tissue dielectric media, probe calibration points and other system operating parameters required for measuring the SAR of a test device. The system verification must be performed for each frequency band and within the valid range of each probe calibration point required for testing the device.

The system verification results are required that the area scan estimated 1-g SAR is within 3% of the zoom scan 1-g SAR. The details are presented in annex B.

**Table 8.1: System Verification of Head**

Measurement Date (yyyy-mm-dd)	Frequency	Target value (W/kg)		Measured value(W/kg)		Deviation	
		10 g Average	1 g Average	10 g Average	1 g Average	10 g Average	1 g Average
2021-3-29	750 MHz	5.53	8.47	5.40	8.08	-2.35%	-4.60%
2021-3-30	750 MHz	5.53	8.47	5.68	8.48	2.71%	0.12%
2021-3-31	750 MHz	5.53	8.47	5.68	8.48	2.71%	0.12%
2021-4-25	750 MHz	5.53	8.47	5.56	8.32	0.54%	-1.77%
2021-4-26	750 MHz	5.53	8.47	5.60	8.36	1.27%	-1.30%
2021-3-29	835 MHz	6.25	9.60	6.40	9.64	2.40%	0.42%
2021-3-30	835 MHz	6.25	9.60	6.32	9.56	1.12%	-0.42%
2021-4-25	835 MHz	6.25	9.60	6.68	10.16	6.88%	5.83%
2021-3-29	1750 MHz	19.1	36.5	19.3	36.6	0.94%	0.27%
2021-3-29	1750 MHz	19.1	36.5	20.0	37.8	4.50%	3.67%
2021-3-30	1750 MHz	19.1	36.5	20.8	39.4	9.11%	7.95%
2021-3-29	1900 MHz	20.6	39.6	20.2	39.1	-2.14%	-1.21%
2021-3-29	1900 MHz	20.6	39.6	20.1	39.2	-2.52%	-1.11%
2021-3-30	1900 MHz	20.6	39.6	19.0	37.1	-7.57%	-6.26%
2021-3-30	2300 MHz	23.8	49.7	23.0	49.2	-3.53%	-1.01%
2021-4-15	2450 MHz	24.5	52.5	25.0	54.4	2.04%	3.62%
2021-3-30	2600 MHz	25.3	57.0	26.3	59.6	3.87%	4.56%
2021-4-15	5250 MHz	22.9	80.5	23.1	83.5	0.87%	3.73%
2021-4-16	5600 MHz	23.6	83.3	24.1	87.0	2.12%	4.44%
2021-4-16	5750 MHz	22.7	80.4	22.1	80.1	-2.64%	-0.37%

## 9 Measurement Procedures

### 9.1 Tests to be performed

In order to determine the highest value of the peak spatial-average SAR of a handset, all device positions, configurations and operational modes shall be tested for each frequency band according to steps 1 to 3 below. A flowchart of the test process is shown in picture 9.1.

**Step 1:** The tests described in 9.2 shall be performed at the channel that is closest to the centre of the transmit frequency band ( $f_c$ ) for:

- a) all device positions (cheek and tilt, for both left and right sides of the SAM phantom, as described in annex D),
- b) all configurations for each device position in a), e.g., antenna extended and retracted, and
- c) all operational modes, e.g., analogue and digital, for each device position in a) and configuration in b) in each frequency band.

If more than three frequencies need to be tested according to 11.1 (i.e.,  $N_c > 3$ ), then all frequencies, configurations and modes shall be tested for all of the above test conditions.

**Step 2:** For the condition providing highest peak spatial-average SAR determined in Step 1, perform all tests described in 9.2 at all other test frequencies, i.e., lowest and highest frequencies. In addition, for all other conditions (device position, configuration and operational mode) where the peak spatial-average SAR value determined in Step 1 is within 3 dB of the applicable SAR limit, it is recommended that all other test frequencies shall be tested as well.

**Step 3:** Examine all data to determine the highest value of the peak spatial-average SAR found in Steps 1 to 2.

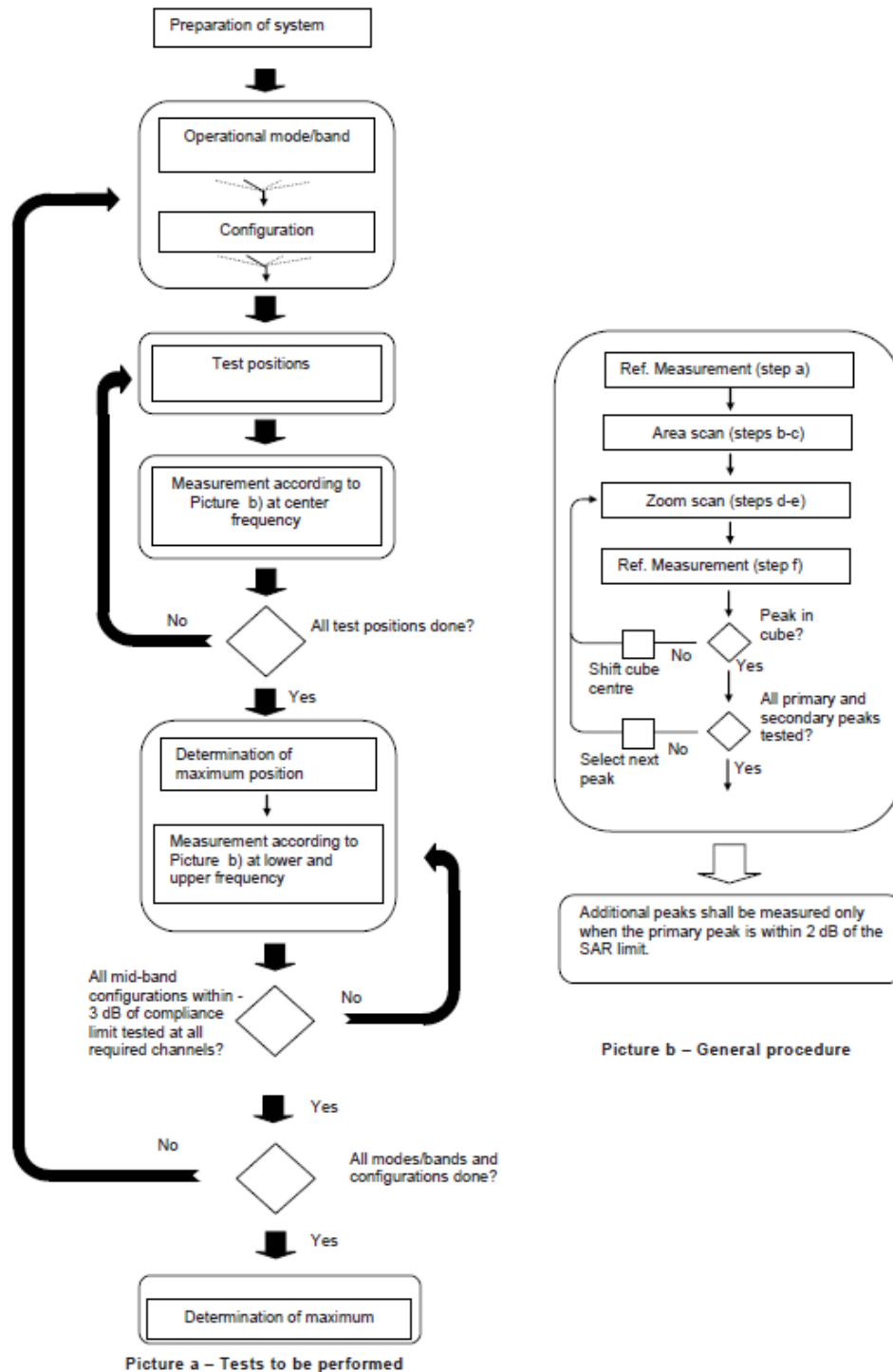

**Picture 9.1**Block diagram of the tests to be performed

## 9.2 General Measurement Procedure

The area and zoom scan resolutions specified in the table below must be applied to the SAR measurements and fully documented in SAR reports to qualify for TCB approval. Probe boundary effect error compensation is required for measurements with the probe tip closer than half a probe tip diameter to the phantom surface. Both the probe tip diameter and sensor offset distance must satisfy measurement protocols; to ensure probe boundary effect errors are minimized and the

higher fields closest to the phantom surface can be correctly measured and extrapolated to the phantom surface for computing 1-g SAR. Tolerances of the post-processing algorithms must be verified by the test laboratory for the scan resolutions used in the SAR measurements, according to the reference distribution functions specified in IEEE Std 1528-2013. The results should be documented as part of the system validation records and may be requested to support test results when all the measurement parameters in the following table are not satisfied.

		$\leq 3$ GHz	$> 3$ GHz
Maximum distance from closest measurement point (geometric center of probe sensors) to phantom surface		$5 \pm 1$ mm	$\frac{1}{2} \cdot \delta \cdot \ln(2) \pm 0.5$ mm
Maximum probe angle from probe axis to phantom surface normal at the measurement location		$30^\circ \pm 1^\circ$	$20^\circ \pm 1^\circ$
Maximum area scan spatial resolution: $\Delta x_{Area}$ , $\Delta y_{Area}$		$\leq 2$ GHz: $\leq 15$ mm 2 – 3 GHz: $\leq 12$ mm	3 – 4 GHz: $\leq 12$ mm 4 – 6 GHz: $\leq 10$ mm
		When the x or y dimension of the test device, in the measurement plane orientation, is smaller than the above, the measurement resolution must be $\leq$ the corresponding x or y dimension of the test device with at least one measurement point on the test device.	
Maximum zoom scan spatial resolution: $\Delta x_{Zoom}$ , $\Delta y_{Zoom}$		$\leq 2$ GHz: $\leq 8$ mm 2 – 3 GHz: $\leq 5$ mm*	3 – 4 GHz: $\leq 5$ mm* 4 – 6 GHz: $\leq 4$ mm*
Maximum zoom scan spatial resolution, normal to phantom surface	uniform grid: $\Delta z_{Zoom}(n)$	$\leq 5$ mm	3 – 4 GHz: $\leq 4$ mm 4 – 5 GHz: $\leq 3$ mm 5 – 6 GHz: $\leq 2$ mm
	graded grid	$\Delta z_{Zoom}(1)$ : between 1 <sup>st</sup> two points closest to phantom surface	$\leq 4$ mm
		$\Delta z_{Zoom}(n>1)$ : between subsequent points	$\leq 1.5 \cdot \Delta z_{Zoom}(n-1)$
Minimum zoom scan volume	x, y, z	$\geq 30$ mm	3 – 4 GHz: $\geq 28$ mm 4 – 5 GHz: $\geq 25$ mm 5 – 6 GHz: $\geq 22$ mm
Note: $\delta$ is the penetration depth of a plane-wave at normal incidence to the tissue medium; see draft standard IEEE P1528-2011 for details. * When zoom scan is required and the <i>reported</i> SAR from the area scan based 1-g SAR estimation procedures of KDB 447498 is $\leq 1.4$ W/kg, $\leq 8$ mm, $\leq 7$ mm and $\leq 5$ mm zoom scan resolution may be applied, respectively, for 2 GHz to 3 GHz, 3 GHz to 4 GHz and 4 GHz to 6 GHz.			

### 9.3 WCDMA Measurement Procedures for SAR

The following procedures are applicable to WCDMA handsets operating under 3GPP Release99, Release 5 and Release 6. The default test configuration is to measure SAR with an established radio link between the DUT and a communication test set using a 12.2kbps RMC (reference measurement channel) configured in Test Loop Mode 1. SAR is selectively confirmed for other physical channel configurations (DPCCH & DPDCH<sub>n</sub>), HSDPA and HSPA (HSUPA/HSDPA) modes according to output power, exposure conditions and device operating capabilities. Both uplink and downlink should be configured with the same RMC or AMR, when required. SAR for Release 5 HSDPA and Release 6 HSPA are measured using the applicable FRC (fixed reference channel) and E-DCH reference channel configurations. Maximum output power is verified according to applicable versions of 3GPP TS 34.121 and SAR must be measured according to these maximum output conditions. When Maximum Power Reduction (MPR) is not implemented according to Cubic Metric (CM) requirements for Release 6 HSPA, the following procedures do not apply.

#### For Release 5 HSDPA Data Devices:

Sub-test	$\beta_c$	$\beta_d$	$\beta_d$ (SF)	$\beta_c / \beta_d$	$\beta_{hs}$	CM/dB
1	2/15	15/15	64	2/15	4/15	0.0
2	12/15	15/15	64	12/15	24/25	1.0
3	15/15	8/15	64	15/8	30/15	1.5
4	15/15	4/15	64	15/4	30/15	1.5

#### For Release 6 HSPA Data Devices

Sub-test	$\beta_c$	$\beta_d$	$\beta_d$ (SF)	$\beta_c / \beta_d$	$\beta_{hs}$	$\beta_{ec}$	$\beta_{ed}$	$\beta_{ed}$ (SF)	$\beta_{ed}$ (codes)	CM (dB)	MPR (dB)	AG Index	E-TFCI
1	11/15	15/15	64	11/15	22/15	209/225	1039/225	4	1	1.5	1.5	20	75
2	6/15	15/15	64	6/15	12/15	12/15	12/15	4	1	1.5	1.5	12	67
3	15/15	9/15	64	15/9	30/15	30/15	$\beta_{ed1}:47/15$ $\beta_{ed2}:47/15$	4	2	1.5	1.5	15	92
4	2/15	15/15	64	2/15	4/15	4/15	56/75	4	1	1.5	1.5	17	71
5	15/15	15/15	64	15/15	24/15	30/15	134/15	4	1	1.5	1.5	21	81

#### Rel.8 DC-HSDPA (Cat 24)

SAR test exclusion for Rel.8 DC-HSDPA must satisfy the SAR test exclusion requirements of Rel.5 HSDPA. SAR test exclusion for DC-HSDPA devices is determined by power measurements according to the H-Set 12, Fixed Reference Channel (FRC) configuration in Table C.8.1.12 of 3GPP TS 34.121-1. A primary and a secondary serving HS-DSCH Cell are required to perform the power measurement and for the results to qualify for SAR test exclusion.



## 9.4 SAR Measurement for LTE

SAR tests for LTE are performed with a base station simulator, Rohde & Schwarz CMW500. Closed loop power control was used so the UE transmits with maximum output power during SAR testing. All powers were measured with the CMW 500.

It is performed for conducted power and SAR based on the KDB941225 D05.

SAR is evaluated separately according to the following procedures for the different test positions in each exposure condition – head, body, body-worn accessories and other use conditions. The procedures in the following subsections are applied separately to test each LTE frequency band.

### 1) QPSK with 1 RB allocation

Start with the largest channel bandwidth and measure SAR for QPSK with 1 RB allocation, using the RB offset and required test channel combination with the highest maximum output power among RB offsets at the upper edge, middle and lower edge of each required test channel. When the reported SAR is  $\leq 0.8$  W/kg, testing of the remaining RB offset configurations and required test channels is not required for 1 RB allocation; otherwise, SAR is required for the remaining required test channels and only for the RB offset configuration with the highest output power for that channel. When the reported SAR of a required test channel is  $> 1.45$  W/kg, SAR is required for all three RB offset configurations for that required test channel.

### 2) QPSK with 50% RB allocation

The procedures required for 1 RB allocation in 1) are applied to measure the SAR for QPSK with 50% RB allocation.

### 3) QPSK with 100% RB allocation

For QPSK with 100% RB allocation, SAR is not required when the highest maximum output power for 100 % RB allocation is less than the highest maximum output power in 50% and 1 RB allocations and the highest reported SAR for 1 RB and 50% RB allocation in 1) and 2) are  $\leq 0.8$  W/kg. Otherwise, SAR is measured for the highest output power channel; and if the reported SAR is  $> 1.45$  W/kg, the remaining required test channels must also be tested.

## TDD test:

TDD testing is performed using guidance from FCC KDB 941225 D05 v02r05 and the SAR test guidance provided in April 2013 TCB works hop notes. TDD is tested at the highest duty factor using UL-DL configuration 0 with special subframe configuration 6 and applying the FDD LTE procedures in KDB 941225 D05 v02r05. SAR testing is performed using the extended cyclic prefix listed in 3GPP TS 36.211.

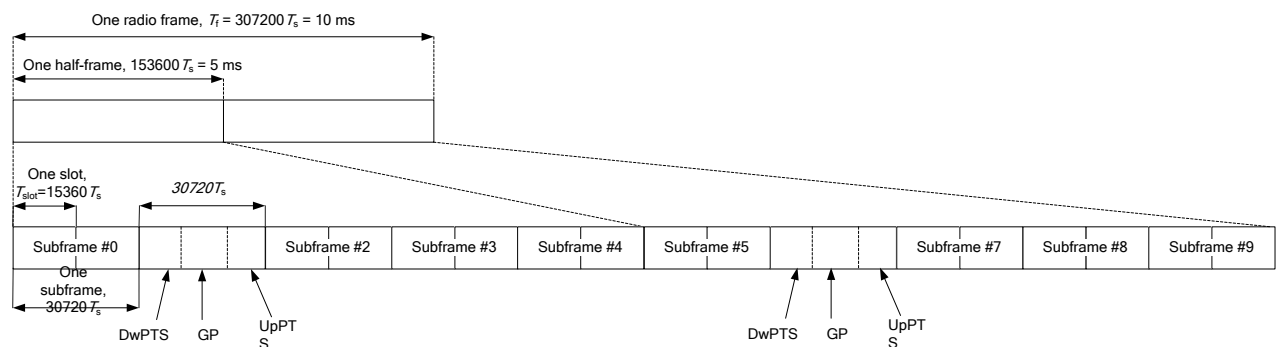

**Figure 9.2: Frame structure type 2 (for 5 ms switch-point periodicity)**

**Table 9.1: Configuration of special subframe (lengths of DwPTS/GP/UpPTS)**

Special subframe configuration	Normal cyclic prefix in downlink			Extended cyclic prefix in downlink		
	DwPTS	UpPTS		DwPTS	UpPTS	
		Normal cyclic prefix in uplink	Extended cyclic prefix in uplink		Normal cyclic prefix in uplink	Extended cyclic prefix in uplink
0	$6592 \cdot T_s$	$2192 \cdot T_s$	$2560 \cdot T_s$	$7680 \cdot T_s$	$2192 \cdot T_s$	$2560 \cdot T_s$
1	$19760 \cdot T_s$			$20480 \cdot T_s$		
2	$21952 \cdot T_s$			$23040 \cdot T_s$		
3	$24144 \cdot T_s$			$25600 \cdot T_s$		
4	$26336 \cdot T_s$			$7680 \cdot T_s$		
5	$6592 \cdot T_s$	$4384 \cdot T_s$	$5120 \cdot T_s$	$20480 \cdot T_s$	$4384 \cdot T_s$	$5120 \cdot T_s$
6	$19760 \cdot T_s$			$23040 \cdot T_s$		
7	$21952 \cdot T_s$			$12800 \cdot T_s$		
8	$24144 \cdot T_s$			-		
9	$13168 \cdot T_s$			-		

**Table 9.2: Uplink-downlink configurations**

Uplink-downlink configuration	Downlink-to-Uplink Switch-point periodicity	Subframe number										
		0	1	2	3	4	5	6	7	8	9	
0	5 ms	D	S	U	U	U	D	S	U	U	U	
1	5 ms	D	S	U	U	D	D	S	U	U	D	
2	5 ms	D	S	U	D	D	D	S	U	D	D	
3	10 ms	D	S	U	U	U	D	D	D	D	D	
4	10 ms	D	S	U	U	D	D	D	D	D	D	
5	10 ms	D	S	U	D	D	D	D	D	D	D	
6	5 ms	D	S	U	U	U	D	S	U	U	D	

Duty factor is calculated by:

Duty factor = uplink frame\*6+UpPTS\*2/one frame length

$$= (30720 \cdot T_s * 6 + 5120 \cdot T_s * 2) / 307200 \cdot T_s$$

$$= 0.633$$

According to the KDB 447498 D01, SAR should be evaluated at more than 3 frequencies for devices supporting transmit bands wider than 100MHz. Oct.2014 FCC-TCB conference notes (Dec. 2014 rev.) specifies the 5 test channels to use for 3GPP band 41 SAR evaluation.

## 9.5 Bluetooth & Wi-Fi Measurement Procedures for SAR

Normal network operating configurations are not suitable for measuring the SAR of 802.11 transmitters in general. Unpredictable fluctuations in network traffic and antenna diversity conditions can introduce undesirable variations in SAR results. The SAR for these devices should be measured using chipset based test mode software to ensure that the results are consistent and reliable.

Chipset based test mode software is hardware dependent and generally varies among manufacturers. The device operating parameters established in a test mode for SAR measurements must be identical to those programmed in production units, including output power levels, amplifier gain settings and other RF performance tuning parameters. The test frequencies should correspond to actual channel frequencies defined for domestic use. SAR for devices with switched diversity should be measured with only one antenna transmitting at a time during each SAR measurement, according to a fixed modulation and data rate. The same data pattern should be used for all measurements.

## 9.6 Power Drift

To control the output power stability during the SAR test, DASY5 system calculates the power drift by measuring the E-field at the same location at the beginning and at the end of the measurement for each test position. These drift values can be found in section 14 labeled as: (Power Drift [dB]). This ensures that the power drift during one measurement is within 5%.

## 10 Area Scan Based 1-g SAR

### 10.1 Requirement of KDB

According to the KDB447498 D01 v06, when the implementation is based the specific polynomial fit algorithm as presented at the 29th Bioelectromagnetics Society meeting (2007) and the estimated 1-gSAR is  $\leq 1.2$  W/kg, a zoom scan measurement is not required provided it is also not needed for any other purpose; for example, if the peak SAR location required for simultaneous transmission SAR test exclusion can be determined accurately by the SAR system or manually to discriminate between distinctive peaks and scattered noisy SAR distributions from area scans.

There must not be any warning or alert messages due to various measurement concerns identified by the SAR system; for example, noise in measurements, peaks too close to scan boundary, peaks are too sharp, spatial resolution and uncertainty issues etc. The SAR system verification must also demonstrate that the area scan estimated 1-g SAR is within 3% of the zoom scan 1-g SAR (See Annex B). When all the SAR results for each exposure condition in a frequency band and wireless mode are based on estimated 1-g SAR, the 1-g SAR for the highest SAR configuration must be determined by a zoom scan.

### 10.2 Fast SAR Algorithms

The approach is based on the area scan measurement applying a frequency dependent attenuation parameter. This attenuation parameter was empirically determined by analyzing a large number of phones. The MOTOROLA FAST SAR was developed and validated by the MOTOROLA Research Group in Ft. Lauderdale.

In the initial study, an approximation algorithm based on Linear fit was developed. The accuracy of the algorithm has been demonstrated across a broad frequency range (136-2450 MHz) and for both 1- and 10-g averaged SAR using a sample of 264 SAR measurements from 55 wireless handsets. For the sample size studied, the root-mean-squared errors of the algorithm are 1.2% and 5.8% for 1- and 10-g averaged SAR, respectively. The paper describing the algorithm in detail is expected to be published in August 2004 within the Special Issue of Transactions on MTT.

In the second step, the same research group optimized the fitting algorithm to an Polynomial fit whereby the frequency validity was extended to cover the range 30-6000MHz. Details of this study can be found in the BEMS 2007 Proceedings.

Both algorithms are implemented in DASY software.

## 11 Conducted Output Power

Table: Summary of Receiver detection mechanism

Antenna	Sensor deactive (Body scenario)	Sensor active (Body scenario)
Main antenna	Power Level A1	Power Level B1

### 11.1 WCDMA Measurement result

Table 11.1-1: The conducted Power for WCDMA- Level A1

Item	band	FDDV result			
	ARFCN	4233 (846.6MHz)	4182 (836.4MHz)	4132 (826.4MHz)	Tune up
WCDMA	\	24.54	24.47	24.42	25.50
HSUPA	1	21.83	21.70	21.65	22.50
	2	21.79	21.69	21.66	22.50
	3	22.78	22.72	22.66	23.50
	4	21.26	21.24	21.18	22.50
	5	22.77	22.68	22.62	23.50
DC-HSDPA	1	23.73	23.70	23.67	24.50
	2	23.65	23.62	23.51	24.50
	3	23.17	23.13	23.11	24.00
	4	23.15	23.14	23.09	24.00
Item	band	FDDIV result			
	ARFCN	1513 (1752.6MHz)	1412 (1732.4MHz)	1312 (1712.4MHz)	
WCDMA	\	24.65	24.76	24.83	25.50
HSUPA	1	22.11	22.21	22.24	23.50
	2	22.09	22.20	22.23	22.50
	3	23.11	23.19	23.23	23.50
	4	21.56	21.66	21.68	22.50
	5	23.06	23.17	23.18	24.50
DC-HSDPA	1	24.25	24.31	24.33	24.50
	2	24.06	24.16	24.27	24.50
	3	23.67	23.73	23.75	24.00
	4	23.64	23.70	23.74	24.00
Item	band	FDDII result			
	ARFCN	9538 (1907.6MHz)	9400 (1880MHz)	9262 (1852.4MHz)	
WCDMA	\	24.45	24.33	24.36	25.20
HSUPA	1	21.87	21.77	21.84	22.20
	2	21.84	21.80	21.86	22.20
	3	22.88	22.78	22.85	23.20
	4	21.37	21.28	21.33	22.20
	5	22.81	22.75	22.79	23.50

DC-HSDPA	1	23.94	23.93	23.95	24.20
	2	23.84	23.86	23.91	24.20
	3	23.37	23.34	23.38	23.70
	4	23.34	23.32	23.35	23.70

**Table 11.2-2: The conducted Power for WCDMA- Level B1**

Item	band	FDDV result			
	ARFCN	4233 (846.6MHz)	4182 (836.4MHz)	4132 (826.4MHz)	Tune up
WCDMA	\	18.02	17.95	17.97	19.00
HSUPA	1	15.34	15.33	15.31	16.00
	2	15.31	15.32	15.30	16.00
	3	16.31	16.24	16.19	17.00
	4	15.26	15.15	15.13	16.00
	5	16.29	16.22	16.20	18.00
DC-HSDPA	1	17.27	17.21	17.23	18.00
	2	17.15	17.14	17.13	18.00
	3	16.75	16.77	16.73	17.50
	4	16.71	16.72	16.70	17.50
Item	band	FDDIV result			
	ARFCN	1513 (1752.6MHz)	1412 (1732.4MHz)	1312 (1712.4MHz)	
WCDMA	\	12.73	12.80	12.78	13.50
HSUPA	1	10.31	10.32	10.33	11.50
	2	10.29	10.20	10.30	10.50
	3	11.29	11.32	11.31	11.50
	4	9.74	9.78	9.85	10.50
	5	11.26	11.27	11.28	12.50
DC-HSDPA	1	12.26	12.15	12.22	12.50
	2	12.16	12.11	12.18	12.50
	3	11.82	11.83	11.84	12.00
	4	11.78	11.79	11.81	12.00
Item	band	FDDII result			
	ARFCN	9538 (1907.6MHz)	9400 (1880MHz)	9262 (1852.4MHz)	
WCDMA	\	10.80	10.77	10.85	12.00
HSUPA	1	8.39	8.36	8.42	9.00
	2	8.38	8.37	8.45	9.00
	3	9.32	9.29	9.35	10.00
	4	7.91	7.84	7.93	9.00
	5	9.28	9.25	9.33	11.00
DC-HSDPA	1	10.29	10.25	10.42	11.00
	2	10.23	10.14	10.41	11.00
	3	9.87	9.89	9.93	10.50
	4	9.82	9.84	9.86	10.50

## 11.2 LTE Measurement result

**Table 11.2-1: Tune up for LTE - Level A1**

Band	Tune up (dBm)
Band 2	25.2
Band 4	25.5
Band 5	25.5
Band 7	24
Band 12	25.5
Band 13	25
Band 14	25
Band 17	25.5
Band 25	25.2
Band 26	25.5
Band 30	24
Band 41-PC2	27.5
Band 41-PC3	24.5
Band 66	25.5
Band 71	25.5

**Table 11.2-2: Tune up for LTE - Level B1**

Band	Tune up (dBm)
Band 2	12.2
Band 4	13.5
Band 5	19
Band 7	13
Band 12	17
Band 13	16.5
Band 14	16.5
Band 17	17
Band 25	12.2
Band 26	19
Band 30	11
Band 41-PC2	15.5
Band 41-PC3	13.5
Band 66	13.5
Band 71	17

**Table 11.2-3: Maximum Power Reduction (MPR) for LTE**

Modulation	Channel bandwidth / Transmission bandwidth configuration [RB]						MPR (dB)
	1.4 MHz	3 MHz	5 MHz	10 MHz	15 MHz	20 MHz	
QPSK	> 5	> 4	> 8	> 12	> 16	> 18	1
16 QAM	≤ 5	≤ 4	≤ 8	≤ 12	≤ 16	≤ 18	1
16 QAM	> 5	> 4	> 8	> 12	> 16	> 18	2
64 QAM	≤ 5	≤ 4	≤ 8	≤ 12	≤ 16	≤ 18	2
64 QAM	> 5	> 4	> 8	> 12	> 16	> 18	3



## Level A1

Band 2					
Bandwidth (MHz)	RB allocation RB offset (Start RB)	Frequency (MHz)	QPSK	16QAM	64QAM
			Actual output power (dBm)	Actual output power (dBm)	Actual output power (dBm)
1.4 MHz	1RB High (5)	1909.3	24.32	23.57	23.25
		1880	24.19	23.19	23.06
		1850.7	24.23	23.36	23.20
	1RB Middle (3)	1909.3	24.50	23.69	23.44
		1880	24.47	23.32	23.25
		1850.7	24.37	23.56	23.31
	1RB Low (0)	1909.3	24.23	23.56	23.29
		1880	24.23	23.22	23.08
		1850.7	24.31	23.36	23.17
	3RB High (3)	1909.3	24.22	23.50	23.28
		1880	24.28	23.39	23.19
		1850.7	24.25	23.42	23.20
	3RB Middle (1)	1909.3	24.35	23.53	23.35
		1880	24.33	23.44	23.19
		1850.7	24.32	23.45	23.22
	3RB Low (0)	1909.3	24.25	23.53	23.28
		1880	24.27	23.36	23.09
		1850.7	24.27	23.41	23.18
	6RB (0)	1909.3	23.25	22.21	22.19
		1880	23.23	22.37	21.99
		1850.7	23.24	22.52	22.10
3 MHz	1RB High (14)	1908.5	24.36	23.63	23.41
		1880	24.27	23.23	23.19
		1851.5	24.26	23.23	23.23
	1RB Middle (7)	1908.5	24.52	23.75	23.54
		1880	24.41	23.41	23.37
		1851.5	24.45	23.35	23.48
	1RB Low (0)	1908.5	24.34	23.70	23.36
		1880	24.35	23.33	23.22
		1851.5	24.30	23.28	23.31
	8RB High (7)	1908.5	23.26	22.37	22.29
		1880	23.25	22.24	22.08
		1851.5	23.27	22.43	22.18
	8RB Middle (4)	1908.5	23.32	22.43	22.25
		1880	23.30	22.33	22.14
		1851.5	23.31	22.49	22.23
	8RB Low (0)	1908.5	23.24	22.41	22.27
		1880	23.25	22.29	22.11
		1851.5	23.27	22.45	22.17
15RB (0)	1908.5	23.24	22.37	22.22	
	1880	23.25	22.18	22.04	
	1851.5	23.26	22.39	22.13	

5 MHz	1RB High (24)	1907.5	24.28	23.33	23.27
		1880	24.32	23.37	23.09
		1852.5	24.23	23.74	23.16
	1RB Middle (12)	1907.5	24.49	23.59	23.57
		1880	24.57	23.65	23.38
		1852.5	24.49	23.99	23.47
	1RB Low (0)	1907.5	24.25	23.37	23.22
		1880	24.32	23.37	23.05
		1852.5	24.24	23.76	23.20
	12RB High (13)	1907.5	23.32	22.37	22.21
		1880	23.28	22.27	22.01
		1852.5	23.35	22.47	22.12
	12RB Middle (6)	1907.5	23.38	22.48	22.26
		1880	23.35	22.39	22.11
		1852.5	23.39	22.58	22.17
	12RB Low (0)	1907.5	23.32	22.36	22.20
		1880	23.30	22.33	22.09
		1852.5	23.33	22.46	22.10
25RB (0)	1907.5	23.30	22.33	22.17	
	1880	23.30	22.28	22.06	
	1852.5	23.36	22.46	22.09	
10 MHz	1RB High (49)	1905	24.33	23.31	23.26
		1880	24.24	23.16	23.09
		1855	24.29	23.63	23.24
	1RB Middle (24)	1905	24.28	23.46	23.36
		1880	24.36	23.30	23.27
		1855	24.46	23.79	23.34
	1RB Low (0)	1905	24.27	23.38	23.35
		1880	24.25	23.20	23.12
		1855	24.32	23.64	23.22
	25RB High (25)	1905	23.35	22.51	22.22
		1880	23.25	22.29	22.06
		1855	23.44	22.50	22.17
	25RB Middle (12)	1905	23.39	22.52	22.25
		1880	23.33	22.34	22.10
		1855	23.40	22.52	22.16
	25RB Low (0)	1905	23.34	22.52	22.24
		1880	23.37	22.38	22.15
		1855	23.36	22.45	22.10
50RB (0)	1905	23.37	22.46	22.24	
	1880	23.31	22.33	22.10	
	1855	23.43	22.49	22.13	
15 MHz	1RB High (74)	1902.5	24.23	23.13	23.22
		1880	24.24	23.54	23.09
		1857.5	24.25	23.70	23.10
	1RB Middle (37)	1902.5	24.37	23.32	23.41
		1880	24.40	23.67	23.23
		1857.5	24.38	23.74	23.30

	1RB Low (0)	1902.5	24.20	23.20	23.28
		1880	24.32	23.66	23.21
		1857.5	24.35	23.67	23.20
	36RB High (38)	1902.5	23.38	22.36	22.21
		1880	23.33	22.25	22.00
		1857.5	23.37	22.32	22.13
	36RB Middle (19)	1902.5	23.40	22.38	22.21
		1880	23.38	22.34	22.06
		1857.5	23.42	22.33	22.12
	36RB Low (0)	1902.5	23.36	22.34	22.16
		1880	23.37	22.36	22.09
		1857.5	23.40	22.29	22.07
	75RB (0)	1902.5	23.40	22.40	22.19
		1880	23.37	22.33	22.05
		1857.5	23.39	22.38	22.09
20 MHz	1RB High (99)	1900	24.09	23.54	23.25
		1880	24.05	23.41	23.03
		1860	24.07	23.66	23.17
	1RB Middle (50)	1900	24.35	23.86	23.38
		1880	24.31	23.73	23.32
		1860	24.33	23.96	23.39
	1RB Low (0)	1900	24.06	23.49	23.12
		1880	24.08	23.56	23.07
		1860	24.15	23.66	23.18
	50RB High (50)	1900	23.25	22.33	22.19
		1880	23.12	22.07	21.93
		1860	23.33	22.40	22.11
	50RB Middle (25)	1900	23.34	22.38	22.19
		1880	23.24	22.20	22.08
		1860	23.32	22.37	22.11
	50RB Low (0)	1900	23.26	22.33	22.19
		1880	23.26	22.26	22.12
		1860	23.23	22.29	22.04
	100RB (0)	1900	23.27	22.32	22.19
		1880	23.15	22.18	22.04
		1860	23.28	22.34	22.08

Band 4					
Bandwidth (MHz)	RB allocation	Frequency (MHz)	Actual output power (dBm)		
	RB offset		QPSK	16QAM	64QAM
1.4 MHz	1RB_High	1754.3	24.83	24.07	23.93
		1732.5	24.97	24.10	24.04
		1710.7	25.00	24.43	23.94
	1RB_Middle	1754.3	25.06	24.20	24.03
		1732.5	25.15	24.29	24.07
		1710.7	25.20	24.11	24.18
	1RB_Low	1754.3	24.83	24.00	23.91
		1732.5	25.01	24.17	24.05
		1710.7	25.04	24.42	24.00
	3RB_High	1754.3	25.13	24.28	23.90
		1732.5	25.15	24.23	24.02
		1710.7	25.19	24.36	23.99
	3RB_Middle	1754.3	25.10	24.32	23.98
		1732.5	25.24	24.27	23.97
		1710.7	25.26	24.37	24.01
	3RB_Low	1754.3	25.02	24.28	23.93
		1732.5	25.15	24.23	23.90
		1710.7	25.19	24.35	23.95
	6RB	1754.3	23.95	23.22	22.78
		1732.5	23.97	23.26	22.87
		1710.7	24.09	23.03	22.88
3 MHz	1RB_High	1753.5	24.83	23.97	23.86
		1732.5	24.95	23.94	23.98
		1711.5	25.03	24.43	23.95
	1RB_Middle	1753.5	25.02	24.16	24.06
		1732.5	25.09	24.06	24.11
		1711.5	25.20	24.36	24.06
	1RB_Low	1753.5	24.91	24.06	23.91
		1732.5	24.94	23.95	23.92
		1711.5	25.00	24.41	23.92
	8RB_High	1753.5	23.91	23.01	22.82
		1732.5	23.98	23.18	22.86
		1711.5	24.03	23.13	22.86
	8RB_Middle	1753.5	23.97	23.05	22.80
		1732.5	24.03	23.24	22.92
		1711.5	24.07	23.20	22.90
	8RB_Low	1753.5	23.93	23.00	22.81
		1732.5	23.99	23.18	22.89
		1711.5	24.05	23.14	22.86
15RB	1753.5	23.96	22.98	22.74	
	1732.5	24.04	23.15	22.82	
	1711.5	24.06	23.10	22.80	

5 MHz	1RB_High	1752.5	24.88	23.97	23.81
		1732.5	24.96	24.12	23.90
		1712.5	24.91	24.46	23.83
	1RB_Middle	1752.5	25.10	24.25	23.99
		1732.5	25.21	24.30	24.20
		1712.5	25.17	24.15	24.14
	1RB_Low	1752.5	24.87	23.99	23.89
		1732.5	24.95	24.11	23.84
		1712.5	24.92	24.46	23.91
	12RB_High	1752.5	23.97	23.05	22.76
		1732.5	24.02	23.17	22.83
		1712.5	24.04	23.21	22.84
	12RB_Middle	1752.5	24.03	23.10	22.85
		1732.5	24.06	23.23	22.92
		1712.5	24.10	23.28	22.87
	12RB_Low	1752.5	23.98	23.01	22.77
		1732.5	24.02	23.19	22.84
		1712.5	24.01	23.21	22.84
25RB	1752.5	23.99	22.97	22.76	
	1732.5	24.06	23.18	22.83	
	1712.5	24.05	23.16	22.82	
10MHz	1RB_High	1750	24.84	23.95	23.90
		1732.5	24.91	23.94	24.00
		1715	24.98	24.42	23.95
	1RB_Middle	1750	24.98	24.09	24.02
		1732.5	25.14	24.04	24.05
		1715	25.09	24.48	24.11
	1RB_Low	1750	24.86	23.94	23.86
		1732.5	24.93	23.89	23.96
		1715	25.01	24.37	23.91
	25RB_High	1750	23.97	23.12	22.79
		1732.5	24.10	23.20	22.86
		1715	24.06	23.18	22.89
	25RB_Middle	1750	24.01	23.17	22.83
		1732.5	24.09	23.20	22.87
		1715	24.08	23.18	22.85
	25RB_Low	1750	23.99	23.14	22.81
		1732.5	24.12	23.22	22.89
		1715	24.08	23.15	22.91
50RB	1750	24.01	23.09	22.79	
	1732.5	24.15	23.22	22.88	
	1715	24.09	23.17	22.89	
15MHz	1RB_High	1747.5	24.85	24.25	25.63
		1732.5	24.87	24.31	23.86
		1717.5	24.91	23.90	23.90
	1RB_Middle	1747.5	24.91	24.38	25.67
		1732.5	25.04	24.41	23.98
		1717.5	25.00	23.98	23.95

	1RB_Low	1747.5	24.83	24.25	25.63
		1732.5	25.02	24.37	23.99
		1717.5	24.97	23.92	23.96
	36RB_High	1747.5	23.95	23.03	22.79
		1732.5	24.01	23.03	22.81
		1717.5	24.05	23.02	22.81
	36RB_Middle	1747.5	23.95	23.00	22.77
		1732.5	24.08	23.03	22.85
		1717.5	24.12	23.10	22.87
	36RB_Low	1747.5	23.92	22.97	22.75
		1732.5	24.17	23.11	22.90
		1717.5	24.07	23.07	22.83
75RB	1747.5	24.01	23.00	22.75	
	1732.5	24.12	23.11	22.83	
	1717.5	24.14	23.12	22.79	
20MHz	1RB_High	1745	24.77	24.28	23.77
		1732.5	24.79	24.29	23.91
		1720	24.88	24.44	23.87
	1RB_Middle	1745	25.01	24.35	23.99
		1732.5	25.14	24.44	24.12
		1720	25.23	24.46	24.05
	1RB_Low	1745	24.86	24.32	23.84
		1732.5	24.80	24.24	23.90
		1720	24.85	24.41	23.89
	50RB_High	1745	24.00	23.08	22.73
		1732.5	24.03	23.08	22.77
		1720	24.03	23.09	22.74
	50RB_Middle	1745	24.05	23.10	22.78
		1732.5	24.12	23.15	22.84
		1720	24.06	23.14	22.83
	50RB_Low	1745	24.01	23.07	22.76
		1732.5	24.15	23.14	22.85
		1720	24.08	23.16	22.84
	100RB	1745	23.98	23.02	22.78
		1732.5	24.09	23.14	22.83
		1720	24.06	23.15	22.83

Band 5					
Bandwidth (MHz)	RB allocation RB offset (Start RB)	Frequency (MHz)	QPSK	16QAM	64QAM
			Actual output power (dBm)	Actual output power (dBm)	Actual output power (dBm)
1.4 MHz	1RB High (5)	848.3	24.44	23.42	23.16
		836.5	24.36	23.43	23.18
		824.7	24.30	23.65	23.06
	1RB Middle (3)	848.3	24.61	23.59	23.29
		836.5	24.52	23.64	23.30
		824.7	24.53	23.79	23.13
	1RB Low (0)	848.3	24.37	23.38	23.29
		836.5	24.35	23.42	23.21
		824.7	24.31	23.62	22.96
	3RB High (3)	848.3	24.56	23.64	23.34
		836.5	24.38	23.44	23.11
		824.7	24.35	23.54	23.01
	3RB Middle (1)	848.3	24.51	23.68	23.37
		836.5	24.46	23.49	23.19
		824.7	24.40	23.53	23.01
	3RB Low (0)	848.3	24.45	23.58	23.23
		836.5	24.41	23.41	23.13
		824.7	24.35	23.49	23.04
	6RB (0)	848.3	23.54	22.66	22.17
		836.5	23.43	22.55	22.02
		824.7	23.37	22.30	21.92
3 MHz	1RB High (14)	847.5	24.46	23.41	23.30
		836.5	24.35	23.25	23.20
		825.5	24.34	23.67	23.06
	1RB Middle (7)	847.5	24.56	23.55	23.49
		836.5	24.47	23.42	23.32
		825.5	24.44	23.81	23.20
	1RB Low (0)	847.5	24.39	23.39	23.15
		836.5	24.32	23.29	23.20
		825.5	24.33	23.63	23.00
	8RB High (7)	847.5	23.49	22.50	22.19
		836.5	23.32	22.49	22.04
		825.5	23.30	22.39	21.89
	8RB Middle (4)	847.5	23.47	22.53	22.18
		836.5	23.41	22.51	22.08
		825.5	23.33	22.46	21.95
	8RB Low (0)	847.5	23.42	22.45	22.10
		836.5	23.37	22.52	22.07
		825.5	23.30	22.44	21.91
	15RB (0)	847.5	23.39	22.40	22.10
		836.5	23.37	22.39	22.01
		825.5	23.27	22.31	21.86
5 MHz	1RB	846.5	24.42	23.81	25.02

	High (24)	836.5	24.28	23.32	23.06	
		826.5	24.31	23.38	23.00	
	1RB Middle (12)	846.5	24.58	23.96	25.36	
		836.5	24.57	23.60	23.36	
	1RB Low (0)	826.5	24.54	23.62	23.27	
		846.5	24.32	23.73	24.97	
		836.5	24.30	23.39	23.02	
	12RB High (13)	826.5	24.27	23.36	22.90	
		846.5	23.33	22.45	22.07	
		836.5	23.33	22.40	22.02	
	12RB Middle (6)	826.5	23.27	22.33	21.90	
		846.5	23.43	22.57	22.16	
		836.5	23.40	22.46	22.05	
	12RB Low (0)	826.5	23.31	22.44	21.91	
		846.5	23.44	22.55	22.13	
		836.5	23.37	22.40	22.00	
	25RB (0)	826.5	23.26	22.34	21.89	
		846.5	23.41	22.47	22.12	
		836.5	23.34	22.34	22.02	
	10 MHz	1RB High (49)	826.5	23.30	22.32	21.84
			844	24.47	23.32	23.27
			836.5	24.40	23.68	23.23
		1RB Middle (24)	829	24.27	23.31	23.15
			844	24.45	23.37	23.33
			836.5	24.51	23.79	23.25
		1RB Low (0)	829	24.33	23.39	23.29
			844	24.28	23.23	23.24
			836.5	24.29	23.60	23.16
		25RB High (25)	829	24.20	23.19	23.04
			844	23.26	22.29	22.00
836.5			23.39	22.45	22.09	
25RB Middle (12)		829	23.28	22.42	22.00	
		844	23.42	22.46	22.16	
		836.5	23.40	22.44	22.07	
25RB Low (0)		829	23.33	22.43	22.00	
		844	23.40	22.43	22.16	
		836.5	23.36	22.41	22.06	
50RB (0)		829	23.34	22.42	22.01	
		844	23.35	22.35	22.07	
		836.5	23.39	22.41	22.10	
			829	23.32	22.37	22.00



Band 7					
Bandwidth (MHz)	RB allocation	Frequency (MHz)	QPSK	16QAM	64QAM
	RB offset (Start RB)		Actual output power (dBm)	Actual output power (dBm)	Actual output power (dBm)
5 MHz	1RB High (24)	2567.5	23.00	22.10	22.01
		2535	23.14	22.14	21.90
		2502.5	23.08	22.49	22.17
	1RB Middle (12)	2567.5	23.30	22.38	22.19
		2535	23.37	22.42	22.26
		2502.5	23.31	22.76	22.40
	1RB Low (0)	2567.5	22.99	22.08	22.01
		2535	23.12	22.16	21.95
		2502.5	23.09	22.50	22.19
	12RB High (13)	2567.5	22.03	21.11	20.93
		2535	22.11	21.11	20.92
		2502.5	22.13	21.22	21.16
	12RB Middle (6)	2567.5	22.11	21.22	21.01
		2535	22.14	21.17	21.00
		2502.5	22.16	21.26	21.22
	12RB Low (0)	2567.5	22.10	21.17	21.01
		2535	22.09	21.11	20.96
		2502.5	22.11	21.19	21.17
	25RB (0)	2567.5	22.09	21.07	20.96
		2535	22.10	21.09	20.92
		2502.5	22.13	21.13	21.16
10 MHz	1RB High (49)	2565	23.07	22.43	22.12
		2535	23.09	22.07	22.05
		2505	23.06	21.98	22.19
	1RB Middle (24)	2565	23.19	22.53	22.21
		2535	23.25	22.16	22.12
		2505	23.29	22.14	22.33
	1RB Low (0)	2565	23.08	22.38	22.00
		2535	23.05	22.05	21.99
		2505	23.11	21.98	22.24
	25RB High (25)	2565	22.13	21.12	20.94
		2535	22.13	21.19	20.94
		2505	22.20	21.18	21.20
	25RB Middle (12)	2565	22.15	21.19	20.98
		2535	22.16	21.19	21.00
		2505	22.21	21.17	21.19
	25RB Low (0)	2565	22.15	21.20	21.00
		2535	22.16	21.18	21.03
		2505	22.17	21.11	21.19
	50RB (0)	2565	22.16	21.15	20.96
		2535	22.16	21.15	20.97

		2505	22.14	21.13	21.17
15 MHz	1RB High (74)	2562.5	22.96	22.36	22.01
		2535	23.05	22.41	21.86
		2507.5	22.98	22.00	22.17
	1RB Middle (37)	2562.5	23.10	22.46	22.09
		2535	23.20	22.47	22.05
		2507.5	23.09	22.07	22.26
	1RB Low (0)	2562.5	23.02	22.39	22.08
		2535	23.10	22.40	22.05
		2507.5	23.07	21.92	22.17
	36RB High (38)	2562.5	22.05	21.08	20.91
		2535	22.18	21.05	20.90
		2507.5	22.14	21.13	21.14
	36RB Middle (19)	2562.5	22.09	21.12	20.95
		2535	22.20	21.09	20.95
		2507.5	22.14	21.10	21.12
	36RB Low (0)	2562.5	22.06	21.12	20.96
		2535	22.19	21.07	21.00
		2507.5	22.16	21.07	21.15
	75RB (0)	2562.5	22.07	21.08	20.91
		2535	22.17	21.10	20.91
		2507.5	22.14	21.12	21.11
20 MHz	1RB High (99)	2560	22.88	22.34	21.94
		2535	22.92	22.33	21.74
		2510	22.89	22.43	21.99
	1RB Middle (50)	2560	23.10	22.63	22.11
		2535	23.25	22.55	22.05
		2510	23.19	22.70	22.24
	1RB Low (0)	2560	22.90	22.39	21.95
		2535	22.94	22.29	21.92
		2510	22.94	22.38	22.04
	50RB High (50)	2560	21.98	20.98	20.84
		2535	22.01	20.96	20.85
		2510	22.03	21.11	21.09
	50RB Middle (25)	2560	22.07	21.13	20.94
		2535	22.06	21.03	20.94
		2510	22.06	21.10	21.12
	50RB Low (0)	2560	22.05	21.10	20.91
		2535	22.04	20.98	20.96
		2510	21.93	20.96	21.07
	100RB (0)	2560	21.99	21.04	20.88
		2535	22.04	21.00	20.91
		2510	22.01	21.05	21.10

Band 12						
Bandwidth (MHz)	RB allocation RB offset (Start RB)	Frequency (MHz)	QPSK	16QAM	64QAM	
			Actual output power (dBm)	Actual output power (dBm)	Actual output power (dBm)	
1.4 MHz	1RB High (5)	715.3	24.41	23.58	25.19	
		707.5	24.49	23.65	23.51	
		699.7	24.51	23.88	23.42	
	1RB Middle (3)	715.3	24.64	23.76	25.33	
		707.5	24.67	23.75	23.56	
		699.7	24.72	24.06	23.52	
	1RB Low (0)	715.3	24.37	23.51	25.16	
		707.5	24.47	23.65	23.43	
		699.7	24.49	23.87	23.39	
	3RB High (3)	715.3	24.62	23.84	23.43	
		707.5	24.55	23.62	23.40	
		699.7	24.55	23.75	23.44	
	3RB Middle (1)	715.3	24.58	23.85	23.58	
		707.5	24.54	23.67	23.44	
		699.7	24.62	23.75	23.41	
	3RB Low (0)	715.3	24.54	23.77	23.47	
		707.5	24.54	23.62	23.40	
		699.7	24.55	23.73	23.39	
	6RB (0)	715.3	23.47	22.77	22.37	
		707.5	23.57	22.74	22.32	
		699.7	23.60	22.49	22.31	
	3 MHz	1RB High (14)	714.5	24.40	23.60	25.24
			707.5	24.50	23.49	23.44
			700.5	24.54	23.88	23.39
		1RB Middle (7)	714.5	24.62	23.69	25.44
			707.5	24.61	23.64	23.63
			700.5	24.72	24.08	23.62
1RB Low (0)		714.5	24.46	23.56	25.25	
		707.5	24.39	23.49	23.46	
		700.5	24.54	23.87	23.41	
8RB High (7)		714.5	23.53	22.59	22.36	
		707.5	23.58	22.70	22.35	
		700.5	23.56	22.62	22.30	
8RB Middle (4)		714.5	23.57	22.61	22.35	
		707.5	23.66	22.74	22.37	
		700.5	23.63	22.69	22.39	
8RB Low (0)		714.5	23.62	22.63	22.39	
		707.5	23.52	22.64	22.29	
		700.5	23.56	22.65	22.34	
15RB (0)		714.5	23.52	22.52	22.30	
		707.5	23.56	22.61	22.29	

		700.5	23.55	22.58	22.27
5 MHz	1RB High (24)	713.5	24.35	24.01	25.20
		707.5	24.42	23.49	23.30
		701.5	24.47	23.67	23.33
	1RB Middle (12)	713.5	24.64	24.17	25.42
		707.5	24.72	23.84	23.69
		701.5	24.75	23.87	23.57
	1RB Low (0)	713.5	24.41	23.92	25.18
		707.5	24.42	23.52	23.50
		701.5	24.48	23.63	23.36
	12RB High (13)	713.5	23.40	22.56	22.22
		707.5	23.61	22.61	22.39
		701.5	23.53	22.58	22.29
	12RB Middle (6)	713.5	23.62	22.70	22.39
		707.5	23.65	22.65	22.39
		701.5	23.59	22.64	22.36
	12RB Low (0)	713.5	23.62	22.72	22.42
		707.5	23.51	22.52	22.28
		701.5	23.54	22.58	22.30
25RB (0)	713.5	23.56	22.60	22.32	
	707.5	23.57	22.54	22.33	
	701.5	23.52	22.51	22.26	
10 MHz	1RB High (49)	711	24.37	23.44	23.48
		707.5	24.44	23.74	23.41
		704	24.44	23.46	23.43
	1RB Middle (24)	711	24.62	23.50	23.57
		707.5	24.61	23.98	23.62
		704	24.56	23.55	23.58
	1RB Low (0)	711	24.28	23.41	23.52
		707.5	24.41	23.76	23.50
		704	24.42	23.37	23.44
	25RB High (25)	711	23.35	22.34	22.21
		707.5	23.56	22.56	22.44
		704	23.60	22.70	22.43
	25RB Middle (12)	711	23.54	22.55	22.39
		707.5	23.61	22.58	22.43
		704	23.55	22.59	22.40
	25RB Low (0)	711	23.45	22.50	22.35
		707.5	23.46	22.50	22.36
		704	23.54	22.59	22.38
50RB (0)	711	23.41	22.41	22.30	
	707.5	23.50	22.54	22.40	
	704	23.57	22.59	22.45	

Band 13					
Bandwidth (MHz)	RB allocation	Frequency (MHz)	QPSK	16QAM	64QAM
	RB offset (Start RB)		Actual output power (dBm)	Actual output power (dBm)	Actual output power (dBm)
5 MHz	1RB High (24)	784.5	23.89	22.83	22.52
		782	23.95	23.03	22.67
		779.5	23.86	23.29	22.57
	1RB Middle (12)	784.5	24.14	23.20	22.97
		782	24.17	23.18	22.81
		779.5	24.07	23.53	22.91
	1RB Low (0)	784.5	23.85	22.87	22.61
		782	23.86	22.90	22.62
		779.5	23.95	23.25	22.65
	12RB High (13)	784.5	22.95	22.02	21.64
		782	22.88	22.00	21.59
		779.5	22.84	22.04	21.56
	12RB Middle (6)	784.5	22.99	22.06	21.67
		782	22.94	22.03	21.64
		779.5	22.95	22.10	21.63
	12RB Low (0)	784.5	22.85	21.96	21.61
		782	22.92	21.98	21.63
		779.5	22.84	21.92	21.56
	25RB (0)	784.5	22.89	21.95	21.65
		782	22.91	21.96	21.56
		779.5	22.85	21.97	21.55
10 MHz	1RB High (49)	782	23.96	22.80	22.66
	1RB Middle (24)	782	24.03	22.89	22.84
	1RB Low (0)	782	23.98	22.78	22.76
	25RB High (25)	782	23.05	22.14	21.73
	25RB Middle (12)	782	22.97	22.05	21.62
	25RB Low (0)	782	22.83	21.92	21.52
	50RB (0)	782	22.94	21.98	21.59

Band 14					
Bandwidth (MHz)	RB allocation	Frequency (MHz)	QPSK	16QAM	64QAM
	RB offset (Start RB)		Actual output power (dBm)	Actual output power (dBm)	Actual output power (dBm)
5 MHz	1RB High (24)	795.5	23.96	23.03	22.60
		793	23.98	23.14	22.60
		790.5	23.90	23.46	22.67
	1RB Middle (12)	795.5	24.23	23.32	22.97
		793	24.20	23.37	22.92
		790.5	24.15	23.72	23.04
	1RB Low (0)	795.5	23.95	23.06	22.74
		793	24.03	23.17	22.77
		790.5	23.91	23.37	22.57
	12RB High (13)	795.5	23.04	22.10	21.57
		793	23.06	22.19	21.60
		790.5	22.97	22.17	21.53
	12RB Middle (6)	795.5	23.12	22.17	21.62
		793	23.07	22.24	21.70
		790.5	23.06	22.25	21.64
	12RB Low (0)	795.5	23.01	22.09	21.55
		793	23.00	22.15	21.63
		790.5	23.03	22.22	21.64
	25RB (0)	795.5	23.03	22.04	21.54
		793	23.05	22.17	21.60
		790.5	23.03	22.18	21.59
10 MHz	1RB High (49)	793	24.01	22.99	22.68
	1RB Middle (24)	793	24.18	23.08	22.85
	1RB Low (0)	793	24.05	22.98	22.74
	25RB High (25)	793	23.23	22.29	21.68
	25RB Middle (12)	793	23.16	22.26	21.69
	25RB Low (0)	793	23.17	22.22	21.68
	50RB (0)	793	23.23	22.24	21.70

Band 17						
Bandwidth (MHz)	RB allocation	Frequency (MHz)	QPSK	16QAM	64QAM	
	RB offset (Start RB)		Actual output power (dBm)	Actual output power (dBm)	Actual output power (dBm)	
5 MHz	1RB High (24)	713.5	24.34	23.88	22.79	
		710	24.37	23.43	22.34	
		706.5	24.37	23.52	22.43	
	1RB Middle (12)	713.5	24.63	24.09	23.00	
		710	24.65	23.70	22.61	
		706.5	24.63	23.82	22.73	
	1RB Low (0)	713.5	24.34	23.80	22.71	
		710	24.36	23.46	22.37	
		706.5	24.37	23.53	22.44	
	12RB High (13)	713.5	23.37	22.47	21.38	
		710	23.45	22.41	21.32	
		706.5	23.58	22.57	21.48	
	12RB Middle (6)	713.5	23.58	22.59	21.50	
		710	23.54	22.50	21.41	
		706.5	23.54	22.60	21.51	
	12RB Low (0)	713.5	23.50	22.60	21.51	
		710	23.44	22.43	21.34	
		706.5	23.48	22.52	21.43	
	25RB (0)	713.5	23.50	22.48	21.39	
		710	23.44	22.34	21.25	
		706.5	23.55	22.54	21.45	
	10 MHz	1RB High (49)	711	24.42	23.48	22.39
			710	24.47	23.86	22.77
			709	24.48	23.48	22.39
1RB Middle (24)		711	24.60	23.53	22.44	
		710	24.65	23.94	22.85	
		709	24.61	23.60	22.51	
1RB Low (0)		711	24.42	23.49	22.40	
		710	24.49	23.89	22.80	
		709	24.46	23.53	22.44	
25RB High (25)		711	23.34	22.33	21.54	
		710	23.38	22.35	21.56	
		709	23.47	22.49	21.70	
25RB Middle (12)		711	23.58	22.58	21.79	
		710	23.57	22.56	21.77	
		709	23.57	22.63	21.84	
25RB Low (0)		711	23.46	22.49	21.70	
		710	23.47	22.50	21.71	
		709	23.45	22.53	21.74	
50RB (0)		711	23.46	22.42	21.63	
		710	23.44	22.43	21.64	
		709	23.47	22.49	21.70	

Band 25					
Bandwidth (MHz)	RB allocation	Frequency (MHz)	QPSK	16QAM	64QAM
	RB offset (Start RB)		Actual output power (dBm)	Actual output power (dBm)	Actual output power (dBm)
1.4 MHz	1RB High (5)	1914.3	24.21	23.22	23.23
		1882.5	24.23	23.32	23.12
		1850.7	24.36	23.69	23.24
	1RB Middle (3)	1914.3	24.39	23.33	23.32
		1882.5	24.42	23.52	23.30
		1850.7	24.52	23.89	23.44
	1RB Low (0)	1914.3	24.23	23.20	23.22
		1882.5	24.25	23.34	23.09
		1850.7	24.33	23.70	23.20
	3RB High (3)	1914.3	24.34	23.49	23.25
		1882.5	24.28	23.33	23.20
		1850.7	24.48	23.65	23.14
	3RB Middle (1)	1914.3	24.38	23.53	23.26
		1882.5	24.33	23.39	23.16
		1850.7	24.52	23.63	23.26
	3RB Low (0)	1914.3	24.35	23.50	23.29
		1882.5	24.27	23.35	23.08
		1850.7	24.49	23.64	23.20
	6RB (0)	1914.3	23.31	22.42	22.24
		1882.5	23.24	22.40	22.06
		1850.7	23.40	22.32	22.13
3 MHz	1RB High (14)	1913.5	24.29	23.60	23.33
		1882.5	24.31	23.08	23.27
		1851.5	24.40	23.72	23.31
	1RB Middle (7)	1913.5	24.44	23.67	23.49
		1882.5	24.42	23.27	23.38
		1851.5	24.59	23.90	23.44
	1RB Low (0)	1913.5	24.31	23.67	23.36
		1882.5	24.25	23.25	23.26
		1851.5	24.44	23.77	23.29
	8RB High (7)	1913.5	23.32	22.60	22.25
		1882.5	23.23	22.36	22.09
		1851.5	23.37	22.43	22.11
	8RB Middle (4)	1913.5	23.40	22.59	22.36
		1882.5	23.34	22.43	22.17
		1851.5	23.45	22.54	22.18
	8RB Low (0)	1913.5	23.38	22.61	22.27
		1882.5	23.31	22.40	22.11
		1851.5	23.43	22.52	22.17
	15RB (0)	1913.5	23.35	22.60	22.23
		1882.5	23.31	22.32	22.05
		1851.5	23.39	22.40	22.05
5 MHz	1RB High (24)	1912.5	24.25	23.23	23.18
		1882.5	24.33	23.38	23.13



	1RB Middle (12)	1852.5	24.24	23.76	23.12	
		1912.5	24.49	23.49	23.38	
		1882.5	24.56	23.59	23.38	
	1RB Low (0)	1852.5	24.53	24.04	23.36	
		1912.5	24.26	23.29	23.27	
		1882.5	24.29	23.40	23.11	
	12RB High (13)	1852.5	24.31	23.82	23.22	
		1912.5	23.26	22.34	22.21	
		1882.5	23.28	22.36	22.05	
	12RB Middle (6)	1852.5	23.39	22.48	22.11	
		1912.5	23.40	22.50	22.34	
		1882.5	23.37	22.43	22.08	
	12RB Low (0)	1852.5	23.48	22.59	22.16	
		1912.5	23.37	22.45	22.28	
		1882.5	23.35	22.37	22.12	
	25RB (0)	1852.5	23.35	22.47	22.09	
		1912.5	23.34	22.34	22.22	
		1882.5	23.34	22.34	22.11	
	10 MHz	1RB High (49)	1852.5	23.38	22.47	22.07
			1910	23.34	22.34	22.22
			1882.5	23.34	22.34	22.11
		1RB Middle (24)	1910	24.26	23.20	23.32
			1882.5	24.27	23.19	23.15
			1855	24.33	23.71	23.24
		1RB Low (0)	1910	24.38	23.43	23.43
			1882.5	24.41	23.34	23.43
			1855	24.49	23.82	23.40
		25RB High (25)	1910	24.22	23.35	23.37
			1882.5	24.24	23.24	23.32
			1855	24.40	23.74	23.28
25RB Middle (12)		1910	23.22	22.42	22.15	
		1882.5	23.33	22.36	22.14	
		1855	23.49	22.56	22.16	
25RB Low (0)		1910	23.42	22.57	22.30	
		1882.5	23.40	22.42	22.15	
		1855	23.47	22.53	22.17	
50RB (0)		1910	23.42	22.54	22.31	
		1882.5	23.42	22.47	22.20	
		1855	23.40	22.46	22.11	
15 MHz		1RB High (74)	1910	23.38	22.46	22.23
			1882.5	23.42	22.41	22.17
			1855	23.50	22.52	22.14
		1RB Middle (37)	1907.5	24.27	23.53	23.31
			1882.5	24.17	23.18	23.17
			1857.5	24.29	23.69	23.20
		1RB Low (0)	1907.5	24.30	23.77	23.37
			1882.5	24.32	23.26	23.22
			1857.5	24.38	23.73	23.31
		1907.5	24.14	23.71	23.32	
		1882.5	24.22	23.26	23.16	

	36RB High (38)	1857.5	24.41	23.75	23.23	
		1907.5	23.30	22.29	22.19	
		1882.5	23.35	22.29	22.11	
	36RB Middle (19)	1857.5	23.41	22.49	22.12	
		1907.5	23.39	22.37	22.28	
		1882.5	23.44	22.38	22.16	
	36RB Low (0)	1857.5	23.46	22.45	22.14	
		1907.5	23.26	22.31	22.22	
		1882.5	23.41	22.42	22.16	
	75RB (0)	1857.5	23.42	22.44	22.12	
		1907.5	23.33	22.38	22.19	
		1882.5	23.41	22.40	22.11	
20 MHz	1RB High (99)	1857.5	23.43	22.44	22.11	
		1907.5	23.33	22.38	22.19	
		1882.5	23.41	22.40	22.11	
	1RB Middle (50)	1905	24.19	23.51	23.21	
		1882.5	24.07	23.55	23.16	
		1860	24.18	23.70	23.13	
	1RB Low (0)	1905	24.47	23.95	23.46	
		1882.5	24.39	23.80	23.32	
		1860	24.50	24.02	23.44	
	50RB High (50)	1905	24.11	23.62	23.13	
		1882.5	24.17	23.63	23.20	
		1860	24.24	23.77	23.15	
	50RB Middle (25)	1905	23.21	22.26	22.11	
		1882.5	23.25	22.24	22.06	
		1860	23.43	22.52	22.11	
	50RB Low (0)	1905	23.38	22.41	22.25	
		1882.5	23.38	22.31	22.15	
		1860	23.40	22.45	22.11	
	100RB (0)	1905	23.25	22.32	22.12	
		1882.5	23.42	22.36	22.19	
		1860	23.32	22.38	22.03	
			1905	23.20	22.26	22.15
			1882.5	23.33	22.32	22.13
			1860	23.39	22.49	22.08

Band 26						
Bandwidth (MHz)	RB allocation RB offset (Start RB)	Frequency (MHz)	QPSK	16QAM	64QAM	
			Actual output power (dBm)	Actual output power (dBm)	Actual output power (dBm)	
1.4 MHz	1RB High (5)	848.3	25.08	23.97	23.75	
		831.5	25.11	24.14	23.76	
		814.7	25.05	24.34	23.68	
	1RB Middle (3)	848.3	25.28	24.14	23.83	
		831.5	25.28	24.37	23.87	
		814.7	25.26	24.36	23.71	
	1RB Low (0)	848.3	25.06	24.01	23.78	
		831.5	25.09	24.17	23.87	
		814.7	25.11	24.38	23.76	
	3RB High (3)	848.3	25.12	24.17	23.70	
		831.5	25.17	24.18	23.84	
		814.7	25.10	24.25	23.68	
	3RB Middle (1)	848.3	25.14	24.22	23.77	
		831.5	25.18	24.21	23.82	
		814.7	25.21	24.29	23.71	
	3RB Low (0)	848.3	25.09	24.16	23.77	
		831.5	25.15	24.16	23.81	
		814.7	25.11	24.24	23.70	
	6RB (0)	848.3	24.21	23.30	22.75	
		831.5	24.14	23.27	22.70	
		814.7	24.16	23.07	22.58	
	3 MHz	1RB High (14)	847.5	25.10	24.37	23.83
			831.5	25.10	24.07	23.88
			815.5	25.12	24.07	23.55
		1RB Middle (7)	847.5	25.24	24.50	23.97
			831.5	25.21	24.27	23.96
			815.5	25.19	24.24	23.67
1RB Low (0)		847.5	25.11	24.35	23.84	
		831.5	25.06	24.17	23.80	
		815.5	25.07	24.11	23.48	
8RB High (7)		847.5	24.12	23.10	22.72	
		831.5	24.11	23.16	22.74	
		815.5	24.08	23.16	22.38	
8RB Middle (4)		847.5	24.18	23.17	22.78	
		831.5	24.16	23.19	22.76	
		815.5	24.12	23.20	22.45	
8RB Low (0)		847.5	24.16	23.18	22.74	
		831.5	24.10	23.16	22.69	
		815.5	24.10	23.17	22.40	
15RB (0)		847.5	24.10	23.07	22.73	
		831.5	24.10	23.09	22.67	
		815.5	24.11	23.05	22.35	
5 MHz		1RB High (24)	846.5	25.08	24.06	23.67
			831.5	25.10	24.18	23.76

		816.5	25.03	24.33	23.64		
		1RB Middle (12)	846.5	25.24	24.29	24.02	
			831.5	25.33	24.41	24.01	
		1RB Low (0)	816.5	25.18	24.38	23.86	
			846.5	25.08	24.10	23.77	
			831.5	25.10	24.17	23.74	
		12RB High (13)	816.5	25.06	24.49	23.70	
			846.5	24.03	23.02	22.69	
			831.5	24.11	23.21	22.72	
		12RB Middle (6)	816.5	24.10	23.19	22.59	
			846.5	24.10	23.13	22.75	
			831.5	24.10	23.21	22.76	
		12RB Low (0)	816.5	24.06	23.21	22.59	
			846.5	24.12	23.16	22.77	
			831.5	24.10	23.15	22.70	
		25RB (0)	816.5	24.02	23.13	22.53	
			846.5	24.04	23.00	22.75	
			831.5	24.08	23.15	22.71	
			816.5	24.05	23.14	22.54	
			1RB High (49)	844	25.12	24.30	23.74
				831.5	25.04	24.06	23.86
	820	25.08		24.00	23.72		
		1RB Middle (24)	844	25.17	24.47	23.96	
			831.5	25.16	24.18	23.99	
			820	25.12	24.03	23.83	
		1RB Low (0)	844	25.04	24.35	23.81	
			831.5	25.01	24.00	23.75	
			820	25.00	23.95	23.74	
		25RB High (25)	844	23.98	23.03	22.72	
			831.5	24.17	23.28	22.78	
820			24.07	23.12	22.66		
	25RB Middle (12)	844	24.06	23.14	22.77		
		831.5	24.09	23.24	22.74		
		820	24.09	23.17	22.65		
	25RB Low (0)	844	24.14	23.17	22.81		
		831.5	24.12	23.25	22.72		
		820	23.98	23.06	22.58		
	50RB (0)	844	24.07	23.06	22.74		
		831.5	24.13	23.19	22.76		
		820	24.05	23.06	22.60		
10 MHz	1RB High (74)	841.5	25.02	23.84	23.76		
		831.5	25.06	24.31	23.81		
		822.5	25.09	24.40	23.75		
	1RB Middle (37)	841.5	25.07	23.93	23.78		
		831.5	25.18	24.44	23.91		
		822.5	25.11	24.43	23.72		
1RB Low (0)	841.5	24.98	23.86	23.83			
	831.5	25.08	24.32	23.78			
15 MHz	1RB High (74)	841.5	25.02	23.84	23.76		
		831.5	25.06	24.31	23.81		
		822.5	25.09	24.40	23.75		
	1RB Middle (37)	841.5	25.07	23.93	23.78		
		831.5	25.18	24.44	23.91		
		822.5	25.11	24.43	23.72		
1RB Low (0)	841.5	24.98	23.86	23.83			
	831.5	25.08	24.32	23.78			



		822.5	24.97	24.28	23.65
	36RB High (38)	841.5	24.14	23.07	22.67
		831.5	24.17	23.19	22.73
		822.5	24.14	23.08	22.57
	36RB Middle (19)	841.5	24.18	23.11	22.73
		831.5	24.16	23.19	22.72
		822.5	24.14	23.08	22.62
	36RB Low (0)	841.5	24.13	23.06	22.72
		831.5	24.11	23.17	22.70
		822.5	24.07	23.00	22.55
	75RB (0)	841.5	24.13	23.08	22.70
		831.5	24.15	23.18	22.70
		822.5	24.05	23.09	22.54

Band 30					
Bandwidth (MHz)	RB allocation	Frequency (MHz)	QPSK	16QAM	64QAM
	RB offset (Start RB)		Actual output power (dBm)	Actual output power (dBm)	Actual output power (dBm)
5 MHz	1RB High (24)	2312.5	22.30	21.45	20.89
		2310	22.37	21.44	20.88
		2307.5	22.29	21.77	21.21
	1RB Middle (12)	2312.5	22.55	21.66	21.10
		2310	22.61	21.65	21.09
		2307.5	22.58	22.03	21.47
	1RB Low (0)	2312.5	22.33	21.41	20.85
		2310	22.38	21.43	20.87
		2307.5	22.29	21.76	21.20
	12RB High (13)	2312.5	21.38	20.40	19.84
		2310	21.36	20.35	19.79
		2307.5	21.44	20.51	19.95
	12RB Middle (6)	2312.5	21.40	20.46	19.90
		2310	21.45	20.40	19.84
		2307.5	21.45	20.53	19.97
	12RB Low (0)	2312.5	21.35	20.40	19.84
		2310	21.39	20.36	19.80
		2307.5	21.43	20.47	19.91
	25RB (0)	2312.5	21.33	20.34	19.78
		2310	21.33	20.34	19.78
		2307.5	21.39	20.42	19.86
10 MHz	1RB High (49)	2310	22.46	21.69	21.13
	1RB Middle (24)	2310	22.36	21.76	21.20
	1RB Low (0)	2310	22.34	21.67	21.11
	25RB High (25)	2310	21.42	20.39	19.83
	25RB Middle (12)	2310	21.38	20.39	19.83
	25RB Low (0)	2310	21.40	20.39	19.83
	50RB (0)	2310	21.38	20.36	19.80

Band 41-PC3					
Bandwidth (MHz)	RB allocation	Frequency (MHz)	QPSK	16QAM	64QAM
	RB offset (Start RB)		Actual output power (dBm)	Actual output power (dBm)	Actual output power (dBm)
5 MHz	1RB High (24)	2687.5	23.99	22.94	22.48
		2640.3	23.44	22.49	21.90
		2593	23.17	21.93	21.59
		2545.8	23.30	22.23	21.61
		2498.5	23.85	22.86	22.35
	1RB Middle (12)	2687.5	24.03	22.97	22.68
		2640.3	23.46	22.45	22.09
		2593	23.21	21.94	21.74
		2545.8	23.37	22.29	21.92
		2498.5	23.86	22.91	22.54
	1RB Low (0)	2687.5	23.94	22.89	22.44
		2640.3	23.36	22.41	21.97
		2593	23.15	21.92	21.54
		2545.8	23.35	22.28	21.72
		2498.5	23.88	22.89	22.35
	12RB High (13)	2687.5	23.10	22.01	21.96
		2640.3	22.48	21.46	21.40
		2593	22.18	21.08	21.10
		2545.8	22.47	21.34	21.21
		2498.5	22.96	21.91	21.83
	12RB Middle (6)	2687.5	23.13	22.06	22.03
		2640.3	22.59	21.54	21.49
		2593	22.24	21.15	21.15
		2545.8	22.55	21.44	21.30
		2498.5	23.07	22.01	21.91
	12RB Low (0)	2687.5	23.07	21.99	21.97
		2640.3	22.47	21.42	21.39
		2593	22.17	21.08	21.08
		2545.8	22.46	21.32	21.24
		2498.5	22.95	21.91	21.83
	25RB (0)	2687.5	23.04	22.03	21.99
		2640.3	22.54	21.42	21.39
		2593	22.17	21.13	21.10
		2545.8	22.46	21.45	21.25
		2498.5	23.00	21.92	21.84
	10 MHz	1RB High (49)	2685	24.12	23.05
2639			23.57	22.60	22.00
2593			23.29	22.08	21.72

		2547	23.39	22.30	21.66
		2501	23.90	22.94	22.42
	1RB Middle (24)	2685	24.32	23.24	22.66
		2639	23.81	22.82	22.21
		2593	23.56	22.35	21.78
		2547	23.73	22.61	21.90
		2501	24.32	23.27	22.63
		2685	24.00	22.87	22.50
	1RB Low (0)	2639	23.47	22.48	22.04
		2593	23.31	22.08	21.70
		2547	23.50	22.40	21.90
		2501	23.99	23.07	22.45
		2685	23.08	22.10	22.04
	25RB High (25)	2639	22.58	21.51	21.38
		2593	22.23	21.15	21.17
		2547	22.48	21.43	21.27
		2501	22.98	21.93	21.90
	25RB Middle (12)	2685	23.09	22.08	22.01
		2639	22.57	21.53	21.53
		2593	22.21	21.14	21.19
		2547	22.53	21.49	21.34
		2501	23.02	21.94	21.89
	25RB Low (0)	2685	23.09	22.07	21.98
		2639	22.58	21.51	21.52
2593		22.28	21.20	21.17	
2547		22.55	21.54	21.37	
2501		23.07	21.99	21.92	
50RB (0)	2685	23.09	22.11	21.98	
	2639	22.56	21.55	21.43	
	2593	22.28	21.20	21.15	
	2547	22.54	21.55	21.35	
	2501	23.00	21.99	21.85	
15 MHz	1RB High (74)	2682.5	24.03	22.95	22.48
		2637.8	23.47	22.47	21.96
		2593	23.17	21.96	21.61
		2548.3	23.32	22.21	21.52
		2503.5	23.73	22.75	22.33
	1RB Middle (37)	2682.5	24.12	22.99	22.51
		2637.8	23.57	22.57	22.09
		2593	23.34	22.13	21.71
		2548.3	23.51	22.38	21.78



		2503.5	23.98	22.96	22.52
	1RB Low (0)	2682.5	23.92	22.81	22.36
		2637.8	23.35	22.32	21.95
		2593	23.26	22.05	21.60
		2548.3	23.49	22.37	21.85
		2503.5	23.91	22.98	22.37
	36RB High (38)	2682.5	23.12	22.07	21.91
		2637.8	22.66	21.56	21.38
		2593	22.28	21.16	21.10
		2548.3	22.44	21.37	21.08
		2503.5	23.01	21.92	21.82
	36RB Middle (19)	2682.5	23.14	22.09	21.90
		2637.8	22.62	21.52	21.43
		2593	22.32	21.20	21.12
		2548.3	22.53	21.39	21.22
		2503.5	23.06	21.96	21.83
	36RB Low (0)	2682.5	23.09	22.00	21.84
		2637.8	22.58	21.46	21.41
		2593	22.29	21.14	21.09
		2548.3	22.55	21.41	21.28
		2503.5	23.04	21.97	21.78
	75RB (0)	2682.5	23.09	22.10	21.90
		2637.8	22.58	21.47	21.38
		2593	22.29	21.20	21.10
		2548.3	22.50	21.44	21.24
2503.5		23.02	21.96	21.77	
20 MHz	1RB High (99)	2680	24.05	22.92	22.44
		2636.5	23.54	22.30	21.92
		2593	23.14	22.10	21.59
		2549.5	23.22	22.11	21.42
		2506	23.72	22.52	22.23
	1RB Middle (50)	2680	24.25	23.09	22.55
		2636.5	23.74	22.48	22.16
		2593	23.38	22.36	21.76
		2549.5	23.57	22.49	21.85
		2506	24.15	22.87	22.60
	1RB Low (0)	2680	23.83	22.77	22.24
		2636.5	23.37	22.11	21.90
		2593	23.16	22.15	21.54
		2549.5	23.43	22.30	21.78
		2506	23.93	22.70	22.33
	50RB	2680	23.03	22.01	21.85

	High (50)	2636.5	22.53	21.46	21.29
		2593	22.18	21.19	21.08
		2549.5	22.32	21.29	21.13
		2506	22.85	21.84	21.81
	50RB Middle (25)	2680	22.99	22.00	21.86
		2636.5	22.53	21.46	21.32
		2593	22.23	21.24	21.14
		2549.5	22.43	21.46	21.29
		2506	22.92	21.90	21.83
	50RB Low (0)	2680	22.95	21.90	21.84
		2636.5	22.42	21.38	21.35
		2593	22.20	21.21	21.08
		2549.5	22.44	21.44	21.30
		2506	22.90	21.89	21.80
	100RB (0)	2680	22.98	21.98	21.85
		2636.5	22.43	21.39	21.38
		2593	22.19	21.16	21.11
		2549.5	22.42	21.39	21.20
		2506	22.87	21.83	21.80

Band 41-PC2					
Bandwidth (MHz)	RB allocation	Frequency (MHz)	QPSK	16QAM	64QAM
	RB offset (Start RB)		Actual output power (dBm)	Actual output power (dBm)	Actual output power (dBm)
5 MHz	1RB High (24)	2687.5	27.00	26.29	25.82
		2640.3	26.40	25.83	25.25
		2593	26.14	25.37	24.89
		2545.8	26.33	25.66	24.99
		2498.5	26.87	26.24	25.66
	1RB Middle (12)	2687.5	27.28	26.39	25.91
		2640.3	26.68	26.10	25.35
		2593	26.45	25.68	24.99
		2545.8	26.69	26.01	25.15
		2498.5	27.20	26.47	25.78
	1RB Low (0)	2687.5	26.92	26.25	25.77
		2640.3	26.34	25.77	25.24
		2593	26.16	25.39	24.89
		2545.8	26.40	25.73	25.07
		2498.5	26.90	26.35	25.66
	12RB High (13)	2687.5	26.12	25.14	25.00
		2640.3	25.54	24.64	24.38
		2593	25.27	24.26	24.08
		2545.8	25.52	24.50	24.23
		2498.5	26.02	25.08	24.77
	12RB Middle (6)	2687.5	26.11	25.17	25.02
		2640.3	25.60	24.68	24.48
		2593	25.28	24.26	24.09
		2545.8	25.54	24.52	24.30
		2498.5	26.08	25.12	24.80
	12RB Low (0)	2687.5	26.15	25.16	24.96
		2640.3	25.52	24.58	24.42
		2593	25.21	24.23	24.07
		2545.8	25.55	24.47	24.20
		2498.5	26.06	25.06	24.81
	25RB (0)	2687.5	26.14	25.21	25.00
		2640.3	25.58	24.60	24.43
		2593	25.26	24.27	24.11
		2545.8	25.54	24.55	24.27
		2498.5	26.05	24.99	24.86
	10 MHz	1RB High (49)	2685	27.08	26.49
2639			26.45	25.90	25.31
2593			26.28	25.48	24.98

		2547	26.38	25.89	25.00
		2501	26.84	26.29	25.73
	1RB Middle (24)	2685	27.10	26.31	25.96
		2639	26.53	25.95	25.46
		2593	26.35	25.55	25.08
		2547	26.50	26.01	25.21
		2501	27.01	26.41	25.88
		2685	26.96	26.38	25.78
	1RB Low (0)	2639	26.34	25.78	25.36
		2593	26.28	25.51	24.99
		2547	26.50	25.98	25.23
		2501	26.94	26.40	25.77
		2685	26.16	25.20	25.05
	25RB High (25)	2639	25.59	24.68	24.48
		2593	25.27	24.30	24.18
		2547	25.56	24.56	24.28
		2501	26.02	25.04	24.92
	25RB Middle (12)	2685	26.13	25.19	25.05
		2639	25.60	24.62	24.54
		2593	25.28	24.27	24.18
		2547	25.59	24.62	24.35
		2501	26.06	25.09	24.90
	25RB Low (0)	2685	26.08	25.15	25.02
		2639	25.58	24.61	24.55
2593		25.29	24.32	24.18	
2547		25.58	24.61	24.40	
2501		26.11	25.10	24.94	
50RB (0)	2685	26.13	25.19	24.99	
	2639	25.59	24.61	24.49	
	2593	25.31	24.31	24.16	
	2547	25.58	24.63	24.26	
	2501	26.03	25.09	24.87	
15 MHz	1RB High (74)	2682.5	27.07	26.42	25.78
		2637.8	26.43	25.72	25.25
		2593	26.20	25.36	24.93
		2548.3	26.31	25.82	24.88
		2503.5	26.71	26.09	25.64
	1RB Middle (37)	2682.5	27.09	26.46	25.81
		2637.8	26.44	25.79	25.39
		2593	26.32	25.51	25.00
		2548.3	26.52	26.02	25.12

		2503.5	26.93	26.29	25.79
	1RB Low (0)	2682.5	26.88	26.29	25.66
		2637.8	26.26	25.60	25.28
		2593	26.30	25.44	24.89
		2548.3	26.50	25.96	25.16
		2503.5	26.86	26.23	25.63
	36RB High (38)	2682.5	26.14	25.13	24.85
		2637.8	25.64	24.57	24.35
		2593	25.27	24.22	24.05
		2548.3	25.45	24.43	24.03
		2503.5	26.03	24.96	24.77
	36RB Middle (19)	2682.5	26.18	25.12	24.88
		2637.8	25.64	24.57	24.40
		2593	25.34	24.26	24.06
		2548.3	25.57	24.51	24.15
		2503.5	26.07	25.02	24.80
	36RB Low (0)	2682.5	26.07	25.03	24.83
		2637.8	25.57	24.48	24.37
		2593	25.30	24.18	24.06
		2548.3	25.56	24.49	24.21
		2503.5	26.06	25.02	24.74
	75RB (0)	2682.5	26.16	25.12	24.87
		2637.8	25.62	24.52	24.39
		2593	25.29	24.27	24.08
		2548.3	25.53	24.49	24.21
2503.5		26.05	24.99	24.81	
20 MHz	1RB High (99)	2680	27.04	26.26	25.66
		2636.5	26.45	25.59	25.12
		2593	26.09	25.55	24.88
		2549.5	26.26	25.55	24.74
		2506	26.68	25.92	25.53
	1RB Middle (50)	2680	27.32	25.94	25.83
		2636.5	26.75	25.88	25.41
		2593	26.48	25.92	25.10
		2549.5	26.78	26.07	25.19
		2506	27.23	26.39	25.88
	1RB Low (0)	2680	26.79	26.07	25.50
		2636.5	26.27	25.44	25.21
		2593	26.14	25.58	24.85
		2549.5	26.43	25.71	25.12
		2506	26.89	26.11	25.63
	50RB	2680	26.09	25.10	24.80

	High (50)	2636.5	25.56	24.58	24.35
		2593	25.22	24.28	24.02
		2549.5	25.39	24.42	23.96
		2506	25.90	24.93	24.74
	50RB Middle (25)	2680	26.06	25.07	24.80
		2636.5	25.57	24.56	24.45
		2593	25.30	24.37	24.11
		2549.5	25.52	24.56	24.17
		2506	25.99	24.98	24.81
	50RB Low (0)	2680	25.98	24.97	24.76
		2636.5	25.47	24.48	24.40
		2593	25.22	24.31	24.04
		2549.5	25.53	24.54	24.24
		2506	26.00	24.96	24.79
	100RB (0)	2680	26.06	25.06	24.82
		2636.5	25.48	24.54	24.39
		2593	25.28	24.27	24.06
		2549.5	25.49	24.51	24.13
		2506	25.97	24.94	24.80

Band 66						
Bandwidth (MHz)	RB allocation	Frequency (MHz)	QPSK	16QAM	64QAM	
	RB offset (Start RB)		Actual output power (dBm)	Actual output power (dBm)	Actual output power (dBm)	
1.4 MHz	1RB High (5)	1779.3	24.77	23.88	23.65	
		1745	24.92	24.26	23.86	
		1710.7	24.82	23.97	23.86	
	1RB Middle (3)	1779.3	24.95	24.03	23.75	
		1745	25.08	24.45	23.94	
		1710.7	25.06	24.19	24.00	
	1RB Low (0)	1779.3	24.82	23.87	23.69	
		1745	24.90	24.31	23.82	
		1710.7	24.84	23.96	23.87	
	3RB High (3)	1779.3	24.90	23.92	23.62	
		1745	25.03	24.22	23.81	
		1710.7	25.07	24.23	19.22	
	3RB Middle (1)	1779.3	24.95	23.93	23.67	
		1745	25.11	24.21	23.88	
		1710.7	25.06	24.25	23.90	
	3RB Low (0)	1779.3	24.91	23.90	23.64	
		1745	25.03	24.19	23.77	
		1710.7	25.00	24.23	23.86	
	6RB (0)	1779.3	23.80	22.99	22.57	
		1745	23.96	22.91	22.71	
		1710.7	23.96	23.19	22.82	
	3 MHz	1RB High (14)	1778.5	24.81	23.75	23.72
			1745	25.01	24.38	23.89
			1711.5	24.94	24.00	23.93
1RB Middle (7)		1778.5	24.92	23.84	23.84	
		1745	25.11	24.48	23.97	
		1711.5	25.08	24.18	24.12	
1RB Low (0)		1778.5	24.75	23.75	23.74	
		1745	24.98	24.36	23.89	
		1711.5	24.98	24.08	23.97	
8RB High (7)		1778.5	23.80	22.95	22.63	
		1745	23.94	23.03	22.71	
		1711.5	23.98	23.05	22.85	
8RB Middle (4)		1778.5	23.86	23.00	22.64	
		1745	23.97	23.10	22.79	
		1711.5	24.03	23.11	22.87	
8RB Low (0)		1778.5	23.84	22.97	22.61	
		1745	23.95	23.07	22.78	
		1711.5	23.99	23.03	22.81	
15RB (0)		1778.5	23.84	22.90	22.53	
		1745	23.99	23.01	22.69	
		1711.5	24.01	22.99	22.76	
5 MHz		1RB High (24)	1777.5	24.78	23.88	23.56
			1745	24.88	24.40	23.75

	1RB Middle (12)	1712.5	24.94	24.02	23.86	
		1777.5	25.07	24.09	23.79	
		1745	25.07	24.43	24.02	
	1RB Low (0)	1712.5	25.17	24.30	24.11	
		1777.5	24.84	23.92	23.71	
		1745	24.87	24.37	23.86	
	12RB High (13)	1712.5	24.91	24.00	23.87	
		1777.5	23.79	22.93	22.57	
		1745	23.98	23.10	22.74	
	12RB Middle (6)	1712.5	24.01	23.12	22.81	
		1777.5	23.89	23.01	22.63	
		1745	24.00	23.15	22.79	
	12RB Low (0)	1712.5	24.08	23.13	22.86	
		1777.5	23.85	22.91	22.60	
		1745	23.96	23.11	22.72	
	25RB (0)	1712.5	23.97	23.08	22.82	
		1777.5	23.86	22.92	22.55	
		1745	23.98	23.06	22.70	
	10 MHz	1RB High (49)	1712.5	24.01	23.03	22.81
			1777.5	23.86	22.92	22.55
			1745	23.98	23.06	22.70
		1RB Middle (24)	1775	24.75	23.72	23.65
			1745	24.93	24.30	23.87
			1715	24.94	24.05	23.93
		1RB Low (0)	1775	24.95	23.87	23.87
			1745	25.08	24.46	23.96
			1715	25.04	24.12	24.01
25RB High (25)		1775	24.76	23.76	23.73	
		1745	24.96	24.29	23.85	
		1715	24.90	23.98	23.98	
25RB Middle (12)		1775	24.90	23.98	23.98	
		1745	23.86	22.95	22.59	
		1715	24.08	23.25	22.85	
25RB Low (0)		1775	24.08	23.25	22.85	
		1745	23.93	22.99	22.67	
		1715	24.06	23.10	22.78	
50RB (0)		1775	24.08	23.24	22.84	
		1745	23.97	22.99	22.69	
		1715	24.05	23.19	22.82	
15 MHz		1RB High (74)	1775	24.05	23.19	22.82
			1745	23.99	23.03	22.78
			1715	24.05	23.19	22.82
		1RB Middle (37)	1775	23.92	22.95	22.63
			1745	24.00	23.02	22.73
			1715	24.10	23.16	22.85
	1RB Low (0)	1772.5	24.65	23.65	23.63	
		1745	24.86	24.22	23.76	
		1717.5	24.87	24.29	23.82	
	1RB Low (0)	1772.5	24.80	23.79	23.76	
		1745	24.99	24.33	23.83	
		1717.5	24.96	24.36	23.94	
1RB Low (0)	1772.5	24.81	23.72	23.73		
	1745	24.89	24.28	23.73		



	36RB High (38)	1717.5	24.92	24.30	23.92	
		1772.5	23.88	22.82	22.55	
		1745	23.93	22.97	22.67	
	36RB Middle (19)	1717.5	24.03	22.98	22.79	
		1772.5	23.87	22.86	22.61	
		1745	23.94	22.97	22.68	
	36RB Low (0)	1717.5	24.06	23.01	22.82	
		1772.5	23.90	22.87	22.63	
		1745	24.00	23.01	22.75	
	75RB (0)	1717.5	24.04	23.01	22.75	
		1772.5	23.95	22.90	22.60	
		1745	23.98	22.95	22.69	
	20 MHz	1RB High (99)	1717.5	24.08	23.04	22.74
			1770	24.60	24.17	23.53
			1745	24.79	24.25	23.62
1RB Middle (50)		1720	24.79	24.29	23.78	
		1770	24.93	24.45	23.81	
		1745	25.04	24.48	23.89	
1RB Low (0)		1720	25.07	24.50	24.06	
		1770	24.75	24.22	23.61	
		1745	24.80	24.24	23.65	
50RB High (50)		1720	24.80	24.24	23.82	
		1770	23.77	22.77	22.47	
		1745	23.89	22.93	22.62	
50RB Middle (25)		1720	23.98	23.00	22.67	
		1770	23.87	22.86	22.55	
		1745	23.92	22.96	22.67	
50RB Low (0)		1720	24.03	23.08	22.81	
		1770	23.88	22.92	22.62	
		1745	23.98	22.98	22.70	
100RB (0)		1720	24.05	23.04	22.79	
		1770	23.81	22.85	22.57	
		1745	23.90	22.94	22.65	
			1720	24.01	23.04	22.76

Band 71						
Bandwidth (MHz)	RB allocation	Frequency (MHz)	QPSK	16QAM	64QAM	
	RB offset (Start RB)		Actual output power (dBm)	Actual output power (dBm)	Actual output power (dBm)	
5 MHz	1RB High (24)	695.5	24.92	24.03	23.81	
		680.5	24.97	24.13	23.69	
		665.5	24.99	24.46	23.77	
	1RB Middle (12)	695.5	25.14	24.27	24.01	
		680.5	25.25	24.41	24.07	
		665.5	25.22	24.37	24.03	
	1RB Low (0)	695.5	24.90	24.04	23.74	
		680.5	24.98	24.20	23.78	
		665.5	24.94	24.24	23.82	
	12RB High (13)	695.5	24.04	23.10	22.72	
		680.5	24.08	23.15	22.67	
		665.5	24.16	23.28	22.73	
	12RB Middle (6)	695.5	24.08	23.12	22.74	
		680.5	24.12	23.22	22.74	
		665.5	24.16	23.28	22.79	
	12RB Low (0)	695.5	24.04	23.09	22.71	
		680.5	24.04	23.15	22.69	
		665.5	24.08	23.18	22.61	
	25RB (0)	695.5	24.07	23.04	22.70	
		680.5	24.10	23.12	22.71	
		665.5	24.13	23.21	22.69	
	10 MHz	1RB High (49)	693	24.97	24.03	23.93
			680.5	24.88	24.36	23.73
			668	24.98	24.10	23.79
1RB Middle (24)		693	25.15	24.29	24.04	
		680.5	25.02	24.42	24.04	
		668	25.14	24.24	23.94	
1RB Low (0)		693	24.96	23.99	23.95	
		680.5	24.94	24.43	23.91	
		668	24.93	24.08	23.87	
25RB High (25)		693	24.11	23.20	22.81	
		680.5	24.09	23.18	22.71	
		668	24.17	23.25	22.72	
25RB Middle (12)		693	24.10	23.21	22.85	
		680.5	24.07	23.16	22.74	
		668	24.16	23.24	22.73	
25RB Low (0)		693	24.06	23.14	22.86	
		680.5	24.06	23.13	22.71	
		668	24.05	23.18	22.67	
50RB (0)		693	24.11	23.16	22.82	
		680.5	24.08	23.16	22.71	
		668	24.14	23.19	22.71	
15 MHz		1RB	690.5	24.94	24.33	23.82

	High (74)	680.5	24.99	24.28	23.69	
		670.5	24.90	23.95	23.75	
	1RB Middle (37)	690.5	25.05	24.33	23.83	
		680.5	25.06	24.47	23.86	
	1RB Low (0)	670.5	24.98	24.01	23.89	
		690.5	24.94	24.27	23.80	
		680.5	24.96	24.41	23.91	
	36RB High (38)	670.5	24.89	23.88	23.93	
		690.5	24.15	23.10	22.69	
		680.5	24.13	23.03	22.70	
	36RB Middle (19)	670.5	24.11	23.11	22.74	
		690.5	24.14	23.09	22.69	
		680.5	24.12	23.03	22.71	
	36RB Low (0)	670.5	24.11	23.08	22.76	
		690.5	24.11	23.05	22.69	
		680.5	24.10	23.02	22.75	
	75RB (0)	670.5	24.12	23.02	22.70	
		690.5	24.13	23.04	22.67	
		680.5	24.14	23.09	22.70	
	20 MHz	1RB High (99)	670.5	24.15	23.10	22.73
			688	24.85	24.29	23.69
			683	24.89	24.20	23.57
		1RB Middle (50)	673	24.83	24.40	23.70
			688	25.13	24.49	23.88
683			25.09	24.47	23.94	
1RB Low (0)		673	25.14	24.41	23.87	
		688	24.79	24.30	23.87	
		683	24.83	24.30	23.78	
50RB High (50)		673	24.85	24.43	23.86	
		688	23.91	22.92	22.54	
		683	23.97	22.96	22.57	
50RB Middle (25)		673	24.14	23.17	22.73	
		688	24.04	23.05	22.66	
		683	24.02	23.04	22.67	
50RB Low (0)		673	24.15	23.14	22.77	
		688	23.99	23.01	22.66	
		683	24.00	22.99	22.66	
100RB (0)		673	24.02	23.06	22.67	
		688	23.93	22.97	22.57	
		683	23.95	22.98	22.60	
			673	24.05	23.09	22.69

## Level B1

Band 2					
Bandwidth (MHz)	RB allocation	Frequency (MHz)	QPSK	16QAM	64QAM
	RB offset (Start RB)		Actual output power (dBm)	Actual output power (dBm)	Actual output power (dBm)
1.4 MHz	1RB High (5)	1909.3	11.17	10.31	10.36
		1880	11.13	10.34	10.22
		1850.7	11.31	10.76	10.25
	1RB Middle (3)	1909.3	11.19	10.42	10.46
		1880	11.30	10.54	10.31
		1850.7	11.47	10.87	10.39
	1RB Low (0)	1909.3	11.14	10.29	10.33
		1880	11.14	10.36	10.23
		1850.7	11.32	10.74	10.29
	3RB High (3)	1909.3	11.32	10.50	10.39
		1880	11.23	10.33	10.18
		1850.7	11.34	10.66	10.20
	3RB Middle (1)	1909.3	11.31	10.55	10.38
		1880	11.28	10.39	10.30
		1850.7	11.44	10.67	10.24
	3RB Low (0)	1909.3	11.28	10.48	10.32
		1880	11.21	10.35	10.18
		1850.7	11.40	10.64	10.21
	6RB (0)	1909.3	10.22	9.47	9.22
		1880	10.17	9.38	9.08
		1850.7	10.31	9.31	9.10
3 MHz	1RB High (14)	1908.5	11.21	10.27	10.50
		1880	11.20	10.26	10.31
		1851.5	11.39	10.79	10.38
	1RB Middle (7)	1908.5	11.38	10.50	10.69
		1880	11.33	10.40	10.49
		1851.5	11.53	10.94	10.48
	1RB Low (0)	1908.5	11.22	10.40	10.36
		1880	11.19	10.29	10.33
		1851.5	11.44	10.77	10.37
	8RB High (7)	1908.5	10.26	9.34	9.29
		1880	10.23	9.37	9.08
		1851.5	10.38	9.50	9.22
	8RB Middle (4)	1908.5	10.30	9.43	9.32
		1880	10.29	9.42	9.19
		1851.5	10.42	9.54	9.22
	8RB Low (0)	1908.5	10.27	9.35	9.30
		1880	10.26	9.40	9.16
		1851.5	10.37	9.54	9.16
	15RB (0)	1908.5	10.25	9.30	9.21
		1880	10.28	9.36	9.07
		1851.5	10.39	9.42	9.16

5 MHz	1RB High (24)	1907.5	11.26	10.39	10.34	
		1880	11.22	10.42	10.23	
		1852.5	11.25	10.83	10.28	
	1RB Middle (12)	1907.5	11.45	10.61	10.67	
		1880	11.43	10.65	10.48	
		1852.5	11.48	11.02	10.49	
	1RB Low (0)	1907.5	11.24	10.39	10.34	
		1880	11.20	10.39	10.18	
		1852.5	11.32	10.84	10.28	
	12RB High (13)	1907.5	10.28	9.39	9.24	
		1880	10.25	9.34	9.11	
		1852.5	10.36	9.52	9.16	
	12RB Middle (6)	1907.5	10.32	9.43	9.31	
		1880	10.29	9.38	9.16	
		1852.5	10.40	9.59	9.21	
	12RB Low (0)	1907.5	10.28	9.37	9.23	
		1880	10.31	9.39	9.15	
		1852.5	10.37	9.48	9.11	
	25RB (0)	1907.5	10.27	9.34	9.23	
		1880	10.31	9.35	9.13	
		1852.5	10.35	9.48	9.11	
	10 MHz	1RB High (49)	1905	11.23	10.36	10.47
			1880	11.21	10.30	10.35
			1855	11.40	10.78	10.29
1RB Middle (24)		1905	11.40	10.52	10.53	
		1880	11.44	10.42	10.47	
		1855	11.48	10.92	10.46	
1RB Low (0)		1905	11.22	10.41	10.44	
		1880	11.20	10.32	10.37	
		1855	11.39	10.79	10.29	
25RB High (25)		1905	10.35	9.53	9.26	
		1880	10.29	9.34	9.15	
		1855	10.51	9.53	9.24	
25RB Middle (12)		1905	10.34	9.48	9.29	
		1880	10.34	9.39	9.17	
		1855	10.47	9.48	9.20	
25RB Low (0)		1905	10.30	9.49	9.29	
		1880	10.40	9.44	9.21	
		1855	10.35	9.43	9.14	
50RB (0)		1905	10.32	9.38	9.27	
		1880	10.37	9.36	9.17	
		1855	10.42	9.47	9.19	
15 MHz		1RB High (74)	1902.5	11.24	10.64	10.43
			1880	11.14	10.77	10.27
			1857.5	11.23	10.27	10.25
	1RB Middle (37)	1902.5	11.32	10.76	10.48	
		1880	11.30	10.88	10.31	
		1857.5	11.34	10.41	10.27	

	1RB Low (0)	1902.5	11.26	10.69	10.31
		1880	11.23	10.86	10.30
		1857.5	11.30	10.36	10.34
	36RB High (38)	1902.5	10.33	9.42	9.27
		1880	10.29	9.23	9.12
		1857.5	10.41	9.39	9.18
	36RB Middle (19)	1902.5	10.33	9.40	9.26
		1880	10.34	9.31	9.18
		1857.5	10.42	9.40	9.16
	36RB Low (0)	1902.5	10.30	9.39	9.22
		1880	10.34	9.34	9.18
		1857.5	10.37	9.34	9.13
	75RB (0)	1902.5	10.28	9.35	9.21
		1880	10.32	9.33	9.16
		1857.5	10.37	9.39	9.14
20 MHz	1RB High (99)	1900	11.21	10.74	10.29
		1880	11.14	10.76	10.17
		1860	11.15	10.72	10.16
	1RB Middle (50)	1900	11.43	11.05	10.41
		1880	11.44	11.05	10.43
		1860	11.43	11.03	10.46
	1RB Low (0)	1900	11.13	10.78	10.21
		1880	11.16	10.85	10.26
		1860	11.20	10.78	10.33
	50RB High (50)	1900	10.41	9.40	9.27
		1880	10.23	9.27	9.06
		1860	10.43	9.44	9.14
	50RB Middle (25)	1900	10.43	9.44	9.22
		1880	10.37	9.41	9.17
		1860	10.44	9.46	9.17
	50RB Low (0)	1900	10.40	9.45	9.22
		1880	10.39	9.46	9.17
		1860	10.34	9.37	9.09
	100RB (0)	1900	10.41	9.40	9.23
		1880	10.26	9.33	9.11
		1860	10.41	9.41	9.13

Band 4					
Bandwidth (MHz)	RB allocation	Frequency (MHz)	Actual output power (dBm)		
	RB offset		QPSK	16QAM	64QAM
1.4 MHz	1RB_High	1754.3	12.49	11.62	11.55
		1732.5	12.49	11.68	11.45
		1710.7	12.49	11.88	11.51
	1RB_Middle	1754.3	12.66	11.74	11.66
		1732.5	12.69	11.83	11.51
		1710.7	12.65	12.06	11.62
	1RB_Low	1754.3	12.44	11.62	11.57
		1732.5	12.52	11.63	11.48
		1710.7	12.51	11.87	11.45
	3RB_High	1754.3	12.68	11.84	11.53
		1732.5	12.58	11.66	11.44
		1710.7	12.58	11.77	11.50
	3RB_Middle	1754.3	12.68	11.88	11.55
		1732.5	12.65	11.72	11.49
		1710.7	12.63	11.79	11.55
	3RB_Low	1754.3	12.65	11.83	11.50
		1732.5	12.63	11.66	11.44
		1710.7	12.60	11.81	11.48
	6RB	1754.3	11.55	10.72	10.46
		1732.5	11.58	10.71	10.40
		1710.7	11.53	10.45	10.44
3 MHz	1RB_High	1753.5	12.49	11.59	11.62
		1732.5	12.54	11.51	11.48
		1711.5	12.60	11.95	11.53
	1RB_Middle	1753.5	12.63	11.79	11.92
		1732.5	12.66	11.65	11.78
		1711.5	12.72	12.13	11.68
	1RB_Low	1753.5	12.53	11.67	11.60
		1732.5	12.53	11.52	11.49
		1711.5	12.56	11.92	11.54
	8RB_High	1753.5	11.50	10.56	10.48
		1732.5	11.47	10.65	10.39
		1711.5	11.49	10.63	10.45
	8RB_Middle	1753.5	11.54	10.66	10.54
		1732.5	11.56	10.72	10.42
		1711.5	11.55	10.66	10.47
	8RB_Low	1753.5	11.54	10.60	10.49
		1732.5	11.54	10.66	10.42
		1711.5	11.50	10.64	10.44
15RB	1753.5	11.52	10.51	10.44	
	1732.5	11.54	10.57	10.33	
	1711.5	11.50	10.58	10.37	

5 MHz	1RB_High	1752.5	12.54	11.64	11.50
		1732.5	12.49	11.67	11.35
		1712.5	12.45	11.96	11.45
	1RB_Middle	1752.5	12.74	11.88	11.75
		1732.5	12.74	11.93	11.74
		1712.5	12.71	12.25	11.69
	1RB_Low	1752.5	12.52	11.62	11.43
		1732.5	12.49	11.69	11.45
		1712.5	12.46	11.97	11.46
	12RB_High	1752.5	11.57	10.61	10.44
		1732.5	11.49	10.58	10.39
		1712.5	11.54	10.68	10.41
	12RB_Middle	1752.5	11.60	10.67	10.51
		1732.5	11.55	10.65	10.45
		1712.5	11.58	10.72	10.48
	12RB_Low	1752.5	11.53	10.55	10.45
		1732.5	11.52	10.60	10.41
		1712.5	11.48	10.65	10.38
25RB	1752.5	11.56	10.52	10.42	
	1732.5	11.55	10.59	10.36	
	1712.5	11.54	10.61	10.40	
10MHz	1RB_High	1750	12.50	11.58	11.59
		1732.5	12.51	11.47	11.50
		1715	12.60	11.96	11.41
	1RB_Middle	1750	12.58	11.65	11.72
		1732.5	12.63	11.62	11.65
		1715	12.71	12.09	11.68
	1RB_Low	1750	12.50	11.57	11.62
		1732.5	12.46	11.47	11.49
		1715	12.54	11.88	11.49
	25RB_High	1750	11.58	10.74	10.50
		1732.5	11.55	10.58	10.39
		1715	11.62	10.65	10.44
	25RB_Middle	1750	11.61	10.71	10.48
		1732.5	11.57	10.66	10.44
		1715	11.57	10.65	10.44
	25RB_Low	1750	11.57	10.69	10.49
		1732.5	11.60	10.61	10.48
		1715	11.52	10.59	10.38
50RB	1750	11.60	10.67	10.48	
	1732.5	11.58	10.57	10.41	
	1715	11.57	10.58	10.36	
15MHz	1RB_High	1747.5	12.37	11.42	11.52
		1732.5	12.49	11.87	11.46
		1717.5	12.48	11.94	11.34
	1RB_Middle	1747.5	12.51	11.54	11.61
		1732.5	12.66	12.00	11.57
1717.5	12.60	12.12	11.63		



	1RB_Low	1747.5	12.41	11.45	11.50
		1732.5	12.56	11.88	11.47
		1717.5	12.46	11.96	11.46
	36RB_High	1747.5	11.56	10.56	10.47
		1732.5	11.58	10.62	10.43
		1717.5	11.56	10.55	10.41
	36RB_Middle	1747.5	11.57	10.55	10.50
		1732.5	11.61	10.66	10.45
		1717.5	11.62	10.58	10.46
	36RB_Low	1747.5	11.55	10.55	10.48
		1732.5	11.56	10.61	10.47
		1717.5	11.50	10.50	10.42
75RB	1747.5	11.59	10.58	10.46	
	1732.5	11.52	10.58	10.41	
	1717.5	11.56	10.50	10.38	
20MHz	1RB_High	1745	12.47	12.04	11.48
		1732.5	12.43	12.05	11.34
		1720	12.42	11.83	11.42
	1RB_Middle	1745	12.69	12.33	11.79
		1732.5	12.77	12.28	11.66
		1720	12.76	12.19	11.57
	1RB_Low	1745	12.46	11.96	11.50
		1732.5	12.39	11.92	11.38
		1720	12.38	11.81	11.39
	50RB_High	1745	11.63	10.67	10.47
		1732.5	11.54	10.56	10.33
		1720	11.47	10.47	10.32
	50RB_Middle	1745	11.63	10.69	10.50
		1732.5	11.61	10.62	10.41
		1720	11.56	10.59	10.41
	50RB_Low	1745	11.58	10.62	10.47
		1732.5	11.64	10.62	10.44
		1720	11.51	10.49	10.37
	100RB	1745	11.59	10.66	10.48
		1732.5	11.55	10.60	10.42
		1720	11.50	10.51	10.34

Band 5						
Bandwidth (MHz)	RB allocation RB offset (Start RB)	Frequency (MHz)	QPSK	16QAM	64QAM	
			Actual output power (dBm)	Actual output power (dBm)	Actual output power (dBm)	
1.4 MHz	1RB High (5)	848.3	18.38	17.47	17.39	
		836.5	18.40	17.55	17.30	
		824.7	18.46	17.82	17.23	
	1RB Middle (3)	848.3	18.62	17.64	17.60	
		836.5	18.56	17.76	17.40	
		824.7	18.62	17.99	17.35	
	1RB Low (0)	848.3	18.34	17.43	17.37	
		836.5	18.39	17.55	17.40	
		824.7	18.44	17.77	17.25	
	3RB High (3)	848.3	18.56	17.67	17.43	
		836.5	18.48	17.55	17.36	
		824.7	18.46	17.72	17.19	
	3RB Middle (1)	848.3	18.60	17.72	17.43	
		836.5	18.56	17.58	17.38	
		824.7	18.53	17.73	17.31	
	3RB Low (0)	848.3	18.51	17.65	17.40	
		836.5	18.51	17.60	17.30	
		824.7	18.51	17.70	17.26	
	6RB (0)	848.3	17.47	16.69	16.27	
		836.5	17.43	16.66	16.25	
		824.7	17.46	16.43	16.14	
	3 MHz	1RB High (14)	847.5	18.47	17.46	17.53
			836.5	18.44	17.44	17.48
			825.5	18.55	17.93	17.45
		1RB Middle (7)	847.5	18.56	17.61	17.65
			836.5	18.55	17.56	17.58
			825.5	18.63	17.63	17.56
1RB Low (0)		847.5	18.46	17.55	17.49	
		836.5	18.43	17.49	17.45	
		825.5	18.49	17.86	17.36	
8RB High (7)		847.5	17.44	16.56	16.31	
		836.5	17.42	16.63	16.30	
		825.5	17.46	16.63	16.21	
8RB Middle (4)		847.5	17.51	16.63	16.36	
		836.5	17.48	16.71	16.31	
		825.5	17.51	16.71	16.27	
8RB Low (0)		847.5	17.45	16.52	16.30	
		836.5	17.46	16.66	16.29	
		825.5	17.43	16.61	16.18	
15RB (0)		847.5	17.47	16.47	16.30	
		836.5	17.48	16.56	16.21	
		825.5	17.48	16.56	16.14	
5 MHz		1RB	846.5	18.42	17.91	17.40

	High (24)	836.5	18.45	17.54	17.40	
		826.5	18.50	17.67	17.36	
	1RB Middle (12)	846.5	18.65	17.64	17.60	
		836.5	18.67	17.75	17.64	
	1RB Low (0)	826.5	18.70	17.87	17.51	
		846.5	18.37	17.86	17.32	
		836.5	18.46	17.56	17.47	
	12RB High (13)	826.5	18.43	17.60	17.31	
		846.5	17.40	16.58	16.29	
		836.5	17.44	16.56	16.28	
	12RB Middle (6)	826.5	17.46	16.60	16.25	
		846.5	17.52	16.65	16.36	
		836.5	17.52	16.61	16.35	
	12RB Low (0)	826.5	17.48	16.64	16.31	
		846.5	17.49	16.67	16.38	
		836.5	17.46	16.55	16.28	
	25RB (0)	826.5	17.47	16.59	16.23	
		846.5	17.44	16.57	16.33	
		836.5	17.46	16.50	16.29	
	10 MHz	1RB High (49)	826.5	17.51	16.58	16.21
			844	18.47	17.86	17.58
			836.5	18.51	17.52	17.65
		1RB Middle (24)	829	18.47	17.47	17.56
			844	18.48	17.95	17.69
836.5			18.62	17.68	17.72	
1RB Low (0)		829	18.67	17.55	17.73	
		844	18.68	17.86	17.58	
		836.5	18.48	17.54	17.64	
25RB High (25)		829	18.52	17.41	17.43	
		844	17.50	16.50	16.38	
		836.5	17.53	16.67	16.43	
25RB Middle (12)		829	17.50	16.64	16.43	
		844	17.53	16.56	16.47	
		836.5	17.53	16.71	16.44	
25RB Low (0)		829	17.54	16.61	16.36	
		844	17.48	16.65	16.52	
		836.5	17.49	16.66	16.42	
50RB (0)		829	17.49	16.65	16.43	
		844	17.49	16.55	16.44	
		836.5	17.49	16.62	16.40	
			829	17.48	16.63	16.41

Band 7					
Bandwidth (MHz)	RB allocation	Frequency (MHz)	QPSK	16QAM	64QAM
	RB offset (Start RB)		Actual output power (dBm)	Actual output power (dBm)	Actual output power (dBm)
5 MHz	1RB High (24)	2567.5	11.90	11.40	11.06
		2535	12.01	11.09	11.11
		2502.5	12.12	11.22	11.39
	1RB Middle (12)	2567.5	12.19	11.64	11.32
		2535	12.29	11.38	11.35
		2502.5	12.34	11.47	11.61
	1RB Low (0)	2567.5	11.89	11.35	11.03
		2535	12.01	11.15	11.20
		2502.5	12.10	11.21	11.35
	12RB High (13)	2567.5	10.94	10.04	9.98
		2535	11.06	10.06	10.08
		2502.5	11.11	10.15	10.31
	12RB Middle (6)	2567.5	11.03	10.09	10.05
		2535	11.12	10.13	10.18
		2502.5	11.16	10.18	10.34
	12RB Low (0)	2567.5	11.01	10.10	10.03
		2535	11.05	10.07	10.09
		2502.5	11.10	10.11	10.29
	25RB (0)	2567.5	10.96	10.02	10.00
		2535	11.05	9.99	10.12
		2502.5	11.10	10.10	10.31
10 MHz	1RB High (49)	2565	11.99	11.00	11.08
		2535	12.05	11.00	11.12
		2505	12.20	11.47	11.40
	1RB Middle (24)	2565	12.13	11.08	11.31
		2535	12.18	11.14	11.38
		2505	12.31	11.64	11.58
	1RB Low (0)	2565	11.97	10.98	11.19
		2535	12.04	11.02	11.26
		2505	12.18	11.47	11.44
	25RB High (25)	2565	11.01	10.08	10.02
		2535	11.12	10.11	10.15
		2505	11.22	10.24	10.40
	25RB Middle (12)	2565	11.06	10.11	10.05
		2535	11.13	10.11	10.19
		2505	11.18	10.22	10.40
	25RB Low (0)	2565	11.03	10.12	10.09
		2535	11.15	10.14	10.22
		2505	11.19	10.20	10.38
	50RB (0)	2565	11.03	10.04	10.10
		2535	11.13	10.09	10.18

		2505	11.16	10.19	10.39
15 MHz	1RB High (74)	2562.5	11.89	10.85	11.07
		2535	12.04	11.31	11.19
		2507.5	12.07	11.51	11.38
	1RB Middle (37)	2562.5	11.98	10.96	11.18
		2535	12.16	11.45	11.28
		2507.5	12.18	11.61	11.42
	1RB Low (0)	2562.5	11.91	10.84	11.08
		2535	12.07	11.36	11.32
		2507.5	12.11	11.53	11.42
	36RB High (38)	2562.5	11.05	9.98	9.97
		2535	11.11	10.09	10.10
		2507.5	11.19	10.13	10.35
	36RB Middle (19)	2562.5	11.06	10.02	10.03
		2535	11.16	10.14	10.17
		2507.5	11.17	10.14	10.35
	36RB Low (0)	2562.5	11.02	9.97	10.05
		2535	11.10	10.09	10.20
		2507.5	11.13	10.12	10.32
	75RB (0)	2562.5	10.97	9.99	9.99
		2535	11.11	10.08	10.14
		2507.5	11.15	10.13	10.31
20 MHz	1RB High (99)	2560	12.04	11.48	11.03
		2535	12.06	11.49	11.08
		2510	12.07	11.46	11.34
	1RB Middle (50)	2560	12.32	11.77	11.24
		2535	12.32	11.83	11.36
		2510	12.35	11.75	11.65
	1RB Low (0)	2560	12.06	11.49	11.15
		2535	12.07	11.55	11.30
		2510	12.05	11.43	11.34
	50RB High (50)	2560	11.02	10.02	9.93
		2535	11.11	10.09	10.04
		2510	11.17	10.14	10.34
	50RB Middle (25)	2560	11.13	10.12	10.07
		2535	11.17	10.18	10.18
		2510	11.18	10.13	10.35
	50RB Low (0)	2560	11.07	10.05	10.06
		2535	11.14	10.14	10.20
		2510	11.12	10.06	10.30
	100RB (0)	2560	11.04	10.05	9.99
		2535	11.11	10.10	10.10
		2510	11.16	10.15	10.32

Band 12						
Bandwidth (MHz)	RB allocation RB offset (Start RB)	Frequency (MHz)	QPSK	16QAM	64QAM	
			Actual output power (dBm)	Actual output power (dBm)	Actual output power (dBm)	
1.4 MHz	1RB High (5)	715.3	16.09	15.21	15.07	
		707.5	16.03	15.24	15.07	
		699.7	16.16	15.51	15.02	
	1RB Middle (3)	715.3	16.24	15.34	15.23	
		707.5	16.21	15.44	15.08	
		699.7	16.32	15.69	15.08	
	1RB Low (0)	715.3	16.00	15.10	15.08	
		707.5	16.07	15.23	15.03	
		699.7	16.11	15.47	15.04	
	3RB High (3)	715.3	16.15	15.42	15.09	
		707.5	16.21	15.26	14.97	
		699.7	16.24	15.44	15.03	
	3RB Middle (1)	715.3	16.26	15.48	15.05	
		707.5	16.17	15.30	15.02	
		699.7	16.26	15.44	15.01	
	3RB Low (0)	715.3	16.17	15.41	15.04	
		707.5	16.16	15.22	14.97	
		699.7	16.21	15.42	14.98	
	6RB (0)	715.3	15.12	14.36	13.90	
		707.5	15.04	14.35	13.81	
		699.7	15.10	14.05	13.84	
	3 MHz	1RB High (14)	714.5	16.07	15.15	15.16
			707.5	16.04	15.08	15.04
			700.5	16.15	15.53	15.05
		1RB Middle (7)	714.5	16.20	15.33	15.28
			707.5	16.18	15.21	15.20
			700.5	16.30	15.69	15.25
1RB Low (0)		714.5	16.04	15.19	15.07	
		707.5	16.02	15.14	15.03	
		700.5	16.14	15.55	14.99	
8RB High (7)		714.5	15.05	14.19	13.89	
		707.5	15.02	14.22	13.90	
		700.5	15.07	14.27	13.89	
8RB Middle (4)		714.5	15.16	14.28	13.96	
		707.5	15.07	14.31	13.91	
		700.5	15.13	14.34	13.94	
8RB Low (0)		714.5	15.08	14.21	13.95	
		707.5	15.05	14.25	13.89	
		700.5	15.07	14.28	13.86	
15RB (0)		714.5	15.07	14.14	13.85	
		707.5	15.04	14.19	13.81	

		700.5	15.09	14.20	13.84
5 MHz	1RB High (24)	713.5	16.04	15.58	14.96
		707.5	16.07	15.17	14.98
		701.5	16.11	15.26	14.96
	1RB Middle (12)	713.5	16.24	15.77	15.21
		707.5	16.28	15.43	15.21
		701.5	16.33	15.50	15.27
	1RB Low (0)	713.5	16.00	15.54	15.05
		707.5	16.02	15.15	14.90
		701.5	16.05	15.23	14.92
	12RB High (13)	713.5	14.95	14.16	13.75
		707.5	15.13	14.27	13.90
		701.5	15.05	14.17	13.82
	12RB Middle (6)	713.5	15.11	14.34	13.93
		707.5	15.10	14.25	13.88
		701.5	15.14	14.31	13.92
	12RB Low (0)	713.5	15.14	14.33	13.93
		707.5	15.04	14.18	13.84
		701.5	15.02	14.20	13.84
	25RB (0)	713.5	15.08	14.25	13.83
		707.5	15.13	14.16	13.82
		701.5	15.07	14.17	13.82
10 MHz	1RB High (49)	711	16.16	15.19	14.97
		707.5	16.18	15.51	15.04
		704	16.09	15.21	15.05
	1RB Middle (24)	711	16.25	15.29	15.16
		707.5	16.33	15.66	15.17
		704	16.27	15.36	15.11
	1RB Low (0)	711	16.00	15.08	15.08
		707.5	16.16	15.50	15.03
		704	16.12	15.20	15.07
	25RB High (25)	711	15.06	14.13	13.74
		707.5	15.28	14.39	13.90
		704	15.29	14.45	13.92
	25RB Middle (12)	711	15.26	14.32	13.87
		707.5	15.23	14.31	13.84
		704	15.23	14.39	13.86
	25RB Low (0)	711	15.10	14.21	13.83
		707.5	15.16	14.27	13.85
		704	15.23	14.36	13.89
	50RB (0)	711	15.11	14.20	13.80
		707.5	15.29	14.38	13.91
		704	15.26	14.37	13.88

Band 13					
Bandwidth (MHz)	RB allocation	Frequency (MHz)	QPSK	16QAM	64QAM
	RB offset (Start RB)		Actual output power (dBm)	Actual output power (dBm)	Actual output power (dBm)
5 MHz	1RB High (24)	784.5	15.60	14.66	14.33
		782	15.63	14.78	14.36
		779.5	15.57	15.05	14.41
	1RB Middle (12)	784.5	15.86	14.96	14.49
		782	15.87	15.02	14.59
		779.5	15.82	15.36	14.59
	1RB Low (0)	784.5	15.58	14.65	14.41
		782	15.59	14.76	14.38
		779.5	15.56	15.05	14.33
	12RB High (13)	784.5	14.72	13.74	13.26
		782	14.63	13.78	13.25
		779.5	14.63	13.80	13.22
	12RB Middle (6)	784.5	14.66	13.78	13.30
		782	14.65	13.79	13.31
		779.5	14.68	13.85	13.31
	12RB Low (0)	784.5	14.58	13.73	13.28
		782	14.63	13.78	13.27
		779.5	14.52	13.71	13.22
	25RB (0)	784.5	14.65	13.66	13.26
		782	14.66	13.74	13.30
		779.5	14.57	13.75	13.20
10 MHz	1RB High (49)	782	15.62	14.75	14.40
	1RB Middle (24)	782	15.76	14.84	14.52
	1RB Low (0)	782	15.62	14.64	14.54
	25RB High (25)	782	14.77	13.94	13.34
	25RB Middle (12)	782	14.68	13.85	13.25
	25RB Low (0)	782	14.58	13.74	13.16
	50RB (0)	782	14.69	13.81	13.28



Band 14					
Bandwidth (MHz)	RB allocation	Frequency (MHz)	QPSK	16QAM	64QAM
	RB offset (Start RB)		Actual output power (dBm)	Actual output power (dBm)	Actual output power (dBm)
5 MHz	1RB High (24)	795.5	15.59	14.66	14.22
		793	15.59	14.74	14.28
		790.5	15.56	15.08	14.33
	1RB Middle (12)	795.5	15.79	14.89	14.58
		793	15.76	14.90	14.58
		790.5	15.81	15.30	14.60
	1RB Low (0)	795.5	15.59	14.63	14.27
		793	15.59	14.73	14.32
		790.5	15.54	15.04	14.38
	12RB High (13)	795.5	14.63	13.69	13.22
		793	14.60	13.71	13.19
		790.5	14.54	13.78	13.15
	12RB Middle (6)	795.5	14.62	13.73	13.24
		793	14.67	13.80	13.25
		790.5	14.67	13.85	13.32
	12RB Low (0)	795.5	14.62	13.66	13.20
		793	14.67	13.78	13.27
		790.5	14.60	13.74	13.24
	25RB (0)	795.5	14.60	13.63	13.20
		793	14.64	13.74	13.23
		790.5	14.62	13.79	13.25
10 MHz	1RB High (49)	793	15.66	15.05	14.29
	1RB Middle (24)	793	15.97	15.24	14.44
	1RB Low (0)	793	15.65	15.02	14.37
	25RB High (25)	793	14.71	13.83	13.26
	25RB Middle (12)	793	14.67	13.81	13.23
	25RB Low (0)	793	14.74	13.84	13.39
	50RB (0)	793	14.74	13.85	13.33

Band 17						
Bandwidth (MHz)	RB allocation	Frequency (MHz)	QPSK	16QAM	64QAM	
	RB offset (Start RB)		Actual output power (dBm)	Actual output power (dBm)	Actual output power (dBm)	
5 MHz	1RB High (24)	713.5	15.48	14.93	14.41	
		710	15.45	14.53	14.01	
		706.5	15.42	14.64	14.12	
	1RB Middle (12)	713.5	15.71	15.18	14.66	
		710	15.75	14.85	14.33	
		706.5	15.66	14.81	14.29	
	1RB Low (0)	713.5	15.38	14.89	14.37	
		710	15.41	14.51	13.99	
		706.5	15.42	14.60	14.08	
	12RB High (13)	713.5	14.40	13.55	13.03	
		710	14.48	13.60	13.08	
		706.5	14.52	13.67	13.15	
	12RB Middle (6)	713.5	14.58	13.72	13.20	
		710	14.59	13.67	13.15	
		706.5	14.57	13.69	13.17	
	12RB Low (0)	713.5	14.51	13.68	13.16	
		710	14.43	13.54	13.02	
		706.5	14.49	13.66	13.14	
	25RB (0)	713.5	14.44	13.61	13.09	
		710	14.53	13.52	13.00	
		706.5	14.53	13.62	13.10	
	10 MHz	1RB High (49)	711	16.15	15.51	14.99
			710	16.06	15.15	14.63
			709	15.99	15.05	14.53
1RB Middle (24)		711	16.26	15.65	14.93	
		710	16.15	15.27	14.75	
		709	16.11	15.16	14.64	
1RB Low (0)		711	16.11	15.49	14.97	
		710	16.08	15.11	14.59	
		709	16.01	15.06	14.54	
25RB High (25)		711	14.92	14.06	13.54	
		710	15.03	14.17	13.65	
		709	15.09	14.22	13.70	
25RB Middle (12)		711	15.15	14.26	13.74	
		710	15.13	14.33	13.81	
		709	15.19	14.27	13.75	
25RB Low (0)		711	14.99	14.15	13.63	
		710	14.99	14.18	13.66	
		709	15.03	14.14	13.62	
50RB (0)		711	14.97	14.09	13.57	
		710	15.05	14.16	13.64	
		709	15.10	14.15	13.63	

Band 25					
Bandwidth (MHz)	RB allocation RB offset (Start RB)	Frequency (MHz)	QPSK	16QAM	64QAM
			Actual output power (dBm)	Actual output power (dBm)	Actual output power (dBm)
1.4 MHz	1RB High (5)	1914.3	11.23	10.43	10.42
		1882.5	11.18	10.42	10.21
		1850.7	11.39	10.86	10.36
	1RB Middle (3)	1914.3	11.45	10.56	10.53
		1882.5	11.38	10.61	10.38
		1850.7	11.57	10.97	10.44
	1RB Low (0)	1914.3	11.26	10.39	10.43
		1882.5	11.21	10.43	10.26
		1850.7	11.40	10.85	10.38
	3RB High (3)	1914.3	11.49	10.64	10.47
		1882.5	11.29	10.38	10.23
		1850.7	11.47	10.73	10.40
	3RB Middle (1)	1914.3	11.47	10.69	10.51
		1882.5	11.35	10.42	10.30
		1850.7	11.55	10.77	10.41
	3RB Low (0)	1914.3	11.39	10.55	10.44
		1882.5	11.30	10.42	10.25
		1850.7	11.51	10.75	10.35
	6RB (0)	1914.3	10.36	9.57	9.28
		1882.5	10.30	9.44	9.11
		1850.7	10.49	9.43	9.21
3 MHz	1RB High (14)	1913.5	11.29	10.44	10.60
		1882.5	11.24	10.26	10.34
		1851.5	11.45	10.89	10.34
	1RB Middle (7)	1913.5	11.43	10.58	10.56
		1882.5	11.35	10.45	10.51
		1851.5	11.62	11.02	10.60
	1RB Low (0)	1913.5	11.28	10.49	10.45
		1882.5	11.20	10.33	10.37
		1851.5	11.52	10.94	10.47
	8RB High (7)	1913.5	10.29	9.42	9.34
		1882.5	10.26	9.41	9.17
		1851.5	10.46	9.61	9.24
	8RB Middle (4)	1913.5	10.37	9.50	9.38
		1882.5	10.32	9.43	9.21
		1851.5	10.48	9.63	9.34
	8RB Low (0)	1913.5	10.33	9.45	9.36
		1882.5	10.29	9.44	9.17
		1851.5	10.48	9.62	9.27
	15RB (0)	1913.5	10.33	9.38	9.33
		1882.5	10.31	9.35	9.10
		1851.5	10.46	9.54	9.19
5 MHz	1RB High (24)	1912.5	11.32	10.44	10.46
		1882.5	11.26	10.50	10.21

	1RB Middle (12)	1852.5	11.30	10.87	10.29	
		1912.5	11.55	10.68	10.65	
		1882.5	11.51	10.67	10.54	
	1RB Low (0)	1852.5	11.56	11.12	10.63	
		1912.5	11.28	10.41	10.39	
		1882.5	11.26	10.44	10.26	
	12RB High (13)	1852.5	11.38	10.98	10.29	
		1912.5	10.29	9.40	9.30	
		1882.5	10.29	9.41	9.16	
	12RB Middle (6)	1852.5	10.45	9.59	9.20	
		1912.5	10.39	9.47	9.37	
		1882.5	10.34	9.47	9.21	
	12RB Low (0)	1852.5	10.50	9.65	9.26	
		1912.5	10.36	9.46	9.36	
		1882.5	10.31	9.40	9.16	
	25RB (0)	1852.5	10.41	9.57	9.16	
		1912.5	10.29	9.36	9.28	
		1882.5	10.34	9.38	9.17	
	10 MHz	1RB High (49)	1852.5	10.46	9.55	9.19
			1910	11.31	10.39	10.49
			1882.5	11.28	10.31	10.37
		1RB Middle (24)	1855	11.44	10.86	10.39
			1910	11.38	10.47	10.61
			1882.5	11.39	10.39	10.47
		1RB Low (0)	1855	11.65	11.00	10.43
			1910	11.25	10.37	10.45
			1882.5	11.27	10.35	10.37
		25RB High (25)	1855	11.45	10.88	10.50
			1910	10.26	9.46	9.28
			1882.5	10.36	9.40	9.19
25RB Middle (12)		1855	10.51	9.53	9.27	
		1910	10.36	9.54	9.35	
		1882.5	10.40	9.40	9.20	
25RB Low (0)		1855	10.55	9.55	9.24	
		1910	10.37	9.54	9.35	
		1882.5	10.43	9.49	9.27	
50RB (0)		1855	10.48	9.50	9.20	
		1910	10.32	9.41	9.31	
		1882.5	10.43	9.42	9.24	
15 MHz		1RB High (74)	1855	10.47	9.49	9.22
			1907.5	11.23	10.23	10.47
			1882.5	11.28	10.67	10.39
		1RB Middle (37)	1857.5	11.28	10.86	10.22
			1907.5	11.31	10.31	10.44
			1882.5	11.34	10.73	10.39
1RB Low (0)		1857.5	11.43	10.99	10.32	
		1907.5	11.17	10.22	10.34	
			1882.5	11.31	10.72	10.38

	36RB High (38)	1857.5	11.41	10.99	10.33	
		1907.5	10.27	9.36	9.28	
		1882.5	10.34	9.35	9.17	
	36RB Middle (19)	1857.5	10.46	9.42	9.19	
		1907.5	10.36	9.35	9.32	
		1882.5	10.39	9.45	9.19	
	36RB Low (0)	1857.5	10.44	9.42	9.20	
		1907.5	10.26	9.31	9.24	
		1882.5	10.40	9.42	9.21	
	75RB (0)	1857.5	10.45	9.42	9.20	
		1907.5	10.28	9.34	9.26	
		1882.5	10.40	9.37	9.20	
20 MHz	1RB High (99)	1857.5	10.41	9.42	9.16	
		1907.5	10.28	9.34	9.26	
		1882.5	10.40	9.37	9.20	
	1RB Middle (50)	1905	11.28	10.84	10.37	
		1882.5	11.23	10.86	10.26	
		1860	11.20	10.76	10.31	
	1RB Low (0)	1905	11.54	11.11	10.59	
		1882.5	11.42	11.05	10.45	
		1860	11.52	11.00	10.46	
	50RB High (50)	1905	11.25	10.79	10.30	
		1882.5	11.21	10.89	10.27	
		1860	11.35	10.83	10.35	
	50RB Middle (25)	1905	10.27	9.36	9.19	
		1882.5	10.28	9.31	9.08	
		1860	10.49	9.45	9.19	
	50RB Low (0)	1905	10.37	9.46	9.28	
		1882.5	10.41	9.47	9.19	
		1860	10.48	9.45	9.20	
	100RB (0)	1905	10.26	9.38	9.19	
		1882.5	10.48	9.52	9.24	
		1860	10.41	9.40	9.09	
			1905	10.24	9.36	9.19
			1882.5	10.42	9.42	9.19
			1860	10.39	9.44	9.14

Band 26					
Bandwidth (MHz)	RB allocation RB offset (Start RB)	Frequency (MHz)	QPSK	16QAM	64QAM
			Actual output power (dBm)	Actual output power (dBm)	Actual output power (dBm)
1.4 MHz	1RB High (5)	848.3	18.42	17.47	17.37
		831.5	18.40	17.57	17.28
		814.7	18.42	17.81	17.21
	1RB Middle (3)	848.3	18.57	17.64	17.52
		831.5	18.57	17.72	17.39
		814.7	18.61	17.95	17.31
	1RB Low (0)	848.3	18.38	17.45	17.31
		831.5	18.40	17.58	17.35
		814.7	18.48	17.77	17.17
	3RB High (3)	848.3	18.53	17.67	17.29
		831.5	18.50	17.60	17.28
		814.7	18.51	17.72	17.15
	3RB Middle (1)	848.3	18.54	17.72	17.40
		831.5	18.51	17.58	17.35
		814.7	18.58	17.73	17.17
	3RB Low (0)	848.3	18.51	17.67	17.33
		831.5	18.53	17.60	17.29
		814.7	18.53	17.72	17.18
	6RB (0)	848.3	17.44	16.67	16.19
		831.5	17.43	16.64	16.16
		814.7	17.42	16.42	16.04
3 MHz	1RB High (14)	847.5	18.42	17.81	17.43
		831.5	18.41	17.49	17.30
		815.5	18.39	17.49	10.61
	1RB Middle (7)	847.5	18.53	17.96	17.54
		831.5	18.50	17.62	17.43
		815.5	18.50	17.63	10.88
	1RB Low (0)	847.5	18.46	17.80	17.38
		831.5	18.39	17.54	17.29
		815.5	18.38	17.51	10.64
	8RB High (7)	847.5	17.39	16.52	16.22
		831.5	17.40	16.54	16.20
		815.5	17.36	16.54	9.48
	8RB Middle (4)	847.5	17.47	16.62	16.28
		831.5	17.45	16.59	16.19
		815.5	17.45	16.57	9.53
	8RB Low (0)	847.5	17.42	16.59	16.27
		831.5	17.42	16.54	16.16
		815.5	17.41	16.56	9.49
	15RB (0)	847.5	17.41	16.50	16.18
		831.5	17.43	16.45	16.13
		815.5	17.42	16.48	9.41
5 MHz	1RB High (24)	846.5	18.41	17.48	17.27
		831.5	18.41	17.62	17.31

	1RB Middle (12)	816.5	18.39	17.90	17.21	
		846.5	18.65	17.73	17.54	
		831.5	18.66	17.80	17.50	
	1RB Low (0)	816.5	18.65	17.83	17.38	
		846.5	18.45	17.47	17.30	
		831.5	18.43	17.57	17.22	
	12RB High (13)	816.5	18.39	17.90	17.17	
		846.5	17.39	16.46	16.15	
		831.5	17.44	16.57	16.21	
	12RB Middle (6)	816.5	17.48	16.68	16.10	
		846.5	17.46	16.58	16.28	
		831.5	17.44	16.60	16.21	
	12RB Low (0)	816.5	17.45	16.70	16.13	
		846.5	17.46	16.58	16.31	
		831.5	17.38	16.57	16.20	
	25RB (0)	816.5	17.40	16.58	16.03	
		846.5	17.42	16.46	16.23	
		831.5	17.43	16.56	16.17	
	10 MHz	1RB High (49)	816.5	17.46	16.63	16.09
			844	18.39	17.42	17.34
			831.5	18.46	17.82	17.47
		1RB Middle (24)	820	18.46	17.54	17.27
			844	18.50	17.50	17.55
			831.5	18.59	17.96	17.49
		1RB Low (0)	820	18.56	17.61	17.46
			844	18.35	17.40	17.44
			831.5	18.48	17.81	17.28
		25RB High (25)	820	18.45	17.48	17.33
			844	17.40	16.47	16.18
			831.5	17.50	16.65	16.28
25RB Middle (12)		820	17.50	16.68	16.18	
		844	17.46	16.60	16.30	
		831.5	17.51	16.66	16.22	
25RB Low (0)		820	17.52	16.69	16.13	
		844	17.55	16.64	16.36	
		831.5	17.51	16.64	16.25	
50RB (0)		820	17.48	16.65	16.12	
		844	17.47	16.53	16.26	
		831.5	17.53	16.60	16.25	
15 MHz		1RB High (74)	820	17.47	16.61	16.12
			841.5	18.43	17.75	17.38
			831.5	18.38	17.87	17.40
		1RB Middle (37)	822.5	18.41	17.41	17.35
			841.5	18.54	17.84	17.54
			831.5	18.51	17.92	17.46
1RB Low (0)		822.5	18.53	17.54	17.37	
		841.5	18.40	17.77	17.43	
			831.5	18.43	17.90	17.32



		822.5	18.41	17.42	17.25
	36RB High (38)	841.5	17.43	16.52	16.23
		831.5	17.47	16.53	16.23
		822.5	17.48	16.54	16.15
	36RB Middle (19)	841.5	17.48	16.57	16.26
		831.5	17.50	16.52	16.23
		822.5	17.55	16.60	16.20
	36RB Low (0)	841.5	17.43	16.52	16.21
		831.5	17.50	16.50	16.21
		822.5	17.46	16.50	16.12
	75RB (0)	841.5	17.42	16.50	16.20
		831.5	17.49	16.55	16.21
		822.5	17.47	16.52	16.12



Band 30					
Bandwidth (MHz)	RB allocation	Frequency (MHz)	QPSK	16QAM	64QAM
	RB offset (Start RB)		Actual output power (dBm)	Actual output power (dBm)	Actual output power (dBm)
5 MHz	1RB High (24)	2312.5	10.37	9.43	8.71
		2310	10.35	9.45	8.73
		2307.5	10.31	9.74	8.92
	1RB Middle (12)	2312.5	10.64	9.68	8.96
		2310	10.63	9.77	8.95
		2307.5	10.56	9.97	8.96
	1RB Low (0)	2312.5	10.32	9.39	8.67
		2310	10.38	9.43	8.71
		2307.5	10.27	9.74	8.83
	12RB High (13)	2312.5	9.36	8.39	7.67
		2310	9.37	8.41	7.69
		2307.5	9.37	8.47	7.75
	12RB Middle (6)	2312.5	9.46	8.44	7.72
		2310	9.43	8.50	7.78
		2307.5	9.40	8.47	7.75
	12RB Low (0)	2312.5	9.39	8.40	7.68
		2310	9.33	8.40	7.68
		2307.5	9.32	8.42	7.70
	25RB (0)	2312.5	9.37	8.31	7.59
		2310	9.42	8.39	7.67
		2307.5	9.35	8.38	7.66
10 MHz	1RB High (49)	2310	10.35	9.40	8.68
	1RB Middle (24)	2310	10.49	9.58	8.86
	1RB Low (0)	2310	10.34	9.36	8.64
	25RB High (25)	2310	9.39	8.48	7.76
	25RB Middle (12)	2310	9.44	8.54	7.82
	25RB Low (0)	2310	9.38	8.48	7.76
	50RB (0)	2310	9.41	8.40	7.68

Band 41-PC3					
Bandwidth (MHz)	RB allocation	Frequency (MHz)	QPSK	16QAM	64QAM
	RB offset (Start RB)		Actual output power (dBm)	Actual output power (dBm)	Actual output power (dBm)
5 MHz	1RB High (24)	2687.5	12.13	11.08	11.02
		2640.3	12.15	11.32	10.94
		2593	12.38	11.25	11.04
		2545.8	12.37	11.37	10.98
		2498.5	12.43	11.61	11.27
	1RB Middle (12)	2687.5	12.14	11.12	11.21
		2640.3	12.24	11.40	11.18
		2593	12.43	11.32	11.33
		2545.8	12.41	11.44	11.26
		2498.5	12.43	11.62	11.43
	1RB Low (0)	2687.5	12.11	11.07	11.01
		2640.3	12.17	11.37	11.02
		2593	12.39	11.27	11.06
		2545.8	12.34	11.39	11.05
		2498.5	12.38	11.59	9.02
	12RB High (13)	2687.5	11.25	10.22	10.41
		2640.3	11.36	10.36	10.34
		2593	11.44	10.41	10.48
		2545.8	11.50	10.41	10.33
		2498.5	11.62	10.61	10.62
	12RB Middle (6)	2687.5	11.36	10.34	10.47
		2640.3	11.49	10.49	10.42
		2593	11.59	10.54	10.50
		2545.8	11.59	10.53	10.42
		2498.5	11.69	10.71	10.29
	12RB Low (0)	2687.5	11.23	10.19	10.38
		2640.3	11.37	10.37	10.41
		2593	11.50	10.40	10.43
		2545.8	11.50	10.40	10.46
		2498.5	11.55	10.59	10.59
	25RB (0)	2687.5	11.25	10.32	10.44
		2640.3	11.41	10.36	10.35
		2593	11.49	10.43	10.50
		2545.8	11.55	10.49	10.43
		2498.5	11.62	10.62	10.68
	10 MHz	1RB High (49)	2685	12.23	11.25
2639			12.32	11.51	11.00
2593			12.57	11.48	11.18

		2547	12.47	11.54	11.04
		2501	12.57	11.79	11.43
	1RB Middle (24)	2685	12.49	11.54	11.21
		2639	12.63	11.81	11.19
		2593	12.83	11.73	11.28
		2547	12.77	11.77	11.19
		2501	12.85	12.09	11.50
		1RB Low (0)	2685	12.15	11.19
	2639		12.36	11.52	11.17
	2593		12.57	11.47	11.17
	2547		12.45	11.52	11.14
	2501		12.53	11.76	11.35
	25RB High (25)	2685	11.34	10.33	10.53
		2639	11.45	10.45	10.36
		2593	11.57	10.54	10.52
		2547	11.58	10.53	10.46
		2501	11.73	10.73	10.75
	25RB Middle (12)	2685	11.33	10.35	10.44
		2639	11.49	10.47	10.49
		2593	11.56	10.51	10.56
		2547	11.64	10.55	10.50
		2501	11.65	10.67	10.73
	25RB Low (0)	2685	11.37	10.37	10.51
		2639	11.53	10.53	10.52
		2593	11.64	10.58	10.57
		2547	11.61	10.62	10.55
		2501	11.67	10.67	10.68
	50RB (0)	2685	11.31	10.38	10.48
		2639	11.48	10.51	10.43
		2593	11.59	10.57	10.55
2547		11.57	10.59	10.42	
2501		11.68	10.67	10.68	
15 MHz	1RB High (74)	2682.5	12.37	11.22	11.00
		2637.8	12.35	11.37	10.91
		2593	12.42	11.56	11.07
		2548.3	12.62	11.52	10.95
		2503.5	12.65	11.67	11.39
	1RB Middle (37)	2682.5	12.46	11.34	11.06
		2637.8	12.51	11.50	11.11
		2593	12.56	11.64	11.18
		2548.3	12.76	11.65	11.12

		2503.5	12.75	11.74	11.44
	1RB Low (0)	2682.5	12.32	11.16	10.98
		2637.8	12.42	11.45	11.14
		2593	12.47	11.61	11.08
		2548.3	12.63	11.56	11.16
		2503.5	12.66	11.65	11.29
	36RB High (38)	2682.5	11.36	10.35	10.37
		2637.8	11.54	10.46	10.30
		2593	11.67	10.59	10.42
		2548.3	11.69	10.60	10.35
		2503.5	11.76	10.67	10.71
	36RB Middle (19)	2682.5	11.37	10.35	10.37
		2637.8	11.59	10.52	10.38
		2593	11.67	10.61	10.45
		2548.3	11.70	10.58	10.38
		2503.5	11.78	10.70	10.70
	36RB Low (0)	2682.5	11.32	10.29	10.35
		2637.8	11.57	10.48	10.44
		2593	11.66	10.60	10.47
		2548.3	11.68	10.57	10.41
		2503.5	11.71	10.61	10.53
	75RB (0)	2682.5	11.31	10.36	10.35
		2637.8	11.55	10.54	10.36
		2593	11.66	10.61	10.56
		2548.3	11.64	10.58	10.34
2503.5		11.74	10.67	10.67	
20 MHz	1RB High (99)	2680	12.23	11.10	10.96
		2636.5	12.32	11.45	12.41
		2593	12.36	11.39	11.03
		2549.5	12.45	11.37	10.91
		2506	12.56	11.69	11.32
	1RB Middle (50)	2680	12.40	11.24	11.08
		2636.5	12.55	11.65	12.44
		2593	12.60	11.59	11.27
		2549.5	12.67	11.55	11.16
		2506	12.73	11.84	11.48
	1RB Low (0)	2680	12.15	10.99	10.90
		2636.5	12.37	11.45	12.38
		2593	12.39	11.39	11.08
		2549.5	12.41	11.33	11.09
		2506	12.51	11.65	11.27
	50RB	2680	11.23	10.30	10.34

	High (50)	2636.5	11.42	10.46	10.43
		2593	11.53	10.48	10.42
		2549.5	11.51	10.52	10.25
		2506	11.69	10.71	10.73
	50RB Middle (25)	2680	11.26	10.32	10.34
		2636.5	11.49	10.53	10.48
		2593	11.58	10.56	10.45
		2549.5	11.55	10.54	10.34
		2506	11.65	10.67	10.70
	50RB Low (0)	2680	11.25	10.28	10.36
		2636.5	11.45	10.48	10.40
		2593	11.49	10.47	10.38
		2549.5	11.52	10.51	10.39
		2506	11.56	10.58	10.54
	100RB (0)	2680	11.21	10.28	10.38
		2636.5	11.43	10.40	10.42
		2593	11.50	10.48	10.44
		2549.5	11.50	10.49	10.32
		2506	11.62	10.60	10.67

Band 41-PC2					
Bandwidth (MHz)	RB allocation	Frequency (MHz)	QPSK	16QAM	64QAM
	RB offset (Start RB)		Actual output power (dBm)	Actual output power (dBm)	Actual output power (dBm)
5 MHz	1RB High (24)	2687.5	14.24	13.55	13.50
		2640.3	14.26	13.76	13.42
		2593	14.43	13.70	13.49
		2545.8	14.48	13.86	13.46
		2498.5	14.57	14.08	13.65
	1RB Middle (12)	2687.5	14.52	13.90	13.66
		2640.3	14.64	14.16	13.66
		2593	14.80	14.11	13.66
		2545.8	14.78	14.17	13.60
		2498.5	14.87	14.39	13.78
	1RB Low (0)	2687.5	14.20	13.56	13.49
		2640.3	14.30	13.81	13.52
		2593	14.45	13.69	13.50
		2545.8	14.46	13.82	13.49
		2498.5	14.51	14.03	13.60
	12RB High (13)	2687.5	13.37	12.37	12.65
		2640.3	13.47	12.53	12.59
		2593	13.56	12.58	12.64
		2545.8	13.62	12.57	12.55
		2498.5	13.69	12.81	12.79
	12RB Middle (6)	2687.5	13.38	12.44	12.71
		2640.3	13.50	12.60	12.66
		2593	13.62	12.62	12.71
		2545.8	13.68	12.63	12.64
		2498.5	13.75	12.83	12.81
	12RB Low (0)	2687.5	13.34	12.36	12.64
		2640.3	13.47	12.55	12.64
		2593	13.60	12.59	12.63
		2545.8	13.59	12.53	12.60
		2498.5	13.64	12.78	12.71
25RB (0)	2687.5	13.37	12.44	12.67	
	2640.3	13.46	12.47	12.64	
	2593	13.57	12.57	12.66	
	2545.8	13.62	12.62	12.60	
	2498.5	13.71	12.73	12.77	
10 MHz	1RB High (49)	2685	14.34	13.84	13.60
		2639	14.43	13.86	13.53
		2593	14.64	13.89	13.60

		2547	14.55	14.12	13.49
		2501	14.66	14.16	13.78
	1RB Middle (24)	2685	14.38	13.90	13.70
		2639	14.50	13.99	13.71
		2593	14.72	13.95	13.71
		2547	14.64	14.22	13.64
		2501	14.71	14.22	13.87
		1RB Low (0)	2685	14.23	13.75
	2639		14.41	13.91	13.65
	2593		14.65	13.89	13.62
	2547		14.58	14.08	13.63
	2501		14.59	14.10	13.69
	25RB High (25)	2685	13.45	12.46	12.72
		2639	13.54	12.56	12.68
		2593	13.63	12.65	12.77
		2547	13.65	12.69	12.62
		2501	13.78	12.78	12.91
	25RB Middle (12)	2685	13.39	12.44	12.71
		2639	13.56	12.57	12.71
		2593	13.64	12.66	12.73
		2547	13.66	12.64	12.65
		2501	13.77	12.73	12.85
	25RB Low (0)	2685	13.38	12.43	12.74
		2639	13.59	12.59	12.77
		2593	13.62	12.66	12.73
		2547	13.67	12.64	12.71
		2501	13.72	12.75	12.81
	50RB (0)	2685	13.38	12.46	12.66
		2639	13.57	12.56	12.70
		2593	13.62	12.65	12.72
2547		13.63	12.67	12.59	
2501		13.73	12.73	12.79	
15 MHz	1RB High (74)	2682.5	14.40	13.59	12.56
		2637.8	14.37	13.86	13.40
		2593	14.36	13.87	13.55
		2548.3	14.62	13.86	13.37
		2503.5	14.68	14.14	13.75
	1RB Middle (37)	2682.5	14.47	13.65	12.55
		2637.8	14.50	13.97	13.62
		2593	14.48	13.93	13.62
		2548.3	14.77	13.98	13.57

		2503.5	14.75	14.26	13.79
	1RB Low (0)	2682.5	14.34	13.50	12.56
		2637.8	14.45	13.89	13.61
		2593	14.42	13.87	13.55
		2548.3	14.63	13.90	13.55
		2503.5	14.66	14.15	13.62
	36RB High (38)	2682.5	13.38	12.38	12.53
		2637.8	13.55	12.49	12.54
		2593	13.62	12.62	12.61
		2548.3	13.64	12.61	12.48
		2503.5	13.77	12.70	12.79
	36RB Middle (19)	2682.5	13.36	12.39	12.56
		2637.8	13.60	12.52	12.62
		2593	13.62	12.64	12.60
		2548.3	13.66	12.62	12.51
		2503.5	13.80	12.76	12.76
	36RB Low (0)	2682.5	13.34	12.36	12.52
		2637.8	13.55	12.50	12.66
		2593	13.60	12.63	12.58
		2548.3	13.65	12.61	12.56
		2503.5	13.71	12.65	12.67
	75RB (0)	2682.5	13.34	12.38	12.56
		2637.8	13.58	12.52	12.61
		2593	13.64	12.62	12.65
		2548.3	13.63	12.63	12.52
2503.5		13.78	12.76	12.76	
20 MHz	1RB High (99)	2680	14.43	13.87	13.45
		2636.5	14.56	13.87	13.37
		2593	14.62	13.82	13.47
		2549.5	14.55	14.01	13.31
		2506	14.64	13.97	13.73
	1RB Middle (50)	2680	14.77	14.20	13.57
		2636.5	14.94	14.23	13.68
		2593	14.94	14.18	13.69
		2549.5	14.91	14.38	13.62
		2506	15.03	14.33	13.88
	1RB Low (0)	2680	14.34	13.77	13.40
		2636.5	14.58	13.91	13.61
		2593	14.59	13.79	13.47
		2549.5	14.50	14.00	13.51
		2506	14.67	13.94	13.59
	50RB	2680	13.46	12.59	12.51



	High (50)	2636.5	13.62	12.62	12.54
		2593	13.69	12.71	12.61
		2549.5	13.62	12.70	12.47
		2506	13.79	12.77	12.87
	50RB Middle (25)	2680	13.46	12.62	12.53
		2636.5	13.68	12.69	12.68
		2593	13.74	12.77	12.67
		2549.5	13.67	12.74	12.56
		2506	13.75	12.75	12.85
	50RB Low (0)	2680	13.46	12.56	12.53
		2636.5	13.66	12.64	12.68
		2593	13.66	12.65	12.59
		2549.5	13.64	12.68	12.58
		2506	13.66	12.64	12.71
	100RB (0)	2680	13.46	12.52	12.51
		2636.5	13.64	12.61	12.63
		2593	13.66	12.69	12.63
		2549.5	13.65	12.64	12.52
		2506	13.72	12.73	12.80

Band 66						
Bandwidth (MHz)	RB allocation	Frequency (MHz)	QPSK	16QAM	64QAM	
	RB offset (Start RB)		Actual output power (dBm)	Actual output power (dBm)	Actual output power (dBm)	
1.4 MHz	1RB High (5)	1779.3	12.48	11.73	11.57	
		1745	12.51	11.94	11.49	
		1710.7	12.41	11.57	11.41	
	1RB Middle (3)	1779.3	12.67	11.88	11.60	
		1745	12.69	12.03	11.67	
		1710.7	12.55	11.76	11.54	
	1RB Low (0)	1779.3	12.51	11.77	11.58	
		1745	12.54	11.88	11.50	
		1710.7	12.43	11.54	11.53	
	3RB High (3)	1779.3	12.64	11.74	11.52	
		1745	12.60	11.87	11.47	
		1710.7	12.58	11.87	11.47	
	3RB Middle (1)	1779.3	12.68	11.78	11.56	
		1745	12.68	11.87	11.57	
		1710.7	12.61	11.80	11.51	
	3RB Low (0)	1779.3	12.63	11.73	11.49	
		1745	12.61	11.81	11.57	
		1710.7	12.54	11.74	11.45	
	6RB (0)	1779.3	11.55	10.73	10.48	
		1745	11.52	10.47	10.45	
		1710.7	11.49	10.70	10.37	
	3 MHz	1RB High (14)	1778.5	12.56	11.55	11.63
			1745	12.57	12.00	11.61
			1711.5	12.45	11.57	11.54
1RB Middle (7)		1778.5	12.64	11.68	11.72	
		1745	12.72	12.12	11.74	
		1711.5	12.60	11.75	11.67	
1RB Low (0)		1778.5	12.50	11.58	11.57	
		1745	12.58	12.00	11.63	
		1711.5	12.52	11.64	11.55	
8RB High (7)		1778.5	11.53	10.68	10.47	
		1745	11.50	10.65	10.45	
		1711.5	11.49	10.55	10.44	
8RB Middle (4)		1778.5	11.56	10.71	10.49	
		1745	11.53	10.70	10.52	
		1711.5	11.55	10.59	10.43	
8RB Low (0)		1778.5	11.55	10.71	10.47	
		1745	11.49	10.64	10.50	
		1711.5	11.49	10.53	10.43	
15RB (0)		1778.5	11.56	10.65	10.40	
		1745	11.51	10.59	10.39	
		1711.5	11.51	10.49	10.35	
5 MHz		1RB High (24)	1777.5	12.50	11.69	11.49
			1745	12.51	11.97	11.53

	1RB Middle (12)	1712.5	12.51	11.66	11.37	
		1777.5	12.74	11.94	11.71	
		1745	12.72	12.20	11.77	
	1RB Low (0)	1712.5	12.73	11.88	11.74	
		1777.5	12.52	11.69	11.53	
		1745	12.49	11.95	11.52	
	12RB High (13)	1712.5	12.49	11.66	11.47	
		1777.5	11.53	10.64	10.45	
		1745	11.52	10.67	10.46	
	12RB Middle (6)	1712.5	11.52	10.58	10.41	
		1777.5	11.59	10.69	10.54	
		1745	11.59	10.76	10.51	
	12RB Low (0)	1712.5	11.56	10.63	10.44	
		1777.5	11.56	10.68	10.50	
		1745	11.53	10.66	10.45	
	25RB (0)	1712.5	11.49	10.58	10.40	
		1777.5	11.58	10.64	10.46	
		1745	11.55	10.64	10.42	
	10 MHz	1RB High (49)	1712.5	11.51	10.54	10.39
			1777.5	11.58	10.64	10.46
			1745	11.55	10.64	10.42
1RB Middle (24)		1775	12.55	11.55	11.60	
		1745	12.59	11.95	11.55	
		1715	12.53	11.63	11.44	
1RB Low (0)		1775	12.65	11.70	11.76	
		1745	12.66	12.07	11.72	
		1715	12.56	11.73	11.62	
25RB High (25)		1775	12.48	11.52	11.68	
		1745	12.56	11.95	11.62	
		1715	12.49	11.57	11.52	
25RB Middle (12)		1775	11.58	10.62	10.48	
		1745	11.59	10.68	10.50	
		1715	11.57	10.65	10.42	
25RB Low (0)		1775	11.61	10.69	10.53	
		1745	11.64	10.71	10.49	
		1715	11.58	10.70	10.42	
50RB (0)		1775	11.68	10.70	10.60	
		1745	11.63	10.68	10.48	
		1715	11.53	10.65	10.41	
15 MHz	1RB High (74)	1775	11.53	10.65	10.41	
		1775	11.61	10.68	10.52	
		1745	11.60	10.68	10.48	
	1RB Middle (37)	1715	11.53	10.61	10.41	
		1772.5	12.45	11.45	11.48	
		1745	12.49	11.89	11.56	
	1RB Low (0)	1717.5	12.47	11.99	11.41	
		1772.5	12.58	11.60	11.62	
		1745	12.65	12.02	11.66	
		1717.5	12.54	12.08	11.53	
		1772.5	12.43	11.50	11.54	
		1745	12.52	11.85	11.52	

	36RB High (38)	1717.5	12.46	12.00	11.51	
		1772.5	11.49	10.51	10.46	
		1745	11.56	10.65	10.47	
	36RB Middle (19)	1717.5	11.57	10.56	10.42	
		1772.5	11.57	10.58	10.52	
		1745	11.56	10.61	10.48	
	36RB Low (0)	1717.5	11.52	10.51	10.39	
		1772.5	11.53	10.56	10.51	
		1745	11.55	10.62	10.47	
	75RB (0)	1717.5	11.50	10.49	10.38	
		1772.5	11.54	10.61	10.50	
		1745	11.59	10.60	10.45	
	20 MHz	1RB High (99)	1717.5	11.51	10.52	10.38
			1770	12.50	12.04	11.43
			1745	12.42	12.09	11.50
1RB Middle (50)		1720	12.46	11.92	11.39	
		1770	12.74	12.33	11.72	
		1745	12.70	12.35	11.70	
1RB Low (0)		1720	12.75	12.14	11.55	
		1770	12.43	11.99	11.49	
		1745	12.44	12.06	11.52	
50RB High (50)		1720	12.41	11.85	11.41	
		1770	11.47	10.56	10.36	
		1745	11.60	10.69	10.43	
50RB Middle (25)		1720	11.53	10.46	10.34	
		1770	11.66	10.72	10.51	
		1745	11.63	10.66	10.50	
50RB Low (0)		1720	11.56	10.52	10.38	
		1770	11.61	10.68	10.53	
		1745	11.60	10.66	10.48	
100RB (0)		1720	11.50	10.49	10.35	
		1770	11.60	10.64	10.48	
		1745	11.61	10.61	10.46	
			1720	11.51	10.50	10.33

Band 71						
Bandwidth (MHz)	RB allocation	Frequency (MHz)	QPSK	16QAM	64QAM	
	RB offset (Start RB)		Actual output power (dBm)	Actual output power (dBm)	Actual output power (dBm)	
5 MHz	1RB High (24)	695.5	15.92	15.07	14.74	
		680.5	15.86	15.09	14.70	
		665.5	15.92	15.50	14.64	
	1RB Middle (12)	695.5	16.12	15.15	15.04	
		680.5	16.17	15.33	14.89	
		665.5	16.22	15.76	15.08	
	1RB Low (0)	695.5	15.90	14.96	14.68	
		680.5	15.89	15.12	14.71	
		665.5	15.92	15.48	14.69	
	12RB High (13)	695.5	14.97	13.97	13.61	
		680.5	14.99	14.05	13.62	
		665.5	15.09	14.16	13.68	
	12RB Middle (6)	695.5	15.06	14.07	13.66	
		680.5	15.03	14.10	13.65	
		665.5	15.10	14.24	13.73	
	12RB Low (0)	695.5	14.99	14.04	13.64	
		680.5	14.99	14.04	13.61	
		665.5	14.95	14.06	13.58	
	25RB (0)	695.5	15.04	13.98	13.62	
		680.5	15.02	14.04	13.60	
		665.5	15.03	14.14	13.62	
	10 MHz	1RB High (49)	693	15.95	14.96	11.83
			680.5	15.88	15.33	14.74
			668	15.95	15.04	14.71
1RB Middle (24)		693	16.12	15.11	11.93	
		680.5	15.99	15.43	14.88	
		668	16.12	15.21	14.95	
1RB Low (0)		693	15.99	15.01	11.81	
		680.5	15.82	15.30	14.77	
		668	15.91	15.05	14.80	
25RB High (25)		693	15.04	14.17	10.72	
		680.5	15.03	14.08	13.68	
		668	15.16	14.23	13.72	
25RB Middle (12)		693	15.07	14.09	10.74	
		680.5	15.02	14.05	13.65	
		668	15.05	14.16	13.65	
25RB Low (0)		693	14.96	14.00	10.73	
		680.5	15.01	14.05	13.67	
		668	14.98	14.08	13.61	
50RB (0)		693	15.04	14.07	10.69	
		680.5	15.09	14.08	13.68	
		668	15.04	14.09	13.65	
15 MHz		1RB	690.5	15.96	15.32	14.75

	High (74)	680.5	15.87	15.39	14.72	
		670.5	15.82	14.92	14.63	
	1RB Middle (37)	690.5	15.98	15.33	14.81	
		680.5	15.95	15.50	14.89	
	1RB Low (0)	670.5	15.95	15.03	14.75	
		690.5	15.90	15.28	14.82	
		680.5	15.90	15.43	14.68	
	36RB High (38)	670.5	15.88	15.00	14.87	
		690.5	14.99	13.98	13.63	
		680.5	15.03	14.02	13.67	
	36RB Middle (19)	670.5	15.05	14.03	13.59	
		690.5	14.97	13.98	13.60	
		680.5	15.01	13.98	13.65	
	36RB Low (0)	670.5	15.03	14.03	13.66	
		690.5	14.92	13.94	13.59	
		680.5	15.06	14.01	13.67	
	75RB (0)	670.5	14.96	13.95	13.62	
		690.5	14.94	13.93	13.55	
		680.5	15.03	13.99	13.65	
	20 MHz	1RB High (99)	670.5	15.02	14.00	13.58
			688	15.86	15.43	14.68
			683	15.79	15.36	14.64
		1RB Middle (50)	673	15.83	15.37	14.64
			688	16.04	15.63	14.81
683			16.08	15.72	14.86	
1RB Low (0)		673	16.13	15.58	14.83	
		688	15.78	15.35	14.67	
		683	15.76	15.39	14.76	
50RB High (50)		673	15.80	15.33	14.70	
		688	14.78	13.80	13.45	
		683	15.00	14.06	13.62	
50RB Middle (25)		673	14.95	13.91	13.54	
		688	14.96	14.02	13.63	
		683	15.02	14.03	13.65	
50RB Low (0)		673	15.00	13.98	13.61	
		688	14.85	13.90	13.49	
		683	15.01	14.03	13.66	
100RB (0)		673	14.84	13.82	13.52	
		688	14.81	13.88	13.47	
		683	14.96	13.98	13.60	
			673	14.90	13.90	13.51

### 11.3 Wi-Fi and BT Measurement result

The maximum output power of BT is 8.14dBm.

The maximum tune up of BT is 9dBm.

Normal Power by Sensor deactive ,Low power by Sensor active.

The average conducted power for Wi-Fi is as following:

#### Normal power

2.4GHz										
802.11b(dBm)										
Channel\data rate	1Mbps	2Mbps	5.5Mbps	11Mbps						
11(2462MHz)	18.43	/	18.44	/						
6(2437MHz)	18.71	18.70	18.79	18.72						
1(2412MHz)	17.76	/	17.80	/						
Tune up	19.00	19.00	19.00	19.00						
802.11g(dBm)										
Channel\data rate	6Mbps	9Mbps	12Mbps	18Mbps	24Mbps	36Mbps	48Mbps	54Mbps		
11(2462MHz)	17.71	/	/	/	/	/	/	/		
6(2437MHz)	18.19	18.03	17.38	17.36	16.39	16.38	14.94	14.90		
1(2412MHz)	17.75	/	/	/	/	/	/	/		
Tune up	19.00	19.00	18.00	18.00	17.00	17.00	16.00	16.00		
802.11n(dBm)-20MHz										
Channel\data rate	MCS0	MCS1	MCS2	MCS3	MCS4	MCS5	MCS6	MCS7		
11(2462MHz)	18.70	/	/	/	/	/	/	/		
6(2437MHz)	18.91	18.90	17.90	17.92	16.95	16.47	15.41	15.40		
1(2412MHz)	18.01	/	/	/	/	/	/	/		
Tune up	19.00	19.00	18.00	18.00	17.00	17.00	16.00	16.00		
802.11n(dBm)-40MHz										
Channel\data rate	MCS0	MCS1	MCS2	MCS3	MCS4	MCS5	MCS6	MCS7		
9(2452MHz)	16.90	/	/	/	/	/	/	/		
6(2437MHz)	17.34	17.30	16.33	16.32	15.31	14.85	13.85	13.91		
3(2422MHz)	16.70	/	/	/	/	/	/	/		
Tune up	17.50	17.50	16.50	16.50	15.50	15.50	14.50	14.50		

5GHz										
802.11ac(dBm)-80MHz										
Channel\data rate	MCS0	MCS1	MCS2	MCS3	MCS4	MCS5	MCS6	MCS7	MCS8	MCS9
42(5210 MHz)	<b>16.01</b>	15.94	14.94	14.93	13.96	13.55	12.58	12.55	11.50	11.51
58(5290 MHz)	<b>15.01</b>	14.99	13.99	14.00	13.02	12.59	11.53	11.52	10.56	10.52
106(5530 MHz)	<b>14.91</b>									
122(5610 MHz)	15.08									
138(5690 MHz)	15.78	15.75	14.76	14.73	13.95	13.45	12.49	12.46	11.43	11.47
155(5775 MHz)	<b>16.22</b>	16.21	15.19	15.18	14.29	13.86	12.75	12.74	11.82	11.86
Tune up	16.50	16.50	15.50	15.50	14.50	14.50	13.50	13.50	12.50	12.50



**Low power**

2.4GHz									
802.11b(dBm)									
Channel\data rate	1Mbps	2Mbps	5.5Mbps	11Mbps					
11(2462MHz)	10.70	/		/					
6(2437MHz)	10.96	10.94	10.93	10.92					
1(2412MHz)	10.16	/	/	/					
Tune up	11.00	11.00	11.00	11.00					
802.11g(dBm)									
Channel\data rate	6Mbps	9Mbps	12Mbps	18Mbps	24Mbps	36Mbps	48Mbps	54Mbps	
11(2462MHz)	10.75	10.74	10.69	10.67	10.70	10.66	10.15	10.14	
6(2437MHz)	10.01	/	/	/	/	/	/	/	
1(2412MHz)	10.15	/	/	/	/	/	/	/	
Tune up	11.00	11.00	11.00	11.00	11.00	11.00	11.00	11.00	11.00
802.11n(dBm)-20MHz									
Channel\data rate	MCS0	MCS1	MCS2	MCS3	MCS4	MCS5	MCS6	MCS7	
11(2462MHz)	10.70	/	/	/	/	/	/	/	
6(2437MHz)	10.97	10.96	10.95	10.94	10.93	10.59	10.55	10.57	
1(2412MHz)	10.15	/	/	/	/	/	/	/	
Tune up	11.00	11.00	11.00	11.00	11.00	11.00	11.00	11.00	11.00
802.11n(dBm)-40MHz									
Channel\data rate	MCS0	MCS1	MCS2	MCS3	MCS4	MCS5	MCS6	MCS7	
9(2452MHz)	10.46	/	/	/	/	/	/	/	
6(2437MHz)	10.91	10.82	10.83	10.85	10.84	10.37	10.34	10.27	
3(2422MHz)	10.28	/	/	/	/	/	/	/	
Tune up	11.00	11.00	11.00	11.00	11.00	11.00	11.00	11.00	11.00

5GHz										
802.11ac(dBm)-80MHz										
Channel\data rate	MCS0	MCS1	MCS2	MCS3	MCS4	MCS5	MCS6	MCS7	MCS8	MCS9
42(5210 MHz)	<b>4.65</b>	4.64	4.61	4.60	4.59	4.09	4.11	4.08	4.07	4.06
58(5290 MHz)	<b>4.92</b>	4.86	4.82	4.77	4.83	4.32	4.25	4.22	4.21	4.20
106(5530 MHz)	<b>3.82</b>									
122(5610 MHz)	3.86									
138(5690 MHz)	4.69	4.67	4.66	4.64	4.57	4.15	4.13	4.12	4.10	4.06
155(5775 MHz)	<b>5.07</b>	5.06	5.04	5.01	5.00	4.51	4.49	4.48	4.47	4.46
Tune up	5.50	5.50	5.50	5.50	5.50	5.50	5.50	5.50	5.50	5.50





## 12 Simultaneous TX SAR Considerations

### 12.1 Introduction

The following procedures adopted from “FCC SAR Considerations for Cell Phones with Multiple Transmitters” are applicable to handsets with built-in unlicensed transmitters such as 802.11 a/b/g and Bluetooth devices which may simultaneously transmit with the licensed transmitter.

For this device, the BT and Wi-Fi can transmit simultaneous with other transmitters.

### 12.2 Transmit Antenna Separation Distances

Please refer to the picture of antenna locations in the document: “The Photos of SAR test-I21Z70098”

### 12.3 SAR Measurement Positions

According to the KDB941225 D06 Hot Spot SAR v01, the edges with less than 2.5 cm distance to the antennas need to be tested for SAR.

SAR measurement positions						
Mode	Front	Rear	Left edge	Right edge	Top edge	Bottom edge
Main antenna	Yes	Yes	Yes	No	Yes	No
WLAN antenna	Yes	Yes	No	Yes	Yes	No

## 12.4 Standalone SAR Test Exclusion Considerations

Standalone 1-g head or body SAR evaluation by measurement or numerical simulation is not required when the corresponding SAR Exclusion Threshold condition, listed below, is satisfied. The 1-g SAR test exclusion threshold for 100 MHz to 6 GHz at test separation distances  $\leq 50$  mm are determined by:

$$\left[ \frac{\text{max. power of channel, including tune-up tolerance, mW}}{\text{min. test separation distance, mm}} \right] \cdot \sqrt{f(\text{GHz})} \leq 3.0$$
 for 1-g SAR, where

- $f(\text{GHz})$  is the RF channel transmit frequency in GHz
- Power and distance are rounded to the nearest mW and mm before calculation
- The result is rounded to one decimal place for comparison

**Table 12.1: Standalone SAR test exclusion considerations**

Band/Mode	F(GHz)	Position	SAR test exclusion threshold(mW)	RF output power		SAR test exclusion
				dBm	mW	
Bluetooth	2.441	Body	19.20	9	7.94	Yes
2.4GHz WLAN	2.45	Body	19.17	19	79.43	No
5GHz WLAN	5.2	Body	13.16	16.5	44.67	No
	5.3	Body	13.03	16.5	44.67	No
	5.6	Body	12.68	16.5	44.67	No
	5.8	Body	12.46	16.5	44.67	No

### 13 Evaluation of Simultaneous

**Table 13.1: The sum of SAR values for Main antenna + WiFi-2.4G**

	<b>Position</b>	<b>Cellular antenna</b>	<b>WiFi-2.4G</b>	<b>Sum</b>
<b>Highest SAR value for Body</b>	Rear 0mm	0.91	0.28	<b>1.19</b>

**Table 13.2: The sum of SAR values for Main antenna + WiFi-5G**

	<b>Position</b>	<b>Cellular antenna</b>	<b>WiFi-5G</b>	<b>Sum</b>
<b>Maximum reported SAR value for Body</b>	Top 0mm	0.82	0.31	<b>1.13</b>

**Table 13.3: The sum of SAR values for Main antenna + WiFi-5G +BT**

	<b>Position</b>	<b>Cellular antenna</b>	<b>WiFi-5G</b>	<b>BT</b>	<b>Sum</b>
<b>Maximum reported SAR value for Body</b>	Top 0mm	0.82	0.31	<0.01	<b>1.13</b>

[1] – The SAR of BT is too low to get it, so the “<0.01” is used to indicate the SAR of BT.

According to the above tables, the sum of reported SAR values is <1.6W/kg. So the simultaneous transmission SAR with volume scans is not required.

## 14 SAR Test Result

It is determined by user manual for the distance between the EUT and the phantom bottom. The distance is 0/12/21/26/24/14/27 mm and just applied to the condition of body worn accessory. It is performed for all SAR measurements with area scan based 1-g SAR estimation (Fast SAR). A zoom scan measurement is added when the estimated 1-gSAR is the highest measured SAR in each exposure configuration, wireless mode and frequency band combination or more than 1.2W/kg.

The calculated SAR is obtained by the following formula:

$$\text{Reported SAR} = \text{Measured SAR} \times 10^{(P_{\text{Target}} - P_{\text{Measured}})/10}$$

Where  $P_{\text{Target}}$  is the power of manufacturing upper limit;

$P_{\text{Measured}}$  is the measured power in chapter 11.

**Table 14.1: Duty Cycle**

Mode	Duty Cycle
WCDMA&LTE FDD	1:1
LTE TDD	1:1.58
LTE B41 PC2	1:2.309
LTE B41 PC3	1:1.58

### 14.1 SAR results for Fast SAR

**Table 14.1-1: SAR Values (WCDMA 850 MHz Band - Body)**

Frequency		Test Position	Figure No./ Note	Ambient Temperature: 22.9 °C		Liquid Temperature: 22.5 °C		Measured SAR(1g) (W/kg)	Reported SAR(1g) (W/kg)	Power Drift (dB)
Ch.	MHz			Conducted Power (dBm)	Max. tune-up Power (dBm)	Measured SAR(10g) (W/kg)	Reported SAR(10g) (W/kg)			
4233	846.6	Front	Note1	24.54	25.50	0.142	<b>0.18</b>	0.265	<b>0.33</b>	-0.10
4182	836.4	Front	Note1 Fig.1	24.47	25.50	0.146	<b>0.19</b>	0.272	<b>0.34</b>	-0.19
4132	826.4	Front	Note1	24.42	25.50	0.141	<b>0.18</b>	0.262	<b>0.34</b>	0.13
4182	836.4	Rear	Note2	24.47	25.50	0.131	<b>0.17</b>	0.244	<b>0.31</b>	-0.06
4182	836.4	Left	Note3	24.47	25.50	0.109	<b>0.14</b>	0.222	<b>0.28</b>	0.05
4182	836.4	Top	Note2	24.47	25.50	0.065	<b>0.08</b>	0.129	<b>0.16</b>	-0.10
4182	836.4	Front	/	17.95	19.00	0.075	<b>0.10</b>	0.137	<b>0.17</b>	-0.08
4182	836.4	Rear	/	17.95	19.00	0.116	<b>0.15</b>	0.244	<b>0.31</b>	-0.11
4182	836.4	Left	/	17.95	19.00	0.094	<b>0.12</b>	0.147	<b>0.19</b>	-0.03
4182	836.4	Top	/	17.95	19.00	0.049	<b>0.06</b>	0.119	<b>0.15</b>	0.12

Note: The distance between the EUT and the phantom bottom is 0mm.

Note1: The distance between the EUT and the phantom bottom is 21mm.

Note2: The distance between the EUT and the phantom bottom is 26mm.

Note3: The distance between the EUT and the phantom bottom is 12mm.

**Table 14.1-2: SAR Values (WCDMA 1700 MHz Band - Body)**

Frequency		Test Position	Figure No./ Note	Ambient Temperature: 22.9 °C		Liquid Temperature: 22.5 °C		Measured SAR(1g) (W/kg)	Reported SAR(1g) (W/kg)	Power Drift (dB)
Ch.	MHz			Conducted Power (dBm)	Max. tune-up Power (dBm)	Measured SAR(10g) (W/kg)	Reported SAR(10g) (W/kg)			
1412	1732.4	Front	Note1	24.76	25.50	0.116	<b>0.14</b>	0.191	<b>0.23</b>	-0.11
1412	1732.4	Rear	Note2	24.76	25.50	0.079	<b>0.09</b>	0.133	<b>0.16</b>	-0.02
1412	1732.4	Left	Note3	24.76	25.50	0.128	<b>0.15</b>	0.217	<b>0.26</b>	0.01
1412	1732.4	Top	Note2	24.76	25.50	0.146	<b>0.17</b>	0.243	<b>0.29</b>	0.05
1412	1732.4	Front	/	12.80	13.50	0.121	<b>0.14</b>	0.249	<b>0.29</b>	-0.09
1412	1732.4	Rear	/	12.80	13.50	0.169	<b>0.20</b>	0.341	<b>0.40</b>	-0.04
1412	1732.4	Left	/	12.80	13.50	0.052	<b>0.06</b>	0.116	<b>0.14</b>	-0.11
1513	1752.6	Top	Fig.2	12.73	13.50	0.189	<b>0.23</b>	0.492	<b>0.59</b>	-0.15
1412	1732.4	Top	/	12.80	13.50	0.183	<b>0.22</b>	0.480	<b>0.56</b>	0.04
1312	1712.4	Top	/	12.78	13.50	0.174	<b>0.21</b>	0.455	<b>0.54</b>	-0.06

Note: The distance between the EUT and the phantom bottom is 0mm.

Note1: The distance between the EUT and the phantom bottom is 21mm.

Note2: The distance between the EUT and the phantom bottom is 26mm.

Note3: The distance between the EUT and the phantom bottom is 12mm.

**Table 14.1-3: SAR Values (WCDMA 1900 MHz Band - Body)**

Frequency		Test Position	Figure No./Note	Conducted Power (dBm)	Max. tune-up Power (dBm)	Ambient Temperature: 22.9 °C		Liquid Temperature: 22.5 °C		Power Drift (dB)
Ch.	MHz					Measured SAR(10g) (W/kg)	Reported SAR(10g) (W/kg)	Measured SAR(1g) (W/kg)	Reported SAR(1g) (W/kg)	
9400	1880	Front	Note1	24.33	25.20	0.129	<b>0.16</b>	0.214	<b>0.26</b>	0.13
9400	1880	Rear	Note2	24.33	25.20	0.098	<b>0.12</b>	0.155	<b>0.19</b>	-0.07
9400	1880	Left	Note3	24.33	25.20	0.181	<b>0.22</b>	0.322	<b>0.39</b>	0.05
9400	1880	Top	Note2	24.33	25.20	0.128	<b>0.16</b>	0.215	<b>0.26</b>	0.00
9400	1880	Front	/	10.77	12.00	0.094	<b>0.12</b>	0.211	<b>0.28</b>	-0.11
9400	1880	Rear	/	10.77	12.00	0.140	<b>0.19</b>	0.312	<b>0.41</b>	-0.02
9400	1880	Left	/	10.77	12.00	0.049	<b>0.07</b>	0.134	<b>0.18</b>	0.00
9538	1907.6	Top	Fig.3	10.80	12.00	0.162	<b>0.21</b>	0.429	<b>0.57</b>	0.14
9400	1880	Top	/	10.77	12.00	0.150	<b>0.20</b>	0.399	<b>0.53</b>	0.01
9262	1852.4	Top	/	10.85	12.00	0.156	<b>0.20</b>	0.363	<b>0.47</b>	-0.09

Note: The distance between the EUT and the phantom bottom is 0mm.

Note1: The distance between the EUT and the phantom bottom is 21mm.

Note2: The distance between the EUT and the phantom bottom is 26mm.

Note3: The distance between the EUT and the phantom bottom is 12mm.

**Table 14.1-4: SAR Values (LTE Band2 - Body)**

Frequency		Mode	Test Position	Figure No./Note	Conducted Power (dBm)	Max. tune-up Power (dBm)	Ambient Temperature: 22.9 °C		Liquid Temperature: 22.5 °C		Power Drift (dB)
Ch.	MHz						Measured SAR(10g) (W/kg)	Reported SAR(10g) (W/kg)	Measured SAR(1g) (W/kg)	Reported SAR(1g) (W/kg)	
19100	1900	1RB_Mid	Front	Note1	24.35	25.20	0.235	<b>0.29</b>	0.389	<b>0.47</b>	-0.01
19100	1900	1RB_Mid	Rear	Note2	24.35	25.20	0.157	<b>0.19</b>	0.248	<b>0.30</b>	0.08
19100	1900	1RB_Mid	Left	Note3	24.35	25.20	0.230	<b>0.28</b>	0.394	<b>0.48</b>	0.08
19100	1900	1RB_Mid	Top	Note2	24.35	25.20	0.252	<b>0.31</b>	0.418	<b>0.51</b>	-0.07
18900	1880	1RB_Mid	Front	/	11.44	12.20	0.146	<b>0.17</b>	0.338	<b>0.40</b>	0.07
18900	1880	1RB_Mid	Rear	/	11.44	12.20	0.224	<b>0.27</b>	0.601	<b>0.72</b>	-0.05
18900	1880	1RB_Mid	Left	/	11.44	12.20	0.077	<b>0.09</b>	0.232	<b>0.28</b>	-0.01
18900	1880	1RB_Mid	Top	Fig.4	11.44	12.20	0.245	<b>0.29</b>	0.645	<b>0.77</b>	0.17
19100	1900	50RB_Mid	Front	Note1	23.34	24.20	0.185	<b>0.23</b>	0.306	<b>0.37</b>	-0.09
19100	1900	50RB_Mid	Rear	Note2	23.34	24.20	0.122	<b>0.15</b>	0.192	<b>0.23</b>	-0.12
19100	1900	50RB_Mid	Left	Note3	23.34	24.20	0.180	<b>0.22</b>	0.307	<b>0.37</b>	-0.03
19100	1900	50RB_Mid	Top	Note2	23.34	24.20	0.197	<b>0.24</b>	0.327	<b>0.40</b>	0.05
18700	1860	50RB_Mid	Front	/	10.44	11.20	0.106	<b>0.13</b>	0.239	<b>0.28</b>	-0.12
18700	1860	50RB_Mid	Rear	/	10.44	11.20	0.175	<b>0.21</b>	0.459	<b>0.55</b>	-0.07
18700	1860	50RB_Mid	Left	/	10.44	11.20	0.055	<b>0.07</b>	0.148	<b>0.18</b>	-0.10
18700	1860	50RB_Mid	Top	/	10.44	11.20	0.181	<b>0.22</b>	0.475	<b>0.57</b>	0.11

Note: The distance between the EUT and the phantom bottom is 0mm.

Note1: The distance between the EUT and the phantom bottom is 21mm.

Note2: The distance between the EUT and the phantom bottom is 26mm.

Note3: The distance between the EUT and the phantom bottom is 12mm.

Note4: The LTE mode is QPSK\_20MHz.

**Table 14.1-5: SAR Values (LTE Band4 - Body)**

Frequency		Mode	Test Position	Figure No./ Note	Conducted Power (dBm)	Max. tune-up Power (dBm)	Measured SAR(10g) (W/kg)	Reported SAR(10g) (W/kg)	Measured SAR(1g) (W/kg)	Reported SAR(1g) (W/kg)	Power Drift (dB)
Ch.	MHz										
20050	1720	1RB_Mid	Front	Note1	25.23	25.50	0.140	<b>0.15</b>	0.234	<b>0.25</b>	0.11
20050	1720	1RB_Mid	Rear	Note2	25.23	25.50	0.109	<b>0.12</b>	0.178	<b>0.19</b>	0.01
20050	1720	1RB_Mid	Left	Note3	25.23	25.50	0.163	<b>0.17</b>	0.278	<b>0.30</b>	0.02
20050	1720	1RB_Mid	Top	Note2	25.23	25.50	0.176	<b>0.19</b>	0.284	<b>0.30</b>	0.06
20175	1732.5	1RB_Mid	Front	/	12.77	13.50	0.185	<b>0.22</b>	0.433	<b>0.51</b>	0.01
20300	1745	1RB_Mid	Rear	/	12.69	13.50	0.257	<b>0.31</b>	0.600	<b>0.72</b>	0.01
20175	1732.5	1RB_Mid	Rear	Fig.5	12.77	13.50	0.310	<b>0.37</b>	0.767	<b>0.91</b>	-0.12
20050	1720	1RB_Mid	Rear	/	12.76	13.50	0.248	<b>0.29</b>	0.570	<b>0.68</b>	0.01
20175	1732.5	1RB_Mid	Left	/	12.77	13.50	0.079	<b>0.09</b>	0.228	<b>0.27</b>	0.04
20300	1745	1RB_Mid	Top	/	12.69	13.50	0.198	<b>0.24</b>	0.543	<b>0.65</b>	0.06
20175	1732.5	1RB_Mid	Top	/	12.77	13.50	0.239	<b>0.28</b>	0.694	<b>0.82</b>	0.00
20050	1720	1RB_Mid	Top	/	12.76	13.50	0.191	<b>0.23</b>	0.516	<b>0.61</b>	0.14
20175	1732.5	50RB_Low	Front	Note1	24.15	24.50	0.110	<b>0.12</b>	0.184	<b>0.20</b>	0.06
20175	1732.5	50RB_Low	Rear	Note2	24.15	24.50	0.086	<b>0.09</b>	0.141	<b>0.15</b>	0.13
20175	1732.5	50RB_Low	Left	Note3	24.15	24.50	0.131	<b>0.14</b>	0.225	<b>0.24</b>	-0.06
20175	1732.5	50RB_Low	Top	Note2	24.15	24.50	0.140	<b>0.15</b>	0.226	<b>0.24</b>	-0.05
20175	1732.5	50RB_Low	Front	/	11.64	12.50	0.146	<b>0.18</b>	0.343	<b>0.42</b>	0.07
20175	1732.5	50RB_Low	Rear	/	11.64	12.50	0.245	<b>0.30</b>	0.603	<b>0.74</b>	0.02
20175	1732.5	50RB_Low	Left	/	11.64	12.50	0.064	<b>0.08</b>	0.184	<b>0.22</b>	0.09
20175	1732.5	50RB_Low	Top	/	11.64	12.50	0.187	<b>0.23</b>	0.545	<b>0.66</b>	-0.13
20300	1745	100RB	Rear	/	11.59	12.50	0.198	<b>0.24</b>	0.462	<b>0.57</b>	0.01
20300	1745	100RB	Top	/	11.59	12.50	0.178	<b>0.22</b>	0.439	<b>0.54</b>	0.16

Note: The distance between the EUT and the phantom bottom is 0mm.

Note1: The distance between the EUT and the phantom bottom is 21mm.

Note2: The distance between the EUT and the phantom bottom is 26mm.

Note3: The distance between the EUT and the phantom bottom is 12mm.

Note4: The LTE mode is QPSK\_20MHz.

**Table 14.1-6: SAR Values (LTE Band5 - Body)**

Frequency		Mode	Test Position	Figure No./Note	Conducted Power (dBm)	Max. tune-up Power (dBm)	Measured SAR(10g) (W/kg)	Reported SAR(10g) (W/kg)	Measured SAR(1g) (W/kg)	Reported SAR(1g) (W/kg)	Power Drift (dB)
Ch.	MHz										
Ambient Temperature: 22.9°C					Liquid Temperature: 22.5°C						
20525	836.5	1RB_Mid	Front	Note1	24.51	25.50	0.121	<b>0.15</b>	0.169	<b>0.21</b>	0.02
20525	836.5	1RB_Mid	Rear	Note2	24.51	25.50	0.105	<b>0.13</b>	0.147	<b>0.18</b>	0.06
20525	836.5	1RB_Mid	Left	Note3	24.51	25.50	0.101	<b>0.13</b>	0.168	<b>0.21</b>	0.03
20525	836.5	1RB_Mid	Top	Note2	24.51	25.50	0.068	<b>0.09</b>	0.100	<b>0.13</b>	-0.05
20600	844	1RB_Low	Front	/	18.68	19.00	0.134	<b>0.14</b>	0.321	<b>0.35</b>	0.13
20600	844	1RB_Low	Rear	Fig.6	18.68	19.00	0.143	<b>0.15</b>	0.323	<b>0.35</b>	0.15
20600	844	1RB_Low	Left	/	18.68	19.00	0.141	<b>0.15</b>	0.307	<b>0.33</b>	0.01
20600	844	1RB_Low	Top	/	18.68	19.00	0.086	<b>0.09</b>	0.296	<b>0.32</b>	0.11
20600	844	25RB_Mid	Front	Note1	23.42	24.50	0.092	<b>0.12</b>	0.130	<b>0.17</b>	-0.10
20600	844	25RB_Mid	Rear	Note2	23.42	24.50	0.081	<b>0.10</b>	0.113	<b>0.14</b>	-0.11
20600	844	25RB_Mid	Left	Note3	23.42	24.50	0.078	<b>0.10</b>	0.130	<b>0.17</b>	-0.03
20600	844	25RB_Mid	Top	Note2	23.42	24.50	0.053	<b>0.07</b>	0.077	<b>0.10</b>	-0.01
20450	829	25RB_Mid	Front	/	17.54	18.00	0.106	<b>0.12</b>	0.253	<b>0.28</b>	-0.06
20450	829	25RB_Mid	Rear	/	17.54	18.00	0.113	<b>0.13</b>	0.255	<b>0.28</b>	-0.03
20450	829	25RB_Mid	Left	/	17.54	18.00	0.111	<b>0.12</b>	0.240	<b>0.27</b>	0.12
20450	829	25RB_Mid	Top	/	17.54	18.00	0.068	<b>0.08</b>	0.234	<b>0.26</b>	0.13

Note: The distance between the EUT and the phantom bottom is 0mm.

Note1: The distance between the EUT and the phantom bottom is 21mm.

Note2: The distance between the EUT and the phantom bottom is 26mm.

Note3: The distance between the EUT and the phantom bottom is 12mm.

Note4: The LTE mode is QPSK\_10MHz.



**Table 14.1-7: SAR Values (LTE Band7 - Body)**

Frequency		Mode	Test Position	Figure No.	Ambient Temperature: 22.9 °C		Liquid Temperature: 22.5°C		Measured SAR(1g) (W/kg)	Reported SAR(1g) (W/kg)	Power Drift (dB)
Ch.	MHz				Conducted Power (dBm)	Max. tune-up Power (dBm)	Measured SAR(10g) (W/kg)	Reported SAR(10g) (W/kg)			
21100	2535	1RB-Mid	Front	Note1	23.25	24.00	0.187	<b>0.22</b>	0.332	<b>0.39</b>	-0.05
21100	2535	1RB-Mid	Rear	Note2	23.25	24.00	0.135	<b>0.16</b>	0.244	<b>0.29</b>	0.04
21100	2535	1RB-Mid	Left	Note3	23.25	24.00	0.197	<b>0.23</b>	0.376	<b>0.45</b>	-0.09
21100	2535	1RB-Mid	Top	Note2	23.25	24.00	0.214	<b>0.25</b>	0.394	<b>0.47</b>	-0.02
20850	2510	1RB-Mid	Front		12.35	13.00	0.235	<b>0.27</b>	0.587	<b>0.68</b>	-0.07
21350	2560	1RB-Mid	Rear	/	12.32	13.00	0.261	<b>0.31</b>	0.696	<b>0.81</b>	0.00
21100	2535	1RB-Mid	Rear		12.32	13.00	0.265	<b>0.31</b>	0.686	<b>0.80</b>	0.00
20850	2510	1RB-Mid	Rear	Fig.7	12.35	13.00	0.288	<b>0.33</b>	0.756	<b>0.88</b>	0.15
20850	2510	1RB-Mid	Left	/	12.35	13.00	0.057	<b>0.07</b>	0.154	<b>0.18</b>	0.05
20850	2510	1RB-Mid	Top	/	12.35	13.00	0.211	<b>0.25</b>	0.547	<b>0.64</b>	0.08
21350	2510	50RB- Mid	Front	Note1	22.07	23.00	0.156	<b>0.19</b>	0.174	<b>0.22</b>	0.10
21350	2510	50RB- Mid	Rear	Note2	22.07	23.00	0.119	<b>0.15</b>	0.213	<b>0.26</b>	0.01
21350	2510	50RB- Mid	Left	Note3	22.07	23.00	0.165	<b>0.20</b>	0.315	<b>0.39</b>	-0.02
21350	2510	50RB- Mid	Top	Note2	22.07	23.00	0.149	<b>0.18</b>	0.273	<b>0.34</b>	-0.04
20850	2510	50RB-Mid	Front	/	11.18	12.00	0.180	<b>0.22</b>	0.449	<b>0.54</b>	-0.10
20850	2510	50RB-Mid	Rear	/	11.18	12.00	0.216	<b>0.26</b>	0.566	<b>0.68</b>	-0.03
20850	2510	50RB-Mid	Left	/	11.18	12.00	0.044	<b>0.05</b>	0.121	<b>0.15</b>	0.06
20850	2510	50RB-Mid	Top	/	11.18	12.00	0.162	<b>0.20</b>	0.420	<b>0.51</b>	0.04
20850	2510	100RB	Rear	/	11.16	12.00	0.199	<b>0.24</b>	0.516	<b>0.63</b>	0.00

Note: The distance between the EUT and the phantom bottom is 0mm.

Note1: The distance between the EUT and the phantom bottom is 21mm.

Note2: The distance between the EUT and the phantom bottom is 26mm.

Note3: The distance between the EUT and the phantom bottom is 12mm.

Note4: The LTE mode is QPSK\_20MHz.

**Table 14.1-8: SAR Values (LTE Band12 - Body)**

Frequency		Mode	Test Position	Figure No.	Ambient Temperature: 22.9 °C		Liquid Temperature: 22.5°C		Measured SAR(1g) (W/kg)	Reported SAR(1g) (W/kg)	Power Drift (dB)
Ch.	MHz				Conducted Power (dBm)	Max. tune-up Power (dBm)	Measured SAR(10g) (W/kg)	Reported SAR(10g) (W/kg)			
23130	711	1RB-Mid	Front	Note1	24.62	25.50	0.083	<b>0.10</b>	0.110	<b>0.13</b>	-0.03
23130	711	1RB-Mid	Rear	Note2	24.62	25.50	0.070	<b>0.09</b>	0.093	<b>0.11</b>	0.12
23130	711	1RB-Mid	Left	Note3	24.62	25.50	0.040	<b>0.05</b>	0.063	<b>0.08</b>	0.05
23130	711	1RB-Mid	Top	Note2	24.62	25.50	0.045	<b>0.06</b>	0.068	<b>0.08</b>	0.06
23095	707.5	1RB-Mid	Front	/	16.33	17.00	0.187	<b>0.22</b>	0.449	<b>0.52</b>	0.12
23095	707.5	1RB-Mid	Rear	Fig.8	16.33	17.00	0.239	<b>0.28</b>	0.571	<b>0.67</b>	0.16
23095	707.5	1RB-Mid	Left	/	16.33	17.00	0.043	<b>0.05</b>	0.109	<b>0.13</b>	0.01
23095	707.5	1RB-Mid	Top	/	16.33	17.00	0.193	<b>0.23</b>	0.563	<b>0.66</b>	-0.09
23095	707.5	25RB_Mid	Front	Note1	23.61	24.50	0.062	<b>0.08</b>	0.083	<b>0.10</b>	-0.10
23095	707.5	25RB_Mid	Rear	Note2	23.61	24.50	0.043	<b>0.05</b>	0.058	<b>0.07</b>	0.09
23095	707.5	25RB_Mid	Left	Note3	23.61	24.50	0.029	<b>0.04</b>	0.046	<b>0.06</b>	0.04
23095	707.5	25RB_Mid	Top	Note2	23.61	24.50	0.038	<b>0.05</b>	0.054	<b>0.07</b>	0.04
23060	704	25RB_High	Front	/	15.29	16.00	0.127	<b>0.15</b>	0.306	<b>0.36</b>	0.12
23060	704	25RB_High	Rear	/	15.29	16.00	0.152	<b>0.18</b>	0.360	<b>0.42</b>	0.02
23060	704	25RB_High	Left	/	15.29	16.00	0.037	<b>0.04</b>	0.096	<b>0.11</b>	-0.12
23060	704	25RB_High	Top	/	15.29	16.00	0.091	<b>0.11</b>	0.238	<b>0.28</b>	0.11

Note: The distance between the EUT and the phantom bottom is 0mm.

Note1: The distance between the EUT and the phantom bottom is 21mm.

Note2: The distance between the EUT and the phantom bottom is 26mm.

Note3: The distance between the EUT and the phantom bottom is 12mm.

Note4: The LTE mode is QPSK\_10MHz.

**Table 14.1-9: SAR Values (LTE Band13 - Body)**

Frequency		Mode	Test Position	Figure No.	Ambient Temperature: 22.9 °C		Liquid Temperature: 22.5°C		Measured SAR(1g) (W/kg)	Reported SAR(1g) (W/kg)	Power Drift (dB)
Ch.	MHz				Conducted Power (dBm)	Max. tune-up Power (dBm)	Measured SAR(10g) (W/kg)	Reported SAR(10g) (W/kg)			
23230	782	1RB-Mid	Front	Note1	24.03	25.00	0.103	<b>0.13</b>	0.140	<b>0.18</b>	0.02
23230	782	1RB-Mid	Rear	Note2	24.03	25.00	0.092	<b>0.12</b>	0.129	<b>0.16</b>	-0.01
23230	782	1RB-Mid	Left	Note3	24.03	25.00	0.070	<b>0.09</b>	0.115	<b>0.14</b>	0.06
23230	782	1RB-Mid	Top	Note2	24.03	25.00	0.087	<b>0.11</b>	0.129	<b>0.16</b>	-0.08
23230	782	1RB-Mid	Front	/	15.76	16.50	0.082	<b>0.10</b>	0.152	<b>0.18</b>	0.10
23230	782	1RB-Mid	Rear	Fig.9	15.76	16.50	0.111	<b>0.13</b>	0.251	<b>0.30</b>	0.15
23230	782	1RB-Mid	Left	/	15.76	16.50	0.049	<b>0.06</b>	0.120	<b>0.14</b>	0.03
23230	782	1RB-Mid	Top	/	15.76	16.50	0.079	<b>0.09</b>	0.243	<b>0.29</b>	0.11
23230	782	25RB_High	Front	Note1	23.05	24.00	0.094	<b>0.12</b>	0.133	<b>0.17</b>	-0.02
23230	782	25RB_High	Rear	Note2	23.05	24.00	0.062	<b>0.08</b>	0.092	<b>0.11</b>	0.02
23230	782	25RB_High	Left	Note3	23.05	24.00	0.052	<b>0.06</b>	0.086	<b>0.11</b>	0.11

23230	782	25RB_High	Top	Note2	23.05	24.00	0.067	<b>0.08</b>	0.101	<b>0.13</b>	0.12
23230	782	25RB_High	Front	/	14.77	15.50	0.064	<b>0.08</b>	0.118	<b>0.14</b>	0.03
23230	782	25RB_High	Rear	/	14.77	15.50	0.086	<b>0.10</b>	0.196	<b>0.23</b>	-0.06
23230	782	25RB_High	Left	/	14.77	15.50	0.038	<b>0.04</b>	0.093	<b>0.11</b>	-0.13
23230	782	25RB_High	Top	/	14.77	15.50	0.062	<b>0.07</b>	0.189	<b>0.22</b>	-0.07

Note: The distance between the EUT and the phantom bottom is 0mm.

Note1: The distance between the EUT and the phantom bottom is 21mm.

Note2: The distance between the EUT and the phantom bottom is 26mm.

Note3: The distance between the EUT and the phantom bottom is 12mm.

Note4: The LTE mode is QPSK\_10MHz.

**Table 14.1-10: SAR Values (LTE Band14 - Body)**

Frequency		Mode	Test Position	Figure No.	Ambient Temperature: 22.9 °C		Liquid Temperature: 22.5 °C		Measured SAR(1g) (W/kg)	Reported SAR(1g) (W/kg)	Power Drift (dB)
Ch.	MHz				Conducted Power (dBm)	Max. tune-up Power (dBm)	Measured SAR(10g) (W/kg)	Reported SAR(10g) (W/kg)			
23330	793	1RB-Mid	Front	Note1	24.18	25.00	0.086	<b>0.10</b>	0.115	<b>0.14</b>	0.13
23330	793	1RB-Mid	Rear	Note2	24.18	25.00	0.081	<b>0.10</b>	0.106	<b>0.13</b>	0.07
23330	793	1RB-Mid	Left	Note3	24.18	25.00	0.060	<b>0.07</b>	0.096	<b>0.12</b>	0.10
23330	793	1RB-Mid	Top	Note2	24.18	25.00	0.055	<b>0.07</b>	0.076	<b>0.09</b>	0.10
23330	793	1RB-Mid	Front	/	15.97	16.50	0.102	<b>0.12</b>	0.195	<b>0.22</b>	-0.12
23330	793	1RB-Mid	Rear	Fig.10	15.97	16.50	0.140	<b>0.16</b>	0.299	<b>0.34</b>	0.14
23330	793	1RB-Mid	Left	/	15.97	16.50	0.058	<b>0.07</b>	0.119	<b>0.13</b>	0.08
23330	793	1RB-Mid	Top	/	15.97	16.50	0.083	<b>0.09</b>	0.163	<b>0.18</b>	0.08
23330	793	25RB_High	Front	Note1	23.23	24.00	0.070	<b>0.08</b>	0.093	<b>0.11</b>	0.10
23330	793	25RB_High	Rear	Note2	23.23	24.00	0.062	<b>0.07</b>	0.081	<b>0.10</b>	0.00
23330	793	25RB_High	Left	Note3	23.23	24.00	0.047	<b>0.06</b>	0.074	<b>0.09</b>	-0.12
23330	793	25RB_High	Top	Note2	23.23	24.00	0.041	<b>0.05</b>	0.056	<b>0.07</b>	-0.02
23330	793	25RB_Low	Front	/	14.74	15.50	0.077	<b>0.09</b>	0.123	<b>0.15</b>	0.12
23330	793	25RB_Low	Rear	/	14.74	15.50	0.098	<b>0.12</b>	0.166	<b>0.20</b>	0.02
23330	793	25RB_Low	Left	/	14.74	15.50	0.047	<b>0.06</b>	0.097	<b>0.12</b>	0.00
23330	793	25RB_Low	Top	/	14.74	15.50	0.068	<b>0.08</b>	0.135	<b>0.16</b>	0.02

Note: The distance between the EUT and the phantom bottom is 0mm.

Note1: The distance between the EUT and the phantom bottom is 21mm.

Note2: The distance between the EUT and the phantom bottom is 26mm.

Note3: The distance between the EUT and the phantom bottom is 12mm.

Note4: The LTE mode is QPSK\_10MHz.

**Table 14.1-11: SAR Values (LTE Band17 - Body)**

Frequency		Mode	Test Position	Figure No.	Ambient Temperature: 22.9 °C		Liquid Temperature: 22.5°C		Measured SAR(1g) (W/kg)	Reported SAR(1g) (W/kg)	Power Drift (dB)
Ch.	MHz				Conducted Power (dBm)	Max. tune-up Power (dBm)	Measured SAR(10g) (W/kg)	Reported SAR(10g) (W/kg)			
23790	710	1RB-Mid	Front	Note1	24.65	25.50	0.069	<b>0.08</b>	0.099	<b>0.12</b>	0.09
23790	710	1RB-Mid	Rear	Note2	24.65	25.50	0.102	<b>0.12</b>	0.138	<b>0.17</b>	0.07
23790	710	1RB-Mid	Left	Note3	24.65	25.50	0.040	<b>0.05</b>	0.061	<b>0.07</b>	0.03
23790	710	1RB-Mid	Top	Note2	24.65	25.50	0.058	<b>0.07</b>	0.087	<b>0.11</b>	0.05
23800	711	1RB-Mid	Front	/	16.26	17.00	0.152	<b>0.18</b>	0.277	<b>0.33</b>	-0.05
23800	711	1RB-Mid	Rear	Fig.11	16.26	17.00	0.207	<b>0.25</b>	0.460	<b>0.55</b>	0.06
23800	711	1RB-Mid	Left	/	16.26	17.00	0.091	<b>0.11</b>	0.219	<b>0.26</b>	-0.05
23800	711	1RB-Mid	Top	/	16.26	17.00	0.146	<b>0.17</b>	0.444	<b>0.53</b>	0.02
23800	711	25RB_Mid	Front	Note1	24.65	25.50	0.088	<b>0.11</b>	0.121	<b>0.15</b>	0.03
23800	711	25RB_Mid	Rear	Note2	24.65	25.50	0.078	<b>0.09</b>	0.105	<b>0.13</b>	0.17
23800	711	25RB_Mid	Left	Note3	24.65	25.50	0.059	<b>0.07</b>	0.096	<b>0.12</b>	0.05
23800	711	25RB_Mid	Top	Note2	24.65	25.50	0.052	<b>0.06</b>	0.073	<b>0.09</b>	0.03
23780	709	25RB_Mid	Front	/	15.19	16.00	0.118	<b>0.14</b>	0.215	<b>0.26</b>	-0.10
23780	709	25RB_Mid	Rear	/	15.19	16.00	0.159	<b>0.19</b>	0.358	<b>0.43</b>	0.00
23780	709	25RB_Mid	Left	/	15.19	16.00	0.070	<b>0.08</b>	0.170	<b>0.20</b>	-0.11
23780	709	25RB_Mid	Top	/	15.19	16.00	0.115	<b>0.14</b>	0.345	<b>0.42</b>	-0.08

Note: The distance between the EUT and the phantom bottom is 0mm.

Note1: The distance between the EUT and the phantom bottom is 21mm.

Note2: The distance between the EUT and the phantom bottom is 26mm.

Note3: The distance between the EUT and the phantom bottom is 12mm.

Note4: The LTE mode is QPSK\_10MHz.

**Table 14.1-12: SAR Values (LTE Band25 - Body)**

Frequency		Mode	Test Position	Figure No.	Ambient Temperature: 22.9 °C		Liquid Temperature: 22.5°C		Measured SAR(1g) (W/kg)	Reported SAR(1g) (W/kg)	Power Drift (dB)
Ch.	MHz				Conducted Power (dBm)	Max. tune-up Power (dBm)	Measured SAR(10g) (W/kg)	Reported SAR(10g) (W/kg)			
26140	1860	1RB-Mid	Front	Note1	24.50	25.20	0.132	<b>0.16</b>	0.216	<b>0.25</b>	-0.07
26140	1860	1RB-Mid	Rear	Note2	24.50	25.20	0.082	<b>0.10</b>	0.135	<b>0.16</b>	0.01
26140	1860	1RB-Mid	Left	Note3	24.50	25.20	0.175	<b>0.21</b>	0.298	<b>0.35</b>	0.02
26140	1860	1RB-Mid	Top	Note2	24.50	25.20	0.248	<b>0.29</b>	0.409	<b>0.48</b>	0.07
26590	1905	1RB-Mid	Front	/	11.54	12.20	0.164	<b>0.19</b>	0.352	<b>0.41</b>	-0.06
26590	1905	1RB-Mid	Rear	Fig.12	11.54	12.20	0.258	<b>0.30</b>	0.632	<b>0.74</b>	0.17
26590	1905	1RB-Mid	Left	/	11.54	12.20	0.078	<b>0.09</b>	0.181	<b>0.21</b>	-0.13
26590	1905	1RB-Mid	Top	/	11.54	12.20	0.252	<b>0.29</b>	0.575	<b>0.67</b>	-0.10
26140	1860	50RB_High	Front	Note1	23.43	24.20	0.107	<b>0.13</b>	0.175	<b>0.21</b>	-0.05
26140	1860	50RB_High	Rear	Note2	23.43	24.20	0.065	<b>0.08</b>	0.106	<b>0.13</b>	0.09
26140	1860	50RB_High	Left	Note3	23.43	24.20	0.134	<b>0.16</b>	0.228	<b>0.27</b>	-0.13

26140	1860	50RB_High	Top	Note2	23.43	24.20	0.191	<b>0.23</b>	0.315	<b>0.38</b>	0.11
26140	1860	50RB_High	Front	/	10.49	11.20	0.115	<b>0.14</b>	0.246	<b>0.29</b>	-0.09
26140	1860	50RB_High	Rear	/	10.49	11.20	0.174	<b>0.20</b>	0.390	<b>0.46</b>	-0.08
26140	1860	50RB_High	Left	/	10.49	11.20	0.056	<b>0.07</b>	0.127	<b>0.15</b>	0.09
26140	1860	50RB_High	Top	/	10.49	11.20	0.200	<b>0.24</b>	0.454	<b>0.53</b>	0.08

Note: The distance between the EUT and the phantom bottom is 0mm.

Note1: The distance between the EUT and the phantom bottom is 21mm.

Note2: The distance between the EUT and the phantom bottom is 26mm.

Note3: The distance between the EUT and the phantom bottom is 12mm.

Note4: The LTE mode is QPSK\_20MHz.

**Table 14.1-13: SAR Values (LTE Band26 - Body)**

Frequency		Mode	Test Position	Figure No.	Ambient Temperature: 22.9 °C		Liquid Temperature: 22.5 °C		Measured SAR(1g) (W/kg)	Reported SAR(1g) (W/kg)	Power Drift (dB)
Ch.	MHz				Conducted Power (dBm)	Max. tune-up Power (dBm)	Measured SAR(10g) (W/kg)	Reported SAR(10g) (W/kg)			
26865	831.5	1RB-Mid	Front	Note1	25.18	25.50	0.101	<b>0.11</b>	0.142	<b>0.15</b>	0.01
26865	831.5	1RB-Mid	Rear	Note2	25.18	25.50	0.087	<b>0.09</b>	0.125	<b>0.13</b>	0.04
26865	831.5	1RB-Mid	Left	Note3	25.18	25.50	0.077	<b>0.08</b>	0.130	<b>0.14</b>	0.13
26865	831.5	1RB-Mid	Top	Note2	25.18	25.50	0.062	<b>0.07</b>	0.095	<b>0.10</b>	0.09
26965	841.5	1RB-Mid	Front	/	18.54	19.00	0.080	<b>0.09</b>	0.157	<b>0.17</b>	0.05
26965	841.5	1RB-Mid	Rear	Fig.13	18.54	19.00	0.123	<b>0.14</b>	0.278	<b>0.31</b>	-0.05
26965	841.5	1RB-Mid	Left	/	18.54	19.00	0.137	<b>0.15</b>	0.278	<b>0.31</b>	0.11
26965	841.5	1RB-Mid	Top	/	18.54	19.00	0.084	<b>0.09</b>	0.232	<b>0.26</b>	-0.13
26965	841.5	36RB_Mid	Front	Note1	24.18	24.50	0.080	<b>0.09</b>	0.114	<b>0.12</b>	0.09
26965	841.5	36RB_Mid	Rear	Note2	24.18	24.50	0.071	<b>0.08</b>	0.101	<b>0.11</b>	0.10
26965	841.5	36RB_Mid	Left	Note3	24.18	24.50	0.062	<b>0.07</b>	0.103	<b>0.11</b>	-0.10
26965	841.5	36RB_Mid	Top	Note2	24.18	24.50	0.050	<b>0.05</b>	0.077	<b>0.08</b>	-0.01
26775	822.5	36RB_Mid	Front	/	17.55	18.00	0.064	<b>0.07</b>	0.126	<b>0.14</b>	0.04
26775	822.5	36RB_Mid	Rear	/	17.55	18.00	0.093	<b>0.10</b>	0.207	<b>0.23</b>	-0.13
26775	822.5	36RB_Mid	Left	/	17.55	18.00	0.110	<b>0.12</b>	0.222	<b>0.25</b>	0.03
26775	822.5	36RB_Mid	Top	/	17.55	18.00	0.066	<b>0.07</b>	0.184	<b>0.20</b>	0.03

Note: The distance between the EUT and the phantom bottom is 0mm.

Note1: The distance between the EUT and the phantom bottom is 21mm.

Note2: The distance between the EUT and the phantom bottom is 26mm.

Note3: The distance between the EUT and the phantom bottom is 12mm.

Note4: The LTE mode is QPSK\_15MHz.

**Table 14.1-14: SAR Values (LTE Band30- Body)**

Frequency		Mode	Test Position	Figure No.	Ambient Temperature: 22.9 °C		Liquid Temperature: 22.5°C		Measured SAR(1g) (W/kg)	Reported SAR(1g) (W/kg)	Power Drift (dB)
Ch.	MHz				Conducted Power (dBm)	Max. tune-up Power (dBm)	Measured SAR(10g) (W/kg)	Reported SAR(10g) (W/kg)			
27710	2310	1RB-High	Front	Note1	22.46	24.00	0.139	<b>0.20</b>	0.242	<b>0.34</b>	-0.13
27710	2310	1RB-High	Rear	Note2	22.46	24.00	0.074	<b>0.11</b>	0.131	<b>0.19</b>	0.05
27710	2310	1RB-High	Left	Note3	22.46	24.00	0.086	<b>0.12</b>	0.163	<b>0.23</b>	-0.07
27710	2310	1RB-High	Top	Note2	22.46	24.00	0.098	<b>0.14</b>	0.172	<b>0.25</b>	0.11
27710	2310	1RB-Mid	Front	/	10.49	11.00	0.116	<b>0.13</b>	0.261	<b>0.29</b>	-0.05
27710	2310	1RB-Mid	Rear	/	10.49	11.00	0.181	<b>0.20</b>	0.449	<b>0.50</b>	0.09
27710	2310	1RB-Mid	Left	/	10.49	11.00	0.076	<b>0.09</b>	0.192	<b>0.22</b>	-0.04
27710	2310	1RB-Mid	Top	Fig.14	10.49	11.00	0.228	<b>0.26</b>	0.578	<b>0.65</b>	0.12
27710	2310	25RB_High	Front	Note1	21.42	23.00	0.109	<b>0.16</b>	0.190	<b>0.27</b>	-0.12
27710	2310	25RB_High	Rear	Note2	21.42	23.00	0.056	<b>0.08</b>	0.099	<b>0.14</b>	-0.10
27710	2310	25RB_High	Left	Note3	21.42	23.00	0.065	<b>0.09</b>	0.122	<b>0.18</b>	0.11
27710	2310	25RB_High	Top	Note2	21.42	23.00	0.074	<b>0.11</b>	0.133	<b>0.19</b>	0.00
27710	2310	25RB_Mid	Front	/	9.44	10.00	0.089	<b>0.10</b>	0.202	<b>0.23</b>	-0.03
27710	2310	25RB_Mid	Rear	/	9.44	10.00	0.140	<b>0.16</b>	0.347	<b>0.39</b>	-0.03
27710	2310	25RB_Mid	Left	/	9.44	10.00	0.059	<b>0.07</b>	0.149	<b>0.17</b>	-0.03
27710	2310	25RB_Mid	Top	/	9.44	10.00	0.173	<b>0.20</b>	0.437	<b>0.50</b>	0.07

Note: The distance between the EUT and the phantom bottom is 0mm.

Note1: The distance between the EUT and the phantom bottom is 21mm.

Note2: The distance between the EUT and the phantom bottom is 26mm.

Note3: The distance between the EUT and the phantom bottom is 12mm.

Note4: The LTE mode is QPSK\_10MHz.

**Table 14.1-15: SAR Values (LTE Band41 PC3 - Body)**

Frequency		Mode	Test Position	Figure No.	Ambient Temperature: 22.9 °C		Liquid Temperature: 22.5°C		Measured SAR(1g) (W/kg)	Reported SAR(1g) (W/kg)	Power Drift (dB)
Ch.	MHz				Conducted Power (dBm)	Max. tune-up Power (dBm)	Measured SAR(10g) (W/kg)	Reported SAR(10g) (W/kg)			
41490	2680	1RB-Mid	Front	Note1	24.25	24.50	0.158	<b>0.17</b>	0.298	<b>0.32</b>	0.01
41490	2680	1RB-Mid	Rear	Note2	24.25	24.50	0.112	<b>0.12</b>	0.204	<b>0.22</b>	-0.10
41490	2680	1RB-Mid	Left	Note3	24.25	24.50	0.153	<b>0.16</b>	0.295	<b>0.31</b>	0.11
41490	2680	1RB-Mid	Top	Note2	24.25	24.50	0.186	<b>0.20</b>	0.350	<b>0.37</b>	0.06
39750	2506	1RB-Mid	Front	/	12.73	13.50	0.124	<b>0.15</b>	0.256	<b>0.31</b>	-0.10
39750	2506	1RB-Mid	Rear	Fig.15	12.73	13.50	0.155	<b>0.19</b>	0.405	<b>0.48</b>	0.17
39750	2506	1RB-Mid	Left	/	12.73	13.50	0.051	<b>0.06</b>	0.142	<b>0.17</b>	0.10
39750	2506	1RB-Mid	Top	/	12.73	13.50	0.133	<b>0.16</b>	0.319	<b>0.38</b>	0.04
41490	2680	50RB_High	Front	Note1	23.03	23.50	0.121	<b>0.13</b>	0.227	<b>0.25</b>	-0.11
41490	2680	50RB_High	Rear	Note2	23.03	23.50	0.085	<b>0.09</b>	0.157	<b>0.17</b>	-0.02
41490	2680	50RB_High	Left	Note3	23.03	23.50	0.114	<b>0.13</b>	0.216	<b>0.24</b>	0.09

41490	2680	50RB_High	Top	Note2	23.03	23.50	0.141	<b>0.16</b>	0.268	<b>0.30</b>	0.10
39750	2506	50RB_High	Front	/	11.69	12.50	0.097	<b>0.12</b>	0.200	<b>0.24</b>	0.08
39750	2506	50RB_High	Rear	/	11.69	12.50	0.120	<b>0.14</b>	0.312	<b>0.38</b>	-0.02
39750	2506	50RB_High	Left	/	11.69	12.50	0.040	<b>0.05</b>	0.111	<b>0.13</b>	0.13
39750	2506	50RB_High	Top	/	11.69	12.50	0.103	<b>0.12</b>	0.249	<b>0.30</b>	-0.10

Note: The distance between the EUT and the phantom bottom is 0mm.

Note1: The distance between the EUT and the phantom bottom is 21mm.

Note2: The distance between the EUT and the phantom bottom is 26mm.

Note3: The distance between the EUT and the phantom bottom is 12mm.

Note4: The LTE mode is QPSK\_20MHz.

**Table 14.1-16: SAR Values (LTE Band41 PC2 - Body)**

Frequency		Mode	Test Position	Figure No.	Ambient Temperature: 22.9 °C		Liquid Temperature: 22.5 °C		Measured SAR(1g) (W/kg)	Reported SAR(1g) (W/kg)	Power Drift (dB)
Ch.	MHz				Conducted Power (dBm)	Max. tune-up Power (dBm)	Measured SAR(10g) (W/kg)	Reported SAR(10g) (W/kg)			
41490	2680	1RB-Mid	Front	Note1	27.32	27.50	0.076	<b>0.08</b>	0.145	<b>0.15</b>	-0.06
41490	2680	1RB-Mid	Rear	Note2	27.32	27.50	0.058	<b>0.06</b>	0.107	<b>0.11</b>	-0.06
41490	2680	1RB-Mid	Left	Note3	27.32	27.50	0.071	<b>0.07</b>	0.137	<b>0.14</b>	0.04
41490	2680	1RB-Mid	Top	Note2	27.32	27.50	0.124	<b>0.13</b>	0.234	<b>0.24</b>	0.11
39750	2506	1RB-Mid	Front	/	15.03	15.50	0.084	<b>0.09</b>	0.195	<b>0.22</b>	-0.05
39750	2506	1RB-Mid	Rear	Fig.16	15.03	15.50	0.104	<b>0.12</b>	0.272	<b>0.30</b>	0.16
39750	2506	1RB-Mid	Left	/	15.03	15.50	0.024	<b>0.03</b>	0.061	<b>0.07</b>	0.11
39750	2506	1RB-Mid	Top	/	15.03	15.50	0.081	<b>0.09</b>	0.203	<b>0.23</b>	0.01
41490	2680	50RB_High	Front	Note1	26.09	26.50	0.059	<b>0.06</b>	0.112	<b>0.12</b>	0.09
41490	2680	50RB_High	Rear	Note2	26.09	26.50	0.040	<b>0.04</b>	0.075	<b>0.08</b>	0.10
41490	2680	50RB_High	Left	Note3	26.09	26.50	0.054	<b>0.06</b>	0.103	<b>0.11</b>	0.07
41490	2680	50RB_High	Top	Note2	26.09	26.50	0.097	<b>0.11</b>	0.184	<b>0.20</b>	-0.04
39750	2506	50RB_High	Front	/	13.79	14.50	0.064	<b>0.08</b>	0.150	<b>0.18</b>	-0.04
39750	2506	50RB_High	Rear	/	13.79	14.50	0.079	<b>0.09</b>	0.203	<b>0.24</b>	-0.03
39750	2506	50RB_High	Left	/	13.79	14.50	0.018	<b>0.02</b>	0.045	<b>0.05</b>	0.10
39750	2506	50RB_High	Top	/	13.79	14.50	0.062	<b>0.07</b>	0.155	<b>0.18</b>	0.00

Note: The distance between the EUT and the phantom bottom is 0mm.

Note1: The distance between the EUT and the phantom bottom is 21mm.

Note2: The distance between the EUT and the phantom bottom is 26mm.

Note3: The distance between the EUT and the phantom bottom is 12mm.

Note4: The LTE mode is QPSK\_20MHz.

**Table 14.1-17: SAR Values (LTE Band66 - Body)**

Frequency		Mode	Test Position	Figure No./Note	Ambient Temperature: 22.9 °C		Liquid Temperature: 22.5 °C				Power Drift (dB)
Ch.	MHz				Conducted Power (dBm)	Max. tune-up Power (dBm)	Measured SAR(10g) (W/kg)	Reported SAR(10g) (W/kg)	Measured SAR(1g) (W/kg)	Reported SAR(1g) (W/kg)	
132072	1720	1RB_Mid	Front	Note1	25.07	25.50	0.371	<b>0.41</b>	0.604	<b>0.67</b>	0.09
132072	1720	1RB_Mid	Rear	Note2	25.07	25.50	0.307	<b>0.34</b>	0.486	<b>0.54</b>	0.06
132072	1720	1RB_Mid	Left	Note3	25.07	25.50	0.264	<b>0.29</b>	0.451	<b>0.50</b>	0.01
132072	1720	1RB_Mid	Top	Note2	25.07	25.50	0.346	<b>0.38</b>	0.566	<b>0.62</b>	0.03
132072	1720	1RB_Mid	Front	/	12.75	13.50	0.170	<b>0.20</b>	0.358	<b>0.43</b>	0.13
132072	1720	1RB_Mid	Rear	Fig.17	12.75	13.50	0.258	<b>0.31</b>	0.578	<b>0.69</b>	0.15
132072	1720	1RB_Mid	Left	/	12.75	13.50	0.060	<b>0.07</b>	0.131	<b>0.16</b>	0.05
132072	1720	1RB_Mid	Top	/	12.75	13.50	0.249	<b>0.30</b>	0.576	<b>0.68</b>	0.13
132072	1720	50RB_Low	Front	Note1	24.05	24.50	0.285	<b>0.32</b>	0.462	<b>0.51</b>	0.08
132072	1720	50RB_Low	Rear	Note2	24.05	24.50	0.239	<b>0.27</b>	0.377	<b>0.42</b>	0.13
132072	1720	50RB_Low	Left	Note3	24.05	24.50	0.206	<b>0.23</b>	0.353	<b>0.39</b>	-0.13
132072	1720	50RB_Low	Top	Note2	24.05	24.50	0.272	<b>0.30</b>	0.444	<b>0.49</b>	-0.09
132572	1770	50RB_Mid	Front	/	11.66	12.50	0.122	<b>0.15</b>	0.269	<b>0.33</b>	0.02
132572	1770	50RB_Mid	Rear	/	11.66	12.50	0.198	<b>0.24</b>	0.447	<b>0.54</b>	0.00
132572	1770	50RB_Mid	Left	/	11.66	12.50	0.044	<b>0.05</b>	0.098	<b>0.12</b>	0.07
132572	1770	50RB_Mid	Top	/	11.66	12.50	0.186	<b>0.23</b>	0.429	<b>0.52</b>	0.12

Note: The distance between the EUT and the phantom bottom is 0mm.

Note1: The distance between the EUT and the phantom bottom is 21mm.

Note2: The distance between the EUT and the phantom bottom is 26mm.

Note3: The distance between the EUT and the phantom bottom is 12mm.

Note4: The LTE mode is QPSK\_20MHz.



**Table 14.1-18: SAR Values (LTE Band71 - Body)**

Frequency		Mode	Test Position	Figure No./Note	Ambient Temperature: 22.9 °C		Liquid Temperature: 22.5 °C		Measured SAR(1g) (W/kg)	Reported SAR(1g) (W/kg)	Power Drift (dB)
Ch.	MHz				Conducted Power (dBm)	Max. tune-up Power (dBm)	Measured SAR(10g) (W/kg)	Reported SAR(10g) (W/kg)			
133222	673	1RB_Mid	Front	Note1	25.14	25.50	0.082	<b>0.09</b>	0.110	<b>0.12</b>	-0.10
133222	673	1RB_Mid	Rear	Note2	25.14	25.50	0.076	<b>0.08</b>	0.107	<b>0.12</b>	-0.02
133222	673	1RB_Mid	Left	Note3	25.14	25.50	0.033	<b>0.04</b>	0.056	<b>0.06</b>	-0.07
133222	673	1RB_Mid	Top	Note2	25.14	25.50	0.050	<b>0.05</b>	0.072	<b>0.08</b>	0.12
133222	673	1RB_Mid	Front	/	16.13	17.00	0.149	<b>0.18</b>	0.299	<b>0.37</b>	0.02
133222	673	1RB_Mid	Rear	Fig.18	16.13	17.00	0.206	<b>0.25</b>	0.466	<b>0.57</b>	0.18
133222	673	1RB_Mid	Left	/	16.13	17.00	0.029	<b>0.04</b>	0.064	<b>0.08</b>	-0.10
133222	673	1RB_Mid	Top	/	16.13	17.00	0.138	<b>0.17</b>	0.358	<b>0.44</b>	0.09
133222	673	50RB_Mid	Front	Note1	24.15	24.50	0.065	<b>0.07</b>	0.091	<b>0.10</b>	-0.03
133222	673	50RB_Mid	Rear	Note2	24.15	24.50	0.062	<b>0.07</b>	0.086	<b>0.09</b>	-0.06
133222	673	50RB_Mid	Left	Note3	24.15	24.50	0.027	<b>0.03</b>	0.046	<b>0.05</b>	0.10
133222	673	50RB_Mid	Top	Note2	24.15	24.50	0.039	<b>0.04</b>	0.056	<b>0.06</b>	-0.04
133322	683	50RB_Mid	Front	/	15.02	16.00	0.117	<b>0.15</b>	0.236	<b>0.30</b>	0.08
133322	683	50RB_Mid	Rear	/	15.02	16.00	0.161	<b>0.20</b>	0.367	<b>0.46</b>	0.08
133322	683	50RB_Mid	Left	/	15.02	16.00	0.024	<b>0.03</b>	0.053	<b>0.07</b>	-0.10
133322	683	50RB_Mid	Top	/	15.02	16.00	0.108	<b>0.14</b>	0.280	<b>0.35</b>	0.04

Note: The distance between the EUT and the phantom bottom is 0mm.

Note1: The distance between the EUT and the phantom bottom is 21mm.

Note2: The distance between the EUT and the phantom bottom is 26mm.

Note3: The distance between the EUT and the phantom bottom is 12mm.

Note4: The LTE mode is QPSK\_20MHz.

## 14.2 SAR results for Standard procedure

There is zoom scan measurement to be added for the highest measured SAR in each exposure configuration/band.

**Table 14.2-1: SAR Values (WCDMA 850 MHz Band - Body)**

Frequency		Test Position	Figure No./ Note	Ambient Temperature: 22.9 °C		Liquid Temperature: 22.5 °C		Measured SAR(1g) (W/kg)	Reported SAR(1g) (W/kg)	Power Drift (dB)
Ch.	MHz			Conducted Power (dBm)	Max. tune-up Power (dBm)	Measured SAR(10g) (W/kg)	Reported SAR(10g) (W/kg)			
4182	836.4	Front	Note1 Fig.1	24.47	25.50	0.146	<b>0.19</b>	0.272	<b>0.34</b>	-0.19

Note1: The distance between the EUT and the phantom bottom is 21mm.

**Table 14.2-2: SAR Values (WCDMA 1700 MHz Band - Body)**

Frequency		Test Position	Figure No./ Note	Ambient Temperature: 22.9 °C		Liquid Temperature: 22.5 °C		Measured SAR(1g) (W/kg)	Reported SAR(1g) (W/kg)	Power Drift (dB)
Ch.	MHz			Conducted Power (dBm)	Max. tune-up Power (dBm)	Measured SAR(10g) (W/kg)	Reported SAR(10g) (W/kg)			
1513	1752.6	Top	Fig.2	12.73	13.50	0.189	<b>0.23</b>	0.492	<b>0.59</b>	-0.15

Note: The distance between the EUT and the phantom bottom is 0mm.

**Table 14.2-3: SAR Values (WCDMA 1900 MHz Band - Body)**

Frequency		Test Position	Figure No./ Note	Ambient Temperature: 22.9 °C		Liquid Temperature: 22.5 °C		Measured SAR(1g) (W/kg)	Reported SAR(1g) (W/kg)	Power Drift (dB)
Ch.	MHz			Conducted Power (dBm)	Max. tune-up Power (dBm)	Measured SAR(10g) (W/kg)	Reported SAR(10g) (W/kg)			
9538	1907.6	Top	Fig.3	10.80	12.00	0.162	<b>0.21</b>	0.429	<b>0.57</b>	0.14

Note: The distance between the EUT and the phantom bottom is 0mm.

**Table 14.2-4: SAR Values (LTE Band2 - Body)**

Frequency		Mode	Test Position	Figure No./ Note	Ambient Temperature: 22.9 °C		Liquid Temperature: 22.5 °C		Measured SAR(1g) (W/kg)	Reported SAR(1g) (W/kg)	Power Drift (dB)
Ch.	MHz				Conducted Power (dBm)	Max. tune-up Power (dBm)	Measured SAR(10g) (W/kg)	Reported SAR(10g) (W/kg)			
18900	1880	1RB_Mid	Top	Fig.4	11.44	12.20	0.245	<b>0.29</b>	0.645	<b>0.77</b>	0.17

Note: The distance between the EUT and the phantom bottom is 0mm.

Note1: The LTE mode is QPSK\_20MHz.

**Table 14.2-5: SAR Values (LTE Band4 - Body)**

Ambient Temperature: 22.9 °C					Liquid Temperature: 22.5°C						
Frequency		Mode	Test Position	Figure No./Note	Conducted Power (dBm)	Max. tune-up Power (dBm)	Measured SAR(10g) (W/kg)	Reported SAR(10g) (W/kg)	Measured SAR(1g) (W/kg)	Reported SAR(1g) (W/kg)	Power Drift (dB)
Ch.	MHz										
20175	1732.5	1RB_Mid	Rear	Fig.5	12.77	13.50	0.310	<b>0.37</b>	0.767	<b>0.91</b>	-0.12

Note: The distance between the EUT and the phantom bottom is 0mm.

Note1: The LTE mode is QPSK\_20MHz.

**Table 14.2-6: SAR Values (LTE Band5 - Body)**

Ambient Temperature: 22.9 °C					Liquid Temperature: 22.5°C						
Frequency		Mode	Test Position	Figure No./Note	Conducted Power (dBm)	Max. tune-up Power (dBm)	Measured SAR(10g) (W/kg)	Reported SAR(10g) (W/kg)	Measured SAR(1g) (W/kg)	Reported SAR(1g) (W/kg)	Power Drift (dB)
Ch.	MHz										
20600	844	1RB_Low	Rear	Fig.6	18.68	19.00	0.143	<b>0.15</b>	0.323	<b>0.35</b>	0.15

Note: The distance between the EUT and the phantom bottom is 0mm.

Note1: The LTE mode is QPSK\_10MHz.

**Table 14.2-7: SAR Values (LTE Band7 - Body)**

Ambient Temperature: 22.9 °C					Liquid Temperature: 22.5°C						
Frequency		Mode	Test Position	Figure No.	Conducted Power (dBm)	Max. tune-up Power (dBm)	Measured SAR(10g) (W/kg)	Reported SAR(10g) (W/kg)	Measured SAR(1g) (W/kg)	Reported SAR(1g) (W/kg)	Power Drift (dB)
Ch.	MHz										
20850	2510	1RB-Mid	Rear	Fig.7	12.35	13.00	0.288	<b>0.33</b>	0.756	<b>0.88</b>	0.15

Note: The distance between the EUT and the phantom bottom is 0mm.

Note1: The LTE mode is QPSK\_20MHz.

**Table 14.2-8: SAR Values (LTE Band12 - Body)**

Ambient Temperature: 22.9 °C					Liquid Temperature: 22.5°C						
Frequency		Mode	Test Position	Figure No.	Conducted Power (dBm)	Max. tune-up Power (dBm)	Measured SAR(10g) (W/kg)	Reported SAR(10g) (W/kg)	Measured SAR(1g) (W/kg)	Reported SAR(1g) (W/kg)	Power Drift (dB)
Ch.	MHz										
23095	707.5	1RB-Mid	Rear	Fig.8	16.33	17.00	0.239	<b>0.28</b>	0.571	<b>0.67</b>	0.16

Note: The distance between the EUT and the phantom bottom is 0mm.

Note1: The LTE mode is QPSK\_10MHz.

**Table 14.2-9: SAR Values (LTE Band13 - Body)**

Ambient Temperature: 22.9 °C					Liquid Temperature: 22.5°C						
Frequency		Mode	Test Position	Figure No.	Conducted Power (dBm)	Max. tune-up Power (dBm)	Measured SAR(10g) (W/kg)	Reported SAR(10g) (W/kg)	Measured SAR(1g) (W/kg)	Reported SAR(1g) (W/kg)	Power Drift (dB)
Ch.	MHz										
23230	782	1RB-Mid	Rear	Fig.9	15.76	16.50	0.111	<b>0.13</b>	0.251	<b>0.30</b>	0.15

Note: The distance between the EUT and the phantom bottom is 0mm.

Note1: The LTE mode is QPSK\_10MHz.

**Table 14.2-10: SAR Values (LTE Band14 - Body)**

Ambient Temperature: 22.9 °C					Liquid Temperature: 22.5°C						
Frequency		Mode	Test Position	Figure No.	Conducted Power (dBm)	Max. tune-up Power (dBm)	Measured SAR(10g) (W/kg)	Reported SAR(10g) (W/kg)	Measured SAR(1g) (W/kg)	Reported SAR(1g) (W/kg)	Power Drift (dB)
Ch.	MHz										
23330	793	1RB-Mid	Rear	Fig.10	15.97	16.50	0.140	<b>0.16</b>	0.299	<b>0.34</b>	0.14

Note: The distance between the EUT and the phantom bottom is 0mm.

Note1: The LTE mode is QPSK\_10MHz.

**Table 14.2-11: SAR Values (LTE Band17 - Body)**

Ambient Temperature: 22.9 °C					Liquid Temperature: 22.5°C						
Frequency		Mode	Test Position	Figure No.	Conducted Power (dBm)	Max. tune-up Power (dBm)	Measured SAR(10g) (W/kg)	Reported SAR(10g) (W/kg)	Measured SAR(1g) (W/kg)	Reported SAR(1g) (W/kg)	Power Drift (dB)
Ch.	MHz										
23800	711	1RB-Mid	Rear	Fig.11	16.26	17.00	0.207	<b>0.25</b>	0.460	<b>0.55</b>	0.06

Note: The distance between the EUT and the phantom bottom is 0mm.

Note1: The LTE mode is QPSK\_10MHz.

**Table 14.2-12: SAR Values (LTE Band25 - Body)**

Ambient Temperature: 22.9 °C					Liquid Temperature: 22.5°C						
Frequency		Mode	Test Position	Figure No.	Conducted Power (dBm)	Max. tune-up Power (dBm)	Measured SAR(10g) (W/kg)	Reported SAR(10g) (W/kg)	Measured SAR(1g) (W/kg)	Reported SAR(1g) (W/kg)	Power Drift (dB)
Ch.	MHz										
26590	1905	1RB-Mid	Rear	Fig.12	11.54	12.20	0.258	<b>0.30</b>	0.632	<b>0.74</b>	0.17

Note: The distance between the EUT and the phantom bottom is 0mm.

Note1: The LTE mode is QPSK\_20MHz.

**Table 14.2-13: SAR Values (LTE Band26 - Body)**

				Ambient Temperature: 22.9 °C				Liquid Temperature: 22.5°C			
Frequency		Mode	Test Position	Figure No.	Conducted Power (dBm)	Max. tune-up Power (dBm)	Measured SAR(10g) (W/kg)	Reported SAR(10g) (W/kg)	Measured SAR(1g) (W/kg)	Reported SAR(1g) (W/kg)	Power Drift (dB)
Ch.	MHz										
26965	841.5	1RB-Mid	Rear	Fig.13	18.54	19.00	0.123	<b>0.14</b>	0.278	<b>0.31</b>	-0.05

Note: The distance between the EUT and the phantom bottom is 0mm.

Note1: The LTE mode is QPSK\_15MHz.

**Table 14.2-14: SAR Values (LTE Band30- Body)**

				Ambient Temperature: 22.9 °C				Liquid Temperature: 22.5°C			
Frequency		Mode	Test Position	Figure No.	Conducted Power (dBm)	Max. tune-up Power (dBm)	Measured SAR(10g) (W/kg)	Reported SAR(10g) (W/kg)	Measured SAR(1g) (W/kg)	Reported SAR(1g) (W/kg)	Power Drift (dB)
Ch.	MHz										
27710	2310	1RB-Mid	Top	Fig.14	10.49	11.00	0.228	<b>0.26</b>	0.578	<b>0.65</b>	0.12

Note: The distance between the EUT and the phantom bottom is 0mm.

Note1: The LTE mode is QPSK\_10MHz.

**Table 14.2-15: SAR Values (LTE Band41 PC3 - Body)**

				Ambient Temperature: 22.9 °C				Liquid Temperature: 22.5°C			
Frequency		Mode	Test Position	Figure No.	Conducted Power (dBm)	Max. tune-up Power (dBm)	Measured SAR(10g) (W/kg)	Reported SAR(10g) (W/kg)	Measured SAR(1g) (W/kg)	Reported SAR(1g) (W/kg)	Power Drift (dB)
Ch.	MHz										
39750	2506	1RB-Mid	Rear	Fig.15	12.73	13.50	0.155	<b>0.19</b>	0.405	<b>0.48</b>	0.17

Note: The distance between the EUT and the phantom bottom is 0mm.

Note1: The LTE mode is QPSK\_20MHz.

**Table 14.2-16: SAR Values (LTE Band41 PC2 - Body)**

				Ambient Temperature: 22.9 °C				Liquid Temperature: 22.5°C			
Frequency		Mode	Test Position	Figure No.	Conducted Power (dBm)	Max. tune-up Power (dBm)	Measured SAR(10g) (W/kg)	Reported SAR(10g) (W/kg)	Measured SAR(1g) (W/kg)	Reported SAR(1g) (W/kg)	Power Drift (dB)
Ch.	MHz										
39750	2506	1RB-Mid	Rear	Fig.16	15.03	15.50	0.104	<b>0.12</b>	0.272	<b>0.30</b>	0.16

Note: The distance between the EUT and the phantom bottom is 0mm.

Note1: The LTE mode is QPSK\_20MHz.

**Table 14.2-17: SAR Values (LTE Band66 - Body)**

Frequency		Mode	Test Position	Figure No./Note	Ambient Temperature: 22.9 °C		Liquid Temperature: 22.5°C				Power Drift (dB)
Ch.	MHz				Conducted Power (dBm)	Max. tune-up Power (dBm)	Measured SAR(10g) (W/kg)	Reported SAR(10g) (W/kg)	Measured SAR(1g) (W/kg)	Reported SAR(1g) (W/kg)	
132072	1720	1RB_Mid	Rear	Fig.17	12.75	13.50	0.258	<b>0.31</b>	0.578	<b>0.69</b>	0.15

Note: The distance between the EUT and the phantom bottom is 0mm.

Note1: The LTE mode is QPSK\_20MHz.

**Table 14.2-18: SAR Values (LTE Band71 - Body)**

Frequency		Mode	Test Position	Figure No./Note	Ambient Temperature: 22.9 °C		Liquid Temperature: 22.5°C				Power Drift (dB)
Ch.	MHz				Conducted Power (dBm)	Max. tune-up Power (dBm)	Measured SAR(10g) (W/kg)	Reported SAR(10g) (W/kg)	Measured SAR(1g) (W/kg)	Reported SAR(1g) (W/kg)	
133222	673	1RB_Mid	Rear	Fig.18	16.13	17.00	0.206	<b>0.25</b>	0.466	<b>0.57</b>	0.18

Note: The distance between the EUT and the phantom bottom is 0mm.

Note1: The LTE mode is QPSK\_20MHz.

### 14.3 WLAN Evaluation For 2.4G

According to the KDB248227 D01, SAR is measured for 2.4GHz 802.11b DSSS using the initial test position procedure.

#### Body Evaluation

**Table 14.3-4: SAR Values(WLAN - Body)– 802.11b 1Mbps**

Frequency		Test Position	Figure No./ Note	Ambient Temperature: 22.9°C		Liquid Temperature: 22.5°C		Reported SAR(1g)(W/kg)	Reported SAR(1g)(W/kg)	Power Drift (dB)
MHz	Ch.			Conducted Power (dBm)	Max. tune-up Power (dBm)	Measured SAR(10g)(W/kg)	Reported SAR(10g)(W/kg)			
2437	6	Front 24mm	/	18.79	19.00	0.038	<b>0.04</b>	0.069	<b>0.07</b>	0.13
2437	6	Rear 14mm	/	18.79	19.00	0.100	<b>0.10</b>	0.191	<b>0.20</b>	-0.11
2437	6	Right 0mm	/	18.79	19.00	0.059	<b>0.06</b>	0.133	<b>0.14</b>	-0.08
2437	6	Top 27mm	/	18.79	19.00	0.031	<b>0.03</b>	0.055	<b>0.06</b>	-0.15
2437	6	Front 0mm	/	10.96	11.00	0.080	<b>0.08</b>	0.204	<b>0.21</b>	-0.11
2437	6	Rear 0mm	Fig.19	10.96	11.00	0.113	<b>0.11</b>	0.273	<b>0.28</b>	0.07
2437	6	Top 0mm	/	10.96	11.00	0.083	<b>0.08</b>	0.208	<b>0.21</b>	0.08

According to the KDB248227 D01, The reported SAR must be scaled to 100% transmission duty factor to determine compliance at the maximum tune-up tolerance limit. The scaled reported SAR is presented as below.

**Table 14.3-6: SAR Values (WLAN - Body) – 802.11b (Scaled Reported SAR)**

Frequency		Test Position	Ambient Temperature: 22.9°C		Liquid Temperature: 22.5°C	
MHz	Ch.		Actual duty factor	maximum duty factor	Reported SAR (1g)(W/kg)	Scaled reported SAR (1g)(W/kg)
2437	6	Rear 0mm	100%	100%	<b>0.28</b>	<b>0.28</b>

SAR is not required for OFDM because the 802.11b adjusted SAR  $\leq 1.2$  W/kg.

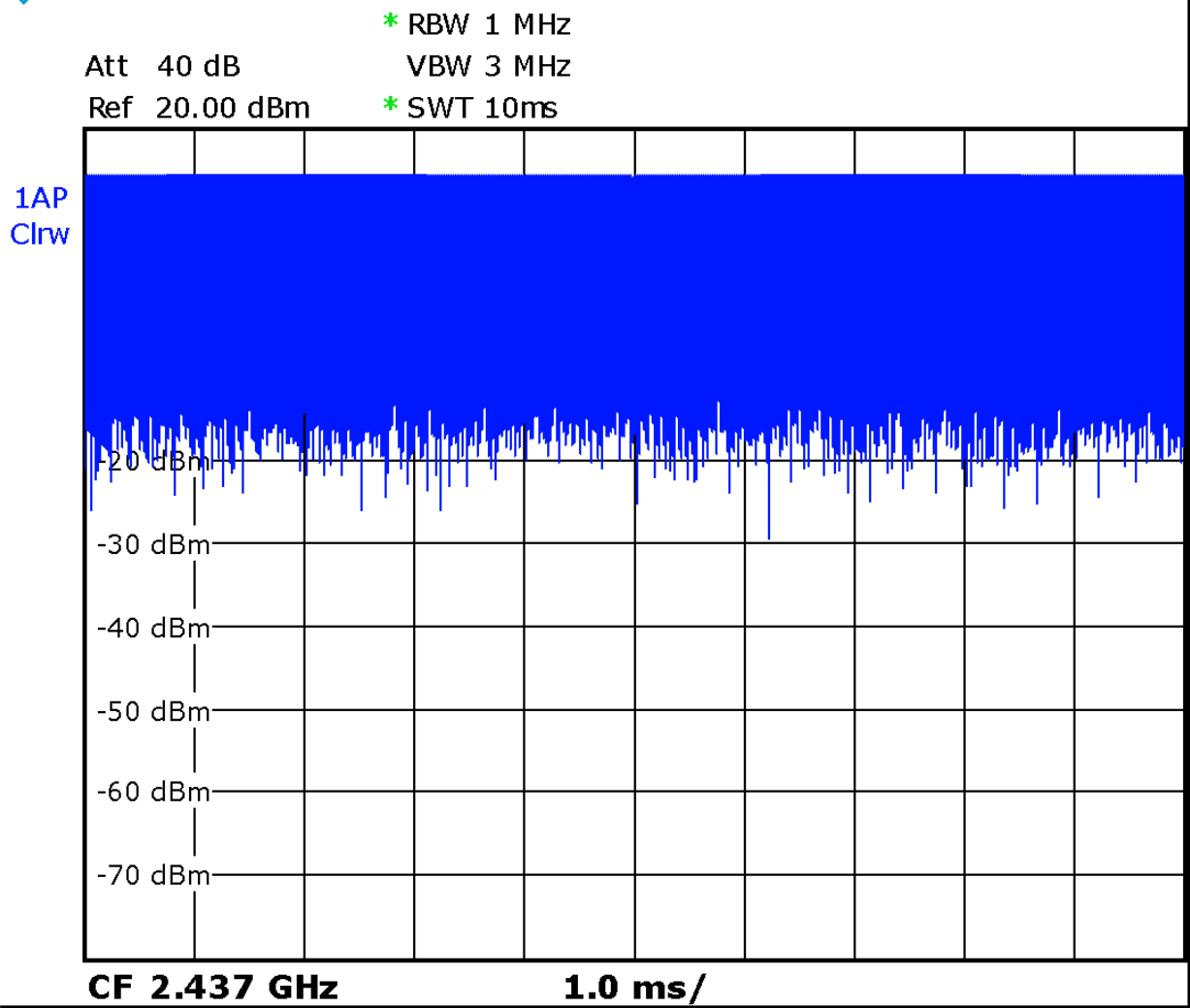

Picture 14.1 Duty factor plot



## 14.4 WLAN Evaluation For 5G

**Table 14.4-1: OFDM mode specified maximum output power of WLAN antenna**

802.11 mode	a	g	n		ac			
Ch. BW(MHz)	20	20	20	40	20	40	80	160
U-NII-1	X		X	X	X	X	X	
U-NII-2A	X		X	X	X	X	X	
U-NII-2C	X		X	X	X	X	X	
U-NII-3	X		X	X	X	X	X	
§ 15.247 (5.8 GHz)								

X: maximum(conducted) output power(mW), including tolerance, specified for production units

**Table 14.4-2: Maximum output power specified of WLAN antenna for Normal Power**

802.11 mode	a	g	n		ac			
Ch. BW(MHz)	20	20	20	40	20	40	80	160
U-NII-1	45		45	45	45	45	45	
U-NII-2A	45		45	45	45	45	45	
U-NII-2C	45		45	45	45	45	45	
U-NII-3	45		45	45	45	45	45	
§ 15.247 (5.8 GHz)								

- The maximum output power specified for production units is the same for all channels, modulations and data rates in each channel bandwidth configuration of the 802.11a/g/n/ac modes.
- The **blue highlighted** cells represent highest output configurations in each standalone or aggregated frequency band, with tune-up tolerance included.

**Table 14.4-3: Maximum output power specified of WLAN antenna for Low Power**

802.11 mode	a	g	n		ac			
Ch. BW(MHz)	20	20	20	40	20	40	80	160
U-NII-1	4		4	4	4	4	4	
U-NII-2A	4		4	4	4	4	4	
U-NII-2C	4		4	4	4	4	4	
U-NII-3	4		4	4	4	4	4	
§ 15.247 (5.8 GHz)								

- The maximum output power specified for production units is the same for all channels, modulations and data rates in each channel bandwidth configuration of the 802.11a/g/n/ac modes.
- The **blue highlighted** cells represent highest output configurations in each standalone or aggregated frequency band, with tune-up tolerance included.

**Table 14.4-4: Maximum output power measured of WLAN antenna, for the applicable OFDM configurations according to the default power measurement procedures for selection initial test configurations - Normal Power**

802.11 mode	a	n		ac		
BW(MHz)	20	20	40	20	40	80
U-NII-1	36/40/44/48 Lower power	36/40/44/48 Lower power	38/46 Lower power	36/40/44/48 Lower power	38/46 Lower power	<b>42</b> <b>40</b>
U-NII-2A	52/56/60/64 Lower power	52/56/60/64 Lower power	54/62 Lower power	52/56/60/64 Lower power	54/62 Lower power	<b>58</b> <b>32</b>
U-NII-2C	100/104/108/112 116/120/124/128 132/136/140/144 Lower power	100/104/108/112 2 116/132/136/140 0 Lower power	102/110/118/126/134/142 Lower power	100/104/108/112/116/132/136/140 Lower power	102/110/134 Lower power	106/122/ <b>13</b> <b>8</b> <b>31/32/38</b>
U-NII-3	149/153/157/161/165 Lower power	149/153/157/161/165 Lower power	151/159 Lower power	149/153/157/161/165 Lower power	151/159 Lower power	<b>155</b> <b>42</b>

- The **bold numbers** is the maximum output measured power (mW).
- Channels with measured maximum power within 0.25dB are considered to have the same measured output. Channels selected for initial test configuration are **highlighted in yellow**.

**Table 14.4-5: Maximum output power measured of WLAN antenna, for the applicable OFDM configurations according to the default power measurement procedures for selection initial test configurations – Low Power**

802.11 mode	a	n		ac		
BW(MHz)	20	20	40	20	40	80
U-NII-1	36/40/44/48 Lower power	36/40/44/48 Lower power	38/46 Lower power	36/40/44/48 Lower power	38/46 Lower power	<b>42</b> <b>3</b>
U-NII-2A	52/56/60/64 Lower power	52/56/60/64 Lower power	54/62 Lower power	52/56/60/64 Lower power	54/62 Lower power	<b>58</b> <b>3</b>
U-NII-2C	100/104/108/112 116/120/124/128 132/136/140/144 Lower power	100/104/108/112 116/132/136/140 Lower power	102/110/134 Lower power	100/104/108/112 116/132/136/140 Lower power	102/110/134 4 Lower power	106/122/ <b>138</b> <b>2/2/3</b>
U-NII-3	149/153/157/161/165	149/153/157/161/165	151/159 Lower	149/153/157/161/165	151/159 Lower	<b>155</b> <b>3</b>

	Lower power	Lower power	power	Lower power	power	
<ul style="list-style-type: none"> <li>The <b>bold numbers</b> is the maximum output measured power (mW).</li> <li>Channels with measured maximum power within 0.25dB are considered to have the same measured output. Channels selected for initial test configuration are <b>highlighted in yellow</b>.</li> </ul>						

**Table 14.4-6: Reported SAR of initial test configuration for Normal Power Body**

802.11 mode	a		n		ac	
BW(MHz)	20	20	40	20	40	80
<b>U-NII-1</b>	36/40/44/48	36/40/44/48	38/46	36/40/44/48	38/46	42 UNII-2A exclusion applied
<b>U-NII-2A</b>	52/56/60/64	52/56/60/64	54/62	52/56/60/64	54/62	<b>58</b> 0.38
<b>U-NII-2C</b>	100/104/108/112/ 116/120/124/128/ 132/136/140/144	100/104/108/11 2 116/132/136/14 0	102/110/11 8/126/134	100/104/108/112 116/132/136/140	102/110/13 4	106/122/ <b>138</b> 0.30
<b>U-NII-3</b>	149/153/157/161/ 165	149/153/157/16 1/165	151/159	149/153/157/161 /165	151/159	<b>155</b> 0.31

Highest measured output power channel tested initially are in **yellow highlight**.

The tune up of UNII-1 is less than UNII-2A. SAR is measured for UNII-2A band first. Adjusted SAR of UNII-2A band is ≤ 1.2 W/kg. SAR is not required for UNII-1 band.

**Table 14.4-7: Reported SAR of initial test configuration for Low Power Body**

802.11 mode	a		n		ac	
BW(MHz)	20	20	40	20	40	80
<b>U-NII-1</b>	36/40/44/48	36/40/44/48	38/46	36/40/44/48	38/46	42 UNII-2A exclusion applied
<b>U-NII-2A</b>	52/56/60/64	52/56/60/64	54/62	52/56/60/64	54/62	<b>58</b> 0.57
<b>U-NII-2C</b>	100/104/108/112/ 116/120/124/128/ 132/136/140/144	100/104/108/11 2 116/132/136/14 0	102/110/11 8/126/134	100/104/108/112 116/132/136/140	102/110/13 4	106/122/ <b>138</b> 0.39
<b>U-NII-3</b>	149/153/157/161/ 165	149/153/157/16 1/165	151/159	149/153/157/161 /165	151/159	<b>155</b> 0.35

Highest measured output power channel tested initially are in **yellow highlight**.

The tune up of UNII-1 is less than UNII-2A. SAR is measured for UNII-2A band first. Adjusted SAR of UNII-2A band is ≤ 1.2 W/kg. SAR is not required for UNII-1 band.

**Table 14.4-8: SAR Values (WLAN - Body)**

Frequency		Test Position	Figure No.	Ambient Temperature: 22.9 °C		Liquid Temperature: 22.5 °C				Power Drift (dB)
MHz	Ch.			Conducted Power (dBm)	Max. tune-up Power (dBm)	Measured SAR(10g) (W/kg)	Reported SAR(10g) (W/kg)	Measured SAR(1g) (W/kg)	Reported SAR(1g) (W/kg)	
5290	58	Front 24mm	/	15.01	16.50	0.107	<b>0.15</b>	0.268	<b>0.38</b>	0.09
5290	58	Rear 14mm	/	15.01	16.50	0.079	<b>0.11</b>	0.226	<b>0.32</b>	0.17
5290	58	Right 0mm	/	15.01	16.50	0.020	<b>0.03</b>	0.073	<b>0.10</b>	0.05
5290	58	Top 27mm	/	15.01	16.50	0.083	<b>0.12</b>	0.198	<b>0.28</b>	0.07
5690	138	Front 24mm	/	15.78	16.50	0.100	<b>0.12</b>	0.252	<b>0.30</b>	-0.06
5690	138	Rear 14mm	/	15.78	16.50	0.061	<b>0.07</b>	0.165	<b>0.19</b>	0.08
5690	138	Right 0mm	/	15.78	16.50	0.021	<b>0.02</b>	0.068	<b>0.08</b>	0.15
5690	138	Top 27mm	/	15.78	16.50	0.087	<b>0.10</b>	0.186	<b>0.22</b>	0.09
5775	155	Front 24mm	/	16.22	16.50	0.113	<b>0.12</b>	0.295	<b>0.31</b>	-0.12
5775	155	Rear 14mm	/	16.22	16.50	0.065	<b>0.07</b>	0.179	<b>0.19</b>	-0.19
5775	155	Right 0mm	/	16.22	16.50	0.036	<b>0.04</b>	0.151	<b>0.16</b>	0.11
5775	155	Top 27mm	/	16.22	16.50	0.083	<b>0.09</b>	0.203	<b>0.22</b>	0.06
5290	58	Front 0mm	Fig.20	4.92	5.50	0.102	<b>0.12</b>	0.502	<b>0.57</b>	0.00
5290	58	Rear 0mm	/	4.92	5.50	0.024	<b>0.03</b>	0.100	<b>0.11</b>	0.04
5290	58	Top 0mm	/	4.92	5.50	0.058	<b>0.07</b>	0.260	<b>0.30</b>	0.17
5690	138	Front 0mm	/	4.69	5.50	0.082	<b>0.10</b>	0.326	<b>0.39</b>	0.03
5690	138	Rear 0mm	/	4.69	5.50	0.025	<b>0.03</b>	0.106	<b>0.13</b>	0.09
5690	138	Top 0mm	/	4.69	5.50	0.059	<b>0.07</b>	0.261	<b>0.31</b>	0.70
5775	155	Front 0mm	/	5.07	5.50	0.707	<b>0.78</b>	0.316	<b>0.35</b>	0.06
5775	155	Rear 0mm	/	5.07	5.50	0.031	<b>0.03</b>	0.135	<b>0.15</b>	0.05
5775	155	Top 0mm	/	5.07	5.50	0.062	<b>0.07</b>	0.263	<b>0.29</b>	0.09

According to the KDB248227 D01, The reported SAR must be scaled to 100% transmission duty factor to determine compliance at the maximum tune-up tolerance limit. The scaled reported SAR is presented as below.

**Table 14.4-9: SAR Values (WLAN - Body) – Scaled Reported SAR**

Frequency		Test Position	D (mm)	Actual duty factor	maximum duty factor	Reported SAR (1g) (W/kg)	Scaled reported SAR (1g) (W/kg)
MHz	Ch.						
5290	58	Front	0	100%	100%	<b>0.57</b>	<b>0.57</b>

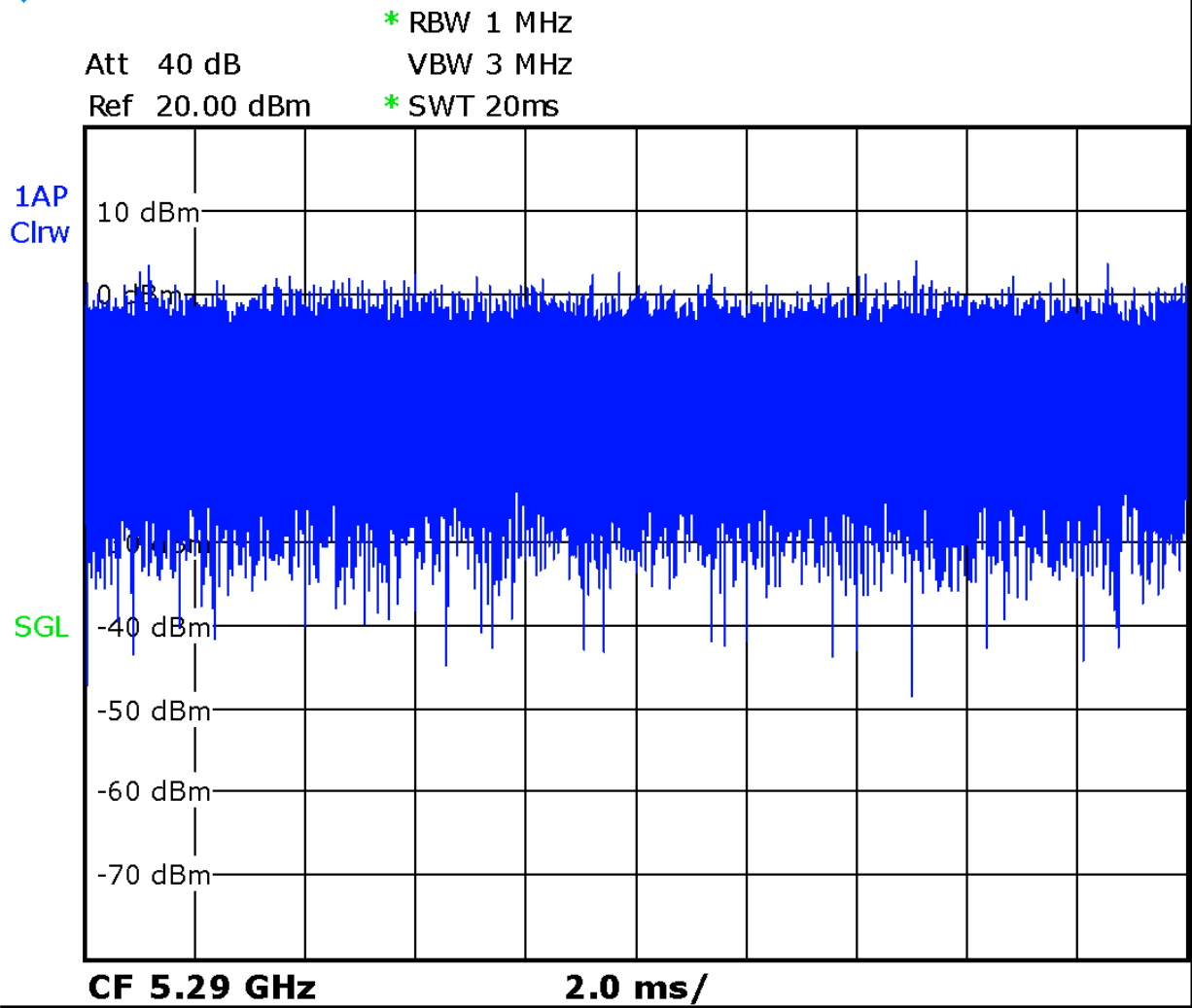

Picture 14.2 The plot of duty factor

### 14.5 SAR results for Fast BT

**Table 14.5-1: SAR Values (Bluetooth - Body)**

Frequency		Test Position	Figure No.	Conducted Power (dBm)	Max. tune-up Power (dBm)	Ambient Temperature: 22.2 °C		Liquid Temperature: 22 °C		Power Drift (dB)
Ch	MHz					Measured SAR(10g) (W/kg)	Reported SAR(10g) (W/kg)	Measured SAR(1g) (W/kg)	Reported SAR(1g) (W/kg)	
78	2480	Front	/	8.14	9	< 0.01	<b>&lt; 0.01</b>	< 0.01	<b>&lt; 0.01</b>	/
78	2480	Rear	/	8.14	9	< 0.01	<b>&lt; 0.01</b>	< 0.01	<b>&lt; 0.01</b>	/
78	2480	Right	/	8.14	9	< 0.01	<b>&lt; 0.01</b>	< 0.01	<b>&lt; 0.01</b>	/
78	2480	Top	/	8.14	9	< 0.01	<b>&lt; 0.01</b>	< 0.01	<b>&lt; 0.01</b>	/

Note1: The distance between the EUT and the phantom bottom is 0mm

## 15 SAR Measurement Variability

SAR measurement variability must be assessed for each frequency band, which is determined by the SAR probe calibration point and tissue-equivalent medium used for the device measurements. When both head and body tissue-equivalent media are required for SAR measurements in a frequency band, the variability measurement procedures should be applied to the tissue medium with the highest measured SAR, using the highest measured SAR configuration for that tissue-equivalent medium.

The following procedures are applied to determine if repeated measurements are required.

- 1) Repeated measurement is not required when the original highest measured SAR is  $< 0.80$  W/kg; steps 2) through 4) do not apply.
- 2) When the original highest measured SAR is  $\geq 0.80$  W/kg, repeat that measurement once.
- 3) Perform a second repeated measurement only if the ratio of largest to smallest SAR for the original and first repeated measurements is  $> 1.20$  or when the original or repeated measurement is  $\geq 1.45$  W/kg ( $\sim 10\%$  from the 1-g SAR limit).
- 4) Perform a third repeated measurement only if the original, first or second repeated measurement is  $\geq 1.5$  W/kg and the ratio of largest to smallest SAR for the original, first and second repeated measurements is  $> 1.20$ .

## 16 Measurement Uncertainty

### 16.1 Measurement Uncertainty for Normal SAR Tests (300MHz~3GHz)

No.	Error Description	Type	Uncertainty value	Probably Distribution	Div.	(Ci) 1g	(Ci) 10g	Std. Unc. (1g)	Std. Unc. (10g)	Degree of freedom
<b>Measurement system</b>										
1	Probe calibration	B	6.0	N	1	1	1	6.0	6.0	$\infty$
2	Isotropy	B	4.7	R	$\sqrt{3}$	0.7	0.7	1.9	1.9	$\infty$
3	Boundary effect	B	1.0	R	$\sqrt{3}$	1	1	0.6	0.6	$\infty$
4	Linearity	B	4.7	R	$\sqrt{3}$	1	1	2.7	2.7	$\infty$
5	Detection limit	B	1.0	N	1	1	1	0.6	0.6	$\infty$
6	Readout electronics	B	0.3	R	$\sqrt{3}$	1	1	0.3	0.3	$\infty$
7	Response time	B	0.8	R	$\sqrt{3}$	1	1	0.5	0.5	$\infty$
8	Integration time	B	2.6	R	$\sqrt{3}$	1	1	1.5	1.5	$\infty$
9	RF ambient conditions-noise	B	0	R	$\sqrt{3}$	1	1	0	0	$\infty$
10	RF ambient conditions-reflection	B	0	R	$\sqrt{3}$	1	1	0	0	$\infty$
11	Probe positioned mech. restrictions	B	0.4	R	$\sqrt{3}$	1	1	0.2	0.2	$\infty$
12	Probe positioning with respect to phantom shell	B	2.9	R	$\sqrt{3}$	1	1	1.7	1.7	$\infty$
13	Post-processing	B	1.0	R	$\sqrt{3}$	1	1	0.6	0.6	$\infty$
<b>Test sample related</b>										
14	Test sample positioning	A	3.3	N	1	1	1	3.3	3.3	71
15	Device holder uncertainty	A	3.4	N	1	1	1	3.4	3.4	5
16	Drift of output power	B	5.0	R	$\sqrt{3}$	1	1	2.9	2.9	$\infty$
<b>Phantom and set-up</b>										
17	Phantom uncertainty	B	4.0	R	$\sqrt{3}$	1	1	2.3	2.3	$\infty$
18	Liquid conductivity (target)	B	5.0	R	$\sqrt{3}$	0.64	0.43	1.8	1.2	$\infty$
19	Liquid conductivity (meas.)	A	2.06	N	1	0.64	0.43	1.32	0.89	43
20	Liquid permittivity (target)	B	5.0	R	$\sqrt{3}$	0.6	0.49	1.7	1.4	$\infty$
21	Liquid permittivity (meas.)	A	1.6	N	1	0.6	0.49	1.0	0.8	521

Combined standard uncertainty	$u_c' = \sqrt{\sum_{i=1}^{21} c_i^2 u_i^2}$							9.55	9.43	257
Expanded uncertainty (confidence interval of 95 %)	$u_e = 2u_c$							19.1	18.9	

**16.2 Measurement Uncertainty for Normal SAR Tests (3~6GHz)**

No.	Error Description	Type	Uncertainty value	Probably Distribution	Div.	(Ci) 1g	(Ci) 10g	Std. Unc. (1g)	Std. Unc. (10g)	Degree of freedom
<b>Measurement system</b>										
1	Probe calibration	B	6.55	N	1	1	1	6.55	6.55	$\infty$
2	Isotropy	B	4.7	R	$\sqrt{3}$	0.7	0.7	1.9	1.9	$\infty$
3	Boundary effect	B	2.0	R	$\sqrt{3}$	1	1	1.2	1.2	$\infty$
4	Linearity	B	4.7	R	$\sqrt{3}$	1	1	2.7	2.7	$\infty$
5	Detection limit	B	1.0	R	$\sqrt{3}$	1	1	0.6	0.6	$\infty$
6	Readout electronics	B	0.3	R	$\sqrt{3}$	1	1	0.3	0.3	$\infty$
7	Response time	B	0.8	R	$\sqrt{3}$	1	1	0.5	0.5	$\infty$
8	Integration time	B	2.6	R	$\sqrt{3}$	1	1	1.5	1.5	$\infty$
9	RF ambient conditions-noise	B	0	R	$\sqrt{3}$	1	1	0	0	$\infty$
10	RFambient conditions-reflection	B	0	R	$\sqrt{3}$	1	1	0	0	$\infty$
11	Probe positioned mech. restrictions	B	0.8	R	$\sqrt{3}$	1	1	0.5	0.5	$\infty$
12	Probe positioning with respect to phantom shell	B	6.7	R	$\sqrt{3}$	1	1	3.9	3.9	$\infty$
13	Post-processing	B	4.0	R	$\sqrt{3}$	1	1	2.3	2.3	$\infty$
<b>Test sample related</b>										
14	Test sample positioning	A	3.3	N	1	1	1	3.3	3.3	71
15	Device holder uncertainty	A	3.4	N	1	1	1	3.4	3.4	5
16	Drift of output power	B	5.0	R	$\sqrt{3}$	1	1	2.9	2.9	$\infty$
<b>Phantom and set-up</b>										
17	Phantom uncertainty	B	4.0	R	$\sqrt{3}$	1	1	2.3	2.3	$\infty$
18	Liquid conductivity (target)	B	5.0	R	$\sqrt{3}$	0.64	0.43	1.8	1.2	$\infty$
19	Liquid conductivity (meas.)	A	2.06	N	1	0.64	0.43	1.32	0.89	43
20	Liquid permittivity (target)	B	5.0	R	$\sqrt{3}$	0.6	0.49	1.7	1.4	$\infty$



21	Liquid permittivity (meas.)	A	1.6	N	1	0.6	0.49	1.0	0.8	521
Combined standard uncertainty		$u_c = \sqrt{\sum_{i=1}^{21} c_i^2 u_i^2}$						10.7	10.6	257
Expanded uncertainty (confidence interval of 95 %)		$u_e = 2u_c$						21.4	21.1	

### 16.3 Measurement Uncertainty for Fast SAR Tests (300MHz~3GHz)

No.	Error Description	Type	Uncertainty value	Probably Distribution	Div.	(Ci) 1g	(Ci) 10g	Std. Unc. (1g)	Std. Unc. (10g)	Degree of freedom
<b>Measurement system</b>										
1	Probe calibration	B	6.0	N	1	1	1	6.0	6.0	∞
2	Isotropy	B	4.7	R	$\sqrt{3}$	0.7	0.7	1.9	1.9	∞
3	Boundary effect	B	1.0	R	$\sqrt{3}$	1	1	0.6	0.6	∞
4	Linearity	B	4.7	R	$\sqrt{3}$	1	1	2.7	2.7	∞
5	Detection limit	B	1.0	R	$\sqrt{3}$	1	1	0.6	0.6	∞
6	Readout electronics	B	0.3	R	$\sqrt{3}$	1	1	0.3	0.3	∞
7	Response time	B	0.8	R	$\sqrt{3}$	1	1	0.5	0.5	∞
8	Integration time	B	2.6	R	$\sqrt{3}$	1	1	1.5	1.5	∞
9	RF ambient conditions-noise	B	0	R	$\sqrt{3}$	1	1	0	0	∞
10	RFambient conditions-reflection	B	0	R	$\sqrt{3}$	1	1	0	0	∞
11	Probe positioned mech. Restrictions	B	0.4	R	$\sqrt{3}$	1	1	0.2	0.2	∞
12	Probe positioning with respect to phantom shell	B	2.9	R	$\sqrt{3}$	1	1	1.7	1.7	∞
13	Post-processing	B	1.0	R	$\sqrt{3}$	1	1	0.6	0.6	∞
14	Fast SAR z-Approximation	B	7.0	R	$\sqrt{3}$	1	1	4.0	4.0	∞
<b>Test sample related</b>										
15	Test sample positioning	A	3.3	N	1	1	1	3.3	3.3	71
16	Device holder uncertainty	A	3.4	N	1	1	1	3.4	3.4	5
17	Drift of output power	B	5.0	R	$\sqrt{3}$	1	1	2.9	2.9	∞
<b>Phantom and set-up</b>										
18	Phantom uncertainty	B	4.0	R	$\sqrt{3}$	1	1	2.3	2.3	∞
19	Liquid conductivity (target)	B	5.0	R	$\sqrt{3}$	0.64	0.43	1.8	1.2	∞

20	Liquid conductivity (meas.)	A	2.06	N	1	0.64	0.43	1.32	0.89	43
21	Liquid permittivity (target)	B	5.0	R	$\sqrt{3}$	0.6	0.49	1.7	1.4	$\infty$
22	Liquid permittivity (meas.)	A	1.6	N	1	0.6	0.49	1.0	0.8	521
Combined standard uncertainty		$u_c = \sqrt{\sum_{i=1}^{22} c_i^2 u_i^2}$						10.4	10.3	257
Expanded uncertainty (confidence interval of 95 %)		$u_e = 2u_c$						20.8	20.6	

#### 16.4 Measurement Uncertainty for Fast SAR Tests (3~6GHz)

No.	Error Description	Type	Uncertainty value	Probably Distribution	Div.	(Ci) 1g	(Ci) 10g	Std. Unc. (1g)	Std. Unc. (10g)	Degree of freedom
<b>Measurement system</b>										
1	Probe calibration	B	6.55	N	1	1	1	6.55	6.55	$\infty$
2	Isotropy	B	4.7	R	$\sqrt{3}$	0.7	0.7	1.9	1.9	$\infty$
3	Boundary effect	B	2.0	R	$\sqrt{3}$	1	1	1.2	1.2	$\infty$
4	Linearity	B	4.7	R	$\sqrt{3}$	1	1	2.7	2.7	$\infty$
5	Detection limit	B	1.0	R	$\sqrt{3}$	1	1	0.6	0.6	$\infty$
6	Readout electronics	B	0.3	R	$\sqrt{3}$	1	1	0.3	0.3	$\infty$
7	Response time	B	0.8	R	$\sqrt{3}$	1	1	0.5	0.5	$\infty$
8	Integration time	B	2.6	R	$\sqrt{3}$	1	1	1.5	1.5	$\infty$
9	RF ambient conditions-noise	B	0	R	$\sqrt{3}$	1	1	0	0	$\infty$
10	RF ambient conditions-reflection	B	0	R	$\sqrt{3}$	1	1	0	0	$\infty$
11	Probe positioned mech. Restrictions	B	0.8	R	$\sqrt{3}$	1	1	0.5	0.5	$\infty$
12	Probe positioning with respect to phantom shell	B	6.7	R	$\sqrt{3}$	1	1	3.9	3.9	$\infty$
13	Post-processing	B	1.0	R	$\sqrt{3}$	1	1	0.6	0.6	$\infty$
14	Fast SAR z-Approximation	B	14.0	R	$\sqrt{3}$	1	1	8.1	8.1	$\infty$
<b>Test sample related</b>										
15	Test sample positioning	A	3.3	N	1	1	1	3.3	3.3	71
16	Device holder uncertainty	A	3.4	N	1	1	1	3.4	3.4	5
17	Drift of output power	B	5.0	R	$\sqrt{3}$	1	1	2.9	2.9	$\infty$

Phantom and set-up										
18	Phantom uncertainty	B	4.0	R	$\sqrt{3}$	1	1	2.3	2.3	$\infty$
19	Liquid conductivity (target)	B	5.0	R	$\sqrt{3}$	0.64	0.43	1.8	1.2	$\infty$
20	Liquid conductivity (meas.)	A	2.06	N	1	0.64	0.43	1.32	0.89	43
21	Liquid permittivity (target)	B	5.0	R	$\sqrt{3}$	0.6	0.49	1.7	1.4	$\infty$
22	Liquid permittivity (meas.)	A	1.6	N	1	0.6	0.49	1.0	0.8	521
Combined standard uncertainty		$u_c = \sqrt{\sum_{i=1}^{22} c_i^2 u_i^2}$						13.5	13.4	257
Expanded uncertainty (confidence interval of 95 %)		$u_e = 2u_c$						27.0	26.8	

## 17 MAIN TEST INSTRUMENTS

**Table 17.1: List of Main Instruments**

No.	Name	Type	Serial Number	Calibration Date	Valid Period
01	Network analyzer	E5071C	MY46110673	January 14, 2021	One year
02	Power meter	NRP2	101919	May 12, 2020	One year
03	Power sensor	NRP-Z91	101547		
04	Signal Generator	E4438C	MY49070393	May 14, 2020	One Year
05	Amplifier	60S1G4	0331848	No Calibration Requested	
06	BTS	CMW500	159890	January 25 2021	One year
07	E-field Probe	SPEAG EX3DV4	7600	November 30, 2020	One year
08	E-field Probe	SPEAG EX3DV4	7548	June 16, 2020	One year
09	E-field Probe	SPEAG EX3DV4	7517	February 3, 2021	One year
10	E-field Probe	SPEAG EX3DV4	7464	December 18, 2020	One year
11	DAE	SPEAG DAE4	1525	September 2, 2020	One year
12	DAE	SPEAG DAE4	1331	September 2, 2020	One year
13	DAE	SPEAG DAE4	1588	September 2, 2020	One year
14	Dipole Validation Kit	SPEAG D750V3	1017	July 24,2020	One year
15	Dipole Validation Kit	SPEAG D835V2	4d069	July 24,,2020	One year
16	Dipole Validation Kit	SPEAG D1750V2	1003	July 24, 2020	One year
17	Dipole Validation Kit	SPEAG D1900V2	5d101	July 28,2020	One year
18	Dipole Validation Kit	SPEAG D2450V2	853	July 21,2020	One year
19	Dipole Validation Kit	SPEAG D2600V2	1012	July 21,2020	One year
20	Dipole Validation Kit	SPEAG D5GHzV2	1060	July 27,2020	One year
21	Dipole Validation Kit	SPEAG D2300V2	1018	July 21,2020	One year

\*\*\*END OF REPORT BODY\*\*\*

## ANNEX A Graph Results

### WCDMA1900 Body

Date/Time: 3/29/2021

Electronics: DAE4 Sn1525

Medium: H1900

Medium parameters used (interpolated):  $f = 1852.4$  MHz;  $\sigma = 1.431$  S/m;  $\epsilon_r = 41.192$ ;  $\rho = 1000$  kg/m<sup>3</sup>

Ambient Temperature: 23.3°C      Liquid Temperature: 22.5°C

Communication System: WCDMA1900(B2) Frequency: 1852.4 MHz Duty Cycle: 1:1

Probe: EX3DV4 - SN7600 ConvF(8.7, 8.7, 8.7)

**Area Scan (81x141x1):** Interpolated grid: dx=1.500 mm, dy=1.500 mm

Maximum value of SAR (interpolated) = 0.660 W/kg

**Zoom Scan (6x6x7)/Cube 0:** Measurement grid: dx=8mm, dy=8mm, dz=5mm

Reference Value = 13.95 V/m; Power Drift = 0.14 dB

Peak SAR (extrapolated) = 1.12 W/kg

**SAR(1 g) = 0.429 W/kg; SAR(10 g) = 0.162 W/kg**

Maximum value of SAR (measured) = 0.848 W/kg

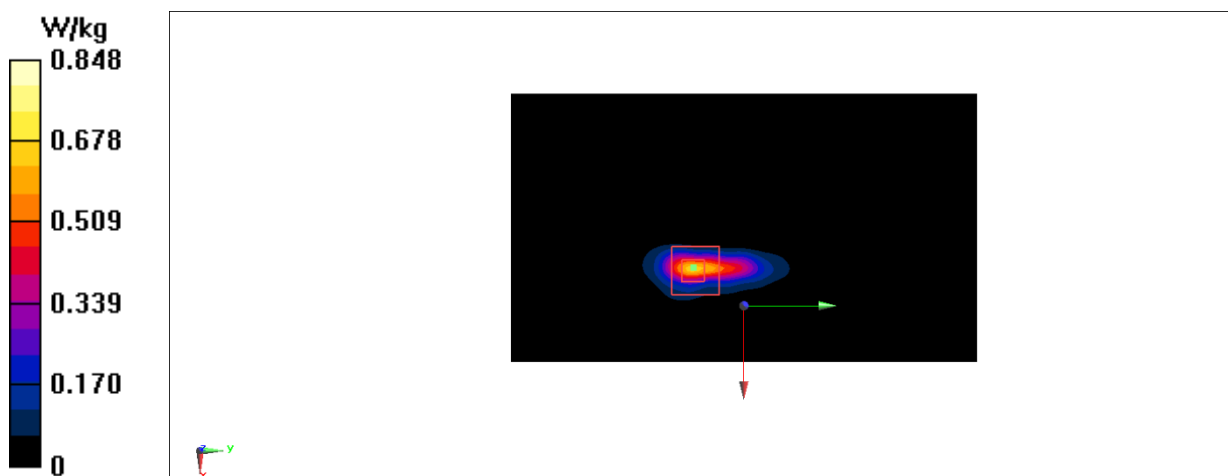

Fig A.1

**WCDMA1700 Body**

Date/Time: 3/29/2021

Electronics: DAE4 Sn1525

Medium: H1700

Medium parameters used (interpolated):  $f = 1752.6$  MHz;  $\sigma = 1.372$  S/m;  $\epsilon_r = 41.473$ ;  $\rho = 1000$  kg/m<sup>3</sup>

Ambient Temperature: 23.3°C      Liquid Temperature: 22.5°C

Communication System: WCDMA1700(B4) Frequency: 1752.6 MHz Duty Cycle: 1:1

Probe: EX3DV4 - SN7600 ConvF(9.01, 9.01, 9.01)

**Area Scan (81x141x1):** Interpolated grid: dx=1.500 mm, dy=1.500 mm

Maximum value of SAR (interpolated) = 0.732 W/kg

**Zoom Scan (6x6x7)/Cube 0:** Measurement grid: dx=8mm, dy=8mm, dz=5mm

Reference Value = 13.98 V/m; Power Drift = -0.15 dB

Peak SAR (extrapolated) = 1.32 W/kg

**SAR(1 g) = 0.492 W/kg; SAR(10 g) = 0.189 W/kg**

Maximum value of SAR (measured) = 0.992 W/kg

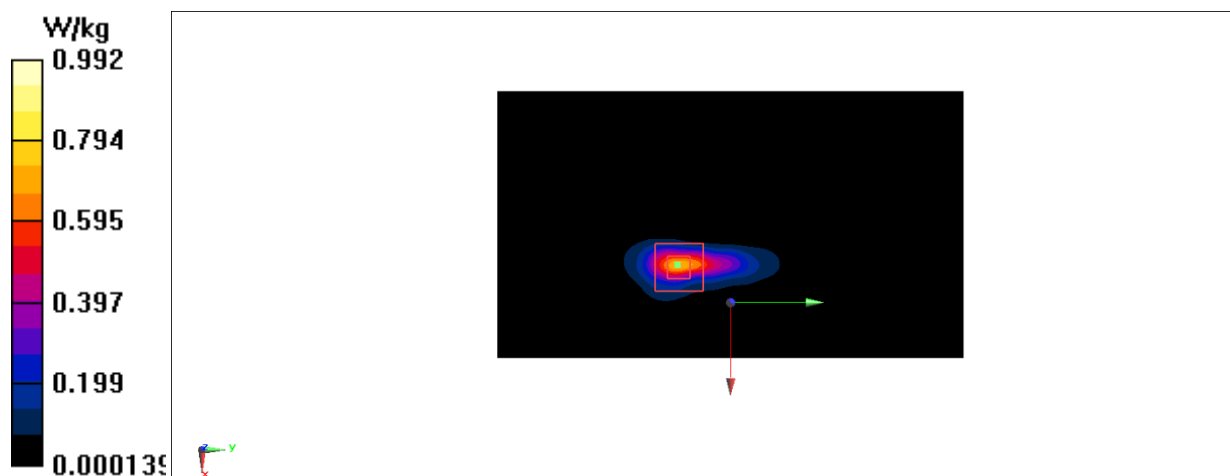

Fig A.2

**WCDMA850 Body**

Date/Time: 3/29/2021

Electronics: DAE4 Sn1525

Medium: H835

Medium parameters used (interpolated):  $f = 836.6$  MHz;  $\sigma = 0.856$  S/m;  $\epsilon_r = 43.76$ ;  $\rho = 1000$  kg/m<sup>3</sup>

Ambient Temperature: 23.3°C      Liquid Temperature: 22.5°C

Communication System: WCDMA850(B5) Frequency: 836.6 MHz Duty Cycle: 1:1

Probe: EX3DV4 - SN7600 ConvF(10.88, 10.88, 10.88)

**Area Scan (81x141x1):** Interpolated grid: dx=1.500 mm, dy=1.500 mm

Maximum value of SAR (interpolated) = 0.218 W/kg

**Zoom Scan (6x6x7)/Cube 0:** Measurement grid: dx=8mm, dy=8mm, dz=5mm

Reference Value = 12.13 V/m; Power Drift = -0.19 dB

Peak SAR (extrapolated) = 0.705 W/kg

**SAR(1 g) = 0.272 W/kg; SAR(10 g) = 0.146 W/kg**

Maximum value of SAR (measured) = 0.214 W/kg

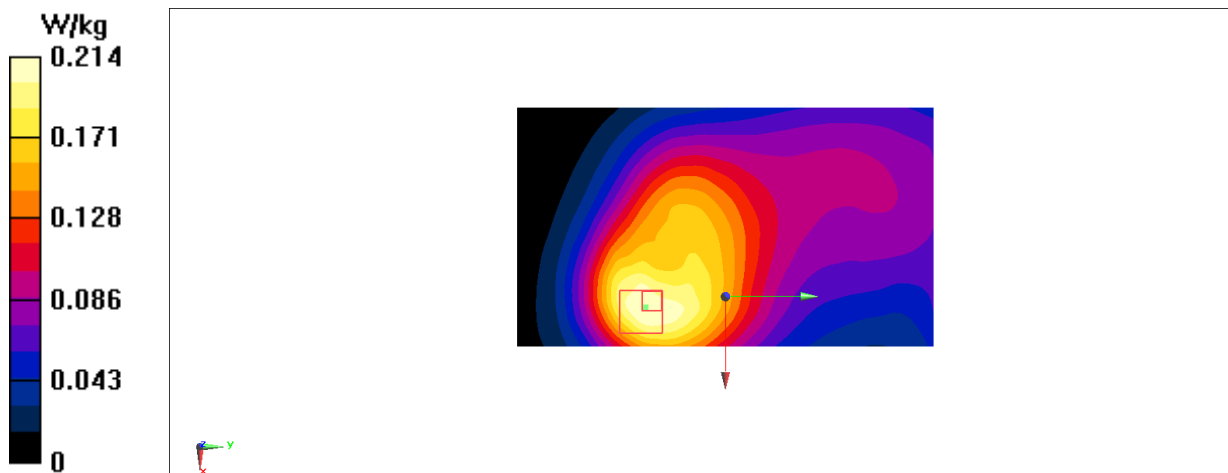

Fig A.3

**LTE Band2 Body**

Date/Time: 3/29/2021

Electronics: DAE4 Sn1525

Medium: H1900

Medium parameters used:  $f = 1880$  MHz;  $\sigma = 1.429$  S/m;  $\epsilon_r = 41.294$ ;  $\rho = 1000$  kg/m<sup>3</sup>

Ambient Temperature: 23.3°C      Liquid Temperature: 22.5°C

Communication System: LTE Band2    Frequency: 1880 MHz Duty Cycle: 1:1

Probe: EX3DV4 - SN7600 ConvF(8.7, 8.7, 8.7)

**Area Scan (81x141x1):** Interpolated grid: dx=1.500 mm, dy=1.500 mm

Maximum value of SAR (interpolated) = 1.23 W/kg

**Zoom Scan (6x6x7)/Cube 0:** Measurement grid: dx=8mm, dy=8mm, dz=5mm

Reference Value = 7.845 V/m; Power Drift = 0.17 dB

Peak SAR (extrapolated) = 1.74 W/kg

**SAR(1 g) = 0.645 W/kg; SAR(10 g) = 0.245 W/kg**

Maximum value of SAR (measured) = 1.41 W/kg

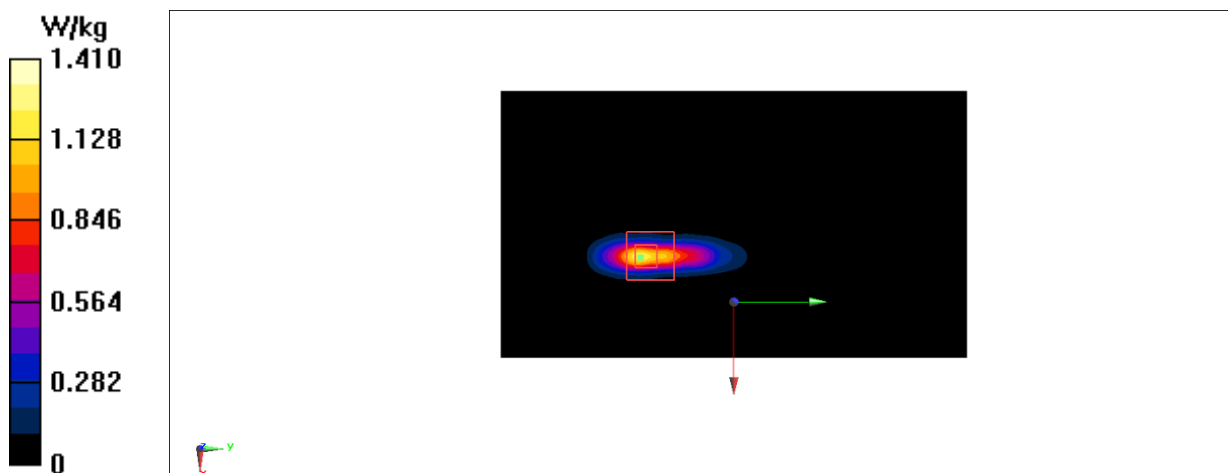

Fig A.4



**LTE Band4 Body**

Date/Time: 3/29/2021

Electronics: DAE4 Sn1525

Medium: H1750

Medium parameters used (interpolated):  $f = 1732.5$  MHz;  $\sigma = 1.329$  S/m;  $\epsilon_r = 41.615$ ;  $\rho = 1000$  kg/m<sup>3</sup>

Ambient Temperature: 23.3oC      Liquid Temperature: 22.5oC

Communication System: LTE Band4    Frequency: 1732.5 MHz Duty Cycle: 1:1

Probe: EX3DV4 - SN7600 ConvF(9.01, 9.01, 9.01)

Area Scan (81x141x1): Interpolated grid: dx=1.500 mm, dy=1.500 mm

Maximum value of SAR (interpolated) = 1.41 W/kg

Zoom Scan (6x6x7)/Cube 0: Measurement grid: dx=8mm, dy=8mm, dz=5mm

Reference Value = 0 V/m; Power Drift = -0.12 dB

Peak SAR (extrapolated) = 2.24 W/kg

SAR(1 g) = 0.767 W/kg; SAR(10 g) = 0.310 W/kg

Maximum value of SAR (measured) = 1.55 W/kg

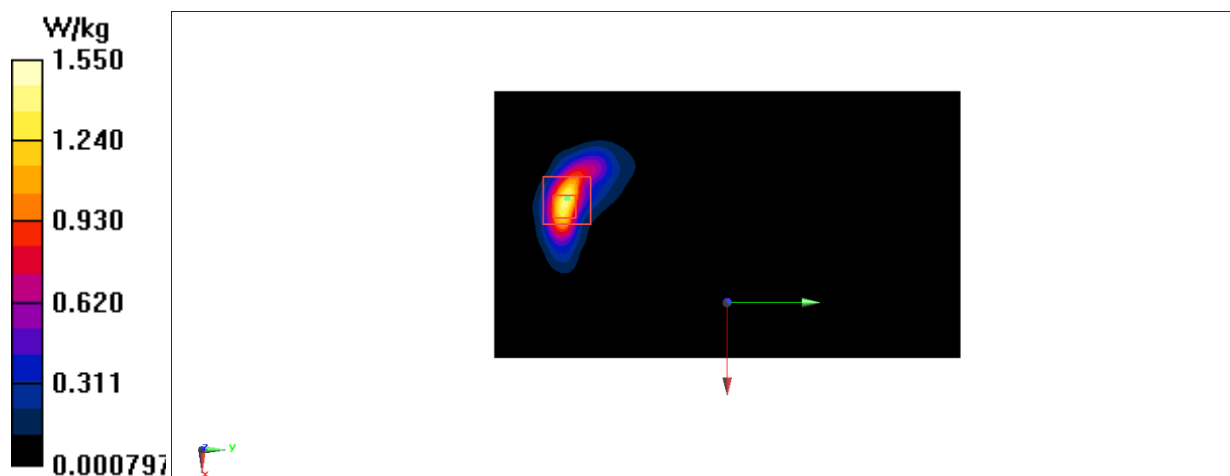

Fig A.5

**LTE Band5 Body**

Date/Time: 4/25/2021

Electronics: DAE4 Sn1331

Medium: H835

Medium parameters used (interpolated):  $f = 844$  MHz;  $\sigma = 0.857$  S/m;  $\epsilon_r = 44.619$ ;  $\rho = 1000$  kg/m<sup>3</sup>

Ambient Temperature: 23.3°C      Liquid Temperature: 22.5°C

Communication System: LTE Band5    Frequency: 844 MHz Duty Cycle: 1:1

Probe: EX3DV4 - SN7548 ConvF(10.17, 10.17, 10.17)

**Area Scan (81x141x1):** Interpolated grid: dx=1.500 mm, dy=1.500 mm

Maximum value of SAR (interpolated) = 0.365 W/kg

**Zoom Scan (7x7x7)/Cube 0:** Measurement grid: dx=5mm, dy=5mm, dz=5mm

Reference Value = 11.06 V/m; Power Drift = 0.15 dB

Peak SAR (extrapolated) = 1.23 W/kg

**SAR(1 g) = 0.323 W/kg; SAR(10 g) = 0.143 W/kg**

Maximum value of SAR (measured) = 0.759 W/kg

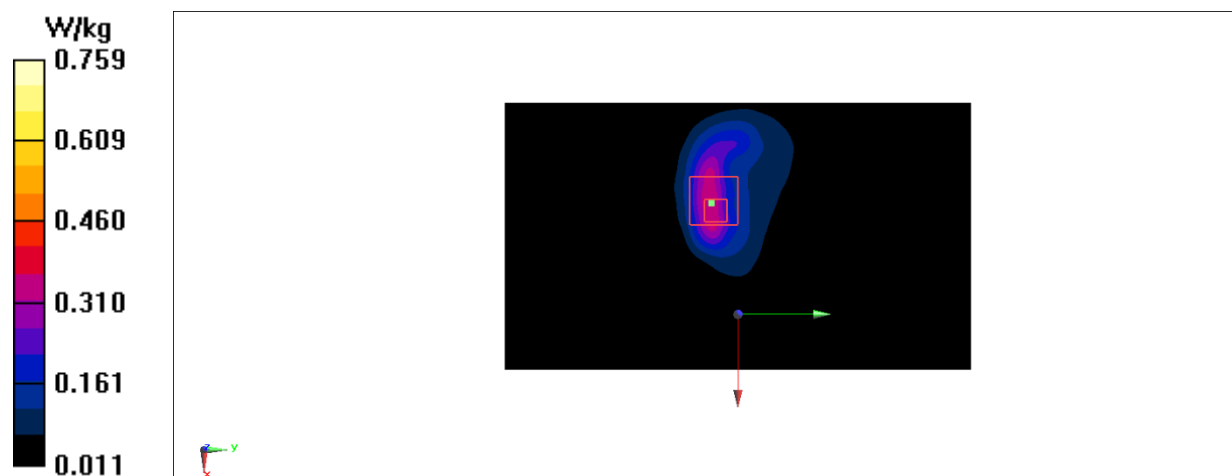

Fig A.6

**LTE Band7 Body**

Date/Time: 3/30/2021

Electronics: DAE4 Sn1525

Medium: H2600

Medium parameters used:  $f = 2510$  MHz;  $\sigma = 1.958$  S/m;  $\epsilon_r = 38.687$ ;  $\rho = 1000$  kg/m<sup>3</sup>

Ambient Temperature: 23.3°C      Liquid Temperature: 22.5°C

Communication System: LTE Band7-20M    Frequency: 2510 MHz Duty Cycle: 1:1

Probe: EX3DV4 - SN7517 ConvF(7.34, 7.34, 7.34)

**Area Scan (141x81x1):** Interpolated grid: dx=1.200 mm, dy=1.200 mm

Maximum value of SAR (interpolated) = 1.67 W/kg

**Zoom Scan (8x8x7)/Cube 0:** Measurement grid: dx=5mm, dy=5mm, dz=5mm

Reference Value = 1.412 V/m; Power Drift = 0.15 dB

Peak SAR (extrapolated) = 2.42 W/kg

**SAR(1 g) = 0.756 W/kg; SAR(10 g) = 0.288 W/kg**

Maximum value of SAR (measured) = 1.59 W/kg

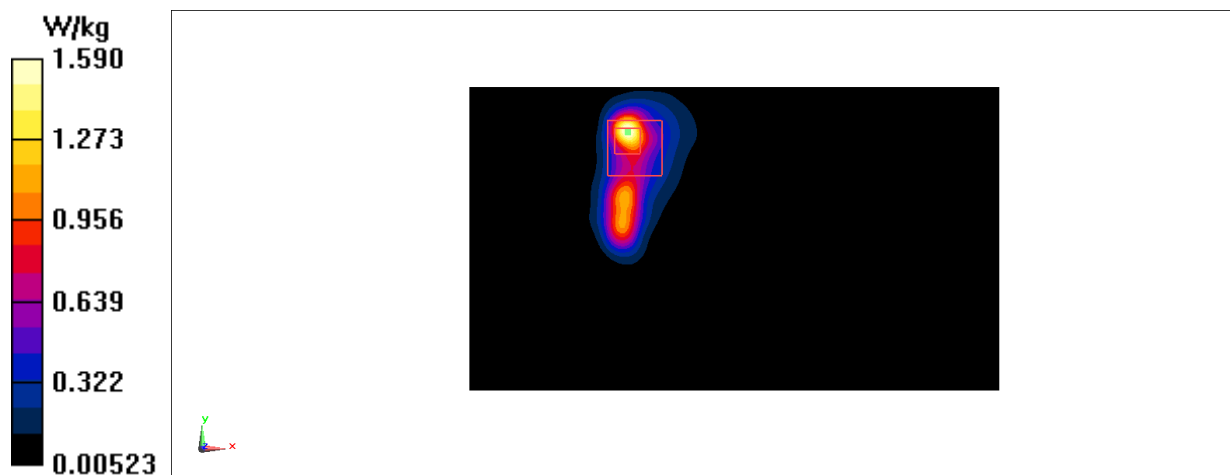

Fig A.7

**LTE Band12 Body**

Date/Time: 3/29/2021

Electronics: DAE4 Sn1525

Medium: H750

Medium parameters used (interpolated):  $f = 704$  MHz;  $\sigma = 0.804$  S/m;  $\epsilon_r = 44.168$ ;  $\rho = 1000$  kg/m<sup>3</sup>

Ambient Temperature: 23.3°C      Liquid Temperature: 22.5°C

Communication System: LTE Band12    Frequency: 704 MHz Duty Cycle: 1:1

Probe: EX3DV4 - SN7600 ConvF(10.88, 10.88, 10.88)

**Area Scan (81x141x1):** Interpolated grid: dx=1.500 mm, dy=1.500 mm

Maximum value of SAR (interpolated) = 0.688 W/kg

**Zoom Scan (6x6x7)/Cube 0:** Measurement grid: dx=8mm, dy=8mm, dz=5mm

Reference Value = 2.538 V/m; Power Drift = 0.16 dB

Peak SAR (extrapolated) = 2.31 W/kg

**SAR(1 g) = 0.571 W/kg; SAR(10 g) = 0.239 W/kg**

Maximum value of SAR (measured) = 1.50 W/kg

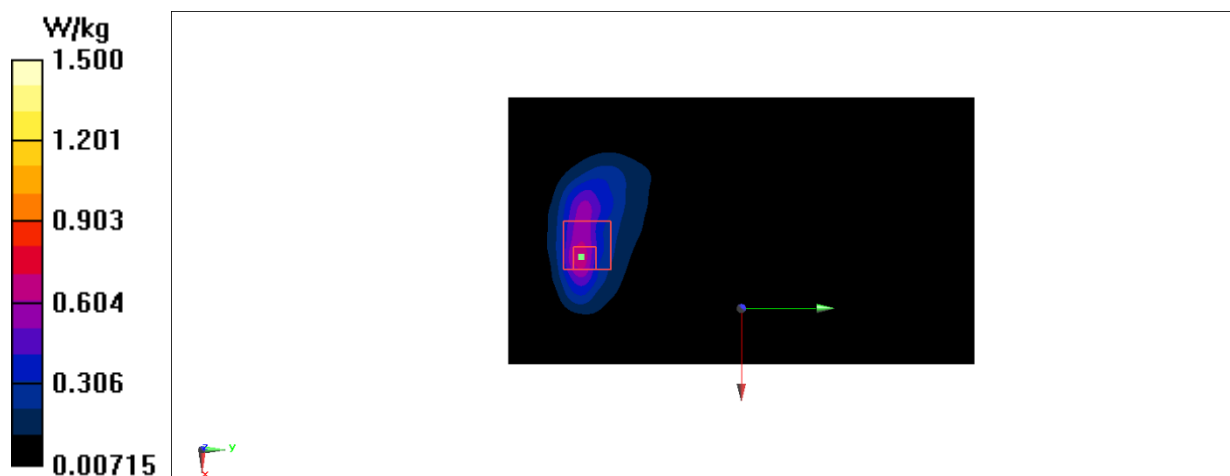

Fig A.8

**LTE Band13 Body**

Date/Time: 3/30/2021

Electronics: DAE4 Sn1525

Medium: H750

Medium parameters used:  $f = 780$  MHz;  $\sigma = 0.858$  S/m;  $\epsilon_r = 42.935$ ;  $\rho = 1000$  kg/m<sup>3</sup>

Ambient Temperature: 23.3°C      Liquid Temperature: 22.5°C

Communication System: LTE Band13    Frequency: 782 MHz Duty Cycle: 1:1

Probe: EX3DV4 - SN7517 ConvF(9.81, 9.81, 9.81)

**Area Scan (141x81x1):** Interpolated grid: dx=1.500 mm, dy=1.500 mm

Maximum value of SAR (interpolated) = 0.565 W/kg

**Zoom Scan (6x7x7)/Cube 0:** Measurement grid: dx=8mm, dy=8mm, dz=5mm

Reference Value = 3.519 V/m; Power Drift = 0.15 dB

Peak SAR (extrapolated) = 0.826 W/kg

**SAR(1 g) = 0.251 W/kg; SAR(10 g) = 0.111 W/kg**

Maximum value of SAR (measured) = 0.517 W/kg

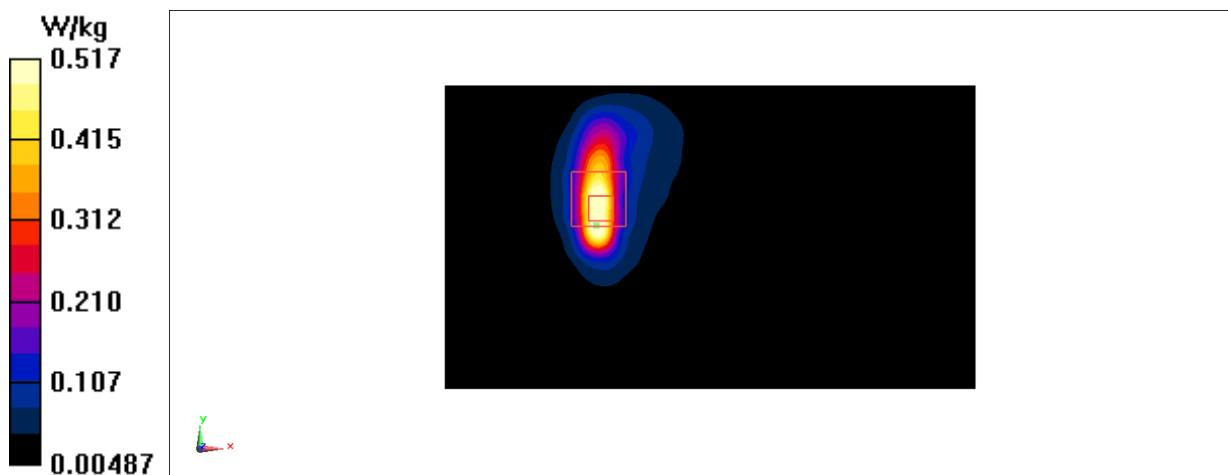

Fig A.9

**LTE Band14 Body**

Date/Time: 4/26/2021

Electronics: DAE4 Sn1525

Medium: H750

Medium parameters used (interpolated):  $f = 793$  MHz;  $\sigma = 0.849$  S/m;  $\epsilon_r = 45.065$ ;  $\rho = 1000$  kg/m<sup>3</sup>

Ambient Temperature: 23.3°C      Liquid Temperature: 22.5°C

Communication System: LTE Band14    Frequency: 793 MHz Duty Cycle: 1:1

Probe: EX3DV4 - SN7600 ConvF(10.88, 10.88, 10.88)

**Area Scan (81x141x1):** Interpolated grid: dx=1.500 mm, dy=1.500 mm

Maximum value of SAR (interpolated) = 0.350 W/kg

**Zoom Scan (7x6x7)/Cube 0:** Measurement grid: dx=8mm, dy=8mm, dz=5mm

Reference Value = 5.474 V/m; Power Drift = 0.14 dB

Peak SAR (extrapolated) = 0.938 W/kg

**SAR(1 g) = 0.299 W/kg; SAR(10 g) = 0.140 W/kg**

Maximum value of SAR (measured) = 0.606 W/kg

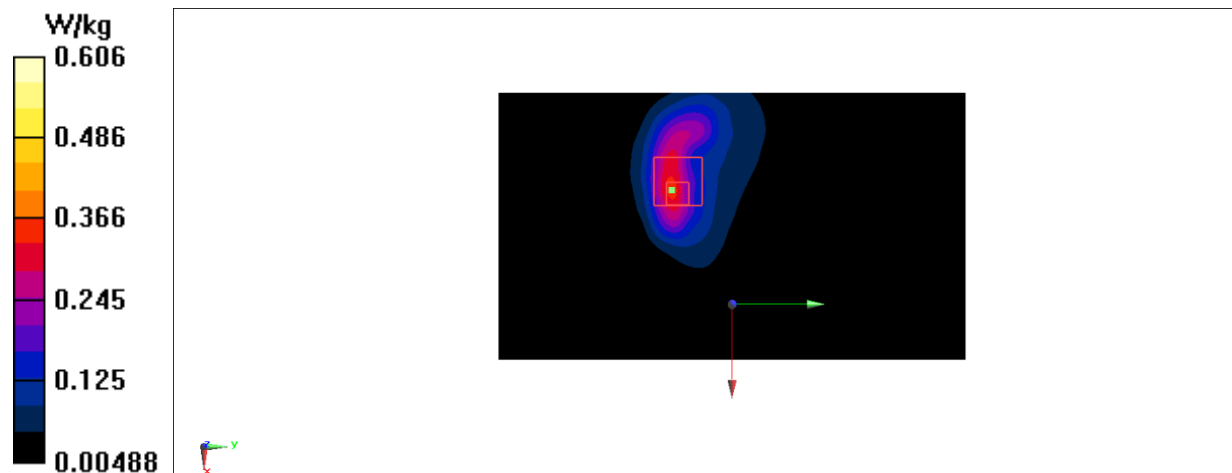

Fig A.10

**LTE Band17 Body**

Date/Time: 4/25/2021

Electronics: DAE4 Sn1331

Medium: H750

Medium parameters used (interpolated):  $f = 711 \text{ MHz}$ ;  $\sigma = 0.805 \text{ S/m}$ ;  $\epsilon_r = 45.051$ ;  $\rho = 1000 \text{ kg/m}^3$ 

Ambient Temperature: 23.3°C      Liquid Temperature: 22.5°C

Communication System: LTE Band17    Frequency: 711 MHz Duty Cycle: 1:1

Probe: EX3DV4 - SN7548 ConvF(10.17, 10.17, 10.17)

**Area Scan (81x141x1):** Interpolated grid:  $dx=1.500 \text{ mm}$ ,  $dy=1.500 \text{ mm}$ 

Maximum value of SAR (interpolated) = 0.739 W/kg

**Zoom Scan (7x7x7)/Cube 0:** Measurement grid:  $dx=5\text{mm}$ ,  $dy=5\text{mm}$ ,  $dz=5\text{mm}$ 

Reference Value = 12.47 V/m; Power Drift = 0.06 dB

Peak SAR (extrapolated) = 1.80 W/kg

**SAR(1 g) = 0.460 W/kg; SAR(10 g) = 0.207 W/kg**

Maximum value of SAR (measured) = 1.08 W/kg

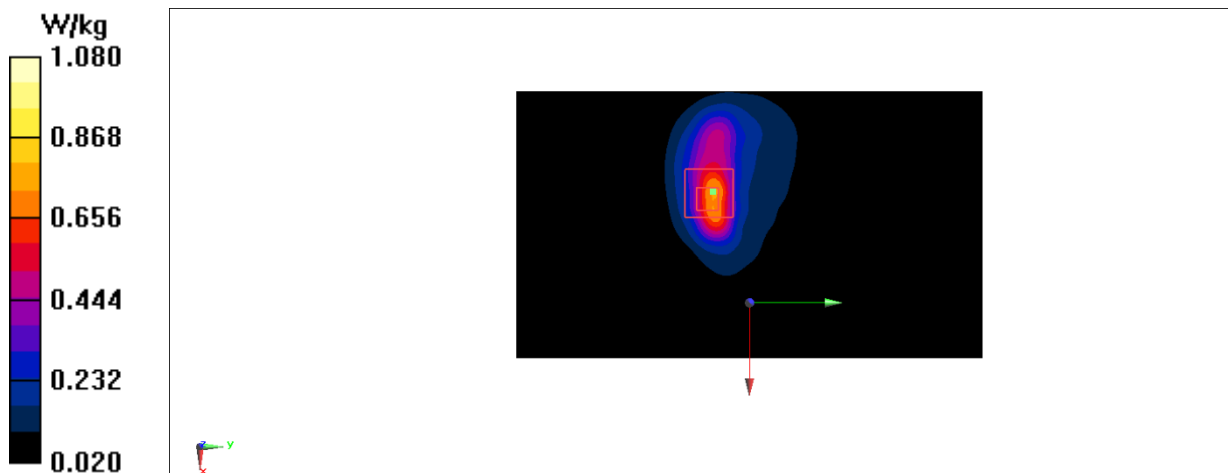

Fig A.11

**LTE Band25 Body**

Date/Time: 3/30/2021

Electronics: DAE4 Sn1525

Medium: H1900

Medium parameters used:  $f = 1905$  MHz;  $\sigma = 1.471$  S/m;  $\epsilon_r = 39.857$ ;  $\rho = 1000$  kg/m<sup>3</sup>

Ambient Temperature: 23.3°C      Liquid Temperature: 22.5°C

Communication System: LTE Band25    Frequency: 1905 MHz Duty Cycle: 1:1

Probe: EX3DV4 - SN7517 ConvF(7.81, 7.81, 7.81)

**Area Scan (141x81x1):** Interpolated grid: dx=1.500 mm, dy=1.500 mm

Maximum value of SAR (interpolated) = 1.33 W/kg

**Zoom Scan (6x6x7)/Cube 0:** Measurement grid: dx=8mm, dy=8mm, dz=5mm

Reference Value = 0.8940 V/m; Power Drift = 0.17 dB

Peak SAR (extrapolated) = 1.49 W/kg

**SAR(1 g) = 0.632 W/kg; SAR(10 g) = 0.258 W/kg**

Maximum value of SAR (measured) = 1.25 W/kg

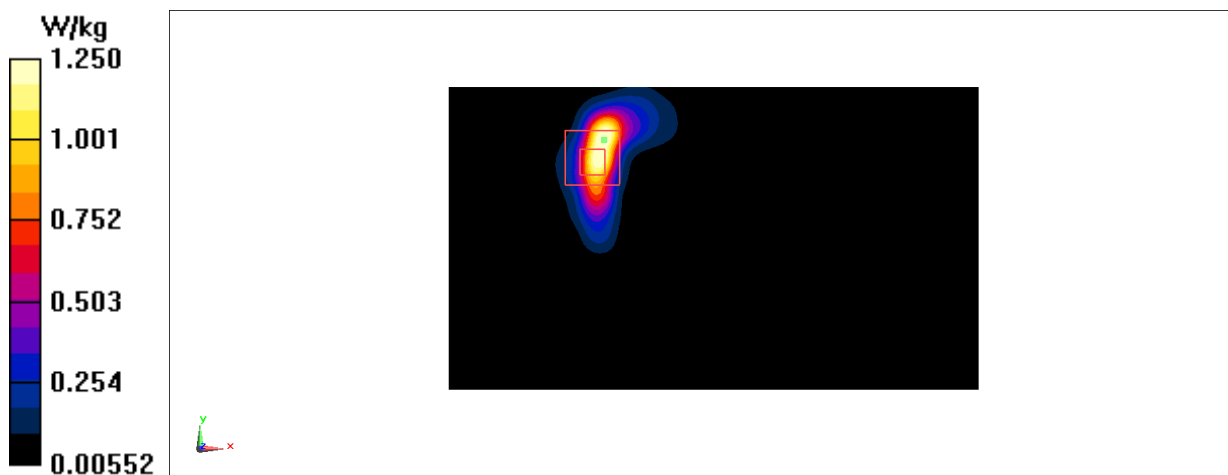

Fig A.12



**LTE Band26 Body**

Date/Time: 3/30/2021

Electronics: DAE4 Sn1525

Medium: H835

Medium parameters used:  $f = 840$  MHz;  $\sigma = 0.88$  S/m;  $\epsilon_r = 42.694$ ;  $\rho = 1000$  kg/m<sup>3</sup>

Ambient Temperature: 23.3°C      Liquid Temperature: 22.5°C

Communication System: LTE Band26      Frequency: 841.5 MHz Duty Cycle: 1:1

Probe: EX3DV4 - SN7517 ConvF(9.81, 9.81, 9.81)

**Area Scan (141x81x1):** Interpolated grid: dx=1.500 mm, dy=1.500 mm

Maximum value of SAR (interpolated) = 0.632 W/kg

**Zoom Scan (6x7x7)/Cube 0:** Measurement grid: dx=8mm, dy=8mm, dz=5mm

Reference Value = 3.752 V/m; Power Drift = -0.05 dB

Peak SAR (extrapolated) = 0.899 W/kg

**SAR(1 g) = 0.278 W/kg; SAR(10 g) = 0.123 W/kg**

Maximum value of SAR (measured) = 0.554 W/kg

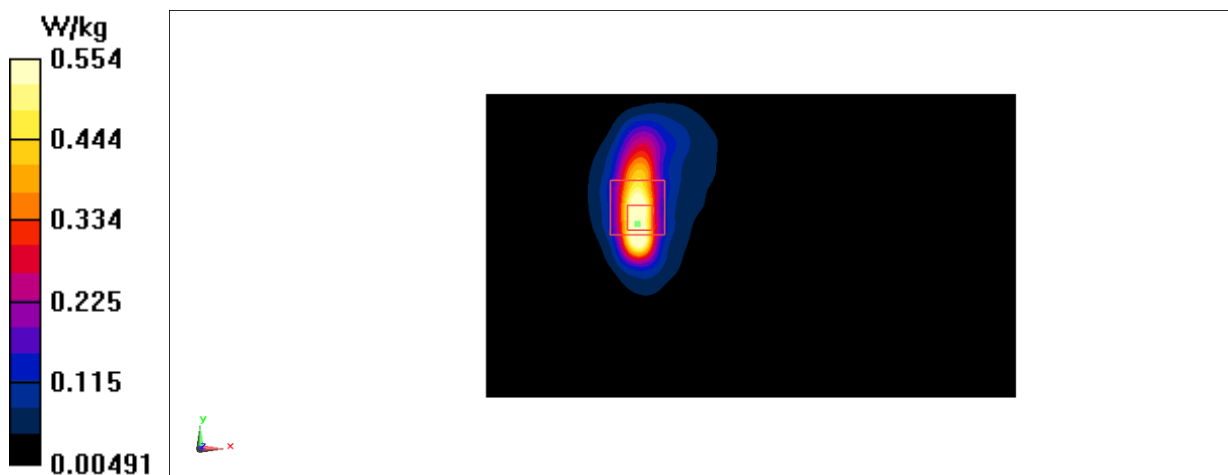

Fig A.13

**LTE Band30 Body**

Date/Time: 3/30/2021

Electronics: DAE4 Sn1525

Medium: H2300

Medium parameters used:  $f = 2310$  MHz;  $\sigma = 1.807$  S/m;  $\epsilon_r = 39.102$ ;  $\rho = 1000$  kg/m<sup>3</sup>

Ambient Temperature: 23.3oC      Liquid Temperature: 22.5oC

Communication System: LTE Band30    Frequency: 2310 MHz Duty Cycle: 1:1

Probe: EX3DV4 - SN7517 ConvF(7.58, 7.58, 7.58)

Area Scan (141x81x1): Interpolated grid: dx=1.200 mm, dy=1.200 mm

Maximum value of SAR (interpolated) = 1.19 W/kg

Zoom Scan (9x7x7)/Cube 0: Measurement grid: dx=5mm, dy=5mm, dz=5mm

Reference Value = 4.740 V/m; Power Drift = 0.12 dB

Peak SAR (extrapolated) = 1.68 W/kg

SAR(1 g) = 0.578 W/kg; SAR(10 g) = 0.228 W/kg

Maximum value of SAR (measured) = 1.20 W/kg

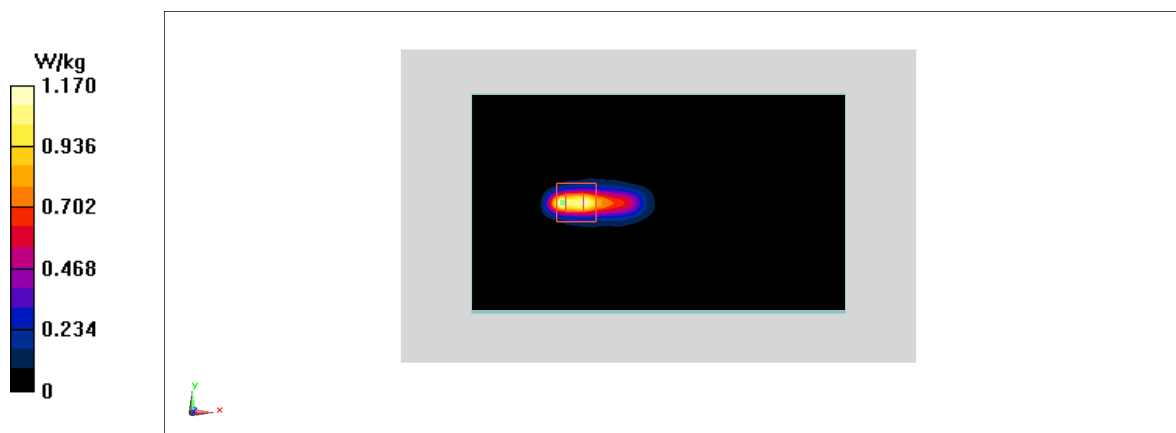

Fig A.14

**LTE Band41 PC3 Body**

Date/Time: 3/30/2021

Electronics: DAE4 Sn1525

Medium: H2600

Medium parameters used:  $f = 2505$  MHz;  $\sigma = 1.954$  S/m;  $\epsilon_r = 38.69$ ;  $\rho = 1000$  kg/m<sup>3</sup>

Ambient Temperature: 23.3°C      Liquid Temperature: 22.5°C

Communication System: LTE Band41    Frequency: 2506 MHz Duty Cycle: 1:1.5787

Probe: EX3DV4 - SN7517 ConvF(7.34, 7.34, 7.34)

**Area Scan (141x81x1):** Interpolated grid: dx=1.200 mm, dy=1.200 mm

Maximum value of SAR (interpolated) = 0.884 W/kg

**Zoom Scan (7x7x7)/Cube 0:** Measurement grid: dx=5mm, dy=5mm, dz=5mm

Reference Value = 1.586 V/m; Power Drift = 0.17 dB

Peak SAR (extrapolated) = 1.30 W/kg

**SAR(1 g) = 0.405 W/kg; SAR(10 g) = 0.155 W/kg**

Maximum value of SAR (measured) = 0.861 W/kg

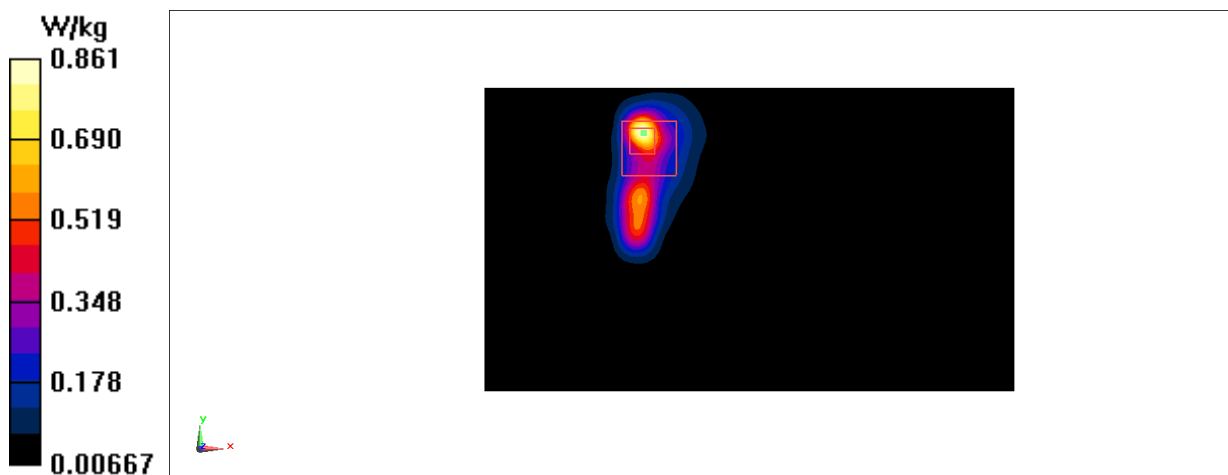

Fig A.15

**LTE Band41 PC2 Body**

Date/Time: 3/30/2021

Electronics: DAE4 Sn1525

Medium: H2600

Medium parameters used:  $f = 2505$  MHz;  $\sigma = 1.954$  S/m;  $\epsilon_r = 38.69$ ;  $\rho = 1000$  kg/m<sup>3</sup>

Ambient Temperature: 23.3°C      Liquid Temperature: 22.5°C

Communication System: LTE Band41    Frequency: 2506 MHz Duty Cycle: 1:2.309

Probe: EX3DV4 - SN7517 ConvF(7.34, 7.34, 7.34)

**Area Scan (141x81x1):** Interpolated grid: dx=1.200 mm, dy=1.200 mm

Maximum value of SAR (interpolated) = 0.575 W/kg

**Zoom Scan (7x7x7)/Cube 0:** Measurement grid: dx=5mm, dy=5mm, dz=5mm

Reference Value = 1.146 V/m; Power Drift = 0.16 dB

Peak SAR (extrapolated) = 0.863 W/kg

**SAR(1 g) = 0.272 W/kg; SAR(10 g) = 0.104 W/kg**

Maximum value of SAR (measured) = 0.574 W/kg

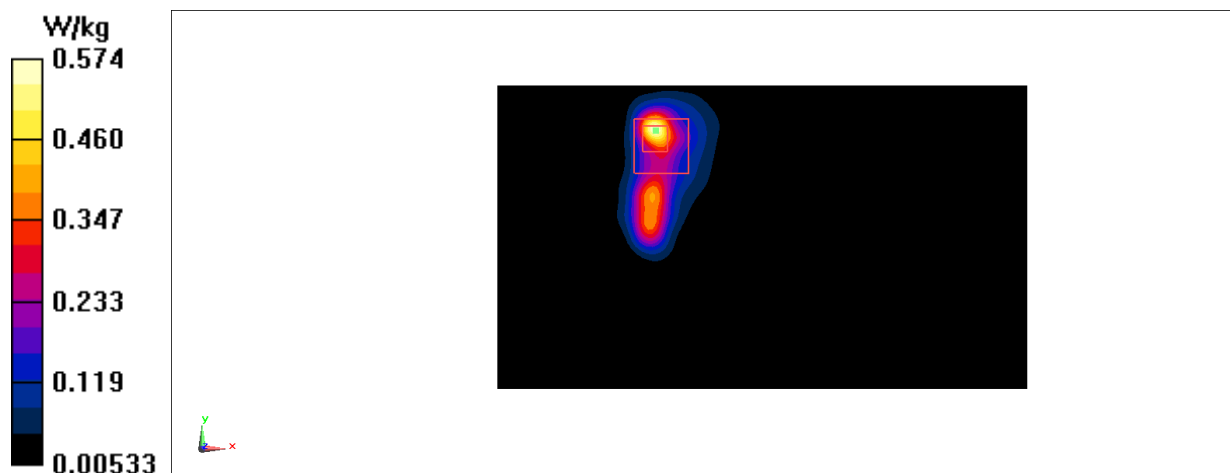

**Fig A.16**

**LTE Band66 Body**

Date/Time: 3/30/2021

Electronics: DAE4 Sn1525

Medium: H1750

Medium parameters used:  $f = 1720$  MHz;  $\sigma = 1.357$  S/m;  $\epsilon_r = 40.325$ ;  $\rho = 1000$  kg/m<sup>3</sup>

Ambient Temperature: 23.3°C      Liquid Temperature: 22.5°C

Communication System: LTE Band66    Frequency: 1720 MHz Duty Cycle: 1:1

Probe: EX3DV4 - SN7517 ConvF(8.22, 8.22, 8.22)

**Area Scan (141x81x1):** Interpolated grid: dx=1.500 mm, dy=1.500 mm

Maximum value of SAR (interpolated) = 1.23 W/kg

**Zoom Scan (6x6x7)/Cube 0:** Measurement grid: dx=8mm, dy=8mm, dz=5mm

Reference Value = 1.439 V/m; Power Drift = 0.15 dB

Peak SAR (extrapolated) = 1.37 W/kg

**SAR(1 g) = 0.578 W/kg; SAR(10 g) = 0.258 W/kg**

Maximum value of SAR (measured) = 1.06 W/kg

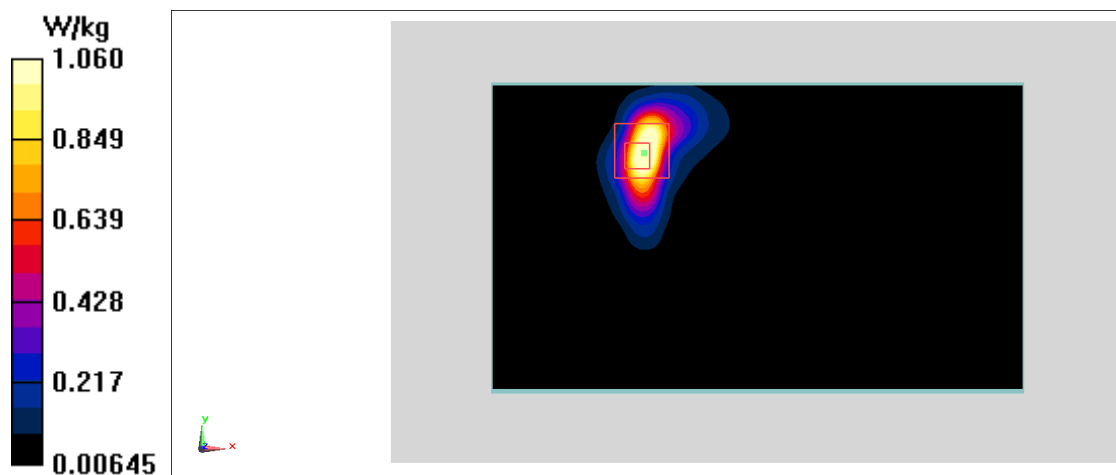

Fig A.17

**LTE Band71 Body**

Date/Time: 3/31/2021

Electronics: DAE4 Sn1525

Medium: H750

Medium parameters used:  $f = 700$  MHz;  $\sigma = 0.825$  S/m;  $\epsilon_r = 43.465$ ;  $\rho = 1000$  kg/m<sup>3</sup>

Ambient Temperature: 23.3°C      Liquid Temperature: 22.5°C

Communication System: LTE Band71    Frequency: 673 MHz Duty Cycle: 1:1

Probe: EX3DV4 - SN7517 ConvF(9.81, 9.81, 9.81)

**Area Scan (141x81x1):** Interpolated grid: dx=1.500 mm, dy=1.500 mm

Maximum value of SAR (interpolated) = 1.08 W/kg

**Zoom Scan (6x6x7)/Cube 0:** Measurement grid: dx=8mm, dy=8mm, dz=5mm

Reference Value = 10.38 V/m; Power Drift = 0.18 dB

Peak SAR (extrapolated) = 1.55 W/kg

**SAR(1 g) = 0.466 W/kg; SAR(10 g) = 0.206 W/kg**

Maximum value of SAR (measured) = 1.07 W/kg

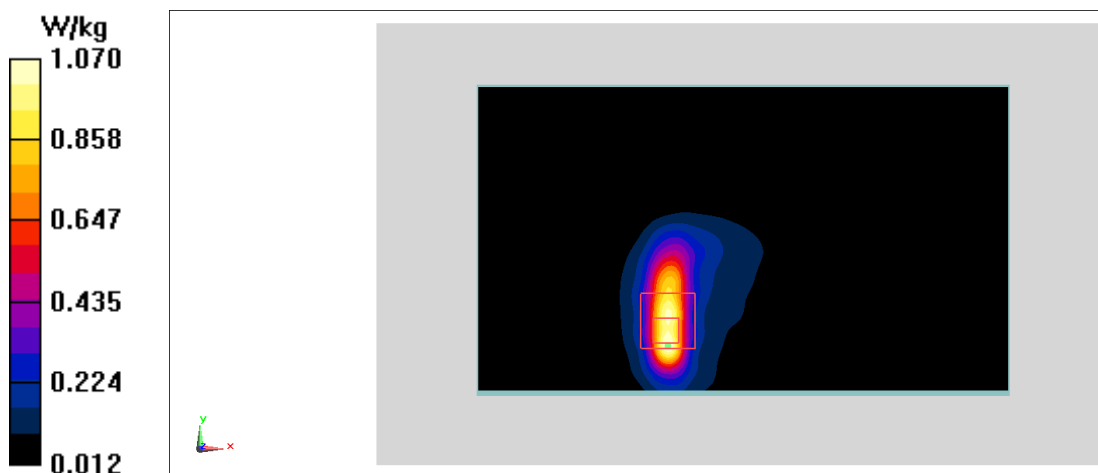

Fig A.18

**WLAN2450 Body**

Date/Time: 4/15/2021

Electronics: DAE4 Sn1588

Medium: H2450

Medium parameters used (interpolated):  $f = 2437$  MHz;  $\sigma = 1.929$  S/m;  $\epsilon_r = 40.792$ ;  $\rho = 1000$  kg/m<sup>3</sup>

Ambient Temperature: 23.3oC      Liquid Temperature: 22.5oC

Communication System: Wlan 2450    Frequency: 2437 MHz Duty Cycle: 1:1

Probe: EX3DV4 - SN7464 ConvF(7.75, 7.75, 7.75)

Area Scan (111x151x1): Interpolated grid: dx=1.200 mm, dy=1.200 mm

Maximum value of SAR (interpolated) = 0.554 W/kg

Zoom Scan (7x7x7)/Cube 0: Measurement grid: dx=5mm, dy=5mm, dz=5mm

Reference Value = 2.598 V/m; Power Drift = 0.07 dB

Peak SAR (extrapolated) = 0.802 W/kg

SAR(1 g) = 0.273 W/kg; SAR(10 g) = 0.113 W/kg

Smallest distance from peaks to all points 3 dB below = 7.3 mm

Ratio of SAR at M2 to SAR at M1 = 32.4%

Maximum value of SAR (measured) = 0.554 W/kg

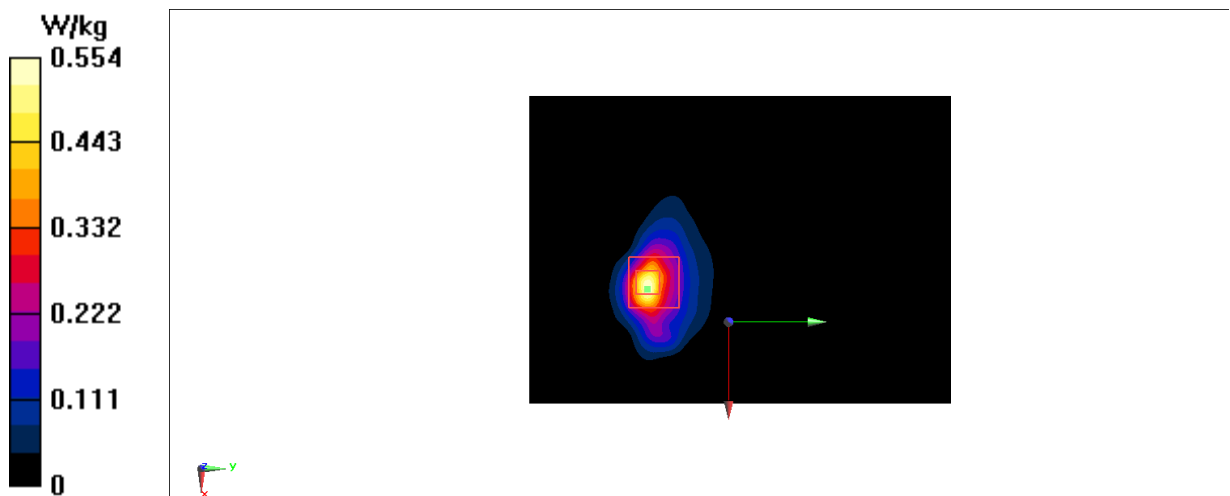

**Fig A.19**

**WLAN5G Body**

Date/Time: 4/15/2021

Electronics: DAE4 Sn1588

Medium: H5G

Medium parameters used:  $f = 5290$  MHz;  $\sigma = 4.912$  S/m;  $\epsilon_r = 34.435$ ;  $\rho = 1000$  kg/m<sup>3</sup>

Ambient Temperature: 23.3oC      Liquid Temperature: 22.5oC

Communication System: WLan 11a    Frequency: 5290 MHz Duty Cycle: 1:1

Probe: EX3DV4 - SN7464 ConvF(5.55, 5.55, 5.55)

Area Scan (131x201x1): Interpolated grid: dx=1.000 mm, dy=1.000 mm

Maximum value of SAR (interpolated) = 1.30 W/kg

Zoom Scan (8x8x7)/Cube 0: Measurement grid: dx=4mm, dy=4mm, dz=1.4mm

Reference Value = 0 V/m; Power Drift = 0.00 dB

Peak SAR (extrapolated) = 2.99 W/kg

SAR(1 g) = 0.504 W/kg; SAR(10 g) = 0.102 W/kg

Smallest distance from peaks to all points 3 dB below = 4 mm

Ratio of SAR at M2 to SAR at M1 = 58.4%

Maximum value of SAR (measured) = 1.58 W/kg

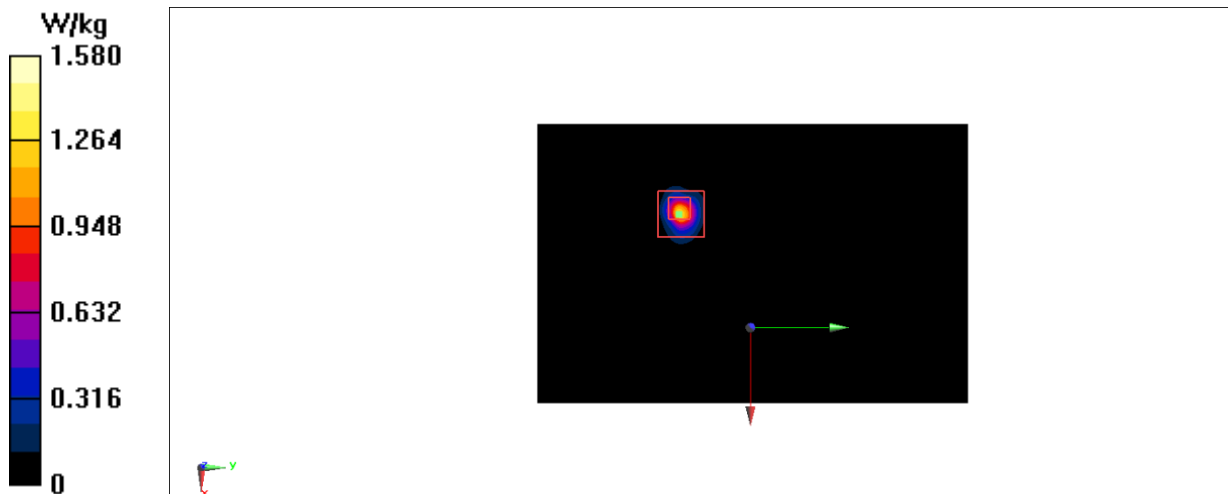
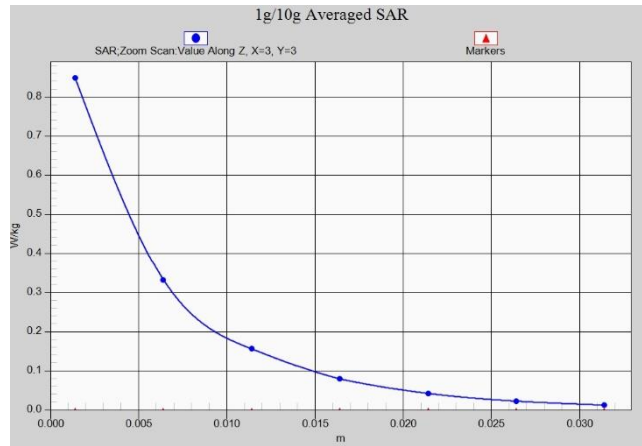
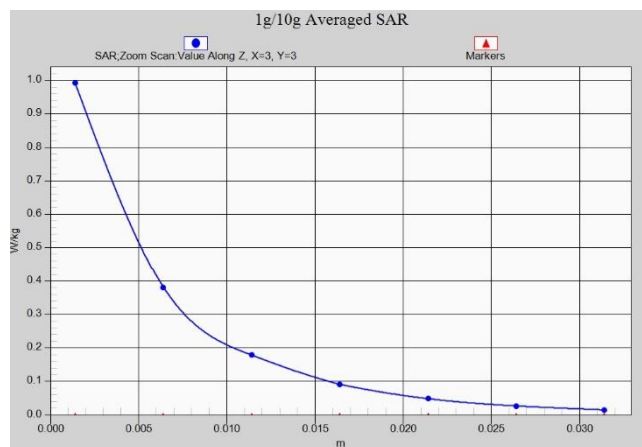

Fig A.20

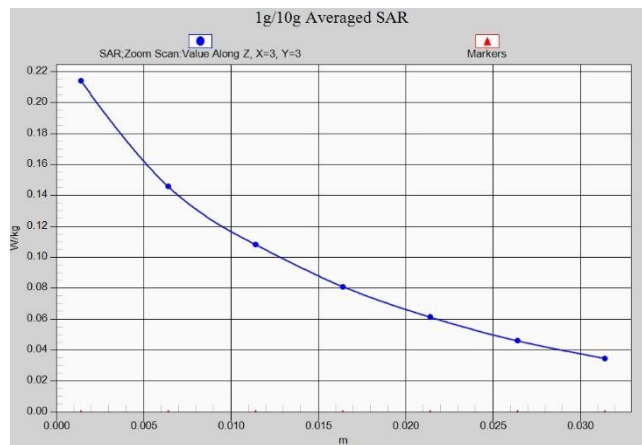



**Fig. 1-1 Z-Scan at power reference point (WCDMA1900)**



**Fig. 1-2 Z-Scan at power reference point (WCDMA1700)**



**Fig. 1-3 Z-Scan at power reference point (WCDMA850)**

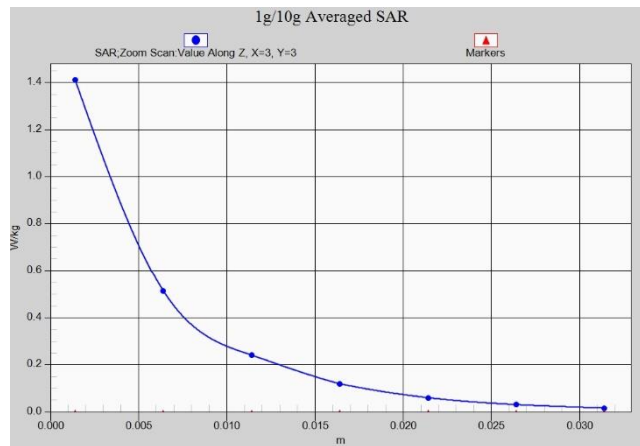

**Fig. 1-4 Z-Scan at power reference point (LTE Band2)**

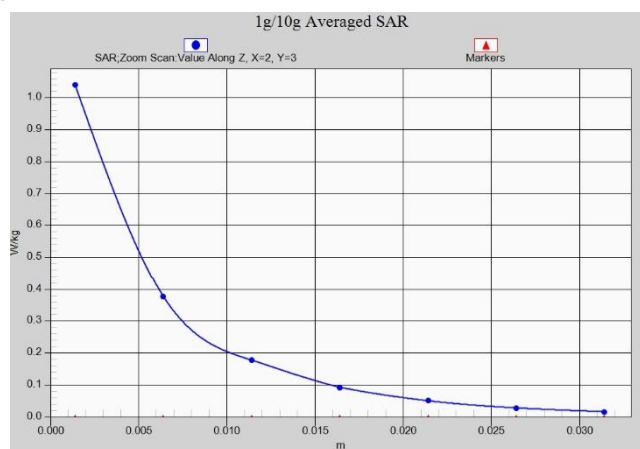

**Fig. 1-5 Z-Scan at power reference point (LTE Band4)**

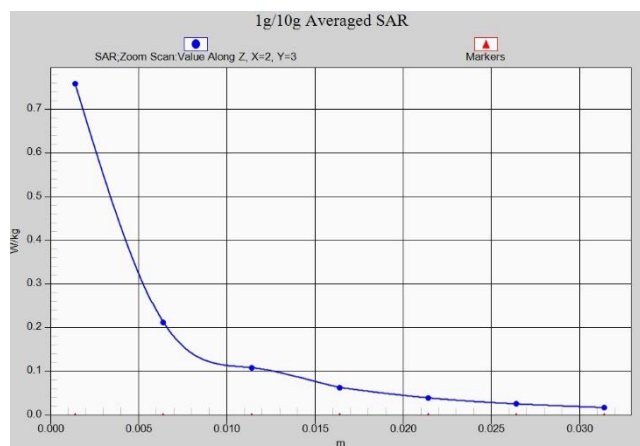

**Fig. 1-6 Z-Scan at power reference point (LTE Band5)**

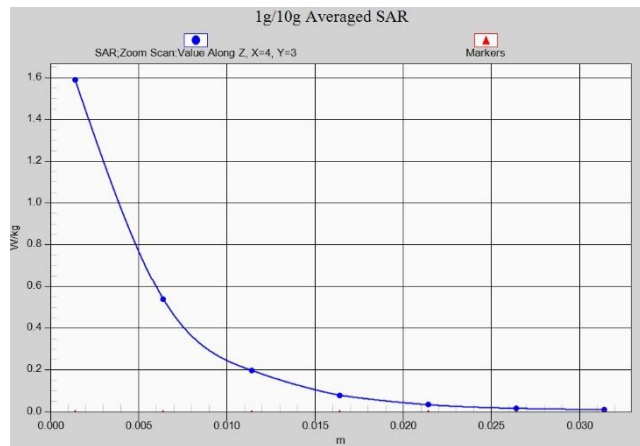

**Fig. 1-7 Z-Scan at power reference point (LTE Band 7)**

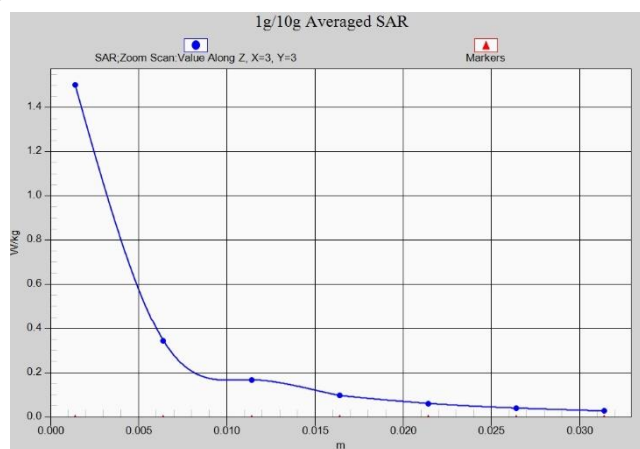

**Fig. 1-8 Z-Scan at power reference point (LTE Band 12)**

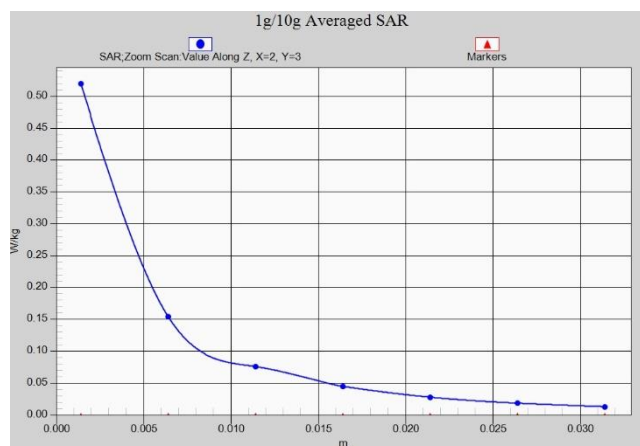

**Fig. 1-9 Z-Scan at power reference point (LTE Band 13)**

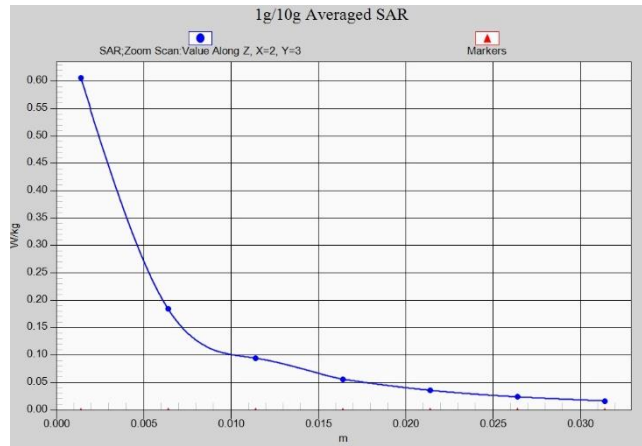

**Fig. 1-10 Z-Scan at power reference point (LTE Band14)**

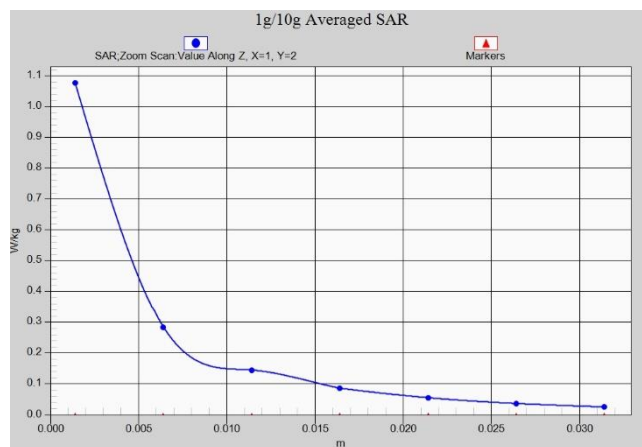

**Fig. 1-11 Z-Scan at power reference point (LTE Band17)**

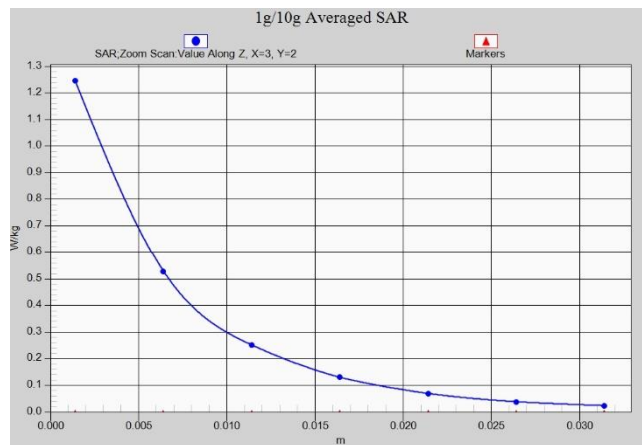

**Fig. 1-12 Z-Scan at power reference point (LTE Band25)**

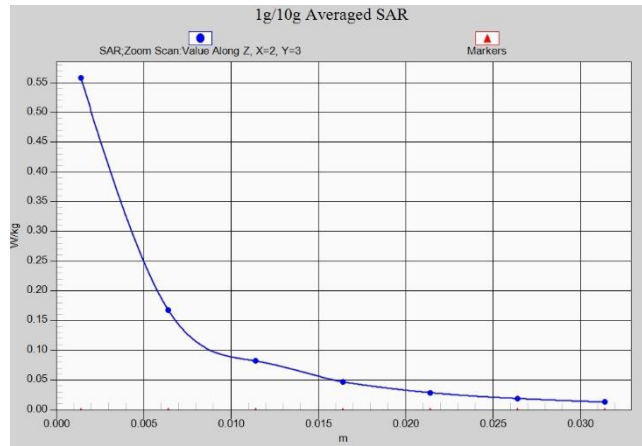

**Fig. 1-13 Z-Scan at power reference point (LTE Band26)**

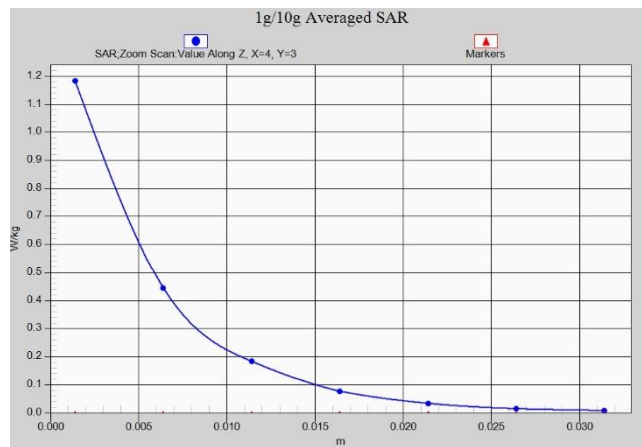

**Fig. 1-14 Z-Scan at power reference point (LTE Band30)**

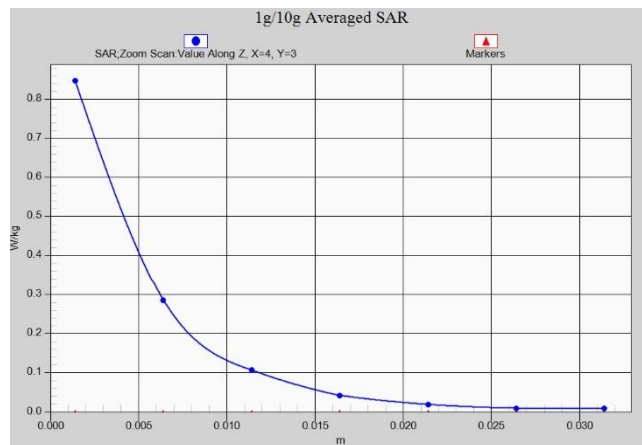

**Fig. 1-15 Z-Scan at power reference point (LTE Band41 PC3)**

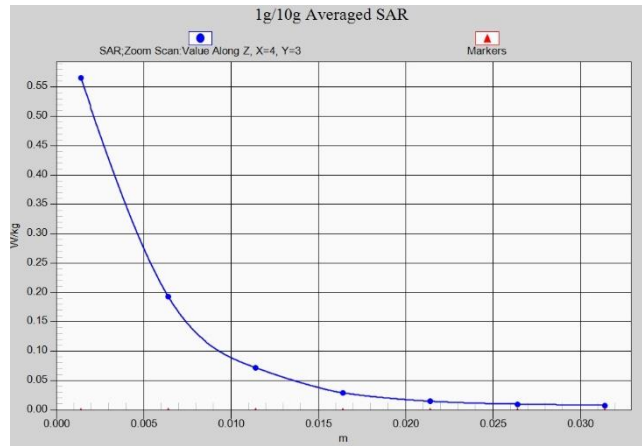

**Fig. 1-16 Z-Scan at power reference point (LTE Band41 PC2)**

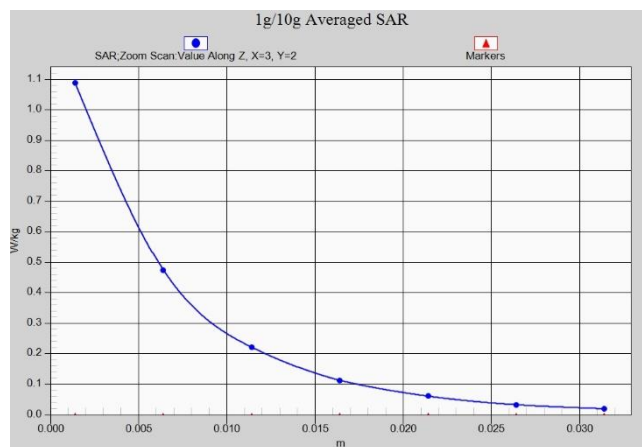

**Fig. 1-17 Z-Scan at power reference point (LTE Band66)**

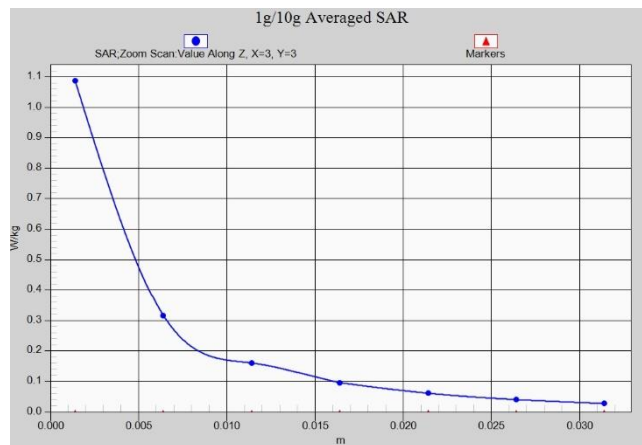

**Fig. 1-18 Z-Scan at power reference point (LTE Band71)**

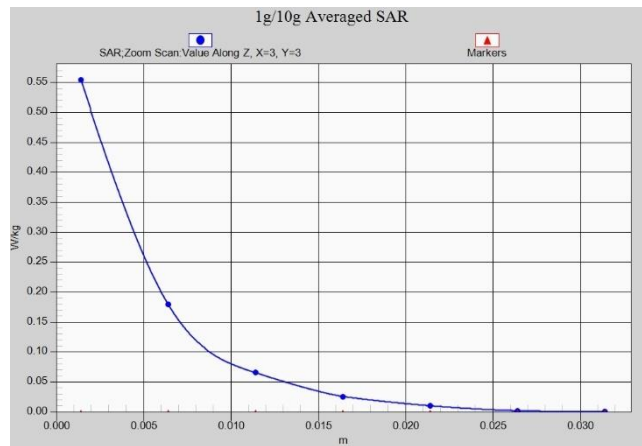

Fig. 1-19 Z-Scan at power reference point (2450 MHz)

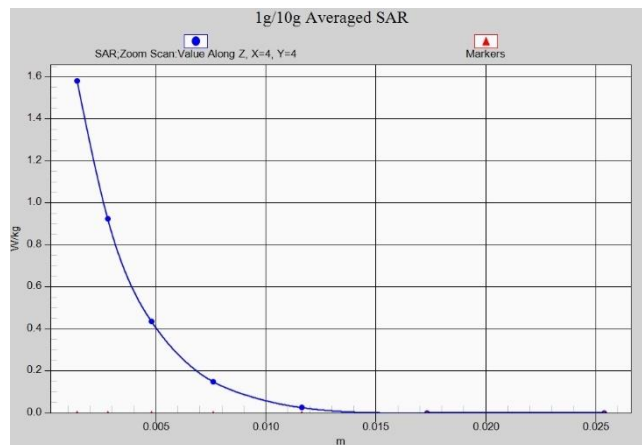

Fig. 1-20 Z-Scan at power reference point (5GHz)

## ANNEX B System Verification Results

### 750 MHz

Date: 3/29/2021

Electronics: DAE4 Sn1525

Medium: H750

Medium parameters used:  $f = 750$  MHz;  $\sigma = 0.822$  S/m;  $\epsilon_r = 44.017$ ;  $\rho = 1000$  kg/m<sup>3</sup>

Ambient Temperature: 23.3°C      Liquid Temperature: 22.5°C

Communication System: UID 0, CW (0) Frequency: 750 MHz Duty Cycle: 1:1

Probe: EX3DV4 - SN7600 ConvF(10.88, 10.88, 10.88)

Area Scan (51x141x1): Interpolated grid:  $dx=1.500$  mm,  $dy=1.500$  mm

Reference Value = 44.33 V/m; Power Drift = 0.17 dB

Fast SAR: SAR(1 g) = 2.06 W/kg; SAR(10 g) = 1.37 W/kg

Maximum value of SAR (interpolated) = 2.79 W/kg

Zoom Scan (5x5x7)/Cube 0: Measurement grid:  $dx=8$ mm,  $dy=8$ mm,  $dz=5$ mm

Reference Value = 44.33 V/m; Power Drift = 0.17 dB

Peak SAR (extrapolated) = 3.18 W/kg

SAR(1 g) = 2.02 W/kg; SAR(10 g) = 1.35 W/kg

Maximum value of SAR (measured) = 2.71 W/kg

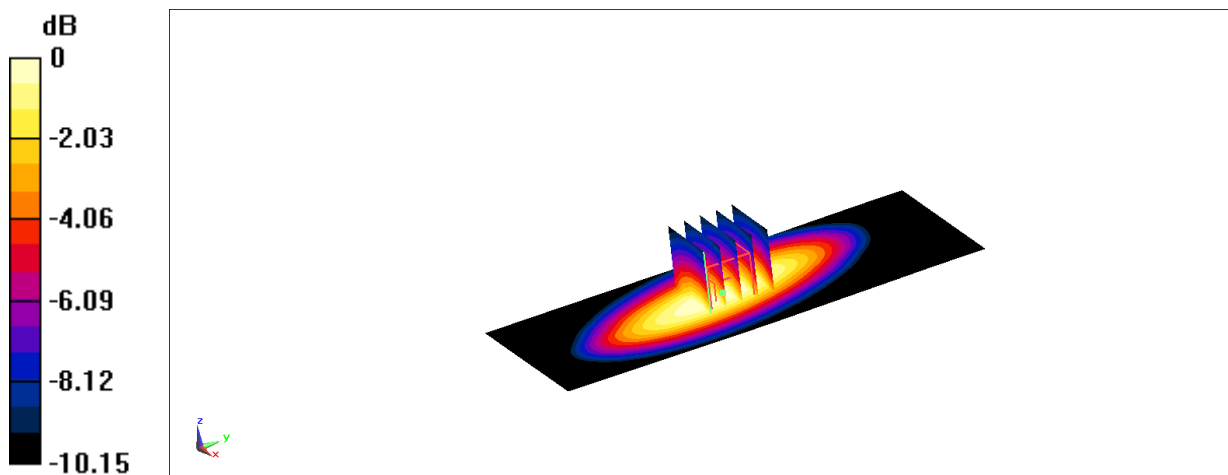

$$0 \text{ dB} = 2.71 \text{ W/kg} = 4.33 \text{ dBW/kg}$$

Fig.B.1 validation 750 MHz 250mW



## 750 MHz

Date: 3/30/2021

Electronics: DAE4 Sn1525

Medium: H750

Medium parameters used:  $f = 750 \text{ MHz}$ ;  $\sigma = 0.843 \text{ S/m}$ ;  $\epsilon_r = 43.15$ ;  $\rho = 1000 \text{ kg/m}^3$

Ambient Temperature: 23.3oC      Liquid Temperature: 22.5oC

Communication System: UID 0, CW (0) Frequency: 750 MHz Duty Cycle: 1:1

Probe: EX3DV4 - SN7517 ConvF(9.81, 9.81, 9.81)

Area Scan (51x141x1): Interpolated grid:  $dx=1.500 \text{ mm}$ ,  $dy=1.500 \text{ mm}$

Reference Value = 51.53 V/m; Power Drift = 0.15 dB

Fast SAR: SAR(1 g) = 2.15 W/kg; SAR(10 g) = 1.45 W/kg

Maximum value of SAR (interpolated) = 2.90 W/kg

Zoom Scan (5x5x7)/Cube 0: Measurement grid:  $dx=8\text{mm}$ ,  $dy=8\text{mm}$ ,  $dz=5\text{mm}$

Reference Value = 51.53 V/m; Power Drift = 0.15 dB

Peak SAR (extrapolated) = 3.38 W/kg

SAR(1 g) = 2.12 W/kg; SAR(10 g) = 1.42 W/kg

Maximum value of SAR (measured) = 2.89 W/kg

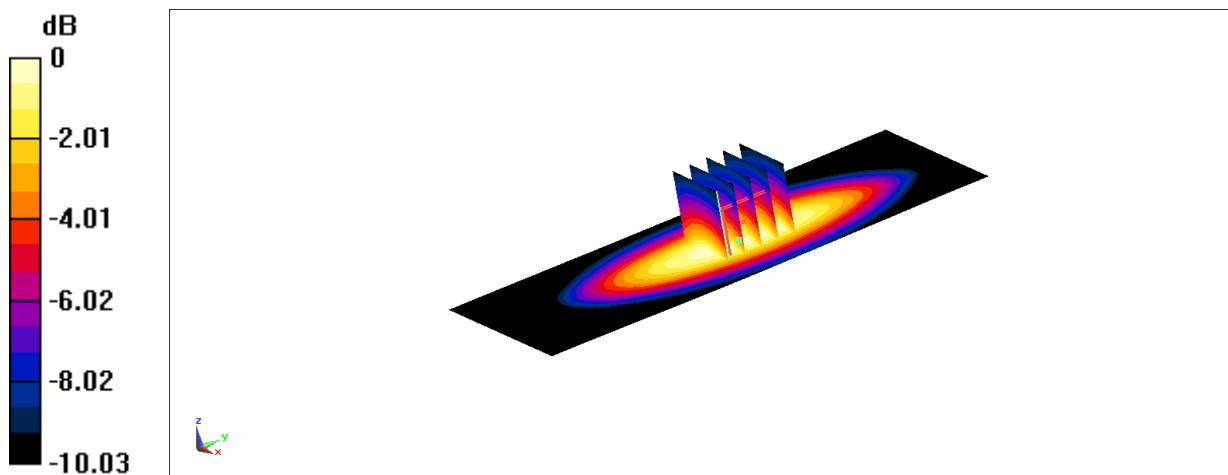

$$0 \text{ dB} = 2.89 \text{ W/kg} = 4.61 \text{ dBW/kg}$$

**Fig.B.2 validation 750 MHz 250mW**

## 750 MHz

Date: 3/31/2021

Electronics: DAE4 Sn1525

Medium: H750

Medium parameters used:  $f = 750$  MHz;  $\sigma = 0.843$  S/m;  $\epsilon_r = 43.15$ ;  $\rho = 1000$  kg/m<sup>3</sup>

Ambient Temperature: 23.3oC      Liquid Temperature: 22.5oC

Communication System: UID 0, CW (0) Frequency: 750 MHz Duty Cycle: 1:1

Probe: EX3DV4 - SN7517 ConvF(9.81, 9.81, 9.81)

Area Scan (51x141x1): Interpolated grid: dx=1.500 mm, dy=1.500 mm

Reference Value = 51.53 V/m; Power Drift = 0.15 dB

Fast SAR: SAR(1 g) = 2.16 W/kg; SAR(10 g) = 1.45 W/kg

Maximum value of SAR (interpolated) = 2.90 W/kg

Zoom Scan (5x5x7)/Cube 0: Measurement grid: dx=8mm, dy=8mm, dz=5mm

Reference Value = 51.53 V/m; Power Drift = 0.15 dB

Peak SAR (extrapolated) = 3.38 W/kg

SAR(1 g) = 2.12 W/kg; SAR(10 g) = 1.42 W/kg

Maximum value of SAR (measured) = 2.89 W/kg

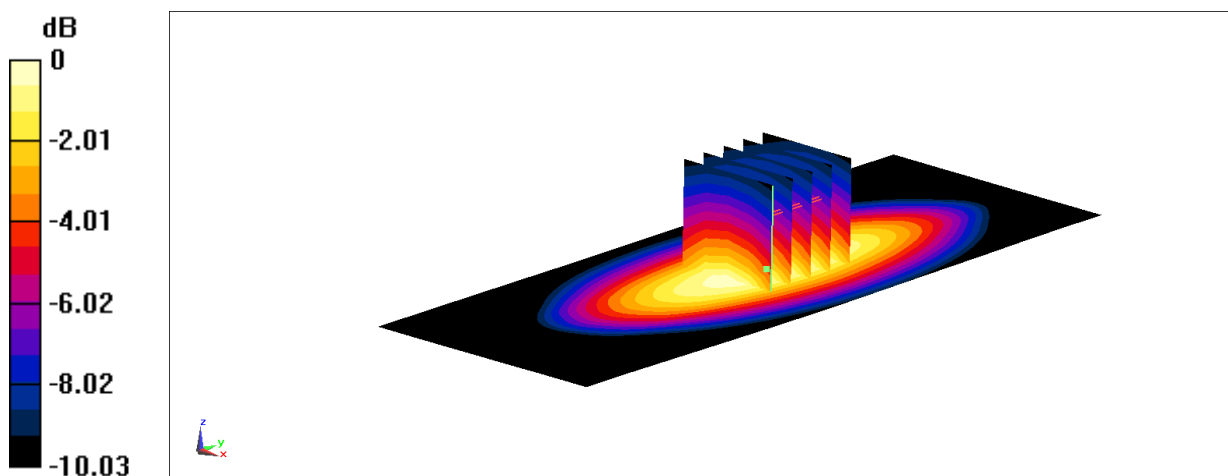

0 dB = 2.89 W/kg = 4.61 dBW/kg

**Fig.B.3 validation 750 MHz 250mW**

## 750 MHz

Date: 4/25/2021

Electronics: DAE4 Sn1331

Medium: H750

Medium parameters used:  $f = 750$  MHz;  $\sigma = 0.82$  S/m;  $\epsilon_r = 44.894$ ;  $\rho = 1000$  kg/m<sup>3</sup>

Ambient Temperature: 23.3oC      Liquid Temperature: 22.5oC

Communication System: UID 0, CW (0) Frequency: 750 MHz Duty Cycle: 1:1

Probe: EX3DV4 - SN7548 ConvF(10.17, 10.17, 10.17)

Area Scan (51x141x1): Interpolated grid: dx=1.500 mm, dy=1.500 mm

Reference Value = 50.91 V/m; Power Drift = 0.02 dB

Fast SAR: SAR(1 g) = 2.12 W/kg; SAR(10 g) = 1.42 W/kg

Maximum value of SAR (interpolated) = 2.91 W/kg

Zoom Scan (5x5x7)/Cube 0: Measurement grid: dx=8mm, dy=8mm, dz=5mm

Reference Value = 50.91 V/m; Power Drift = 0.02 dB

Peak SAR (extrapolated) = 3.32 W/kg

SAR(1 g) = 2.08 W/kg; SAR(10 g) = 1.39 W/kg

Maximum value of SAR (measured) = 2.82 W/kg

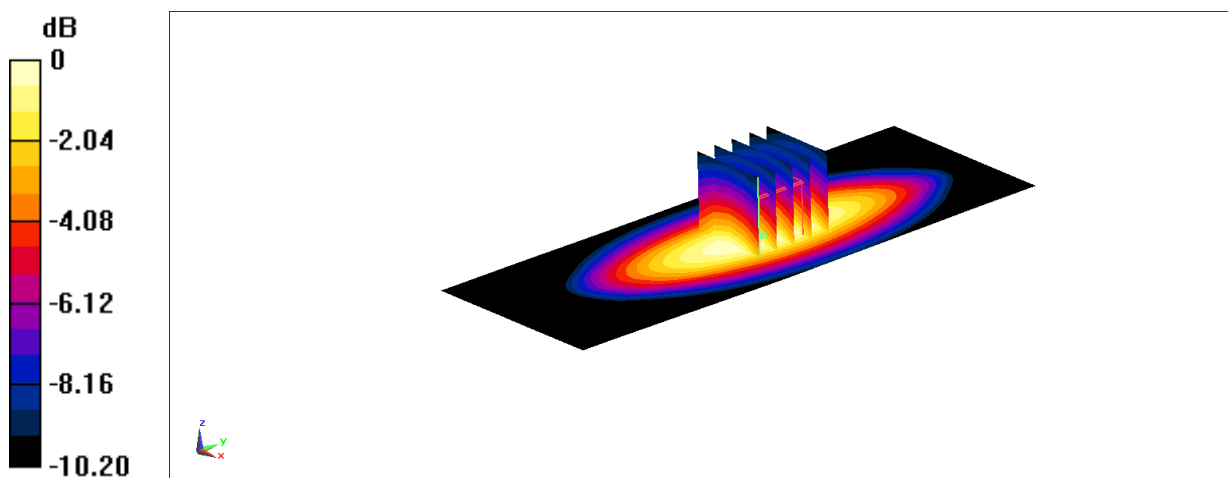

0 dB = 2.82 W/kg = 4.50 dBW/kg

**Fig.B.4 validation 750 MHz 250mW**

## 750 MHz

Date: 3/30/2021

Electronics: DAE4 Sn1525

Medium: H750

Medium parameters used:  $f = 750$  MHz;  $\sigma = 0.831$  S/m;  $\epsilon_r = 45.22$ ;  $\rho = 1000$  kg/m<sup>3</sup>

Ambient Temperature: 23.3oC      Liquid Temperature: 22.5oC

Communication System: UID 0, CW (0) Frequency: 750 MHz Duty Cycle: 1:1

Probe: EX3DV4 - SN7517 ConvF(9.81, 9.81, 9.81)

Area Scan (51x141x1): Interpolated grid: dx=1.500 mm, dy=1.500 mm

Reference Value = 51.53 V/m; Power Drift = 0.15 dB

Fast SAR: SAR(1 g) = 2.14 W/kg; SAR(10 g) = 1.43 W/kg

Maximum value of SAR (interpolated) = 2.86 W/kg

Zoom Scan (5x5x7)/Cube 0: Measurement grid: dx=8mm, dy=8mm, dz=5mm

Reference Value = 51.53 V/m; Power Drift = 0.15 dB

Peak SAR (extrapolated) = 3.33 W/kg

SAR(1 g) = 2.09 W/kg; SAR(10 g) = 1.4 W/kg

Maximum value of SAR (measured) = 2.84 W/kg

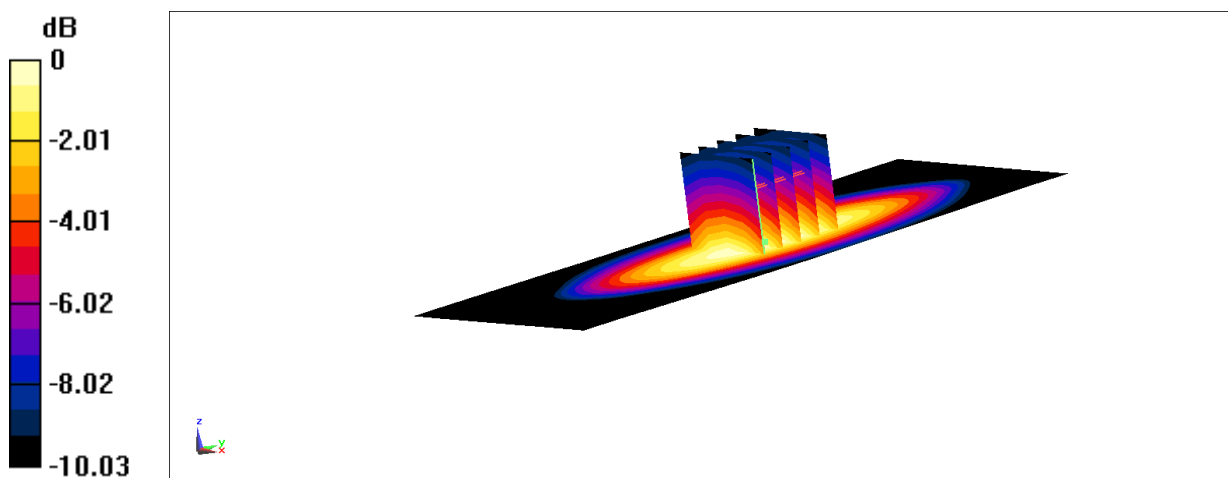

0 dB = 2.84 W/kg = 4.53 dBW/kg

**Fig.B.5 validation 750 MHz 250mW**

## 835 MHz

Date: 3/29/2021

Electronics: DAE4 Sn1525

Medium: H835

Medium parameters used:  $f = 835$  MHz;  $\sigma = 0.855$  S/m;  $\epsilon_r = 43.764$ ;  $\rho = 1000$  kg/m<sup>3</sup>

Ambient Temperature: 23.3°C      Liquid Temperature: 22.5°C

Communication System: UID 0, CW (0) Frequency: 835 MHz Duty Cycle: 1:1

Probe: EX3DV4 - SN7600 ConvF(10.88, 10.88, 10.88)

Area Scan (51x141x1): Interpolated grid:  $dx=1.500$  mm,  $dy=1.500$  mm

Reference Value = 56.29 V/m; Power Drift = 0.13 dB

Fast SAR: SAR(1 g) = 2.46 W/kg; SAR(10 g) = 1.61 W/kg

Maximum value of SAR (interpolated) = 3.20 W/kg

Zoom Scan (5x5x7)/Cube 0: Measurement grid:  $dx=8$ mm,  $dy=8$ mm,  $dz=5$ mm

Reference Value = 56.29 V/m; Power Drift = 0.13 dB

Peak SAR (extrapolated) = 3.83 W/kg

SAR(1 g) = 2.41 W/kg; SAR(10 g) = 1.6 W/kg

Maximum value of SAR (measured) = 3.26 W/kg

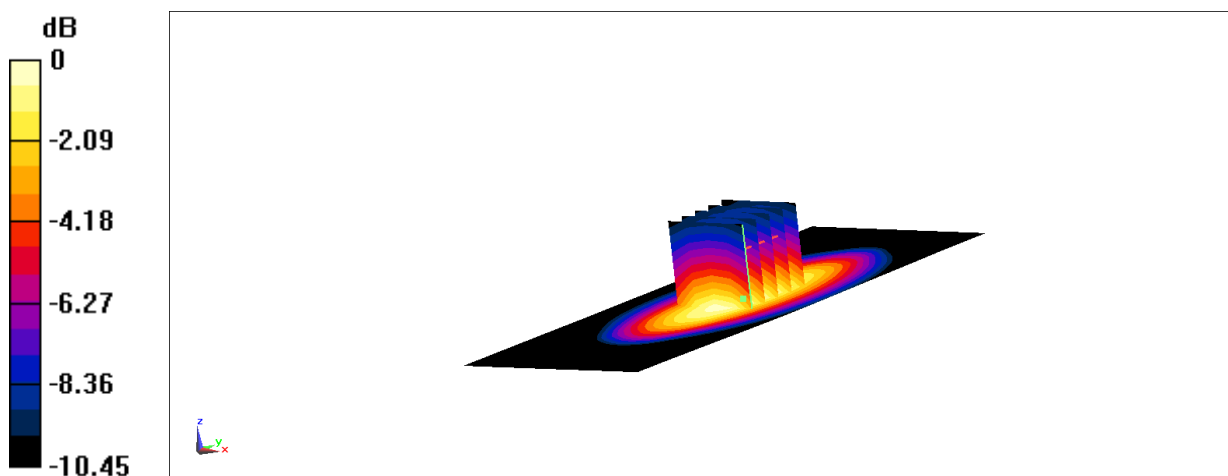

0 dB = 3.26 W/kg = 5.13 dBW/kg

**Fig.B.6 validation 835 MHz 250mW**

## 835 MHz

Date: 3/30/2021

Electronics: DAE4 Sn1525

Medium: H835

Medium parameters used:  $f = 835 \text{ MHz}$ ;  $\sigma = 0.878 \text{ S/m}$ ;  $\epsilon_r = 42.712$ ;  $\rho = 1000 \text{ kg/m}^3$

Ambient Temperature: 23.3oC      Liquid Temperature: 22.5oC

Communication System: UID 0, CW (0) Frequency: 835 MHz Duty Cycle: 1:1

Probe: EX3DV4 - SN7517 ConvF(9.81, 9.81, 9.81)

Area Scan 3 (51x131x1): Interpolated grid:  $dx=1.500 \text{ mm}$ ,  $dy=1.500 \text{ mm}$

Reference Value = 58.54 V/m; Power Drift = 0.11 dB

Fast SAR: SAR(1 g) = 2.46 W/kg; SAR(10 g) = 1.62 W/kg

Maximum value of SAR (interpolated) = 3.25 W/kg

Zoom Scan (7x7x7) /Cube 0: Measurement grid:  $dx=5\text{mm}$ ,  $dy=5\text{mm}$ ,  $dz=5\text{mm}$

Reference Value = 58.54 V/m; Power Drift = 0.11 dB

Peak SAR (extrapolated) = 3.79 W/kg

SAR(1 g) = 2.39 W/kg; SAR(10 g) = 1.58 W/kg

Maximum value of SAR (measured) = 3.25 W/kg

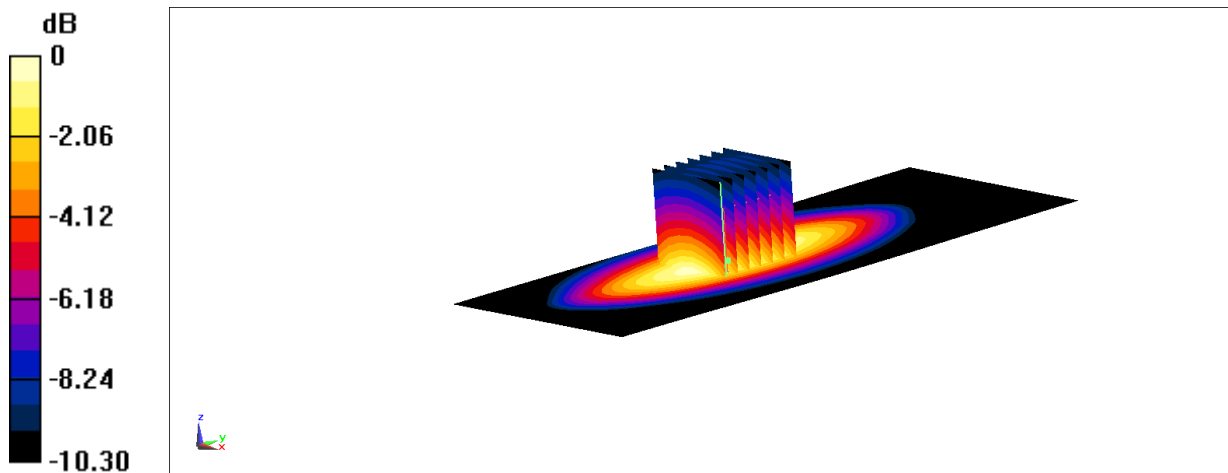

$$0 \text{ dB} = 3.25 \text{ W/kg} = 5.12 \text{ dBW/kg}$$

**Fig.B.7 validation 835 MHz 250mW**

## 835 MHz

Date: 4/25/2021

Electronics: DAE4 Sn1331

Medium: H835

Medium parameters used:  $f = 835$  MHz;  $\sigma = 0.854$  S/m;  $\epsilon_r = 44.648$ ;  $\rho = 1000$  kg/m<sup>3</sup>

Ambient Temperature: 23.3oC      Liquid Temperature: 22.5oC

Communication System: UID 0, CW (0) Frequency: 835 MHz Duty Cycle: 1:1

Probe: EX3DV4 - SN7548 ConvF(10.17, 10.17, 10.17)

Area Scan (51x141x1): Interpolated grid: dx=1.500 mm, dy=1.500 mm

Reference Value = 44.50 V/m; Power Drift = 0.18 dB

Fast SAR: SAR(1 g) = 2.61 W/kg; SAR(10 g) = 1.73 W/kg

Maximum value of SAR (interpolated) = 3.47 W/kg

Zoom Scan (5x5x7)/Cube 0: Measurement grid: dx=8mm, dy=8mm, dz=5mm

Reference Value = 44.50 V/m; Power Drift = 0.18 dB

Peak SAR (extrapolated) = 4.03 W/kg

SAR(1 g) = 2.54 W/kg; SAR(10 g) = 1.67 W/kg

Maximum value of SAR (measured) = 3.44 W/kg

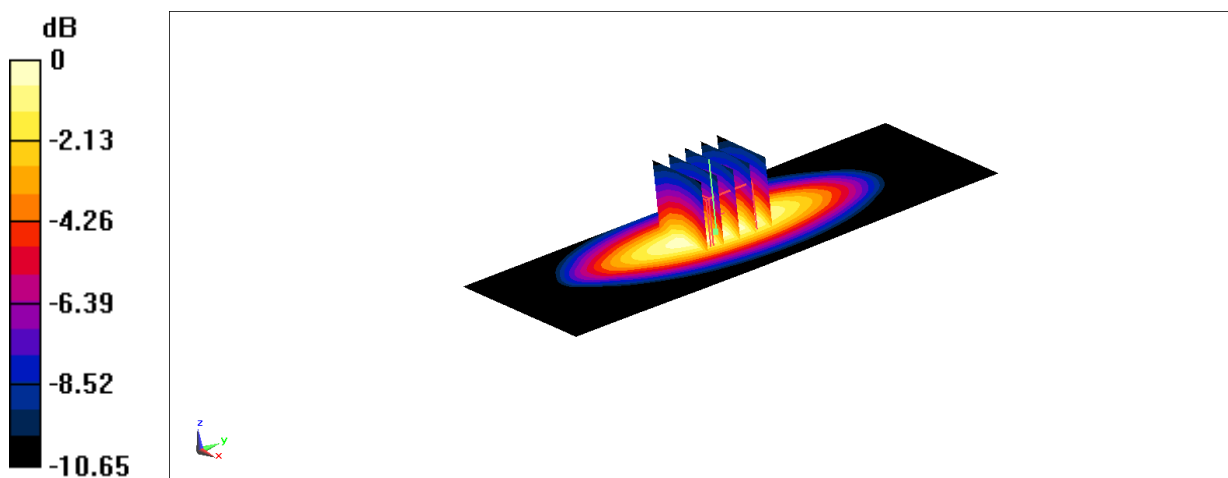

0 dB = 3.44 W/kg = 5.37 dBW/kg

**Fig.B.8 validation 835 MHz 250mW**

## 1750 MHz

Date: 3/29/2021

Electronics: DAE4 Sn1525

Medium: H1750

Medium parameters used:  $f = 1750$  MHz;  $\sigma = 1.34$  S/m;  $\epsilon_r = 41.588$ ;  $\rho = 1000$  kg/m<sup>3</sup>

Ambient Temperature: 23.3oC      Liquid Temperature: 22.5oC

Communication System: UID 0, CW (0) Frequency: 1750 MHz Duty Cycle: 1:1

Probe: EX3DV4 - SN7600 ConvF(9.01, 9.01, 9.01)

Area Scan (51x141x1): Interpolated grid: dx=1.500 mm, dy=1.500 mm

Reference Value = 51.83 V/m; Power Drift = 0.18 dB

Fast SAR: SAR(1 g) = 9.22 W/kg; SAR(10 g) = 4.87 W/kg

Maximum value of SAR (interpolated) = 14.5 W/kg

Zoom Scan (5x5x7)/Cube 0: Measurement grid: dx=8mm, dy=8mm, dz=5mm

Reference Value = 51.83 V/m; Power Drift = 0.18 dB

Peak SAR (extrapolated) = 17.9 W/kg

SAR(1 g) = 9.15 W/kg; SAR(10 g) = 4.82 W/kg

Maximum value of SAR (measured) = 14.2 W/kg

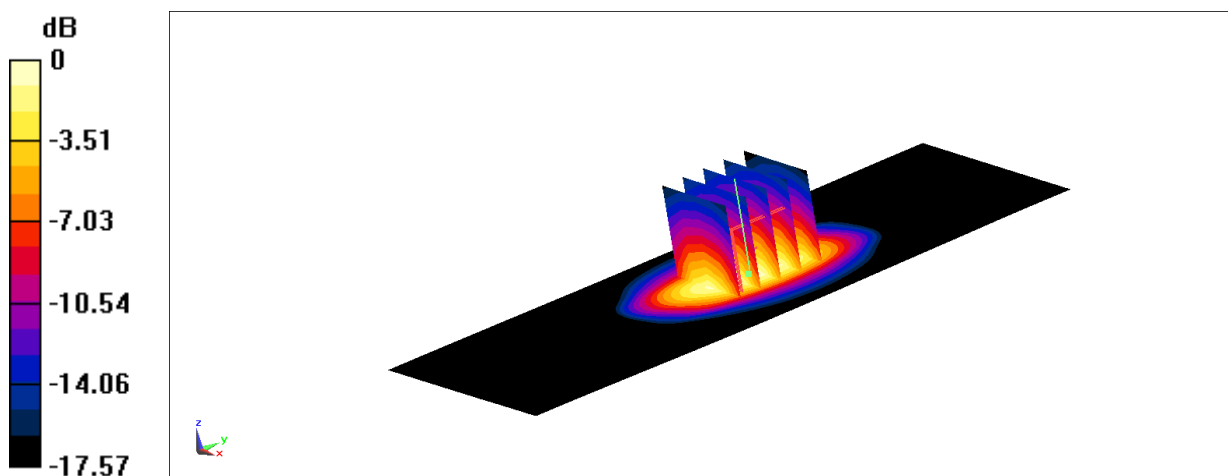

0 dB = 14.2 W/kg = 11.52 dBW/kg

**Fig.B.9 validation 1750 MHz 250mW**



## 1750 MHz

Date: 3/29/2021

Electronics: DAE4 Sn1525

Medium: H1750

Medium parameters used:  $f = 1750$  MHz;  $\sigma = 1.371$  S/m;  $\epsilon_r = 41.48$ ;  $\rho = 1000$  kg/m<sup>3</sup>

Ambient Temperature: 23.3oC      Liquid Temperature: 22.5oC

Communication System: UID 0, CW (0) Frequency: 1750 MHz Duty Cycle: 1:1

Probe: EX3DV4 - SN7600 ConvF(9.01, 9.01, 9.01)

Area Scan (51x141x1): Interpolated grid: dx=1.500 mm, dy=1.500 mm

Reference Value = 57.66 V/m; Power Drift = 0.17 dB

Fast SAR: SAR(1 g) = 9.72 W/kg; SAR(10 g) = 5.11 W/kg

Maximum value of SAR (interpolated) = 14.8 W/kg

Zoom Scan (5x5x7)/Cube 0: Measurement grid: dx=8mm, dy=8mm, dz=5mm

Reference Value = 57.66 V/m; Power Drift = 0.17 dB

Peak SAR (extrapolated) = 18.5 W/kg

SAR(1 g) = 9.46 W/kg; SAR(10 g) = 4.99 W/kg

Maximum value of SAR (measured) = 14.5 W/kg

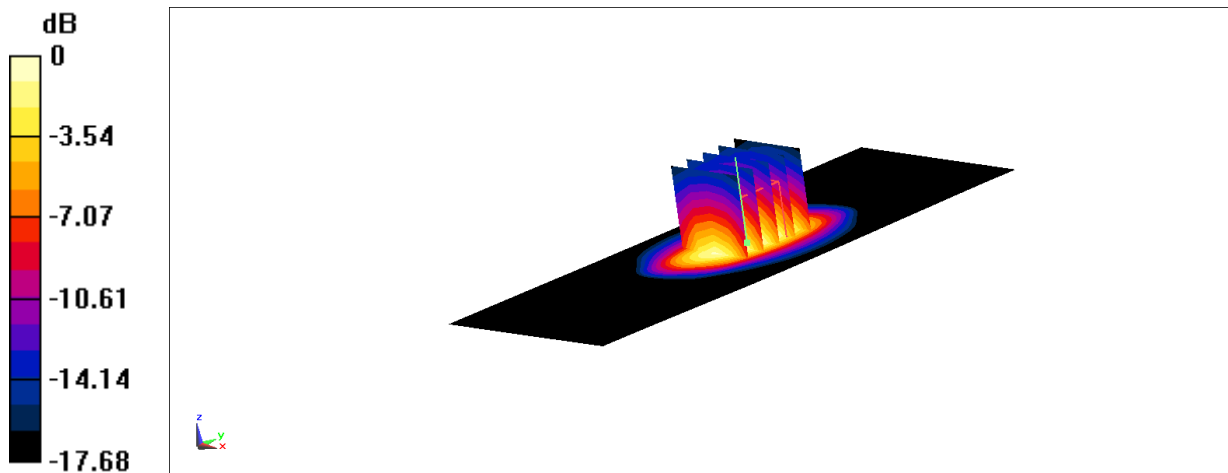

0 dB = 14.5 W/kg = 11.61 dBW/kg

**Fig.B.10 validation 1750 MHz 250mW**

## 1750 MHz

Date: 3/30/2021

Electronics: DAE4 Sn1525

Medium: H1750

Medium parameters used:  $f = 1750$  MHz;  $\sigma = 1.375$  S/m;  $\epsilon_r = 40.3$ ;  $\rho = 1000$  kg/m<sup>3</sup>

Ambient Temperature: 23.3oC      Liquid Temperature: 22.5oC

Communication System: UID 0, CW (0) Frequency: 1750 MHz Duty Cycle: 1:1

Probe: EX3DV4 - SN7517 ConvF(8.22, 8.22, 8.22)

Area Scan (51x141x1): Interpolated grid: dx=1.500 mm, dy=1.500 mm

Reference Value = 64.38 V/m; Power Drift = 0.16 dB

Fast SAR: SAR(1 g) = 10.14 W/kg; SAR(10 g) = 5.36 W/kg

Maximum value of SAR (interpolated) = 15.9 W/kg

Zoom Scan (5x5x7)/Cube 0: Measurement grid: dx=8mm, dy=8mm, dz=5mm

Reference Value = 64.38 V/m; Power Drift = 0.16 dB

Peak SAR (extrapolated) = 18.7 W/kg

SAR(1 g) = 9.85 W/kg; SAR(10 g) = 5.21 W/kg

Maximum value of SAR (measured) = 14.5 W/kg

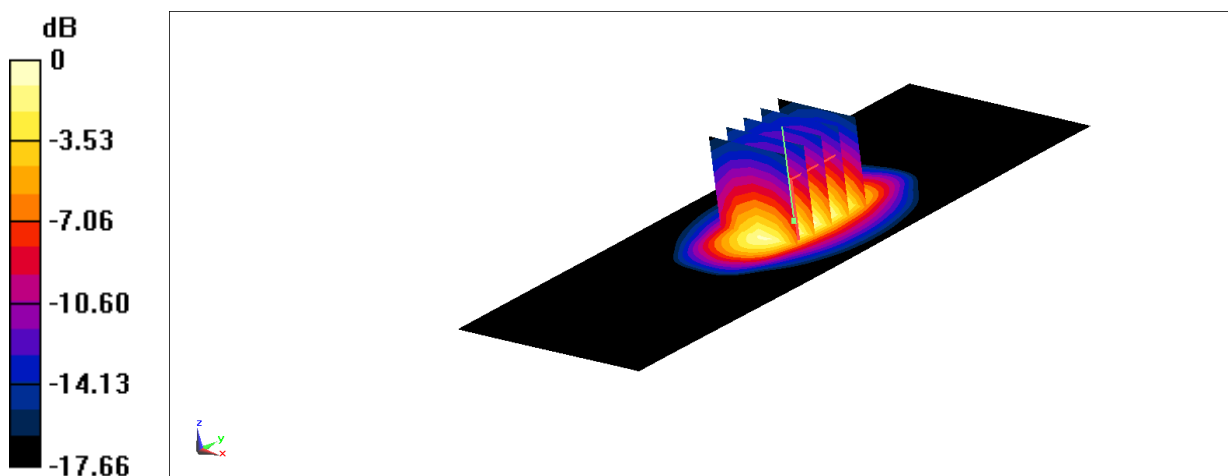

0 dB = 14.5 W/kg = 11.61 dBW/kg

**Fig.B.11 validation 1750 MHz 250mW**

## 1900 MHz

Date: 3/29/2021

Electronics: DAE4 Sn1525

Medium: H1900

Medium parameters used:  $f = 1900$  MHz;  $\sigma = 1.455$  S/m;  $\epsilon_r = 41.13$ ;  $\rho = 1000$  kg/m<sup>3</sup>

Ambient Temperature: 23.3oC      Liquid Temperature: 22.5oC

Communication System: UID 0, CW (0) Frequency: 1900 MHz Duty Cycle: 1:1

Probe: EX3DV4 - SN7600 ConvF(8.7, 8.7, 8.7)

Area Scan (51x141x1): Interpolated grid: dx=1.500 mm, dy=1.500 mm

Reference Value = 58.99 V/m; Power Drift = 0.14 dB

Fast SAR: SAR(1 g) = 10.03 W/kg; SAR(10 g) = 5.17 W/kg

Maximum value of SAR (interpolated) = 15.9 W/kg

Zoom Scan (5x5x7)/Cube 0: Measurement grid: dx=8mm, dy=8mm, dz=5mm

Reference Value = 58.99 V/m; Power Drift = 0.14 dB

Peak SAR (extrapolated) = 18.6 W/kg

SAR(1 g) = 9.78 W/kg; SAR(10 g) = 5.04 W/kg

Maximum value of SAR (measured) = 14.9 W/kg

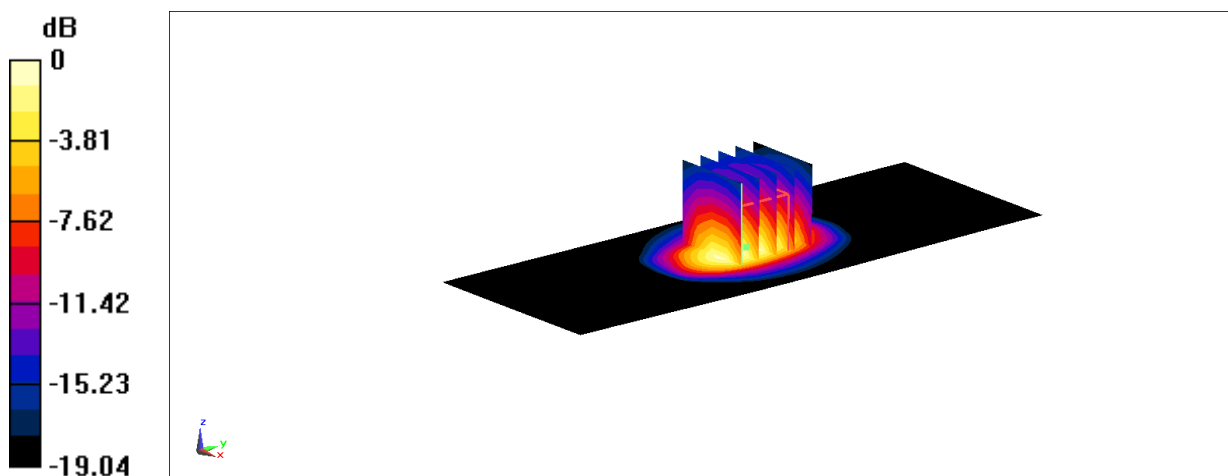

0 dB = 14.9 W/kg = 11.73 dBW/kg

**Fig.B.12 validation 1900 MHz 250mW**

## 1900 MHz

Date: 3/29/2021

Electronics: DAE4 Sn1525

Medium: H1900

Medium parameters used:  $f = 1900$  MHz;  $\sigma = 1.442$  S/m;  $\epsilon_r = 41.246$ ;  $\rho = 1000$  kg/m<sup>3</sup>

Ambient Temperature: 23.3oC      Liquid Temperature: 22.5oC

Communication System: UID 0, CW (0) Frequency: 1900 MHz Duty Cycle: 1:1

Probe: EX3DV4 - SN7600 ConvF(8.7, 8.7, 8.7)

Area Scan (51x141x1): Interpolated grid: dx=1.500 mm, dy=1.500 mm

Reference Value = 59.13 V/m; Power Drift = 0.18 dB

Fast SAR: SAR(1 g) = 10.04 W/kg; SAR(10 g) = 5.18 W/kg

Maximum value of SAR (interpolated) = 16.1 W/kg

Zoom Scan (5x5x7)/Cube 0: Measurement grid: dx=8mm, dy=8mm, dz=5mm

Reference Value = 59.13 V/m; Power Drift = 0.18 dB

Peak SAR (extrapolated) = 18.7 W/kg

SAR(1 g) = 9.79 W/kg; SAR(10 g) = 5.02 W/kg

Maximum value of SAR (measured) = 14.9 W/kg

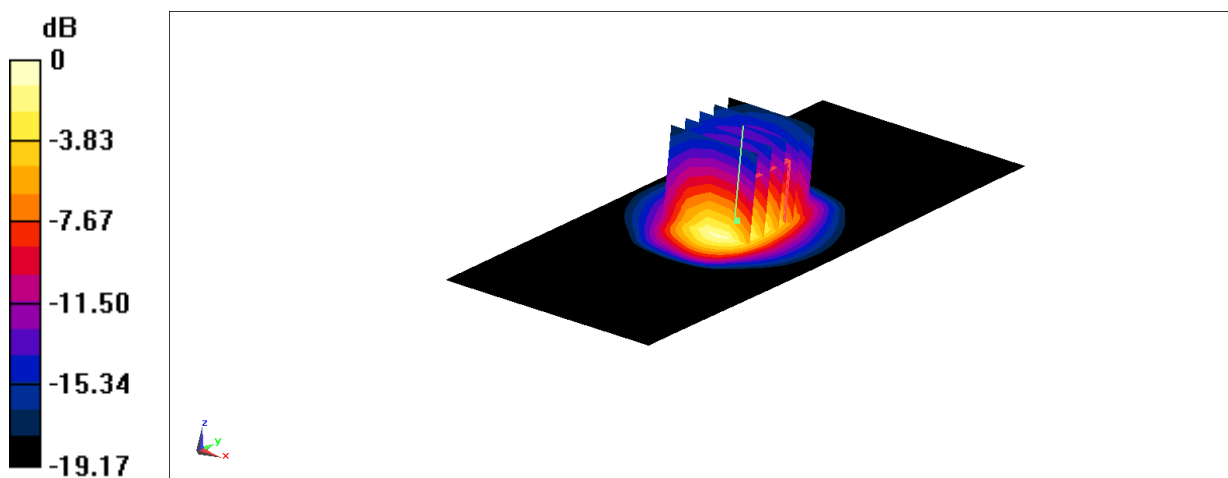

0 dB = 14.9 W/kg = 11.73 dBW/kg

**Fig.B.13 validation 1900 MHz 250mW**

## 1900 MHz

Date: 3/30/2021

Electronics: DAE4 Sn1525

Medium: H1900

Medium parameters used:  $f = 1900$  MHz;  $\sigma = 1.467$  S/m;  $\epsilon_r = 39.87$ ;  $\rho = 1000$  kg/m<sup>3</sup>

Ambient Temperature: 23.3oC      Liquid Temperature: 22.5oC

Communication System: UID 0, CW (0) Frequency: 1900 MHz Duty Cycle: 1:1

Probe: EX3DV4 - SN7517 ConvF(7.81, 7.81, 7.81)

Area Scan 3 (61x81x1): Interpolated grid:  $dx=1.200$  mm,  $dy=1.200$  mm

Reference Value = 70.08 V/m; Power Drift = 0.18 dB

Fast SAR: SAR(1 g) = 9.54 W/kg; SAR(10 g) = 4.92 W/kg

Maximum value of SAR (interpolated) = 15.9 W/kg

Zoom Scan (7x7x7)/Cube 0: Measurement grid:  $dx=5$ mm,  $dy=5$ mm,  $dz=5$ mm

Reference Value = 70.08 V/m; Power Drift = 0.18 dB

Peak SAR (extrapolated) = 18.1 W/kg

SAR(1 g) = 9.28 W/kg; SAR(10 g) = 4.76 W/kg

Maximum value of SAR (measured) = 14.9 W/kg

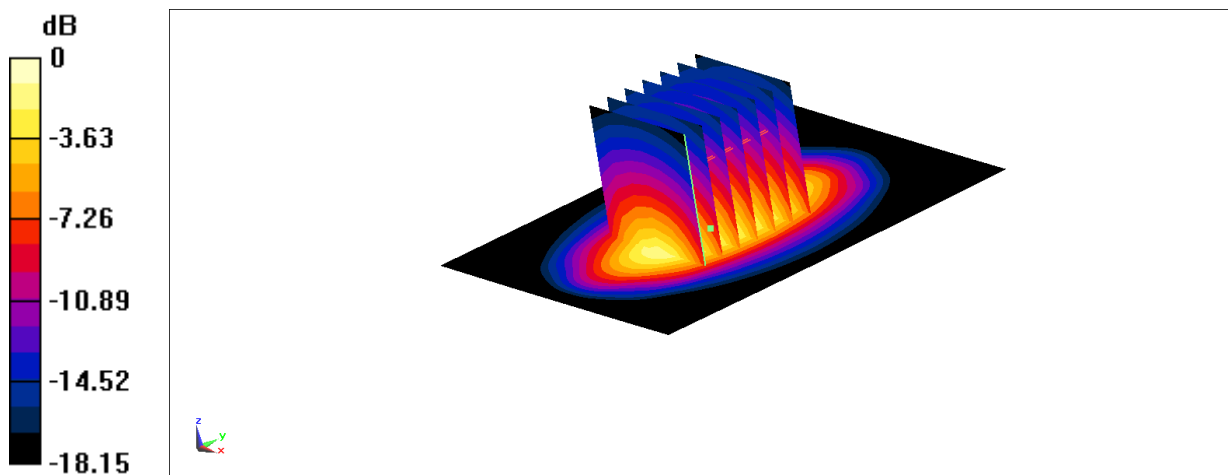

0 dB = 14.9 W/kg = 11.73 dBW/kg

**Fig.B.14 validation 1900 MHz 250mW**

## 2300 MHz

Date: 3/30/2021

Electronics: DAE4 Sn1525

Medium: H2300

Medium parameters used:  $f = 2300$  MHz;  $\sigma = 1.798$  S/m;  $\epsilon_r = 39.131$ ;  $\rho = 1000$  kg/m<sup>3</sup>

Ambient Temperature: 23.3oC      Liquid Temperature: 22.5oC

Communication System: UID 0, CW (0) Frequency: 2300 MHz Duty Cycle: 1:1

Probe: EX3DV4 - SN7517 ConvF(7.58, 7.58, 7.58)

Area Scan 3 (61x81x1): Interpolated grid: dx=1.200 mm, dy=1.200 mm

Reference Value = 102.0 V/m; Power Drift = 0.05 dB

Fast SAR: SAR(1 g) = 12.65 W/kg; SAR(10 g) = 5.83 W/kg

Maximum value of SAR (interpolated) = 21.0 W/kg

Zoom Scan (7x7x7)/Cube 0: Measurement grid: dx=5mm, dy=5mm, dz=5mm

Reference Value = 102.0 V/m; Power Drift = 0.05 dB

Peak SAR (extrapolated) = 25.7 W/kg

SAR(1 g) = 12.3 W/kg; SAR(10 g) = 5.74 W/kg

Maximum value of SAR (measured) = 20.5 W/kg

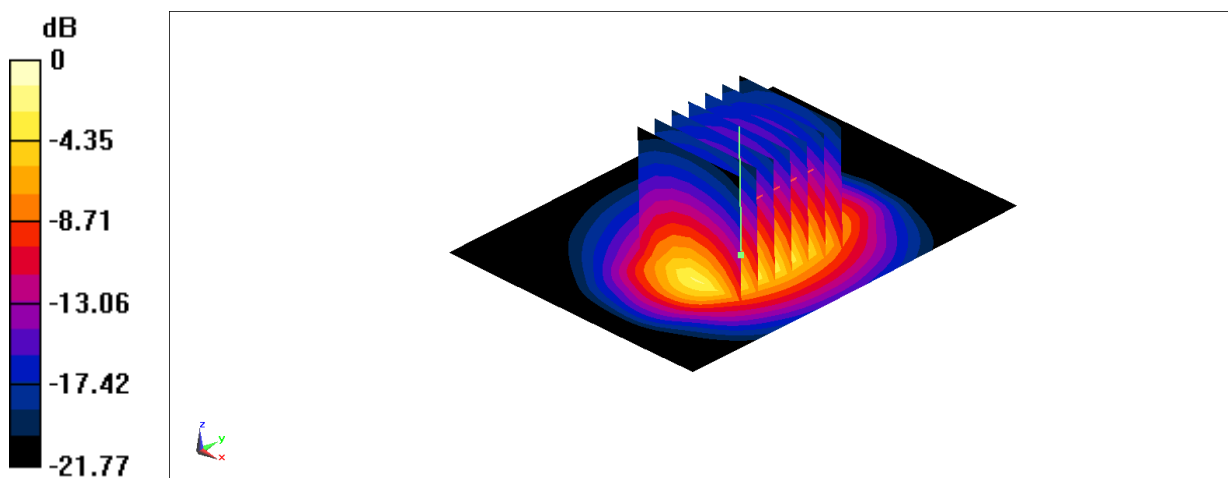

0 dB = 20.5 W/kg = 13.12 dBW/kg

**Fig.B.15 validation 2300 MHz 250mW**

## 2450 MHz

Date: 4/15/2021

Electronics: DAE4 Sn1588

Medium: H2450

Medium parameters used:  $f = 2450$  MHz;  $\sigma = 1.941$  S/m;  $\epsilon_r = 40.769$ ;  $\rho = 1000$  kg/m<sup>3</sup>

Ambient Temperature: 23.3oC      Liquid Temperature: 22.5oC

Communication System: UID 0, CW (0) Frequency: 2450 MHz Duty Cycle: 1:1

Probe: EX3DV4 - SN7464 ConvF(7.75, 7.75, 7.75)

Area Scan 3 (61x81x1): Interpolated grid: dx=1.200 mm, dy=1.200 mm

Reference Value = 69.28 V/m; Power Drift = 0.12 dB

Fast SAR: SAR(1 g) = 13.97 W/kg; SAR(10 g) = 6.25 W/kg

Maximum value of SAR (interpolated) = 23.3 W/kg

Zoom Scan (7x7x7)/Cube 0: Measurement grid: dx=5mm, dy=5mm, dz=5mm

Reference Value = 69.28 V/m; Power Drift = 0.12 dB

Peak SAR (extrapolated) = 29.1 W/kg

SAR(1 g) = 13.6 W/kg; SAR(10 g) = 6.25 W/kg

Maximum value of SAR (measured) = 23.2 W/kg

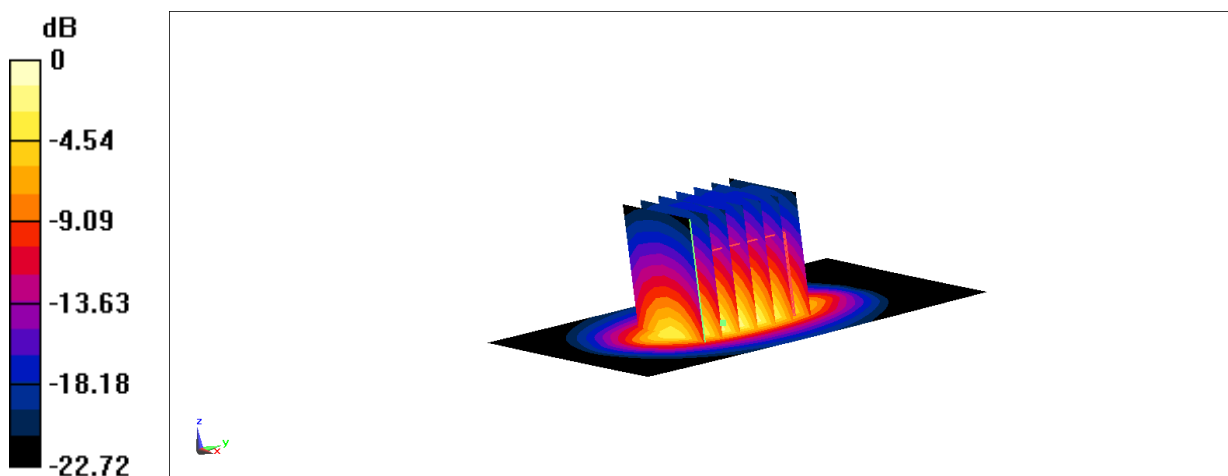

0 dB = 23.2 W/kg = 13.65 dBW/kg

**Fig.B.16 validation 2450 MHz 250mW**

## 2600 MHz

Date: 3/30/2021

Electronics: DAE4 Sn1525

Medium: H2600

Medium parameters used:  $f = 2600$  MHz;  $\sigma = 2.017$  S/m;  $\epsilon_r = 38.501$ ;  $\rho = 1000$  kg/m<sup>3</sup>

Ambient Temperature: 23.3oC      Liquid Temperature: 22.5oC

Communication System: UID 0, CW (0) Frequency: 2600 MHz Duty Cycle: 1:1

Probe: EX3DV4 - SN7517 ConvF(7.1, 7.1, 7.1)

Area Scan 3 (61x81x1): Interpolated grid:  $dx=1.200$  mm,  $dy=1.200$  mm

Reference Value = 113.0 V/m; Power Drift = 0.05 dB

Fast SAR: SAR(1 g) = 15.3 W/kg; SAR(10 g) = 6.69 W/kg

Maximum value of SAR (interpolated) = 26.0 W/kg

Zoom Scan (7x7x7)/Cube 0: Measurement grid:  $dx=5$ mm,  $dy=5$ mm,  $dz=5$ mm

Reference Value = 113.0 V/m; Power Drift = 0.05 dB

Peak SAR (extrapolated) = 32.7 W/kg

SAR(1 g) = 14.9 W/kg; SAR(10 g) = 6.57 W/kg

Maximum value of SAR (measured) = 25.5 W/kg

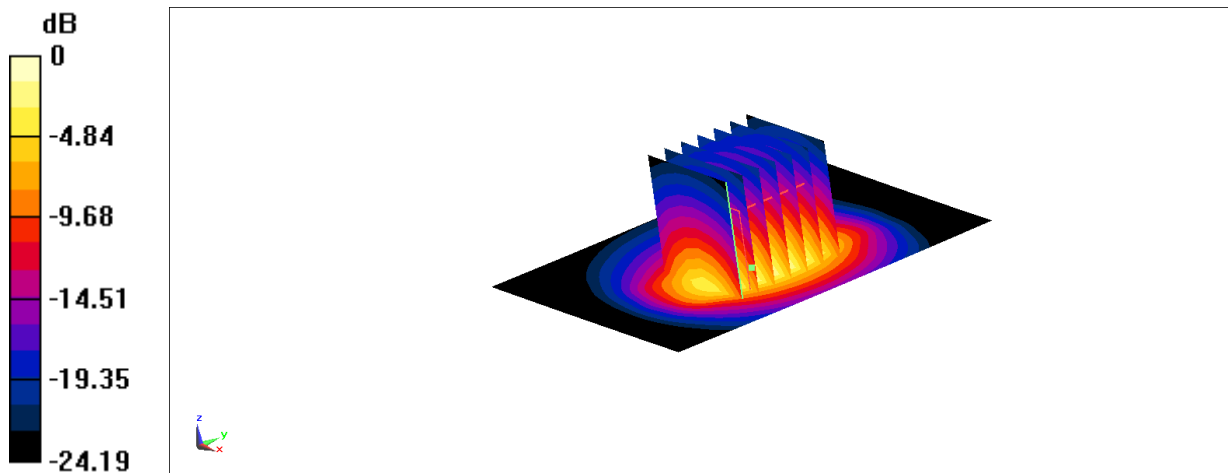

$$0 \text{ dB} = 25.5 \text{ W/kg} = 14.07 \text{ dBW/kg}$$

**Fig.B.17 validation 2600 MHz 250mW**



## 5250 MHz

Date: 4/15/2021

Electronics: DAE4 Sn1588

Medium: H5G

Medium parameters used:  $f = 5250$  MHz;  $\sigma = 4.863$  S/m;  $\epsilon_r = 34.425$ ;  $\rho = 1000$  kg/m<sup>3</sup>

Ambient Temperature: 23.3oC      Liquid Temperature: 22.5oC

Communication System: UID 0, CW (0) Frequency: 5250 MHz Duty Cycle: 1:1

Probe: EX3DV4 - SN7464 ConvF(5.55, 5.55, 5.55)

Area Scan (91x91x1): Interpolated grid: dx=1.000 mm, dy=1.000 mm

Maximum value of SAR (interpolated) = 20.6 W/kg

Zoom Scan (4x4x1.4mm, graded), dist=1.4mm (8x8x7)/Cube 0: Measurement grid:  
dx=4mm, dy=4mm, dz=1.4mm

Reference Value = 19.79 V/m; Power Drift = 0.12 dB

Peak SAR (extrapolated) = 37.5 W/kg

SAR(1 g) = 8.35 W/kg; SAR(10 g) = 2.31 W/kg

Maximum value of SAR (measured) = 20.1 W/kg

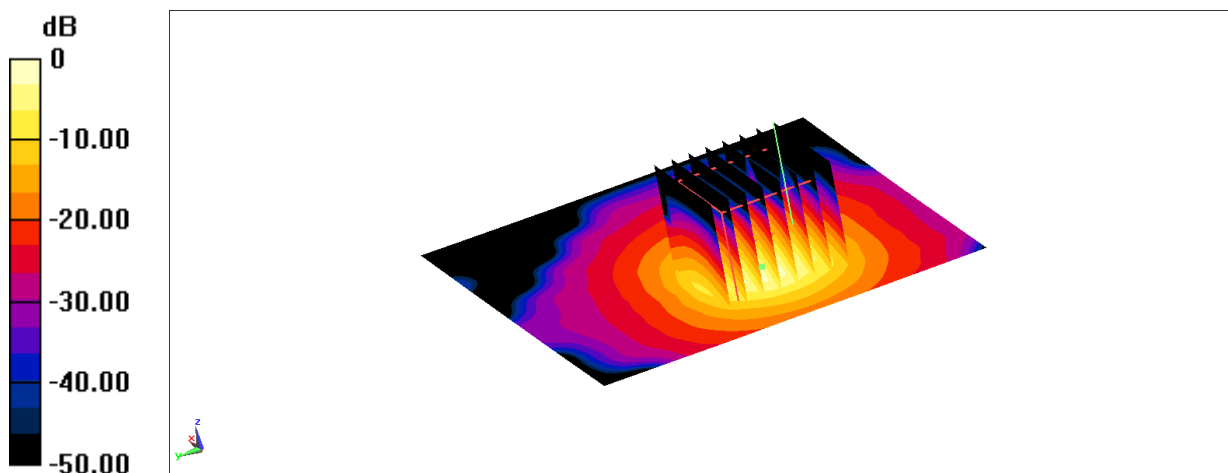

0 dB = 20.1 W/kg = 13.03 dBW/kg

**Fig.B.18 validation 5250 MHz 100mW**

## 5600 MHz

Date: 4/15/2021

Electronics: DAE4 Sn1588

Medium: H5G

Medium parameters used:  $f = 5600$  MHz;  $\sigma = 5.23$  S/m;  $\epsilon_r = 33.792$ ;  $\rho = 1000$  kg/m<sup>3</sup>

Ambient Temperature: 23.3oC      Liquid Temperature: 22.5oC

Communication System: UID 0, CW (0) Frequency: 5600 MHz Duty Cycle: 1:1

Probe: EX3DV4 - SN7464 ConvF(4.89, 4.89, 4.89)

Area Scan (91x91x1): Interpolated grid: dx=1.000 mm, dy=1.000 mm

Maximum value of SAR (interpolated) = 22.5 W/kg

Zoom Scan (4x4x1.4mm, graded), dist=1.4mm (8x8x7)/Cube 0: Measurement grid:  
dx=4mm, dy=4mm, dz=1.4mm

Reference Value = 20.28 V/m; Power Drift = 0.19 dB

Peak SAR (extrapolated) = 39.7 W/kg

SAR(1 g) = 8.7 W/kg; SAR(10 g) = 2.41 W/kg

Maximum value of SAR (measured) = 21.3 W/kg

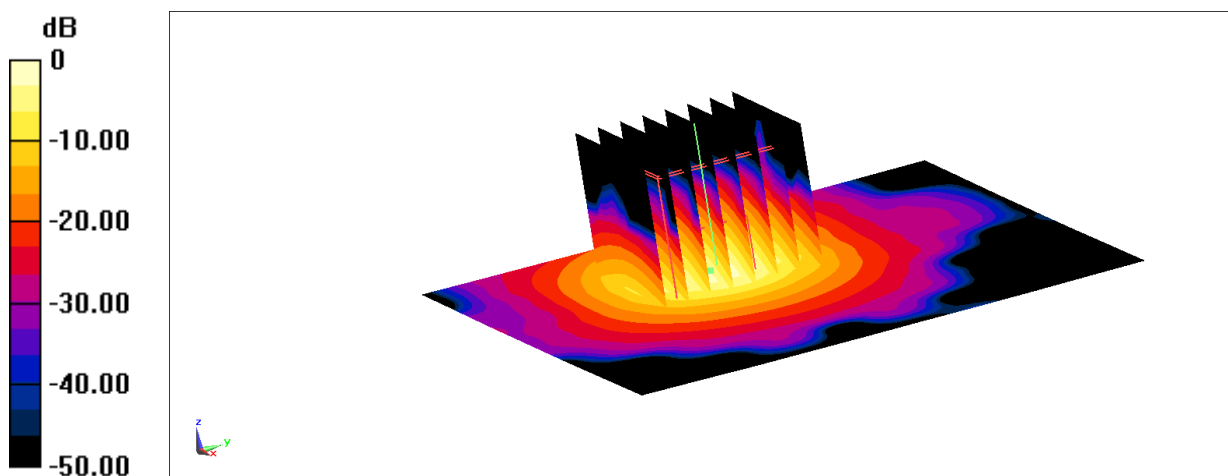

0 dB = 21.3 W/kg = 13.28 dBW/kg

**Fig.B.14 validation 5600 MHz 100mW**

## 5750 MHz

Date: 4/15/2021

Electronics: DAE4 Sn1588

Medium: H5G

Medium parameters used:  $f = 5750$  MHz;  $\sigma = 5.431$  S/m;  $\epsilon_r = 33.687$ ;  $\rho = 1000$  kg/m<sup>3</sup>

Ambient Temperature: 23.3oC      Liquid Temperature: 22.5oC

Communication System: UID 0, CW (0) Frequency: 5750 MHz Duty Cycle: 1:1

Probe: EX3DV4 - SN7464 ConvF(4.99, 4.99, 4.99)

Area Scan (91x91x1): Interpolated grid: dx=1.000 mm, dy=1.000 mm

Maximum value of SAR (interpolated) = 22.5 W/kg

Zoom Scan (4x4x1.4mm, graded), dist=1.4mm (8x8x7)/Cube 0: Measurement grid:  
dx=4mm, dy=4mm, dz=1.4mm

Reference Value = 19.99 V/m; Power Drift = 0.17 dB

Peak SAR (extrapolated) = 39.0 W/kg

SAR(1 g) = 8.01 W/kg; SAR(10 g) = 2.21 W/kg

Maximum value of SAR (measured) = 19.9 W/kg

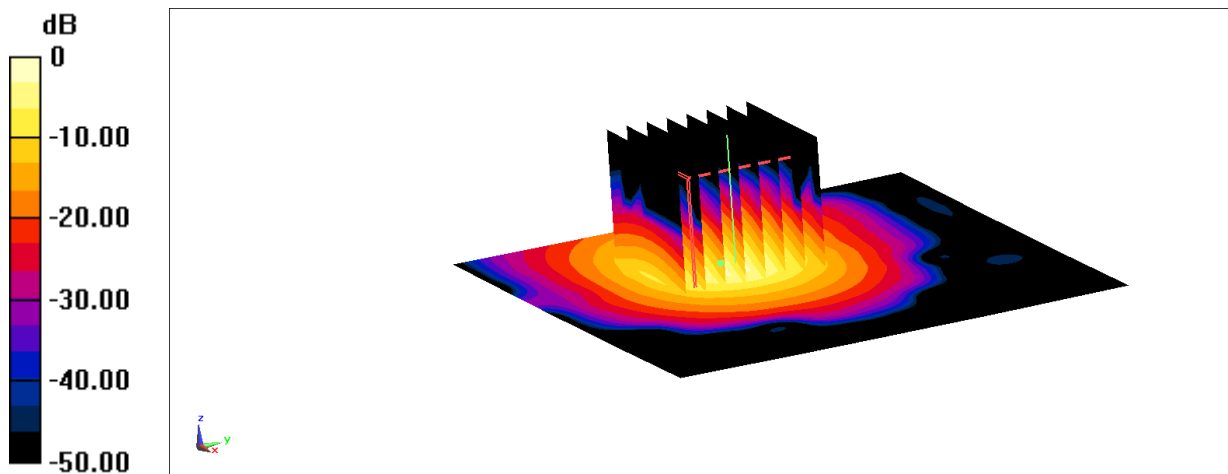

0 dB = 19.9 W/kg = 12.99 dBW/kg

**Fig.B.15 validation 5750 MHz 100mW**



The SAR system verification must be required that the area scan estimated 1-g SAR is within 3% of the zoom scan 1-g SAR.

**Table B.1 Comparison between area scan and zoom scan for system verification**

Date	Band	Position	Area scan (1g)	Zoom scan (1g)	Drift (%)
2021-3-29	750 MHz	Head	2.06	2.02	1.98
2021-3-30	750 MHz	Head	2.15	2.12	1.42
2021-3-31	750 MHz	Head	2.16	2.12	1.89
2021-4-25	750 MHz	Head	2.12	2.08	1.92
2021-4-26	750 MHz	Head	2.14	2.09	2.39
2021-3-29	835 MHz	Head	2.46	2.41	2.07
2021-3-30	835 MHz	Head	2.46	2.39	2.93
2021-4-25	835 MHz	Head	2.61	2.54	2.76
2021-3-29	1750 MHz	Head	9.22	9.15	0.77
2021-3-29	1750 MHz	Head	9.72	9.46	2.75
2021-3-30	1750 MHz	Head	10.14	9.85	2.94
2021-3-29	1900 MHz	Head	10.03	9.78	2.56
2021-3-29	1900 MHz	Head	10.04	9.79	2.55
2021-3-30	1900 MHz	Head	9.54	9.28	2.80
2021-3-30	2300 MHz	Head	12.65	12.3	2.85
2021-4-15	2450 MHz	Head	13.97	13.6	2.72
2021-3-30	2600 MHz	Head	15.3	14.9	2.68

## ANNEX C SAR Measurement Setup

### C.1 Measurement Set-up

The Dasy4 or DASY5 system for performing compliance tests is illustrated above graphically. This system consists of the following items:

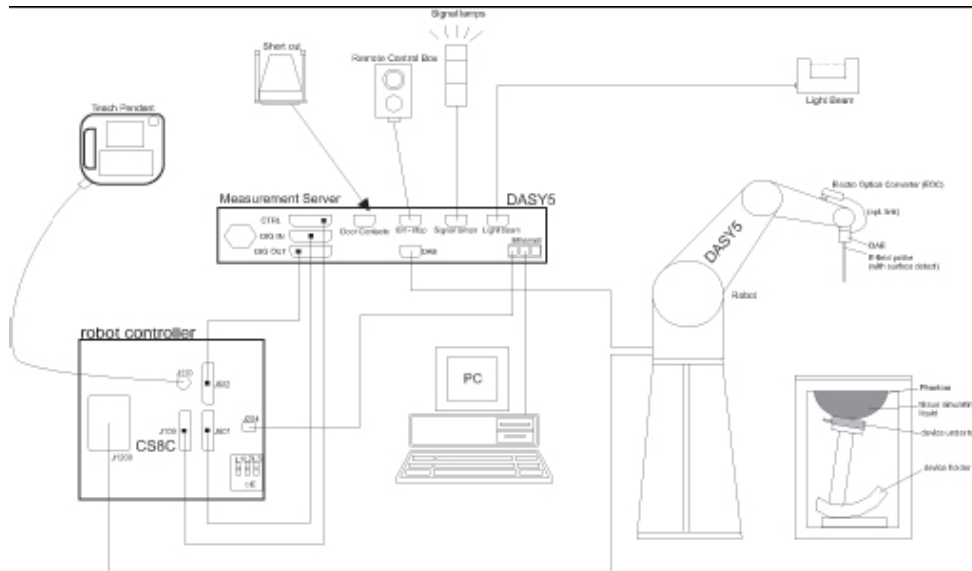

**Picture C.1 SAR Lab Test Measurement Set-up**

- A standard high precision 6-axis robot (StäubliTX=RX family) with controller, teach pendant and software. An arm extension for accommodating the data acquisition electronics (DAE).
- An isotropic field probe optimized and calibrated for the targeted measurement.
- A data acquisition electronics (DAE) which performs the signal amplification, signal multiplexing, AD-conversion, offset measurements, mechanical surface detection, collision detection, etc. The unit is battery powered with standard or rechargeable batteries. The signal is optically transmitted to the EOC.
- The Electro-optical converter (EOC) performs the conversion from optical to electrical signals for the digital communication to the DAE. To use optical surface detection, a special version of the EOC is required. The EOC signal is transmitted to the measurement server.
- The function of the measurement server is to perform the time critical tasks such as signal filtering, control of the robot operation and fast movement interrupts.
- The Light Beam used is for probe alignment. This improves the (absolute) accuracy of the probe positioning.
- A computer running WinXP and the DASY4 or DASY5 software.
- Remote control and teach pendant as well as additional circuitry for robot safety such as
- warning lamps, etc.
- The phantom, the device holder and other accessories according to the targeted measurement.

## C.2 Dasy4 or DASY5 E-field Probe System

The SAR measurements were conducted with the dosimetric probe designed in the classical triangular configuration and optimized for dosimetric evaluation. The probe is constructed using the thick film technique; with printed resistive lines on ceramic substrates. The probe is equipped with an optical multifiber line ending at the front of the probe tip. It is connected to the EOC box on the robot arm and provides an automatic detection of the phantom surface. Half of the fibers are connected to a pulsed infrared transmitter, the other half to a synchronized receiver. As the probe approaches the surface, the reflection from the surface produces a coupling from the transmitting to the receiving fibers. This reflection increases first during the approach, reaches maximum and then decreases. If the probe is flatly touching the surface, the coupling is zero. The distance of the coupling maximum to the surface is independent of the surface reflectivity and largely independent of the surface to probe angle. The DASY4 or DASY5 software reads the reflection during a software approach and looks for the maximum using 2<sup>nd</sup> ord curve fitting. The approach is stopped at reaching the maximum.

### Probe Specifications:

<b>Model:</b>	<b>ES3DV3, EX3DV4</b>
<b>Frequency</b>	<b>10MHz — 6.0GHz(EX3DV4)</b>
<b>Range:</b>	<b>10MHz — 4GHz(ES3DV3)</b>
<b>Calibration:</b>	<b>In head and body simulating tissue at Frequencies from 835 up to 5800MHz</b>
<b>Linearity:</b>	<b>± 0.2 dB(30 MHz to 6 GHz) for EX3DV4 ± 0.2 dB(30 MHz to 4 GHz) for ES3DV3</b>
<b>DynamicRange:</b>	<b>10 mW/kg — 100W/kg</b>
<b>Probe Length:</b>	<b>330 mm</b>
<b>Probe Tip</b>	
<b>Length:</b>	<b>20 mm</b>
<b>Body Diameter:</b>	<b>12 mm</b>
<b>Tip Diameter:</b>	<b>2.5 mm (3.9 mm for ES3DV3)</b>
<b>Tip-Center:</b>	<b>1 mm (2.0mm for ES3DV3)</b>
<b>Application:</b>	<b>SAR Dosimetry Testing Compliance tests of mobile phones Dosimetry in strong gradient fields</b>



Picture C.2Near-field Probe



Picture C.3E-field Probe

## C.3 E-field Probe Calibration

Each E-Probe/Probe Amplifier combination has unique calibration parameters. A TEM cell calibration procedure is conducted to determine the proper amplifier settings to enter in the probe parameters. The amplifier settings are determined for a given frequency by subjecting the probe to a known E-field density (1 mW/cm<sup>2</sup>) using an RF Signal generator, TEM cell, and RF Power Meter.

The free space E-field from amplified probe outputs is determined in a test chamber. This calibration can be performed in a TEM cell if the frequency is below 1 GHz and in a waveguide or other methodologies above 1 GHz for free space. For the free space calibration, the probe is placed

in the volumetric center of the cavity and at the proper orientation with the field. The probe is then rotated 360 degrees until the three channels show the maximum reading. The power density readings equates to 1 mW/cm<sup>2</sup>.

E-field temperature correlation calibration is performed in a flat phantom filled with the appropriate simulated brain tissue. The E-field in the medium correlates with the temperature rise in the dielectric medium. For temperature correlation calibration a RF transparent thermistor-based temperature probe is used in conjunction with the E-field probe.

$$SAR = C \frac{\Delta T}{\Delta t}$$

Where:

$\Delta t$  = Exposure time (30 seconds),

C = Heat capacity of tissue (brain or muscle),

$\Delta T$  = Temperature increase due to RF exposure.

$$SAR = \frac{|E|^2 \cdot \sigma}{\rho}$$

Where:

$\sigma$  = Simulated tissue conductivity,

$\rho$  = Tissue density (kg/m<sup>3</sup>).

## C.4 Other Test Equipment

### C.4.1 Data Acquisition Electronics(DAE)

The data acquisition electronics consist of a highly sensitive electrometer-grade preamplifier with auto-zeroing, a channel and gain-switching multiplexer, a fast 16 bit AD-converter and a command decoder with a control logic unit. Transmission to the measurement server is accomplished through an optical downlink for data and status information, as well as an optical uplink for commands and the clock.

The mechanical probe mounting device includes two different sensor systems for frontal and sideways probe contacts. They are used for mechanical surface detection and probe collision detection.

The input impedance of the DAE is 200 MOhm; the inputs are symmetrical and floating. Common mode rejection is above 80 dB.

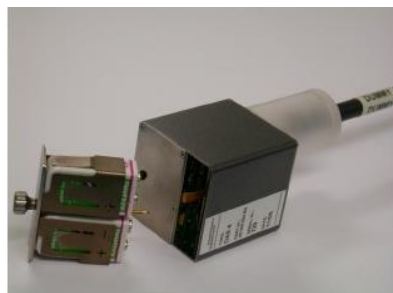

PictureC.4: DAE

### C.4.2 Robot

The SPEAG DASY system uses the high precision robots (DASY4: RX90XL; DASY5: RX160L) type from Stäubli SA (France). For the 6-axis controller system, the robot controller version from Stäubli is used. The Stäubli robot series have many features that are important for our application:

- High precision (repeatability 0.02mm)
- High reliability (industrial design)
- Low maintenance costs (virtually maintenance free due to direct drive gears; no belt drives)
- Jerk-free straight movements (brushless synchron motors; no stepper motors)
- Low ELF interference (motor control fields shielded via the closed metallic construction shields)



Picture C.5 DASY 4



Picture C.6 DASY 5

### C.4.3 Measurement Server

The Measurement server is based on a PC/104 CPU board with CPU (dasy4: 166 MHz, Intel Pentium; DASY5: 400 MHz, Intel Celeron), chipdisk (DASY4: 32 MB; DASY5: 128MB), RAM (DASY4: 64 MB, DASY5: 128MB). The necessary circuits for communication with the DAE electronic box, as well as the 16 bit AD converter system for optical detection and digital I/O interface are contained on the DASY I/O board, which is directly connected to the PC/104 bus of the CPU board.

The measurement server performs all real-time data evaluation of field measurements and surface detection, controls robot movements and handles safety operation. The PC operating system cannot interfere with these time critical processes. All connections are supervised by a watchdog, and disconnection of any of the cables to the measurement server will automatically disarm the robot and disable all program-controlled robot movements. Furthermore, the measurement server is equipped with an expansion port which is reserved for future applications. Please note that this expansion port does not have a standardized pinout, and therefore only devices provided by SPEAG can be connected. Devices from any other supplier could seriously damage the measurement server.



Picture C.7 Server for DASY 4



Picture C.8 Server for DASY 5



#### C.4.4 Device Holder for Phantom

The SAR in the phantom is approximately inversely proportional to the square of the distance between the source and the liquid surface. For a source at 5mm distance, a positioning uncertainty of  $\pm 0.5\text{mm}$  would produce a SAR uncertainty of  $\pm 20\%$ . Accurate device positioning is therefore crucial for accurate and repeatable measurements. The positions in which the devices must be measured are defined by the standards.

The DASY device holder is designed to cope with the different positions given in the standard. It has two scales for device rotation (with respect to the body axis) and device inclination (with respect to the line between the ear reference points). The rotation centers for both scales are the ear reference point (ERP). Thus the device needs no repositioning when changing the angles.

The DASY device holder is constructed of low-loss POM material having the following dielectric parameters: relative permittivity  $\epsilon = 3$  and loss tangent  $\delta = 0.02$ . The amount of dielectric material has been reduced in the closest vicinity of the device, since measurements have suggested that the influence of the clamp on the test results could thus be lowered.

<Laptop Extension Kit>

The extension is lightweight and made of POM, acrylic glass and foam. It fits easily on the upper part of the Mounting Device in place of the phone positioner. The extension is fully compatible with the Twin-SAM and ELI phantoms.



**Picture C.9-1: Device Holder**

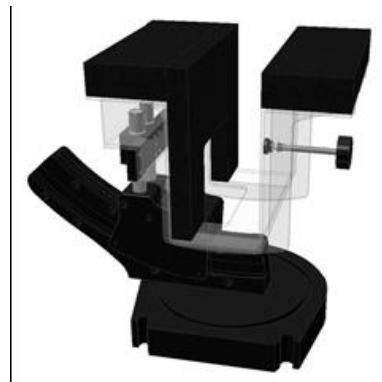

**Picture C.9-2: Laptop Extension Kit**

#### C.4.5 Phantom

The SAM Twin Phantom V4.0 is constructed of a fiberglass shell integrated in a table. The shape of the shell is based on data from an anatomical study designed to

Represent the 90<sup>th</sup> percentile of the population. The phantom enables the dissymmetric evaluation of SAR for both left and right handed handset usage, as well as body-worn usage using the flat phantom region. Reference markings on the Phantom allow the complete setup of all predefined phantom positions and measurement grids by manually teaching three points in the robot. The shell phantom has a 2mm shell thickness (except the ear region where shell thickness increases to 6 mm).

Shell Thickness:  $2 \pm 0.2$  mm

Filling Volume: Approx. 25 liters

Dimensions: 810 x 1000 x 500 mm (H x L x W)

Available: Special



**Picture C.10: SAM Twin Phantom**

## ANNEX D Position of the wireless device in relation to the phantom

### D.1 General considerations

This standard specifies two handset test positions against the head phantom – the “cheek” position and the “tilt” position.

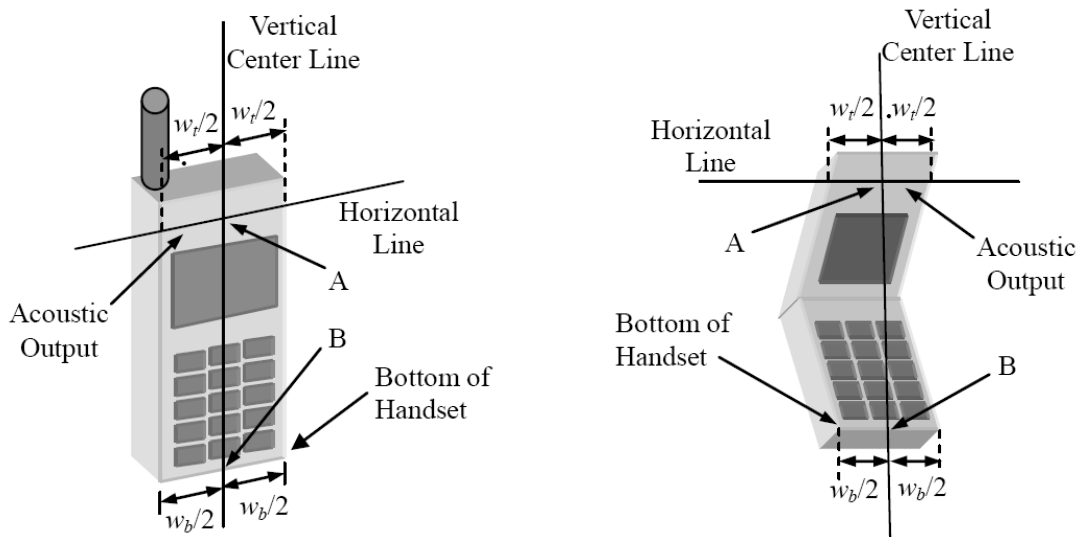

- $w_t$  Width of the handset at the level of the acoustic
- $w_b$  Width of the bottom of the handset
- A Midpoint of the width  $w_t$  of the handset at the level of the acoustic output
- B Midpoint of the width  $w_b$  of the bottom of the handset

Picture D.1-a Typical “fixed” case handset    Picture D.1-b Typical “clam-shell” case handset

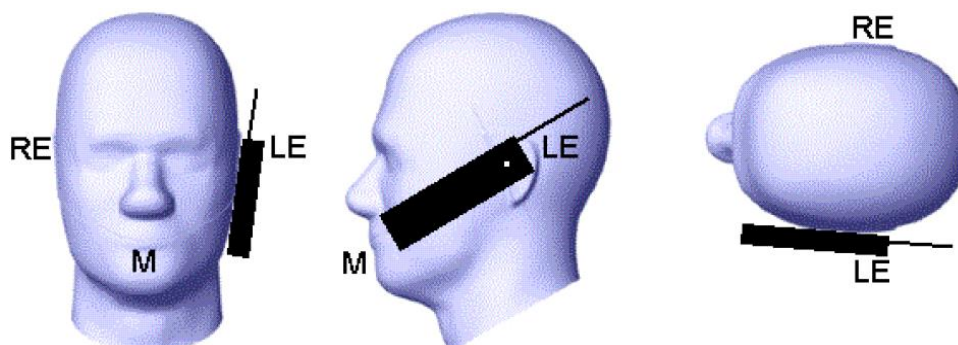

Picture D.2 Cheek position of the wireless device on the left side of SAM

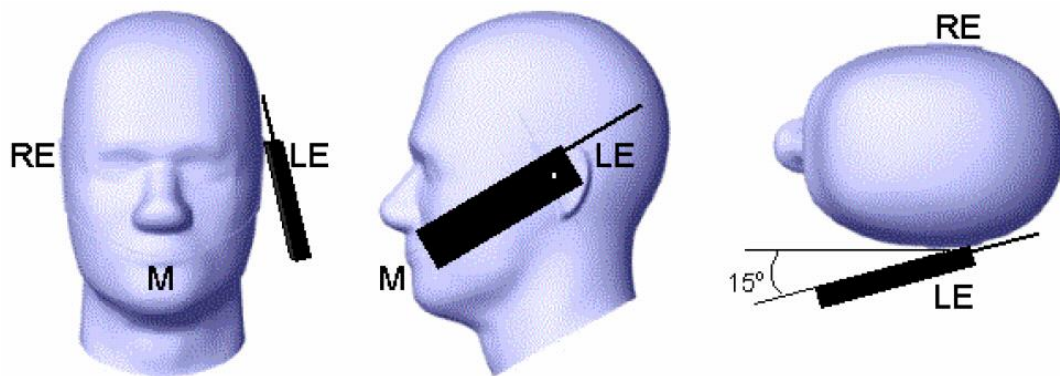

Picture D.3 Tilt position of the wireless device on the left side of SAM

## D.2 Body-worn device

A typical example of a body-worn device is a mobile phone, wireless enabled PDA or other battery operated wireless device with the ability to transmit while mounted on a person's body using a carry accessory approved by the wireless device manufacturer.

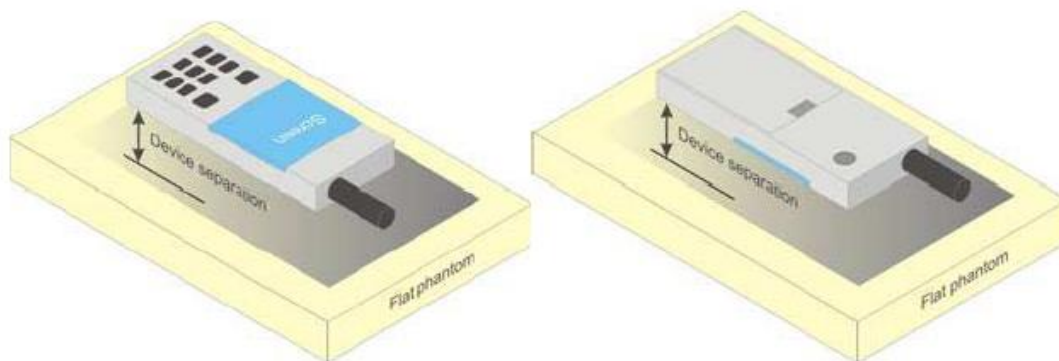

Picture D.4 Test positions for body-worn devices

## D.3 Desktop device

A typical example of a desktop device is a wireless enabled desktop computer placed on a table or desk when used.

The DUT shall be positioned at the distance and in the orientation to the phantom that corresponds to the intended use as specified by the manufacturer in the user instructions. For devices that employ an external antenna with variable positions, tests shall be performed for all antenna positions specified. Picture 8.5 show positions for desktop device SAR tests. If the intended use is not specified, the device shall be tested directly against the flat phantom.

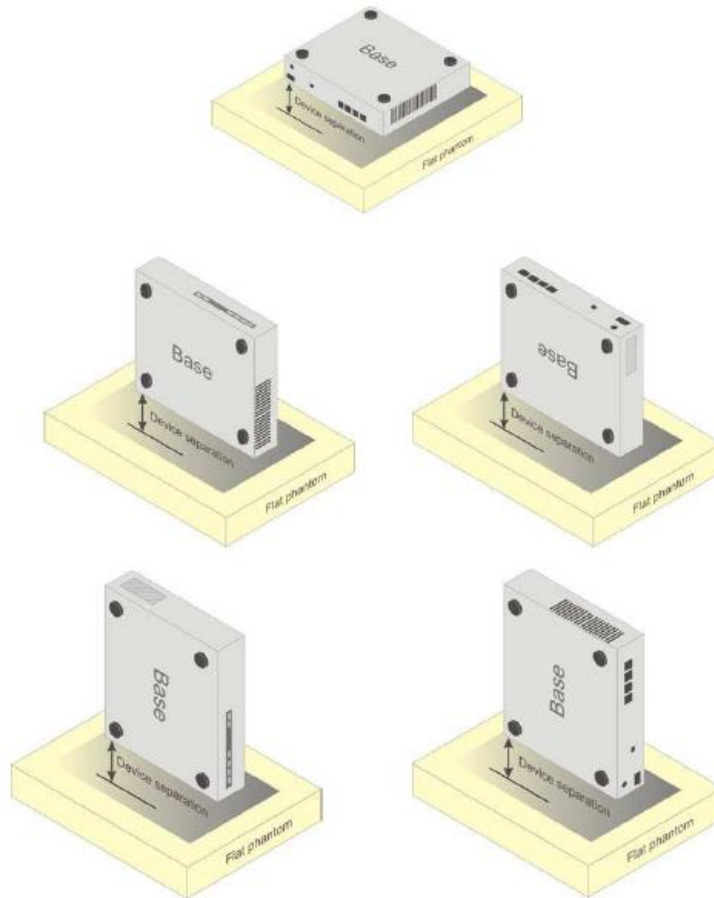

Picture D.5 Test positions for desktop devices

#### D.4 DUT Setup Photos



Picture D.6

## ANNEX E Equivalent Media Recipes

The liquid used for the frequency range of 800-3000 MHz consisted of water, sugar, salt, preventol, glycol monobutyl and Cellulose. The liquid has been previously proven to be suited for worst-case. The Table E.1 shows the detail solution. It's satisfying the latest tissue dielectric parameters requirements proposed by the IEEE 1528 and IEC 62209.

**TableE.1: Composition of the Tissue Equivalent Matter**

Frequency (MHz)	835Head	835Body	1900 Head	1900 Body	2450 Head	2450 Body	5800 Head	5800 Body
Ingredients (% by weight)								
Water	41.45	52.5	55.242	69.91	58.79	72.60	65.53	65.53
Sugar	56.0	45.0	\	\	\	\	\	\
Salt	1.45	1.4	0.306	0.13	0.06	0.18	\	\
Preventol	0.1	0.1	\	\	\	\	\	\
Cellulose	1.0	1.0	\	\	\	\	\	\
Glycol Monobutyl	\	\	44.452	29.96	41.15	27.22	\	\
Diethylenglycol monohexylether	\	\	\	\	\	\	17.24	17.24
Triton X-100	\	\	\	\	\	\	17.24	17.24
Dielectric Parameters	$\epsilon=41.5$	$\epsilon=55.2$	$\epsilon=40.0$	$\epsilon=53.3$	$\epsilon=39.2$	$\epsilon=52.7$	$\epsilon=35.3$	$\epsilon=48.2$
Target Value	$\sigma=0.90$	$\sigma=0.97$	$\sigma=1.40$	$\sigma=1.52$	$\sigma=1.80$	$\sigma=1.95$	$\sigma=5.27$	$\sigma=6.00$

**Note: There are a little adjustment respectively for 750, 1750, 2600, 5200, 5300 and 5600 based on the recipe of closest frequency in table E.1.**

## ANNEX F System Validation

The SAR system must be validated against its performance specifications before it is deployed. When SAR probes, system components or software are changed, upgraded or recalibrated, these must be validated with the SAR system(s) that operates with such components.

**Table F.1: System Validation for 7600**

Probe SN.	Liquid name	Validation date	Frequency point	Status (OK or Not)
7600	Head 750MHz	December 2, 2020	750 MHz	OK
7600	Head 900MHz	December 2, 2020	900 MHz	OK
7600	Head 1450MHz	December 3, 2020	1450 MHz	OK
7600	Head 1640MHz	December 3, 2020	1640 MHz	OK
7600	Head 1750MHz	December 3, 2020	1750 MHz	OK
7600	Head 1900MHz	December 4, 2020	1900 MHz	OK
7600	Head 2000MHz	December 4, 2020	2000 MHz	OK
7600	Head 2300MHz	December 4, 2020	2300 MHz	OK
7600	Head 2450MHz	December 5, 2020	2450 MHz	OK
7600	Head 2600MHz	December 5, 2020	2600 MHz	OK
7600	Head 3300MHz	December 6, 2020	3300 MHz	OK
7600	Head 3500MHz	December 6, 2020	3500 MHz	OK
7600	Head 3700MHz	December 6, 2020	3700 MHz	OK
7600	Head 3900MHz	December 7, 2020	3900 MHz	OK
7600	Head 4100MHz	December 7, 2020	4100MHz	OK
7600	Head 4200MHz	December 7, 2020	4200MHz	OK
7600	Head 4400MHz	December 8, 2020	4400MHz	OK
7600	Head 4600MHz	December 8, 2020	4600MHz	OK
7600	Head 4800MHz	December 8, 2020	4800MHz	OK
7600	Head 4950MHz	December 8, 2020	4950MHz	OK
7600	Head 5250MHz	December 9, 2020	5250MHz	OK
7600	Head 5600MHz	December 9, 2020	5600 MHz	OK
7600	Head 5750MHz	December 9, 2020	5750 MHz	OK

**Table F.2: System Validation for 7464**

Probe SN.	Liquid name	Validation date	Frequency point	Status (OK or Not)
<b>7464</b>	Head 750MHz	December 23, 2020	750 MHz	OK
<b>7464</b>	Head 900MHz	December 23, 2020	900 MHz	OK
<b>7464</b>	Head 1450MHz	December 24, 2020	1450 MHz	OK
<b>7464</b>	Head 1640MHz	December 24, 2020	1640 MHz	OK
<b>7464</b>	Head 1750MHz	December 24, 2020	1750 MHz	OK
<b>7464</b>	Head 1900MHz	December 25, 2020	1900 MHz	OK
<b>7464</b>	Head 2100MHz	December 25, 2020	2100 MHz	OK
<b>7464</b>	Head 2300MHz	December 25, 2020	2300 MHz	OK
<b>7464</b>	Head 2450MHz	December 25, 2020	2450 MHz	OK
<b>7464</b>	Head 2600MHz	December 25, 2020	2600 MHz	OK
<b>7464</b>	Head 3300MHz	December 26, 2020	3300 MHz	OK
<b>7464</b>	Head 3500MHz	December 26, 2020	3500 MHz	OK
<b>7464</b>	Head 3700MHz	December 26, 2020	3700 MHz	OK
<b>7464</b>	Head 3900MHz	December 27, 2020	3900 MHz	OK
<b>7464</b>	Head 4100MHz	December 27, 2020	4100MHz	OK
<b>7464</b>	Head 4200MHz	December 27, 2020	4200MHz	OK
<b>7464</b>	Head 4400MHz	December 28, 2020	4400MHz	OK
<b>7464</b>	Head 4600MHz	December 28, 2020	4600MHz	OK
<b>7464</b>	Head 4800MHz	December 28, 2020	4800MHz	OK
<b>7464</b>	Head 4950MHz	December 28, 2020	4950MHz	OK
<b>7464</b>	Head 5250MHz	December 29, 2020	5250MHz	OK
<b>7464</b>	Head 5600MHz	December 29, 2020	5600 MHz	OK
<b>7464</b>	Head 5750MHz	December 29, 2020	5750 MHz	OK



**Table F.3: System Validation for 7517**

Probe SN.	Liquid name	Validation date	Frequency point	Status (OK or Not)
7517	Head 750MHz	February 19, 2021	750 MHz	OK
7517	Head 900MHz	February 19, 2021	900 MHz	OK
7517	Head 1450MHz	February 20, 2021	1450 MHz	OK
7517	Head 1640MHz	February 20, 2021	1640 MHz	OK
7517	Head 1750MHz	February 21, 2021	1750 MHz	OK
7517	Head 1900MHz	February 21, 2021	1900 MHz	OK
7517	Head 2000MHz	February 22, 2021	2000 MHz	OK
7517	Head 2300MHz	February 22, 2021	2300 MHz	OK
7517	Head 2450MHz	February 22, 2021	2450 MHz	OK
7517	Head 2600MHz	February 23, 2021	2600 MHz	OK
7517	Head 3300MHz	February 23, 2021	3300 MHz	OK
7517	Head 3500MHz	February 23, 2021	3500 MHz	OK
7517	Head 3700MHz	February 24, 2021	3700 MHz	OK
7517	Head 3900MHz	February 24, 2021	3900 MHz	OK
7517	Head 4100MHz	February 25, 2021	4100MHz	OK
7517	Head 4200MHz	February 25, 2021	4200MHz	OK
7517	Head 4400MHz	February 25, 2021	4400MHz	OK
7517	Head 4600MHz	February 26, 2021	4600MHz	OK
7517	Head 4800MHz	February 26, 2021	4800MHz	OK
7517	Head 4950MHz	February 26, 2021	4950MHz	OK
7517	Head 5250MHz	February 27, 2021	5250MHz	OK
7517	Head 5600MHz	February 27, 2021	5600 MHz	OK
7517	Head 5750MHz	February 27, 2021	5750 MHz	OK

**Table F.4: System Validation for 7548**

Probe SN.	Liquid name	Validation date	Frequency point	Status (OK or Not)
7548	Head 750MHz	July 2, 2020	750 MHz	OK
7548	Head 900MHz	July 2, 2020	900 MHz	OK
7548	Head 1450MHz	July 3, 2020	1450 MHz	OK
7548	Head 1750MHz	July 3, 2020	1750 MHz	OK
7548	Head 1900MHz	July 3, 2020	1900 MHz	OK
7548	Head 2000MHz	July 4, 2020	2000 MHz	OK
7548	Head 2300MHz	July 4, 2020	2300 MHz	OK
7548	Head 2450MHz	July 4, 2020	2450 MHz	OK
7548	Head 2600MHz	July 4, 2020	2600 MHz	OK
7548	Head 3300MHz	July 5, 2020	3300 MHz	OK
7548	Head 3500MHz	July 5, 2020	3500 MHz	OK
7548	Head 3700MHz	July 5, 2020	3700 MHz	OK
7548	Head 3900MHz	July 5, 2020	3900 MHz	OK
7548	Head 4100MHz	July 6, 2020	4100MHz	OK
7548	Head 4200MHz	July 6, 2020	4200MHz	OK
7548	Head 4400MHz	July 6, 2020	4400MHz	OK
7548	Head 4600MHz	July 6, 2020	4600MHz	OK
7548	Head 4800MHz	July 6, 2020	4800MHz	OK
7548	Head 4950MHz	July 6, 2020	4950MHz	OK
7548	Head 5250MHz	July 7, 2020	5250MHz	OK
7548	Head 5600MHz	July 7, 2020	5600 MHz	OK
7548	Head 5750MHz	July 7, 2020	5750 MHz	OK



No.I21Z70098-SEM01

## ANNEX G Probe Calibration Certificate



中国认可  
国际互认  
校准  
CALIBRATION  
CNAS L0570

Add: No.51 Xueyuan Road, Haidian District, Beijing, 100191, China  
Tel: +86-10-62304633-2512 Fax: +86-10-62304633-2504  
E-mail: cttl@chinattl.com [Http://www.chinattl.cn](http://www.chinattl.cn)

Client

**CTTL**

Certificate No: **Z20-60421**

### CALIBRATION CERTIFICATE

Object **EX3DV4 - SN : 7600**

Calibration Procedure(s) **FF-Z11-004-02**  
**Calibration Procedures for Dosimetric E-field Probes**

Calibration date: **November 30, 2020**

This calibration Certificate documents the traceability to national standards, which realize the physical units of measurements(SI). The measurements and the uncertainties with confidence probability are given on the following pages and are part of the certificate.

All calibrations have been conducted in the closed laboratory facility: environment temperature(22±3)°C and humidity<70%.

Calibration Equipment used (M&TE critical for calibration)

Primary Standards	ID #	Cal Date(Calibrated by, Certificate No.)	Scheduled Calibration
Power Meter NRP2	101919	16-Jun-20(CTTL, No.J20X04344)	Jun-21
Power sensor NRP-Z91	101547	16-Jun-20(CTTL, No.J20X04344)	Jun-21
Power sensor NRP-Z91	101548	16-Jun-20(CTTL, No.J20X04344)	Jun-21
Reference 10dBAttenuator	18N50W-10dB	10-Feb-20(CTTL, No.J20X00525)	Feb-22
Reference 20dBAttenuator	18N50W-20dB	10-Feb-20(CTTL, No.J20X00526)	Feb-22
Reference Probe EX3DV4	SN 7307	29-May-20(SPEAG, No.EX3-7307_May20)	May-21
DAE4	SN 1556	4-Feb-20(SPEAG, No.DAE4-1556_Feb20)	Feb-21

Secondary Standards	ID #	Cal Date(Calibrated by, Certificate No.)	Scheduled Calibration
SignalGenerator MG3700A	6201052605	23-Jun-20(CTTL, No.J20X04343)	Jun-21
Network Analyzer E5071C	MY46110673	10-Feb-20(CTTL, No.J20X00515)	Feb-21

	Name	Function	Signature
Calibrated by:	Yu Zongying	SAR Test Engineer	
Reviewed by:	Lin Hao	SAR Test Engineer	
Approved by:	Qi Dianyuan	SAR Project Leader	

Issued: December 02, 2020

This calibration certificate shall not be reproduced except in full without written approval of the laboratory.

Certificate No: Z20-60421

Page 1 of 9

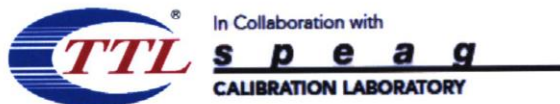

Add: No.51 Xueyuan Road, Haidian District, Beijing, 100191, China  
Tel: +86-10-62304633-2512 Fax: +86-10-62304633-2504  
E-mail: cttl@chinattl.com [Http://www.chinattl.cn](http://www.chinattl.cn)

**Glossary:**

TSL	tissue simulating liquid
NORM <sub>x,y,z</sub>	sensitivity in free space
ConvF	sensitivity in TSL / NORM <sub>x,y,z</sub>
DCP	diode compression point
CF	crest factor (1/duty_cycle) of the RF signal
A,B,C,D	modulation dependent linearization parameters
Polarization $\Phi$	$\Phi$ rotation around probe axis
Polarization $\theta$	$\theta$ rotation around an axis that is in the plane normal to probe axis (at measurement center), $i$ $\theta=0$ is normal to probe axis
Connector Angle	information used in DASY system to align probe sensor X to the robot coordinate system

**Calibration is Performed According to the Following Standards:**

- IEEE Std 1528-2013, "IEEE Recommended Practice for Determining the Peak Spatial-Averaged Specific Absorption Rate (SAR) in the Human Head from Wireless Communications Devices: Measurement Techniques", June 2013
- IEC 62209-1, "Measurement procedure for the assessment of Specific Absorption Rate (SAR) from hand-held and body-mounted devices used next to the ear (frequency range of 300 MHz to 6 GHz)", July 2016
- IEC 62209-2, "Procedure to determine the Specific Absorption Rate (SAR) for wireless communication devices used in close proximity to the human body (frequency range of 30 MHz to 6 GHz)", March 2010
- KDB 865664, "SAR Measurement Requirements for 100 MHz to 6 GHz"

**Methods Applied and Interpretation of Parameters:**

- NORM<sub>x,y,z</sub>:** Assessed for E-field polarization  $\theta=0$  ( $f \leq 900$  MHz in TEM-cell;  $f > 1800$  MHz: waveguide). NORM<sub>x,y,z</sub> are only intermediate values, i.e., the uncertainties of NORM<sub>x,y,z</sub> does not effect the  $E^2$ -field uncertainty inside TSL (see below ConvF).
- NORM( $f$ )<sub>x,y,z</sub> = NORM<sub>x,y,z</sub> \* frequency\_response** (see Frequency Response Chart). This linearization is implemented in DASY4 software versions later than 4.2. The uncertainty of the frequency response is included in the stated uncertainty of ConvF.
- DCP<sub>x,y,z</sub>:** DCP are numerical linearization parameters assessed based on the data of power sweep (no uncertainty required). DCP does not depend on frequency nor media.
- PAR:** PAR is the Peak to Average Ratio that is not calibrated but determined based on the signal characteristics.
- A<sub>x,y,z</sub>; B<sub>x,y,z</sub>; C<sub>x,y,z</sub>; VR<sub>x,y,z</sub>:** A,B,C are numerical linearization parameters assessed based on the data of power sweep for specific modulation signal. The parameters do not depend on frequency nor media. VR is the maximum calibration range expressed in RMS voltage across the diode.
- ConvF and Boundary Effect Parameters:** Assessed in flat phantom using E-field (or Temperature Transfer Standard for  $f \leq 800$  MHz) and inside waveguide using analytical field distributions based on power measurements for  $f > 800$  MHz. The same setups are used for assessment of the parameters applied for boundary compensation (alpha, depth) of which typical uncertainty valued are given. These parameters are used in DASY4 software to improve probe accuracy close to the boundary. The sensitivity in TSL corresponds to NORM<sub>x,y,z</sub> \* ConvF whereby the uncertainty corresponds to that given for ConvF. A frequency dependent ConvF is used in DASY version 4.4 and higher which allows extending the validity from  $\pm 50$  MHz to  $\pm 100$  MHz.
- Spherical isotropy (3D deviation from isotropy):** in a field of low gradients realized using a flat phantom exposed by a patch antenna.
- Sensor Offset:** The sensor offset corresponds to the offset of virtual measurement center from the probe tip (on probe axis). No tolerance required.
- Connector Angle:** The angle is assessed using the information gained by determining the NORM<sub>x</sub> (no uncertainty required).

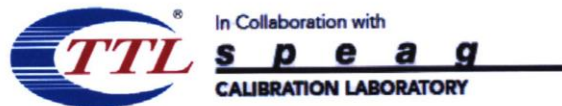

Add: No.51 Xueyuan Road, Haidian District, Beijing, 100191, China  
 Tel: +86-10-62304633-2512 Fax: +86-10-62304633-2504  
 E-mail: cttl@chinattl.com [Http://www.chinattl.cn](http://www.chinattl.cn)

## DASY/EASY – Parameters of Probe: EX3DV4 – SN:7600

### Basic Calibration Parameters

	Sensor X	Sensor Y	Sensor Z	Unc (k=2)
Norm( $\mu\text{V}/(\text{V}/\text{m})^2$ ) <sup>A</sup>	0.70	0.65	0.67	±10.0%
DCP(mV) <sup>B</sup>	109.4	109.2	108.7	

### Modulation Calibration Parameters

UID	Communication System Name		A dB	B dB/μV	C	D dB	VR mV	Unc <sup>E</sup> (k=2)
0	CW	X	0.0	0.0	1.0	0.00	225.0	±2.1%
		Y	0.0	0.0	1.0		206.5	
		Z	0.0	0.0	1.0		212.8	

The reported uncertainty of measurement is stated as the standard uncertainty of Measurement multiplied by the coverage factor  $k=2$ , which for a normal distribution Corresponds to a coverage probability of approximately 95%.

<sup>A</sup> The uncertainties of Norm X, Y, Z do not affect the E<sup>2</sup>-field uncertainty inside TSL (see Page 4).

<sup>B</sup> Numerical linearization parameter: uncertainty not required.

<sup>E</sup> Uncertainty is determined using the max. deviation from linear response applying rectangular distribution and is expressed for the square of the field value.



Add: No.51 Xueyuan Road, Haidian District, Beijing, 100191, China  
 Tel: +86-10-62304633-2512 Fax: +86-10-62304633-2504  
 E-mail: cttl@chinattl.com [Http://www.chinattl.cn](http://www.chinattl.cn)

## DASY/EASY – Parameters of Probe: EX3DV4 – SN:7600

### Calibration Parameter Determined in Head Tissue Simulating Media

f [MHz] <sup>C</sup>	Relative Permittivity <sup>F</sup>	Conductivity (S/m) <sup>F</sup>	ConvF X	ConvF Y	ConvF Z	Alpha <sup>G</sup>	Depth <sup>G</sup> (mm)	Unct. (k=2)
750	41.9	0.89	10.88	10.88	10.88	0.40	0.77	±12.1%
900	41.5	0.97	10.45	10.45	10.45	0.17	1.31	±12.1%
1450	40.5	1.20	9.28	9.28	9.28	0.10	1.40	±12.1%
1640	40.3	1.29	9.10	9.10	9.10	0.21	1.03	±12.1%
1750	40.1	1.37	9.01	9.01	9.01	0.20	1.11	±12.1%
1900	40.0	1.40	8.70	8.70	8.70	0.26	1.03	±12.1%
2000	40.0	1.40	8.68	8.68	8.68	0.21	1.16	±12.1%
2300	39.5	1.67	8.19	8.19	8.19	0.37	0.88	±12.1%
2450	39.2	1.80	7.79	7.79	7.79	0.35	1.00	±12.1%
2600	39.0	1.96	7.67	7.67	7.67	0.46	0.80	±12.1%
3300	38.2	2.71	7.35	7.35	7.35	0.43	0.95	±13.3%
3500	37.9	2.91	7.01	7.01	7.01	0.44	0.94	±13.3%
3700	37.7	3.12	6.77	6.77	6.77	0.42	1.02	±13.3%
3900	37.5	3.32	6.85	6.85	6.85	0.35	1.30	±13.3%
4100	37.2	3.53	6.75	6.75	6.75	0.40	1.15	±13.3%
4200	37.1	3.63	6.65	6.65	6.65	0.35	1.35	±13.3%
4400	36.9	3.84	6.54	6.54	6.54	0.35	1.35	±13.3%
4600	36.7	4.04	6.39	6.39	6.39	0.45	1.25	±13.3%
4800	36.4	4.25	6.34	6.34	6.34	0.40	1.42	±13.3%
4950	36.3	4.40	6.01	6.01	6.01	0.45	1.30	±13.3%
5250	35.9	4.71	5.68	5.68	5.68	0.45	1.30	±13.3%
5600	35.5	5.07	5.11	5.11	5.11	0.50	1.25	±13.3%
5750	35.4	5.22	5.07	5.07	5.07	0.50	1.25	±13.3%

<sup>C</sup> Frequency validity above 300 MHz of ±100MHz only applies for DASY v4.4 and higher (Page 2), else it is restricted to ±50MHz. The uncertainty is the RSS of ConvF uncertainty at calibration frequency and the uncertainty for the indicated frequency band. Frequency validity below 300 MHz is ± 10, 25, 40, 50 and 70 MHz for ConvF assessments at 30, 64, 128, 150 and 220 MHz respectively. Above 5 GHz frequency validity can be extended to ± 110 MHz.

<sup>F</sup> At frequency below 3 GHz, the validity of tissue parameters ( $\epsilon$  and  $\sigma$ ) can be relaxed to ±10% if liquid compensation formula is applied to measured SAR values. At frequencies above 3 GHz, the validity of tissue parameters ( $\epsilon$  and  $\sigma$ ) is restricted to ±5%. The uncertainty is the RSS of the ConvF uncertainty for indicated target tissue parameters.

<sup>G</sup> Alpha/Depth are determined during calibration. SPEAG warrants that the remaining deviation due to the boundary effect after compensation is always less than ± 1% for frequencies below 3 GHz and below ± 2% for the frequencies between 3-6 GHz at any distance larger than half the probe tip diameter from the boundary.