



SAR TEST REPORT

No. I20Z70015-SEM01

For

Samsung Electronics. Co., Ltd.

Mobile phone

Model name: SM-A115U

With

Hardware Version: REV1.0

Software Version: A115U.001

FCC ID: ZCasma115U

Issued Date: 2020-5-6

Note:

The test results in this test report relate only to the devices specified in this report. This report shall not be reproduced except in full without the written approval of CTTL.

The report must not be used by the client to claim product certification, approval, or endorsement by NVLAP, NIST, or any agency of the U.S. Government.

Test Laboratory:

CTTL, Telecommunication Technology Labs, CAICT

No. 51, Xueyuan Road, Haidian District, Beijing, P. R. China 100191.

Tel:+86(0)10-62304633-2512, Fax:+86(0)10-62304633-2504

Email: ctl_terminals@caict.ac.cn, website: www.caict.ac.cn



No.I20Z70015-SEM01

REPORT HISTORY

| Report Number | Revision | Issue Date | Description |
|----------------------|-----------------|-------------------|------------------------------------|
| I20Z70015-SEM01 | Rev.0 | 2020-5-2 | Initial creation of test report |
| I20Z70015-SEM01 | Rev.1 | 2020-5-6 | Remove LTE Band40 relative results |



TABLE OF CONTENT

| | |
|--|-----------|
| 1 TEST LABORATORY | 5 |
| 1.1 TESTING LOCATION | 5 |
| 1.2 TESTING ENVIRONMENT..... | 5 |
| 1.3 PROJECT DATA | 5 |
| 1.4 SIGNATURE..... | 5 |
| 2 STATEMENT OF COMPLIANCE | 6 |
| 3 CLIENT INFORMATION | 8 |
| 3.1 APPLICANT INFORMATION | 8 |
| 3.2 MANUFACTURER INFORMATION | 8 |
| 4 EQUIPMENT UNDER TEST (EUT) AND ANCILLARY EQUIPMENT (AE) | 9 |
| 4.1 ABOUT EUT | 9 |
| 4.2 INTERNAL IDENTIFICATION OF EUT USED DURING THE TEST | 9 |
| 4.3 INTERNAL IDENTIFICATION OF AE USED DURING THE TEST | 9 |
| 5 TEST METHODOLOGY | 10 |
| 5.1 APPLICABLE LIMIT REGULATIONS | 10 |
| 5.2 APPLICABLE MEASUREMENT STANDARDS | 10 |
| 6 SPECIFIC ABSORPTION RATE (SAR) | 11 |
| 6.1 INTRODUCTION..... | 11 |
| 6.2 SAR DEFINITION..... | 11 |
| 7 TISSUE SIMULATING LIQUIDS | 12 |
| 7.1 TARGETS FOR TISSUE SIMULATING LIQUID..... | 12 |
| 7.2 DIELECTRIC PERFORMANCE | 12 |
| 8 SYSTEM VERIFICATION | 17 |
| 8.1 SYSTEM SETUP..... | 17 |
| 8.2 SYSTEM VERIFICATION..... | 18 |
| 9 MEASUREMENT PROCEDURES | 19 |
| 9.1 TESTS TO BE PERFORMED | 19 |
| 9.2 GENERAL MEASUREMENT PROCEDURE..... | 21 |
| 9.3 WCDMA MEASUREMENT PROCEDURES FOR SAR | 22 |
| 9.4 SAR MEASUREMENT FOR LTE..... | 23 |
| 9.5 BLUETOOTH & WI-FI MEASUREMENT PROCEDURES FOR SAR | 25 |
| 9.6 POWER DRIFT..... | 25 |
| 10 AREA SCAN BASED 1-G SAR | 26 |
| 10.1 REQUIREMENT OF KDB..... | 26 |
| 10.2 FAST SAR ALGORITHMS..... | 26 |

| | |
|---|------------|
| 11 CONDUCTED OUTPUT POWER..... | 27 |
| 11.1 GSM MEASUREMENT RESULT | 27 |
| 11.2 WCDMA MEASUREMENT RESULT | 29 |
| 11.3 CDMA MEASUREMENT RESULT | 31 |
| 11.4 LTE MEASUREMENT RESULT | 32 |
| 11.4 Wi-Fi AND BT MEASUREMENT RESULT | 66 |
| 12 SIMULTANEOUS TX SAR CONSIDERATIONS..... | 69 |
| 12.1 INTRODUCTION..... | 69 |
| 12.2 TRANSMIT ANTENNA SEPARATION DISTANCES..... | 69 |
| 12.3 SAR MEASUREMENT POSITIONS | 70 |
| 12.4 STANDALONE SAR TEST EXCLUSION CONSIDERATIONS | 70 |
| 13 EVALUATION OF SIMULTANEOUS..... | 71 |
| 14 SAR TEST RESULT | 73 |
| 14.1 SAR RESULTS FOR FAST SAR | 74 |
| 14.2 SAR RESULTS FOR STANDARD PROCEDURE | 91 |
| 14.3 WLAN EVALUATION FOR 2.4G | 99 |
| 14.4 WLAN EVALUATION FOR 5G..... | 102 |
| 15 SAR MEASUREMENT VARIABILITY..... | 109 |
| 16 MEASUREMENT UNCERTAINTY | 110 |
| 16.1 MEASUREMENT UNCERTAINTY FOR NORMAL SAR TESTS (300MHZ~3GHZ)..... | 110 |
| 16.2 MEASUREMENT UNCERTAINTY FOR NORMAL SAR TESTS (3~6GHZ) | 111 |
| 16.3 MEASUREMENT UNCERTAINTY FOR FAST SAR TESTS (300MHZ~3GHZ)..... | 112 |
| 16.4 MEASUREMENT UNCERTAINTY FOR FAST SAR TESTS (3~6GHZ) | 113 |
| 17 MAIN TEST INSTRUMENTS..... | 114 |
| ANNEX A GRAPH RESULTS | 115 |
| ANNEX B SYSTEM VERIFICATION RESULTS | 165 |
| ANNEX C SAR MEASUREMENT SETUP | 176 |
| ANNEX D POSITION OF THE WIRELESS DEVICE IN RELATION TO THE PHANTOM | 182 |
| ANNEX E EQUIVALENT MEDIA RECIPES | 185 |
| ANNEX F SYSTEM VALIDATION | 186 |
| ANNEX G PROBE CALIBRATION CERTIFICATE..... | 187 |
| ANNEX H DIPOLE CALIBRATION CERTIFICATE | 207 |
| ANNEX I SENSOR TRIGGERING DATA SUMMARY..... | 286 |
| ANNEX J ACCREDITATION CERTIFICATE..... | 293 |

1 Test Laboratory

1.1 Testing Location

| | |
|---------------|---|
| Company Name: | CTTL(Shouxiang) |
| Address: | No. 51 Shouxiang Science Building, Xueyuan Road, Haidian District, Beijing, P. R. China100191 |

1.2 Testing Environment

| | |
|-----------------------------|----------------|
| Temperature: | 18°C~25°C, |
| Relative humidity: | 30%~ 70% |
| Ground system resistance: | < 0.5 Ω |
| Ambient noise & Reflection: | < 0.012 W/kg |

1.3 Project Data

| | |
|---------------------|----------------|
| Project Leader: | Qi Dianyuan |
| Test Engineer: | Lin Xiaojun |
| Testing Start Date: | March 19, 2020 |
| Testing End Date: | March 28, 2020 |

1.4 Signature



Lin Xiaojun
(Prepared this test report)



Qi Dianyuan
(Reviewed this test report)

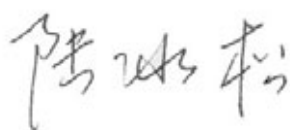

Lu Bingsong
Deputy Director of the laboratory
(Approved this test report)



2 Statement of Compliance

The maximum results of SAR found during testing for Samsung Electronics. Co., Ltd. Mobile phone SM-A115U are as follows:

Table 2.1: Highest Reported SAR (1g)

| Exposure Configuration | Technology Band | Highest Reported SAR 1g(W/kg) | Equipment Class |
|------------------------|-----------------|-------------------------------|-----------------|
| Head | GSM 850 | 0.49 | PCE |
| | PCS 1900 | 0.31 | |
| | UMTS FDD 2 | 0.73 | |
| | UMTS FDD 4 | 1.08 | |
| | UMTS FDD 5 | 0.58 | |
| | LTE Band 7 | 0.26 | |
| | LTE Band 12 | 0.29 | |
| | LTE Band 13 | 0.29 | |
| | LTE Band 25 | 0.71 | |
| | LTE Band 26 | 0.38 | |
| | LTE Band 41 | 0.19 | |
| | LTE Band 66 | 0.78 | |
| | LTE Band 71 | 0.24 | |
| | CDMA BC0 | 0.35 | |
| | CDMA BC1 | 0.82 | |
| | CDMA BC10 | 0.10 | |
| | WLAN 2.4 GHz | 0.30 | DTS |
| | WLAN 5 GHz | 0.49 | UNII |
| Hotspot | GSM 850 | 0.76 | PCE |
| | PCS 1900 | 0.70 | |
| | UMTS FDD 2 | 0.29 | |
| | UMTS FDD 4 | 0.44 | |
| | UMTS FDD 5 | 0.63 | |
| | LTE Band 7 | 0.44 | |
| | LTE Band 12 | 0.30 | |
| | LTE Band 13 | 0.51 | |
| | LTE Band 25 | 0.54 | |
| | LTE Band 26 | 0.50 | |
| | LTE Band 41 | 0.66 | |
| | LTE Band 66 | 0.47 | |
| | LTE Band 71 | 0.19 | |
| | CDMA BC0 | 0.69 | |
| | CDMA BC1 | 0.55 | |
| | CDMA BC10 | 0.15 | |
| | WLAN 2.4 GHz | 0.31 | DTS |
| | WLAN 5 GHz | 0.68 | UNII |

The SAR values found for the Mobile Phone are below the maximum recommended levels of 1.6 W/kg as averaged over any 1g tissue according to the ANSI C95.1-1992.

For body operation, this device has been tested and meets FCC RF exposure guidelines when used

with any accessory that contains no metal and which provides a minimum separation distance of 10 mm for hotspot and 15mm for body worn between this device and the body of the user. Use of other accessories may not ensure compliance with FCC RF exposure guidelines.

The EUT battery must be fully charged and checked periodically during the test to ascertain uniform power output.

The measurement together with the test system set-up is described in annex C of this test report. A detailed description of the equipment under test can be found in chapter 4 of this test report. The highest reported SAR value is obtained at the case of (**Table 2.1**), and the values are: **1.08 W/kg(1g)**.

Table 2.2: The sum of reported SAR values for main antenna and WiFi2.4G

| | Position | Main antenna | WiFi | Sum |
|--|------------------------------|--------------|------|-------------|
| Highest reported SAR value for Head | Right hand, Tilt (WCDMA1700) | 1.08 | 0.09 | 1.17 |
| Highest reported SAR value for Body | Rear 10mm (GSM850) | 0.76 | 0.29 | 1.05 |

Table 2.3: The sum of reported SAR values for main antenna and WiFi5G

| | Position | Main antenna | WiFi | Sum |
|--|------------------------------|--------------|------|-------------|
| Highest reported SAR value for Head | Right hand, Tilt (WCDMA1700) | 1.08 | 0.22 | 1.30 |
| Highest reported SAR value for Body | Rear 10mm (GSM850) | 0.76 | 0.59 | 1.35 |

Table 2.4: The sum of reported SAR values for main antenna and BT

| | Position | Main antenna | BT | Sum |
|--|------------------------------|--------------|---------------------|-------------|
| Maximum reported SAR value for Head | Right hand, Tilt (WCDMA1700) | 1.08 | 0.37 ^[1] | 1.45 |
| Maximum reported SAR value for Body | Rear 10mm (GSM850) | 0.76 | 0.19 ^[1] | 0.95 |

[1] - Estimated SAR for Bluetooth (see the table 13.4)

According to the above tables, the highest sum of reported SAR values is **1.45 W/kg (1g)**. The detail for simultaneous transmission consideration is described in chapter 13.



3 Client Information

3.1 Applicant Information

| | |
|-----------------|---|
| Company Name: | Samsung Electronics. Co., Ltd. |
| Address/Post: | 19 Chapin Rd.,Building D Pine Brook, NJ 07058 |
| Contact Person: | Jenni Chun |
| Contact Email: | j1.chun@samsung.com |
| Telephone: | +1-201-937-4203 |
| Fax | NA |

3.2 Manufacturer Information

| | |
|-----------------|--|
| Company Name: | Samsung Electronics. Co., Ltd |
| Address/Post: | R5, A Tower 22 Floor A-1,(Maetan dong) 129,Samsung-ro,Yeongtong-gu, Suwon-Si, Gyeonggi-do 16677, Korea |
| Contact Person: | JP KIM |
| Contact Email: | jp426.kim@samsung.com |
| Telephone: | +82-10-4376-0326 |
| Fax | NA |

4 Equipment Under Test (EUT) and Ancillary Equipment (AE)

4.1 About EUT

| | |
|-------------------------------------|---|
| Description: | Mobile phone |
| Model name: | A115U.001 |
| Operating mode(s): | GSM 850/900/1800/1900, UMTS FDD 1/2/4/5, BT, Wi-Fi, LTE Band 1/2/3/4/5/7/8/12/13/17/20/25/26/28/38/39/40/41/66/71 |
| Tested Tx Frequency: | 824 – 849 MHz (GSM 850) |
| | 1850 – 1910 MHz (GSM 1900) |
| | 824–849 MHz (WCDMA 850 Band V) |
| | 1710 – 1755 MHz (WCDMA 1700 Band IV) |
| | 1850–1910 MHz (WCDMA1900 Band II) |
| | 824.7 - 848.31 MHz (CDMA BC0) |
| | 1851.25 - 1908.75 MHz (CDMA BC1) |
| | 817.9 - 823.1 MHz (CDMA BC10) |
| | 2502.5 – 2567.5 MHz(LTE Band 7) |
| | 699.7 – 715.3 MHz (LTE Band 12) |
| | 779.5 –784.5 MHz (LTE Band 13) |
| | 1850.7 – 1914.3MHz(LTE Band 25) |
| | 814.7 – 848.3MHz(LTE Band 26) |
| | 2498.5 – 2687.5 MHz (LTE Band 41) |
| | 1710.7 – 1779.3 MHz (LTE Band 66) |
| 665.5 – 695.5 MHz (LTE Band 71) | |
| 2412 – 2462 MHz (Wi-Fi 2.4G) | |
| 5.15 – 5.825 GHz(Wi-Fi 5G) | |
| GPRS/EGPRS Multislot Class: | 10 |
| GPRS capability Class: | B |
| Test device Production information: | Production unit |
| Device type: | Portable device |
| Antenna type: | Integrated antenna |
| Hotspot mode: | Support |

4.2 Internal Identification of EUT used during the test

| EUT ID* | IMEI | HW | SW Version |
|---------|-----------------|--------|------------|
| EUT1 | 354223110084167 | REV1.0 | A115U.001 |
| EUT2 | 354223110060647 | REV1.0 | A115U.001 |
| EUT3 | 354223110082245 | REV1.0 | A115U.001 |

*EUT ID: is used to identify the test sample in the lab internally.

Note: It is performed to test SAR with the EUT1~2 and conducted power with the EUT3.

4.3 Internal Identification of AE used during the test

| AE ID* | Description | Model | SN | Manufacturer |
|--------|-------------|------------|----|--------------------------------------|
| AE1 | Battery | HQ-70N | / | Ningde Amperex Technology Limited |
| AE2 | Headset | EHS61ASFWE | / | DONGGUAN YOUNGBO ELECTRONICS CO.,LTD |
| AE3 | Headset | EHS61ASFWE | / | CRESYN VIETNAM CO.,LTD. |

*AE ID: is used to identify the test sample in the lab internally.



5 TEST METHODOLOGY

5.1 Applicable Limit Regulations

ANSI C95.1–1992:IEEE Standard for Safety Levels with Respect to Human Exposure to Radio Frequency Electromagnetic Fields, 3 kHz to 300 GHz.

It specifies the maximum exposure limit of **1.6 W/kg** as averaged over any 1 gram of tissue for portable devices being used within 20 cm of the user in the uncontrolled environment.

5.2 Applicable Measurement Standards

IEEE 1528–2013: Recommended Practice for Determining the Peak Spatial-Average Specific Absorption Rate (SAR) in the Human Head from Wireless Communications Devices: Measurement Techniques.

KDB447498 D01: General RF Exposure Guidance v06: Mobile and Portable Devices RF Exposure Procedures and Equipment Authorization Policies.

KDB648474 D04 Handset SAR v01r03: SAR Evaluation Considerations for Wireless Handsets.

KDB941225 D01 SAR test for 3G devices v03r01: SAR Measurement Procedures for 3G Devices

KDB941225 D05 SAR for LTE Devices v02r05: SAR Evaluation Considerations for LTE Devices

KDB941225 D06 Hotspot Mode SAR v02r01: SAR Evaluation Procedures for Portable Devices with Wireless Router Capabilities

KDB248227 D01 802.11 Wi-Fi SAR v02r02: SAR GUIDANCE FOR IEEE 802.11 (Wi-Fi) TRANSMITTERS

KDB865664 D01 SAR measurement 100 MHz to 6 GHz v01r04: SAR Measurement Requirements for 100 MHz to 6 GHz.

KDB865664 D02 RF Exposure Reporting v01r02: RF Exposure Compliance Reporting and Documentation Considerations

6 Specific Absorption Rate (SAR)

6.1 Introduction

SAR is related to the rate at which energy is absorbed per unit mass in an object exposed to a radio field. The SAR distribution in a biological body is complicated and is usually carried out by experimental techniques or numerical modeling. The standard recommends limits for two tiers of groups, occupational/controlled and general population/uncontrolled, based on a person's awareness and ability to exercise control over his or her exposure. In general, occupational/controlled exposure limits are higher than the limits for general population/uncontrolled.

6.2 SAR Definition

The SAR definition is the time derivative (rate) of the incremental energy (dW) absorbed by (dissipated in) an incremental mass (dm) contained in a volume element (dv) of a given density (ρ). The equation description is as below:

$$SAR = \frac{d}{dt} \left(\frac{dW}{dm} \right) = \frac{d}{dt} \left(\frac{dW}{\rho dv} \right)$$

SAR is expressed in units of Watts per kilogram (W/kg)

SAR measurement can be either related to the temperature elevation in tissue by

$$SAR = c \left(\frac{\delta T}{\delta t} \right)$$

Where: C is the specific heat capacity, δT is the temperature rise and δt is the exposure duration, or related to the electrical field in the tissue by

$$SAR = \frac{\sigma |E|^2}{\rho}$$

Where: σ is the conductivity of the tissue, ρ is the mass density of tissue and E is the RMS electrical field strength.

However for evaluating SAR of low power transmitter, electrical field measurement is typically applied.

7 Tissue Simulating Liquids

7.1 Targets for tissue simulating liquid

Table 7.1: Targets for tissue simulating liquid

| Frequency(MHz) | Liquid Type | Conductivity(σ) | $\pm 5\%$ Range | Permittivity(ϵ) | $\pm 5\%$ Range |
|----------------|-------------|--------------------------|-----------------|----------------------------|-----------------|
| 750 | Head | 0.89 | 0.85~0.93 | 41.94 | 39.8~44.0 |
| 835 | Head | 0.90 | 0.86~0.95 | 41.5 | 39.4~43.6 |
| 1750 | Head | 1.37 | 1.30~1.44 | 40.08 | 38.1~42.1 |
| 1900 | Head | 1.40 | 1.33~1.47 | 40.0 | 38.0~42.0 |
| 2300 | Head | 1.67 | 1.59~1.75 | 39.47 | 37.5~41.4 |
| 2450 | Head | 1.80 | 1.71~1.89 | 39.2 | 37.2~41.2 |
| 2600 | Head | 1.96 | 1.86~2.06 | 39.01 | 37.1~41.0 |
| 5250 | Head | 4.71 | 4.47~4.95 | 35.93 | 34.13~37.73 |
| 5600 | Head | 5.07 | 4.82~5.32 | 35.53 | 33.8~37.3 |
| 5750 | Head | 5.22 | 4.96~5.48 | 35.36 | 33.59~37.13 |

7.2 Dielectric Performance

Table 7.2: Dielectric Performance of Tissue Simulating Liquid

| Measurement Date (yyyy-mm-dd) | Type | Frequency | Permittivity ϵ | Drift (%) | Conductivity σ (S/m) | Drift (%) |
|-------------------------------|------|-----------|-------------------------|-----------|-----------------------------|-----------|
| 2020/3/19 | Head | 750 MHz | 42.07 | 0.31 | 0.897 | 0.79 |
| 2020/3/20 | Head | 835 MHz | 41.45 | -0.12 | 0.884 | -1.78 |
| 2020/3/21 | Head | 1750 MHz | 39.44 | -1.60 | 1.374 | 0.29 |
| 2020/3/22 | Head | 1900 MHz | 39.33 | -1.68 | 1.382 | -1.29 |
| 2020/3/23 | Head | 2300 MHz | 39.52 | 0.05 | 1.682 | 0.72 |
| 2020/3/24 | Head | 2450 MHz | 38.58 | -1.58 | 1.8 | 0.00 |
| 2020/3/25 | Head | 2600 MHz | 38.46 | -1.41 | 1.956 | -0.20 |
| 2020/3/26 | Head | 5250 MHz | 35.58 | -0.97 | 4.667 | -0.91 |
| 2020/3/27 | Head | 5600 MHz | 36.18 | 1.83 | 5.097 | 0.53 |
| 2020/3/28 | Head | 5750 MHz | 35.35 | -0.03 | 5.324 | 1.99 |

Note: The liquid temperature is 22.0°C

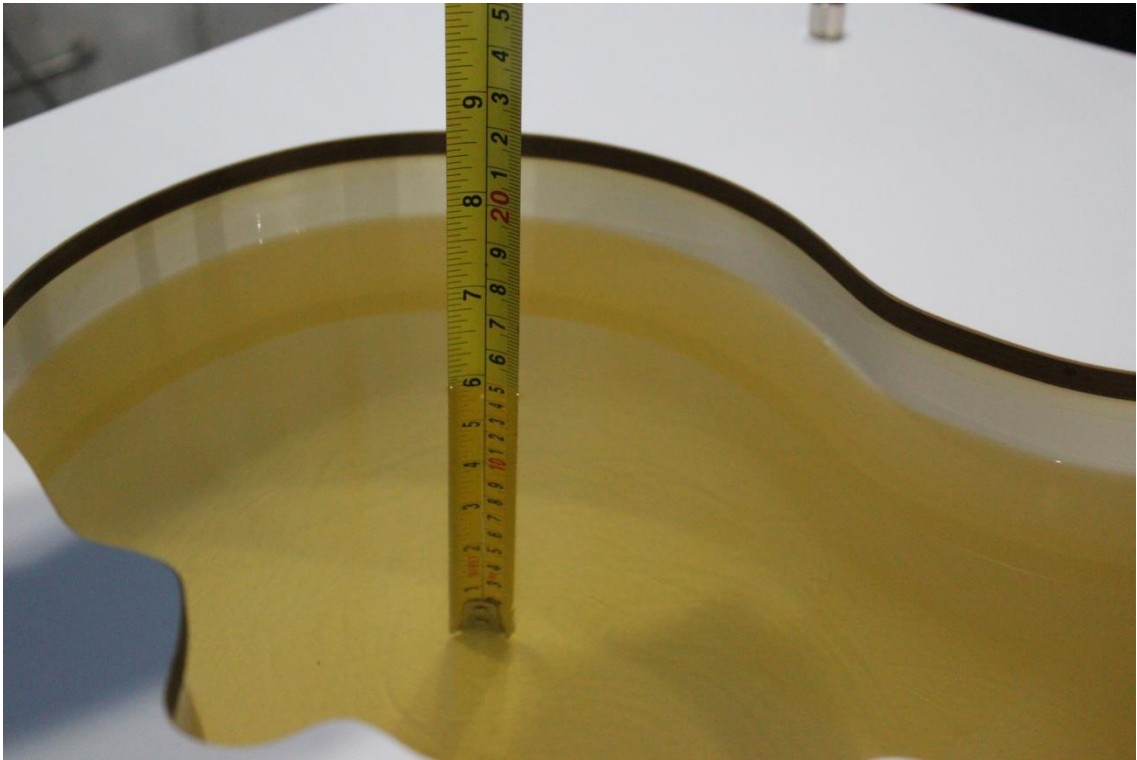

Picture 7-1 Liquid depth in the Head Phantom (750MHz)

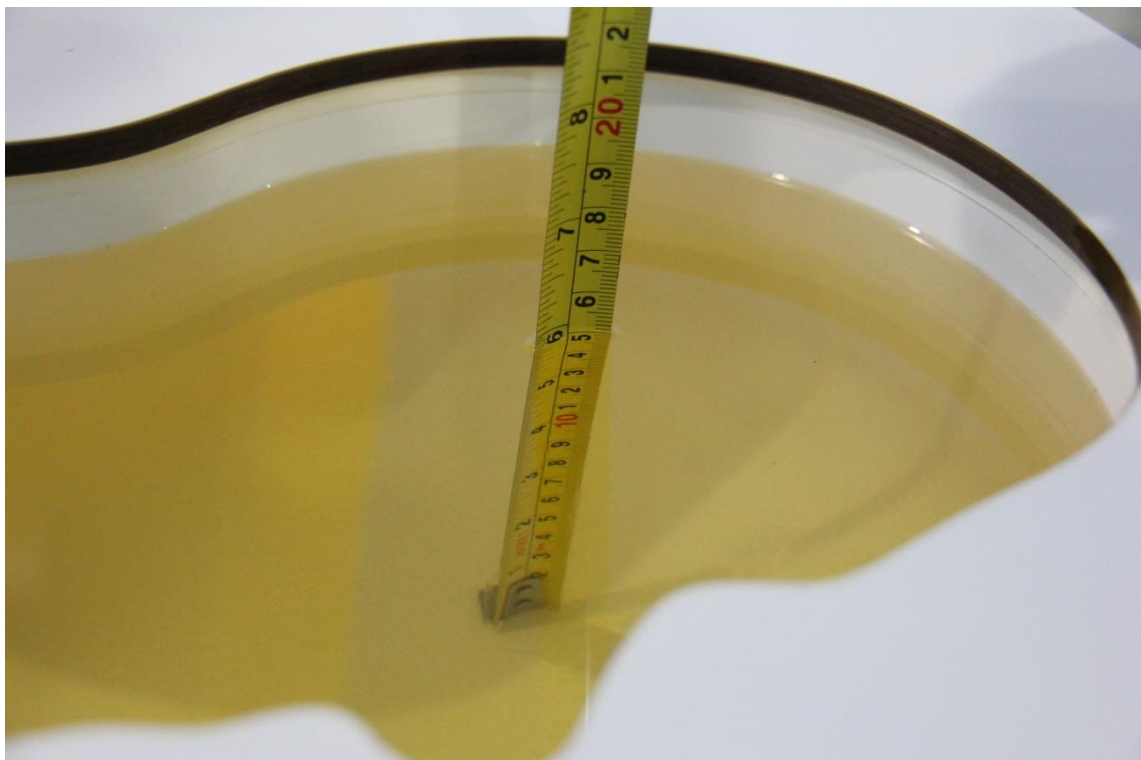

Picture 7-2 Liquid depth in the Head Phantom (835 MHz)

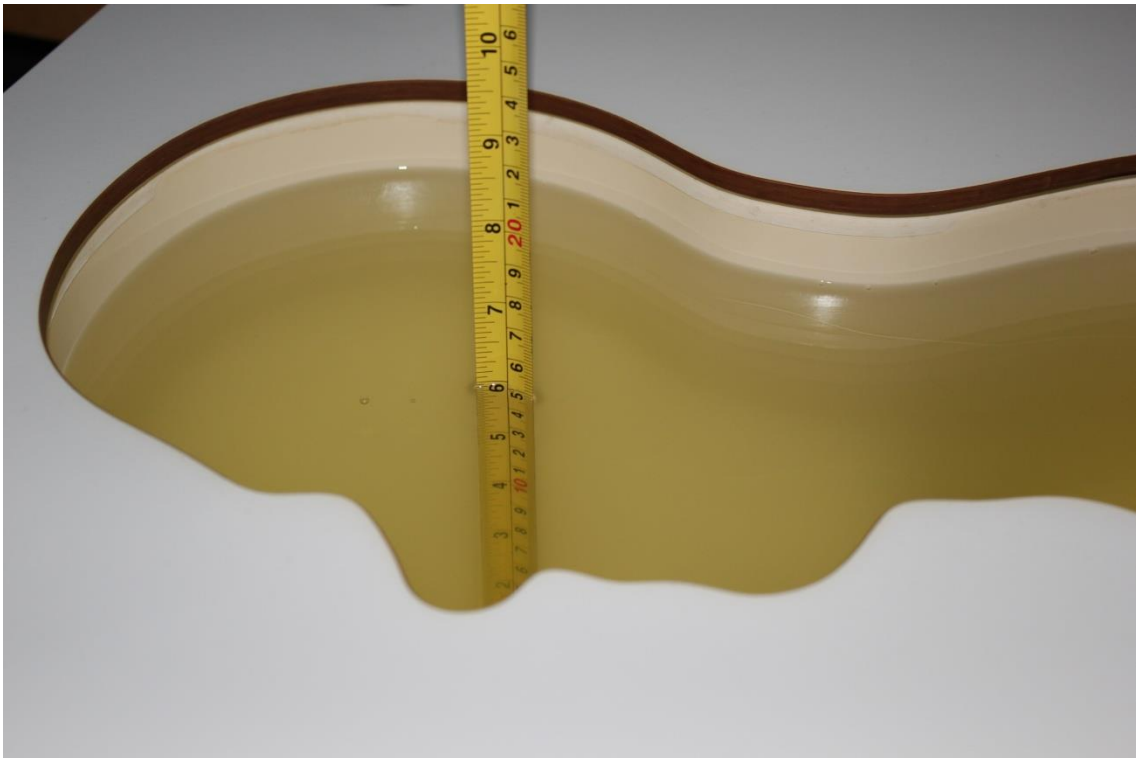

Picture 7-3 Liquid depth in the Head Phantom (1750 MHz)



Picture 7-4 Liquid depth in the Head Phantom (1900 MHz)

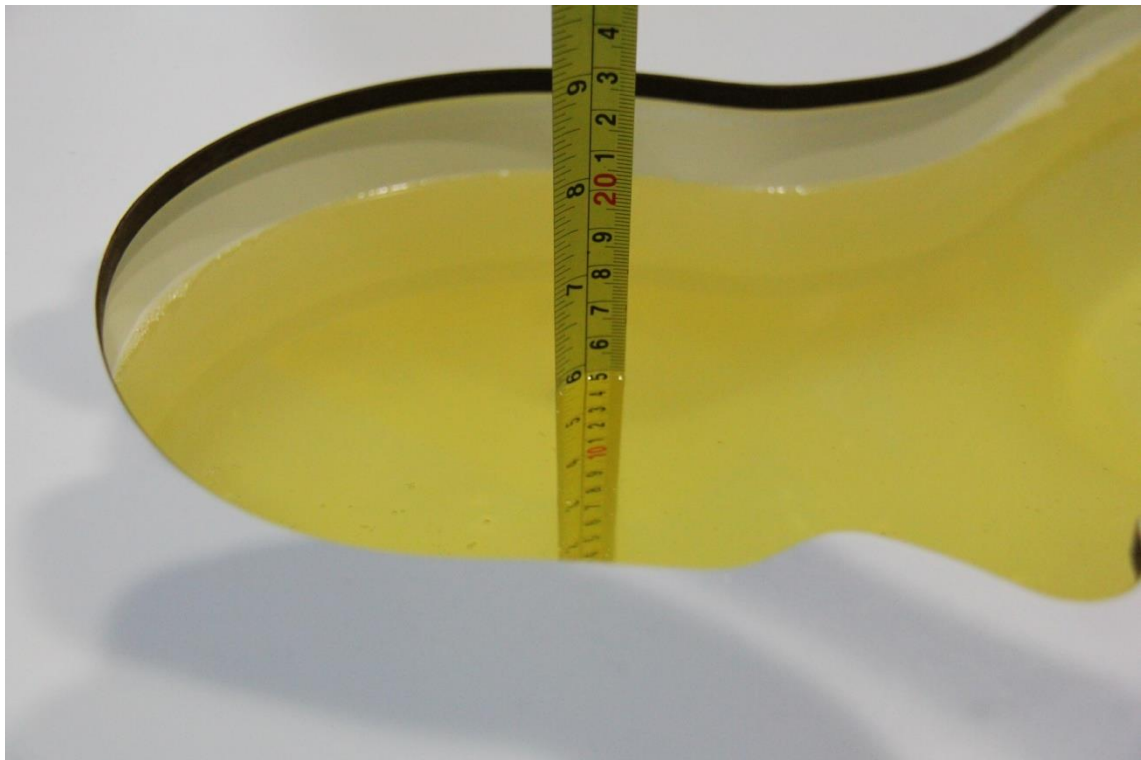

Picture 7-5 Liquid depth in the Head Phantom (2450MHz)

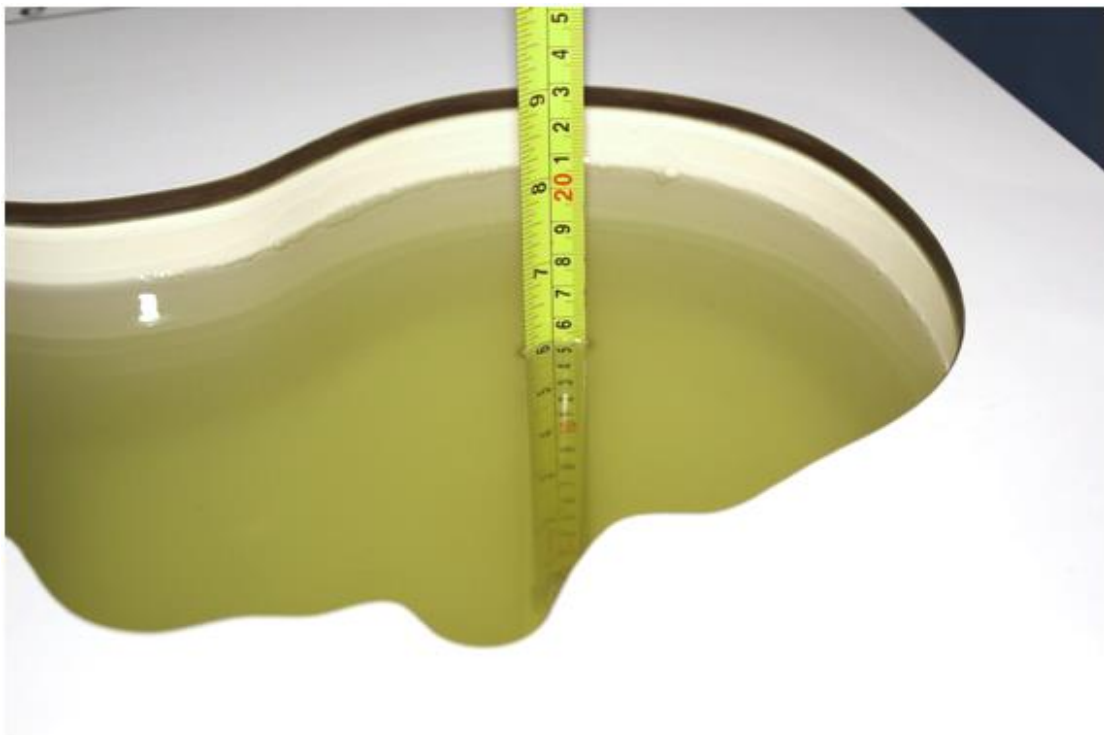

Picture 7-6 Liquid depth in the Head Phantom (2600 MHz)



Picture 7-7 Liquid depth in the Head Phantom (5GHz)



Picture 7-8 Liquid depth in the Head Phantom (2300 MHz)

8 System verification

8.1 System Setup

In the simplified setup for system evaluation, the DUT is replaced by a calibrated dipole and the power source is replaced by a continuous wave that comes from a signal generator. The calibrated dipole must be placed beneath the flat phantom section of the SAM twin phantom with the correct distance holder. The distance holder should touch the phantom surface with a light pressure at the reference marking and be oriented parallel to the long side of the phantom. The equipment setup is shown below:

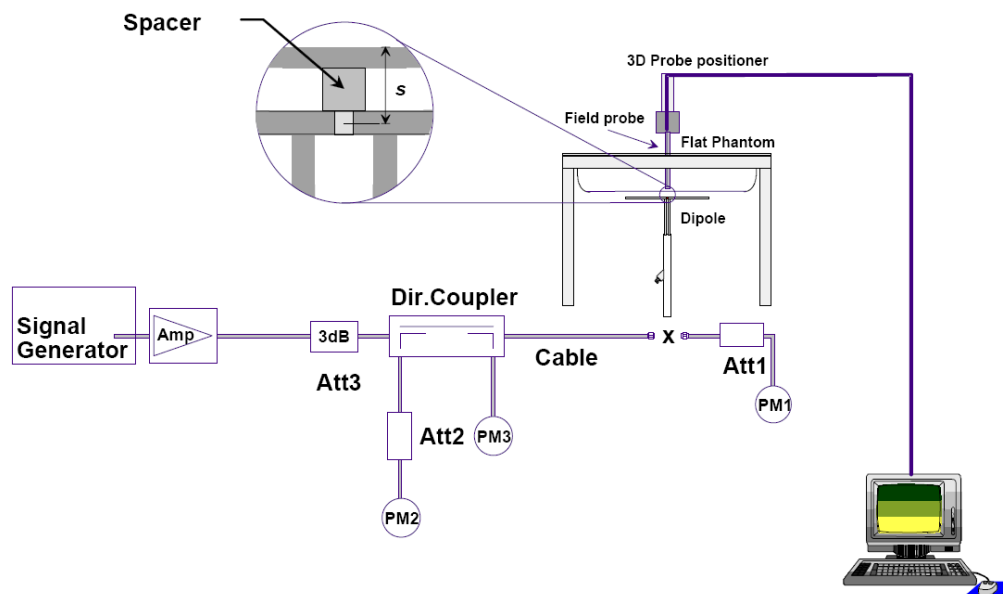

Picture 8.1 System Setup for System Evaluation



Picture 8.2 Photo of Dipole Setup

8.2 System Verification

SAR system verification is required to confirm measurement accuracy, according to the tissue dielectric media, probe calibration points and other system operating parameters required for measuring the SAR of a test device. The system verification must be performed for each frequency band and within the valid range of each probe calibration point required for testing the device.

The system verification results are required that the area scan estimated 1-g SAR is within 3% of the zoom scan 1-g SAR. The details are presented in annex B.

Table 8.1: System Verification of Head

| Measurement Date (yyyy-mm-dd) | Frequency | Target value (W/kg) | | Measured value(W/kg) | | Deviation | |
|----------------------------------|-----------|---------------------|----------------|----------------------|----------------|-----------------|----------------|
| | | 10 g Average | 1 g Average | 10 g Average | 1 g Average | 10 g Average | 1 g Average |
| 2020/3/19 | 750 MHz | 5.57 | 8.57 | 5.64 | 8.52 | 1.26% | -0.58% |
| 2020/3/20 | 835 MHz | 6.29 | 9.70 | 6.24 | 9.76 | -0.79% | 0.62% |
| 2020/3/21 | 1750 MHz | 19.3 | 36.6 | 19.24 | 36.12 | -0.31% | -1.31% |
| 2020/3/22 | 1900 MHz | 20.8 | 39.7 | 21.16 | 39.8 | 1.73% | 0.25% |
| 2020/3/23 | 2300 MHz | 24.1 | 49.7 | 23.88 | 49 | -0.91% | -1.41% |
| 2020/3/24 | 2450 MHz | 24.2 | 51.6 | 24.36 | 50.56 | 0.66% | -2.02% |
| 2020/3/25 | 2600 MHz | 25.1 | 55.8 | 25.52 | 56 | 1.67% | 0.36% |
| 2020/3/26 | 5250 MHz | 23.2 | 80.4 | 23.3 | 79.4 | 0.34% | -1.19% |
| 2020/3/27 | 5600 MHz | 24.1 | 84.5 | 24.1 | 84.7 | 0.08% | 0.21% |
| 2020/3/28 | 5750 MHz | 23.0 | 80.4 | 23.4 | 80.4 | 1.57% | -0.05% |

9 Measurement Procedures

9.1 Tests to be performed

In order to determine the highest value of the peak spatial-average SAR of a handset, all device positions, configurations and operational modes shall be tested for each frequency band according to steps 1 to 3 below. A flowchart of the test process is shown in picture 9.1.

Step 1: The tests described in 9.2 shall be performed at the channel that is closest to the centre of the transmit frequency band (f_c) for:

- a) all device positions (cheek and tilt, for both left and right sides of the SAM phantom, as described in annex D),
- b) all configurations for each device position in a), e.g., antenna extended and retracted, and
- c) all operational modes, e.g., analogue and digital, for each device position in a) and configuration in b) in each frequency band.

If more than three frequencies need to be tested according to 11.1 (i.e., $N_c > 3$), then all frequencies, configurations and modes shall be tested for all of the above test conditions.

Step 2: For the condition providing highest peak spatial-average SAR determined in Step 1, perform all tests described in 9.2 at all other test frequencies, i.e., lowest and highest frequencies. In addition, for all other conditions (device position, configuration and operational mode) where the peak spatial-average SAR value determined in Step 1 is within 3 dB of the applicable SAR limit, it is recommended that all other test frequencies shall be tested as well.

Step 3: Examine all data to determine the highest value of the peak spatial-average SAR found in Steps 1 to 2.

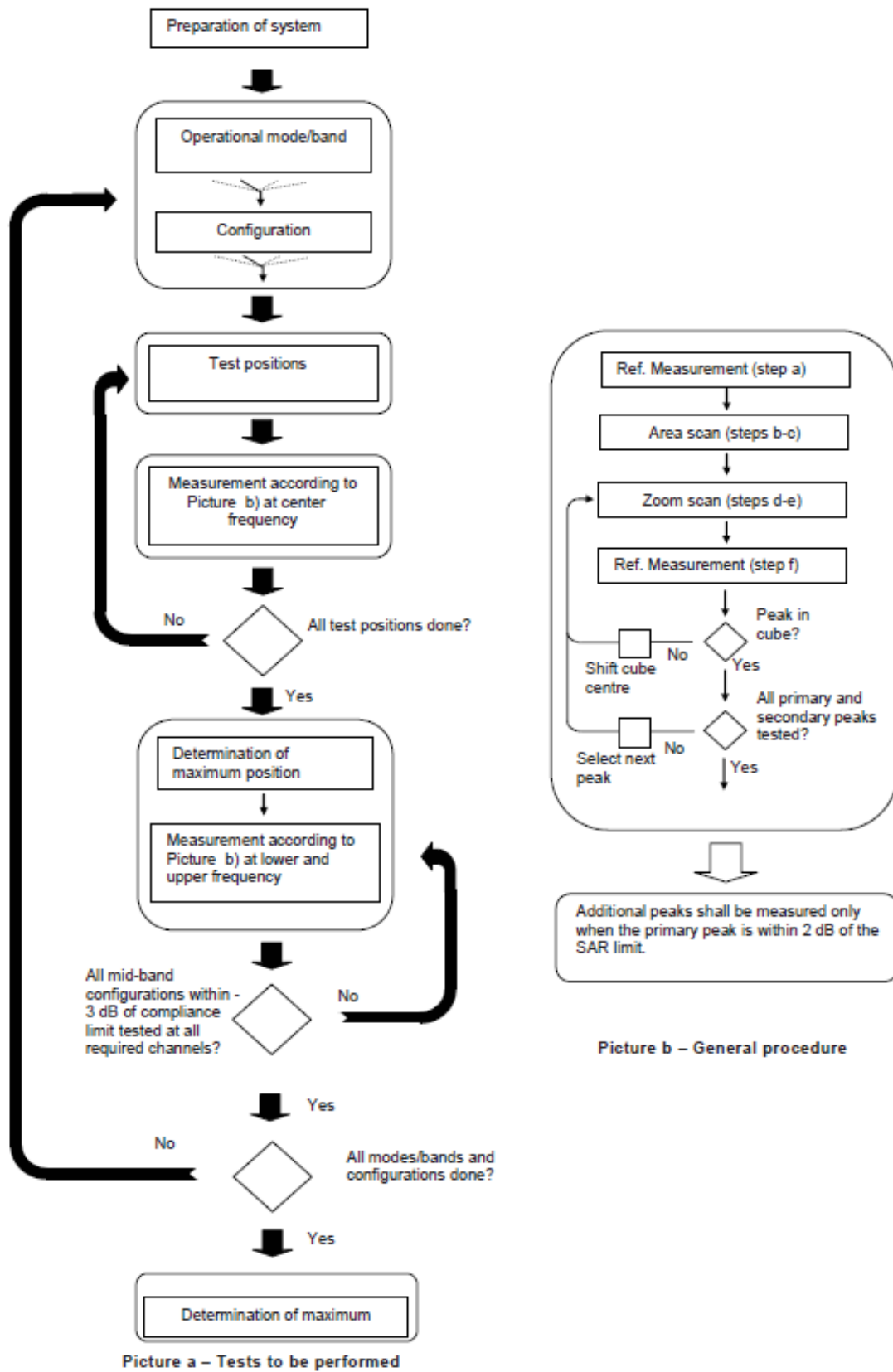

Picture 9.1 Block diagram of the tests to be performed

9.2 General Measurement Procedure

The area and zoom scan resolutions specified in the table below must be applied to the SAR measurements and fully documented in SAR reports to qualify for TCB approval. Probe boundary effect error compensation is required for measurements with the probe tip closer than half a probe tip diameter to the phantom surface. Both the probe tip diameter and sensor offset distance must satisfy measurement protocols; to ensure probe boundary effect errors are minimized and the higher fields closest to the phantom surface can be correctly measured and extrapolated to the phantom surface for computing 1-g SAR. Tolerances of the post-processing algorithms must be verified by the test laboratory for the scan resolutions used in the SAR measurements, according to the reference distribution functions specified in IEEE Std 1528-2003. The results should be documented as part of the system validation records and may be requested to support test results when all the measurement parameters in the following table are not satisfied.

| | | ≤ 3 GHz | > 3 GHz |
|---|------------------------------------|--|---|
| Maximum distance from closest measurement point (geometric center of probe sensors) to phantom surface | | 5 ± 1 mm | $\frac{1}{2} \cdot \delta \cdot \ln(2) \pm 0.5$ mm |
| Maximum probe angle from probe axis to phantom surface normal at the measurement location | | $30^\circ \pm 1^\circ$ | $20^\circ \pm 1^\circ$ |
| Maximum area scan spatial resolution: Δx_{Area} , Δy_{Area} | | ≤ 2 GHz: ≤ 15 mm 2 – 3 GHz: ≤ 12 mm | 3 – 4 GHz: ≤ 12 mm 4 – 6 GHz: ≤ 10 mm |
| | | When the x or y dimension of the test device, in the measurement plane orientation, is smaller than the above, the measurement resolution must be \leq the corresponding x or y dimension of the test device with at least one measurement point on the test device. | |
| Maximum zoom scan spatial resolution: Δx_{Zoom} , Δy_{Zoom} | | ≤ 2 GHz: ≤ 8 mm 2 – 3 GHz: ≤ 5 mm* | 3 – 4 GHz: ≤ 5 mm* 4 – 6 GHz: ≤ 4 mm* |
| Maximum zoom scan spatial resolution, normal to phantom surface | uniform grid: $\Delta z_{Zoom}(n)$ | ≤ 5 mm | 3 – 4 GHz: ≤ 4 mm 4 – 5 GHz: ≤ 3 mm 5 – 6 GHz: ≤ 2 mm |
| | graded grid | $\Delta z_{Zoom}(1)$: between 1 st two points closest to phantom surface | ≤ 4 mm |
| | | $\Delta z_{Zoom}(n>1)$: between subsequent points | $\leq 1.5 \cdot \Delta z_{Zoom}(n-1)$ |
| Minimum zoom scan volume | x, y, z | ≥ 30 mm | 3 – 4 GHz: ≥ 28 mm 4 – 5 GHz: ≥ 25 mm 5 – 6 GHz: ≥ 22 mm |
| Note: δ is the penetration depth of a plane-wave at normal incidence to the tissue medium; see draft standard IEEE P1528-2011 for details. * When zoom scan is required and the <i>reported</i> SAR from the area scan based 1-g SAR estimation procedures of KDB 447498 is ≤ 1.4 W/kg, ≤ 8 mm, ≤ 7 mm and ≤ 5 mm zoom scan resolution may be applied, respectively, for 2 GHz to 3 GHz, 3 GHz to 4 GHz and 4 GHz to 6 GHz. | | | |

9.3 WCDMA Measurement Procedures for SAR

The following procedures are applicable to WCDMA handsets operating under 3GPP Release99, Release 5 and Release 6. The default test configuration is to measure SAR with an established radio link between the DUT and a communication test set using a 12.2kbps RMC (reference measurement channel) configured in Test Loop Mode 1. SAR is selectively confirmed for other physical channel configurations (DPCCH & DPDCH_n), HSDPA and HSPA (HSUPA/HSDPA) modes according to output power, exposure conditions and device operating capabilities. Both uplink and downlink should be configured with the same RMC or AMR, when required. SAR for Release 5 HSDPA and Release 6 HSPA are measured using the applicable FRC (fixed reference channel) and E-DCH reference channel configurations. Maximum output power is verified according to applicable versions of 3GPP TS 34.121 and SAR must be measured according to these maximum output conditions. When Maximum Power Reduction (MPR) is not implemented according to Cubic Metric (CM) requirements for Release 6 HSPA, the following procedures do not apply.

For Release 5 HSDPA Data Devices:

| Sub-test | β_c | β_d | β_d (SF) | β_c / β_d | β_{hs} | CM/dB |
|----------|-----------|-----------|----------------|---------------------|--------------|-------|
| 1 | 2/15 | 15/15 | 64 | 2/15 | 4/15 | 0.0 |
| 2 | 12/15 | 15/15 | 64 | 12/15 | 24/25 | 1.0 |
| 3 | 15/15 | 8/15 | 64 | 15/8 | 30/15 | 1.5 |
| 4 | 15/15 | 4/15 | 64 | 15/4 | 30/15 | 1.5 |

For Release 6 HSPA Data Devices

| Sub-test | β_c | β_d | β_d (SF) | β_c / β_d | β_{hs} | β_{ec} | β_{ed} | β_{ed} (SF) | β_{ed} (codes) | CM (dB) | MPR (dB) | AG Index | E-TFCI |
|----------|-----------|-----------|----------------|---------------------|--------------|--------------|--|-------------------|----------------------|---------|----------|----------|--------|
| 1 | 11/15 | 15/15 | 64 | 11/15 | 22/15 | 209/225 | 1039/225 | 4 | 1 | 1.5 | 1.5 | 20 | 75 |
| 2 | 6/15 | 15/15 | 64 | 6/15 | 12/15 | 12/15 | 12/15 | 4 | 1 | 1.5 | 1.5 | 12 | 67 |
| 3 | 15/15 | 9/15 | 64 | 15/9 | 30/15 | 30/15 | $\beta_{ed1}:47/15$ $\beta_{ed2}:47/15$ | 4 | 2 | 1.5 | 1.5 | 15 | 92 |
| 4 | 2/15 | 15/15 | 64 | 2/15 | 4/15 | 4/15 | 56/75 | 4 | 1 | 1.5 | 1.5 | 17 | 71 |
| 5 | 15/15 | 15/15 | 64 | 15/15 | 24/15 | 30/15 | 134/15 | 4 | 1 | 1.5 | 1.5 | 21 | 81 |

Rel.8 DC-HSDPA (Cat 24)

SAR test exclusion for Rel.8 DC-HSDPA must satisfy the SAR test exclusion requirements of Rel.5 HSDPA. SAR test exclusion for DC-HSDPA devices is determined by power measurements according to the H-Set 12, Fixed Reference Channel (FRC) configuration in Table C.8.1.12 of 3GPP TS 34.121-1. A primary and a secondary serving HS-DSCH Cell are required to perform the power measurement and for the results to qualify for SAR test exclusion.

9.4 SAR Measurement for LTE

SAR tests for LTE are performed with a base station simulator, Rohde & Schwarz CMW500. Closed loop power control was used so the UE transmits with maximum output power during SAR testing. All powers were measured with the CMW 500.

It is performed for conducted power and SAR based on the KDB941225 D05.

SAR is evaluated separately according to the following procedures for the different test positions in each exposure condition – head, body, body-worn accessories and other use conditions. The procedures in the following subsections are applied separately to test each LTE frequency band.

1) QPSK with 1 RB allocation

Start with the largest channel bandwidth and measure SAR for QPSK with 1 RB allocation, using the RB offset and required test channel combination with the highest maximum output power among RB offsets at the upper edge, middle and lower edge of each required test channel. When the reported SAR is ≤ 0.8 W/kg, testing of the remaining RB offset configurations and required test channels is not required for 1 RB allocation; otherwise, SAR is required for the remaining required test channels and only for the RB offset configuration with the highest output power for that channel. When the reported SAR of a required test channel is > 1.45 W/kg, SAR is required for all three RB offset configurations for that required test channel.

2) QPSK with 50% RB allocation

The procedures required for 1 RB allocation in 1) are applied to measure the SAR for QPSK with 50% RB allocation.

3) QPSK with 100% RB allocation

For QPSK with 100% RB allocation, SAR is not required when the highest maximum output power for 100 % RB allocation is less than the highest maximum output power in 50% and 1 RB allocations and the highest reported SAR for 1 RB and 50% RB allocation in 1) and 2) are ≤ 0.8 W/kg. Otherwise, SAR is measured for the highest output power channel; and if the reported SAR is > 1.45 W/kg, the remaining required test channels must also be tested.

TDD test:

TDD testing is performed using guidance from FCC KDB 941225 D05 v02r05 and the SAR test guidance provided in April 2013 TCB works hop notes. TDD is tested at the highest duty factor using UL-DL configuration 0 with special subframe configuration 6 and applying the FDD LTE procedures in KDB 941225 D05 v02r05. SAR testing is performed using the extended cyclic prefix listed in 3GPP TS 36.211.

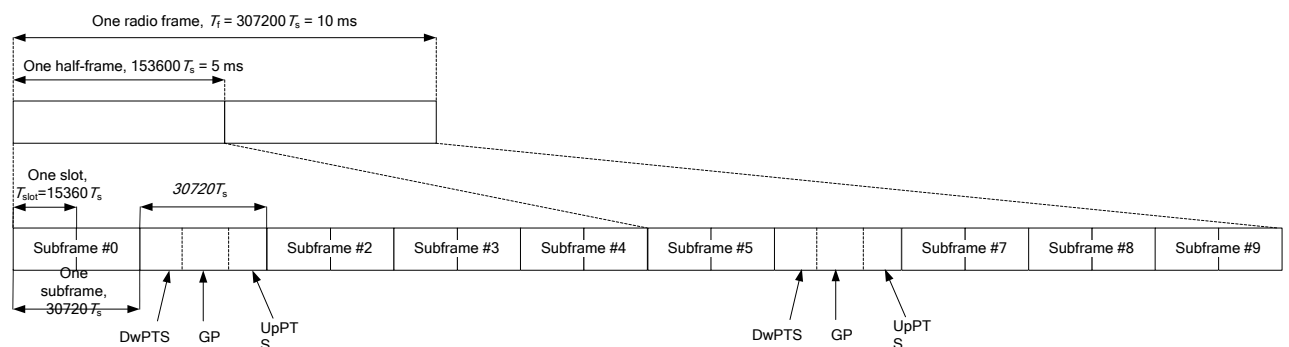

Figure 9.2: Frame structure type 2 (for 5 ms switch-point periodicity)

Table 9.1: Configuration of special subframe (lengths of DwPTS/GP/UpPTS)

| Special subframe configuration | Normal cyclic prefix in downlink | | | Extended cyclic prefix in downlink | | |
|--------------------------------|----------------------------------|--------------------------------|----------------------------------|------------------------------------|--------------------------------|----------------------------------|
| | DwPTS | UpPTS | | DwPTS | UpPTS | |
| | | Normal cyclic prefix in uplink | Extended cyclic prefix in uplink | | Normal cyclic prefix in uplink | Extended cyclic prefix in uplink |
| 0 | $6592 \cdot T_s$ | $2192 \cdot T_s$ | $2560 \cdot T_s$ | $7680 \cdot T_s$ | $2192 \cdot T_s$ | $2560 \cdot T_s$ |
| 1 | $19760 \cdot T_s$ | | | $20480 \cdot T_s$ | | |
| 2 | $21952 \cdot T_s$ | | | $23040 \cdot T_s$ | | |
| 3 | $24144 \cdot T_s$ | | | $25600 \cdot T_s$ | | |
| 4 | $26336 \cdot T_s$ | $4384 \cdot T_s$ | $5120 \cdot T_s$ | $7680 \cdot T_s$ | $4384 \cdot T_s$ | $5120 \cdot T_s$ |
| 5 | $6592 \cdot T_s$ | | | $20480 \cdot T_s$ | | |
| 6 | $19760 \cdot T_s$ | | | $23040 \cdot T_s$ | | |
| 7 | $21952 \cdot T_s$ | | | $12800 \cdot T_s$ | | |
| 8 | $24144 \cdot T_s$ | | | - | | |
| 9 | $13168 \cdot T_s$ | - | - | - | - | - |

Table 9.2: Uplink-downlink configurations

| Uplink-downlink configuration | Downlink-to-Uplink Switch-point periodicity | Subframe number | | | | | | | | | |
|-------------------------------|---|-----------------|---|---|---|---|---|---|---|---|---|
| | | 0 | 1 | 2 | 3 | 4 | 5 | 6 | 7 | 8 | 9 |
| 0 | 5 ms | D | S | U | U | U | D | S | U | U | U |
| 1 | 5 ms | D | S | U | U | D | D | S | U | U | D |
| 2 | 5 ms | D | S | U | D | D | D | S | U | D | D |
| 3 | 10 ms | D | S | U | U | U | D | D | D | D | D |
| 4 | 10 ms | D | S | U | U | D | D | D | D | D | D |
| 5 | 10 ms | D | S | U | D | D | D | D | D | D | D |
| 6 | 5 ms | D | S | U | U | U | D | S | U | U | D |

Duty factor is calculated by:

$$\begin{aligned}
 \text{Duty factor} &= \text{uplink frame} \cdot 6 + \text{UpPTS} \cdot 2 / \text{one frame length} \\
 &= (30720 \cdot T_s \cdot 6 + 5120 \cdot T_s \cdot 2) / 307200 \cdot T_s \\
 &= 0.633
 \end{aligned}$$

According to the KDB 447498 D01, SAR should be evaluated at more than 3 frequencies for devices supporting transmit bands wider than 100MHz. Oct.2014 FCC-TCB conference notes (Dec. 2014 rev.) specifies the 5 test channels to use for 3GPP band 41 SAR evaluation.

9.5 Bluetooth & Wi-Fi Measurement Procedures for SAR

Normal network operating configurations are not suitable for measuring the SAR of 802.11 transmitters in general. Unpredictable fluctuations in network traffic and antenna diversity conditions can introduce undesirable variations in SAR results. The SAR for these devices should be measured using chipset based test mode software to ensure that the results are consistent and reliable.

Chipset based test mode software is hardware dependent and generally varies among manufacturers. The device operating parameters established in a test mode for SAR measurements must be identical to those programmed in production units, including output power levels, amplifier gain settings and other RF performance tuning parameters. The test frequencies should correspond to actual channel frequencies defined for domestic use. SAR for devices with switched diversity should be measured with only one antenna transmitting at a time during each SAR measurement, according to a fixed modulation and data rate. The same data pattern should be used for all measurements.

9.6 Power Drift

To control the output power stability during the SAR test, DASY4 system calculates the power drift by measuring the E-field at the same location at the beginning and at the end of the measurement for each test position. These drift values can be found in section 14 labeled as: (Power Drift [dB]). This ensures that the power drift during one measurement is within 5%.

10 Area Scan Based 1-g SAR

10.1 Requirement of KDB

According to the KDB447498 D01 v05, when the implementation is based the specific polynomial fit

algorithm as presented at the 29th Bioelectromagnetics Society meeting (2007) and the estimated 1-gSAR is ≤ 1.2 W/kg, a zoom scan measurement is not required provided it is also not needed for any other purpose; for example, if the peak SAR location required for simultaneous transmission SAR test exclusion can be determined accurately by the SAR system or manually to discriminate between distinctive peaks and scattered noisy SAR distributions from area scans.

There must not be any warning or alert messages due to various measurement concerns identified by the SAR system; for example, noise in measurements, peaks too close to scan boundary, peaks are too sharp, spatial resolution and uncertainty issues etc. The SAR system verification must also demonstrate that the area scan estimated 1-g SAR is within 3% of the zoom scan 1-g SAR (See Annex B). When all the SAR results for each exposure condition in a frequency band and wireless mode are based on estimated 1-g SAR, the 1-g SAR for the highest SAR configuration must be determined by a zoom scan.

10.2 Fast SAR Algorithms

The approach is based on the area scan measurement applying a frequency dependent attenuation parameter. This attenuation parameter was empirically determined by analyzing a large number of phones. The MOTOROLA FAST SAR was developed and validated by the MOTOROLA Research Group in Ft. Lauderdale.

In the initial study, an approximation algorithm based on Linear fit was developed. The accuracy of the algorithm has been demonstrated across a broad frequency range (136-2450 MHz) and for both 1- and 10-g averaged SAR using a sample of 264 SAR measurements from 55 wireless handsets. For the sample size studied, the root-mean-squared errors of the algorithm are 1.2% and 5.8% for 1- and 10-g averaged SAR, respectively. The paper describing the algorithm in detail is expected to be published in August 2004 within the Special Issue of Transactions on MTT.

In the second step, the same research group optimized the fitting algorithm to an Polynomial fit whereby the frequency validity was extended to cover the range 30-6000MHz. Details of this study can be found in the BEMS 2007 Proceedings.

Both algorithms are implemented in DASY software.

11 Conducted Output Power

For Main antenna, there are two sets of tune-up power, Normal power and Low power, used for different use cases for PCS1900/WCDMA1700/WCDMA1900 and LTE Band7/25/41/66. Normal power status is applied for body worn test of above bands. Low power status is applied for sensor test of above bands. For other bands, Normal power status is applied for both head and body test.

For WiFi antenna, there are two sets of tune-up power, Normal power and Low power. Normal power status is applied for body worn test. Low power status is applied for head test.

11.1 GSM Measurement result

During the process of testing, the EUT was controlled via Agilent Digital Radio Communication tester (E5515C) to ensure the maximum power transmission and proper modulation. This result contains conducted output power for the EUT. In all cases, the measured peak output power should be greater and within 5% than EMI measurement.

Normal Power

Table 11.1-1: The conducted power measurement results for GSM, GPRS and EGPRS

| GSM 850 Speech (GMSK) | Measured Power (dBm) | | | Tune up | calculation | Averaged Power (dBm) | | |
|--------------------------|----------------------|-------|-------|---------|-------------|----------------------|-------|-------|
| | 251 | 190 | 128 | | | 251 | 190 | 128 |
| 1 Txslot | 32.55 | 32.67 | 32.70 | 34.20 | / | / | / | / |
| GSM 850 GPRS (GMSK) | Measured Power (dBm) | | | | calculation | Averaged Power (dBm) | | |
| | 251 | 190 | 128 | | | 251 | 190 | 128 |
| 1 Txslot | 32.34 | 32.37 | 32.34 | 34.00 | -9.03 | 23.31 | 23.34 | 23.31 |
| 2 Txslots | 31.16 | 31.11 | 30.90 | 32.50 | -6.02 | 25.14 | 25.09 | 24.88 |
| 3 Txslots | 29.53 | 29.47 | 29.32 | 30.50 | -4.26 | 25.27 | 25.21 | 25.06 |
| 4 Txslots | 27.57 | 27.77 | 27.57 | 28.50 | -3.01 | 24.56 | 24.76 | 24.56 |
| GSM 850 EGPRS (GMSK) | Measured Power (dBm) | | | | calculation | Averaged Power (dBm) | | |
| | 251 | 190 | 128 | | | 251 | 190 | 128 |
| 1 Txslot | 32.56 | 32.64 | 32.61 | 34.00 | -9.03 | 23.53 | 23.61 | 23.58 |
| 2 Txslots | 31.11 | 31.05 | 31.03 | 32.50 | -6.02 | 25.09 | 25.03 | 25.01 |
| 3 Txslots | 29.41 | 29.38 | 29.27 | 30.50 | -4.26 | 25.15 | 25.12 | 25.01 |
| 4 Txslots | 27.24 | 27.48 | 27.21 | 28.50 | -3.01 | 24.23 | 24.47 | 24.20 |
| GSM 850 EGPRS (8PSK) | Measured Power (dBm) | | | | calculation | Averaged Power (dBm) | | |
| | 251 | 190 | 128 | | | 251 | 190 | 128 |
| 1 Txslot | 25.90 | 25.93 | 26.02 | 27.50 | -9.03 | 16.87 | 16.90 | 16.99 |
| 2 Txslots | 24.38 | 24.20 | 24.29 | 25.50 | -6.02 | 18.36 | 18.18 | 18.27 |
| 3 Txslots | 21.92 | 21.95 | 22.02 | 23.50 | -4.26 | 17.66 | 17.69 | 17.76 |
| 4 Txslots | 21.73 | 21.68 | 21.78 | 23.00 | -3.01 | 18.72 | 18.67 | 18.77 |
| PCS1900 Speech (GMSK) | Measured Power (dBm) | | | Tune up | calculation | Averaged Power (dBm) | | |
| | 810 | 661 | 512 | | | 810 | 661 | 512 |
| 1 Txslot | 30.30 | 30.11 | 30.28 | 31.60 | / | / | / | / |
| PCS1900 | Measured Power (dBm) | | | | calculation | Averaged Power (dBm) | | |

| | | | | | | | | |
|--------------|----------------------|-------|-------|-------|-------------|----------------------|-------|-------|
| GPRS (GMSK) | 810 | 661 | 512 | | | 810 | 661 | 512 |
| 1 Txslot | 30.47 | 30.32 | 30.55 | 31.00 | -9.03 | 21.44 | 21.29 | 21.52 |
| 2 Txslots | 27.99 | 28.04 | 28.17 | 29.00 | -6.02 | 21.97 | 22.02 | 22.15 |
| 3 Txslots | 26.61 | 26.58 | 26.66 | 28.00 | -4.26 | 22.35 | 22.32 | 22.40 |
| 4 Txslots | 25.85 | 25.72 | 25.75 | 27.00 | -3.01 | 22.84 | 22.71 | 22.74 |
| PCS1900 | Measured Power (dBm) | | | | calculation | Averaged Power (dBm) | | |
| EGPRS (GMSK) | 810 | 661 | 512 | | | 810 | 661 | 512 |
| 1 Txslot | 30.27 | 30.01 | 30.22 | 31.00 | -9.03 | 21.24 | 20.98 | 21.19 |
| 2 Txslots | 28.01 | 28.07 | 27.79 | 29.00 | -6.02 | 21.99 | 22.05 | 21.77 |
| 3 Txslots | 26.62 | 26.38 | 26.49 | 28.00 | -4.26 | 22.36 | 22.12 | 22.23 |
| 4 Txslots | 25.68 | 25.79 | 25.82 | 27.00 | -3.01 | 22.67 | 22.78 | 22.81 |
| PCS1900 | Measured Power (dBm) | | | | calculation | Averaged Power (dBm) | | |
| EGPRS (8PSK) | 810 | 661 | 512 | | | 810 | 661 | 512 |
| 1 Txslot | 25.65 | 25.58 | 25.79 | 27.00 | -9.03 | 16.62 | 16.55 | 16.76 |
| 2 Txslots | 24.01 | 24.08 | 24.08 | 25.00 | -6.02 | 17.99 | 18.06 | 18.06 |
| 3 Txslots | 22.84 | 22.89 | 22.89 | 24.00 | -4.26 | 18.58 | 18.63 | 18.63 |
| 4 Txslots | 21.51 | 21.71 | 21.69 | 23.00 | -3.01 | 18.50 | 18.70 | 18.68 |

NOTES:

1) Division Factors

To average the power, the division factor is as follows:

1TX-slot = 1 transmit time slot out of 8 time slots=> conducted power divided by (8/1) => -9.03dB

2TX-slots = 2 transmit time slots out of 8 time slots=> conducted power divided by (8/2) => -6.02dB

3TX-slots = 3 transmit time slots out of 8 time slots=> conducted power divided by (8/3) => -4.26dB

4TX-slots = 4 transmit time slots out of 8 time slots=> conducted power divided by (8/4) => -3.01dB

According to the conducted power as above, the body measurements are performed with 3Txslots for GSM850 and 4Txslots for GSM1900.

Low Power

| | | | | | | | | |
|--------------------------|----------------------|-------|-------|------------|-------------|----------------------|-------|-------|
| PCS1900 Speech (GMSK) | Measured Power (dBm) | | | Tune up | calculation | Averaged Power (dBm) | | |
| | 810 | 661 | 512 | | | 810 | 661 | 512 |
| 1 Txslot | 22.79 | 22.68 | 22.63 | 24.00 | / | / | / | / |
| PCS1900 | Measured Power (dBm) | | | | calculation | Averaged Power (dBm) | | |
| GPRS (GMSK) | 810 | 661 | 512 | | | 810 | 661 | 512 |
| 1 Txslot | 22.89 | 22.82 | 22.90 | 24.00 | -9.03 | 13.86 | 13.79 | 13.87 |
| 2 Txslots | 21.28 | 21.26 | 21.29 | 22.00 | -6.02 | 15.26 | 15.24 | 15.27 |
| 3 Txslots | 19.22 | 19.14 | 19.14 | 20.00 | -4.26 | 14.96 | 14.88 | 14.88 |
| 4 Txslots | 18.57 | 18.59 | 18.63 | 19.00 | -3.01 | 15.56 | 15.58 | 15.62 |
| PCS1900 | Measured Power (dBm) | | | | calculation | Averaged Power (dBm) | | |
| EGPRS (GMSK) | 810 | 661 | 512 | | | 810 | 661 | 512 |
| 1 Txslot | 22.99 | 22.88 | 22.96 | 24.00 | -9.03 | 13.96 | 13.85 | 13.93 |
| 2 Txslots | 21.37 | 21.32 | 21.35 | 22.00 | -6.02 | 15.35 | 15.30 | 15.33 |

| | | | | | | | | |
|-------------------------|----------------------|-------|-------|-------|-------------|----------------------|-------|-------|
| 3 Txslots | 19.29 | 19.20 | 19.20 | 20.00 | -4.26 | 15.03 | 14.94 | 14.94 |
| 4 Txslots | 18.64 | 18.64 | 18.69 | 19.00 | -3.01 | 15.63 | 15.63 | 15.68 |
| PCS1900 EGPRS (8PSK) | Measured Power (dBm) | | | | calculation | Averaged Power (dBm) | | |
| | 810 | 661 | 512 | | | 810 | 661 | 512 |
| 1 Txslot | 23.28 | 23.29 | 23.31 | 24.00 | -9.03 | 14.25 | 14.26 | 14.28 |
| 2 Txslots | 19.66 | 19.67 | 19.74 | 21.00 | -6.02 | 13.64 | 13.65 | 13.72 |
| 3 Txslots | 19.49 | 19.46 | 19.58 | 21.00 | -4.26 | 15.23 | 15.20 | 15.32 |
| 4 Txslots | 18.71 | 18.73 | 18.77 | 20.00 | -3.01 | 15.70 | 15.72 | 15.76 |

NOTES:

1) Division Factors

To average the power, the division factor is as follows:

1TX-slot = 1 transmit time slot out of 8 time slots=> conducted power divided by (8/1) => -9.03dB

2TX-slots = 2 transmit time slots out of 8 time slots=> conducted power divided by (8/2) => -6.02dB

3TX-slots = 3 transmit time slots out of 8 time slots=> conducted power divided by (8/3) => -4.26dB

4TX-slots = 4 transmit time slots out of 8 time slots=> conducted power divided by (8/4) => -3.01dB

According to the conducted power as above, the body measurements are performed with 4Txslots for GSM1900.

11.2 WCDMA Measurement result

Normal power

Table 11.2-1: The conducted Power for WCDMA

| Item | band | FDDV result | | | |
|----------|-------|------------------|------------------|------------------|---------|
| | ARFCN | 4233 (846.6MHz) | 4182 (836.4MHz) | 4132 (826.4MHz) | Tune up |
| WCDMA | \ | 24.55 | 24.44 | 24.37 | 25.70 |
| HSUPA | 1 | 23.28 | 23.07 | 23.15 | 24.70 |
| | 2 | 21.25 | 21.17 | 21.21 | 22.70 |
| | 3 | 22.2 | 22.15 | 22.19 | 23.70 |
| | 4 | 21.28 | 21.19 | 21.22 | 22.70 |
| | 5 | 22.98 | 22.85 | 22.91 | 24.70 |
| DC-HSDPA | 1 | 23.06 | 23.33 | 23.10 | 24.70 |
| | 2 | 23.08 | 23.24 | 23.12 | 24.70 |
| | 3 | 22.62 | 22.71 | 22.65 | 24.20 |
| | 4 | 22.66 | 22.42 | 22.68 | 24.20 |
| Item | band | FDDIV result | | | |
| | ARFCN | 1513 (1752.6MHz) | 1412 (1732.4MHz) | 1312 (1712.4MHz) | |
| WCDMA | \ | 24.28 | 24.15 | 24.16 | 25.50 |
| HSUPA | 1 | 23.88 | 23.73 | 23.70 | 24.50 |
| | 2 | 21.95 | 21.67 | 21.77 | 22.50 |
| | 3 | 22.78 | 22.74 | 22.85 | 23.50 |
| | 4 | 21.87 | 21.65 | 21.78 | 22.50 |

| | | | | | |
|----------|-------|---------------------|----------------|---------------------|---------|
| | 5 | 23.96 | 23.74 | 23.75 | 24.50 |
| DC-HSDPA | 1 | 23.66 | 23.63 | 23.71 | 24.50 |
| | 2 | 23.67 | 23.62 | 23.69 | 24.50 |
| | 3 | 23.18 | 23.14 | 23.21 | 24.00 |
| | 4 | 23.16 | 23.13 | 23.20 | 24.00 |
| Item | band | FDDII result | | | |
| | ARFCN | 9538 (1907.6MHz) | 9400 (1880MHz) | 9262 (1852.4MHz) | Tune up |
| WCDMA | \ | 24.20 | 24.27 | 24.32 | 25.70 |
| HSUPA | 1 | 23.32 | 23.38 | 23.46 | 24.70 |
| | 2 | 21.35 | 21.33 | 21.48 | 22.70 |
| | 3 | 22.67 | 22.51 | 22.64 | 23.70 |
| | 4 | 21.32 | 21.31 | 21.51 | 22.70 |
| | 5 | 23.53 | 23.43 | 23.72 | 24.70 |
| DC-HSDPA | 1 | 23.35 | 23.38 | 23.47 | 24.70 |
| | 2 | 23.32 | 23.35 | 23.46 | 24.70 |
| | 3 | 22.84 | 22.77 | 22.92 | 24.20 |
| | 4 | 22.83 | 22.76 | 22.94 | 24.20 |

Low power

Table 11.2-2: The conducted Power for WCDMA

| | | | | | |
|----------|-------|---------------------|-----------------|---------------------|---------|
| Item | band | FDDIV result | | | |
| | ARFCN | 1513 (1752.6MHz) | 1412(1732.4MHz) | 1312 (1712.4MHz) | Tune up |
| WCDMA | \ | 18.65 | 18.48 | 18.59 | 20.00 |
| HSUPA | 1 | 17.11 | 16.84 | 17.00 | 19.00 |
| | 2 | 15.03 | 15.04 | 15.08 | 17.00 |
| | 3 | 16.02 | 16.09 | 16.07 | 18.00 |
| | 4 | 15.04 | 15.02 | 15.01 | 17.00 |
| | 5 | 17.08 | 17.05 | 17.03 | 19.00 |
| DC-HSDPA | 1 | 17.01 | 17.04 | 17.06 | 19.00 |
| | 2 | 17.02 | 17.01 | 17.02 | 19.00 |
| | 3 | 16.58 | 16.59 | 16.52 | 18.50 |
| | 4 | 16.51 | 16.53 | 16.54 | 18.50 |
| Item | band | FDDII result | | | |
| | ARFCN | 9538 (1907.6MHz) | 9400 (1880MHz) | 9262 (1852.4MHz) | Tune up |
| WCDMA | \ | 18.71 | 18.66 | 18.81 | 20.00 |
| HSUPA | 1 | 17.32 | 17.37 | 17.50 | 19.00 |
| | 2 | 15.28 | 15.32 | 15.43 | 17.00 |
| | 3 | 16.26 | 16.35 | 16.49 | 18.00 |
| | 4 | 15.34 | 15.37 | 15.37 | 17.00 |
| | 5 | 17.31 | 17.37 | 17.51 | 19.00 |
| DC-HSDPA | 1 | 17.55 | 17.26 | 17.41 | 19.00 |

| | | | | | |
|--|----------|-------|-------|-------|-------|
| | 2 | 17.53 | 17.35 | 17.56 | 19.00 |
| | 3 | 17.02 | 16.80 | 16.94 | 18.50 |
| | 4 | 16.98 | 16.90 | 17.05 | 18.50 |

11.3 CDMA Measurement result

Normal power

Table 11.3-1: The conducted Power for CDMA

| CDMA BC0 | Conducted Power (dBm) | | | Tune up |
|---------------------------------|-----------------------|-----------------|-----------------|---------|
| | 777 (848.31MHz) | 384 (836.52MHz) | 1013 (824.7MHz) | |
| SO55/RC3 | 25.02 | 24.86 | 24.80 | 26 |
| SO55/RC1 | 25.01 | 24.85 | 24.76 | 26 |
| SO32/RC3(FCH only) | 24.99 | 24.84 | 24.75 | 26 |
| SO32/RC3(FCH+SCH _n) | 24.98 | 24.83 | 24.73 | 26 |
| EVDO Rev.0 | 24.31 | 24.41 | 24.23 | 26 |
| EVDO Rev.A | 24.23 | 24.47 | 24.21 | 26 |
| CDMA BC1 | Conducted Power (dBm) | | | Tune up |
| | 1175 (1908.75MHz) | 600 (1880MHz) | 25 (1851.25MHz) | |
| SO55/RC3 | 23.59 | 23.54 | 23.61 | 25 |
| SO55/RC1 | 23.56 | 23.49 | 23.59 | 25 |
| SO32/RC3(FCH only) | 23.57 | 23.48 | 23.56 | 25 |
| SO32/RC3(FCH+SCH _n) | 23.58 | 23.48 | 23.59 | 25 |
| EVDO Rev.0 | 22.99 | 22.93 | 22.92 | 25 |
| EVDO Rev.A | 23.05 | 23.01 | 22.87 | 25 |
| CDMA BC10 | Conducted Power (dBm) | | | Tune up |
| | 684 (823.1MHz) | 580 (820.5MHz) | 476(817.9MHz) | |
| SO55/RC3 | 24.97 | 24.88 | 25.00 | 26 |
| SO55/RC1 | 24.96 | 24.86 | 25.01 | 26 |
| SO32/RC3(FCH only) | 24.94 | 24.85 | 24.98 | 26 |
| SO32/RC3(FCH+SCH _n) | 24.93 | 24.84 | 24.99 | 26 |
| EVDO Rev.0 | 24.51 | 24.61 | 24.52 | 26 |
| EVDO Rev.A | 24.45 | 24.53 | 24.48 | 26 |

Low power
Table 11.3-2: The conducted Power for CDMA

| CDMA BC1 | Conducted Power (dBm) | | | Tune up |
|---------------------------------|-----------------------|---------------|-----------------|---------|
| | 1175 (1908.75MHz) | 600 (1880MHz) | 25 (1851.25MHz) | |
| SO55/RC3 | 18.39 | 18.34 | 18.45 | 19.5 |
| SO55/RC1 | 18.48 | 18.42 | 18.50 | 19.5 |
| SO32/RC3(FCH only) | 18.39 | 18.33 | 18.43 | 19.5 |
| SO32/RC3(FCH+SCH _n) | 18.38 | 18.32 | 18.42 | 19.5 |
| EVDO Rev.0 | 18.26 | 18.23 | 18.17 | 19.5 |
| EVDO Rev.A | 18.25 | 18.24 | 18.15 | 19.5 |

11.4 LTE Measurement result
Table 11.4-1: Maximum Power Reduction (MPR) for LTE

| Modulation | Channel bandwidth / Transmission bandwidth configuration [RB] | | | | | | MPR (dB) |
|------------|---|-----|-----|------|------|------|----------|
| | 1.4 | 3 | 5 | 10 | 15 | 20 | |
| | MHz | MHz | MHz | MHz | MHz | MHz | |
| QPSK | > 5 | > 4 | > 8 | > 12 | > 16 | > 18 | 1 |
| 16 QAM | ≤ 5 | ≤ 4 | ≤ 8 | ≤ 12 | ≤ 16 | ≤ 18 | 1 |
| 16 QAM | > 5 | > 4 | > 8 | > 12 | > 16 | > 18 | 2 |
| 64 QAM | ≤ 5 | ≤ 4 | ≤ 8 | ≤ 12 | ≤ 16 | ≤ 18 | 2 |
| 64 QAM | > 5 | > 4 | > 8 | > 12 | > 16 | > 18 | 3 |

Table 11.4-2: The tune up for LTE – Normal Power

| Band | Tune up |
|------------------|---------|
| LTE Band 7 | 24 |
| LTE Band 12 | 25.7 |
| LTE Band 13 | 25 |
| LTE Band 25 | 25 |
| LTE Band 26 | 25.7 |
| LTE Band 41(PC2) | 28.4 |
| LTE Band 41(PC3) | 25 |
| LTE Band 66 | 25 |
| LTE Band 71 | 25.7 |

Table 11.4-3: The tune up for LTE – Low Power

| Band | Tune up |
|------------------|---------|
| LTE Band 7 | 19.5 |
| LTE Band 25 | 22 |
| LTE Band 41(PC2) | 24 |
| LTE Band 41(PC3) | 24 |
| LTE Band 66 | 19.5 |

Normal power

| Band7 | | | | | |
|-----------|------------------|----------------|-------|-------|-------|
| BANDWIDTH | Number of RBs | Frequency | QPSK | 16QAM | 64QAM |
| 5MHz | 1RB-High (24) | 2567.5 (21425) | 22.32 | 21.44 | 20.99 |
| | | 2535 (21100) | 22.27 | 21.53 | 21.13 |
| | | 2502.5 (20775) | 22.35 | 21.93 | 20.90 |
| | 1RB-Middle (12) | 2567.5 (21425) | 22.35 | 21.37 | 21.13 |
| | | 2535 (21100) | 22.28 | 21.43 | 21.18 |
| | | 2502.5 (20775) | 22.56 | 21.86 | 20.83 |
| | 1RB-Low (0) | 2567.5 (21425) | 22.45 | 21.52 | 21.16 |
| | | 2535 (21100) | 22.45 | 21.57 | 21.22 |
| | | 2502.5 (20775) | 22.37 | 21.93 | 21.05 |
| | 12RB-High (13) | 2567.5 (21425) | 21.43 | 20.43 | 19.97 |
| | | 2535 (21100) | 21.43 | 20.48 | 20.06 |
| | | 2502.5 (20775) | 21.38 | 20.56 | 19.79 |
| | 12RB-Middle (6) | 2567.5 (21425) | 21.44 | 20.49 | 19.99 |
| | | 2535 (21100) | 21.38 | 20.49 | 20.05 |
| | | 2502.5 (20775) | 21.41 | 20.61 | 19.87 |
| | 12RB-Low (0) | 2567.5 (21425) | 21.46 | 20.56 | 20.12 |
| | | 2535 (21100) | 21.38 | 20.54 | 20.03 |
| | | 2502.5 (20775) | 21.37 | 20.56 | 19.77 |
| | 25RB (0) | 2567.5 (21425) | 21.43 | 20.43 | 19.98 |
| | | 2535 (21100) | 21.37 | 20.46 | 20.06 |
| | | 2502.5 (20775) | 21.36 | 20.43 | 19.75 |
| 10MHz | 1RB-High (49) | 2565 (21400) | 22.42 | 21.88 | 21.23 |
| | | 2535 (21100) | 22.47 | 21.45 | 21.25 |
| | | 2505 (20800) | 22.42 | 21.32 | 21.07 |
| | 1RB-Middle (24) | 2565 (21400) | 22.36 | 21.75 | 21.07 |
| | | 2535 (21100) | 22.33 | 21.31 | 21.11 |
| | | 2505 (20800) | 22.43 | 21.27 | 20.91 |
| | 1RB-Low (0) | 2565 (21400) | 22.59 | 21.95 | 21.43 |
| | | 2535 (21100) | 22.60 | 21.70 | 21.36 |
| | | 2505 (20800) | 22.61 | 21.50 | 21.18 |
| | 25RB-High (25) | 2565 (21400) | 21.46 | 20.42 | 20.13 |
| | | 2535 (21100) | 21.37 | 20.47 | 20.11 |
| | | 2505 (20800) | 21.30 | 20.35 | 19.77 |
| | 25RB-Middle (12) | 2565 (21400) | 21.47 | 20.47 | 20.04 |
| | | 2535 (21100) | 21.42 | 20.46 | 20.10 |
| | | 2505 (20800) | 21.44 | 20.42 | 19.88 |
| | 25RB-Low (0) | 2565 (21400) | 21.39 | 20.45 | 20.02 |
| | | 2535 (21100) | 21.47 | 20.56 | 20.07 |
| | | 2505 (20800) | 21.44 | 20.36 | 19.76 |
| | 50RB (0) | 2565 (21400) | 21.38 | 20.45 | 20.02 |
| | | 2535 (21100) | 21.46 | 20.49 | 20.01 |
| | | 2505 (20800) | 21.46 | 20.42 | 19.85 |

| | | | | | |
|-------|------------------|----------------|-------|-------|-------|
| 15MHz | 1RB-High (74) | 2562.5 (21375) | 22.21 | 21.56 | 20.85 |
| | | 2535 (21100) | 22.10 | 21.11 | 21.00 |
| | | 2507.5 (20825) | 22.20 | 21.55 | 20.72 |
| | 1RB-Middle (37) | 2562.5 (21375) | 22.26 | 21.57 | 21.00 |
| | | 2535 (21100) | 22.14 | 21.21 | 21.09 |
| | | 2507.5 (20825) | 22.41 | 21.65 | 20.96 |
| | 1RB-Low (0) | 2562.5 (21375) | 22.23 | 21.59 | 21.13 |
| | | 2535 (21100) | 22.17 | 21.20 | 20.93 |
| | | 2507.5 (20825) | 22.35 | 21.67 | 20.83 |
| | 36RB-High (38) | 2562.5 (21375) | 21.38 | 20.33 | 19.91 |
| | | 2535 (21100) | 21.38 | 20.31 | 19.93 |
| | | 2507.5 (20825) | 21.42 | 20.45 | 19.79 |
| | 36RB-Middle (19) | 2562.5 (21375) | 21.35 | 20.36 | 19.94 |
| | | 2535 (21100) | 21.37 | 20.36 | 19.94 |
| | | 2507.5 (20825) | 21.44 | 20.45 | 19.83 |
| | 36RB-Low (0) | 2562.5 (21375) | 21.35 | 20.32 | 19.97 |
| | | 2535 (21100) | 21.36 | 20.37 | 19.95 |
| | | 2507.5 (20825) | 21.39 | 20.37 | 19.82 |
| | 75RB (0) | 2562.5 (21375) | 21.37 | 20.39 | 19.98 |
| | | 2535 (21100) | 21.34 | 20.33 | 19.89 |
| | | 2507.5 (20825) | 21.38 | 20.42 | 19.76 |
| 20MHz | 1RB-High (99) | 2560 (21350) | 22.17 | 21.59 | 20.89 |
| | | 2535 (21100) | 22.23 | 21.65 | 21.04 |
| | | 2510 (20850) | 22.19 | 21.73 | 20.78 |
| | 1RB-Middle (50) | 2560 (21350) | 22.30 | 21.81 | 21.37 |
| | | 2535 (21100) | 22.27 | 21.67 | 21.29 |
| | | 2510 (20850) | 22.27 | 21.89 | 20.85 |
| | 1RB-Low (0) | 2560 (21350) | 22.32 | 21.73 | 21.14 |
| | | 2535 (21100) | 22.22 | 21.59 | 21.08 |
| | | 2510 (20850) | 22.20 | 21.88 | 20.94 |
| | 50RB-High (50) | 2560 (21350) | 21.29 | 20.37 | 19.89 |
| | | 2535 (21100) | 21.30 | 20.32 | 19.84 |
| | | 2510 (20850) | 21.29 | 20.29 | 19.76 |
| | 50RB-Middle (25) | 2560 (21350) | 21.43 | 20.46 | 20.05 |
| | | 2535 (21100) | 21.38 | 20.36 | 19.92 |
| | | 2510 (20850) | 21.36 | 20.37 | 19.84 |
| | 50RB-Low (0) | 2560 (21350) | 21.34 | 20.35 | 19.99 |
| | | 2535 (21100) | 21.36 | 20.35 | 19.94 |
| | | 2510 (20850) | 21.32 | 20.33 | 19.71 |
| | 100RB (0) | 2560 (21350) | 21.41 | 20.40 | 19.94 |
| | | 2535 (21100) | 21.36 | 20.39 | 19.86 |
| | | 2510 (20850) | 21.35 | 20.37 | 19.66 |

| Band12 | | | | | |
|-----------|----------------|---------------|-------|-------|-------|
| BANDWIDTH | Number of RBs | Frequency | QPSK | 16QAM | 64QAM |
| 1.4MHz | 1RB-High (5) | 715.3 (23173) | 24.45 | 23.54 | 22.87 |
| | | 707.5 (23095) | 24.68 | 23.72 | 22.74 |
| | | 699.7 (23017) | 24.59 | 24.08 | 22.74 |
| | 1RB-Middle (3) | 715.3 (23173) | 24.58 | 23.82 | 22.91 |
| | | 707.5 (23095) | 24.75 | 23.70 | 22.71 |
| | | 699.7 (23017) | 24.58 | 24.06 | 22.75 |
| | 1RB-Low (0) | 715.3 (23173) | 24.45 | 23.58 | 22.90 |
| | | 707.5 (23095) | 24.55 | 23.63 | 22.67 |
| | | 699.7 (23017) | 24.39 | 23.82 | 22.79 |
| | 3RB-High (3) | 715.3 (23173) | 24.52 | 23.66 | 22.75 |
| | | 707.5 (23095) | 24.73 | 23.62 | 22.72 |
| | | 699.7 (23017) | 24.39 | 23.70 | 22.71 |
| | 3RB-Middle (1) | 715.3 (23173) | 24.74 | 23.69 | 22.75 |
| | | 707.5 (23095) | 24.61 | 23.56 | 22.70 |
| | | 699.7 (23017) | 24.48 | 23.67 | 22.69 |
| | 3RB-Low (0) | 715.3 (23173) | 24.74 | 23.70 | 22.77 |
| | | 707.5 (23095) | 24.65 | 23.59 | 22.66 |
| | | 699.7 (23017) | 24.41 | 23.66 | 23.01 |
| | 6RB (0) | 715.3 (23173) | 23.51 | 22.61 | 21.56 |
| | | 707.5 (23095) | 23.45 | 22.61 | 21.43 |
| | | 699.7 (23017) | 23.69 | 22.55 | 21.64 |
| 3MHz | 1RB-High (14) | 714.5 (23165) | 24.53 | 23.60 | 22.75 |
| | | 707.5 (23095) | 24.56 | 23.48 | 22.73 |
| | | 700.5 (23025) | 24.55 | 24.00 | 22.71 |
| | 1RB-Middle (7) | 714.5 (23165) | 24.81 | 23.69 | 22.84 |
| | | 707.5 (23095) | 24.55 | 23.57 | 22.75 |
| | | 700.5 (23025) | 24.64 | 24.13 | 22.80 |
| | 1RB-Low (0) | 714.5 (23165) | 24.72 | 23.89 | 22.89 |
| | | 707.5 (23095) | 24.46 | 23.48 | 22.68 |
| | | 700.5 (23025) | 24.45 | 23.87 | 22.86 |
| | 8RB-High (7) | 714.5 (23165) | 23.64 | 22.64 | 21.59 |
| | | 707.5 (23095) | 23.67 | 22.76 | 21.62 |
| | | 700.5 (23025) | 23.58 | 22.67 | 21.80 |
| | 8RB-Middle (4) | 714.5 (23165) | 23.72 | 22.70 | 21.72 |
| | | 707.5 (23095) | 23.63 | 22.80 | 21.63 |
| | | 700.5 (23025) | 23.52 | 22.74 | 21.67 |
| | 8RB-Low (0) | 714.5 (23165) | 23.75 | 22.72 | 21.85 |
| | | 707.5 (23095) | 23.62 | 22.70 | 21.54 |
| | | 700.5 (23025) | 23.68 | 22.78 | 21.91 |
| | 15RB (0) | 714.5 (23165) | 23.70 | 22.59 | 21.68 |
| | | 707.5 (23095) | 23.68 | 22.69 | 21.70 |
| | | 700.5 (23025) | 23.63 | 22.57 | 21.58 |

| | | | | | | |
|------------------|-----------------|---------------|---------------|-------|-------|-------|
| 5MHz | 1RB-High (24) | 713.5 (23155) | 24.68 | 23.78 | 22.72 | |
| | | 707.5 (23095) | 24.76 | 24.09 | 22.63 | |
| | | 701.5 (23035) | 24.68 | 23.71 | 22.72 | |
| | 1RB-Middle (12) | 713.5 (23155) | 24.71 | 23.76 | 22.66 | |
| | | 707.5 (23095) | 25.14 | 24.12 | 22.72 | |
| | | 701.5 (23035) | 24.37 | 23.77 | 22.90 | |
| | 1RB-Low (0) | 713.5 (23155) | 24.87 | 23.90 | 23.06 | |
| | | 707.5 (23095) | 24.95 | 24.11 | 22.68 | |
| | | 701.5 (23035) | 24.51 | 23.60 | 22.79 | |
| | 12RB-High (13) | 713.5 (23155) | 23.75 | 22.77 | 21.68 | |
| | | 707.5 (23095) | 23.68 | 22.74 | 21.59 | |
| | | 701.5 (23035) | 23.68 | 22.70 | 21.50 | |
| | 12RB-Middle (6) | 713.5 (23155) | 23.62 | 22.51 | 21.66 | |
| | | 707.5 (23095) | 23.57 | 22.76 | 21.60 | |
| | | 701.5 (23035) | 23.69 | 22.83 | 21.65 | |
| | 12RB-Low (0) | 713.5 (23155) | 23.72 | 22.76 | 21.79 | |
| | | 707.5 (23095) | 23.66 | 22.84 | 21.68 | |
| | | 701.5 (23035) | 23.63 | 22.83 | 21.74 | |
| | 25RB (0) | 713.5 (23155) | 23.67 | 22.72 | 21.72 | |
| | | 707.5 (23095) | 23.59 | 22.69 | 21.63 | |
| | | 701.5 (23035) | 23.83 | 22.74 | 21.60 | |
| | 10MHz | 1RB-High (49) | 711 (23130) | 24.68 | 23.74 | 22.76 |
| | | | 707.5 (23095) | 24.95 | 23.84 | 22.64 |
| | | | 704 (23060) | 24.87 | 24.17 | 22.83 |
| 1RB-Middle (24) | | 711 (23130) | 24.76 | 23.70 | 22.83 | |
| | | 707.5 (23095) | 24.55 | 23.48 | 22.69 | |
| | | 704 (23060) | 24.44 | 23.83 | 22.68 | |
| 1RB-Low (0) | | 711 (23130) | 24.95 | 23.94 | 23.06 | |
| | | 707.5 (23095) | 24.94 | 23.83 | 22.97 | |
| | | 704 (23060) | 24.41 | 23.81 | 23.25 | |
| 25RB-High (25) | | 711 (23130) | 23.67 | 22.77 | 21.70 | |
| | | 707.5 (23095) | 23.64 | 22.73 | 21.63 | |
| | | 704 (23060) | 23.66 | 22.73 | 21.73 | |
| 25RB-Middle (12) | | 711 (23130) | 23.62 | 22.81 | 21.60 | |
| | | 707.5 (23095) | 23.64 | 22.74 | 21.69 | |
| | | 704 (23060) | 23.76 | 22.72 | 21.65 | |
| 25RB-Low (0) | | 711 (23130) | 23.73 | 22.79 | 21.78 | |
| | | 707.5 (23095) | 23.91 | 22.84 | 21.71 | |
| | | 704 (23060) | 23.60 | 22.59 | 21.71 | |
| 50RB (0) | | 711 (23130) | 23.74 | 22.76 | 21.69 | |
| | | 707.5 (23095) | 23.76 | 22.76 | 21.63 | |
| | | 704 (23060) | 23.61 | 22.73 | 21.70 | |

| Band13 | | | | | |
|-----------|------------------|---------------|-------|-------|-------|
| BANDWIDTH | Number of RBs | Frequency | QPSK | 16QAM | 64QAM |
| 5MHz | 1RB-High (24) | 784.5 (23255) | 23.78 | 22.77 | 21.92 |
| | | 782 (23230) | 23.90 | 23.07 | 22.22 |
| | | 779.5 (23205) | 23.66 | 22.72 | 21.87 |
| | 1RB-Middle (12) | 784.5 (23255) | 23.64 | 22.63 | 21.79 |
| | | 782 (23230) | 24.31 | 23.15 | 22.29 |
| | | 779.5 (23205) | 23.76 | 22.65 | 21.80 |
| | 1RB-Low (0) | 784.5 (23255) | 23.88 | 22.77 | 21.92 |
| | | 782 (23230) | 23.81 | 23.14 | 22.28 |
| | | 779.5 (23205) | 23.54 | 22.62 | 21.78 |
| | 12RB-High (13) | 784.5 (23255) | 22.63 | 21.74 | 20.93 |
| | | 782 (23230) | 22.68 | 21.90 | 21.08 |
| | | 779.5 (23205) | 22.74 | 21.92 | 21.10 |
| | 12RB-Middle (6) | 784.5 (23255) | 22.66 | 21.75 | 20.95 |
| | | 782 (23230) | 22.70 | 21.92 | 21.11 |
| | | 779.5 (23205) | 22.65 | 21.80 | 20.99 |
| | 12RB-Low (0) | 784.5 (23255) | 22.62 | 21.69 | 20.89 |
| | | 782 (23230) | 22.71 | 21.90 | 21.08 |
| | | 779.5 (23205) | 22.92 | 21.60 | 20.80 |
| | 25RB (0) | 784.5 (23255) | 22.74 | 21.72 | 20.92 |
| | | 782 (23230) | 22.70 | 21.78 | 20.97 |
| | | 779.5 (23205) | 22.79 | 21.68 | 20.88 |
| 10MHz | 1RB-High (49) | 782 (23230) | 23.92 | 22.76 | 21.91 |
| | 1RB-Middle (24) | 782 (23230) | 23.76 | 22.53 | 21.69 |
| | 1RB-Low (0) | 782 (23230) | 23.96 | 22.76 | 21.91 |
| | 25RB-High (25) | 782 (23230) | 22.72 | 21.74 | 20.93 |
| | 25RB-Middle (12) | 782 (23230) | 22.72 | 21.74 | 20.93 |
| | 25RB-Low (0) | 782 (23230) | 22.82 | 21.67 | 20.87 |
| | 50RB (0) | 782 (23230) | 22.81 | 21.82 | 21.01 |

| Band25 | | | | | |
|-----------|----------------|----------------|-------|-------|-------|
| BANDWIDTH | Number of RBs | Frequency | QPSK | 16QAM | 64QAM |
| 1.4MHz | 1RB-High (5) | 1914.3 (26683) | 23.18 | 22.75 | 21.50 |
| | | 1882.5 (26365) | 23.65 | 22.59 | 21.90 |
| | | 1850.7 (26047) | 23.61 | 22.72 | 21.72 |
| | 1RB-Middle (3) | 1914.3 (26683) | 23.24 | 22.85 | 21.56 |
| | | 1882.5 (26365) | 23.56 | 22.76 | 21.92 |
| | | 1850.7 (26047) | 23.69 | 22.75 | 21.93 |
| | 1RB-Low (0) | 1914.3 (26683) | 23.32 | 22.84 | 21.52 |
| | | 1882.5 (26365) | 23.45 | 22.68 | 21.97 |
| | | 1850.7 (26047) | 23.69 | 22.75 | 21.77 |
| | 3RB-High (3) | 1914.3 (26683) | 23.05 | 22.52 | 21.49 |
| | | 1882.5 (26365) | 23.57 | 22.65 | 21.79 |
| | | 1850.7 (26047) | 23.74 | 22.65 | 21.74 |
| | 3RB-Middle (1) | 1914.3 (26683) | 23.21 | 22.67 | 21.52 |
| | | 1882.5 (26365) | 23.68 | 22.74 | 21.87 |
| | | 1850.7 (26047) | 23.70 | 22.70 | 21.82 |
| | 3RB-Low (0) | 1914.3 (26683) | 23.22 | 22.67 | 21.53 |
| | | 1882.5 (26365) | 23.62 | 22.73 | 21.85 |
| | | 1850.7 (26047) | 23.73 | 22.66 | 21.80 |
| | 6RB (0) | 1914.3 (26683) | 22.53 | 21.64 | 20.86 |
| | | 1882.5 (26365) | 22.67 | 21.76 | 20.66 |
| | | 1850.7 (26047) | 22.56 | 21.75 | 20.85 |
| 3MHz | 1RB-High (14) | 1913.5 (26675) | 23.06 | 22.78 | 21.67 |
| | | 1882.5 (26365) | 23.50 | 22.62 | 21.69 |
| | | 1851.5 (26055) | 23.59 | 22.48 | 21.53 |
| | 1RB-Middle (7) | 1913.5 (26675) | 23.40 | 22.86 | 21.83 |
| | | 1882.5 (26365) | 23.52 | 22.58 | 21.61 |
| | | 1851.5 (26055) | 23.50 | 22.53 | 21.54 |
| | 1RB-Low (0) | 1913.5 (26675) | 23.65 | 23.06 | 21.88 |
| | | 1882.5 (26365) | 23.48 | 22.69 | 21.83 |
| | | 1851.5 (26055) | 23.67 | 22.56 | 21.63 |
| | 8RB-High (7) | 1913.5 (26675) | 22.67 | 21.69 | 20.77 |
| | | 1882.5 (26365) | 22.67 | 21.73 | 20.80 |
| | | 1851.5 (26055) | 22.64 | 21.73 | 20.91 |
| | 8RB-Middle (4) | 1913.5 (26675) | 22.58 | 21.68 | 20.73 |
| | | 1882.5 (26365) | 22.67 | 21.72 | 20.81 |
| | | 1851.5 (26055) | 22.68 | 21.88 | 20.88 |
| | 8RB-Low (0) | 1913.5 (26675) | 22.62 | 21.73 | 20.81 |
| | | 1882.5 (26365) | 22.72 | 21.74 | 20.89 |
| | | 1851.5 (26055) | 22.67 | 21.78 | 20.91 |
| | 15RB (0) | 1913.5 (26675) | 22.67 | 21.69 | 20.73 |
| | | 1882.5 (26365) | 22.69 | 21.66 | 20.74 |
| | | 1851.5 (26055) | 22.60 | 21.71 | 20.82 |

| | | | | | | |
|------------------|-----------------|----------------|----------------|-------|-------|-------|
| 5MHz | 1RB-High (24) | 1912.5 (26665) | 23.22 | 22.20 | 21.54 | |
| | | 1882.5 (26365) | 23.59 | 22.75 | 22.16 | |
| | | 1852.5 (26065) | 23.59 | 23.18 | 21.71 | |
| | 1RB-Middle (12) | 1912.5 (26665) | 23.58 | 22.66 | 21.67 | |
| | | 1882.5 (26365) | 23.57 | 22.71 | 22.18 | |
| | | 1852.5 (26065) | 23.76 | 23.11 | 21.68 | |
| | 1RB-Low (0) | 1912.5 (26665) | 23.64 | 22.76 | 21.84 | |
| | | 1882.5 (26365) | 23.83 | 22.87 | 22.32 | |
| | | 1852.5 (26065) | 23.67 | 23.29 | 21.78 | |
| | 12RB-High (13) | 1912.5 (26665) | 22.75 | 21.65 | 20.85 | |
| | | 1882.5 (26365) | 22.74 | 21.71 | 20.91 | |
| | | 1852.5 (26065) | 22.70 | 21.83 | 20.77 | |
| | 12RB-Middle (6) | 1912.5 (26665) | 22.75 | 21.71 | 20.85 | |
| | | 1882.5 (26365) | 22.76 | 21.77 | 20.98 | |
| | | 1852.5 (26065) | 22.69 | 21.88 | 20.79 | |
| | 12RB-Low (0) | 1912.5 (26665) | 22.73 | 21.82 | 20.89 | |
| | | 1882.5 (26365) | 22.67 | 21.70 | 20.98 | |
| | | 1852.5 (26065) | 22.71 | 21.84 | 20.79 | |
| | 25RB (0) | 1912.5 (26665) | 22.80 | 21.67 | 20.84 | |
| | | 1882.5 (26365) | 22.61 | 21.70 | 20.81 | |
| | | 1852.5 (26065) | 22.74 | 21.78 | 20.77 | |
| | 10MHz | 1RB-High (49) | 1910 (26640) | 23.16 | 22.42 | 21.48 |
| | | | 1882.5 (26365) | 23.76 | 22.88 | 22.14 |
| | | | 1855 (26090) | 23.82 | 22.75 | 21.97 |
| 1RB-Middle (24) | | 1910 (26640) | 23.83 | 22.90 | 21.83 | |
| | | 1882.5 (26365) | 23.58 | 22.73 | 21.92 | |
| | | 1855 (26090) | 23.54 | 22.61 | 21.82 | |
| 1RB-Low (0) | | 1910 (26640) | 23.76 | 23.05 | 21.70 | |
| | | 1882.5 (26365) | 23.92 | 22.95 | 22.13 | |
| | | 1855 (26090) | 23.58 | 22.75 | 22.02 | |
| 25RB-High (25) | | 1910 (26640) | 22.68 | 21.70 | 20.87 | |
| | | 1882.5 (26365) | 22.73 | 21.79 | 20.81 | |
| | | 1855 (26090) | 22.82 | 21.79 | 20.86 | |
| 25RB-Middle (12) | | 1910 (26640) | 22.65 | 21.67 | 20.80 | |
| | | 1882.5 (26365) | 22.72 | 21.79 | 20.85 | |
| | | 1855 (26090) | 22.84 | 21.78 | 20.90 | |
| 25RB-Low (0) | | 1910 (26640) | 22.65 | 21.67 | 20.84 | |
| | | 1882.5 (26365) | 22.71 | 21.80 | 20.82 | |
| | | 1855 (26090) | 22.83 | 21.66 | 20.89 | |
| 50RB (0) | | 1910 (26640) | 22.70 | 21.80 | 20.90 | |
| | | 1882.5 (26365) | 22.83 | 21.84 | 20.93 | |
| | | 1855 (26090) | 22.80 | 21.77 | 20.90 | |

| | | | | | |
|-------|------------------|----------------|-------|-------|-------|
| 15MHz | 1RB-High (74) | 1907.5 (26615) | 23.39 | 22.50 | 21.55 |
| | | 1882.5 (26365) | 23.54 | 22.49 | 22.01 |
| | | 1857.5 (26115) | 23.57 | 22.94 | 21.92 |
| | 1RB-Middle (37) | 1907.5 (26615) | 23.68 | 23.05 | 21.69 |
| | | 1882.5 (26365) | 23.52 | 22.52 | 21.86 |
| | | 1857.5 (26115) | 23.55 | 22.94 | 21.85 |
| | 1RB-Low (0) | 1907.5 (26615) | 23.70 | 23.11 | 21.56 |
| | | 1882.5 (26365) | 23.65 | 22.59 | 22.03 |
| | | 1857.5 (26115) | 23.61 | 22.97 | 21.89 |
| | 36RB-High (38) | 1907.5 (26615) | 22.79 | 21.76 | 20.71 |
| | | 1882.5 (26365) | 22.71 | 21.60 | 20.87 |
| | | 1857.5 (26115) | 22.59 | 21.64 | 20.70 |
| | 36RB-Middle (19) | 1907.5 (26615) | 22.77 | 21.77 | 20.69 |
| | | 1882.5 (26365) | 22.66 | 21.57 | 20.84 |
| | | 1857.5 (26115) | 22.61 | 21.74 | 20.65 |
| | 36RB-Low (0) | 1907.5 (26615) | 22.74 | 21.68 | 20.67 |
| | | 1882.5 (26365) | 22.67 | 21.65 | 20.84 |
| | | 1857.5 (26115) | 22.62 | 21.70 | 20.71 |
| | 75RB (0) | 1907.5 (26615) | 22.72 | 21.82 | 20.86 |
| | | 1882.5 (26365) | 22.67 | 21.75 | 20.84 |
| | | 1857.5 (26115) | 22.60 | 21.64 | 20.71 |
| 20MHz | 1RB-High (99) | 1905 (26590) | 23.35 | 22.78 | 21.56 |
| | | 1882.5 (26365) | 23.18 | 22.80 | 21.85 |
| | | 1860 (26140) | 23.25 | 22.59 | 21.67 |
| | 1RB-Middle (50) | 1905 (26590) | 23.65 | 23.32 | 21.99 |
| | | 1882.5 (26365) | 23.79 | 22.98 | 22.18 |
| | | 1860 (26140) | 23.46 | 22.86 | 21.89 |
| | 1RB-Low (0) | 1905 (26590) | 23.71 | 23.16 | 21.95 |
| | | 1882.5 (26365) | 23.57 | 23.13 | 22.23 |
| | | 1860 (26140) | 23.53 | 22.88 | 21.99 |
| | 50RB-High (50) | 1905 (26590) | 22.59 | 21.63 | 20.60 |
| | | 1882.5 (26365) | 22.50 | 21.64 | 20.64 |
| | | 1860 (26140) | 22.43 | 21.36 | 20.51 |
| | 50RB-Middle (25) | 1905 (26590) | 22.66 | 21.76 | 20.66 |
| | | 1882.5 (26365) | 22.71 | 21.79 | 20.79 |
| | | 1860 (26140) | 22.48 | 21.58 | 20.70 |
| | 50RB-Low (0) | 1905 (26590) | 22.67 | 21.66 | 20.58 |
| | | 1882.5 (26365) | 22.55 | 21.68 | 20.71 |
| | | 1860 (26140) | 22.57 | 21.60 | 20.69 |
| | 100RB (0) | 1905 (26590) | 22.79 | 21.72 | 20.70 |
| | | 1882.5 (26365) | 22.67 | 21.68 | 20.78 |
| | | 1860 (26140) | 22.58 | 21.57 | 20.67 |

| Band26 | | | | | |
|-----------|----------------|---------------|-------|-------|-------|
| BANDWIDTH | Number of RBs | Frequency | QPSK | 16QAM | 64QAM |
| 1.4MHz | 1RB-High (5) | 848.3 (27033) | 24.58 | 23.83 | 22.82 |
| | | 831.5 (26865) | 24.73 | 23.58 | 22.79 |
| | | 814.7 (26697) | 24.02 | 23.54 | 22.41 |
| | 1RB-Middle (3) | 848.3 (27033) | 24.55 | 23.78 | 22.84 |
| | | 831.5 (26865) | 24.82 | 23.73 | 22.94 |
| | | 814.7 (26697) | 24.36 | 23.54 | 22.54 |
| | 1RB-Low (0) | 848.3 (27033) | 24.56 | 23.81 | 22.92 |
| | | 831.5 (26865) | 24.73 | 23.62 | 22.74 |
| | | 814.7 (26697) | 24.41 | 23.51 | 22.47 |
| | 3RB-High (3) | 848.3 (27033) | 24.59 | 23.62 | 22.74 |
| | | 831.5 (26865) | 24.56 | 23.57 | 22.76 |
| | | 814.7 (26697) | 24.36 | 23.47 | 22.71 |
| | 3RB-Middle (1) | 848.3 (27033) | 24.50 | 23.66 | 22.71 |
| | | 831.5 (26865) | 24.53 | 23.67 | 22.78 |
| | | 814.7 (26697) | 24.74 | 23.41 | 22.48 |
| | 3RB-Low (0) | 848.3 (27033) | 24.57 | 23.58 | 22.80 |
| | | 831.5 (26865) | 24.48 | 23.59 | 22.74 |
| | | 814.7 (26697) | 24.39 | 23.41 | 22.49 |
| | 6RB (0) | 848.3 (27033) | 23.77 | 22.63 | 21.84 |
| | | 831.5 (26865) | 23.60 | 22.70 | 21.87 |
| | | 814.7 (26697) | 23.57 | 22.49 | 21.14 |
| 3MHz | 1RB-High (14) | 847.5 (27025) | 24.40 | 23.89 | 22.87 |
| | | 831.5 (26865) | 24.51 | 23.65 | 22.54 |
| | | 815.5 (26705) | 24.53 | 23.58 | 22.57 |
| | 1RB-Middle (7) | 847.5 (27025) | 24.43 | 23.84 | 22.71 |
| | | 831.5 (26865) | 24.45 | 23.58 | 22.57 |
| | | 815.5 (26705) | 24.46 | 23.59 | 22.56 |
| | 1RB-Low (0) | 847.5 (27025) | 24.49 | 23.92 | 22.88 |
| | | 831.5 (26865) | 24.51 | 23.60 | 22.54 |
| | | 815.5 (26705) | 24.52 | 23.59 | 22.57 |
| | 8RB-High (7) | 847.5 (27025) | 23.67 | 22.63 | 21.84 |
| | | 831.5 (26865) | 23.64 | 22.64 | 21.89 |
| | | 815.5 (26705) | 23.59 | 22.63 | 21.89 |
| | 8RB-Middle (4) | 847.5 (27025) | 23.56 | 22.63 | 21.83 |
| | | 831.5 (26865) | 23.59 | 22.68 | 21.95 |
| | | 815.5 (26705) | 23.61 | 22.67 | 21.99 |
| | 8RB-Low (0) | 847.5 (27025) | 23.74 | 22.73 | 21.93 |
| | | 831.5 (26865) | 23.60 | 22.66 | 21.87 |
| | | 815.5 (26705) | 23.61 | 22.63 | 21.96 |
| | 15RB (0) | 847.5 (27025) | 23.63 | 22.68 | 21.74 |
| | | 831.5 (26865) | 23.58 | 22.56 | 21.80 |
| | | 815.5 (26705) | 23.58 | 22.60 | 21.79 |

| | | | | | | |
|------------------|-----------------|---------------|---------------|-------|-------|-------|
| 5MHz | 1RB-High (24) | 846.5 (27015) | 24.83 | 22.73 | 22.70 | |
| | | 831.5 (26865) | 24.49 | 22.79 | 22.77 | |
| | | 816.5 (26715) | 24.49 | 22.37 | 23.17 | |
| | 1RB-Middle (12) | 846.5 (27015) | 24.62 | 23.65 | 22.72 | |
| | | 831.5 (26865) | 24.94 | 23.00 | 22.73 | |
| | | 816.5 (26715) | 24.53 | 22.53 | 23.27 | |
| | 1RB-Low (0) | 846.5 (27015) | 24.70 | 23.06 | 22.77 | |
| | | 831.5 (26865) | 24.58 | 22.92 | 22.82 | |
| | | 816.5 (26715) | 24.61 | 22.74 | 23.21 | |
| | 12RB-High (13) | 846.5 (27015) | 23.67 | 22.01 | 21.69 | |
| | | 831.5 (26865) | 23.67 | 21.68 | 21.87 | |
| | | 816.5 (26715) | 23.62 | 21.53 | 22.09 | |
| | 12RB-Middle (6) | 846.5 (27015) | 23.61 | 22.43 | 21.77 | |
| | | 831.5 (26865) | 23.73 | 21.80 | 21.83 | |
| | | 816.5 (26715) | 23.79 | 21.65 | 22.07 | |
| | 12RB-Low (0) | 846.5 (27015) | 23.68 | 22.42 | 21.91 | |
| | | 831.5 (26865) | 23.66 | 21.79 | 21.83 | |
| | | 816.5 (26715) | 23.62 | 21.74 | 22.03 | |
| | 25RB (0) | 846.5 (27015) | 23.64 | 22.23 | 21.77 | |
| | | 831.5 (26865) | 23.65 | 21.67 | 21.83 | |
| | | 816.5 (26715) | 23.59 | 21.51 | 21.81 | |
| | 10MHz | 1RB-High (49) | 844 (26990) | 24.88 | 23.90 | 23.09 |
| | | | 831.5 (26865) | 24.89 | 23.76 | 22.84 |
| | | | 820 (26750) | 24.75 | 24.01 | 23.25 |
| 1RB-Middle (24) | | 844 (26990) | 24.79 | 23.65 | 22.70 | |
| | | 831.5 (26865) | 24.64 | 23.44 | 22.62 | |
| | | 820 (26750) | 24.57 | 23.75 | 22.92 | |
| 1RB-Low (0) | | 844 (26990) | 24.93 | 23.93 | 23.10 | |
| | | 831.5 (26865) | 24.71 | 23.74 | 22.80 | |
| | | 820 (26750) | 24.81 | 23.95 | 23.17 | |
| 25RB-High (25) | | 844 (26990) | 23.72 | 22.75 | 21.90 | |
| | | 831.5 (26865) | 23.57 | 22.73 | 21.95 | |
| | | 820 (26750) | 23.68 | 22.67 | 21.88 | |
| 25RB-Middle (12) | | 844 (26990) | 23.69 | 22.82 | 21.97 | |
| | | 831.5 (26865) | 23.68 | 22.70 | 21.87 | |
| | | 820 (26750) | 23.67 | 22.69 | 21.86 | |
| 25RB-Low (0) | | 844 (26990) | 23.76 | 22.88 | 22.06 | |
| | | 831.5 (26865) | 23.84 | 22.75 | 21.90 | |
| | | 820 (26750) | 23.76 | 22.72 | 21.97 | |
| 50RB (0) | | 844 (26990) | 23.73 | 22.80 | 21.95 | |
| | | 831.5 (26865) | 23.61 | 22.67 | 21.86 | |
| | | 820 (26750) | 23.66 | 22.74 | 21.82 | |

| | | | | | |
|-------|------------------|---------------|-------|-------|-------|
| 15MHz | 1RB-High (74) | 841.5 (26965) | 25.51 | 24.67 | 23.71 |
| | | 831.5 (26865) | 25.29 | 24.09 | 23.42 |
| | | 822.5 (26775) | 24.83 | 24.35 | 23.08 |
| | 1RB-Middle (37) | 841.5 (26965) | 25.27 | 24.70 | 23.53 |
| | | 831.5 (26865) | 24.83 | 23.58 | 22.96 |
| | | 822.5 (26775) | 24.53 | 23.79 | 22.53 |
| | 1RB-Low (0) | 841.5 (26965) | 25.49 | 24.55 | 23.61 |
| | | 831.5 (26865) | 25.12 | 23.77 | 23.28 |
| | | 822.5 (26775) | 24.71 | 24.00 | 22.79 |
| | 36RB-High (38) | 841.5 (26965) | 23.92 | 23.17 | 22.26 |
| | | 831.5 (26865) | 23.73 | 22.58 | 21.85 |
| | | 822.5 (26775) | 23.38 | 22.49 | 21.54 |
| | 36RB-Middle (19) | 841.5 (26965) | 24.34 | 23.26 | 22.39 |
| | | 831.5 (26865) | 23.75 | 22.81 | 21.90 |
| | | 822.5 (26775) | 23.67 | 22.66 | 21.79 |
| | 36RB-Low (0) | 841.5 (26965) | 24.38 | 23.48 | 22.64 |
| | | 831.5 (26865) | 24.04 | 23.13 | 22.10 |
| | | 822.5 (26775) | 23.82 | 22.87 | 22.04 |
| | 75RB (0) | 841.5 (26965) | 24.39 | 23.40 | 22.50 |
| | | 831.5 (26865) | 23.84 | 22.93 | 21.98 |
| | | 822.5 (26775) | 23.70 | 22.62 | 21.76 |



| Band41(PC3) | | | | | | |
|------------------|-----------------|-----------------|----------------|-------|-------|-------|
| BANDWIDTH | Number of RBs | Frequency | QPSK | 16QAM | 64QAM | |
| 5MHz | 1RB-High (24) | 2687.5 (41565) | 23.53 | 22.54 | 21.76 | |
| | | 2640.3(41093) | 23.37 | 22.28 | 21.51 | |
| | | 2593 (40620) | 23.37 | 22.26 | 21.49 | |
| | | 2545.8(40148) | 23.39 | 22.47 | 21.69 | |
| | 1RB-Middle (12) | 2498.5 (39675) | 23.41 | 22.26 | 21.49 | |
| | | 2687.5 (41565) | 23.36 | 22.39 | 21.61 | |
| | | 2640.3(41093) | 23.75 | 22.26 | 21.49 | |
| | | 2593 (40620) | 23.46 | 22.28 | 21.51 | |
| | 1RB-Low (0) | 2545.8(40148) | 23.38 | 22.40 | 21.62 | |
| | | 2498.5 (39675) | 23.77 | 22.08 | 21.31 | |
| | | 2687.5 (41565) | 23.60 | 22.70 | 21.91 | |
| | | 2640.3(41093) | 23.53 | 22.32 | 21.54 | |
| | 12RB-High (13) | 2593 (40620) | 23.50 | 22.43 | 21.65 | |
| | | 2545.8(40148) | 23.57 | 22.62 | 21.83 | |
| | | 2498.5 (39675) | 23.50 | 22.29 | 21.52 | |
| | | 2687.5 (41565) | 22.46 | 21.47 | 20.73 | |
| | 12RB-Middle (6) | 2640.3(41093) | 22.34 | 21.29 | 20.55 | |
| | | 2593 (40620) | 22.24 | 21.28 | 20.54 | |
| | | 2545.8(40148) | 22.40 | 21.39 | 20.65 | |
| | | 2498.5 (39675) | 22.30 | 21.23 | 20.49 | |
| | 12RB-Low (0) | 2687.5 (41565) | 22.39 | 21.42 | 20.68 | |
| | | 2640.3(41093) | 22.37 | 21.29 | 20.55 | |
| | | 2593 (40620) | 22.37 | 21.31 | 20.58 | |
| | | 2545.8(40148) | 22.37 | 21.42 | 20.68 | |
| | 25RB (0) | 2498.5 (39675) | 22.29 | 21.24 | 20.50 | |
| | | 2687.5 (41565) | 22.40 | 21.48 | 20.74 | |
| | | 2640.3(41093) | 22.36 | 21.35 | 20.61 | |
| | | 2593 (40620) | 22.44 | 21.44 | 20.70 | |
| | 25RB (0) | 2545.8(40148) | 22.40 | 21.47 | 20.73 | |
| | | 2498.5 (39675) | 22.31 | 21.28 | 20.55 | |
| | | 2687.5 (41565) | 22.40 | 21.36 | 20.62 | |
| | | 2640.3(41093) | 22.36 | 21.37 | 20.63 | |
| | 10MHz | 1RB-High (49) | 2593 (40620) | 22.32 | 21.40 | 20.66 |
| | | | 2545.8(40148) | 22.39 | 21.38 | 20.64 |
| | | | 2498.5 (39675) | 22.31 | 21.23 | 20.50 |
| | | | 2687.5 (41565) | 22.40 | 21.36 | 20.62 |
| | | 1RB-Middle (24) | 2685 (41540) | 22.30 | 21.37 | 20.63 |
| | | | 2639(41080) | 22.36 | 21.37 | 20.63 |
| | | | 2593 (40620) | 22.32 | 21.40 | 20.66 |
| | | | 2547(40160) | 22.39 | 21.39 | 20.65 |
| | | 1RB-Low (0) | 2501 (39700) | 23.39 | 22.54 | 21.75 |
| | | | 2685 (41540) | 23.45 | 22.32 | 21.55 |
| | | | 2639(41080) | 23.98 | 22.36 | 21.58 |
| | | | 2593 (40620) | 23.36 | 22.45 | 21.67 |
| | | 25RB-High (25) | 2547(40160) | 23.40 | 22.27 | 21.50 |
| | | | 2501 (39700) | 23.39 | 22.28 | 21.51 |
| | | | 2685 (41540) | 23.48 | 22.46 | 21.69 |
| | | | 2639(41080) | 23.58 | 22.57 | 21.79 |
| 25RB-Middle (12) | | 2593 (40620) | 23.52 | 22.36 | 21.59 | |
| | | 2547(40160) | 23.54 | 22.40 | 21.62 | |
| | | 2501 (39700) | 23.58 | 22.45 | 21.67 | |
| | | 2685 (41540) | 22.38 | 21.45 | 20.70 | |
| 25RB-Low (0) | | 2639(41080) | 22.56 | 21.53 | 20.79 | |
| | | 2593 (40620) | 22.38 | 21.35 | 20.61 | |
| | | 2547(40160) | 22.39 | 21.44 | 20.70 | |
| | | 2501 (39700) | 22.40 | 21.36 | 20.62 | |
| 50RB (0) | | 2685 (41540) | 22.38 | 21.34 | 20.60 | |
| | | 2639(41080) | 22.48 | 21.49 | 20.74 | |
| | | 2593 (40620) | 22.37 | 21.45 | 20.70 | |
| | | 2547(40160) | 22.41 | 21.44 | 20.70 | |
| 50RB (0) | | 2501 (39700) | 22.46 | 21.40 | 20.66 | |
| | | 2685 (41540) | 22.45 | 21.41 | 20.67 | |
| | | 2639(41080) | 22.45 | 21.46 | 20.72 | |
| | | 2593 (40620) | 22.44 | 21.46 | 20.72 | |
| 50RB (0) | | 2547(40160) | 22.46 | 21.43 | 20.69 | |
| | | 2501 (39700) | 22.39 | 21.39 | 20.65 | |
| | | 2685 (41540) | 22.47 | 21.50 | 20.76 | |
| | | 2639(41080) | 22.48 | 21.54 | 20.80 | |
| 50RB (0) | | 2593 (40620) | 22.40 | 21.46 | 20.71 | |
| | | 2547(40160) | 22.46 | 21.42 | 20.68 | |
| | | 2501 (39700) | 22.35 | 21.41 | 20.67 | |
| | | 2685 (41540) | 22.47 | 21.50 | 20.76 | |

| | | | | | |
|----------------|------------------|----------------|-------|-------|-------|
| 15MHz | 1RB-High (74) | 2682.5 (41515) | 23.82 | 22.67 | 21.89 |
| | | 2637.8(41068) | 23.73 | 22.85 | 22.06 |
| | | 2593 (40620) | 23.93 | 22.83 | 22.04 |
| | | 2548.3(40173) | 23.81 | 22.78 | 21.99 |
| | | 2503.5 (39725) | 23.80 | 22.94 | 22.14 |
| | 1RB-Middle (37) | 2682.5 (41515) | 23.76 | 22.68 | 21.89 |
| | | 2637.8(41068) | 23.61 | 22.68 | 21.90 |
| | | 2593 (40620) | 23.69 | 22.58 | 21.80 |
| | | 2548.3(40173) | 23.65 | 22.52 | 21.74 |
| | | 2503.5 (39725) | 23.54 | 22.70 | 21.92 |
| | 1RB-Low (0) | 2682.5 (41515) | 23.94 | 22.81 | 22.02 |
| | | 2637.8(41068) | 23.53 | 22.63 | 21.85 |
| | | 2593 (40620) | 23.52 | 22.42 | 21.65 |
| | | 2548.3(40173) | 23.92 | 22.82 | 22.03 |
| | | 2503.5 (39725) | 23.78 | 22.95 | 22.15 |
| | 36RB-High (38) | 2682.5 (41515) | 22.59 | 21.62 | 20.87 |
| | | 2637.8(41068) | 22.60 | 21.65 | 20.90 |
| | | 2593 (40620) | 22.67 | 21.66 | 20.91 |
| | | 2548.3(40173) | 22.71 | 21.66 | 20.91 |
| | | 2503.5 (39725) | 22.71 | 21.74 | 20.99 |
| | 36RB-Middle (19) | 2682.5 (41515) | 22.63 | 21.67 | 20.92 |
| | | 2637.8(41068) | 22.65 | 21.69 | 20.94 |
| | | 2593 (40620) | 22.70 | 21.66 | 20.91 |
| | | 2548.3(40173) | 22.62 | 21.60 | 20.85 |
| | | 2503.5 (39725) | 22.70 | 21.70 | 20.95 |
| | 36RB-Low (0) | 2682.5 (41515) | 22.63 | 21.66 | 20.91 |
| | | 2637.8(41068) | 22.57 | 21.54 | 20.79 |
| | | 2593 (40620) | 22.54 | 21.51 | 20.77 |
| 2548.3(40173) | | 22.66 | 21.67 | 20.92 | |
| 2503.5 (39725) | | 22.65 | 21.68 | 20.93 | |
| 75RB (0) | 2682.5 (41515) | 22.73 | 21.69 | 20.93 | |
| | 2637.8(41068) | 22.61 | 21.62 | 20.87 | |
| | 2593 (40620) | 22.69 | 21.63 | 20.88 | |
| | 2548.3(40173) | 22.63 | 21.69 | 20.94 | |
| | 2503.5 (39725) | 22.66 | 21.64 | 20.89 | |
| 20MHz | 1RB-High (99) | 2680 (41490) | 23.71 | 22.47 | 21.69 |
| | | 2636.5(41055) | 23.90 | 22.72 | 21.93 |
| | | 2593 (40620) | 23.92 | 22.92 | 22.13 |
| | | 2549.5(40185) | 23.84 | 22.84 | 22.05 |
| | | 2506 (39750) | 23.97 | 22.82 | 22.03 |
| | 1RB-Middle (50) | 2680 (41490) | 23.57 | 22.69 | 21.90 |
| | | 2636.5(41055) | 23.85 | 22.58 | 21.80 |
| | | 2593 (40620) | 23.76 | 22.70 | 21.91 |
| | | 2549.5(40185) | 23.59 | 22.56 | 21.78 |
| | | 2506 (39750) | 23.85 | 22.90 | 22.11 |
| | 1RB-Low (0) | 2680 (41490) | 23.89 | 22.79 | 22.00 |
| | | 2636.5(41055) | 23.80 | 22.56 | 21.77 |
| | | 2593 (40620) | 23.68 | 22.76 | 21.97 |
| | | 2549.5(40185) | 23.86 | 22.78 | 22.00 |
| | | 2506 (39750) | 23.92 | 22.75 | 21.96 |
| | 50RB-High (50) | 2680 (41490) | 22.63 | 21.64 | 20.89 |
| | | 2636.5(41055) | 22.66 | 21.64 | 20.89 |
| | | 2593 (40620) | 22.71 | 21.79 | 21.04 |
| | | 2549.5(40185) | 22.67 | 21.58 | 20.83 |
| | | 2506 (39750) | 22.71 | 21.73 | 20.97 |
| | 50RB-Middle (25) | 2680 (41490) | 22.63 | 21.62 | 20.87 |
| | | 2636.5(41055) | 22.68 | 21.62 | 20.87 |
| | | 2593 (40620) | 22.70 | 21.75 | 21.00 |
| | | 2549.5(40185) | 22.55 | 21.48 | 20.73 |
| | | 2506 (39750) | 22.73 | 21.66 | 20.91 |
| | 50RB-Low (0) | 2680 (41490) | 22.65 | 21.63 | 20.88 |
| | | 2636.5(41055) | 22.67 | 21.65 | 20.90 |
| | | 2593 (40620) | 22.53 | 21.61 | 20.86 |
| | | 2549.5(40185) | 22.72 | 21.64 | 20.89 |
| | | 2506 (39750) | 22.71 | 21.66 | 20.91 |
| | 100RB (0) | 2680 (41490) | 22.66 | 21.65 | 20.90 |
| | | 2636.5(41055) | 22.72 | 21.75 | 20.99 |
| 2593 (40620) | | 22.67 | 21.64 | 20.89 | |
| 2549.5(40185) | | 22.67 | 21.69 | 20.94 | |
| 2506 (39750) | | 22.71 | 21.64 | 20.89 | |

| Band41(PC2) | | | | | | |
|------------------|-----------------|----------------|--------------|-------|-------|-------|
| BANDWIDTH | Number of RBs | Frequency | QPSK | 16QAM | 64QAM | |
| 5MHz | 1RB-High (24) | 2687.5 (41565) | 26.52 | 25.49 | 24.53 | |
| | | 2640.3(41093) | 26.78 | 26.11 | 25.13 | |
| | | 2593 (40620) | 26.81 | 25.94 | 24.97 | |
| | | 2545.8(40148) | 26.88 | 26.02 | 25.05 | |
| | | 2498.5 (39675) | 26.77 | 26.19 | 25.21 | |
| | 1RB-Middle (12) | 2687.5 (41565) | 26.60 | 25.82 | 24.85 | |
| | | 2640.3(41093) | 26.75 | 26.14 | 25.16 | |
| | | 2593 (40620) | 26.76 | 26.03 | 25.06 | |
| | | 2545.8(40148) | 26.85 | 26.00 | 25.03 | |
| | | 2498.5 (39675) | 26.61 | 26.03 | 25.06 | |
| | 1RB-Low (0) | 2687.5 (41565) | 26.49 | 25.73 | 24.77 | |
| | | 2640.3(41093) | 26.82 | 26.28 | 25.30 | |
| | | 2593 (40620) | 26.99 | 26.13 | 25.15 | |
| | | 2545.8(40148) | 26.97 | 26.13 | 25.15 | |
| | | 2498.5 (39675) | 26.97 | 26.14 | 25.16 | |
| | 12RB-High (13) | 2687.5 (41565) | 25.97 | 24.94 | 24.00 | |
| | | 2640.3(41093) | 25.75 | 24.85 | 23.91 | |
| | | 2593 (40620) | 25.76 | 24.79 | 23.87 | |
| | | 2545.8(40148) | 25.79 | 24.80 | 23.87 | |
| | | 2498.5 (39675) | 25.59 | 24.78 | 23.85 | |
| | 12RB-Middle (6) | 2687.5 (41565) | 25.88 | 24.88 | 23.95 | |
| | | 2640.3(41093) | 25.80 | 24.86 | 23.93 | |
| | | 2593 (40620) | 25.78 | 24.77 | 23.85 | |
| | | 2545.8(40148) | 25.83 | 24.87 | 23.94 | |
| | | 2498.5 (39675) | 25.65 | 24.83 | 23.90 | |
| | 12RB-Low (0) | 2687.5 (41565) | 25.88 | 24.93 | 24.00 | |
| | | 2640.3(41093) | 25.77 | 24.92 | 23.98 | |
| | | 2593 (40620) | 25.89 | 24.81 | 23.88 | |
| | | 2545.8(40148) | 25.88 | 24.86 | 23.93 | |
| | | 2498.5 (39675) | 25.77 | 24.89 | 23.96 | |
| | 25RB (0) | 2687.5 (41565) | 25.79 | 24.97 | 24.03 | |
| | | 2640.3(41093) | 25.80 | 24.88 | 23.95 | |
| | | 2593 (40620) | 25.83 | 24.82 | 23.89 | |
| | | 2545.8(40148) | 25.82 | 24.85 | 23.92 | |
| | | 2498.5 (39675) | 25.75 | 24.72 | 23.80 | |
| | 10MHz | 1RB-High (49) | 2685 (41540) | 26.47 | 25.43 | 24.48 |
| | | | 2639(41080) | 27.10 | 26.16 | 25.18 |
| | | | 2593 (40620) | 26.97 | 26.38 | 25.39 |
| | | | 2547(40160) | 26.77 | 26.44 | 25.45 |
| | | | 2501 (39700) | 26.93 | 26.21 | 25.22 |
| 1RB-Middle (24) | | 2685 (41540) | 26.70 | 26.08 | 25.10 | |
| | | 2639(41080) | 27.00 | 26.04 | 25.07 | |
| | | 2593 (40620) | 27.05 | 26.16 | 25.18 | |
| | | 2547(40160) | 26.70 | 26.54 | 25.55 | |
| | | 2501 (39700) | 26.76 | 26.05 | 25.07 | |
| 1RB-Low (0) | | 2685 (41540) | 26.46 | 25.86 | 24.89 | |
| | | 2639(41080) | 27.02 | 26.17 | 25.19 | |
| | | 2593 (40620) | 27.02 | 26.36 | 25.37 | |
| | | 2547(40160) | 26.79 | 26.42 | 25.43 | |
| | | 2501 (39700) | 26.97 | 26.18 | 25.20 | |
| 25RB-High (25) | | 2685 (41540) | 25.88 | 24.94 | 24.01 | |
| | | 2639(41080) | 25.95 | 25.01 | 24.08 | |
| | | 2593 (40620) | 25.85 | 24.88 | 23.95 | |
| | | 2547(40160) | 25.91 | 24.90 | 23.97 | |
| | | 2501 (39700) | 25.83 | 24.90 | 23.96 | |
| 25RB-Middle (12) | | 2685 (41540) | 25.82 | 24.88 | 23.95 | |
| | | 2639(41080) | 25.98 | 24.91 | 23.98 | |
| | | 2593 (40620) | 25.88 | 24.88 | 23.94 | |
| | | 2547(40160) | 25.84 | 24.92 | 23.98 | |
| | | 2501 (39700) | 25.87 | 24.94 | 24.01 | |
| 25RB-Low (0) | | 2685 (41540) | 25.87 | 24.96 | 24.03 | |
| | | 2639(41080) | 25.89 | 24.90 | 23.97 | |
| | | 2593 (40620) | 25.92 | 24.85 | 23.92 | |
| | | 2547(40160) | 25.87 | 24.94 | 24.01 | |
| | | 2501 (39700) | 25.77 | 24.83 | 23.90 | |
| 50RB (0) | | 2685 (41540) | 25.94 | 24.98 | 24.04 | |
| | | 2639(41080) | 25.91 | 24.91 | 23.97 | |
| | | 2593 (40620) | 25.90 | 24.86 | 23.93 | |
| | | 2547(40160) | 25.92 | 24.92 | 23.99 | |
| | | 2501 (39700) | 25.84 | 24.86 | 23.93 | |

| | | | | | |
|------------------|------------------|----------------|--------------|-------|-------|
| 15MHz | 1RB-High (74) | 2682.5 (41515) | 26.52 | 25.62 | 24.66 |
| | | 2637.8(41068) | 27.12 | 26.44 | 25.45 |
| | | 2593 (40620) | 27.27 | 26.53 | 25.54 |
| | | 2548.3(40173) | 27.22 | 26.61 | 25.61 |
| | | 2503.5 (39725) | 27.06 | 26.42 | 25.43 |
| | 1RB-Middle (37) | 2682.5 (41515) | 26.65 | 26.06 | 25.08 |
| | | 2637.8(41068) | 26.93 | 26.30 | 25.32 |
| | | 2593 (40620) | 27.12 | 26.30 | 25.32 |
| | | 2548.3(40173) | 26.96 | 26.36 | 25.37 |
| | | 2503.5 (39725) | 26.90 | 26.22 | 25.24 |
| | 1RB-Low (0) | 2682.5 (41515) | 26.72 | 26.14 | 25.16 |
| | | 2637.8(41068) | 26.94 | 26.28 | 25.30 |
| | | 2593 (40620) | 26.88 | 26.15 | 25.17 |
| | | 2548.3(40173) | 27.27 | 26.69 | 25.69 |
| | | 2503.5 (39725) | 27.01 | 26.42 | 25.43 |
| | 36RB-High (38) | 2682.5 (41515) | 26.05 | 25.05 | 24.11 |
| | | 2637.8(41068) | 26.04 | 25.03 | 24.10 |
| | | 2593 (40620) | 26.11 | 25.10 | 24.16 |
| | | 2548.3(40173) | 26.02 | 25.07 | 24.13 |
| | | 2503.5 (39725) | 26.10 | 25.11 | 24.17 |
| | 36RB-Middle (19) | 2682.5 (41515) | 26.08 | 25.10 | 24.16 |
| | | 2637.8(41068) | 26.06 | 25.14 | 24.20 |
| | | 2593 (40620) | 26.08 | 25.15 | 24.21 |
| | | 2548.3(40173) | 26.02 | 25.05 | 24.12 |
| | | 2503.5 (39725) | 26.04 | 25.05 | 24.12 |
| | 36RB-Low (0) | 2682.5 (41515) | 26.10 | 25.07 | 24.13 |
| | | 2637.8(41068) | 25.98 | 24.97 | 24.03 |
| | | 2593 (40620) | 25.88 | 25.02 | 24.08 |
| | | 2548.3(40173) | 26.11 | 25.14 | 24.20 |
| | | 2503.5 (39725) | 26.06 | 25.06 | 24.12 |
| | 75RB (0) | 2682.5 (41515) | 26.02 | 25.09 | 24.15 |
| | | 2637.8(41068) | 26.02 | 25.06 | 24.12 |
| | | 2593 (40620) | 26.05 | 25.06 | 24.12 |
| | | 2548.3(40173) | 25.96 | 25.10 | 24.16 |
| | | 2503.5 (39725) | 26.07 | 25.08 | 24.14 |
| | 20MHz | 1RB-High (99) | 2680 (41490) | 27.19 | 25.51 |
| 2636.5(41055) | | | 27.36 | 26.38 | 25.39 |
| 2593 (40620) | | | 27.41 | 26.67 | 25.67 |
| 2549.5(40185) | | | 27.33 | 26.50 | 25.51 |
| 2506 (39750) | | | 27.36 | 26.38 | 25.39 |
| 1RB-Middle (50) | | 2680 (41490) | 26.92 | 26.05 | 25.08 |
| | | 2636.5(41055) | 27.26 | 26.20 | 25.22 |
| | | 2593 (40620) | 27.23 | 26.59 | 25.60 |
| | | 2549.5(40185) | 27.06 | 26.21 | 25.23 |
| | | 2506 (39750) | 27.24 | 26.15 | 25.17 |
| 1RB-Low (0) | | 2680 (41490) | 27.03 | 26.14 | 25.17 |
| | | 2636.5(41055) | 27.21 | 26.15 | 25.17 |
| | | 2593 (40620) | 27.06 | 26.50 | 25.50 |
| | | 2549.5(40185) | 27.31 | 26.38 | 25.39 |
| | | 2506 (39750) | 27.18 | 26.19 | 25.20 |
| 50RB-High (50) | | 2680 (41490) | 26.13 | 25.14 | 24.20 |
| | | 2636.5(41055) | 26.13 | 25.12 | 24.18 |
| | | 2593 (40620) | 26.17 | 25.21 | 24.26 |
| | | 2549.5(40185) | 26.01 | 25.02 | 24.08 |
| | | 2506 (39750) | 26.13 | 25.16 | 24.22 |
| 50RB-Middle (25) | | 2680 (41490) | 25.98 | 25.09 | 24.15 |
| | | 2636.5(41055) | 26.14 | 25.15 | 24.20 |
| | | 2593 (40620) | 26.16 | 25.13 | 24.19 |
| | | 2549.5(40185) | 25.97 | 24.95 | 24.02 |
| | | 2506 (39750) | 26.09 | 25.12 | 24.18 |
| 50RB-Low (0) | | 2680 (41490) | 26.07 | 25.09 | 24.15 |
| | | 2636.5(41055) | 26.15 | 25.11 | 24.17 |
| | | 2593 (40620) | 26.01 | 25.05 | 24.11 |
| | | 2549.5(40185) | 26.10 | 25.10 | 24.16 |
| | | 2506 (39750) | 26.08 | 25.15 | 24.21 |
| 100RB (0) | | 2680 (41490) | 26.05 | 25.10 | 24.16 |
| | | 2636.5(41055) | 26.14 | 25.23 | 24.28 |
| | | 2593 (40620) | 26.10 | 25.10 | 24.16 |
| | | 2549.5(40185) | 26.14 | 25.11 | 24.17 |
| | | 2506 (39750) | 26.00 | 25.06 | 24.12 |

| Band66 | | | | | | |
|----------------|----------------|-----------------|-----------------|-------|-------|-------|
| BANDWIDTH | Number of RBs | Frequency | QPSK | 16QAM | 64QAM | |
| 1.4MHz | 1RB-High (5) | 1779.3 (132665) | 23.88 | 22.81 | 22.24 | |
| | | 1745 (132322) | 23.84 | 22.85 | 22.28 | |
| | | 1710.7 (131979) | 23.74 | 22.72 | 22.15 | |
| | 1RB-Middle (3) | 1779.3 (132665) | 23.91 | 22.91 | 22.34 | |
| | | 1745 (132322) | 23.75 | 22.75 | 22.18 | |
| | | 1710.7 (131979) | 23.74 | 22.79 | 22.22 | |
| | 1RB-Low (0) | 1779.3 (132665) | 23.87 | 22.91 | 22.34 | |
| | | 1745 (132322) | 23.86 | 22.89 | 22.32 | |
| | | 1710.7 (131979) | 23.98 | 22.72 | 22.15 | |
| | 3RB-High (3) | 1779.3 (132665) | 23.79 | 22.85 | 22.28 | |
| | | 1745 (132322) | 23.65 | 22.99 | 22.41 | |
| | | 1710.7 (131979) | 23.99 | 22.73 | 22.16 | |
| | 3RB-Middle (1) | 1779.3 (132665) | 23.88 | 22.94 | 22.37 | |
| | | 1745 (132322) | 23.72 | 22.91 | 22.34 | |
| | | 1710.7 (131979) | 23.91 | 22.76 | 22.19 | |
| | 3RB-Low (0) | 1779.3 (132665) | 23.78 | 22.94 | 22.37 | |
| | | 1745 (132322) | 23.66 | 22.95 | 22.38 | |
| | | 1710.7 (131979) | 23.95 | 22.73 | 22.16 | |
| | 6RB (0) | 1779.3 (132665) | 22.85 | 21.79 | 21.24 | |
| | | 1745 (132322) | 22.72 | 21.82 | 21.27 | |
| | | 1710.7 (131979) | 22.69 | 21.76 | 21.22 | |
| | 3MHz | 1RB-High (14) | 1778.5 (132657) | 24.00 | 22.90 | 22.33 |
| | | | 1745 (132322) | 23.78 | 22.95 | 22.38 |
| | | | 1711.5 (131987) | 23.76 | 22.67 | 22.10 |
| | | 1RB-Middle (7) | 1778.5 (132657) | 23.90 | 22.91 | 22.34 |
| | | | 1745 (132322) | 23.82 | 22.93 | 22.36 |
| | | | 1711.5 (131987) | 23.86 | 22.91 | 22.34 |
| 1RB-Low (0) | | 1778.5 (132657) | 23.94 | 22.51 | 21.95 | |
| | | 1745 (132322) | 23.72 | 22.41 | 21.85 | |
| | | 1711.5 (131987) | 23.74 | 22.70 | 22.13 | |
| 8RB-High (7) | | 1778.5 (132657) | 22.93 | 21.92 | 21.37 | |
| | | 1745 (132322) | 22.83 | 21.90 | 21.35 | |
| | | 1711.5 (131987) | 22.84 | 21.80 | 21.25 | |
| 8RB-Middle (4) | | 1778.5 (132657) | 22.93 | 21.90 | 21.35 | |
| | | 1745 (132322) | 22.93 | 21.94 | 21.39 | |
| | | 1711.5 (131987) | 22.97 | 21.87 | 21.32 | |
| 8RB-Low (0) | | 1778.5 (132657) | 22.94 | 22.00 | 21.45 | |
| | | 1745 (132322) | 22.90 | 21.89 | 21.34 | |
| | | 1711.5 (131987) | 22.90 | 21.85 | 21.30 | |
| 15RB (0) | | 1778.5 (132657) | 22.97 | 21.93 | 21.38 | |
| | | 1745 (132322) | 22.89 | 21.82 | 21.27 | |
| | | 1711.5 (131987) | 22.87 | 21.78 | 21.23 | |

| | | | | | |
|----------|------------------|-----------------|-------|-------|-------|
| 5MHz | 1RB-High (24) | 1777.5 (132647) | 23.66 | 22.78 | 22.21 |
| | | 1745 (132322) | 23.61 | 22.91 | 22.33 |
| | | 1712.5 (131997) | 23.50 | 22.94 | 22.37 |
| | 1RB-Middle (12) | 1777.5 (132647) | 23.85 | 22.90 | 22.32 |
| | | 1745 (132322) | 23.52 | 22.79 | 22.22 |
| | | 1712.5 (131997) | 22.90 | 22.92 | 22.35 |
| | 1RB-Low (0) | 1777.5 (132647) | 23.83 | 22.95 | 22.37 |
| | | 1745 (132322) | 23.73 | 22.94 | 22.37 |
| | | 1712.5 (131997) | 23.74 | 22.91 | 22.34 |
| | 12RB-High (13) | 1777.5 (132647) | 22.82 | 21.68 | 21.13 |
| | | 1745 (132322) | 22.69 | 21.62 | 21.08 |
| | | 1712.5 (131997) | 22.69 | 21.72 | 21.18 |
| | 12RB-Middle (6) | 1777.5 (132647) | 22.86 | 21.86 | 21.31 |
| | | 1745 (132322) | 22.64 | 21.69 | 21.15 |
| | | 1712.5 (131997) | 22.60 | 21.74 | 21.19 |
| | 12RB-Low (0) | 1777.5 (132647) | 22.76 | 21.73 | 21.18 |
| | | 1745 (132322) | 22.71 | 21.76 | 21.21 |
| | | 1712.5 (131997) | 22.75 | 21.82 | 21.27 |
| 25RB (0) | 1777.5 (132647) | 22.89 | 21.69 | 21.15 | |
| | 1745 (132322) | 22.63 | 21.66 | 21.12 | |
| | 1712.5 (131997) | 22.67 | 21.66 | 21.11 | |
| 10MHz | 1RB-High (49) | 1775 (132622) | 23.88 | 22.94 | 22.37 |
| | | 1745 (132322) | 23.92 | 22.95 | 22.37 |
| | | 1715 (132022) | 23.91 | 22.85 | 22.27 |
| | 1RB-Middle (24) | 1775 (132622) | 23.62 | 22.90 | 22.33 |
| | | 1745 (132322) | 23.60 | 22.70 | 22.13 |
| | | 1715 (132022) | 23.52 | 22.48 | 21.92 |
| | 1RB-Low (0) | 1775 (132622) | 23.35 | 22.48 | 21.92 |
| | | 1745 (132322) | 23.14 | 22.05 | 21.50 |
| | | 1715 (132022) | 23.34 | 22.01 | 21.46 |
| | 25RB-High (25) | 1775 (132622) | 22.85 | 21.91 | 21.36 |
| | | 1745 (132322) | 22.81 | 21.93 | 21.38 |
| | | 1715 (132022) | 22.66 | 21.74 | 21.19 |
| | 25RB-Middle (12) | 1775 (132622) | 22.76 | 21.83 | 21.28 |
| | | 1745 (132322) | 22.70 | 21.77 | 21.22 |
| | | 1715 (132022) | 22.85 | 21.78 | 21.24 |
| | 25RB-Low (0) | 1775 (132622) | 22.62 | 21.65 | 21.11 |
| | | 1745 (132322) | 22.58 | 21.78 | 21.23 |
| | | 1715 (132022) | 22.52 | 21.58 | 21.04 |
| 50RB (0) | 1775 (132622) | 22.73 | 21.84 | 21.30 | |
| | 1745 (132322) | 22.67 | 21.70 | 21.15 | |
| | 1715 (132022) | 22.65 | 21.64 | 21.09 | |

| | | | | | |
|-------|------------------|-----------------|-------|-------|-------|
| 15MHz | 1RB-High (74) | 1772.5 (132597) | 23.85 | 22.91 | 22.34 |
| | | 1745 (132322) | 23.81 | 22.68 | 22.12 |
| | | 1717.5 (132047) | 23.62 | 22.86 | 22.29 |
| | 1RB-Middle (37) | 1772.5 (132597) | 23.97 | 22.83 | 22.26 |
| | | 1745 (132322) | 23.74 | 22.57 | 22.01 |
| | | 1717.5 (132047) | 23.54 | 22.84 | 22.27 |
| | 1RB-Low (0) | 1772.5 (132597) | 23.94 | 22.92 | 22.35 |
| | | 1745 (132322) | 23.82 | 22.87 | 22.29 |
| | | 1717.5 (132047) | 23.74 | 22.83 | 22.26 |
| | 36RB-High (38) | 1772.5 (132597) | 22.84 | 21.84 | 21.30 |
| | | 1745 (132322) | 22.76 | 21.69 | 21.15 |
| | | 1717.5 (132047) | 22.57 | 21.69 | 21.14 |
| | 36RB-Middle (19) | 1772.5 (132597) | 22.74 | 21.78 | 21.23 |
| | | 1745 (132322) | 22.76 | 21.76 | 21.22 |
| | | 1717.5 (132047) | 22.67 | 21.65 | 21.11 |
| | 36RB-Low (0) | 1772.5 (132597) | 22.83 | 21.84 | 21.29 |
| | | 1745 (132322) | 22.65 | 21.58 | 21.04 |
| | | 1717.5 (132047) | 22.71 | 21.77 | 21.23 |
| | 75RB (0) | 1772.5 (132597) | 22.74 | 21.75 | 21.20 |
| | | 1745 (132322) | 22.72 | 21.74 | 21.19 |
| | | 1717.5 (132047) | 22.61 | 21.71 | 21.17 |
| 20MHz | 1RB-High (99) | 1770 (132572) | 23.91 | 22.72 | 22.15 |
| | | 1745 (132322) | 23.95 | 22.89 | 22.32 |
| | | 1720 (132072) | 23.96 | 22.82 | 22.24 |
| | 1RB-Middle (50) | 1770 (132572) | 23.54 | 22.46 | 21.90 |
| | | 1745 (132322) | 23.90 | 22.46 | 21.89 |
| | | 1720 (132072) | 23.54 | 22.05 | 21.50 |
| | 1RB-Low (0) | 1770 (132572) | 23.43 | 22.31 | 21.76 |
| | | 1745 (132322) | 23.65 | 22.98 | 22.40 |
| | | 1720 (132072) | 23.28 | 22.86 | 22.29 |
| | 50RB-High (50) | 1770 (132572) | 22.78 | 21.77 | 21.23 |
| | | 1745 (132322) | 22.74 | 21.79 | 21.25 |
| | | 1720 (132072) | 22.61 | 21.71 | 21.17 |
| | 50RB-Middle (25) | 1770 (132572) | 22.67 | 21.71 | 21.17 |
| | | 1745 (132322) | 22.70 | 21.79 | 21.25 |
| | | 1720 (132072) | 22.79 | 21.69 | 21.14 |
| | 50RB-Low (0) | 1770 (132572) | 22.58 | 21.54 | 21.00 |
| | | 1745 (132322) | 22.51 | 21.62 | 21.08 |
| | | 1720 (132072) | 22.53 | 21.54 | 21.00 |
| | 100RB (0) | 1770 (132572) | 22.67 | 21.70 | 21.16 |
| | | 1745 (132322) | 22.63 | 21.58 | 21.04 |
| | | 1720 (132072) | 22.72 | 21.63 | 21.09 |

| Band71 | | | | | |
|-----------|------------------|----------------|-------|-------|-------|
| BANDWIDTH | Number of RBs | Frequency | QPSK | 16QAM | 64QAM |
| 5MHz | 1RB-High (24) | 695.5 (133447) | 24.57 | 24.02 | 22.91 |
| | | 680.5 (133297) | 24.46 | 23.55 | 22.90 |
| | | 665.5 (133147) | 24.58 | 23.57 | 22.89 |
| | 1RB-Middle (12) | 695.5 (133447) | 24.78 | 23.90 | 23.22 |
| | | 680.5 (133297) | 24.47 | 23.54 | 22.89 |
| | | 665.5 (133147) | 24.73 | 23.68 | 22.97 |
| | 1RB-Low (0) | 695.5 (133447) | 24.66 | 24.01 | 22.91 |
| | | 680.5 (133297) | 24.57 | 23.63 | 22.98 |
| | | 665.5 (133147) | 24.06 | 23.22 | 22.62 |
| | 12RB-High (13) | 695.5 (133447) | 23.53 | 22.65 | 22.02 |
| | | 680.5 (133297) | 23.51 | 22.53 | 22.01 |
| | | 665.5 (133147) | 23.57 | 22.85 | 22.04 |
| | 12RB-Middle (6) | 695.5 (133447) | 23.43 | 22.56 | 21.92 |
| | | 680.5 (133297) | 23.55 | 22.55 | 21.87 |
| | | 665.5 (133147) | 23.62 | 22.67 | 22.01 |
| | 12RB-Low (0) | 695.5 (133447) | 23.59 | 22.76 | 22.10 |
| | | 680.5 (133297) | 23.63 | 22.63 | 21.96 |
| | | 665.5 (133147) | 23.61 | 22.73 | 22.09 |
| | 25RB (0) | 695.5 (133447) | 23.60 | 22.56 | 21.97 |
| | | 680.5 (133297) | 23.60 | 22.57 | 21.92 |
| | | 665.5 (133147) | 23.58 | 22.61 | 21.93 |
| 10MHz | 1RB-High (49) | 693 (132422) | 24.57 | 24.01 | 22.94 |
| | | 680.5 (133297) | 24.71 | 23.52 | 22.81 |
| | | 668 (133172) | 24.19 | 23.21 | 22.64 |
| | 1RB-Middle (24) | 693 (132422) | 24.58 | 23.93 | 23.25 |
| | | 680.5 (133297) | 24.56 | 23.58 | 22.82 |
| | | 668 (133172) | 24.59 | 23.65 | 22.95 |
| | 1RB-Low (0) | 693 (132422) | 24.59 | 23.96 | 22.93 |
| | | 680.5 (133297) | 24.75 | 23.70 | 22.90 |
| | | 668 (133172) | 24.01 | 23.24 | 22.58 |
| | 25RB-High (25) | 693 (132422) | 23.57 | 22.59 | 21.92 |
| | | 680.5 (133297) | 23.52 | 22.63 | 21.99 |
| | | 668 (133172) | 23.54 | 22.64 | 21.95 |
| | 25RB-Middle (12) | 693 (132422) | 23.58 | 22.60 | 21.95 |
| | | 680.5 (133297) | 23.54 | 22.71 | 22.05 |
| | | 668 (133172) | 23.56 | 22.67 | 22.00 |
| | 25RB-Low (0) | 693 (132422) | 23.63 | 22.68 | 21.99 |
| | | 680.5 (133297) | 23.59 | 22.79 | 22.14 |
| | | 668 (133172) | 23.64 | 22.64 | 21.98 |
| | 50RB (0) | 693 (132422) | 23.52 | 22.55 | 21.89 |
| | | 680.5 (133297) | 23.57 | 22.61 | 21.96 |
| | | 668 (133172) | 23.60 | 22.54 | 22.00 |

| | | | | | |
|-----------|------------------|----------------|-------|-------|-------|
| 15MHz | 1RB-High (74) | 690.5 (133397) | 24.46 | 23.55 | 23.26 |
| | | 680.5 (133297) | 24.65 | 23.96 | 23.29 |
| | | 670.5 (133197) | 24.81 | 24.01 | 22.87 |
| | 1RB-Middle (37) | 690.5 (133397) | 24.51 | 23.47 | 23.32 |
| | | 680.5 (133297) | 24.56 | 24.12 | 23.49 |
| | | 670.5 (133197) | 24.48 | 23.90 | 22.79 |
| | 1RB-Low (0) | 690.5 (133397) | 24.65 | 23.66 | 23.41 |
| | | 680.5 (133297) | 24.75 | 24.15 | 23.49 |
| | | 670.5 (133197) | 24.44 | 23.81 | 22.68 |
| | 36RB-High (38) | 690.5 (133397) | 23.64 | 22.56 | 21.92 |
| | | 680.5 (133297) | 23.57 | 22.67 | 21.94 |
| | | 670.5 (133197) | 23.65 | 22.65 | 21.99 |
| | 36RB-Middle (19) | 690.5 (133397) | 23.60 | 22.50 | 21.98 |
| | | 680.5 (133297) | 23.67 | 22.79 | 22.02 |
| | | 670.5 (133197) | 23.73 | 22.64 | 21.99 |
| | 36RB-Low (0) | 690.5 (133397) | 23.63 | 22.63 | 21.91 |
| | | 680.5 (133297) | 23.75 | 22.72 | 22.00 |
| | | 670.5 (133197) | 23.73 | 22.75 | 22.03 |
| 75RB (0) | 690.5 (133397) | 23.60 | 22.60 | 21.98 | |
| | 680.5 (133297) | 23.76 | 22.65 | 22.02 | |
| | 670.5 (133197) | 23.74 | 22.73 | 22.02 | |
| 20MHz | 1RB-High (99) | 688 (133372) | 24.53 | 24.03 | 23.39 |
| | | 683 (133322) | 24.66 | 24.08 | 23.39 |
| | | 673 (133222) | 25.05 | 24.19 | 23.50 |
| | 1RB-Middle (50) | 688 (133372) | 24.54 | 24.02 | 23.29 |
| | | 683 (133322) | 24.42 | 23.86 | 23.17 |
| | | 673 (133222) | 24.79 | 24.08 | 23.31 |
| | 1RB-Low (0) | 688 (133372) | 24.75 | 24.28 | 23.60 |
| | | 683 (133322) | 24.73 | 24.20 | 23.53 |
| | | 673 (133222) | 25.25 | 24.39 | 23.75 |
| | 50RB-High (50) | 688 (133372) | 23.56 | 22.60 | 21.98 |
| | | 683 (133322) | 23.65 | 22.64 | 22.00 |
| | | 673 (133222) | 23.71 | 22.72 | 22.09 |
| | 50RB-Middle (25) | 688 (133372) | 23.64 | 22.64 | 21.97 |
| | | 683 (133322) | 23.74 | 22.66 | 22.00 |
| | | 673 (133222) | 23.68 | 22.70 | 22.03 |
| | 50RB-Low (0) | 688 (133372) | 23.69 | 22.80 | 22.10 |
| | | 683 (133322) | 23.69 | 22.65 | 22.00 |
| | | 673 (133222) | 23.74 | 22.79 | 22.06 |
| 100RB (0) | 688 (133372) | 23.57 | 22.61 | 21.95 | |
| | 683 (133322) | 23.69 | 22.72 | 22.07 | |
| | 673 (133222) | 23.70 | 22.84 | 22.16 | |

Low power

| Band7-Low power | | | | | | |
|------------------|-----------------|----------------|--------------|-------|-------|-------|
| BANDWIDTH | Number of RBs | Frequency | QPSK | 16QAM | 64QAM | |
| 5MHz | 1RB-High (24) | 2567.5 (21425) | 20.45 | 19.56 | 19.19 | |
| | | 2535 (21100) | 20.34 | 19.89 | 19.51 | |
| | | 2502.5 (20775) | 20.42 | 19.53 | 19.16 | |
| | 1RB-Middle (12) | 2567.5 (21425) | 20.48 | 19.55 | 19.18 | |
| | | 2535 (21100) | 20.48 | 19.90 | 19.53 | |
| | | 2502.5 (20775) | 20.45 | 19.39 | 19.02 | |
| | 1RB-Low (0) | 2567.5 (21425) | 20.60 | 19.72 | 19.34 | |
| | | 2535 (21100) | 20.41 | 19.91 | 19.53 | |
| | | 2502.5 (20775) | 20.45 | 19.53 | 19.16 | |
| | 12RB-High (13) | 2567.5 (21425) | 19.39 | 18.50 | 18.15 | |
| | | 2535 (21100) | 19.44 | 18.57 | 18.21 | |
| | | 2502.5 (20775) | 19.41 | 18.45 | 18.10 | |
| | 12RB-Middle (6) | 2567.5 (21425) | 19.43 | 18.50 | 18.14 | |
| | | 2535 (21100) | 19.46 | 18.59 | 18.23 | |
| | | 2502.5 (20775) | 19.43 | 18.48 | 18.13 | |
| | 12RB-Low (0) | 2567.5 (21425) | 19.48 | 18.58 | 18.22 | |
| | | 2535 (21100) | 19.50 | 18.67 | 18.32 | |
| | | 2502.5 (20775) | 19.46 | 18.58 | 18.22 | |
| | 25RB (0) | 2567.5 (21425) | 19.43 | 18.47 | 18.12 | |
| | | 2535 (21100) | 19.43 | 18.49 | 18.14 | |
| | | 2502.5 (20775) | 19.44 | 18.34 | 17.99 | |
| | 10MHz | 1RB-High (49) | 2565 (21400) | 20.49 | 19.41 | 19.04 |
| | | | 2535 (21100) | 20.54 | 19.90 | 19.52 |
| | | | 2505 (20800) | 20.45 | 19.47 | 19.09 |
| 1RB-Middle (24) | | 2565 (21400) | 20.30 | 19.30 | 18.93 | |
| | | 2535 (21100) | 20.38 | 19.74 | 19.36 | |
| | | 2505 (20800) | 20.36 | 19.47 | 19.10 | |
| 1RB-Low (0) | | 2565 (21400) | 20.58 | 19.52 | 19.14 | |
| | | 2535 (21100) | 20.62 | 19.94 | 19.56 | |
| | | 2505 (20800) | 20.59 | 19.60 | 19.23 | |
| 25RB-High (25) | | 2565 (21400) | 19.39 | 18.50 | 18.14 | |
| | | 2535 (21100) | 19.44 | 18.47 | 18.12 | |
| | | 2505 (20800) | 19.38 | 18.39 | 18.04 | |
| 25RB-Middle (12) | | 2565 (21400) | 19.55 | 18.50 | 18.15 | |
| | | 2535 (21100) | 19.45 | 18.49 | 18.14 | |
| | | 2505 (20800) | 19.43 | 18.55 | 18.19 | |
| 25RB-Low (0) | | 2565 (21400) | 19.51 | 18.48 | 18.12 | |
| | | 2535 (21100) | 19.47 | 18.46 | 18.10 | |
| | | 2505 (20800) | 19.37 | 18.53 | 18.18 | |
| 50RB (0) | | 2565 (21400) | 19.48 | 18.45 | 18.10 | |
| | | 2535 (21100) | 19.47 | 18.53 | 18.18 | |
| | | 2505 (20800) | 19.50 | 18.45 | 18.10 | |

| | | | | | |
|-------|------------------|----------------|-------|-------|-------|
| 15MHz | 1RB-High (74) | 2562.5 (21375) | 20.23 | 19.61 | 19.24 |
| | | 2535 (21100) | 20.13 | 19.09 | 18.73 |
| | | 2507.5 (20825) | 20.29 | 19.60 | 19.23 |
| | 1RB-Middle (37) | 2562.5 (21375) | 20.23 | 19.60 | 19.22 |
| | | 2535 (21100) | 20.31 | 19.29 | 18.92 |
| | | 2507.5 (20825) | 20.42 | 19.74 | 19.37 |
| | 1RB-Low (0) | 2562.5 (21375) | 20.29 | 19.59 | 19.22 |
| | | 2535 (21100) | 20.21 | 19.15 | 18.79 |
| | | 2507.5 (20825) | 20.33 | 19.71 | 19.33 |
| | 36RB-High (38) | 2562.5 (21375) | 19.40 | 18.34 | 17.99 |
| | | 2535 (21100) | 19.41 | 18.32 | 17.97 |
| | | 2507.5 (20825) | 19.46 | 18.44 | 18.09 |
| | 36RB-Middle (19) | 2562.5 (21375) | 19.41 | 18.40 | 18.05 |
| | | 2535 (21100) | 19.42 | 18.37 | 18.02 |
| | | 2507.5 (20825) | 19.48 | 18.48 | 18.13 |
| | 36RB-Low (0) | 2562.5 (21375) | 19.30 | 18.24 | 17.90 |
| | | 2535 (21100) | 19.38 | 18.32 | 17.97 |
| | | 2507.5 (20825) | 19.43 | 18.47 | 18.11 |
| | 75RB (0) | 2562.5 (21375) | 19.27 | 18.34 | 17.99 |
| | | 2535 (21100) | 19.38 | 18.41 | 18.06 |
| | | 2507.5 (20825) | 19.41 | 18.45 | 18.10 |
| 20MHz | 1RB-High (99) | 2560 (21350) | 20.31 | 19.60 | 19.23 |
| | | 2535 (21100) | 20.34 | 19.62 | 19.24 |
| | | 2510 (20850) | 20.20 | 19.72 | 19.34 |
| | 1RB-Middle (50) | 2560 (21350) | 20.40 | 19.81 | 19.43 |
| | | 2535 (21100) | 20.61 | 19.77 | 19.39 |
| | | 2510 (20850) | 20.49 | 19.90 | 19.52 |
| | 1RB-Low (0) | 2560 (21350) | 20.57 | 19.68 | 19.31 |
| | | 2535 (21100) | 20.40 | 19.59 | 19.22 |
| | | 2510 (20850) | 20.40 | 19.82 | 19.44 |
| | 50RB-High (50) | 2560 (21350) | 19.33 | 18.41 | 18.06 |
| | | 2535 (21100) | 19.32 | 18.27 | 17.92 |
| | | 2510 (20850) | 19.31 | 18.31 | 17.97 |
| | 50RB-Middle (25) | 2560 (21350) | 19.44 | 18.37 | 18.02 |
| | | 2535 (21100) | 19.41 | 18.37 | 18.02 |
| | | 2510 (20850) | 19.40 | 18.40 | 18.05 |
| | 50RB-Low (0) | 2560 (21350) | 19.30 | 18.35 | 18.00 |
| | | 2535 (21100) | 19.35 | 18.37 | 18.02 |
| | | 2510 (20850) | 19.36 | 18.31 | 17.96 |
| | 100RB (0) | 2560 (21350) | 19.27 | 18.31 | 17.96 |
| | | 2535 (21100) | 19.41 | 18.37 | 18.02 |
| | | 2510 (20850) | 19.31 | 18.33 | 17.98 |

| Band25-Low power | | | | | |
|------------------|----------------|----------------|-------|-------|-------|
| BANDWIDTH | Number of RBs | Frequency | QPSK | 16QAM | 64QAM |
| 1.4MHz | 1RB-High (5) | 1914.3 (26683) | 18.23 | 17.62 | 16.60 |
| | | 1882.5 (26365) | 18.24 | 17.29 | 16.23 |
| | | 1850.7 (26047) | 18.32 | 17.42 | 16.39 |
| | 1RB-Middle (3) | 1914.3 (26683) | 18.30 | 17.67 | 16.68 |
| | | 1882.5 (26365) | 18.35 | 17.33 | 16.33 |
| | | 1850.7 (26047) | 18.39 | 17.47 | 16.45 |
| | 1RB-Low (0) | 1914.3 (26683) | 18.31 | 17.67 | 16.69 |
| | | 1882.5 (26365) | 18.32 | 17.37 | 16.32 |
| | | 1850.7 (26047) | 18.37 | 17.38 | 16.44 |
| | 3RB-High (3) | 1914.3 (26683) | 18.27 | 17.34 | 16.38 |
| | | 1882.5 (26365) | 18.22 | 17.36 | 16.41 |
| | | 1850.7 (26047) | 18.31 | 17.33 | 16.37 |
| | 3RB-Middle (1) | 1914.3 (26683) | 18.29 | 17.45 | 16.41 |
| | | 1882.5 (26365) | 18.30 | 17.50 | 16.48 |
| | | 1850.7 (26047) | 18.30 | 17.38 | 16.38 |
| | 3RB-Low (0) | 1914.3 (26683) | 18.31 | 17.39 | 16.43 |
| | | 1882.5 (26365) | 18.25 | 17.48 | 16.46 |
| | | 1850.7 (26047) | 18.27 | 17.38 | 16.34 |
| | 6RB (0) | 1914.3 (26683) | 17.24 | 16.18 | 15.20 |
| | | 1882.5 (26365) | 17.24 | 16.44 | 15.44 |
| | | 1850.7 (26047) | 17.29 | 16.40 | 15.45 |
| 3MHz | 1RB-High (14) | 1913.5 (26675) | 18.30 | 17.65 | 16.25 |
| | | 1882.5 (26365) | 18.27 | 17.31 | 16.17 |
| | | 1851.5 (26055) | 18.31 | 17.18 | 16.67 |
| | 1RB-Middle (7) | 1913.5 (26675) | 18.36 | 17.64 | 16.33 |
| | | 1882.5 (26365) | 18.28 | 17.36 | 16.28 |
| | | 1851.5 (26055) | 18.32 | 17.28 | 16.76 |
| | 1RB-Low (0) | 1913.5 (26675) | 18.38 | 17.79 | 16.50 |
| | | 1882.5 (26365) | 18.36 | 17.42 | 16.28 |
| | | 1851.5 (26055) | 18.45 | 17.26 | 16.80 |
| | 8RB-High (7) | 1913.5 (26675) | 17.25 | 16.28 | 15.33 |
| | | 1882.5 (26365) | 17.26 | 16.28 | 15.43 |
| | | 1851.5 (26055) | 17.33 | 16.38 | 15.41 |
| | 8RB-Middle (4) | 1913.5 (26675) | 17.35 | 16.41 | 15.46 |
| | | 1882.5 (26365) | 17.31 | 16.38 | 15.47 |
| | | 1851.5 (26055) | 17.33 | 16.48 | 15.46 |
| | 8RB-Low (0) | 1913.5 (26675) | 17.23 | 16.38 | 15.40 |
| | | 1882.5 (26365) | 17.34 | 16.40 | 15.49 |
| | | 1851.5 (26055) | 17.38 | 16.44 | 15.46 |
| | 15RB (0) | 1913.5 (26675) | 17.23 | 16.28 | 15.24 |
| | | 1882.5 (26365) | 17.26 | 16.29 | 15.41 |
| | | 1851.5 (26055) | 17.32 | 16.32 | 15.41 |

| | | | | | | |
|------------------|-----------------|----------------|----------------|-------|-------|-------|
| 5MHz | 1RB-High (24) | 1912.5 (26665) | 18.23 | 17.42 | 16.42 | |
| | | 1882.5 (26365) | 18.34 | 17.54 | 16.56 | |
| | | 1852.5 (26065) | 18.29 | 17.87 | 16.82 | |
| | 1RB-Middle (12) | 1912.5 (26665) | 18.34 | 17.43 | 16.42 | |
| | | 1882.5 (26365) | 18.24 | 17.42 | 16.48 | |
| | | 1852.5 (26065) | 18.28 | 17.86 | 16.84 | |
| | 1RB-Low (0) | 1912.5 (26665) | 18.39 | 17.52 | 16.50 | |
| | | 1882.5 (26365) | 18.41 | 17.55 | 16.55 | |
| | | 1852.5 (26065) | 18.44 | 17.92 | 16.91 | |
| | 12RB-High (13) | 1912.5 (26665) | 17.31 | 16.23 | 15.33 | |
| | | 1882.5 (26365) | 17.38 | 16.37 | 15.40 | |
| | | 1852.5 (26065) | 17.27 | 16.41 | 15.40 | |
| | 12RB-Middle (6) | 1912.5 (26665) | 17.33 | 16.34 | 15.36 | |
| | | 1882.5 (26365) | 17.40 | 16.42 | 15.46 | |
| | | 1852.5 (26065) | 17.34 | 16.47 | 15.52 | |
| | 12RB-Low (0) | 1912.5 (26665) | 17.31 | 16.40 | 15.43 | |
| | | 1882.5 (26365) | 17.36 | 16.40 | 15.45 | |
| | | 1852.5 (26065) | 17.40 | 16.57 | 15.56 | |
| | 25RB (0) | 1912.5 (26665) | 17.33 | 16.23 | 15.26 | |
| | | 1882.5 (26365) | 17.27 | 16.32 | 15.41 | |
| | | 1852.5 (26065) | 17.34 | 16.41 | 15.37 | |
| | 10MHz | 1RB-High (49) | 1910 (26640) | 18.50 | 17.90 | 16.41 |
| | | | 1882.5 (26365) | 18.49 | 17.51 | 16.89 |
| | | | 1855 (26090) | 18.53 | 17.51 | 16.57 |
| 1RB-Middle (24) | | 1910 (26640) | 18.24 | 17.62 | 16.22 | |
| | | 1882.5 (26365) | 18.28 | 17.31 | 16.68 | |
| | | 1855 (26090) | 18.29 | 17.20 | 16.38 | |
| 1RB-Low (0) | | 1910 (26640) | 18.29 | 17.79 | 16.39 | |
| | | 1882.5 (26365) | 18.30 | 17.56 | 16.84 | |
| | | 1855 (26090) | 18.31 | 17.41 | 16.50 | |
| 25RB-High (25) | | 1910 (26640) | 17.29 | 16.37 | 15.46 | |
| | | 1882.5 (26365) | 17.25 | 16.39 | 15.39 | |
| | | 1855 (26090) | 17.30 | 16.38 | 15.44 | |
| 25RB-Middle (12) | | 1910 (26640) | 17.30 | 16.33 | 15.36 | |
| | | 1882.5 (26365) | 17.33 | 16.44 | 15.40 | |
| | | 1855 (26090) | 17.35 | 16.35 | 15.51 | |
| 25RB-Low (0) | | 1910 (26640) | 17.28 | 16.23 | 15.30 | |
| | | 1882.5 (26365) | 17.27 | 16.43 | 15.36 | |
| | | 1855 (26090) | 17.31 | 16.35 | 15.47 | |
| 50RB (0) | | 1910 (26640) | 17.33 | 16.37 | 15.40 | |
| | | 1882.5 (26365) | 17.36 | 16.40 | 15.46 | |
| | | 1855 (26090) | 17.38 | 16.40 | 15.46 | |

| | | | | | | |
|------------------|------------------|-----------------|----------------|-------|-------|-------|
| 15MHz | 1RB-High (74) | 1907.5 (26615) | 18.49 | 17.41 | 16.80 | |
| | | 1882.5 (26365) | 18.27 | 17.60 | 16.15 | |
| | | 1857.5 (26115) | 18.36 | 17.78 | 16.70 | |
| | 1RB-Middle (37) | 1907.5 (26615) | 18.45 | 17.36 | 16.75 | |
| | | 1882.5 (26365) | 18.19 | 17.51 | 16.09 | |
| | | 1857.5 (26115) | 18.35 | 17.72 | 16.68 | |
| | 1RB-Low (0) | 1907.5 (26615) | 18.50 | 17.31 | 16.78 | |
| | | 1882.5 (26365) | 18.27 | 17.60 | 16.15 | |
| | | 1857.5 (26115) | 18.34 | 17.76 | 16.70 | |
| | 36RB-High (38) | 1907.5 (26615) | 17.61 | 16.50 | 15.51 | |
| | | 1882.5 (26365) | 17.24 | 16.34 | 15.25 | |
| | | 1857.5 (26115) | 17.47 | 16.43 | 15.55 | |
| | 36RB-Middle (19) | 1907.5 (26615) | 17.50 | 16.43 | 15.48 | |
| | | 1882.5 (26365) | 17.26 | 16.31 | 15.26 | |
| | | 1857.5 (26115) | 17.40 | 16.38 | 15.46 | |
| | 36RB-Low (0) | 1907.5 (26615) | 17.61 | 16.60 | 15.48 | |
| | | 1882.5 (26365) | 17.13 | 16.25 | 15.21 | |
| | | 1857.5 (26115) | 17.43 | 16.39 | 15.53 | |
| | 75RB (0) | 1907.5 (26615) | 17.50 | 16.62 | 15.48 | |
| | | 1882.5 (26365) | 17.24 | 16.28 | 15.35 | |
| | | 1857.5 (26115) | 17.43 | 16.36 | 15.47 | |
| | 20MHz | 1RB-High (99) | 1905 (26590) | 18.15 | 17.62 | 16.54 |
| | | | 1882.5 (26365) | 17.91 | 17.32 | 16.38 |
| | | | 1860 (26140) | 18.03 | 17.52 | 16.44 |
| | | 1RB-Middle (50) | 1905 (26590) | 18.51 | 17.88 | 16.90 |
| | | | 1882.5 (26365) | 18.13 | 17.57 | 16.60 |
| | | | 1860 (26140) | 18.36 | 17.80 | 16.78 |
| 1RB-Low (0) | | 1905 (26590) | 18.48 | 17.99 | 16.81 | |
| | | 1882.5 (26365) | 18.08 | 17.49 | 16.60 | |
| | | 1860 (26140) | 18.31 | 17.82 | 16.68 | |
| 50RB-High (50) | | 1905 (26590) | 17.47 | 16.50 | 15.42 | |
| | | 1882.5 (26365) | 17.11 | 16.11 | 15.25 | |
| | | 1860 (26140) | 17.32 | 16.33 | 15.32 | |
| 50RB-Middle (25) | | 1905 (26590) | 17.48 | 16.49 | 15.36 | |
| | | 1882.5 (26365) | 17.17 | 16.17 | 15.29 | |
| | | 1860 (26140) | 17.30 | 16.36 | 15.40 | |
| 50RB-Low (0) | | 1905 (26590) | 17.39 | 16.40 | 15.34 | |
| | | 1882.5 (26365) | 17.19 | 16.19 | 15.23 | |
| | | 1860 (26140) | 17.36 | 16.30 | 15.38 | |
| 100RB (0) | | 1905 (26590) | 17.56 | 16.56 | 15.47 | |
| | | 1882.5 (26365) | 17.15 | 16.15 | 15.19 | |
| | | 1860 (26140) | 17.31 | 16.26 | 15.33 | |

| Band41(PC3)-Low power | | | | | | |
|-----------------------|-----------------|-----------------|----------------|-------|-------|-------|
| BANDWIDTH | Number of RBs | Frequency | QPSK | 16QAM | 64QAM | |
| 5MHz | 1RB-High (24) | 2687.5 (41565) | 22.36 | 21.28 | 20.18 | |
| | | 2640.3(41093) | 22.27 | 21.25 | 20.11 | |
| | | 2593 (40620) | 22.50 | 21.33 | 20.30 | |
| | | 2545.8(40148) | 22.52 | 21.27 | 20.25 | |
| | 1RB-Middle (12) | 2498.5 (39675) | 22.42 | 21.53 | 20.30 | |
| | | 2687.5 (41565) | 22.38 | 21.17 | 20.11 | |
| | | 2640.3(41093) | 22.28 | 21.30 | 20.14 | |
| | | 2593 (40620) | 22.79 | 21.24 | 20.30 | |
| | 1RB-Low (0) | 2545.8(40148) | 22.52 | 21.34 | 20.27 | |
| | | 2498.5 (39675) | 22.39 | 21.41 | 20.36 | |
| | | 2687.5 (41565) | 22.53 | 21.42 | 20.13 | |
| | | 2640.3(41093) | 22.47 | 21.44 | 20.32 | |
| | 12RB-High (13) | 2593 (40620) | 22.61 | 21.42 | 20.36 | |
| | | 2545.8(40148) | 22.54 | 21.43 | 20.28 | |
| | | 2498.5 (39675) | 22.53 | 21.61 | 20.37 | |
| | | 2687.5 (41565) | 21.23 | 20.27 | 19.86 | |
| | 12RB-Middle (6) | 2640.3(41093) | 21.13 | 20.20 | 19.79 | |
| | | 2593 (40620) | 21.33 | 20.39 | 19.98 | |
| | | 2545.8(40148) | 21.34 | 20.34 | 19.93 | |
| | | 2498.5 (39675) | 21.32 | 20.39 | 19.98 | |
| | 12RB-Low (0) | 2687.5 (41565) | 21.20 | 20.20 | 19.80 | |
| | | 2640.3(41093) | 21.15 | 20.23 | 19.82 | |
| | | 2593 (40620) | 21.37 | 20.39 | 19.98 | |
| | | 2545.8(40148) | 21.42 | 20.36 | 19.95 | |
| | 25RB (0) | 2498.5 (39675) | 21.36 | 20.45 | 20.04 | |
| | | 2687.5 (41565) | 21.24 | 20.22 | 19.82 | |
| | | 2640.3(41093) | 21.33 | 20.41 | 20.00 | |
| | | 2593 (40620) | 21.41 | 20.45 | 20.04 | |
| | 10MHz | 1RB-High (49) | 2545.8(40148) | 21.44 | 20.37 | 19.96 |
| | | | 2498.5 (39675) | 21.40 | 20.46 | 20.04 |
| | | | 2687.5 (41565) | 21.18 | 20.26 | 19.85 |
| | | | 2640.3(41093) | 21.19 | 20.20 | 19.80 |
| | | 1RB-Middle (24) | 2593 (40620) | 21.47 | 20.38 | 19.96 |
| | | | 2545.8(40148) | 21.36 | 20.46 | 20.05 |
| | | | 2639(41080) | 22.06 | 21.45 | 20.15 |
| | | | 2685 (41540) | 22.06 | 21.45 | 20.15 |
| 1RB-Low (0) | | 2639(41080) | 22.39 | 21.34 | 20.27 | |
| | | 2593 (40620) | 22.39 | 21.42 | 20.28 | |
| | | 2547(40160) | 22.60 | 21.65 | 20.32 | |
| | | 2501 (39700) | 22.61 | 21.48 | 20.38 | |
| 25RB-High (25) | 2685 (41540) | 22.54 | 21.38 | 20.19 | | |
| | 2639(41080) | 22.46 | 21.22 | 20.33 | | |
| | 2593 (40620) | 22.47 | 21.29 | 20.27 | | |
| | 2547(40160) | 22.45 | 21.41 | 20.32 | | |
| 25RB-Middle (12) | 2501 (39700) | 22.35 | 21.27 | 20.31 | | |
| | 2685 (41540) | 22.17 | 21.40 | 20.26 | | |
| | 2639(41080) | 22.34 | 21.36 | 20.28 | | |
| | 2593 (40620) | 22.27 | 21.37 | 20.30 | | |
| 25RB-Low (0) | 2547(40160) | 22.46 | 21.72 | 20.31 | | |
| | 2501 (39700) | 22.56 | 21.48 | 20.22 | | |
| | 2685 (41540) | 21.27 | 20.24 | 19.77 | | |
| | 2639(41080) | 21.31 | 20.36 | 19.88 | | |
| 50RB (0) | 2593 (40620) | 21.40 | 20.37 | 19.89 | | |
| | 2547(40160) | 21.46 | 20.42 | 19.94 | | |
| | 2501 (39700) | 21.48 | 20.47 | 20.00 | | |
| | 2685 (41540) | 21.26 | 20.28 | 19.80 | | |
| 50RB (0) | 2639(41080) | 21.41 | 20.42 | 19.94 | | |
| | 2593 (40620) | 21.41 | 20.36 | 19.89 | | |
| | 2547(40160) | 21.39 | 20.42 | 19.94 | | |
| | 2501 (39700) | 21.44 | 20.40 | 19.93 | | |
| | 2685 (41540) | 21.35 | 20.35 | 19.88 | | |
| | 2639(41080) | 21.37 | 20.37 | 19.90 | | |
| | 2593 (40620) | 21.44 | 20.39 | 19.91 | | |
| | 2547(40160) | 21.39 | 20.40 | 19.93 | | |
| 50RB (0) | 2501 (39700) | 21.38 | 20.31 | 19.83 | | |
| | 2685 (41540) | 21.30 | 20.32 | 19.85 | | |
| | 2639(41080) | 21.43 | 20.38 | 19.90 | | |
| | 2593 (40620) | 21.43 | 20.41 | 19.94 | | |
| 50RB (0) | 2547(40160) | 21.51 | 20.54 | 20.07 | | |
| | 2501 (39700) | 21.40 | 20.38 | 19.90 | | |
| | 2685 (41540) | 21.30 | 20.32 | 19.85 | | |
| | 2639(41080) | 21.43 | 20.38 | 19.90 | | |

| | | | | | | |
|------------------|------------------|----------------|---------------|-------|-------|-------|
| 15MHz | 1RB-High (74) | 2682.5 (41515) | 22.58 | 21.54 | 20.37 | |
| | | 2637.8(41068) | 22.47 | 21.54 | 20.40 | |
| | | 2593 (40620) | 22.73 | 21.64 | 20.51 | |
| | | 2548.3(40173) | 22.73 | 21.76 | 20.68 | |
| | | 2503.5 (39725) | 22.72 | 21.93 | 20.58 | |
| | 1RB-Middle (37) | 2682.5 (41515) | 22.45 | 21.42 | 20.38 | |
| | | 2637.8(41068) | 22.47 | 21.50 | 20.44 | |
| | | 2593 (40620) | 22.60 | 21.52 | 20.58 | |
| | | 2548.3(40173) | 22.69 | 21.65 | 20.65 | |
| | | 2503.5 (39725) | 22.66 | 21.79 | 20.65 | |
| | 1RB-Low (0) | 2682.5 (41515) | 22.65 | 21.58 | 20.32 | |
| | | 2637.8(41068) | 22.23 | 21.28 | 20.33 | |
| | | 2593 (40620) | 22.39 | 21.33 | 20.34 | |
| | | 2548.3(40173) | 22.93 | 21.89 | 20.57 | |
| | | 2503.5 (39725) | 22.88 | 21.99 | 20.67 | |
| | 36RB-High (38) | 2682.5 (41515) | 21.45 | 20.42 | 19.69 | |
| | | 2637.8(41068) | 21.43 | 20.45 | 19.72 | |
| | | 2593 (40620) | 21.59 | 20.56 | 19.82 | |
| | | 2548.3(40173) | 21.78 | 20.73 | 19.99 | |
| | | 2503.5 (39725) | 21.72 | 20.63 | 19.90 | |
| | 36RB-Middle (19) | 2682.5 (41515) | 21.49 | 20.43 | 19.70 | |
| | | 2637.8(41068) | 21.46 | 20.49 | 19.76 | |
| | | 2593 (40620) | 21.58 | 20.63 | 19.89 | |
| | | 2548.3(40173) | 21.67 | 20.71 | 19.97 | |
| | | 2503.5 (39725) | 21.71 | 20.70 | 19.96 | |
| | 36RB-Low (0) | 2682.5 (41515) | 21.39 | 20.37 | 19.64 | |
| | | 2637.8(41068) | 21.35 | 20.38 | 19.65 | |
| | | 2593 (40620) | 21.37 | 20.39 | 19.66 | |
| | | 2548.3(40173) | 21.62 | 20.62 | 19.89 | |
| | | 2503.5 (39725) | 21.71 | 20.72 | 19.98 | |
| | 75RB (0) | 2682.5 (41515) | 21.44 | 20.36 | 19.64 | |
| | | 2637.8(41068) | 21.39 | 20.40 | 19.67 | |
| | | 2593 (40620) | 21.51 | 20.49 | 19.76 | |
| | | 2548.3(40173) | 21.68 | 20.65 | 19.91 | |
| | | 2503.5 (39725) | 21.69 | 20.66 | 19.92 | |
| | 20MHz | 1RB-High (99) | 2680 (41490) | 22.40 | 21.49 | 20.24 |
| | | | 2636.5(41055) | 22.71 | 21.42 | 20.39 |
| | | | 2593 (40620) | 22.75 | 21.79 | 20.52 |
| | | | 2549.5(40185) | 22.58 | 21.65 | 20.56 |
| | | | 2506 (39750) | 22.97 | 21.71 | 20.52 |
| 1RB-Middle (50) | | 2680 (41490) | 22.15 | 21.43 | 20.28 | |
| | | 2636.5(41055) | 22.73 | 21.39 | 20.43 | |
| | | 2593 (40620) | 22.69 | 21.68 | 20.54 | |
| | | 2549.5(40185) | 22.63 | 21.63 | 20.50 | |
| | | 2506 (39750) | 22.95 | 21.75 | 20.61 | |
| 1RB-Low (0) | | 2680 (41490) | 22.35 | 21.46 | 20.29 | |
| | | 2636.5(41055) | 22.44 | 21.17 | 20.28 | |
| | | 2593 (40620) | 22.46 | 21.53 | 20.41 | |
| | | 2549.5(40185) | 22.75 | 21.71 | 20.59 | |
| | | 2506 (39750) | 22.87 | 21.66 | 20.60 | |
| 50RB-High (50) | | 2680 (41490) | 21.35 | 20.33 | 19.71 | |
| | | 2636.5(41055) | 21.46 | 20.48 | 19.85 | |
| | | 2593 (40620) | 21.61 | 20.61 | 19.98 | |
| | | 2549.5(40185) | 21.69 | 20.65 | 20.02 | |
| | | 2506 (39750) | 21.63 | 20.61 | 19.99 | |
| 50RB-Middle (25) | | 2680 (41490) | 21.36 | 20.37 | 19.75 | |
| | | 2636.5(41055) | 21.49 | 20.52 | 19.89 | |
| | | 2593 (40620) | 21.61 | 20.63 | 20.00 | |
| | | 2549.5(40185) | 21.58 | 20.59 | 19.96 | |
| | | 2506 (39750) | 21.72 | 20.70 | 20.07 | |
| 50RB-Low (0) | | 2680 (41490) | 21.42 | 20.38 | 19.76 | |
| | | 2636.5(41055) | 21.40 | 20.37 | 19.75 | |
| | | 2593 (40620) | 21.52 | 20.50 | 19.87 | |
| | | 2549.5(40185) | 21.68 | 20.68 | 20.05 | |
| | | 2506 (39750) | 21.71 | 20.69 | 20.06 | |
| 100RB (0) | | 2680 (41490) | 21.43 | 20.38 | 19.76 | |
| | | 2636.5(41055) | 21.40 | 20.44 | 19.82 | |
| | | 2593 (40620) | 21.60 | 20.60 | 19.97 | |
| | | 2549.5(40185) | 21.62 | 20.62 | 19.99 | |
| | | 2506 (39750) | 21.71 | 20.71 | 20.08 | |

| Band41(PC2)-Low power | | | | | | |
|-----------------------|-----------------|----------------|----------------|-------|-------|-------|
| BANDWIDTH | Number of RBs | Frequency | QPSK | 16QAM | 64QAM | |
| 5MHz | 1RB-High (24) | 2687.5 (41565) | 23.32 | 22.56 | 21.53 | |
| | | 2640.3(41093) | 23.18 | 22.32 | 21.30 | |
| | | 2593 (40620) | 23.33 | 22.44 | 21.42 | |
| | | 2545.8(40148) | 23.27 | 22.45 | 21.42 | |
| | 1RB-Middle (12) | 2498.5 (39675) | 23.32 | 22.68 | 21.65 | |
| | | 2687.5 (41565) | 23.36 | 22.44 | 21.41 | |
| | | 2640.3(41093) | 23.13 | 22.26 | 21.24 | |
| | | 2593 (40620) | 23.39 | 22.45 | 21.42 | |
| | 1RB-Low (0) | 2545.8(40148) | 23.21 | 22.43 | 21.41 | |
| | | 2498.5 (39675) | 23.30 | 22.59 | 21.56 | |
| | | 2687.5 (41565) | 23.30 | 22.47 | 21.44 | |
| | | 2640.3(41093) | 23.08 | 22.51 | 21.48 | |
| | 12RB-High (13) | 2593 (40620) | 23.31 | 22.48 | 21.45 | |
| | | 2545.8(40148) | 23.36 | 22.62 | 21.58 | |
| | | 2498.5 (39675) | 23.40 | 22.68 | 21.64 | |
| | | 2687.5 (41565) | 22.20 | 21.18 | 20.21 | |
| | 12RB-Middle (6) | 2640.3(41093) | 22.01 | 21.12 | 20.15 | |
| | | 2593 (40620) | 22.26 | 21.30 | 20.32 | |
| | | 2545.8(40148) | 22.21 | 21.19 | 20.22 | |
| | | 2498.5 (39675) | 22.25 | 21.36 | 20.38 | |
| | 12RB-Low (0) | 2687.5 (41565) | 22.12 | 21.10 | 20.14 | |
| | | 2640.3(41093) | 22.06 | 21.15 | 20.18 | |
| | | 2593 (40620) | 22.32 | 21.26 | 20.29 | |
| | | 2545.8(40148) | 22.24 | 21.20 | 20.23 | |
| | 25RB (0) | 2498.5 (39675) | 22.31 | 21.44 | 20.45 | |
| | | 2687.5 (41565) | 22.20 | 21.23 | 20.26 | |
| | | 2640.3(41093) | 22.05 | 21.21 | 20.24 | |
| | | 2593 (40620) | 22.25 | 21.28 | 20.30 | |
| | 25RB (0) | 2545.8(40148) | 22.26 | 21.24 | 20.27 | |
| | | 2498.5 (39675) | 22.30 | 21.41 | 20.42 | |
| | | 2687.5 (41565) | 22.14 | 21.15 | 20.18 | |
| | | 2640.3(41093) | 22.09 | 21.09 | 20.13 | |
| | 10MHz | 1RB-High (49) | 2593 (40620) | 22.29 | 21.31 | 20.33 |
| | | | 2545.8(40148) | 22.18 | 21.23 | 20.26 |
| | | | 2498.5 (39675) | 22.24 | 21.21 | 20.24 |
| | | | 2685 (41540) | 23.03 | 22.51 | 21.48 |
| 1RB-Middle (24) | | 2639(41080) | 23.25 | 22.67 | 21.63 | |
| | | 2593 (40620) | 23.38 | 22.55 | 21.51 | |
| | | 2547(40160) | 23.29 | 22.71 | 21.67 | |
| | | 2501 (39700) | 23.31 | 22.64 | 21.60 | |
| 1RB-Low (0) | | 2685 (41540) | 23.02 | 22.58 | 21.55 | |
| | | 2639(41080) | 23.09 | 22.39 | 21.37 | |
| | | 2593 (40620) | 23.25 | 22.46 | 21.43 | |
| | | 2547(40160) | 23.20 | 22.62 | 21.58 | |
| 25RB-High (25) | | 2501 (39700) | 23.20 | 22.61 | 21.58 | |
| | | 2685 (41540) | 23.01 | 22.54 | 21.51 | |
| | | 2639(41080) | 23.10 | 22.55 | 21.52 | |
| | | 2593 (40620) | 23.31 | 22.48 | 21.45 | |
| 25RB-Middle (12) | | 2547(40160) | 23.38 | 22.79 | 21.75 | |
| | | 2501 (39700) | 23.26 | 22.85 | 21.81 | |
| | | 2685 (41540) | 22.12 | 21.15 | 20.18 | |
| | | 2639(41080) | 22.21 | 21.23 | 20.25 | |
| 25RB-Low (0) | | 2593 (40620) | 22.30 | 21.31 | 20.34 | |
| | | 2547(40160) | 22.21 | 21.22 | 20.24 | |
| | | 2501 (39700) | 22.29 | 21.32 | 20.34 | |
| | | 2685 (41540) | 22.20 | 21.19 | 20.22 | |
| 50RB (0) | | 2639(41080) | 22.19 | 21.18 | 20.20 | |
| | | 2593 (40620) | 22.30 | 21.32 | 20.35 | |
| | | 2547(40160) | 22.26 | 21.26 | 20.28 | |
| | | 2501 (39700) | 22.33 | 21.41 | 20.43 | |
| 50RB (0) | | 2685 (41540) | 22.22 | 21.25 | 20.28 | |
| | | 2639(41080) | 22.13 | 21.15 | 20.18 | |
| | | 2593 (40620) | 22.17 | 21.15 | 20.18 | |
| | | 2547(40160) | 22.24 | 21.27 | 20.30 | |
| 50RB (0) | | 2501 (39700) | 22.27 | 21.26 | 20.29 | |
| | | 2685 (41540) | 22.16 | 21.17 | 20.20 | |
| | | 2639(41080) | 22.17 | 21.22 | 20.25 | |
| | | 2593 (40620) | 22.28 | 21.29 | 20.32 | |
| 50RB (0) | | 2547(40160) | 22.25 | 21.26 | 20.28 | |
| | | 2501 (39700) | 22.36 | 21.37 | 20.39 | |



| | | | | | |
|------------------|------------------|----------------|-------|-------|-------|
| 15MHz | 1RB-High (74) | 2682.5 (41515) | 23.37 | 22.73 | 21.69 |
| | | 2637.8(41068) | 23.42 | 22.73 | 21.69 |
| | | 2593 (40620) | 23.63 | 22.72 | 21.68 |
| | | 2548.3(40173) | 23.54 | 22.85 | 21.80 |
| | 1RB-Middle (37) | 2503.5 (39725) | 23.58 | 22.94 | 21.89 |
| | | 2682.5 (41515) | 23.36 | 22.68 | 21.64 |
| | | 2637.8(41068) | 23.32 | 22.64 | 21.60 |
| | | 2593 (40620) | 23.56 | 22.60 | 21.56 |
| | 1RB-Low (0) | 2548.3(40173) | 23.55 | 22.93 | 21.88 |
| | | 2503.5 (39725) | 23.38 | 22.72 | 21.68 |
| | | 2682.5 (41515) | 23.53 | 22.91 | 21.86 |
| | | 2637.8(41068) | 23.14 | 22.47 | 21.44 |
| | 36RB-High (38) | 2593 (40620) | 23.41 | 22.51 | 21.48 |
| | | 2548.3(40173) | 23.67 | 22.97 | 21.97 |
| | | 2503.5 (39725) | 23.64 | 22.98 | 21.98 |
| | | 2682.5 (41515) | 22.23 | 21.22 | 20.25 |
| | 36RB-Middle (19) | 2637.8(41068) | 22.40 | 21.38 | 20.40 |
| | | 2593 (40620) | 22.43 | 21.45 | 20.47 |
| | | 2548.3(40173) | 22.48 | 21.50 | 20.52 |
| | | 2503.5 (39725) | 22.61 | 21.51 | 20.52 |
| | 36RB-Low (0) | 2682.5 (41515) | 22.28 | 21.27 | 20.29 |
| | | 2637.8(41068) | 22.36 | 21.38 | 20.40 |
| | | 2593 (40620) | 22.49 | 21.48 | 20.49 |
| | | 2548.3(40173) | 22.54 | 21.56 | 20.57 |
| | 75RB (0) | 2503.5 (39725) | 22.53 | 21.51 | 20.53 |
| | | 2682.5 (41515) | 22.26 | 21.29 | 20.31 |
| | | 2637.8(41068) | 22.20 | 21.16 | 20.19 |
| | | 2593 (40620) | 22.23 | 21.30 | 20.33 |
| 20MHz | 1RB-High (99) | 2548.3(40173) | 22.51 | 21.60 | 20.61 |
| | | 2503.5 (39725) | 22.58 | 21.61 | 20.62 |
| | | 2682.5 (41515) | 22.28 | 21.20 | 20.23 |
| | | 2637.8(41068) | 22.30 | 21.30 | 20.32 |
| | 1RB-Middle (50) | 2593 (40620) | 22.31 | 21.36 | 20.38 |
| | | 2548.3(40173) | 22.56 | 21.54 | 20.55 |
| | | 2503.5 (39725) | 22.56 | 21.57 | 20.58 |
| | | 2680 (41490) | 23.53 | 22.73 | 21.69 |
| | 1RB-Low (0) | 2636.5(41055) | 23.46 | 22.69 | 21.65 |
| | | 2593 (40620) | 23.80 | 22.89 | 21.84 |
| | | 2549.5(40185) | 23.55 | 22.73 | 21.69 |
| | | 2506 (39750) | 23.51 | 22.70 | 21.66 |
| 50RB-High (50) | 2680 (41490) | 23.50 | 22.68 | 21.64 | |
| | 2636.5(41055) | 23.33 | 22.62 | 21.58 | |
| | 2593 (40620) | 23.52 | 22.75 | 21.71 | |
| | 2549.5(40185) | 23.62 | 22.71 | 21.67 | |
| 50RB-Middle (25) | 2506 (39750) | 23.55 | 22.67 | 21.63 | |
| | 2680 (41490) | 23.51 | 22.72 | 21.68 | |
| | 2636.5(41055) | 23.15 | 22.30 | 21.28 | |
| | 2593 (40620) | 23.30 | 22.69 | 21.65 | |
| 50RB-Low (0) | 2549.5(40185) | 23.57 | 22.75 | 21.71 | |
| | 2506 (39750) | 23.55 | 22.68 | 21.64 | |
| | 2680 (41490) | 22.19 | 21.15 | 20.18 | |
| | 2636.5(41055) | 22.39 | 21.40 | 20.42 | |
| 100RB (0) | 2593 (40620) | 22.77 | 21.44 | 20.45 | |
| | 2549.5(40185) | 22.38 | 21.42 | 20.44 | |
| | 2506 (39750) | 22.50 | 21.40 | 20.42 | |
| | 2680 (41490) | 22.31 | 21.26 | 20.29 | |
| 50RB-High (50) | 2636.5(41055) | 22.40 | 21.36 | 20.38 | |
| | 2593 (40620) | 22.46 | 21.51 | 20.52 | |
| | 2549.5(40185) | 22.61 | 21.55 | 20.56 | |
| | 2506 (39750) | 22.50 | 21.59 | 20.60 | |
| 50RB-Middle (25) | 2680 (41490) | 22.29 | 21.26 | 20.28 | |
| | 2636.5(41055) | 22.28 | 21.31 | 20.33 | |
| | 2593 (40620) | 22.38 | 21.46 | 20.48 | |
| | 2549.5(40185) | 22.58 | 21.54 | 20.55 | |
| 50RB-Low (0) | 2506 (39750) | 22.51 | 21.43 | 20.45 | |
| | 2680 (41490) | 22.25 | 21.21 | 20.24 | |
| | 2636.5(41055) | 22.37 | 21.35 | 20.37 | |
| | 2593 (40620) | 22.51 | 21.48 | 20.50 | |
| 100RB (0) | 2549.5(40185) | 22.44 | 21.49 | 20.50 | |
| | 2506 (39750) | 22.52 | 21.44 | 20.46 | |

| Band66-Low power | | | | | |
|------------------|----------------|-----------------|-------|-------|-------|
| BANDWIDTH | Number of RBs | Frequency | QPSK | 16QAM | 64QAM |
| 1.4MHz | 1RB-High (5) | 1779.3 (132665) | 18.45 | 17.52 | 16.28 |
| | | 1745 (132322) | 18.29 | 17.33 | 16.27 |
| | | 1710.7 (131979) | 18.15 | 17.68 | 16.17 |
| | 1RB-Middle (3) | 1779.3 (132665) | 18.48 | 17.44 | 16.51 |
| | | 1745 (132322) | 18.36 | 17.41 | 16.25 |
| | | 1710.7 (131979) | 18.28 | 17.69 | 16.20 |
| | 1RB-Low (0) | 1779.3 (132665) | 18.44 | 17.49 | 16.49 |
| | | 1745 (132322) | 18.36 | 17.44 | 16.26 |
| | | 1710.7 (131979) | 18.18 | 17.77 | 16.19 |
| | 3RB-High (3) | 1779.3 (132665) | 18.48 | 17.66 | 16.48 |
| | | 1745 (132322) | 18.30 | 17.37 | 16.36 |
| | | 1710.7 (131979) | 18.16 | 17.25 | 16.18 |
| | 3RB-Middle (1) | 1779.3 (132665) | 18.44 | 17.76 | 16.50 |
| | | 1745 (132322) | 18.35 | 17.37 | 16.42 |
| | | 1710.7 (131979) | 18.17 | 17.44 | 16.19 |
| | 3RB-Low (0) | 1779.3 (132665) | 18.41 | 17.69 | 16.52 |
| | | 1745 (132322) | 18.31 | 17.36 | 16.40 |
| | | 1710.7 (131979) | 18.13 | 17.31 | 16.13 |
| | 6RB (0) | 1779.3 (132665) | 17.43 | 16.58 | 15.26 |
| | | 1745 (132322) | 17.27 | 16.36 | 15.41 |
| | | 1710.7 (131979) | 17.08 | 16.05 | 15.18 |
| 3MHz | 1RB-High (14) | 1778.5 (132657) | 18.50 | 17.52 | 16.82 |
| | | 1745 (132322) | 18.37 | 17.28 | 16.32 |
| | | 1711.5 (131987) | 18.29 | 17.69 | 16.11 |
| | 1RB-Middle (7) | 1778.5 (132657) | 18.40 | 17.62 | 16.89 |
| | | 1745 (132322) | 18.36 | 17.32 | 16.32 |
| | | 1711.5 (131987) | 18.23 | 17.75 | 16.24 |
| | 1RB-Low (0) | 1778.5 (132657) | 18.57 | 17.54 | 16.88 |
| | | 1745 (132322) | 18.34 | 17.24 | 16.37 |
| | | 1711.5 (131987) | 18.27 | 17.82 | 16.11 |
| | 8RB-High (7) | 1778.5 (132657) | 17.43 | 16.47 | 15.46 |
| | | 1745 (132322) | 17.34 | 16.35 | 15.28 |
| | | 1711.5 (131987) | 17.27 | 16.33 | 15.28 |
| | 8RB-Middle (4) | 1778.5 (132657) | 17.49 | 16.55 | 15.55 |
| | | 1745 (132322) | 17.35 | 16.46 | 15.36 |
| | | 1711.5 (131987) | 17.21 | 16.40 | 15.29 |
| | 8RB-Low (0) | 1778.5 (132657) | 17.47 | 16.49 | 15.54 |
| | | 1745 (132322) | 17.41 | 16.44 | 15.35 |
| | | 1711.5 (131987) | 17.23 | 16.33 | 15.28 |
| | 15RB (0) | 1778.5 (132657) | 17.43 | 16.38 | 15.47 |
| | | 1745 (132322) | 17.35 | 16.38 | 15.21 |
| | | 1711.5 (131987) | 17.24 | 16.25 | 15.26 |

| | | | | | | |
|------------------|-----------------|-----------------|---------------|-------|-------|-------|
| 5MHz | 1RB-High (24) | 1777.5 (132647) | 18.53 | 17.66 | 16.47 | |
| | | 1745 (132322) | 18.45 | 17.56 | 16.61 | |
| | | 1712.5 (131997) | 18.15 | 17.72 | 16.25 | |
| | 1RB-Middle (12) | 1777.5 (132647) | 18.21 | 17.70 | 16.43 | |
| | | 1745 (132322) | 18.51 | 17.49 | 16.60 | |
| | | 1712.5 (131997) | 17.91 | 17.79 | 16.36 | |
| | 1RB-Low (0) | 1777.5 (132647) | 18.69 | 17.84 | 16.63 | |
| | | 1745 (132322) | 18.59 | 17.67 | 16.67 | |
| | | 1712.5 (131997) | 18.26 | 17.77 | 16.38 | |
| | 12RB-High (13) | 1777.5 (132647) | 17.44 | 16.45 | 15.32 | |
| | | 1745 (132322) | 17.38 | 16.43 | 15.31 | |
| | | 1712.5 (131997) | 17.18 | 16.30 | 15.03 | |
| | 12RB-Middle (6) | 1777.5 (132647) | 17.49 | 16.52 | 15.41 | |
| | | 1745 (132322) | 17.39 | 16.46 | 15.34 | |
| | | 1712.5 (131997) | 17.28 | 16.38 | 15.17 | |
| | 12RB-Low (0) | 1777.5 (132647) | 17.59 | 16.61 | 15.43 | |
| | | 1745 (132322) | 17.35 | 16.44 | 15.32 | |
| | | 1712.5 (131997) | 17.29 | 16.36 | 15.19 | |
| | 25RB (0) | 1777.5 (132647) | 17.49 | 16.43 | 15.29 | |
| | | 1745 (132322) | 17.33 | 16.35 | 15.21 | |
| | | 1712.5 (131997) | 17.30 | 16.33 | 15.10 | |
| | 10MHz | 1RB-High (49) | 1775 (132622) | 18.85 | 17.88 | 16.73 |
| | | | 1745 (132322) | 18.87 | 17.76 | 16.96 |
| | | | 1715 (132022) | 18.75 | 18.18 | 16.56 |
| 1RB-Middle (24) | | 1775 (132622) | 18.36 | 17.39 | 16.10 | |
| | | 1745 (132322) | 18.29 | 17.22 | 16.55 | |
| | | 1715 (132022) | 18.26 | 17.70 | 16.20 | |
| 1RB-Low (0) | | 1775 (132622) | 17.79 | 16.87 | 16.00 | |
| | | 1745 (132322) | 17.68 | 16.63 | 15.95 | |
| | | 1715 (132022) | 17.62 | 16.97 | 15.97 | |
| 25RB-High (25) | | 1775 (132622) | 17.59 | 16.62 | 15.38 | |
| | | 1745 (132322) | 17.42 | 16.54 | 15.38 | |
| | | 1715 (132022) | 17.38 | 16.41 | 15.40 | |
| 25RB-Middle (12) | | 1775 (132622) | 17.47 | 16.54 | 15.37 | |
| | | 1745 (132322) | 17.36 | 16.38 | 15.33 | |
| | | 1715 (132022) | 17.31 | 16.31 | 15.30 | |
| 25RB-Low (0) | | 1775 (132622) | 17.40 | 16.53 | 15.33 | |
| | | 1745 (132322) | 17.30 | 16.33 | 15.24 | |
| | | 1715 (132022) | 17.23 | 16.18 | 15.26 | |
| 50RB (0) | | 1775 (132622) | 17.43 | 16.47 | 15.33 | |
| | | 1745 (132322) | 17.43 | 16.36 | 15.30 | |
| | | 1715 (132022) | 17.33 | 16.38 | 15.31 | |

| | | | | | |
|-------|------------------|-----------------|-------|-------|-------|
| 15MHz | 1RB-High (74) | 1772.5 (132597) | 18.40 | 17.36 | 16.75 |
| | | 1745 (132322) | 18.43 | 17.86 | 16.20 |
| | | 1717.5 (132047) | 18.44 | 17.89 | 16.79 |
| | 1RB-Middle (37) | 1772.5 (132597) | 18.39 | 17.26 | 16.64 |
| | | 1745 (132322) | 18.28 | 17.69 | 16.06 |
| | | 1717.5 (132047) | 18.30 | 17.76 | 16.61 |
| | 1RB-Low (0) | 1772.5 (132597) | 18.57 | 17.43 | 16.79 |
| | | 1745 (132322) | 18.39 | 17.86 | 16.19 |
| | | 1717.5 (132047) | 18.54 | 17.94 | 16.78 |
| | 36RB-High (38) | 1772.5 (132597) | 17.34 | 16.28 | 15.17 |
| | | 1745 (132322) | 17.17 | 16.27 | 15.05 |
| | | 1717.5 (132047) | 17.22 | 16.20 | 15.09 |
| | 36RB-Middle (19) | 1772.5 (132597) | 17.41 | 16.34 | 15.29 |
| | | 1745 (132322) | 17.20 | 16.33 | 15.16 |
| | | 1717.5 (132047) | 17.19 | 16.18 | 15.12 |
| | 36RB-Low (0) | 1772.5 (132597) | 17.46 | 16.40 | 15.31 |
| | | 1745 (132322) | 17.26 | 16.31 | 15.16 |
| | | 1717.5 (132047) | 17.21 | 16.27 | 15.14 |
| | 75RB (0) | 1772.5 (132597) | 17.35 | 16.34 | 15.20 |
| | | 1745 (132322) | 17.23 | 16.30 | 15.15 |
| | | 1717.5 (132047) | 17.13 | 16.07 | 15.17 |
| 20MHz | 1RB-High (99) | 1770 (132572) | 18.44 | 18.13 | 16.94 |
| | | 1745 (132322) | 18.71 | 18.19 | 17.03 |
| | | 1720 (132072) | 18.70 | 18.16 | 17.00 |
| | 1RB-Middle (50) | 1770 (132572) | 18.15 | 17.81 | 16.49 |
| | | 1745 (132322) | 18.24 | 17.63 | 16.52 |
| | | 1720 (132072) | 18.21 | 17.73 | 16.60 |
| | 1RB-Low (0) | 1770 (132572) | 17.90 | 17.51 | 16.42 |
| | | 1745 (132322) | 17.83 | 17.42 | 16.24 |
| | | 1720 (132072) | 17.99 | 17.50 | 16.34 |
| | 50RB-High (50) | 1770 (132572) | 17.29 | 16.27 | 15.25 |
| | | 1745 (132322) | 17.33 | 16.28 | 15.17 |
| | | 1720 (132072) | 17.32 | 16.28 | 15.24 |
| | 50RB-Middle (25) | 1770 (132572) | 17.32 | 16.32 | 15.29 |
| | | 1745 (132322) | 17.25 | 16.27 | 15.16 |
| | | 1720 (132072) | 17.21 | 16.21 | 15.18 |
| | 50RB-Low (0) | 1770 (132572) | 17.26 | 16.22 | 15.17 |
| | | 1745 (132322) | 17.06 | 16.13 | 15.02 |
| | | 1720 (132072) | 17.11 | 16.08 | 15.14 |
| | 100RB (0) | 1770 (132572) | 17.22 | 16.26 | 15.18 |
| | | 1745 (132322) | 17.19 | 16.18 | 15.10 |
| | | 1720 (132072) | 17.17 | 16.16 | 15.10 |



The conducted power measurement results of downlink LTE CA Conduced Power are as below (2CA):

| DL LTE CA Class | PCC | | | | | | | | SCC | | | Power | | |
|-----------------|----------|---------------------|----------------|------------------|----------------|------------------|-----------|-----------|----------|-------------------|----------------|--------------|-----------------|---------|
| | PCC Band | PCC Bandwidth (MHz) | PCC UL RB size | PCC UL RB offset | PCC DL RB size | PCC DL RB offset | C UL Char | C DL Char | SCC Band | C Bandwidth (MHz) | SCC DL Channel | LTE Tx Power | LTE CA Tx Power | Tune-up |
| | | | | | | | | | | | | | | |
| CA_25A-25A | 25 | 20 | 1 | 0 | 0 | 1 | 26140 | 8140 | 25 | 20 | 8590 | 23.53 | 23.45 | 25 |
| CA_12A-66A | 12 | 10 | 1 | 49 | 0 | 1 | 23095 | 5095 | 66 | 20 | 67036 | 24.95 | 24.66 | 25.7 |
| CA_66A-12A | 66 | 20 | 1 | 99 | 0 | 1 | 132072 | 66536 | 12 | 20 | 5095 | 23.96 | 23.81 | 25 |
| CA_41C | 41 | 20 | 1 | 99 | 0 | 1 | 39750 | 2506 | 41 | 20 | 39948 | 23.92 | 23.78 | 25 |
| CA_66C | 66 | 20 | 1 | 99 | 0 | 1 | 132572 | 67036 | 66 | 20 | 67234 | 23.91 | 23.8 | 25 |
| CA_41A-41A | 41 | 20 | 1 | 99 | 0 | 1 | 39750 | 2506 | 41 | 20 | 41490 | 23.97 | 23.78 | 25 |
| CA_13A-66A | 13 | 20 | 1 | 0 | 0 | 1 | 23230 | 5230 | 66 | 20 | 132422 | 23.96 | 23.79 | 25 |
| CA_66A-13A | 66 | 15 | 1 | 74 | 0 | 1 | 132322 | 66786 | 13 | 20 | 5230 | 23.81 | 23.66 | 25 |
| CA_12B | 12 | 15 | 1 | 0 | 0 | 1 | 23035 | 5035 | 12 | 15 | 5083 | 24.51 | 24.31 | 25.7 |
| CA_25A-26A | 25 | 20 | 1 | 20 | 0 | 1 | 26365 | 8365 | 26 | 15 | 8865 | 23.79 | 23.6 | 25 |
| CA_26A-25A | 26 | 15 | 1 | 15 | 0 | 1 | 26965 | 8965 | 25 | 20 | 8365 | 25.51 | 25.39 | 25.7 |
| CA_66B | 66 | 15 | 1 | 74 | 0 | 1 | 135523 | 66987 | 66 | 20 | 67086 | 23.81 | 23.69 | 25 |
| CA_66A-66A | 66 | 20 | 1 | 99 | 0 | 1 | 132072 | 66536 | 66 | 20 | 67036 | 23.96 | 23.72 | 25 |
| CA_25A-41A | 25 | 20 | 1 | 50 | 0 | 1 | 26365 | 8365 | 41 | 20 | 2593 | 23.79 | 23.55 | 25 |
| CA_41A-25A | 41 | 20 | 1 | 0 | 0 | 1 | 39750 | 2506 | 25 | 20 | 8365 | 23.92 | 23.73 | 25 |
| CA_7A-7A | 7 | 20 | 1 | 0 | 0 | 1 | 21000 | 3000 | 7 | 20 | 3350 | 22.32 | 22.19 | 24 |

Note: Testing is not required in bands or modes not intended/allowed for US operation.

11.4 Wi-Fi and BT Measurement result

The maximum output power of BT is 8.6dBm.

The maximum tune up of BT is 9.5dBm.

Normal Power

The average conducted power for Wi-Fi is as following:

| 802.11b | | | | |
|-------------------|--------------|--------------|--------------|--------------|
| Channel\data rate | 1Mbps | 2Mbps | 5.5Mbps | 11Mbps |
| 11(2462MHz) | 18.09 | / | 18.11 | / |
| 6(2437(MHz) | 18.01 | / | 18.14 | / |
| 1(2412MHz) | 18.23 | 18.27 | 18.41 | 18.38 |
| tuneup | 19.20 | 19.20 | 19.20 | 19.20 |

| 802.11g | | | | | | | | |
|-------------------|--------------|--------------|--------------|--------------|--------------|--------------|--------------|--------------|
| Channel\data rate | 6Mbps | 9Mbps | 12Mbps | 18Mbps | 24Mbps | 36Mbps | 48Mbps | 54Mbps |
| 11(2462MHz) | 18.35 | / | / | / | / | / | / | / |
| 6(2437(MHz) | 18.33 | / | / | / | / | / | / | / |
| 1(2412MHz) | 18.56 | 18.19 | 18.16 | 18.17 | 17.64 | 17.06 | 16.47 | 16.44 |
| tuneup | 19.00 | 18.50 | 18.50 | 18.50 | 18.00 | 17.50 | 17.00 | 16.50 |

| 802.11n-20MHz | | | | | | | | |
|----------------------|--------------|--------------|--------------|--------------|--------------|--------------|--------------|--------------|
| Channel\data rate | MCS0 | MCS1 | MCS2 | MCS3 | MCS4 | MCS5 | MCS6 | MCS7 |
| 11(2462MHz) | 17.92 | / | / | / | / | / | / | / |
| 6(2437(MHz) | 17.95 | / | / | / | / | / | / | / |
| 1(2412MHz) | 18.34 | 18.21 | 17.65 | 17.58 | 17.04 | 16.47 | 16.46 | 15.97 |
| tuneup | 19.00 | 18.00 | 18.00 | 18.00 | 18.00 | 17.50 | 17.50 | 16.50 |

| 802.11n-40MHz | | | | | | | | |
|----------------------|--------------|--------------|--------------|--------------|--------------|--------------|--------------|--------------|
| Channel\data rate | MCS0 | MCS1 | MCS2 | MCS3 | MCS4 | MCS5 | MCS6 | MCS7 |
| 9(2452MHz) | 17.02 | / | / | / | / | / | / | / |
| 6(2437MHz) | 16.98 | / | / | / | / | / | / | / |
| 3(2422MHz) | 17.20 | 17.19 | 16.49 | 15.96 | 15.40 | 14.90 | 14.32 | 13.90 |
| tuneup | 17.80 | 17.50 | 17.50 | 17.00 | 16.00 | 15.50 | 15.00 | 14.50 |

| 802.11n-40MHz (5GHz) | | | | | | | | |
|----------------------|--------------|--------------|--------------|--------------|--------------|--------------|--------------|--------------|
| Channel\data rate | MCS0 | MCS1 | MCS2 | MCS3 | MCS4 | MCS5 | MCS6 | MCS7 |
| 38(5190 MHz) | 16.51 | / | / | / | / | / | / | / |
| 46(5230 MHz) | 16.60 | 16.50 | 15.99 | 15.96 | 15.37 | 15.38 | 14.82 | 14.80 |
| 54(5270 MHz) | 16.69 | / | / | / | / | / | / | / |
| 62(5310 MHz) | 16.73 | 16.71 | 16.18 | 16.16 | 15.57 | 15.52 | 15.01 | 14.96 |
| 102(5510 MHz) | 16.56 | / | / | / | / | / | / | / |
| 110(5550 MHz) | 16.68 | / | / | / | / | / | / | / |
| 118(5590 MHz) | 16.80 | / | / | / | / | / | / | / |
| 126(5630 MHz) | 16.69 | / | / | / | / | / | / | / |
| 134(5670 MHz) | 16.74 | / | / | / | / | / | / | / |
| 142(5710 MHz) | 17.03 | 17.01 | 16.56 | 16.48 | 16.02 | 15.95 | 15.37 | 15.35 |
| 151(5755 MHz) | 17.16 | 17.14 | 16.67 | 16.60 | 16.13 | 16.09 | 15.51 | 15.48 |
| 159(5795 MHz) | 17.12 | | | | | | | |
| tuneup | 18.20 | 18.20 | 17.80 | 17.80 | 17.00 | 17.00 | 16.50 | 16.50 |

Low Power

| 802.11b | | | | |
|-------------------|--------------|--------------|--------------|--------------|
| Channel\data rate | 1Mbps | 2Mbps | 5.5Mbps | 11Mbps |
| 11(2462MHz) | 14.81 | / | 14.92 | / |
| 6(2437(MHz) | 14.85 | / | 14.88 | / |
| 1(2412MHz) | 15.24 | 15.23 | 15.38 | 15.30 |
| tuneup | 15.50 | 15.50 | 15.50 | 15.50 |

| 802.11g | | | | | | | | |
|-------------------|--------------|--------------|--------------|--------------|--------------|--------------|--------------|--------------|
| Channel\data rate | 6Mbps | 9Mbps | 12Mbps | 18Mbps | 24Mbps | 36Mbps | 48Mbps | 54Mbps |
| 11(2462MHz) | 13.81 | / | / | / | / | / | / | / |
| 6(2437(MHz) | 13.92 | / | / | / | / | / | / | / |
| 1(2412MHz) | 14.23 | 14.20 | 13.74 | 13.72 | 13.20 | 13.14 | 12.02 | 12.04 |
| tuneup | 15.50 | 15.50 | 15.00 | 15.00 | 14.50 | 14.50 | 14.00 | 14.00 |

| 802.11n-20MHz | | | | | | | | |
|-------------------|--------------|--------------|--------------|--------------|--------------|--------------|--------------|--------------|
| Channel\data rate | MCS0 | MCS1 | MCS2 | MCS3 | MCS4 | MCS5 | MCS6 | MCS7 |
| 11(2462MHz) | 14.78 | / | / | / | / | / | / | / |
| 6(2437(MHz) | 14.92 | / | / | / | / | / | / | / |
| 1(2412MHz) | 15.15 | 15.13 | 14.68 | 14.60 | 14.08 | 14.03 | 12.91 | 12.87 |
| tuneup | 15.50 | 15.50 | 15.00 | 15.00 | 14.50 | 14.50 | 14.50 | 13.50 |

| 802.11n-40MHz | | | | | | | | |
|-------------------|--------------|--------------|--------------|--------------|--------------|--------------|--------------|--------------|
| Channel\data rate | MCS0 | MCS1 | MCS2 | MCS3 | MCS4 | MCS5 | MCS6 | MCS7 |
| 9(2452MHz) | 14.41 | / | / | / | / | / | / | / |
| 6(2437MHz) | 14.35 | / | / | / | / | / | / | / |
| 3(2422MHz) | 14.49 | 14.45 | 13.87 | 13.81 | 13.24 | 13.21 | 12.20 | 12.20 |
| tuneup | 14.80 | 14.80 | 14.50 | 14.50 | 14.00 | 14.00 | 13.00 | 13.00 |



| 802.11a (5GHz) | | | | | | | | |
|---------------------------|--------------|--------------|--------------|--------------|--------------|--------------|--------------|--------------|
| Channel\data rate | 6Mbps | 9Mbps | 12Mbps | 18Mbps | 24Mbps | 36Mbps | 48Mbps | 54Mbps |
| 36(5180 MHz) | 13.99 | / | / | / | / | / | / | / |
| 40(5200 MHz) | 14.09 | 14.03 | 13.48 | 13.52 | 12.91 | 12.92 | 12.34 | 12.32 |
| 44(5220 MHz) | 14.06 | / | / | / | / | / | / | / |
| 48(5240 MHz) | 13.90 | / | / | / | / | / | / | / |
| 52(5260 MHz) | 13.83 | / | / | / | / | / | / | / |
| 56(5280 MHz) | 13.97 | / | / | / | / | / | / | / |
| 60(5300 MHz) | 14.06 | / | / | / | / | / | / | / |
| 64(5320 MHz) | 14.20 | 14.15 | 13.65 | 13.54 | 13.05 | 13.06 | 12.35 | 12.32 |
| 100(5500 MHz) | 14.09 | / | / | / | / | / | / | / |
| 104(5520 MHz) | 14.10 | / | / | / | / | / | / | / |
| 108(5540 MHz) | 14.29 | / | / | / | / | / | / | / |
| 112(5560 MHz) | 14.39 | / | / | / | / | / | / | / |
| 116(5580 MHz) | 14.19 | / | / | / | / | / | / | / |
| 120(5600 MHz) | 14.21 | / | / | / | / | / | / | / |
| 124(5620 MHz) | 14.19 | / | / | / | / | / | / | / |
| 128(5640 MHz) | 14.23 | / | / | / | / | / | / | / |
| 132(5660 MHz) | 14.18 | / | / | / | / | / | / | / |
| 136(5680 MHz) | 14.38 | / | / | / | / | / | / | / |
| 140(5700 MHz) | 14.43 | / | / | / | / | / | / | / |
| 144(5720 MHz) | 14.52 | 14.50 | 13.99 | 13.97 | 13.45 | 13.43 | 12.72 | 12.73 |
| 802.11n(dBm)-40MHz | | | | | | | | |
| 151(5755 MHz) | 13.94 | 13.90 | 13.39 | 13.37 | 12.63 | 12.68 | 11.99 | 11.94 |
| 159(5795 MHz) | 13.82 | / | / | / | / | / | / | / |
| tuneup | 15.00 | 15.00 | 14.70 | 14.70 | 14.20 | 14.20 | 13.50 | 13.50 |

12 Simultaneous TX SAR Considerations

12.1 Introduction

The following procedures adopted from “FCC SAR Considerations for Cell Phones with Multiple Transmitters” are applicable to handsets with built-in unlicensed transmitters such as 802.11 a/b/g and Bluetooth devices which may simultaneously transmit with the licensed transmitter. For this device, the BT and Wi-Fi can transmit simultaneous with other transmitters.

12.2 Transmit Antenna Separation Distances

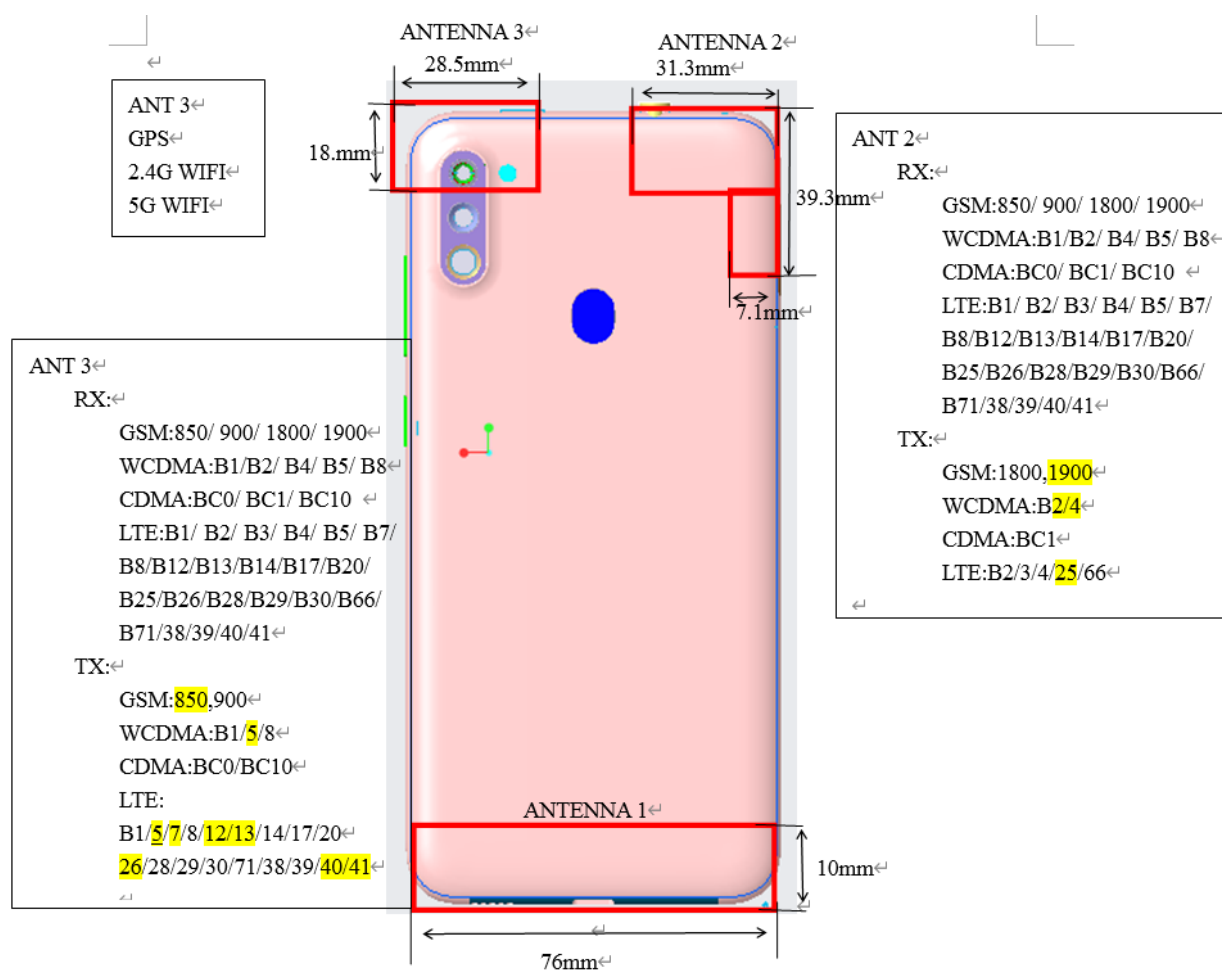

Picture 12.1 Antenna Locations

12.3 SAR Measurement Positions

According to the KDB941225 D06 Hot Spot SAR v01, the edges with less than 2.5 cm distance to the antennas need to be tested for SAR.

| SAR measurement positions | | | | | | |
|---------------------------|-------|------|-----------|------------|----------|-------------|
| Mode | Front | Rear | Left edge | Right edge | Top edge | Bottom edge |
| Main antenna- antenna1 | Yes | Yes | Yes | Yes | No | Yes |
| Main antenna- antenna2 | Yes | Yes | Yes | No | Yes | No |
| WLAN | Yes | Yes | No | Yes | Yes | No |

12.4 Standalone SAR Test Exclusion Considerations

Standalone 1-g head or body SAR evaluation by measurement or numerical simulation is not required when the corresponding SAR Exclusion Threshold condition, listed below, is satisfied. The 1-g SAR test exclusion threshold for 100 MHz to 6 GHz at test separation distances ≤ 50 mm are determined by:

$[(\text{max. power of channel, including tune-up tolerance, mW}) / (\text{min. test separation distance, mm})] \cdot [\sqrt{f(\text{GHz})}] \leq 3.0$ for 1-g SAR, where

- $f(\text{GHz})$ is the RF channel transmit frequency in GHz
- Power and distance are rounded to the nearest mW and mm before calculation
- The result is rounded to one decimal place for comparison

Table 12.1: Standalone SAR test exclusion considerations

| Band/Mode | F(GHz) | Position | SAR test exclusion threshold(mW) | RF output power | | SAR test exclusion |
|-------------|--------|----------|----------------------------------|-----------------|-------|--------------------|
| | | | | dBm | mW | |
| Bluetooth | 2.441 | Head | 9.60 | 9.5 | 8.91 | Yes |
| | | Body | 19.20 | 9.5 | 8.91 | Yes |
| 2.4GHz WLAN | 2.45 | Head | 9.58 | 19.2 | 83.18 | No |
| | | Body | 19.17 | 19.2 | 83.18 | No |
| 5GHz WLAN | 5.2 | Head | 6.58 | 18.2 | 66.07 | No |
| | | Body | 13.16 | 18.2 | 66.07 | No |
| | 5.3 | Head | 6.52 | 18.2 | 66.07 | No |
| | | Body | 13.03 | 18.2 | 66.07 | No |
| | 5.6 | Head | 6.34 | 18.2 | 66.07 | No |
| | | Body | 12.68 | 18.2 | 66.07 | No |
| | 5.8 | Head | 6.23 | 18.2 | 66.07 | No |
| | | Body | 12.46 | 18.2 | 66.07 | No |

13 Evaluation of Simultaneous

Table 13.1: The sum of reported SAR values for main antenna and WiFi2.4G

| | Position | Main antenna | WiFi | Sum |
|-------------------------------------|------------------------------|--------------|------|------|
| Highest reported SAR value for Head | Right hand, Tilt (WCDMA1700) | 1.08 | 0.09 | 1.17 |
| Highest reported SAR value for Body | Rear 10mm (GSM850) | 0.76 | 0.29 | 1.05 |

Table 13.2: The sum of reported SAR values for main antenna and WiFi5G

| | Position | Main antenna | WiFi | Sum |
|-------------------------------------|------------------------------|--------------|------|------|
| Highest reported SAR value for Head | Right hand, Tilt (WCDMA1700) | 1.08 | 0.22 | 1.30 |
| Highest reported SAR value for Body | Rear 10mm (GSM850) | 0.76 | 0.59 | 1.35 |

Table 13.3: The sum of reported SAR values for main antenna and BT

| | Position | Main antenna | BT | Sum |
|-------------------------------------|------------------------------|--------------|---------------------|------|
| Maximum reported SAR value for Head | Right hand, Tilt (WCDMA1700) | 1.08 | 0.37 ^[1] | 1.45 |
| Maximum reported SAR value for Body | Rear 10mm (GSM850) | 0.76 | 0.19 ^[1] | 0.95 |

[1] - Estimated SAR for Bluetooth (see the table 13.4)

Table 13.4: Estimated SAR for Bluetooth

| Mode/Band | F (GHz) | Position | Distance (mm) | Upper limit of power * | | Estimated _{1g} (W/kg) |
|-----------|---------|----------|---------------|------------------------|-----|--------------------------------|
| | | | | dBm | mW | |
| Bluetooth | 2.441 | Head | 5 | 9.5 | 8.9 | 0.37 |
| Bluetooth | 2.441 | Body | 10 | 9.5 | 8.9 | 0.19 |

* - Maximum possible output power declared by manufacturer

When standalone SAR test exclusion applies to an antenna that transmits simultaneously with other antennas, the standalone SAR must be estimated according to following to determine simultaneous transmission SAR test exclusion:

(max. power of channel, including tune-up tolerance, mW)/(min. test separation distance,mm)·[√f(GHz)/x] W/kg for test separation distances ≤ 50 mm;

where x = 7.5 for 1-g SAR.

When the minimum test separation distance is < 5 mm, a distance of 5 mm is applied to determine



No.I20Z70015-SEM01

SAR test exclusion

Conclusion:

According to the above tables, the sum of reported SAR values is $< 1.6 \text{ W/kg}$. So the simultaneous transmission SAR with volume scans is not required.

14 SAR Test Result

It is determined by user manual for the distance between the EUT and the phantom bottom. The distance is 10 mm or 15mm and just applied to the condition of body worn accessory.

It is performed for all SAR measurements with area scan based 1-g SAR estimation (Fast SAR). A zoom scan measurement is added when the estimated 1-gSAR is the highest measured SAR in each exposure configuration, wireless mode and frequency band combination or more than 1.2W/kg.

The calculated SAR is obtained by the following formula:

$$\text{Reported SAR} = \text{Measured SAR} \times 10^{(P_{\text{Target}} - P_{\text{Measured}})/10}$$

Where P_{Target} is the power of manufacturing upper limit;

P_{Measured} is the measured power in chapter 11.

Table 14.1: Duty Cycle

| Mode | Duty Cycle |
|-------------------------------------|------------|
| Speech for GSM850 | 1:2.67 |
| Speech for GSM1900 | 1:2 |
| GPRS&EGPRS for GSM850- Normal Power | 1:2.67 |
| GPRS&EGPRS for GSM850- Low Power | 1:2.67 |
| GPRS&EGPRS for GSM1900-Normal Power | 1:2 |
| GPRS&EGPRS for GSM1900-Low Power | 1:2 |
| WCDMA<E FDD | 1:1 |
| LTE B41 | 1:1.58 |

14.1 SAR results for Fast SAR

Table 14.1-1: SAR Values (GSM 850 MHz Band - Head)

| Ambient Temperature: 22.9 °C | | | | | | Liquid Temperature: 22.5°C | | | | | |
|------------------------------|-------|-------|---------------|------------|-----------------------|----------------------------|--------------------------|--------------------------|-------------------------|-------------------------|------------------|
| Frequency | | Side | Test Position | Figure No. | Conducted Power (dBm) | Max. tune-up Power (dBm) | Measured SAR(10g) (W/kg) | Reported SAR(10g) (W/kg) | Measured SAR(1g) (W/kg) | Reported SAR(1g) (W/kg) | Power Drift (dB) |
| Ch. | MHz | | | | | | | | | | |
| 190 | 836.6 | Left | Touch | / | 29.47 | 30.50 | 0.232 | 0.29 | 0.301 | 0.38 | -0.04 |
| 190 | 836.6 | Left | Tilt | / | 29.47 | 30.50 | 0.140 | 0.18 | 0.181 | 0.23 | 0.12 |
| 251 | 848.8 | Right | Touch | / | 29.53 | 30.50 | 0.192 | 0.24 | 0.261 | 0.33 | 0.03 |
| 190 | 836.6 | Right | Touch | / | 29.47 | 30.50 | 0.242 | 0.31 | 0.323 | 0.41 | -0.11 |
| 128 | 824.2 | Right | Touch | Fig.1 | 29.32 | 30.50 | 0.279 | 0.37 | 0.372 | 0.49 | 0.05 |
| 190 | 836.6 | Right | Tilt | / | 29.47 | 30.50 | 0.175 | 0.22 | 0.224 | 0.28 | 0.04 |

Note: the head SAR of GSM850 is tested with GPRS (3Txslots) mode because of VoIP.

Table 14.1-2: SAR Values (GSM 850 MHz Band - Body)

| Ambient Temperature: 22.9 °C | | | | | | Liquid Temperature: 22.5°C | | | | | |
|------------------------------|-------|----------------------------|---------------|------------|-----------------------|----------------------------|--------------------------|--------------------------|-------------------------|-------------------------|------------------|
| Frequency | | Mode (number of timeslots) | Test Position | Figure No. | Conducted Power (dBm) | Max. tune-up Power (dBm) | Measured SAR(10g) (W/kg) | Reported SAR(10g) (W/kg) | Measured SAR(1g) (W/kg) | Reported SAR(1g) (W/kg) | Power Drift (dB) |
| Ch. | MHz | | | | | | | | | | |
| 190 | 836.6 | GPRS (3) | Front | / | 29.47 | 30.50 | 0.261 | 0.33 | 0.338 | 0.43 | -0.14 |
| 251 | 848.8 | GPRS (3) | Rear | / | 29.53 | 30.50 | 0.260 | 0.33 | 0.420 | 0.53 | -0.13 |
| 190 | 836.6 | GPRS (3) | Rear | / | 29.47 | 30.50 | 0.357 | 0.45 | 0.464 | 0.59 | 0.10 |
| 128 | 824.2 | GPRS (3) | Rear | Fig.2 | 29.32 | 30.50 | 0.440 | 0.58 | 0.578 | 0.76 | -0.05 |
| 190 | 836.6 | GPRS (3) | Left | / | 29.47 | 30.50 | 0.195 | 0.25 | 0.272 | 0.34 | 0.07 |
| 190 | 836.6 | GPRS (3) | Right | / | 29.47 | 30.50 | 0.348 | 0.44 | 0.453 | 0.57 | 0.02 |
| 190 | 836.6 | GPRS (3) | Bottom | / | 29.47 | 30.50 | 0.164 | 0.21 | 0.280 | 0.35 | -0.11 |
| 128 | 824.2 | EGPRS (3) | Rear | / | 29.27 | 30.50 | 0.414 | 0.55 | 0.559 | 0.74 | 0.07 |

Note: The distance between the EUT and the phantom bottom is 10mm.

Table 14.1-3: SAR Values (GSM 1900 MHz Band - Head)

| Ambient Temperature: 22.9 °C | | | | | | Liquid Temperature: 22.5°C | | | | | |
|------------------------------|--------|-------|---------------|------------|-----------------------|----------------------------|--------------------------|--------------------------|-------------------------|-------------------------|------------------|
| Frequency | | Side | Test Position | Figure No. | Conducted Power (dBm) | Max. tune-up Power (dBm) | Measured SAR(10g) (W/kg) | Reported SAR(10g) (W/kg) | Measured SAR(1g) (W/kg) | Reported SAR(1g) (W/kg) | Power Drift (dB) |
| Ch. | MHz | | | | | | | | | | |
| 661 | 1880 | Left | Touch | / | 18.59 | 19.00 | 0.115 | 0.13 | 0.183 | 0.20 | 0.03 |
| 661 | 1880 | Left | Tilt | / | 18.59 | 19.00 | 0.126 | 0.14 | 0.224 | 0.25 | -0.11 |
| 810 | 1909.8 | Right | Touch | / | 18.57 | 19.00 | 0.142 | 0.16 | 0.252 | 0.28 | -0.13 |
| 661 | 1880 | Right | Touch | / | 18.59 | 19.00 | 0.153 | 0.17 | 0.269 | 0.30 | -0.12 |
| 512 | 1850.2 | Right | Touch | Fig.3 | 18.63 | 19.00 | 0.165 | 0.18 | 0.285 | 0.31 | 0.04 |
| 661 | 1880 | Right | Tilt | / | 18.59 | 19.00 | 0.131 | 0.14 | 0.239 | 0.26 | -0.14 |

Note: the head SAR of GSM1900 is tested with GPRS (4Txslots) mode because of VoIP.

Table 14.1-4: SAR Values (GSM 1900 MHz Band - Body)

| Frequency | | Mode (number of timeslots) | Test Position | Figure No. | Conducted Power (dBm) | Max. tune-up Power (dBm) | Measured SAR(10g) (W/kg) | Reported SAR(10g) (W/kg) | Measured SAR(1g) (W/kg) | Reported SAR(1g) (W/kg) | Power Drift (dB) |
|---|--------|----------------------------------|------------------|---------------|-----------------------------|-----------------------------|--------------------------------|--------------------------------|-------------------------------|-------------------------------|------------------------|
| Ch. | MHz | | | | | | | | | | |
| Ambient Temperature: 22.9 °C Liquid Temperature: 22.5 °C | | | | | | | | | | | |
| 661 | 1880 | GPRS (4) | Front | Note2 | 25.72 | 27.00 | 0.055 | 0.07 | 0.082 | 0.11 | 0.02 |
| 810 | 1909.8 | GPRS (4) | Rear | Note3 | 25.72 | 27.00 | 0.074 | 0.10 | 0.118 | 0.16 | -0.11 |
| 661 | 1880 | GPRS (4) | Left | / | 25.72 | 27.00 | 0.018 | 0.02 | 0.031 | 0.04 | -0.12 |
| 512 | 1850.2 | GPRS (4) | Right | / | 25.72 | 27.00 | 0.000 | 0.00 | 0.000 | 0.00 | 0.04 |
| 661 | 1880 | GPRS (4) | Top | Note4 | 25.72 | 27.00 | 0.019 | 0.03 | 0.032 | 0.04 | 0.03 |
| 661 | 1880 | GPRS (4) | Front | / | 18.59 | 19.00 | 0.199 | 0.22 | 0.301 | 0.33 | 0.12 |
| 810 | 1909.8 | GPRS (4) | Rear | / | 18.63 | 19.00 | 0.328 | 0.36 | 0.534 | 0.58 | 0.03 |
| 661 | 1880 | GPRS (4) | Rear | / | 18.59 | 19.00 | 0.333 | 0.37 | 0.567 | 0.62 | -0.11 |
| 512 | 1850.2 | GPRS (4) | Rear | Fig.4 | 18.63 | 19.00 | 0.382 | 0.42 | 0.639 | 0.70 | 0.04 |
| 661 | 1880 | GPRS (4) | Left | / | 18.59 | 19.00 | 0.309 | 0.34 | 0.517 | 0.57 | 0.17 |
| 661 | 1880 | GPRS (4) | Top | / | 18.69 | 19.00 | 0.379 | 0.41 | 0.636 | 0.68 | -0.11 |
| 512 | 1850.2 | EGPRS (4) | Rear | / | 18.59 | 19.00 | 0.199 | 0.22 | 0.301 | 0.33 | 0.12 |

Note1: The distance between the EUT and the phantom bottom is 10mm

Note2: The distance between the EUT and the phantom bottom is 16mm by sensor (See detail in annex I).

Note3: The distance between the EUT and the phantom bottom is 18mm by sensor (See detail in annex I).

Note4: The distance between the EUT and the phantom bottom is 17mm by sensor (See detail in annex I).

Table 14.1-5: SAR Values (WCDMA 1900 MHz Band - Head)

| Frequency | | Side | Test Position | Figure No. | Conducted Power (dBm) | Max. tune-up Power (dBm) | Measure d SAR(10g) (W/kg) | Reported SAR(10g) (W/kg) | Measure d SAR(1g) (W/kg) | Reporte d SAR(1g) (W/kg) | Power Drift (dB) |
|---|--------|-------|------------------|---------------|-----------------------------|--------------------------------|------------------------------------|--------------------------------|-----------------------------------|-----------------------------------|------------------------|
| Ch. | MHz | | | | | | | | | | |
| Ambient Temperature: 22.9 °C Liquid Temperature: 22.5 °C | | | | | | | | | | | |
| 9800 | 1880 | Left | Touch | / | 18.66 | 20.00 | 0.236 | 0.32 | 0.364 | 0.50 | 0.03 |
| 9800 | 1880 | Left | Tilt | / | 18.66 | 20.00 | 0.251 | 0.34 | 0.427 | 0.58 | 0.02 |
| 9800 | 1880 | Right | Touch | / | 18.71 | 20.00 | 0.310 | 0.42 | 0.526 | 0.71 | -0.14 |
| 9938 | 1907.6 | Right | Tilt | Fig.5 | 18.66 | 20.00 | 0.321 | 0.44 | 0.538 | 0.73 | 0.05 |
| 9800 | 1880 | Right | Tilt | / | 18.81 | 20.00 | 0.313 | 0.41 | 0.524 | 0.69 | -0.12 |
| 9662 | 1852.4 | Right | Tilt | / | 18.66 | 20.00 | 0.275 | 0.37 | 0.472 | 0.64 | 0.08 |

Table 14.1-6: SAR Values (WCDMA 1900 MHz Band - Body)

| Frequency | | Test Position | Figure No. | Conduct ed Power (dBm) | Max. tune-up Power (dBm) | Ambient Temperature: 22.9 °C | | Liquid Temperature: 22.5 °C | | Power Drift (dB) |
|-----------|--------|---------------|-------------|------------------------|--------------------------|------------------------------|--------------------------|-----------------------------|-------------------------|------------------|
| Ch. | MHz | | | | | Measured SAR(10g) (W/kg) | Reported SAR(10g) (W/kg) | Measured SAR(1g) (W/kg) | Reported SAR(1g) (W/kg) | |
| 9400 | 1880 | Front | Note2 | 24.27 | 25.70 | 0.088 | 0.12 | 0.143 | 0.20 | -0.10 |
| 9538 | 1907.6 | Rear | Note3 | 24.20 | 25.70 | 0.108 | 0.15 | 0.179 | 0.25 | 0.13 |
| 9400 | 1880 | Rear | Note3 | 24.27 | 25.70 | 0.113 | 0.16 | 0.190 | 0.26 | -0.11 |
| 9262 | 1852.4 | Rear | Note3 Fig.6 | 24.32 | 25.70 | 0.126 | 0.17 | 0.208 | 0.29 | -0.14 |
| 9400 | 1880 | Left | / | 24.27 | 25.70 | 0.028 | 0.04 | 0.050 | 0.07 | 0.13 |
| 9400 | 1880 | Right | / | 24.27 | 25.70 | 0.011 | 0.02 | 0.018 | 0.03 | 0.00 |
| 9400 | 1880 | Top | Note4 | 24.27 | 25.70 | 0.033 | 0.05 | 0.055 | 0.08 | 0.05 |
| 9400 | 1880 | Front | / | 18.66 | 20.00 | 0.041 | 0.06 | 0.068 | 0.09 | 0.05 |
| 9400 | 1880 | Rear | / | 18.66 | 20.00 | 0.068 | 0.09 | 0.121 | 0.16 | -0.11 |
| 9400 | 1880 | Top | / | 18.66 | 20.00 | 0.070 | 0.09 | 0.127 | 0.17 | -0.11 |

Note1: The distance between the EUT and the phantom bottom is 10mm

Note2: The distance between the EUT and the phantom bottom is 16mm by sensor (See detail in annex I).

Note3: The distance between the EUT and the phantom bottom is 18mm by sensor (See detail in annex I).

Note4: The distance between the EUT and the phantom bottom is 17mm by sensor (See detail in annex I).

Table 14.1-7: SAR Values (WCDMA 1700 MHz Band - Head)

| Frequency | | Side | Test Position | Figure No. | Conducte d Power (dBm) | Max. tune-up Power (dBm) | Ambient Temperature: 22.9 °C | | Liquid Temperature: 22.5 °C | | Power Drift (dB) |
|-----------|--------|-------|---------------|------------|------------------------|--------------------------|------------------------------|--------------------------|-----------------------------|-------------------------|------------------|
| Ch. | MHz | | | | | | Measured SAR(10g) (W/kg) | Reported SAR(10g) (W/kg) | Measure d SAR(1g) (W/kg) | Reported SAR(1g) (W/kg) | |
| 1412 | 1732.4 | Left | Touch | / | 18.48 | 20.00 | 0.303 | 0.43 | 0.526 | 0.75 | 0.04 |
| 1412 | 1732.4 | Left | Tilt | / | 18.48 | 20.00 | 0.350 | 0.50 | 0.659 | 0.94 | -0.14 |
| 1412 | 1732.4 | Right | Touch | / | 18.48 | 20.00 | 0.373 | 0.53 | 0.718 | 1.02 | -0.12 |
| 1513 | 1752.6 | Right | Tilt | Fig.7 | 18.65 | 20.00 | 0.398 | 0.54 | 0.789 | 1.08 | 0.05 |
| 1412 | 1732.4 | Right | Tilt | / | 18.48 | 20.00 | 0.374 | 0.53 | 0.754 | 1.07 | -0.13 |
| 1312 | 1712.4 | Right | Tilt | / | 18.59 | 20.00 | 0.339 | 0.47 | 0.687 | 0.95 | -0.12 |

Table 14.1-8: SAR Values (WCDMA 1700 MHz Band - Body)

| Frequency | | Test Position | Figure No. | Conducted Power (dBm) | Max. tune-up Power (dBm) | Measured SAR(10g) (W/kg) | Reported SAR(10g) (W/kg) | Measured SAR(1g) (W/kg) | Reported SAR(1g) (W/kg) | Power Drift (dB) |
|---|--------|---------------|------------|-----------------------|--------------------------|--------------------------|--------------------------|-------------------------|-------------------------|------------------|
| Ch. | MHz | | | | | | | | | |
| Ambient Temperature: 22.9 °C Liquid Temperature: 22.5 °C | | | | | | | | | | |
| 1412 | 1732.5 | Front | Note2 | 24.15 | 25.50 | 0.069 | 0.09 | 0.106 | 0.15 | 0.05 |
| 1412 | 1732.5 | Rear | Note3 | 24.15 | 25.50 | 0.084 | 0.12 | 0.139 | 0.19 | -0.14 |
| 1412 | 1732.5 | Left | / | 24.15 | 25.50 | 0.050 | 0.07 | 0.088 | 0.12 | -0.10 |
| 1412 | 1732.5 | Right | / | 24.15 | 25.50 | 0.038 | 0.05 | 0.062 | 0.08 | -0.11 |
| 1412 | 1732.5 | Top | Note4 | 24.15 | 25.50 | 0.093 | 0.13 | 0.159 | 0.22 | 0.04 |
| 1412 | 1732.5 | Front | / | 18.48 | 20.00 | 0.089 | 0.13 | 0.147 | 0.21 | 0.03 |
| 1513 | 1752.6 | Rear | Fig.8 | 18.65 | 20.00 | 0.177 | 0.24 | 0.319 | 0.44 | -0.11 |
| 1412 | 1732.5 | Rear | / | 18.48 | 20.00 | 0.167 | 0.24 | 0.306 | 0.43 | 0.04 |
| 1312 | 1712.4 | Rear | / | 18.59 | 20.00 | 0.151 | 0.21 | 0.269 | 0.37 | 0.04 |
| 1312 | 1712.4 | Top | / | 18.48 | 20.00 | 0.148 | 0.21 | 0.269 | 0.38 | 0.02 |

Note1: The distance between the EUT and the phantom bottom is 10mm

Note2: The distance between the EUT and the phantom bottom is 16mm by sensor (See detail in annex I).

Note3: The distance between the EUT and the phantom bottom is 18mm by sensor (See detail in annex I).

Note4: The distance between the EUT and the phantom bottom is 17mm by sensor (See detail in annex I).

Table 14.1-9: SAR Values (WCDMA 850 MHz Band - Head)

| Frequency | | Side | Test Position | Figure No. | Conducted Power (dBm) | Max. tune-up Power (dBm) | Measured SAR(10g) (W/kg) | Reported SAR(10g) (W/kg) | Measured SAR(1g) (W/kg) | Reported SAR(1g) (W/kg) | Power Drift (dB) |
|---|-------|-------|---------------|------------|-----------------------|--------------------------|--------------------------|--------------------------|-------------------------|-------------------------|------------------|
| Ch. | MHz | | | | | | | | | | |
| Ambient Temperature: 22.9 °C Liquid Temperature: 22.5 °C | | | | | | | | | | | |
| 4182 | 836.4 | Left | Touch | / | 24.44 | 25.70 | 0.235 | 0.31 | 0.308 | 0.41 | -0.11 |
| 4182 | 836.4 | Left | Tilt | / | 24.44 | 25.70 | 0.146 | 0.20 | 0.188 | 0.25 | -0.13 |
| 4233 | 846.6 | Right | Touch | Fig.9 | 24.55 | 25.70 | 0.322 | 0.42 | 0.428 | 0.56 | 0.04 |
| 4182 | 836.4 | Right | Touch | / | 24.44 | 25.70 | 0.258 | 0.34 | 0.341 | 0.46 | 0.02 |
| 4132 | 826.4 | Right | Touch | / | 24.37 | 25.70 | 0.253 | 0.34 | 0.336 | 0.46 | -0.11 |
| 4182 | 836.4 | Right | Tilt | / | 24.44 | 25.70 | 0.170 | 0.23 | 0.215 | 0.29 | -0.14 |

Table 14.1-10: SAR Values (WCDMA 850 MHz Band - Body)

| Frequency | | Test Position | Figure No. | Conducted Power (dBm) | Max. tune-up Power (dBm) | Ambient Temperature: 22.9 °C | | Liquid Temperature: 22.5 °C | | Power Drift (dB) |
|-----------|-------|---------------|------------|-----------------------|--------------------------|------------------------------|--------------------------|-----------------------------|-------------------------|------------------|
| Ch. | MHz | | | | | Measured SAR(10g) (W/kg) | Reported SAR(10g) (W/kg) | Measured SAR(1g) (W/kg) | Reported SAR(1g) (W/kg) | |
| 4182 | 836.4 | Front | / | 24.44 | 25.70 | 0.269 | 0.36 | 0.354 | 0.47 | -0.14 |
| 4233 | 846.6 | Rear | / | 24.55 | 25.70 | 0.330 | 0.43 | 0.437 | 0.57 | 0.05 |
| 4182 | 836.4 | Rear | Fig.10 | 24.44 | 25.70 | 0.354 | 0.47 | 0.468 | 0.63 | -0.14 |
| 4132 | 826.4 | Rear | / | 24.37 | 25.70 | 0.325 | 0.44 | 0.429 | 0.58 | -0.10 |
| 4182 | 836.4 | Left | / | 24.44 | 25.70 | 0.187 | 0.25 | 0.267 | 0.36 | -0.12 |
| 4182 | 836.4 | Right | / | 24.44 | 25.70 | 0.268 | 0.36 | 0.381 | 0.51 | 0.03 |
| 4182 | 836.4 | Bottom | / | 24.44 | 25.70 | 0.154 | 0.21 | 0.274 | 0.37 | 0.04 |

Note: The distance between the EUT and the phantom bottom is 10mm.

Table 14.1-11: SAR Values (CDMA BC0 Band - Head)

| Frequency | | Side | Test Position | Figure No./ Note | Conducted Power (dBm) | Max. tune-up Power (dBm) | Ambient Temperature: 22.9 °C | | Liquid Temperature: 22.5 °C | | Power Drift (dB) |
|-----------|--------|-------|---------------|------------------|-----------------------|--------------------------|------------------------------|--------------------------|-----------------------------|-------------------------|------------------|
| Ch. | MHz | | | | | | Measured SAR(10g) (W/kg) | Reported SAR(10g) (W/kg) | Measured SAR(1g) (W/kg) | Reported SAR(1g) (W/kg) | |
| 384 | 836.52 | Left | Touch | / | 24.86 | 26 | 0.182 | 0.24 | 0.234 | 0.30 | 0.06 |
| 384 | 836.52 | Left | Tilt | / | 24.86 | 26 | 0.124 | 0.16 | 0.155 | 0.20 | -0.12 |
| 777 | 848.31 | Right | Touch | / | 25.02 | 26 | 0.203 | 0.25 | 0.265 | 0.33 | 0.14 |
| 384 | 836.52 | Right | Touch | Fig.11 | 24.86 | 26 | 0.210 | 0.27 | 0.273 | 0.35 | 0.10 |
| 1013 | 824.7 | Right | Touch | / | 24.80 | 26 | 0.177 | 0.23 | 0.230 | 0.30 | 0.06 |
| 384 | 836.52 | Right | Tilt | / | 24.86 | 26 | 0.148 | 0.19 | 0.185 | 0.24 | 0.04 |

Table 14.1-12: SAR Values (CDMA BC0 Band - Body)

| Frequency | | Test Position | Figure No./Note | Conducted Power (dBm) | Max. tune-up Power (dBm) | Ambient Temperature: 22.9 °C | | Liquid Temperature: 22.5 °C | | Power Drift (dB) |
|-----------|--------|---------------|-----------------|-----------------------|--------------------------|------------------------------|--------------------------|-----------------------------|-------------------------|------------------|
| Ch. | MHz | | | | | Measured SAR(10g) (W/kg) | Reported SAR(10g) (W/kg) | Measured SAR(1g) (W/kg) | Reported SAR(1g) (W/kg) | |
| 384 | 836.52 | Front | / | 24.86 | 26 | 0.191 | 0.25 | 0.347 | 0.45 | -0.06 |
| 777 | 848.31 | Rear | / | 25.02 | 26 | 0.257 | 0.32 | 0.498 | 0.62 | -0.05 |
| 384 | 836.52 | Rear | Fig.12 | 24.86 | 26 | 0.340 | 0.44 | 0.532 | 0.69 | 0.06 |
| 1013 | 824.7 | Rear | / | 24.80 | 26 | 0.296 | 0.39 | 0.466 | 0.61 | -0.13 |
| 384 | 836.52 | Left | / | 24.86 | 26 | 0.165 | 0.22 | 0.288 | 0.37 | -0.12 |
| 384 | 836.52 | Right | / | 24.86 | 26 | 0.254 | 0.33 | 0.433 | 0.56 | 0.14 |
| 384 | 836.52 | Bottom | / | 24.86 | 26 | 0.159 | 0.21 | 0.340 | 0.44 | 0.10 |

Note: The distance between the EUT and the phantom bottom is 10mm.

Table 14.1-13: SAR Values (CDMA BC1 Band - Head)

| Frequency | | Side | Test Position | Figure No./ Note | Conducted Power (dBm) | Max. tune-up Power (dBm) | Measured SAR(10g) (W/kg) | Reported SAR(10g) (W/kg) | Measured SAR(1g) (W/kg) | Reported SAR(1g) (W/kg) | Power Drift (dB) |
|---|---------|-------|---------------|------------------|-----------------------|--------------------------|--------------------------|--------------------------|-------------------------|-------------------------|------------------|
| Ch. | MHz | | | | | | | | | | |
| Ambient Temperature: 22.9 °C Liquid Temperature: 22.5 °C | | | | | | | | | | | |
| 600 | 1880 | Left | Touch | / | 18.34 | 19.5 | 0.353 | 0.46 | 0.606 | 0.79 | 0.06 |
| 600 | 1880 | Left | Tilt | / | 18.34 | 19.5 | 0.326 | 0.43 | 0.603 | 0.79 | 0.14 |
| 1175 | 1908.75 | Right | Touch | / | 18.39 | 19.5 | 0.313 | 0.40 | 0.548 | 0.71 | 0.02 |
| 600 | 1880 | Right | Touch | / | 18.34 | 19.5 | 0.358 | 0.47 | 0.626 | 0.82 | -0.12 |
| 25 | 1851.25 | Right | Touch | Fig.13 | 18.45 | 19.5 | 0.375 | 0.48 | 0.644 | 0.82 | 0.14 |
| 600 | 1880 | Right | Tilt | / | 18.34 | 19.5 | 0.325 | 0.42 | 0.587 | 0.77 | -0.12 |

Table 14.1-14: SAR Values (CDMA BC1 Band - Body)

| Frequency | | Test Position | Figure No./Note | Conducted Power (dBm) | Max. tune-up Power (dBm) | Measured SAR(10g) (W/kg) | Reported SAR(10g) (W/kg) | Measured SAR(1g) (W/kg) | Reported SAR(1g) (W/kg) | Power Drift (dB) |
|---|---------|---------------|-----------------|-----------------------|--------------------------|--------------------------|--------------------------|-------------------------|-------------------------|------------------|
| Ch. | MHz | | | | | | | | | |
| Ambient Temperature: 22.9 °C Liquid Temperature: 22.5 °C | | | | | | | | | | |
| 600 | 1880 | Front | Note2 | 23.54 | 25 | 0.152 | 0.21 | 0.251 | 0.35 | 0.06 |
| 600 | 1880 | Rear | Note3 Fig.14 | 23.54 | 25 | 0.231 | 0.32 | 0.392 | 0.55 | -0.16 |
| 600 | 1880 | Left | / | 23.54 | 25 | 0.167 | 0.23 | 0.310 | 0.43 | -0.01 |
| 600 | 1880 | Right | / | 23.54 | 25 | 0.069 | 0.10 | 0.128 | 0.18 | -0.12 |
| 1175 | 1908.75 | Top | Note4 | 23.54 | 25 | 0.230 | 0.32 | 0.404 | 0.57 | 0.14 |
| 600 | 1880 | Top | Note4 | 23.59 | 25 | 0.230 | 0.32 | 0.404 | 0.56 | 0.13 |
| 25 | 1851.25 | Top | Note4 | 23.61 | 25 | 0.230 | 0.32 | 0.404 | 0.56 | 0.02 |
| 600 | 1880 | Front | / | 18.34 | 19.5 | 0.082 | 0.11 | 0.136 | 0.18 | 0.02 |
| 600 | 1880 | Rear | / | 18.34 | 19.5 | 0.126 | 0.16 | 0.231 | 0.30 | 0.08 |
| 600 | 1880 | Top | / | 18.34 | 19.5 | 0.159 | 0.21 | 0.296 | 0.39 | -0.17 |

Note1: The distance between the EUT and the phantom bottom is 10mm.

Note2: The distance between the EUT and the phantom bottom is 16mm by sensor (See detail in annex I).

Note3: The distance between the EUT and the phantom bottom is 18mm by sensor (See detail in annex I).

Note4: The distance between the EUT and the phantom bottom is 17mm by sensor (See detail in annex I).

Table 14.1-15: SAR Values (CDMA BC10 Band - Head)

| Ambient Temperature: 22.9 °C | | | | | | Liquid Temperature: 22.5 °C | | | | | |
|------------------------------|-------|-------|---------------|------------------|-----------------------|-----------------------------|--------------------------|--------------------------|-------------------------|-------------------------|------------------|
| Frequency | | Side | Test Position | Figure No./ Note | Conducted Power (dBm) | Max. tune-up Power (dBm) | Measured SAR(10g) (W/kg) | Reported SAR(10g) (W/kg) | Measured SAR(1g) (W/kg) | Reported SAR(1g) (W/kg) | Power Drift (dB) |
| Ch. | MHz | | | | | | | | | | |
| 580 | 820.5 | Left | Touch | / | 24.88 | 26 | 0.052 | 0.07 | 0.077 | 0.10 | -0.13 |
| 580 | 820.5 | Left | Tilt | / | 24.88 | 26 | 0.000 | 0.00 | 0.000 | 0.00 | 0.07 |
| 684 | 823.1 | Right | Touch | Fig.15 | 24.97 | 26 | 0.054 | 0.07 | 0.081 | 0.10 | 0.07 |
| 580 | 820.5 | Right | Touch | / | 24.88 | 26 | 0.053 | 0.07 | 0.079 | 0.10 | 0.06 |
| 476 | 817.9 | Right | Touch | / | 25.00 | 26 | 0.000 | 0.00 | 0.000 | 0.00 | -0.13 |
| 580 | 820.5 | Right | Tilt | / | 24.88 | 26 | 0.000 | 0.00 | 0.000 | 0.00 | 0.18 |

Table 14.1-16: SAR Values (CDMA BC10 Band - Body)

| Ambient Temperature: 22.9 °C | | | | | | Liquid Temperature: 22.5 °C | | | | | |
|------------------------------|-------|---------------|------------------|-----------------------|--------------------------|-----------------------------|--------------------------|-------------------------|-------------------------|------------------|--|
| Frequency | | Test Position | Figure No./ Note | Conducted Power (dBm) | Max. tune-up Power (dBm) | Measured SAR(10g) (W/kg) | Reported SAR(10g) (W/kg) | Measured SAR(1g) (W/kg) | Reported SAR(1g) (W/kg) | Power Drift (dB) | |
| Ch. | MHz | | | | | | | | | | |
| 580 | 820.5 | Front | / | 24.88 | 26 | 0.056 | 0.07 | 0.070 | 0.09 | -0.16 | |
| 684 | 823.1 | Rear | Fig.16 | 24.97 | 26 | 0.092 | 0.12 | 0.115 | 0.15 | -0.12 | |
| 580 | 820.5 | Rear | / | 24.88 | 26 | 0.090 | 0.12 | 0.112 | 0.15 | 0.14 | |
| 476 | 817.9 | Rear | / | 25.00 | 26 | 0.088 | 0.11 | 0.110 | 0.14 | 0.13 | |
| 580 | 820.5 | Left | / | 24.88 | 26 | 0.034 | 0.04 | 0.055 | 0.07 | -0.12 | |
| 580 | 820.5 | Right | / | 24.88 | 26 | 0.062 | 0.08 | 0.085 | 0.11 | 0.14 | |
| 580 | 820.5 | Bottom | / | 24.88 | 26 | 0.036 | 0.05 | 0.061 | 0.08 | 0.13 | |

Note: The distance between the EUT and the phantom bottom is 10mm.

Table 14.1-17: SAR Values (LTE Band7 - Head)

| Ambient Temperature: 22.9 °C | | | | | | Liquid Temperature: 22.5 °C | | | | | | |
|------------------------------|------|----------|-------|---------------|------------|-----------------------------|--------------------------|--------------------------|--------------------------|-------------------------|-------------------------|------------------|
| Frequency | | Mode | Side | Test Position | Figure No. | Conducted Power (dBm) | Max. tune-up Power (dBm) | Measured SAR(10g) (W/kg) | Reported SAR(10g) (W/kg) | Measured SAR(1g) (W/kg) | Reported SAR(1g) (W/kg) | Power Drift (dB) |
| Ch. | MHz | | | | | | | | | | | |
| 21100 | 2535 | 1RB_Mid | Left | Touch | Fig.17 | 20.61 | 22 | 0.102 | 0.14 | 0.186 | 0.26 | 0.02 |
| 21100 | 2535 | 1RB_Mid | Left | Tilt | / | 20.61 | 22 | 0.082 | 0.11 | 0.151 | 0.21 | -0.11 |
| 21100 | 2535 | 1RB_Mid | Right | Touch | / | 20.61 | 22 | 0.069 | 0.10 | 0.125 | 0.17 | -0.14 |
| 21100 | 2535 | 1RB_Mid | Right | Tilt | / | 20.61 | 22 | 0.066 | 0.09 | 0.118 | 0.16 | 0.04 |
| 21350 | 2560 | 50RB_Mid | Left | Touch | / | 19.44 | 21 | 0.074 | 0.11 | 0.134 | 0.19 | 0.05 |
| 21350 | 2560 | 50RB_Mid | Left | Tilt | / | 19.44 | 21 | 0.062 | 0.09 | 0.113 | 0.16 | 0.06 |
| 21350 | 2560 | 50RB_Mid | Right | Touch | / | 19.44 | 21 | 0.051 | 0.07 | 0.093 | 0.13 | 0.11 |
| 21350 | 2560 | 50RB_Mid | Right | Tilt | / | 19.44 | 21 | 0.052 | 0.07 | 0.093 | 0.13 | -0.02 |

Note1: The LTE mode is QPSK_20MHz.

Table 14.1-18: SAR Values (LTE Band7 - Body)

| Frequency | | Mode | Test Position | Figure No. | Conduct ed Power (dBm) | Max. tune-up Power (dBm) | Measured SAR(10g) (W/kg) | Reported SAR(10g) (W/kg) | Measured SAR(1g) (W/kg) | Reported SAR(1g) (W/kg) | Power Drift (dB) | |
|-----------|------|------------------------------|---------------|--------------|------------------------|--------------------------|--------------------------|----------------------------|-------------------------|-------------------------|------------------|--|
| Ch. | MHz | | | | | | | | | | | |
| | | Ambient Temperature: 22.9 °C | | | | | | Liquid Temperature: 22.5°C | | | | |
| 21350 | 2560 | 1RB_Low | Front | Note2 | 22.32 | 24 | 0.108 | 0.16 | 0.196 | 0.29 | 0.04 | |
| 21350 | 2560 | 1RB_Low | Rear | Note3 Fig.18 | 22.32 | 24 | 0.158 | 0.23 | 0.296 | 0.44 | 0.07 | |
| 21350 | 2560 | 1RB_Low | Left | / | 22.32 | 24 | 0.127 | 0.19 | 0.230 | 0.34 | -0.05 | |
| 21350 | 2560 | 1RB_Low | Right | Note4 | 22.32 | 24 | 0.103 | 0.15 | 0.182 | 0.27 | -0.13 | |
| 21350 | 2560 | 1RB_Low | Bottom | Note5 | 22.32 | 24 | 0.119 | 0.18 | 0.210 | 0.31 | -0.08 | |
| 21350 | 2560 | 50RB_Mid | Front | Note2 | 21.43 | 23 | 0.103 | 0.15 | 0.188 | 0.27 | 0.06 | |
| 21350 | 2560 | 50RB_Mid | Rear | Note3 | 21.43 | 23 | 0.149 | 0.21 | 0.277 | 0.40 | -0.14 | |
| 21350 | 2560 | 50RB_Mid | Left | / | 21.43 | 23 | 0.119 | 0.17 | 0.214 | 0.31 | 0.05 | |
| 21350 | 2560 | 50RB_Mid | Right | Note4 | 21.43 | 23 | 0.096 | 0.14 | 0.170 | 0.24 | -0.12 | |
| 21350 | 2560 | 50RB_Mid | Bottom | Note5 | 21.43 | 23 | 0.113 | 0.16 | 0.200 | 0.29 | 0.11 | |
| 21100 | 2535 | 1RB_Mid | Front | / | 20.61 | 22 | 0.031 | 0.04 | 0.058 | 0.08 | -0.10 | |
| 21100 | 2535 | 1RB_Mid | Rear | | 20.61 | 22 | 0.050 | 0.07 | 0.104 | 0.14 | -0.11 | |
| 21100 | 2535 | 1RB_Mid | Right | / | 20.61 | 22 | <0.01 | <0.01 | <0.01 | <0.01 | / | |
| 21100 | 2535 | 1RB_Mid | Bottom | / | 20.61 | 22 | 0.046 | 0.06 | 0.095 | 0.13 | 0.02 | |
| 21350 | 2560 | 50RB_Mid | Front | / | 19.44 | 21 | 0.024 | 0.04 | 0.047 | 0.07 | 0.14 | |
| 21350 | 2560 | 50RB_Mid | Rear | / | 19.44 | 21 | 0.041 | 0.06 | 0.086 | 0.12 | 0.13 | |
| 21350 | 2560 | 50RB_Mid | Right | / | 19.44 | 21 | <0.01 | <0.01 | <0.01 | <0.01 | / | |
| 21350 | 2560 | 50RB_Mid | Bottom | / | 19.44 | 21 | 0.038 | 0.05 | 0.076 | 0.11 | 0.07 | |

Note1: The distance between the EUT and the phantom bottom is 10mm

Note2: The distance between the EUT and the phantom bottom is 16mm by sensor (See detail in annex I).

Note3: The distance between the EUT and the phantom bottom is 18mm by sensor (See detail in annex I).

Note4: The distance between the EUT and the phantom bottom is 11mm by sensor (See detail in annex I).

Note5: The distance between the EUT and the phantom bottom is 25mm by sensor (See detail in annex I).

Note6: The LTE mode is QPSK_20MHz.

Table 14.1-19: SAR Values (LTE Band12 - Head)

| Frequency | | Mode | Side | Test Position | Figure No. | Conducted Power (dBm) | Max. tune-up Power (dBm) | Measured SAR(10g) (W/kg) | Reported SAR(10g) (W/kg) | Measured SAR(1g) (W/kg) | Reported SAR(1g) (W/kg) | Power Drift (dB) |
|---|-------|----------|-------|---------------|------------|-----------------------|--------------------------|--------------------------|--------------------------|-------------------------|-------------------------|------------------|
| Ch. | MHz | | | | | | | | | | | |
| Ambient Temperature: 22.9°C Liquid Temperature: 22.5°C | | | | | | | | | | | | |
| 23095 | 707.5 | 1RB_High | Left | Touch | / | 24.95 | 25.7 | 0.161 | 0.19 | 0.203 | 0.24 | -0.12 |
| 23095 | 707.5 | 1RB_High | Left | Tilt | / | 24.95 | 25.7 | 0.103 | 0.12 | 0.129 | 0.15 | -0.11 |
| 23095 | 707.5 | 1RB_High | Right | Touch | Fig.19 | 24.95 | 25.7 | 0.191 | 0.23 | 0.244 | 0.29 | 0.08 |
| 23095 | 707.5 | 1RB_High | Right | Tilt | / | 24.95 | 25.7 | 0.134 | 0.16 | 0.170 | 0.20 | 0.04 |
| 23095 | 707.5 | 25RB_Low | Left | Touch | / | 23.91 | 24.7 | 0.157 | 0.19 | 0.198 | 0.24 | -0.04 |
| 23095 | 707.5 | 25RB_Low | Left | Tilt | / | 23.91 | 24.7 | 0.096 | 0.11 | 0.122 | 0.15 | 0.07 |
| 23095 | 707.5 | 25RB_Low | Right | Touch | / | 23.91 | 24.7 | 0.179 | 0.21 | 0.229 | 0.27 | 0.14 |
| 23095 | 707.5 | 25RB_Low | Right | Tilt | / | 23.91 | 24.7 | 0.118 | 0.14 | 0.149 | 0.18 | 0.13 |

Note1: The LTE mode is QPSK_10MHz.

Table 14.1-20: SAR Values (LTE Band12 - Body)

| Frequency | | Mode | Test Position | Figure No. | Conducted Power (dBm) | Max. tune-up Power (dBm) | Measured SAR(10g) (W/kg) | Reported SAR(10g) (W/kg) | Measured SAR(1g) (W/kg) | Reported SAR(1g) (W/kg) | Power Drift (dB) |
|---|-------|----------|---------------|------------|-----------------------|--------------------------|--------------------------|--------------------------|-------------------------|-------------------------|------------------|
| Ch. | MHz | | | | | | | | | | |
| Ambient Temperature: 22.9°C Liquid Temperature: 22.5°C | | | | | | | | | | | |
| 23095 | 707.5 | 1RB_Low | Front | / | 24.95 | 25.7 | 0.123 | 0.15 | 0.167 | 0.20 | 0.10 |
| 23095 | 707.5 | 1RB_Low | Rear | / | 24.95 | 25.7 | 0.164 | 0.19 | 0.222 | 0.26 | -0.12 |
| 23095 | 707.5 | 1RB_Low | Left | / | 24.95 | 25.7 | 0.103 | 0.12 | 0.151 | 0.18 | -0.11 |
| 23095 | 707.5 | 1RB_Low | Right | Fig.20 | 24.95 | 25.7 | 0.172 | 0.20 | 0.249 | 0.30 | 0.13 |
| 23095 | 707.5 | 1RB_Low | Bottom | / | 24.95 | 25.7 | 0.074 | 0.09 | 0.141 | 0.17 | 0.02 |
| 23095 | 707.5 | 25RB_Mid | Front | / | 23.91 | 24.7 | 0.112 | 0.13 | 0.150 | 0.18 | 0.02 |
| 23095 | 707.5 | 25RB_Mid | Rear | / | 23.91 | 24.7 | 0.156 | 0.19 | 0.211 | 0.25 | 0.15 |
| 23095 | 707.5 | 25RB_Mid | Left | / | 23.91 | 24.7 | 0.095 | 0.11 | 0.138 | 0.17 | 0.16 |
| 23095 | 707.5 | 25RB_Mid | Right | / | 23.91 | 24.7 | 0.159 | 0.19 | 0.231 | 0.28 | 0.02 |
| 23095 | 707.5 | 25RB_Mid | Bottom | / | 23.91 | 24.7 | 0.065 | 0.08 | 0.126 | 0.15 | -0.17 |

Note1: The distance between the EUT and the phantom bottom is 10mm.

Note2: The LTE mode is QPSK_10MHz.

Table 14.1-21: SAR Values (LTE Band13 - Head)

| Frequency | | Mode | Side | Test Position | Figure No. | Conducted Power (dBm) | Max. tune-up Power (dBm) | Measured SAR(10g) (W/kg) | Reported SAR(10g) (W/kg) | Measured SAR(1g) (W/kg) | Reported SAR(1g) (W/kg) | Power Drift (dB) |
|-----------|-----|----------|-------|---------------|------------|-----------------------|--------------------------|--------------------------|--------------------------|-------------------------|-------------------------|------------------|
| Ch. | MHz | | | | | | | | | | | |
| 23230 | 782 | 1RB_Low | Left | Touch | / | 23.96 | 25 | 0.167 | 0.21 | 0.211 | 0.27 | 0.02 |
| 23230 | 782 | 1RB_Low | Left | Tilt | / | 23.96 | 25 | 0.114 | 0.14 | 0.145 | 0.18 | 0.14 |
| 23230 | 782 | 1RB_Low | Right | Touch | Fig.21 | 23.96 | 25 | 0.180 | 0.23 | 0.231 | 0.29 | 0.10 |
| 23230 | 782 | 1RB_Low | Right | Tilt | / | 23.96 | 25 | 0.117 | 0.15 | 0.146 | 0.19 | -0.12 |
| 23230 | 782 | 25RB_Low | Left | Touch | / | 22.82 | 24 | 0.128 | 0.17 | 0.161 | 0.21 | 0.14 |
| 23230 | 782 | 25RB_Low | Left | Tilt | / | 22.82 | 24 | 0.086 | 0.11 | 0.109 | 0.14 | 0.13 |
| 23230 | 782 | 25RB_Low | Right | Touch | / | 22.82 | 24 | 0.140 | 0.18 | 0.179 | 0.24 | -0.13 |
| 23230 | 782 | 25RB_Low | Right | Tilt | / | 22.82 | 24 | 0.091 | 0.12 | 0.114 | 0.15 | -0.08 |

Note1: The LTE mode is QPSK_10MHz.

Table 14.1-22: SAR Values (LTE Band13 - Body)

| Frequency | | Mode | Test Position | Figure No. | Conducted Power (dBm) | Max. tune-up Power (dBm) | Measured SAR(10g) (W/kg) | Reported SAR(10g) (W/kg) | Measured SAR(1g) (W/kg) | Reported SAR(1g) (W/kg) | Power Drift (dB) |
|-----------|-----|-----------|---------------|------------|-----------------------|--------------------------|--------------------------|--------------------------|-------------------------|-------------------------|------------------|
| Ch. | MHz | | | | | | | | | | |
| 23230 | 782 | 1RB_Low | Front | / | 23.96 | 25 | 0.207 | 0.26 | 0.264 | 0.34 | 0.06 |
| 23230 | 782 | 1RB_Low | Rear | Fig.22 | 23.96 | 25 | 0.307 | 0.39 | 0.402 | 0.51 | -0.14 |
| 23230 | 782 | 1RB_Low | Left | / | 23.96 | 25 | 0.117 | 0.15 | 0.163 | 0.21 | 0.05 |
| 23230 | 782 | 1RB_Low | Right | / | 23.96 | 25 | 0.235 | 0.30 | 0.335 | 0.43 | 0.02 |
| 23230 | 782 | 1RB_Low | Bottom | / | 23.96 | 25 | 0.108 | 0.14 | 0.182 | 0.23 | 0.15 |
| 23230 | 782 | 25RB_High | Front | / | 22.82 | 24 | 0.161 | 0.21 | 0.205 | 0.27 | -0.11 |
| 23230 | 782 | 25RB_High | Rear | / | 22.82 | 24 | 0.235 | 0.31 | 0.306 | 0.40 | 0.13 |
| 23230 | 782 | 25RB_High | Left | / | 22.82 | 24 | 0.092 | 0.12 | 0.127 | 0.17 | -0.11 |
| 23230 | 782 | 25RB_High | Right | / | 22.82 | 24 | 0.177 | 0.23 | 0.252 | 0.33 | 0.08 |
| 23230 | 782 | 25RB_High | Bottom | / | 22.82 | 24 | 0.083 | 0.11 | 0.140 | 0.18 | 0.02 |

Note1: The distance between the EUT and the phantom bottom is 10mm.

Note2: The LTE mode is QPSK_10MHz.

Table 14.1-23: SAR Values (LTE Band25 - Head)

| Frequency | | Mode | Side | Test Position | Figure No. | Conducted Power (dBm) | tune-up Power (dBm) | Measured SAR(10g) (W/kg) | Reported SAR(10g) (W/kg) | Measured SAR(1g) (W/kg) | Reported SAR(1g) (W/kg) | Power Drift (dB) |
|-----------|------|----------|-------|---------------|------------|-----------------------|---------------------|--------------------------|--------------------------|-------------------------|-------------------------|------------------|
| Ch. | MHz | | | | | | | | | | | |
| 26590 | 1905 | 1RB_Mid | Left | Touch | / | 18.51 | 19.5 | 0.241 | 0.30 | 0.374 | 0.47 | 0.02 |
| 26590 | 1905 | 1RB_Mid | Left | Tilt | / | 18.51 | 19.5 | 0.263 | 0.33 | 0.452 | 0.57 | -0.12 |
| 26590 | 1905 | 1RB_Mid | Right | Touch | Fig.23 | 18.51 | 19.5 | 0.334 | 0.42 | 0.569 | 0.71 | 0.13 |
| 26590 | 1905 | 1RB_Mid | Right | Tilt | / | 18.51 | 19.5 | 0.293 | 0.37 | 0.529 | 0.66 | -0.06 |
| 26590 | 1905 | 25RB_Mid | Left | Touch | / | 17.48 | 18.5 | 0.191 | 0.24 | 0.298 | 0.38 | -0.05 |
| 26590 | 1905 | 25RB_Mid | Left | Tilt | / | 17.48 | 18.5 | 0.206 | 0.26 | 0.354 | 0.45 | 0.06 |
| 26590 | 1905 | 25RB_Mid | Right | Touch | / | 17.48 | 18.5 | 0.267 | 0.34 | 0.455 | 0.57 | -0.13 |
| 26590 | 1905 | 25RB_Mid | Right | Tilt | / | 17.48 | 18.5 | 0.234 | 0.30 | 0.422 | 0.53 | 0.12 |

Note1: The LTE mode is QPSK_20MHz.

Table 14.1-24: SAR Values (LTE Band25 - Body)

| Frequency | | Mode | Test Position | Figure No. | Conducted Power (dBm) | tune-up Power (dBm) | Measured SAR(10g) (W/kg) | Reported SAR(10g) (W/kg) | Measured SAR(1g) (W/kg) | Reported SAR(1g) (W/kg) | Power Drift (dB) |
|-----------|--------|----------|---------------|------------|-----------------------|---------------------|--------------------------|--------------------------|-------------------------|-------------------------|------------------|
| Ch. | MHz | | | | | | | | | | |
| 26365 | 1882.5 | 1RB_Mid | Front | Note2 | 23.79 | 25 | 0.116 | 0.15 | 0.183 | 0.24 | -0.12 |
| 26365 | 1882.5 | 1RB_Mid | Rear | Note3 | 23.79 | 25 | 0.167 | 0.22 | 0.276 | 0.36 | 0.03 |
| 26365 | 1882.5 | 1RB_Mid | Left | / | 23.79 | 25 | 0.096 | 0.13 | 0.165 | 0.22 | 0.08 |
| 26365 | 1882.5 | 1RB_Mid | Right | / | 23.79 | 25 | 0.049 | 0.07 | 0.079 | 0.10 | -0.12 |
| 26365 | 1882.5 | 1RB_Mid | Top | Note4 | 23.79 | 25 | 0.196 | 0.26 | 0.330 | 0.44 | 0.14 |
| 26365 | 1882.5 | 50RB_Mid | Front | Note2 | 22.71 | 24 | 0.096 | 0.13 | 0.151 | 0.20 | 0.13 |
| 26365 | 1882.5 | 50RB_Mid | Rear | Note3 | 22.71 | 24 | 0.137 | 0.18 | 0.228 | 0.31 | 0.13 |
| 26365 | 1882.5 | 50RB_Mid | Left | / | 22.71 | 24 | 0.080 | 0.11 | 0.139 | 0.19 | 0.02 |
| 26365 | 1882.5 | 50RB_Mid | Right | / | 22.71 | 24 | 0.039 | 0.05 | 0.062 | 0.08 | 0.02 |
| 26365 | 1882.5 | 50RB_Mid | Top | Note4 | 22.71 | 24 | 0.164 | 0.22 | 0.275 | 0.37 | -0.08 |
| 26590 | 1905 | 1RB_Mid | Front | / | 18.51 | 19.5 | 0.146 | 0.18 | 0.226 | 0.28 | 0.13 |
| 26590 | 1905 | 1RB_Mid | Rear | Fig.24 | 18.51 | 19.5 | 0.250 | 0.31 | 0.427 | 0.54 | 0.02 |
| 26590 | 1905 | 1RB_Mid | Top | / | 18.51 | 19.5 | 0.237 | 0.30 | 0.414 | 0.52 | 0.02 |
| 26590 | 1905 | 25RB_Mid | Front | / | 17.48 | 18.5 | 0.119 | 0.15 | 0.184 | 0.23 | -0.11 |
| 26590 | 1905 | 25RB_Mid | Rear | / | 17.48 | 18.5 | 0.198 | 0.25 | 0.338 | 0.43 | -0.05 |
| 26590 | 1905 | 25RB_Mid | Top | / | 17.48 | 18.5 | 0.185 | 0.23 | 0.322 | 0.41 | 0.02 |

Note1: The distance between the EUT and the phantom bottom is 10mm

Note2: The distance between the EUT and the phantom bottom is 16mm by sensor (See detail in annex I).

Note3: The distance between the EUT and the phantom bottom is 18mm by sensor (See detail in annex I).

Note4: The distance between the EUT and the phantom bottom is 17mm by sensor (See detail in annex I).

Note5: The LTE mode is QPSK_20MHz.

Table 14.1-25: SAR Values (LTE Band26 - Head)

| Frequency | | Mode | Side | Test Position | Figure No. | Conducted Power (dBm) | tune-up Power (dBm) | Measured SAR(10g) (W/kg) | Reported SAR(10g) (W/kg) | Measured SAR(1g) (W/kg) | Reported SAR(1g) (W/kg) | Power Drift (dB) |
|-----------|-------|----------|-------|---------------|------------|-----------------------|---------------------|--------------------------|--------------------------|-------------------------|-------------------------|------------------|
| Ch. | MHz | | | | | | | | | | | |
| 26965 | 841.5 | 1RB_High | Left | Touch | / | 25.51 | 25.7 | 0.209 | 0.22 | 0.272 | 0.28 | 0.15 |
| 26965 | 841.5 | 1RB_High | Left | Tilt | / | 25.51 | 25.7 | 0.141 | 0.15 | 0.182 | 0.19 | 0.16 |
| 26965 | 841.5 | 1RB_High | Right | Touch | Fig.25 | 25.51 | 25.7 | 0.240 | 0.25 | 0.317 | 0.33 | 0.02 |
| 26965 | 841.5 | 1RB_High | Right | Tilt | / | 25.51 | 25.7 | 0.155 | 0.16 | 0.194 | 0.20 | 0.03 |
| 26965 | 841.5 | 36RB_Low | Left | Touch | / | 24.38 | 24.7 | 0.241 | 0.26 | 0.313 | 0.34 | 0.08 |
| 26965 | 841.5 | 36RB_Low | Left | Tilt | / | 24.38 | 24.7 | 0.165 | 0.18 | 0.207 | 0.22 | 0.15 |
| 26965 | 841.5 | 36RB_Low | Right | Touch | / | 24.38 | 24.7 | 0.265 | 0.29 | 0.350 | 0.38 | -0.11 |
| 26965 | 841.5 | 36RB_Low | Right | Tilt | / | 24.38 | 24.7 | 0.191 | 0.21 | 0.239 | 0.26 | 0.13 |

Note1: The LTE mode is QPSK_15MHz.

Table 14.1-26: SAR Values (LTE Band26 - Body)

| Frequency | | Mode | Test Position | Figure No. | Conducted Power (dBm) | tune-up Power (dBm) | Measured SAR(10g) (W/kg) | Reported SAR(10g) (W/kg) | Measured SAR(1g) (W/kg) | Reported SAR(1g) (W/kg) | Power Drift (dB) |
|-----------|-------|----------|---------------|------------|-----------------------|---------------------|--------------------------|--------------------------|-------------------------|-------------------------|------------------|
| Ch. | MHz | | | | | | | | | | |
| 26965 | 841.5 | 1RB_High | Front | / | 25.51 | 25.7 | 0.196 | 0.20 | 0.324 | 0.34 | 0.07 |
| 26965 | 841.5 | 1RB_High | Rear | Fig.26 | 25.51 | 25.7 | 0.286 | 0.30 | 0.480 | 0.50 | 0.14 |
| 26965 | 841.5 | 1RB_High | Left | / | 25.51 | 25.7 | 0.141 | 0.15 | 0.216 | 0.23 | 0.13 |
| 26965 | 841.5 | 1RB_High | Right | / | 25.51 | 25.7 | 0.253 | 0.26 | 0.387 | 0.40 | -0.05 |
| 26965 | 841.5 | 1RB_High | Bottom | / | 25.51 | 25.7 | 0.187 | 0.20 | 0.347 | 0.36 | 0.06 |
| 26965 | 841.5 | 36RB_Low | Front | / | 24.38 | 24.7 | 0.269 | 0.29 | 0.380 | 0.41 | -0.13 |
| 26965 | 841.5 | 36RB_Low | Rear | / | 24.38 | 24.7 | 0.326 | 0.35 | 0.550 | 0.59 | 0.02 |
| 26965 | 841.5 | 36RB_Low | Left | / | 24.38 | 24.7 | 0.175 | 0.19 | 0.266 | 0.29 | 0.03 |
| 26965 | 841.5 | 36RB_Low | Right | / | 24.38 | 24.7 | 0.303 | 0.33 | 0.465 | 0.50 | 0.08 |
| 26965 | 841.5 | 36RB_Low | Bottom | / | 24.38 | 24.7 | 0.196 | 0.21 | 0.372 | 0.40 | 0.02 |

Note1: The distance between the EUT and the phantom bottom is 10mm

Note2: The LTE mode is QPSK_15MHz.

Table 14.1-27-a: SAR Values (LTE Band41 PC2 - Head)

| Frequency | | Mode | Side | Test Position | Figure No. | Conducted Power (dBm) | tune-up Power (dBm) | Measured SAR(10g) (W/kg) | Reported SAR(10g) (W/kg) | Measured SAR(1g) (W/kg) | Reported SAR(1g) (W/kg) | Power Drift (dB) |
|---|------|-----------|-------|---------------|------------|-----------------------|---------------------|--------------------------|--------------------------|-------------------------|-------------------------|------------------|
| Ch. | MHz | | | | | | | | | | | |
| Ambient Temperature: 22.9°C Liquid Temperature: 22.5°C | | | | | | | | | | | | |
| 40620 | 2593 | 1RB_High | Left | Touch | / | 23.66 | 24 | 0.051 | 0.06 | 0.096 | 0.10 | -0.13 |
| 40620 | 2593 | 1RB_High | Left | Tilt | Fig.27 | 23.66 | 24 | 0.076 | 0.08 | 0.143 | 0.15 | 0.02 |
| 40620 | 2593 | 1RB_High | Right | Touch | / | 23.66 | 24 | 0.068 | 0.07 | 0.124 | 0.13 | -0.12 |
| 40620 | 2593 | 1RB_High | Right | Tilt | / | 23.66 | 24 | 0.061 | 0.07 | 0.116 | 0.13 | 0.14 |
| 40620 | 2593 | 50RB_High | Left | Touch | / | 22.77 | 23 | 0.052 | 0.05 | 0.097 | 0.10 | 0.13 |
| 40620 | 2593 | 50RB_High | Left | Tilt | / | 22.77 | 23 | 0.075 | 0.08 | 0.140 | 0.15 | -0.05 |
| 40620 | 2593 | 50RB_High | Right | Touch | / | 22.77 | 23 | 0.065 | 0.07 | 0.120 | 0.13 | 0.13 |
| 40620 | 2593 | 50RB_High | Right | Tilt | / | 22.77 | 23 | 0.601 | 0.63 | 0.114 | 0.12 | -0.06 |

Note1: The LTE mode is QPSK_20MHz.

Table 14.1-27-b: SAR Values (LTE Band41 PC3 - Head)

| Frequency | | Mode | Side | Test Position | Figure No. | Conducted Power (dBm) | tune-up Power (dBm) | Measured SAR(10g) (W/kg) | Reported SAR(10g) (W/kg) | Measured SAR(1g) (W/kg) | Reported SAR(1g) (W/kg) | Power Drift (dB) |
|---|------|----------|-------|---------------|------------|-----------------------|---------------------|--------------------------|--------------------------|-------------------------|-------------------------|------------------|
| Ch. | MHz | | | | | | | | | | | |
| Ambient Temperature: 22.9°C Liquid Temperature: 22.5°C | | | | | | | | | | | | |
| 39750 | 2506 | 1RB_High | Left | Touch | Fig.27 | 22.97 | 24 | 0.094 | 0.12 | 0.150 | 0.19 | -0.11 |
| 39750 | 2506 | 1RB_High | Left | Tilt | / | 22.97 | 24 | 0.073 | 0.09 | 0.116 | 0.15 | -0.05 |
| 39750 | 2506 | 1RB_High | Right | Touch | / | 22.97 | 24 | 0.066 | 0.08 | 0.105 | 0.13 | 0.02 |
| 39750 | 2506 | 1RB_High | Right | Tilt | / | 22.97 | 24 | 0.059 | 0.07 | 0.093 | 0.12 | -0.12 |
| 39750 | 2506 | 50RB_Mid | Left | Touch | / | 21.72 | 23 | 0.065 | 0.09 | 0.103 | 0.14 | 0.14 |
| 39750 | 2506 | 50RB_Mid | Left | Tilt | / | 21.72 | 23 | 0.051 | 0.07 | 0.080 | 0.11 | 0.10 |
| 39750 | 2506 | 50RB_Mid | Right | Touch | / | 21.72 | 23 | 0.048 | 0.06 | 0.076 | 0.10 | -0.12 |
| 39750 | 2506 | 50RB_Mid | Right | Tilt | / | 21.72 | 23 | 0.039 | 0.05 | 0.061 | 0.08 | 0.14 |
| 39750 | 2506 | 100RB | Left | Touch | ULCA | 22.91 | 24 | 0.057 | 0.07 | 0.105 | 0.13 | 0.09 |

Note1: The LTE mode is QPSK_20MHz.

Table 14.1-28-a: SAR Values (LTE Band41 PC2 - Body)

| Frequency | | Mode | Test Position | Figure No. | Ambient Temperature: 22.9°C | | Liquid Temperature: 22.5°C | | Measured SAR(1g) (W/kg) | Reported SAR(1g) (W/kg) | Power Drift (dB) |
|-----------|--------|-----------|---------------|------------|-----------------------------|---------------------|----------------------------|--------------------------|-------------------------|-------------------------|------------------|
| Ch. | MHz | | | | Conduct ed Power (dBm) | tune-up Power (dBm) | Measured SAR(10g) (W/kg) | Reported SAR(10g) (W/kg) | | | |
| 40185 | 2549.5 | 1RB_High | Front | Note2 | 27.41 | 28.4 | 0.126 | 0.16 | 0.228 | 0.29 | 0.14 |
| 40185 | 2549.5 | 1RB_High | Rear | Note3 | 27.41 | 28.4 | 0.208 | 0.26 | 0.398 | 0.50 | -0.07 |
| 40185 | 2549.5 | 1RB_High | Left | / | 27.41 | 28.4 | 0.153 | 0.19 | 0.286 | 0.36 | 0.07 |
| 40185 | 2549.5 | 1RB_High | Right | Note4 | 27.41 | 28.4 | 0.128 | 0.16 | 0.232 | 0.29 | -0.06 |
| 40185 | 2549.5 | 1RB_High | Bottom | Note5 | 27.41 | 28.4 | 0.166 | 0.21 | 0.306 | 0.38 | -0.05 |
| 40185 | 2549.5 | 50RB_High | Front | Note2 | 26.17 | 27.4 | 0.121 | 0.16 | 0.221 | 0.29 | 0.06 |
| 40185 | 2549.5 | 50RB_High | Rear | Note3 | 26.17 | 27.4 | 0.203 | 0.27 | 0.389 | 0.52 | -0.13 |
| 40185 | 2549.5 | 50RB_High | Left | / | 26.17 | 27.4 | 0.150 | 0.20 | 0.279 | 0.37 | -0.02 |
| 40185 | 2549.5 | 50RB_High | Right | Note4 | 26.17 | 27.4 | 0.125 | 0.17 | 0.226 | 0.30 | 0.06 |
| 40185 | 2549.5 | 50RB_High | Bottom | Note5 | 26.17 | 27.4 | 0.161 | 0.21 | 0.290 | 0.39 | 0.06 |
| 40185 | 2549.5 | 1RB_Mid | Front | / | 23.80 | 24 | 0.134 | 0.14 | 0.255 | 0.27 | -0.16 |
| 40185 | 2549.5 | 1RB_Mid | Rear | / | 23.80 | 24 | 0.295 | 0.31 | 0.608 | 0.64 | 0.04 |
| 40185 | 2549.5 | 1RB_Mid | Right | / | 23.80 | 24 | 0.088 | 0.09 | 0.167 | 0.17 | 0.14 |
| 40185 | 2549.5 | 1RB_Mid | Bottom | Fig.28 | 23.80 | 24 | 0.307 | 0.32 | 0.631 | 0.66 | 0.10 |
| 40185 | 2549.5 | 50RB_Mid | Front | / | 22.77 | 23 | 0.106 | 0.11 | 0.202 | 0.21 | -0.12 |
| 40185 | 2549.5 | 50RB_Mid | Rear | / | 22.77 | 23 | 0.237 | 0.25 | 0.507 | 0.53 | 0.06 |
| 40185 | 2549.5 | 50RB_Mid | Right | / | 22.77 | 23 | 0.069 | 0.07 | 0.131 | 0.14 | -0.13 |
| 40185 | 2549.5 | 50RB_Mid | Bottom | / | 22.77 | 23 | 0.241 | 0.25 | 0.502 | 0.53 | 0.02 |

Note1: The distance between the EUT and the phantom bottom is 10mm.

Note2: The distance between the EUT and the phantom bottom is 16mm by sensor (See detail in annex I).

Note3: The distance between the EUT and the phantom bottom is 18mm by sensor (See detail in annex I).

Note4: The distance between the EUT and the phantom bottom is 11mm by sensor (See detail in annex I).

Note5: The distance between the EUT and the phantom bottom is 25mm by sensor (See detail in annex I).

Note6: The LTE mode is QPSK_20MHz.

Table 14.1-28-b: SAR Values (LTE Band41 PC3 - Body)

| Frequency | | Mode | Test Position | Figure No. | Ambient Temperature: 22.9 °C | | Liquid Temperature: 22.5 °C | | | | Power Drift (dB) |
|-----------|------|----------|---------------|------------|------------------------------|---------------------|-----------------------------|--------------------------|-------------------------|-------------------------|------------------|
| Ch. | MHz | | | | Conducted Power (dBm) | tune-up Power (dBm) | Measured SAR(10g) (W/kg) | Reported SAR(10g) (W/kg) | Measured SAR(1g) (W/kg) | Reported SAR(1g) (W/kg) | |
| 39750 | 2506 | 1RB_High | Front | Note2 | 23.97 | 25 | 0.011 | 0.01 | 0.021 | 0.03 | 0.13 |
| 39750 | 2506 | 1RB_High | Rear | Note3 | 23.97 | 25 | 0.027 | 0.03 | 0.057 | 0.07 | 0.13 |
| 39750 | 2506 | 1RB_High | Left | / | 23.97 | 25 | 0.010 | 0.01 | 0.020 | 0.03 | -0.06 |
| 39750 | 2506 | 1RB_High | Right | Note4 | 23.97 | 25 | 0.011 | 0.01 | 0.022 | 0.03 | -0.05 |
| 39750 | 2506 | 1RB_High | Bottom | Note5 | 23.97 | 25 | 0.014 | 0.02 | 0.027 | 0.03 | 0.06 |
| 39750 | 2506 | 50RB_Mid | Front | Note2 | 22.73 | 24 | 0.009 | 0.01 | 0.018 | 0.02 | -0.13 |
| 39750 | 2506 | 50RB_Mid | Rear | Note3 | 22.73 | 24 | 0.022 | 0.03 | 0.046 | 0.06 | 0.02 |
| 39750 | 2506 | 50RB_Mid | Left | / | 22.73 | 24 | 0.007 | 0.01 | 0.014 | 0.02 | -0.12 |
| 39750 | 2506 | 50RB_Mid | Right | Note4 | 22.73 | 24 | 0.009 | 0.01 | 0.017 | 0.02 | 0.14 |
| 39750 | 2506 | 50RB_Mid | Bottom | Note5 | 22.73 | 24 | 0.011 | 0.01 | 0.021 | 0.03 | 0.08 |
| 39750 | 2506 | 1RB_High | Front | / | 22.97 | 24 | 0.104 | 0.13 | 0.176 | 0.22 | 0.15 |
| 39750 | 2506 | 1RB_High | Rear | Fig.28 | 22.97 | 24 | 0.197 | 0.25 | 0.368 | 0.47 | -0.11 |
| 39750 | 2506 | 1RB_High | Right | / | 22.97 | 24 | 0.057 | 0.07 | 0.093 | 0.12 | -0.11 |
| 39750 | 2506 | 1RB_High | Bottom | / | 22.97 | 24 | 0.197 | 0.25 | 0.367 | 0.46 | 0.02 |
| 39750 | 2506 | 50RB_Mid | Front | / | 21.72 | 23 | 0.075 | 0.10 | 0.127 | 0.17 | -0.12 |
| 39750 | 2506 | 50RB_Mid | Rear | / | 21.72 | 23 | 0.153 | 0.21 | 0.286 | 0.38 | 0.14 |
| 39750 | 2506 | 50RB_Mid | Right | / | 21.72 | 23 | 0.046 | 0.06 | 0.073 | 0.10 | -0.05 |
| 39750 | 2506 | 50RB_Mid | Bottom | / | 21.72 | 23 | 0.159 | 0.21 | 0.299 | 0.40 | 0.04 |
| 39750 | 2506 | 100RB | Rear | ULCA | 22.91 | 24 | 0.186 | 0.24 | 0.332 | 0.43 | -0.09 |

Note1: The distance between the EUT and the phantom bottom is 10mm.

Note2: The distance between the EUT and the phantom bottom is 16mm by sensor (See detail in annex I).

Note3: The distance between the EUT and the phantom bottom is 18mm by sensor (See detail in annex I).

Note4: The distance between the EUT and the phantom bottom is 11mm by sensor (See detail in annex I).

Note5: The distance between the EUT and the phantom bottom is 25mm by sensor (See detail in annex I).

Note6: The LTE mode is QPSK_20M

Table 14.1-29: SAR Values (LTE Band66 - Head)

| Frequency | | Ambient Temperature: 22.9 °C | | | | | | Liquid Temperature: 22.5 °C | | | | |
|-----------|------|------------------------------|-------|---------------|------------|-----------------------|--------------------------|-----------------------------|--------------------------|-------------------------|-------------------------|------------------|
| Ch. | MHz | Mode | Side | Test Position | Figure No. | Conducted Power (dBm) | Max. tune-up Power (dBm) | Measured SAR(10g) (W/kg) | Reported SAR(10g) (W/kg) | Measured SAR(1g) (W/kg) | Reported SAR(1g) (W/kg) | Power Drift (dB) |
| 132322 | 1745 | 1RB_High | Left | Touch | / | 18.71 | 19.5 | 0.254 | 0.30 | 0.412 | 0.49 | 0.02 |
| 132322 | 1745 | 1RB_High | Left | Tilt | / | 18.71 | 19.5 | 0.281 | 0.34 | 0.498 | 0.60 | -0.12 |
| 132322 | 1745 | 1RB_High | Right | Touch | / | 18.71 | 19.5 | 0.326 | 0.39 | 0.596 | 0.72 | 0.14 |
| 132322 | 1745 | 1RB_High | Right | Tilt | Fig.29 | 18.71 | 19.5 | 0.332 | 0.40 | 0.654 | 0.78 | 0.10 |
| 132322 | 1745 | 50RB_High | Left | Touch | / | 17.33 | 18.5 | 0.180 | 0.24 | 0.290 | 0.38 | 0.09 |
| 132322 | 1745 | 50RB_High | Left | Tilt | / | 17.33 | 18.5 | 0.201 | 0.26 | 0.356 | 0.47 | -0.12 |
| 132322 | 1745 | 50RB_High | Right | Touch | / | 17.33 | 18.5 | 0.230 | 0.30 | 0.422 | 0.55 | 0.14 |
| 132322 | 1745 | 50RB_High | Right | Tilt | / | 17.33 | 18.5 | 0.237 | 0.31 | 0.468 | 0.61 | 0.13 |

Note1: The LTE mode is QPSK_20MHz.

Table 14.1-30: SAR Values (LTE Band66 - Body)

| Frequency | | Ambient Temperature: 22.9 °C | | | | | | Liquid Temperature: 22.5 °C | | | | |
|-----------|------|------------------------------|---------------|--------------|-----------------------|--------------------------|--------------------------|-----------------------------|-------------------------|-------------------------|------------------|--|
| Ch. | MHz | Mode | Test Position | Figure No. | Conducted Power (dBm) | Max. tune-up Power (dBm) | Measured SAR(10g) (W/kg) | Reported SAR(10g) (W/kg) | Measured SAR(1g) (W/kg) | Reported SAR(1g) (W/kg) | Power Drift (dB) | |
| 132072 | 1720 | 1RB_High | Front | Note2 | 23.96 | 25 | 0.106 | 0.13 | 0.172 | 0.22 | 0.04 | |
| 132072 | 1720 | 1RB_High | Rear | Note3 | 23.96 | 25 | 0.122 | 0.16 | 0.205 | 0.26 | 0.02 | |
| 132072 | 1720 | 1RB_High | Left | / | 23.96 | 25 | 0.067 | 0.09 | 0.123 | 0.16 | -0.05 | |
| 132072 | 1720 | 1RB_High | Right | / | 23.96 | 25 | 0.055 | 0.07 | 0.093 | 0.12 | 0.06 | |
| 132072 | 1720 | 1RB_High | Top | Note4 Fig.30 | 23.96 | 25 | 0.127 | 0.16 | 0.226 | 0.29 | -0.16 | |
| 132072 | 1720 | 50RB_Mid | Front | Note2 | 22.79 | 24 | 0.072 | 0.10 | 0.116 | 0.15 | 0.04 | |
| 132072 | 1720 | 50RB_Mid | Rear | Note3 | 22.79 | 24 | 0.081 | 0.11 | 0.137 | 0.18 | -0.12 | |
| 132072 | 1720 | 50RB_Mid | Left | / | 22.79 | 24 | 0.043 | 0.06 | 0.080 | 0.11 | 0.06 | |
| 132072 | 1720 | 50RB_Mid | Right | / | 22.79 | 24 | 0.037 | 0.05 | 0.063 | 0.08 | -0.13 | |
| 132072 | 1720 | 50RB_Mid | Top | Note4 | 22.79 | 24 | 0.085 | 0.11 | 0.151 | 0.20 | -0.11 | |
| 132322 | 1745 | 1RB_High | Front | / | 18.71 | 19.5 | 0.112 | 0.13 | 0.197 | 0.24 | 0.05 | |
| 132322 | 1745 | 1RB_High | Rear | / | 18.71 | 19.5 | 0.208 | 0.25 | 0.392 | 0.47 | -0.07 | |
| 132322 | 1745 | 1RB_High | Top | / | 18.71 | 19.5 | 0.183 | 0.22 | 0.352 | 0.42 | 0.07 | |
| 132322 | 1745 | 50RB_Mid | Front | / | 17.33 | 18.5 | 0.078 | 0.10 | 0.138 | 0.18 | -0.09 | |
| 132322 | 1745 | 50RB_Mid | Rear | / | 17.33 | 18.5 | 0.143 | 0.19 | 0.271 | 0.35 | 0.09 | |
| 132322 | 1745 | 50RB_Mid | Top | / | 17.33 | 18.5 | 0.126 | 0.16 | 0.242 | 0.32 | -0.12 | |

Note1: The distance between the EUT and the phantom bottom is 10mm

Note2: The distance between the EUT and the phantom bottom is 16mm by sensor (See detail in annex I).

Note3: The distance between the EUT and the phantom bottom is 18mm by sensor (See detail in annex I).

Note4: The distance between the EUT and the phantom bottom is 17mm by sensor (See detail in annex I).

Note5: The LTE mode is QPSK_20MHz.

Table 14.1-31: SAR Values (LTE Band71 - Head)

| Frequency | | Ambient Temperature: 22.9°C | | | | | Liquid Temperature: 22.5°C | | | | | |
|-----------|-----|-----------------------------|-------|---------------|------------|-----------------------|----------------------------|--------------------------|--------------------------|-------------------------|-------------------------|------------------|
| Ch. | MHz | Mode | Side | Test Position | Figure No. | Conducted Power (dBm) | Max. tune-up Power (dBm) | Measured SAR(10g) (W/kg) | Reported SAR(10g) (W/kg) | Measured SAR(1g) (W/kg) | Reported SAR(1g) (W/kg) | Power Drift (dB) |
| 133222 | 673 | 1RB_Low | Left | Touch | / | 25.25 | 25.7 | 0.149 | 0.17 | 0.209 | 0.23 | 0.02 |
| 133222 | 673 | 1RB_Low | Left | Tilt | / | 25.25 | 25.7 | 0.033 | 0.04 | 0.050 | 0.06 | -0.05 |
| 133222 | 673 | 1RB_Low | Right | Touch | Fig.31 | 25.25 | 25.7 | 0.175 | 0.19 | 0.220 | 0.24 | 0.06 |
| 133222 | 673 | 1RB_Low | Right | Tilt | / | 25.25 | 25.7 | 0.072 | 0.08 | 0.102 | 0.11 | -0.16 |
| 133222 | 673 | 50RB_Low | Left | Touch | / | 23.74 | 24.7 | 0.087 | 0.11 | 0.122 | 0.15 | -0.01 |
| 133222 | 673 | 50RB_Low | Left | Tilt | / | 23.74 | 24.7 | 0.054 | 0.07 | 0.095 | 0.12 | 0.05 |
| 133222 | 673 | 50RB_Low | Right | Touch | / | 23.74 | 24.7 | 0.051 | 0.06 | 0.088 | 0.11 | -0.05 |
| 133222 | 673 | 50RB_Low | Right | Tilt | / | 23.74 | 24.7 | 0.039 | 0.05 | 0.065 | 0.08 | 0.03 |

Note1: The LTE mode is QPSK_20MHz.

Table 14.1-32: SAR Values (LTE Band71 - Body)

| Frequency | | Ambient Temperature: 22.9°C | | | | | Liquid Temperature: 22.5°C | | | | | |
|-----------|-----|-----------------------------|---------------|------------|-----------------------|--------------------------|----------------------------|--------------------------|-------------------------|-------------------------|------------------|--|
| Ch. | MHz | Mode | Test Position | Figure No. | Conducted Power (dBm) | Max. tune-up Power (dBm) | Measured SAR(10g) (W/kg) | Reported SAR(10g) (W/kg) | Measured SAR(1g) (W/kg) | Reported SAR(1g) (W/kg) | Power Drift (dB) | |
| 133222 | 673 | 1RB_Low | Front | Fig.32 | 25.25 | 25.7 | 0.136 | 0.15 | 0.175 | 0.19 | 0.11 | |
| 133222 | 673 | 1RB_Low | Rear | / | 25.25 | 25.7 | 0.074 | 0.08 | 0.094 | 0.10 | -0.14 | |
| 133222 | 673 | 1RB_Low | Left | / | 25.25 | 25.7 | 0.042 | 0.05 | 0.059 | 0.07 | -0.08 | |
| 133222 | 673 | 1RB_Low | Right | / | 25.25 | 25.7 | 0.069 | 0.08 | 0.095 | 0.11 | 0.02 | |
| 133222 | 673 | 1RB_Low | Bottom | / | 25.25 | 25.7 | 0.027 | 0.03 | 0.047 | 0.05 | 0.07 | |
| 133222 | 673 | 50RB_Low | Front | / | 23.74 | 24.7 | 0.118 | 0.15 | 0.150 | 0.19 | -0.05 | |
| 133222 | 673 | 50RB_Low | Rear | / | 23.74 | 24.7 | 0.065 | 0.08 | 0.083 | 0.10 | 0.07 | |
| 133222 | 673 | 50RB_Low | Left | / | 23.74 | 24.7 | 0.040 | 0.05 | 0.053 | 0.07 | -0.04 | |
| 133222 | 673 | 50RB_Low | Right | / | 23.74 | 24.7 | 0.064 | 0.08 | 0.087 | 0.11 | -0.11 | |
| 133222 | 673 | 50RB_Low | Bottom | / | 23.74 | 24.7 | 0.027 | 0.03 | 0.046 | 0.06 | -0.16 | |

Note1: The distance between the EUT and the phantom bottom is 10mm

Note2: The LTE mode is QPSK_20MHz.

14.2 SAR results for Standard procedure

There is zoom scan measurement to be added for the highest measured SAR in each exposure configuration/band.

Table 14.2-1: SAR Values (GSM 850 MHz Band - Head)

| Ambient Temperature: 22.9 °C | | | | | | Liquid Temperature: 22.5°C | | | | | |
|------------------------------|-------|-------|---------------|------------|-----------------------|----------------------------|--------------------------|--------------------------|-------------------------|-------------------------|------------------|
| Frequency | | Side | Test Position | Figure No. | Conducted Power (dBm) | Max. tune-up Power (dBm) | Measured SAR(10g) (W/kg) | Reported SAR(10g) (W/kg) | Measured SAR(1g) (W/kg) | Reported SAR(1g) (W/kg) | Power Drift (dB) |
| Ch. | MHz | | | | | | | | | | |
| 128 | 824.2 | Right | Touch | Fig.1 | 29.32 | 30.50 | 0.279 | 0.37 | 0.372 | 0.49 | 0.05 |

Note: the head SAR of GSM850 is tested with GPRS (3Txslots) mode because of VoIP.

Table 14.2-2: SAR Values (GSM 850 MHz Band - Body)

| Ambient Temperature: 22.9 °C | | | | | | Liquid Temperature: 22.5°C | | | | | |
|------------------------------|-------|----------------------------|---------------|------------|-----------------------|----------------------------|--------------------------|--------------------------|-------------------------|-------------------------|------------------|
| Frequency | | Mode (number of timeslots) | Test Position | Figure No. | Conducted Power (dBm) | Max. tune-up Power (dBm) | Measured SAR(10g) (W/kg) | Reported SAR(10g) (W/kg) | Measured SAR(1g) (W/kg) | Reported SAR(1g) (W/kg) | Power Drift (dB) |
| Ch. | MHz | | | | | | | | | | |
| 128 | 824.2 | GPRS (3) | Rear | Fig.2 | 29.32 | 30.50 | 0.440 | 0.58 | 0.578 | 0.76 | -0.05 |

Note: The distance between the EUT and the phantom bottom is 10mm.

Table 14.2-3: SAR Values (GSM 1900 MHz Band - Head)

| Ambient Temperature: 22.9 °C | | | | | | Liquid Temperature: 22.5°C | | | | | |
|------------------------------|--------|-------|---------------|------------|-----------------------|----------------------------|--------------------------|--------------------------|-------------------------|-------------------------|------------------|
| Frequency | | Side | Test Position | Figure No. | Conducted Power (dBm) | Max. tune-up Power (dBm) | Measured SAR(10g) (W/kg) | Reported SAR(10g) (W/kg) | Measured SAR(1g) (W/kg) | Reported SAR(1g) (W/kg) | Power Drift (dB) |
| Ch. | MHz | | | | | | | | | | |
| 512 | 1850.2 | Right | Touch | Fig.3 | 18.63 | 19.00 | 0.165 | 0.18 | 0.285 | 0.31 | 0.04 |

Note: the head SAR of GSM1900 is tested with GPRS (4Txslots) mode because of VoIP.

Table 14.2-4: SAR Values (GSM 1900 MHz Band - Body)

| Ambient Temperature: 22.9 °C | | | | | | Liquid Temperature: 22.5°C | | | | | |
|------------------------------|--------|----------------------------|---------------|------------|-----------------------|----------------------------|--------------------------|--------------------------|-------------------------|-------------------------|------------------|
| Frequency | | Mode (number of timeslots) | Test Position | Figure No. | Conducted Power (dBm) | Max. tune-up Power (dBm) | Measured SAR(10g) (W/kg) | Reported SAR(10g) (W/kg) | Measured SAR(1g) (W/kg) | Reported SAR(1g) (W/kg) | Power Drift (dB) |
| Ch. | MHz | | | | | | | | | | |
| 512 | 1850.2 | GPRS (4) | Rear | Fig.4 | 18.63 | 19.00 | 0.382 | 0.42 | 0.639 | 0.70 | 0.04 |

Note1: The distance between the EUT and the phantom bottom is 10mm

Table 14.2-5: SAR Values (WCDMA 1900 MHz Band - Head)

| Frequency | | Side | Test Position | Figure No. | Conducted Power (dBm) | Max. tune-up Power (dBm) | Measured SAR(10g) (W/kg) | Reported SAR(10g) (W/kg) | Measured SAR(1g) (W/kg) | Reported SAR(1g) (W/kg) | Power Drift (dB) |
|-----------|--------|------------------------------|---------------|------------|-----------------------|-----------------------------|--------------------------|--------------------------|-------------------------|-------------------------|------------------|
| Ch. | MHz | | | | | | | | | | |
| | | Ambient Temperature: 22.9 °C | | | | Liquid Temperature: 22.5 °C | | | | | |
| 9938 | 1907.6 | Right | Tilt | Fig.5 | 18.66 | 20.00 | 0.321 | 0.44 | 0.538 | 0.73 | 0.05 |

Table 14.2-6: SAR Values (WCDMA 1900 MHz Band - Body)

| Frequency | | Test Position | Figure No. | Conducted Power (dBm) | Max. tune-up Power (dBm) | Measured SAR(10g) (W/kg) | Reported SAR(10g) (W/kg) | Measured SAR(1g) (W/kg) | Reported SAR(1g) (W/kg) | Power Drift (dB) |
|-----------|--------|------------------------------|-------------|-----------------------|--------------------------|-----------------------------|--------------------------|-------------------------|-------------------------|------------------|
| Ch. | MHz | | | | | | | | | |
| | | Ambient Temperature: 22.9 °C | | | | Liquid Temperature: 22.5 °C | | | | |
| 9262 | 1852.4 | Rear | Note3 Fig.6 | 24.32 | 25.70 | 0.126 | 0.17 | 0.208 | 0.29 | -0.14 |

Note1: The distance between the EUT and the phantom bottom is 10mm

Note3: The distance between the EUT and the phantom bottom is 18mm by sensor (See detail in annex I).

Table 14.2-7: SAR Values (WCDMA 1700 MHz Band - Head)

| Frequency | | Side | Test Position | Figure No. | Conducted Power (dBm) | Max. tune-up Power (dBm) | Measured SAR(10g) (W/kg) | Reported SAR(10g) (W/kg) | Measured SAR(1g) (W/kg) | Reported SAR(1g) (W/kg) | Power Drift (dB) |
|-----------|--------|------------------------------|---------------|------------|-----------------------|-----------------------------|--------------------------|--------------------------|-------------------------|-------------------------|------------------|
| Ch. | MHz | | | | | | | | | | |
| | | Ambient Temperature: 22.9 °C | | | | Liquid Temperature: 22.5 °C | | | | | |
| 1513 | 1752.6 | Right | Tilt | Fig.7 | 18.65 | 20.00 | 0.398 | 0.54 | 0.789 | 1.08 | 0.05 |

Table 14.2-8: SAR Values (WCDMA 1700 MHz Band - Body)

| Frequency | | Test Position | Figure No. | Conducted Power (dBm) | Max. tune-up Power (dBm) | Measured SAR(10g) (W/kg) | Reported SAR(10g) (W/kg) | Measured SAR(1g) (W/kg) | Reported SAR(1g) (W/kg) | Power Drift (dB) |
|-----------|--------|------------------------------|------------|-----------------------|--------------------------|-----------------------------|--------------------------|-------------------------|-------------------------|------------------|
| Ch. | MHz | | | | | | | | | |
| | | Ambient Temperature: 22.9 °C | | | | Liquid Temperature: 22.5 °C | | | | |
| 1513 | 1752.6 | Rear | Fig.8 | 18.65 | 20.00 | 0.177 | 0.24 | 0.319 | 0.44 | -0.11 |

Note1: The distance between the EUT and the phantom bottom is 10mm

Table 14.2-9: SAR Values (WCDMA 850 MHz Band - Head)

| Frequency | | Side | Test Position | Figure No. | Conducted Power (dBm) | Max. tune-up Power (dBm) | Measured SAR(10g) (W/kg) | Reported SAR(10g) (W/kg) | Measured SAR(1g) (W/kg) | Reported SAR(1g) (W/kg) | Power Drift (dB) |
|-----------|-------|------------------------------|---------------|------------|-----------------------|-----------------------------|--------------------------|--------------------------|-------------------------|-------------------------|------------------|
| Ch. | MHz | | | | | | | | | | |
| | | Ambient Temperature: 22.9 °C | | | | Liquid Temperature: 22.5 °C | | | | | |
| 4233 | 846.6 | Right | Touch | Fig.9 | 24.55 | 25.70 | 0.322 | 0.42 | 0.428 | 0.56 | 0.04 |

Table 14.2-10: SAR Values (WCDMA 850 MHz Band - Body)

| Frequency | | Test Position | Figure No. | Conducted Power (dBm) | Max. tune-up Power (dBm) | Measured SAR(10g) (W/kg) | Reported SAR(10g) (W/kg) | Measured SAR(1g) (W/kg) | Reported SAR(1g) (W/kg) | Power Drift (dB) |
|-----------|-------|---------------|------------|-----------------------|--------------------------|--------------------------|--------------------------|-------------------------|-------------------------|------------------|
| Ch. | MHz | | | | | | | | | |
| 4182 | 836.4 | Rear | Fig.10 | 24.44 | 25.70 | 0.354 | 0.47 | 0.468 | 0.63 | -0.14 |

Note: The distance between the EUT and the phantom bottom is 10mm.

Table 14.2-11: SAR Values (CDMA BC0 Band - Head)

| Frequency | | Side | Test Position | Figure No./ Note | Conducted Power (dBm) | Max. tune-up Power (dBm) | Measured SAR(10g) (W/kg) | Reported SAR(10g) (W/kg) | Measured SAR(1g) (W/kg) | Reported SAR(1g) (W/kg) | Power Drift (dB) |
|-----------|--------|-------|---------------|------------------|-----------------------|--------------------------|--------------------------|--------------------------|-------------------------|-------------------------|------------------|
| Ch. | MHz | | | | | | | | | | |
| 384 | 836.52 | Right | Touch | Fig.11 | 24.86 | 26 | 0.210 | 0.27 | 0.273 | 0.35 | 0.10 |

Table 14.2-12: SAR Values (CDMA BC0 Band - Body)

| Frequency | | Test Position | Figure No./ Note | Conducted Power (dBm) | Max. tune-up Power (dBm) | Measured SAR(10g) (W/kg) | Reported SAR(10g) (W/kg) | Measured SAR(1g) (W/kg) | Reported SAR(1g) (W/kg) | Power Drift (dB) |
|-----------|--------|---------------|------------------|-----------------------|--------------------------|--------------------------|--------------------------|-------------------------|-------------------------|------------------|
| Ch. | MHz | | | | | | | | | |
| 384 | 836.52 | Rear | Fig.12 | 24.86 | 26 | 0.340 | 0.44 | 0.532 | 0.69 | 0.06 |

Note: The distance between the EUT and the phantom bottom is 10mm.

Table 14.2-13: SAR Values (CDMA BC1 Band - Head)

| Frequency | | Side | Test Position | Figure No./ Note | Conducted Power (dBm) | Max. tune-up Power (dBm) | Measured SAR(10g) (W/kg) | Reported SAR(10g) (W/kg) | Measured SAR(1g) (W/kg) | Reported SAR(1g) (W/kg) | Power Drift (dB) |
|-----------|---------|-------|---------------|------------------|-----------------------|--------------------------|--------------------------|--------------------------|-------------------------|-------------------------|------------------|
| Ch. | MHz | | | | | | | | | | |
| 25 | 1851.25 | Right | Touch | Fig.13 | 18.45 | 19.5 | 0.375 | 0.48 | 0.644 | 0.82 | 0.14 |

Table 14.2-14: SAR Values (CDMA BC1 Band - Body)

| Frequency | | Test Position | Figure No./ Note | Conducted Power (dBm) | Max. tune-up Power (dBm) | Measured SAR(10g) (W/kg) | Reported SAR(10g) (W/kg) | Measured SAR(1g) (W/kg) | Reported SAR(1g) (W/kg) | Power Drift (dB) |
|-----------|------|---------------|------------------|-----------------------|--------------------------|--------------------------|--------------------------|-------------------------|-------------------------|------------------|
| Ch. | MHz | | | | | | | | | |
| 600 | 1880 | Rear | Note3 Fig.14 | 23.54 | 25 | 0.231 | 0.32 | 0.392 | 0.55 | -0.16 |

Note1: The distance between the EUT and the phantom bottom is 10mm.

Note3: The distance between the EUT and the phantom bottom is 18mm by sensor (See detail in annex I).

Table 14.2-15: SAR Values (CDMA BC10 Band - Head)

| Ambient Temperature: 22.9 °C | | | | | | Liquid Temperature: 22.5 °C | | | | | |
|------------------------------|-------|-------|---------------|------------------|-----------------------|-----------------------------|--------------------------|--------------------------|-------------------------|-------------------------|------------------|
| Frequency | | Side | Test Position | Figure No./ Note | Conducted Power (dBm) | Max. tune-up Power (dBm) | Measured SAR(10g) (W/kg) | Reported SAR(10g) (W/kg) | Measured SAR(1g) (W/kg) | Reported SAR(1g) (W/kg) | Power Drift (dB) |
| Ch. | MHz | | | | | | | | | | |
| 684 | 823.1 | Right | Touch | Fig.15 | 24.97 | 26 | 0.054 | 0.07 | 0.081 | 0.10 | 0.07 |

Table 14.2-16: SAR Values (CDMA BC10 Band - Body)

| Ambient Temperature: 22.9 °C | | | | | | Liquid Temperature: 22.5 °C | | | | | |
|------------------------------|-------|---------------|------------------|-----------------------|--------------------------|-----------------------------|--------------------------|-------------------------|-------------------------|------------------|--|
| Frequency | | Test Position | Figure No./ Note | Conducted Power (dBm) | Max. tune-up Power (dBm) | Measured SAR(10g) (W/kg) | Reported SAR(10g) (W/kg) | Measured SAR(1g) (W/kg) | Reported SAR(1g) (W/kg) | Power Drift (dB) | |
| Ch. | MHz | | | | | | | | | | |
| 684 | 823.1 | Rear | Fig.16 | 24.97 | 26 | 0.092 | 0.12 | 0.115 | 0.15 | -0.12 | |

Note: The distance between the EUT and the phantom bottom is 10mm.

Table 14.2-17: SAR Values (LTE Band7 - Head)

| Ambient Temperature: 22.9 °C | | | | | | Liquid Temperature: 22.5 °C | | | | | | |
|------------------------------|------|---------|------|---------------|------------|-----------------------------|--------------------------|--------------------------|--------------------------|-------------------------|-------------------------|------------------|
| Frequency | | Mode | Side | Test Position | Figure No. | Conducted Power (dBm) | Max. tune-up Power (dBm) | Measured SAR(10g) (W/kg) | Reported SAR(10g) (W/kg) | Measured SAR(1g) (W/kg) | Reported SAR(1g) (W/kg) | Power Drift (dB) |
| Ch. | MHz | | | | | | | | | | | |
| 21100 | 2535 | 1RB_Mid | Left | Touch | Fig.17 | 20.61 | 22 | 0.102 | 0.14 | 0.186 | 0.26 | 0.02 |

Note1: The LTE mode is QPSK_20MHz.

Table 14.2-18: SAR Values (LTE Band7 - Body)

| Ambient Temperature: 22.9 °C | | | | | | Liquid Temperature: 22.5 °C | | | | | |
|------------------------------|------|---------|---------------|--------------|-----------------------|-----------------------------|--------------------------|--------------------------|-------------------------|-------------------------|------------------|
| Frequency | | Mode | Test Position | Figure No. | Conducted Power (dBm) | Max. tune-up Power (dBm) | Measured SAR(10g) (W/kg) | Reported SAR(10g) (W/kg) | Measured SAR(1g) (W/kg) | Reported SAR(1g) (W/kg) | Power Drift (dB) |
| Ch. | MHz | | | | | | | | | | |
| 21350 | 2560 | 1RB_Low | Rear | Note3 Fig.18 | 22.32 | 24 | 0.158 | 0.23 | 0.296 | 0.44 | 0.07 |

Note1: The distance between the EUT and the phantom bottom is 10mm

Note3: The distance between the EUT and the phantom bottom is 18mm by sensor (See detail in annex I).

Note6: The LTE mode is QPSK_20MHz.

Table 14.2-19: SAR Values (LTE Band12 - Head)

| Ambient Temperature: 22.9 °C | | | | | | Liquid Temperature: 22.5 °C | | | | | | |
|------------------------------|-------|----------|-------|---------------|------------|-----------------------------|--------------------------|--------------------------|--------------------------|-------------------------|-------------------------|------------------|
| Frequency | | Mode | Side | Test Position | Figure No. | Conducted Power (dBm) | Max. tune-up Power (dBm) | Measured SAR(10g) (W/kg) | Reported SAR(10g) (W/kg) | Measured SAR(1g) (W/kg) | Reported SAR(1g) (W/kg) | Power Drift (dB) |
| Ch. | MHz | | | | | | | | | | | |
| 23095 | 707.5 | 1RB_High | Right | Touch | Fig.19 | 24.95 | 25.7 | 0.191 | 0.23 | 0.244 | 0.29 | 0.08 |

Note1: The LTE mode is QPSK_10MHz.

Table 14.2-20: SAR Values (LTE Band12 - Body)

| Ambient Temperature: 22.9 °C | | | | | | Liquid Temperature: 22.5 °C | | | | | |
|------------------------------|-------|---------|---------------|------------|-----------------------|-----------------------------|--------------------------|--------------------------|-------------------------|-------------------------|------------------|
| Frequency | | Mode | Test Position | Figure No. | Conducted Power (dBm) | Max. tune-up Power (dBm) | Measured SAR(10g) (W/kg) | Reported SAR(10g) (W/kg) | Measured SAR(1g) (W/kg) | Reported SAR(1g) (W/kg) | Power Drift (dB) |
| Ch. | MHz | | | | | | | | | | |
| 23095 | 707.5 | 1RB_Low | Right | Fig.20 | 24.95 | 25.7 | 0.172 | 0.20 | 0.249 | 0.30 | 0.13 |

Note1: The distance between the EUT and the phantom bottom is 10mm.

Note2: The LTE mode is QPSK_10MHz.

Table 14.2-21: SAR Values (LTE Band13 - Head)

| Ambient Temperature: 22.9 °C | | | | | | Liquid Temperature: 22.5 °C | | | | | | |
|------------------------------|-----|---------|-------|---------------|------------|-----------------------------|--------------------------|--------------------------|--------------------------|-------------------------|-------------------------|------------------|
| Frequency | | Mode | Side | Test Position | Figure No. | Conducted Power (dBm) | Max. tune-up Power (dBm) | Measured SAR(10g) (W/kg) | Reported SAR(10g) (W/kg) | Measured SAR(1g) (W/kg) | Reported SAR(1g) (W/kg) | Power Drift (dB) |
| Ch. | MHz | | | | | | | | | | | |
| 23230 | 782 | 1RB_Low | Right | Touch | Fig.21 | 23.96 | 25 | 0.180 | 0.23 | 0.231 | 0.29 | 0.10 |

Note1: The LTE mode is QPSK_10MHz.

Table 14.2-22: SAR Values (LTE Band13 - Body)

| Ambient Temperature: 22.9 °C | | | | | | Liquid Temperature: 22.5 °C | | | | | |
|------------------------------|-----|---------|---------------|------------|-----------------------|-----------------------------|--------------------------|--------------------------|-------------------------|-------------------------|------------------|
| Frequency | | Mode | Test Position | Figure No. | Conducted Power (dBm) | Max. tune-up Power (dBm) | Measured SAR(10g) (W/kg) | Reported SAR(10g) (W/kg) | Measured SAR(1g) (W/kg) | Reported SAR(1g) (W/kg) | Power Drift (dB) |
| Ch. | MHz | | | | | | | | | | |
| 23230 | 782 | 1RB_Low | Rear | Fig.22 | 23.96 | 25 | 0.307 | 0.39 | 0.402 | 0.51 | -0.14 |

Note1: The distance between the EUT and the phantom bottom is 10mm.

Note2: The LTE mode is QPSK_10MHz.

Table 14.2-23: SAR Values (LTE Band25 - Head)

| Ambient Temperature: 22.9 °C | | | | | | Liquid Temperature: 22.5 °C | | | | | | |
|------------------------------|------|---------|-------|---------------|------------|-----------------------------|---------------------|--------------------------|--------------------------|-------------------------|-------------------------|------------------|
| Frequency | | Mode | Side | Test Position | Figure No. | Conducted Power (dBm) | tune-up Power (dBm) | Measured SAR(10g) (W/kg) | Reported SAR(10g) (W/kg) | Measured SAR(1g) (W/kg) | Reported SAR(1g) (W/kg) | Power Drift (dB) |
| Ch. | MHz | | | | | | | | | | | |
| 26590 | 1905 | 1RB_Mid | Right | Touch | Fig.23 | 18.51 | 19.5 | 0.334 | 0.42 | 0.569 | 0.71 | 0.13 |

Note1: The LTE mode is QPSK_20MHz.

Table 14.2-24: SAR Values (LTE Band25 - Body)

| Ambient Temperature: 22.9 °C | | | | | | Liquid Temperature: 22.5 °C | | | | | |
|------------------------------|------|---------|---------------|------------|-----------------------|-----------------------------|--------------------------|--------------------------|-------------------------|-------------------------|------------------|
| Frequency | | Mode | Test Position | Figure No. | Conducted Power (dBm) | tune-up Power (dBm) | Measured SAR(10g) (W/kg) | Reported SAR(10g) (W/kg) | Measured SAR(1g) (W/kg) | Reported SAR(1g) (W/kg) | Power Drift (dB) |
| Ch. | MHz | | | | | | | | | | |
| 26590 | 1905 | 1RB_Mid | Rear | Fig.24 | 18.51 | 19.5 | 0.250 | 0.31 | 0.427 | 0.54 | 0.02 |

Note1: The distance between the EUT and the phantom bottom is 10mm

Note5: The LTE mode is QPSK_20MHz.

Table 14.2-25: SAR Values (LTE Band26 - Head)

| Ambient Temperature: 22.9 °C | | | | | | Liquid Temperature: 22.5 °C | | | | | | |
|------------------------------|-------|----------|-------|---------------|------------|-----------------------------|---------------------|--------------------------|--------------------------|-------------------------|-------------------------|------------------|
| Frequency | | Mode | Side | Test Position | Figure No. | Conducted Power (dBm) | tune-up Power (dBm) | Measured SAR(10g) (W/kg) | Reported SAR(10g) (W/kg) | Measured SAR(1g) (W/kg) | Reported SAR(1g) (W/kg) | Power Drift (dB) |
| Ch. | MHz | | | | | | | | | | | |
| 26965 | 841.5 | 36RB_Low | Right | Touch | / | 24.38 | 24.7 | 0.265 | 0.29 | 0.350 | 0.38 | -0.11 |

Note1: The LTE mode is QPSK_15MHz.

Table 14.2-26: SAR Values (LTE Band26 - Body)

| Ambient Temperature: 22.9 °C | | | | | | Liquid Temperature: 22.5 °C | | | | | |
|------------------------------|-------|----------|---------------|------------|-----------------------|-----------------------------|--------------------------|--------------------------|-------------------------|-------------------------|------------------|
| Frequency | | Mode | Test Position | Figure No. | Conducted Power (dBm) | tune-up Power (dBm) | Measured SAR(10g) (W/kg) | Reported SAR(10g) (W/kg) | Measured SAR(1g) (W/kg) | Reported SAR(1g) (W/kg) | Power Drift (dB) |
| Ch. | MHz | | | | | | | | | | |
| 26965 | 841.5 | 1RB_High | Rear | Fig.26 | 25.51 | 25.7 | 0.286 | 0.30 | 0.480 | 0.50 | 0.14 |

Note1: The distance between the EUT and the phantom bottom is 10mm

Note2: The LTE mode is QPSK_15MHz.

Table 14.2-27-a: SAR Values (LTE Band41 PC2 - Head)

| Frequency | | Mode | Side | Test Position | Figure No. | Conducted Power (dBm) | tune-up Power (dBm) | Measured SAR(10g) (W/kg) | Reported SAR(10g) (W/kg) | Measured SAR(1g) (W/kg) | Reported SAR(1g) (W/kg) | Power Drift (dB) |
|-----------|------|----------|------|---------------|------------|-----------------------|---------------------|--------------------------|--------------------------|-------------------------|-------------------------|------------------|
| Ch. | MHz | | | | | | | | | | | |
| 40620 | 2593 | 1RB_High | Left | Tilt | Fig.27-a | 23.66 | 24 | 0.076 | 0.08 | 0.143 | 0.15 | 0.02 |

Note1: The LTE mode is QPSK_20MHz.

Table 14.2-27-b: SAR Values (LTE Band41 PC3 - Head)

| Frequency | | Mode | Side | Test Position | Figure No. | Conducted Power (dBm) | tune-up Power (dBm) | Measured SAR(10g) (W/kg) | Reported SAR(10g) (W/kg) | Measured SAR(1g) (W/kg) | Reported SAR(1g) (W/kg) | Power Drift (dB) |
|-----------|------|----------|------|---------------|------------|-----------------------|---------------------|--------------------------|--------------------------|-------------------------|-------------------------|------------------|
| Ch. | MHz | | | | | | | | | | | |
| 39750 | 2506 | 1RB_High | Left | Touch | Fig.27-b | 22.97 | 24 | 0.094 | 0.12 | 0.150 | 0.19 | -0.11 |

Note1: The LTE mode is QPSK_20MHz.

Table 14.2-28-a: SAR Values (LTE Band41 PC2 - Body)

| Frequency | | Mode | Test Position | Figure No. | Conducted Power (dBm) | tune-up Power (dBm) | Measured SAR(10g) (W/kg) | Reported SAR(10g) (W/kg) | Measured SAR(1g) (W/kg) | Reported SAR(1g) (W/kg) | Power Drift (dB) |
|-----------|--------|---------|---------------|------------|-----------------------|---------------------|--------------------------|--------------------------|-------------------------|-------------------------|------------------|
| Ch. | MHz | | | | | | | | | | |
| 40185 | 2549.5 | 1RB_Mid | Bottom | Fig.28-a | 23.80 | 24 | 0.307 | 0.32 | 0.631 | 0.66 | 0.10 |

Note1: The distance between the EUT and the phantom bottom is 10mm.

Note6: The LTE mode is QPSK_20MHz.

Table 14.2-28-b: SAR Values (LTE Band41 PC3 - Body)

| Frequency | | Mode | Test Position | Figure No. | Conducted Power (dBm) | tune-up Power (dBm) | Measured SAR(10g) (W/kg) | Reported SAR(10g) (W/kg) | Measured SAR(1g) (W/kg) | Reported SAR(1g) (W/kg) | Power Drift (dB) |
|-----------|------|----------|---------------|------------|-----------------------|---------------------|--------------------------|--------------------------|-------------------------|-------------------------|------------------|
| Ch. | MHz | | | | | | | | | | |
| 39750 | 2506 | 1RB-High | Rear | Fig.28-b | 22.97 | 24 | 0.197 | 0.25 | 0.368 | 0.47 | -0.11 |

Note1: The distance between the EUT and the phantom bottom is 10mm.

Note2: The LTE mode is QPSK_20M

Table 14.2-29: SAR Values (LTE Band66 - Head)

| Frequency | | Mode | Side | Test Position | Figure No. | Conducted Power (dBm) | Max. tune-up Power (dBm) | Measured SAR(10g) (W/kg) | Reported SAR(10g) (W/kg) | Measured SAR(1g) (W/kg) | Reported SAR(1g) (W/kg) | Power Drift (dB) |
|-----------|------|----------|-------|---------------|------------|-----------------------|--------------------------|--------------------------|--------------------------|-------------------------|-------------------------|------------------|
| Ch. | MHz | | | | | | | | | | | |
| 132322 | 1745 | 1RB_High | Right | Tilt | Fig.29 | 18.71 | 19.5 | 0.332 | 0.40 | 0.654 | 0.78 | 0.10 |

Note1: The LTE mode is QPSK_20MHz.

Table 14.2-30: SAR Values (LTE Band66 - Body)

| Ambient Temperature: 22.9 °C | | | | | | Liquid Temperature: 22.5 °C | | | | | |
|------------------------------|------|----------|---------------|--------------|-----------------------|-----------------------------|--------------------------|--------------------------|-------------------------|-------------------------|------------------|
| Frequency | | Mode | Test Position | Figure No. | Conducted Power (dBm) | Max. tune-up Power (dBm) | Measured SAR(10g) (W/kg) | Reported SAR(10g) (W/kg) | Measured SAR(1g) (W/kg) | Reported SAR(1g) (W/kg) | Power Drift (dB) |
| Ch. | MHz | | | | | | | | | | |
| 132072 | 1720 | 1RB_High | Top | Note4 Fig.30 | 23.96 | 25 | 0.127 | 0.16 | 0.226 | 0.29 | -0.16 |

Note1: The distance between the EUT and the phantom bottom is 10mm

Note4: The distance between the EUT and the phantom bottom is 17mm by sensor (See detail in annex I).

Note5: The LTE mode is QPSK_20MHz.

Table 14.2-31: SAR Values (LTE Band71 - Head)

| Ambient Temperature: 22.9 °C | | | | | | Liquid Temperature: 22.5 °C | | | | | | |
|------------------------------|-----|---------|-------|---------------|------------|-----------------------------|--------------------------|--------------------------|--------------------------|-------------------------|-------------------------|------------------|
| Frequency | | Mode | Side | Test Position | Figure No. | Conducted Power (dBm) | Max. tune-up Power (dBm) | Measured SAR(10g) (W/kg) | Reported SAR(10g) (W/kg) | Measured SAR(1g) (W/kg) | Reported SAR(1g) (W/kg) | Power Drift (dB) |
| Ch. | MHz | | | | | | | | | | | |
| 133222 | 673 | 1RB_Low | Right | Touch | Fig.31 | 25.25 | 25.7 | 0.175 | 0.19 | 0.220 | 0.24 | 0.06 |

Note1: The LTE mode is QPSK_20MHz.

Table 14.2-32: SAR Values (LTE Band71 - Body)

| Ambient Temperature: 22.9 °C | | | | | | Liquid Temperature: 22.5 °C | | | | | |
|------------------------------|-----|---------|---------------|------------|-----------------------|-----------------------------|--------------------------|--------------------------|-------------------------|-------------------------|------------------|
| Frequency | | Mode | Test Position | Figure No. | Conducted Power (dBm) | Max. tune-up Power (dBm) | Measured SAR(10g) (W/kg) | Reported SAR(10g) (W/kg) | Measured SAR(1g) (W/kg) | Reported SAR(1g) (W/kg) | Power Drift (dB) |
| Ch. | MHz | | | | | | | | | | |
| 133222 | 673 | 1RB_Low | Front | Fig.32 | 25.25 | 25.7 | 0.136 | 0.15 | 0.175 | 0.19 | 0.11 |

Note1: The distance between the EUT and the phantom bottom is 10mm

Note2: The LTE mode is QPSK_20MHz.