



FCC PART 15 TEST REPORT No.23T04Z70553-06

for

SAMSUNG Electronics Co., Ltd.

Multi-band GSM/WCDMA/LTE phone with Bluetooth, WLAN

SM-A057M/DS, SM-A057M

With

FCC ID: ZCasma057M

Hardware Version: REV1.0

Software Version: A057M.001

Issued Date: 2023-11-14

Note:

The test results in this test report relate only to the devices specified in this report. This report shall not be reproduced except in full without the written approval of CTTL.

The report must not be used by the client to claim product certification, approval, or endorsement by NVLAP, NIST, or any agency of the U.S. Government.

Test Laboratory:

CTTL-Telecommunication Technology Labs, CAICT

No. 52, Huayuan North Road, Haidian District, Beijing, P. R. China 100191.

Tel:+86(0)10-62304633-2512, Fax:+86(0)10-62304633-2504

Email: ctl_terminals@caict.ac.cn, website: www.caict.ac.cn



REPORT HISTORY

| Report Number | Revision | Description | Issue Date |
|----------------------|-----------------|--------------------|-------------------|
| 23T04Z70553-06 | Rev.0 | 1st edition | 2023-11-14 |
| | | | |

CONTENTS

| | |
|--|-----------|
| CONTENTS | 3 |
| 1. TEST LATORATORY | 4 |
| 1.1. INTRODUCTION & ACCREDITATION | 4 |
| 1.2. TESTING LOCATION | 4 |
| 1.3. TESTING ENVIRONMENT..... | 4 |
| 1.4. PROJECT DATE | 4 |
| 1.5. SIGNATURE | 5 |
| 2. CLIENT INFORMATION..... | 6 |
| 2.1. APPLICANT INFORMATION..... | 6 |
| 2.2. MANUFACTURER INFORMATION..... | 6 |
| 3. EQUIPMENT UNDER TEST (EUT) AND ANCILLARY EQUIPMENT(AE) | 7 |
| 3.1. ABOUT EUT | 7 |
| 3.2. INTERNAL IDENTIFICATION OF EUT USED DURING THE TEST | 7 |
| 3.3. GENERAL DESCRIPTION..... | 7 |
| 4. REFERENCE DOCUMENTS | 8 |
| 4.1. DOCUMENTS SUPPLIED BY APPLICANT | 8 |
| 4.2. REFERENCE DOCUMENTS FOR TESTING..... | 8 |
| 5. LABORATORY ENVIRONMENT..... | 8 |
| 6. SUMMARY OF TEST RESULTS | 8 |
| 6.1. SUMMARY OF TEST RESULTS | 8 |
| 6.2. STATEMENTS..... | 8 |
| 7. TEST EQUIPMENTS UTILIZED | 9 |
| ANNEX A: MEASUREMENT RESULTS..... | 10 |
| A.1. MEASUREMENT METHOD | 10 |
| A.2. CHANNEL MOVE TIME AND CHANNEL CLOSING TRANSMISSION TIME | 12 |
| A.3. NON-OCCUPANCY PERIOD..... | 15 |
| A3.1 ASSOCIATED TEST | 15 |
| ANNEX B: EUT PARAMETERS..... | 16 |
| ANNEX C: ACCREDITATION CERTIFICATE | 17 |



1. TEST LABORATORY

1.1. Introduction & Accreditation

Telecommunication Technology Labs, CAICT is an ISO/IEC 17025:2017 accredited test laboratory under NATIONAL VOLUNTARY LABORATORY ACCREDITATION PROGRAM (NVLAP) with lab code 600118-0, and is also an FCC accredited test laboratory (CN5017), and ISED accredited test laboratory (ISED#: 24849). The detail accreditation scope can be found on NVLAP website.

1.2. Testing Location

Conducted testing Location: CTTL(Huayuan North Road)

Address: No. 52, Huayuan North Road, Haidian District, Beijing,
P. R. China100191

1.3. Testing Environment

Normal Temperature: 15-35°C

Relative Humidity: 20-75%

1.4. Project date

Testing Start Date: 2023-10-24

Testing End Date: 2023-11-14

1.5. Signature



Dong Jiaxuan
(Prepared this test report)

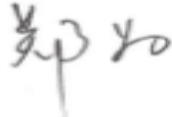

Zheng Wei
(Reviewed this test report)



Pang Shuai
(Approved this test report)



2. CLIENT INFORMATION

2.1. Applicant Information

Company Name: SAMSUNG Electronics Co., Ltd.
Address: 19 Chapin Rd., Building D Pine Brook, NJ 07058
City: New Jersey
Postal Code: /
Country: United States
Telephone: +1-201-937-4203
Fax: /

2.2. Manufacturer Information

Company Name: Samsung Electronics Co., Ltd.
Address: Samsung R5, Maetan dong 129, Samsung ro
Youngtong gu, Suwon city 443 742, Korea
City: Suwon
Postal Code: /
Country: Korea
Telephone: +82-10-2722-4159
Fax: /

3. EQUIPMENT UNDER TEST (EUT) AND ANCILLARY

EQUIPMENT(AE)

3.1. About EUT

| | |
|---------------------|--|
| Description | Multi-band GSM/WCDMA/LTE phone with Bluetooth, WLAN |
| Model name | SM-A057M/DS, SM-A057M |
| FCC ID | ZCASMA057M |
| WLAN Frequency Band | ISM Band: -5250MHz~5350MHz -5470MHz~5725MHz |
| Type of modulation | OFDM |
| Antenna | Integral Antenna |
| Extreme vol. Limits | 3.8V |
| Device Type (DFS) | Client without radar detection(only support client mode) |
| TPC mechanism | Not support |
| Antenna gain | -2.14dBi |

3.2. Internal Identification of EUT used during the test

| EUT ID* | S/N | HW Version | SW Version |
|----------------|--------------|-------------------|-------------------|
| UT04a | 2370553UT04a | REV1.0 | A057M.001 |

*EUT ID: is used to identify the test sample in the lab internally.

3.3. General Description

The Equipment Under Test (EUT) is a model of Multi-band GSM/WCDMA/LTE phone with Bluetooth, WLAN with integrated antenna. It consists of normal options: lithium battery, charger. Manual and specifications of the EUT were provided to fulfil the test.

4. REFERENCE DOCUMENTS

4.1. Documents supplied by applicant

EUT feature information is supplied by the applicant or manufacturer, which is the basis of testing.

4.2. Reference Documents for testing

The following documents listed in this section are referred for testing.

| | | |
|----------------|---|------|
| FCC Part15 | FCC CFR 47, Part 15, Subpart E: 15.407 General technical requirements. | 2021 |
| KDB 905462 D03 | UNII Clients Without Radar Detection New Rules v01r02 | 2016 |

5. LABORATORY ENVIRONMENT

Measurement is performed in shielding room.

6. SUMMARY OF TEST RESULTS

6.1. Summary of Test Results

| SUMMARY OF MEASUREMENT RESULTS | Sub-clause of Part15E | Verdict |
|---|-----------------------|----------|
| Channel move time and channel closing transmission time | 15.407 (h)(2)(iii) | P |
| Non-Occupancy Period | 15.407 (h)(2) (iv) | P |

Please refer to **ANNEX A** for detail.

Terms used in Verdict column

| | |
|----|---|
| P | Pass, The EUT complies with the essential requirements in the standard. |
| NM | Not measured, The test was not measured by CTTL |
| NA | Not Applicable, The test was not applicable |
| F | Fail, The EUT does not comply with the essential requirements in the standard |

6.2. Statements

CTTL has evaluated the test cases requested by the client/manufacturer as listed in section 6.1 of this report for the EUT specified in section 3 according to the standards or reference documents listed in section 4.1.

This report only deal with the UNII DFS functions among the features described in section 3, and The EUT met all requirements of the reference documents.

The end user is not available to get and modify the parameters of the detected Radar Waveforms in this product.

Test Conditions

| | |
|-------|--------------------|
| T nom | Normal Temperature |
| T min | Low Temperature |
| T max | High Temperature |
| V nom | Normal Voltage |
| V min | Low Voltage |
| V max | High Voltage |

| | |
|-------|-------------------|
| H nom | Norm Humidity |
| A nom | Norm Air Pressure |

For this report, all the test case listed above is tested under Normal Temperature and Normal Voltage, and also under norm humidity, the specific conditions as following:

| | | |
|--------------|-------|---------|
| Temperature | T nom | 26°C |
| Voltage | V nom | 3.85V |
| Humidity | H nom | 44% |
| Air Pressure | A nom | 1010hPa |

7. TEST EQUIPMENTS UTILIZED

Conducted test system

| No. | Equipment | Model | Serial Number | Manufacturer | Calibration Period | Calibration Due Date |
|-----|-------------------------|---------|---------------|-----------------|--------------------|----------------------|
| 1 | Vector Signal Analyzer | FSQ40 | 200089 | Rohde & Schwarz | 1 year | 2024-07-04 |
| 2 | Vector Signal Generator | SMU200A | 103752 | Rohde & Schwarz | 1 year | 2024-07-04 |
| 3 | Shielding Room | S81 | / | ETS-Lindgren | / | / |

ANNEX A: MEASUREMENT RESULTS

A.1. Measurement Method

A.1.1. Conducted Measurements

The below figure shows the DFS setup, where the EUT is a WLAN device operating in slave mode, without Radar Interference Detection function. This setup also contains a device operating in master mode. The radar test signals are injected into the master device. The EUT (slave device) is associated with the master device. WLAN traffic is generated by streaming the mpeg file from the master to the slave in full monitor video mode using the media player.

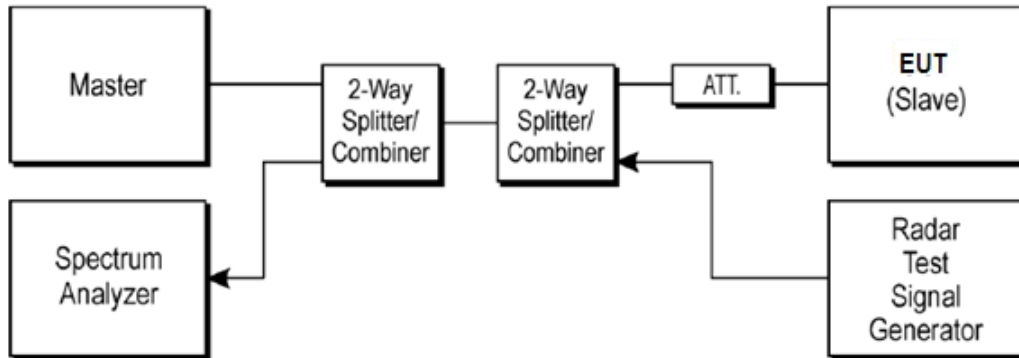

Note:

- 1) All Measurements are performed with the EUT's narrowest channel bandwidth.
- 2) The master device information is as follows
 Vendor: RUCKUS
 Model: R600
 FCC ID: S9GR600
- 3) The software of radar signal generator (R&S SMU200A) is completely designed based on KDB 905462 requirement.

A.1.2. Parameters of DFS test signal

1). Interference threshold values, master or client incorporation in service monitoring. For device power less than 23dBm (E.I.R.P.), the threshold level is -62 dBm at the antenna port after correction for antenna gain and procedural adjustments.

Because of conducted measurement performed, the calibration power from radar signal generator to antenna port of DFS test equipment is -62 dBm.

| Maximum Transmit Power | Value |
|------------------------|---------|
| > 200 mW | -64 dBm |
| < 200 mW | -62 dBm |

The radar Detection Threshold, lowest antenna gain is the parameter of interference radar DFS detection threshold.

One 10 Second plot bee reported for the short Pulse Radar type 1-4, the type 0 was be used, which was selected by auto test software.

Radar Waveform Calibration Result:

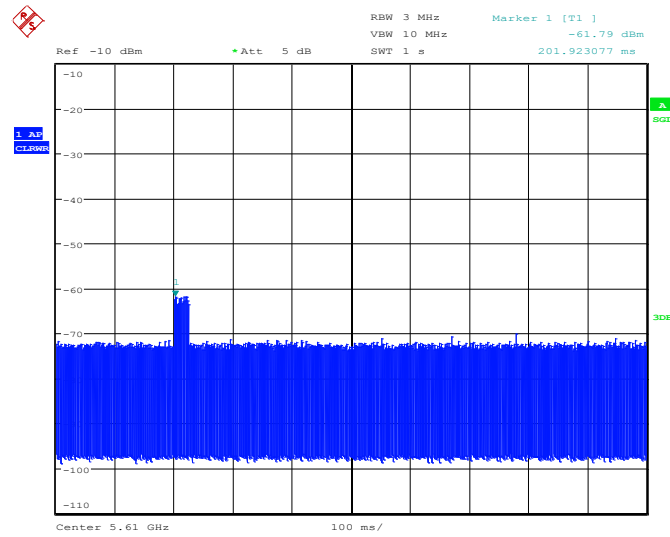

Date: 15.JAN.2022 06:39:49

Fig.A.1 80M Calibration Result

2). DFS requirement values

The required values are as the following table.

| Parameter | Value |
|-----------------------------------|---|
| Non-occupancy | > 1800 s |
| Channel Availability Check Time | 60 s |
| Channel Move Time | 10 s |
| Channel Closing Transmission Time | 200 ms + 60 ms |
| U-NII Detection Bandwidth | Minimum 80% of the 99% transmission power bandwidth |

As the EUT is IP based system, the MPEG video file from NTIA website is used to steam to EUT via the Master device.

A.1.3. Measurement Uncertainty

| Item | Measurement Uncertainty |
|-------|-------------------------|
| Time | 0.70 ms |
| Power | 0.75 dBm |

A.2. Channel move time and channel closing transmission time

Measurement Limit:

| Test Items | Limit |
|-----------------------------------|------------------|
| channel closing transmission time | < 200 ms + 60 ms |
| Channel move time | < 10 s |

Measurement Results:

Frequency Band: 5250MHz ~ 5350MHz

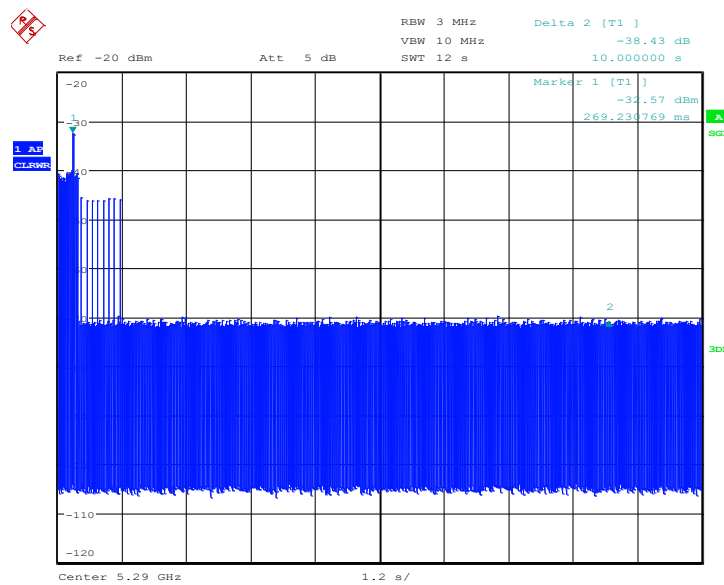

Date: 25.OCT.2023 10:41:35

Fig.A.2 Channel move time

The channel move time is as the figure. It shows the time of the radar and the client pulses. The figure shows that the client stops transmission within 10 seconds, and no transmissions occur after 10 seconds later of the radar burst signal.

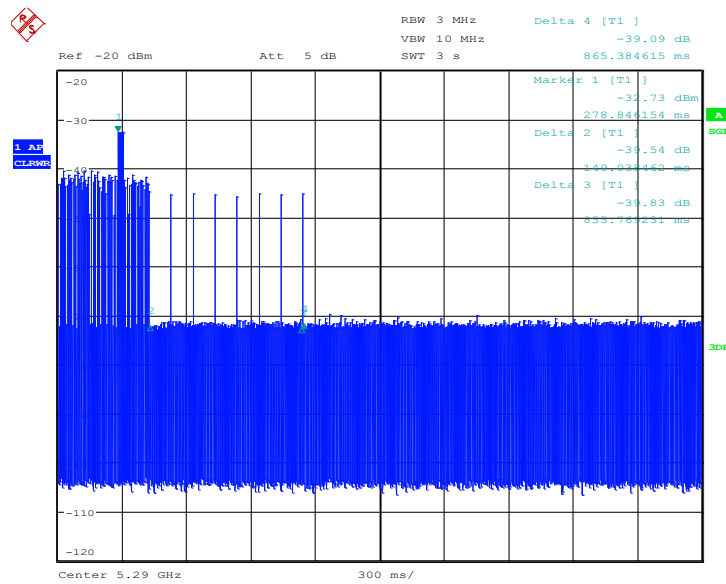

Date: 25.OCT.2023 10:40:24

Fig.A.3 channel closing transmission time

The closing transmission time is as the figure, and the result is $216.34\text{ms} = \text{Delta}2 + (\text{Delta}4 - \text{Delta}3) * 7$.

Conclusion: PASS

Frequency Band 5470MHz ~ 5725MHz

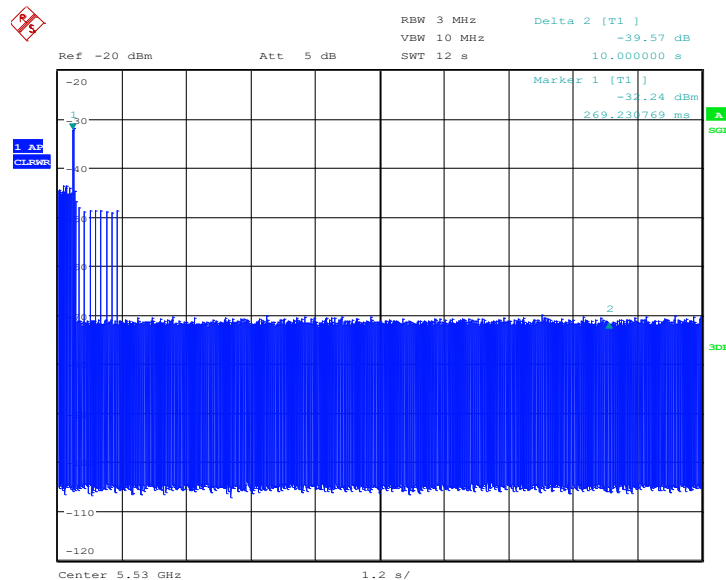

Date: 25.OCT.2023 14:52:54

Fig.A.4 Channel move time

The channel move time is as the figure. It shows the time of the radar and the client pulses. The

figure shows that the client stops transmission within 10 seconds, and no transmissions occur after 10 seconds later of the radar burst signal.

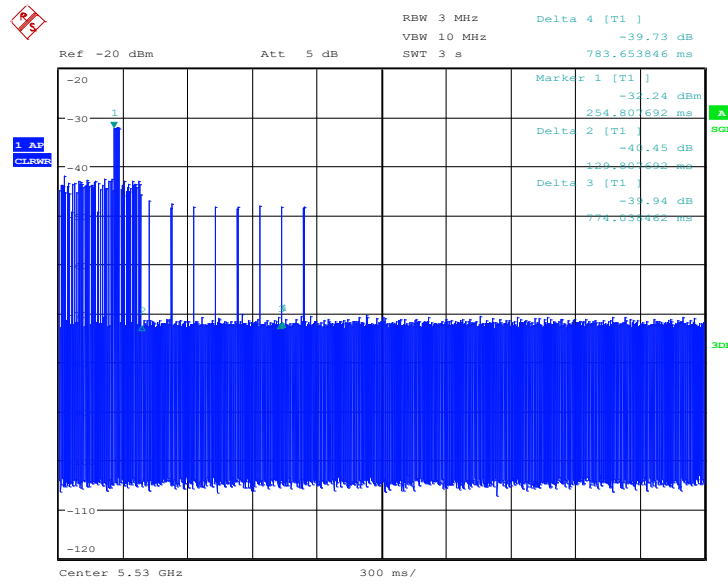

Date: 25.OCT.2023 14:49:51

Fig.A.5 channel closing transmission time

The closing transmission time is as the figure, and the result is $235.57\text{ms} = \text{Delta}2 + (\text{Delta}4 - \text{Delta}3) * 11$.

Conclusion: PASS

A.3.Non-Occupancy Period

Measurement Limit:

| Test Items | Limit |
|----------------------|----------|
| Non-Occupancy Period | > 1800 s |

A3.1 Associated test

Associate the master and client, transmit specified stream between the master and client; monitor the analyzer on the operating frequency to make sure no beacons have been transmitted for 1800 seconds.

Frequency Band: 5150MHz ~ 5350MHz

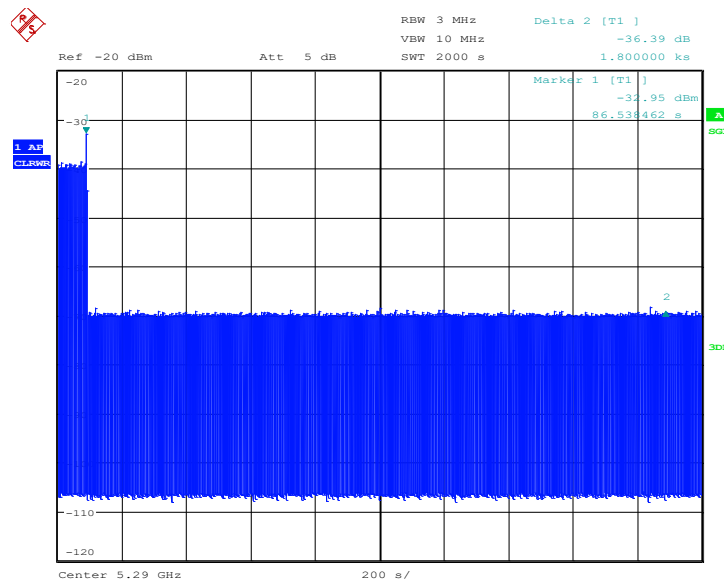

Date: 25.OCT.2023 13:36:25

Fig.A.6 Non-Occupancy Period

The figure above shows that the client does not transmit any emission within 1800 seconds after getting the order of “stop transmits” from the DFS master (access point).

Frequency Band: 5470MHz ~ 5725MHz

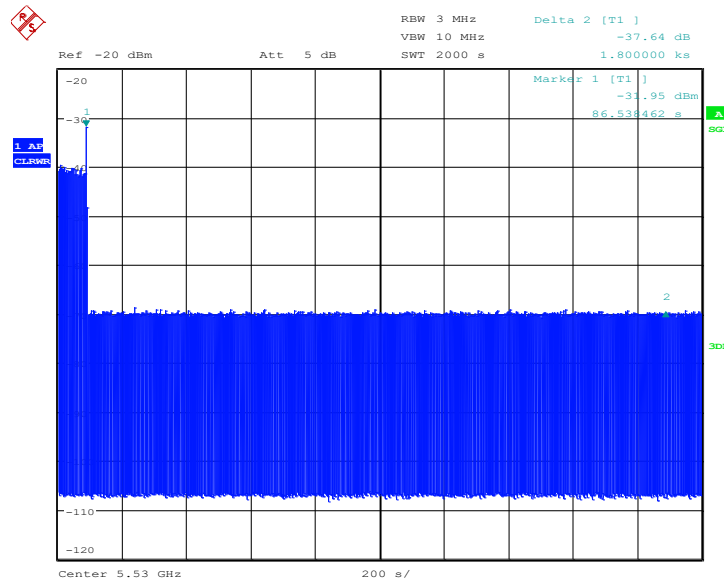

Date: 25.OCT.2023 15:28:42

Fig.A.7 Non-Occupancy Period

The figure above shows that the client does not transmit any emission within 1800 seconds after getting the order of “stop transmits” from the DFS master (access point).

Conclusion: PASS

ANNEX B: EUT parameters

Disclaimer: The antenna gain provided by the client may affect the validity of the measurement results in this report, and the client shall bear the impact and consequences arising therefrom.

ANNEX C: Accreditation Certificate



Accredited Laboratory

A2LA has accredited

TELECOMMUNICATION TECHNOLOGY LABS, CAICT

Beijing, People's Republic of China

for technical competence in the field of

Electrical Testing

This laboratory is accredited in accordance with the recognized International Standard ISO/IEC 17025:2017 *General requirements for the competence of testing and calibration laboratories*. This accreditation demonstrates technical competence for a defined scope and the operation of a laboratory quality management system (refer to joint ISO-ILAC-IAF Communiqué dated April 2017).



Presented this 26th day of June 2023.

Mr. Trace McInturf, Vice President, Accreditation Services
For the Accreditation Council
Certificate Number 7049.01
Valid to July 31, 2024

For the tests to which this accreditation applies, please refer to the laboratory's Electrical Scope of Accreditation.

*** END OF REPORT BODY ***